

D25	1, 13, 16, 17, 35-38, 45, 47, 53, 55, 56, 58, 60-63, 68	2914	N/Ap
	102, 106, 109, 111, 113, 114	2912	N/Ap
	119, 136, 138, 145, 151, 152, 157, 164, 199	2914	

No other classes were impacted by this order.

This order includes the following:

- A. CLASSIFICATION MANUAL CHANGES;
- C. CHANGES TO THE USPC – LOCARNO CONCORDANCE;
- D. DEFINITION CHANGES.

CLASSIFICATION ORDER 1830

Project Leader: Charles Rademaker

Editor: David Delzingaro

Editorial Assistant: Yvonne Smith

CLASS D19 OFFICE SUPPLIES; ARTISTS' AND TEACHERS' MATERIALS

DECEMBER 2003

# 1	PAPER OR PASTEBOARD FOR WRITING OR PRINTING	# 59	TEACHING MATERIAL
# 2	.Combined (1)	60	.Sensory feedback, e.g., audio-visual teaching machine
3	.Envelope	61	.Terrestrial or extraterrestrial map or model
4	..Simulative	# 62	.Demonstrator or exhibitor (10)
5	.Continuous background pattern, e.g., safety paper	63	..Vehicle trainer
6	.Simulative	64	..Movable indicator or changeable exhibitor
7	..Animate	# 65	OFFICE EQUIPMENT NOT ELSEWHERE SPECIFIED
8	...Humanoid	66	.For gluing, sealing, etc.
9	CREDIT CARD, CERTIFICATE, OR STAMP	# 67	..Strip material dispenser (11)
10	.Identification or credit-type card	68	...Lever-operated or automatic
# 11	.Negotiable instrument or ticket, e.g., currency, check, etc. (2)	69	...Manual cutting
12	.Stamp or seal	# 70	..Moistener (12)
20	CALENDAR OR CALENDAR HOLDER	71	...Hand-held
21	.Combined	# 72	.Perforating or cutting (13)
# 22	..With writing paper receptacle (3)	73	..Pencil sharpener
# 23	..With pen or pencil holder (4)	74	...Crank type
24	.Simulative	# 75	.Holder or file (14)
25	.Perpetual	76	..Rotary or flip-card file, list finder
# 26	BOOK, ALBUM OR COVER	77	..For writing instrument and diverse article
27	.Ring bound or looseleaf type	78	...With paper receptacle
28	.Simulative	79	...With inkwell
29	..Animate	80	...Simulative
30	...Humanoid	81	..For writing instrument
31	..Plant life	82	...Simulative
32	.Element or attachment	83	...Instrument supported horizontally
# 33	..Leaf (5)	84	...Instrument supported vertically or angularly
34	..Bookmark	85	...Plural
34.1	BOOKEND	# 86	..For paper or document (15)
34.2	.Combined with disparate article	87	...Combined with telephone holder
34.3	.Simulative	# 88	..Clipboard (16)
34.4	..Animate	89	...Roll paper type
34.5	...Humanoid	90	...Substantially vertical
# 35	EQUIPMENT FOR WRITING, DRAWING, OR FOR FINE ARTS	91	...For display of note pad, document, book, etc.
36	.Plural or combined	92	...Substantially horizontal, e.g., desk tray
# 37	.Guide (6)	# 93	..Inkwell (17)
38	..Compass	94	...Simulative
39	..Curve template or French curve	# 95	.Desk furnishing (18)
40	..Stencil	96	..Paperweight
41	.Marking instrument	97	...Simulative
42	..Simulative	98	..Blotter or pen wiper
43	..Provision for cap over writing tip only	# 99	.Element or attachment (19)
44	..With suspension ring or loop	100	MISCELLANEOUS
45	..Elongated		
46	...Having flared or enlarged top		
47	...With surface texture or pattern		
48Lateral striation		
49Longitudinal striation		
50Diagonal striation		
51	...Substantially circular or oval in cross section		
# 52	.Writing or drawing surface, e.g., blackboard, drawing board, etc. (7)		
# 53	.Eraser (8)		
54	.Element or attachment		
55	..Nib, stylus or grip		
56	..Clip		
57	..Top or cover for marking instrument		
# 58	...Pencil top or ferrule (9)		

SEARCH NOTES FOR CLASS D19
 (1) Includes aerogram.
 (2) For checkbook cover, see subclass 26 below.
 (3) For paper holder per se, or in other combinations, see subclasses 78 and 86+ below.
 (4) For writing instrument holder per se, or in other combinations, see subclasses 77+ and 81+ below.
 (5) For paper other than book or album leaf, see subclasses 1+ above.
 (6) Includes laminating machine.
 (7) Includes tracing board.

Title Change
 * Newly Established Subclass

@ Indent Change
 & Position Change

CLASS D19 OFFICE SUPPLIES; ARTISTS' AND TEACHERS' MATERIALS

DECEMBER 2003

- (8) Includes element. For pencil tip eraser holder, see subclass 58 below.
- (9) Includes eraser holder.
- (10) Includes science demonstrator.
- (11) Includes stamp roll dispenser.
- (12) Includes sponge cup.
- (13) Includes hole punch.
- (14) Includes "desk set". For calendar holder, see subclasses 20+.
- (15) Includes ring or wire type.
- (16) For clip or clamp for clipboard, see Class D8-395.
- (17) For ink bottle, see Class D9.
- (18) Includes desk pad or typewriter pad.
- (19) Includes index tab.

CLASS D20 SALES AND ADVERTISING EQUIPMENT

DECEMBER 2003

- # 1 VENDING MACHINE (7) Figures partially obstructed are included in this subclass. Mannequins are in this subclass.
- # 2 .Stamp, ticket, or insurance type (1)
- 3 .Simulative (8) That is, made from flat, thin sheet material.
- 4 .Multiple diverse article or plural compartment, e.g., beverage, food, etc. (9) Includes post, per se.
- # 5 ..Bottle, can, or carton (2)
- 6 .Periodical, e.g., newspaper, etc.
- # 7 .Gum ball type (3)
- 8 .Element or attachment
- 9 ..Coin control mechanism
- # 10 SIGNS OR DISPLAY FORMS
- 11 .Decalcomania
- # 12 .Composite character (4)
- 13 .Vehicle license or emblem plate
- 14 ..Animate motif
- 15 .Desk-type name plate
- 16 .Barber pole or sign
- 17 .Street or highway address sign
- # 18 .Program reminder or programmable indicator, e.g., T.V., radio, etc. (5)
- 19 .Combined with diverse article or function
- 20 ..With time indicator
- 21 .Rotatable display
- # 22 .Label or tag (6)
- 23 ..Simulative
- 24 ...Animate
- 25Humanoid
- 26 ...Plant life
- 27 ..Substantially rectangular or square
- 28 ..Substantially circular or oval
- 29 .Simulative
- 30 ..Animate
- # 31 ...Humanoid (7)
- 32Element, e.g., hand, head, etc.
- 33Hand
- 34 ..Scenic or geographic representation
- 35 .Vehicle or element thereof
- 36 ..Star
- 37 ..Representation of consumable product or container therefor, e.g., barrel, bottle, etc.
- 38 ..Building
- 39 .Billboard type
- # 40 .Card type (8)
- # 41 .Post supported (9)
- 42 .Attachable to vertical surface or hanging type
- 43 .Fastener or support for card, price tag, etc.
- 44 ..Molding strip type
- 99 MISCELLANEOUS

SEARCH NOTES FOR CLASS D20:

- (1) For household type stamp holder, search D19-67.
- (2) Includes beverage vending, per se.
- (3) Includes element.
- (4) For electroluminescent type, search D18-26.
- (5) Includes holder therefor.
- (6) Excludes clothing label or applique; see D5-63+. Includes cigar band.

Title Change
* Newly Established Subclass

@ Indent Change
& Position Change

DECEMBER 2003

100 PROJECTILE LAUNCHING WEAPON
 101 .Combined
 102 .Spear gun or blow gun
 103 .Rifle or shotgun
 104 .Pistol
 105 ..Simulative motif
 # 106 .Slingshot
 # 107 .Bow
 108 .Firearm element or attachment
 109 ..Gunsight, ventilating rib, or mount
 110 ...Gunsight mount
 111 ..Recoil pad
 112 EXPLOSIVE OR PYROTECHNIC ARTICLE
 113 TARGET OR TARGET LAUNCHER
 114 .Aerial or disc type
 # 115 FREE FLIGHT PROJECTILE
 # 116 .Pellet or bullet
 117 HAND HELD WEAPON
 118 .Sword or knife
 # 119 TRAPPING, REPELLING, OR VERMIN
 DESTROYING
 # 120 .Repeller
 121 .Marine life
 122 .Insect type
 123 ..Electrocuting
 124 ..Fly swatter
 # 125 .Lure
 126 ..Fishing
 127 ...Wormlike
 128 ...With fibrous or featherlike appendage
 129 ...With spoon or spinner
 130Simulative
 131Fish
 132 ...Simulative
 133Fish
 # 134 FISHING EQUIPMENT
 135 .Net or scoop
 136 .Bait bucket or container
 # 137 .Rod or reel
 # 138 ..Combined
 139 ...With diverse article
 140 ..Crank operated reel
 # 141 ...Reel rotates perpendicular to rod
 # 142 ..Rod
 143 ..Line guide
 144 .Fishhook or guard
 145 .Sinker
 146 .Float
 147 .Fishing rod holder
 # 148 ..Combined with diverse article
 149 .Fisherman's tool
 150 ..Relatively movable plural handles
 199 MISCELLANEOUS

CLASS D23 ENVIRONMENTAL HEATING AND COOLING; FLUID HANDLING AND SANITARY EQUIPMENT

DECEMBER 2003

# 200	FLUID HANDLING OR TREATMENT EQUIPMENT	249	..Element or attachment
201	.Fountain	250	...Handle
202	.Storage tank	251Simulative
203	..Underground type (e.g., septic tank, etc.)	252Offset from axis
		253Rim connected to hub by spokes
204	..Substantially spherical	254With escutcheon
205	..Cylindrical	# 255	...Spout (9)
# 206	..Element or attachment (1)	256Simulative
207	.Treatment	257With control for diverter or drain
208	..Sanitary fixture type (e.g., deodorant holder, chemical dispenser, etc.)	258	...Float or check
		# 259	.Fitting (10)
# 209	..Filter or strainer (2)	# 260	..Cap, plug, vent or screen (11)
210	...Immersion type (e.g., aquarium filter, etc.)	# 261	...Drain guard or strainer (12)
		262	..Coupling or joint
211	.Lubricating can	263	...Elbow or with flow direction change
# 212	.Watering can (3)	264	...Adjustable (e.g., swivel, etc.)
# 213	.Dispersal (i.e., sprayer, fogger, nozzle, aerator, etc.) (4)	265	...Clamp or bolt engagement
# 214	..Sprinkler for lawn, agricultural irrigation or fire extinguishing (5)	266	..Pipe, tubing or hose
		267	..Gutter
		268	..Trap
215	...Simulative	269	..Gasket or packing
216	...Oscillating	270	SANITARY FIXTURE OR HOUSING THEREFOR
217	...With surface penetration means	# 271	.Combined (13)
218	...Recessed type	272	..Sink and stove or refrigerator
219	...Tracking type (i.e., sprinkler follows hose, etc.)	273	..Sink, water closet and bathing unit
		274	..Sink and water closet or urinal
220	...Plural rotating arms	275	..Bathtub and shower enclosure
221	...Base	# 276	.Sitz bath (14)
222	..Simulative	# 277	.Bathtub (15)
223	..Hand held or controlled type	278	..Infant type
224	...Direct piston or plunger actuation (i.e., without trigger or lever)	279	..With door or provision for external storage
# 225	...With material container (6)	# 280.1	..Symmetrical (16)
226	...Trigger, lever or button actuation	280.2	...Having support handle
227Cover or guard	280.3	...Having antislip surface
228	..Combined	280.4	...Footed
229	..Provision for adjustment of spray pattern or flow	# 283	.Shower or shower receptor (17)
		284	.Sink
230	..Ball and socket joint for adjustment	285	..Simulative, or with radiating striations
231	.Hand or foot operated pump or well curb		..With cabinet or with provision for storage
232	..Reciprocating lever actuated	286	..With drainboard (i.e., adjacent recessed inclined surface)
233	.Valve or body therefor		..Corner type
234	..Hydrant	287	..Shampoo type (e.g., with depression on rim for neck, etc.)
235	..Pressure regulating or relieving	288	..Plural
236	..Ballcock or float type	289	..With integral spout or hooded overflow
237	..Check	290	..Unitary singular support column
# 238	..Faucet fixture (7)	# 293.1	..Symmetrical (16)
239	...Combined (e.g., with dishwashing brush, support therefor, etc.)	291	.Water closet, bidet or bowl therefor
		292	..Infant training type
240With soap dish or with provision therefor	293	...Simulative
241	...Plural flow controls or provision therefor	294	..Simulative
242Distinct (i.e., when mounted, controls and spout are separated)	295	..Self-contained (i.e., chemical or portable type)
243Pivoting spout	296	..Wall mounted
244	..Gate or butterfly type	297	..With water tank (18)
245	..Manual or visible mechanical control or with provision therefor (e.g., handle, lever, etc.)	298	.Urinal (19)
		299	.Element or attachment (20)
# 246	...With gauge or dial (8)	300	
247	..Symmetrical on two or more axes	# 301	
248	..Symmetrical on one axis	# 302	
		# 303	

Title Change
* Newly Established Subclass

@ Indent Change
& Position Change

CLASS D23 ENVIRONMENTAL HEATING AND COOLING; FLUID HANDLING AND SANITARY EQUIPMENT

DECEMBER 2003

	SANITARY FIXTURE OR HOUSING THEREFOR	356	..Humidifier
	.Element or attachment (20)	357	...Wall or furnace mount
304	..Bathtub or shower	358	...Element
305	...Surround, door or panel	359	..Dehumidifier
306Front	360	..Vaporizer
307	...Splash shield	361	...Wall mount
# 308	..Sink (21)	362	...Circular container
309	..Water closet or urinal	363	...Element
# 310	...Deflector (22)	364	..Air cleaner
# 311	...Seat, or bowl cover (23)	365	...Filter
312Simulative	# 366	..Deodorizer or ozonizer (28)
313	...Tank or tank cover	367	...Simulative
314	HEATING OR COOLING	368	...With distinct hanger or suction cup
315	.Sauna or steam bath type	369	...Activated by moveable cover or by piercing
# 316	.Liquid immersion type, e.g., aquarium, swimming pool, etc. (24)	370	..Fan or ventilator
317	.Mobile space heater, e.g., wheeled blower type, etc.	371	...Exhaust type
318	.Domestic water heater or boiler	372Range or oven
319	..Boiler	373Roof or chimney
320	..With door or access panel	374Chimney
321	..With discharge valve or tap	375Wind rotated, e.g., turbine type, etc.
322	..Element	376Circular hood
323	...Heat exchange unit, e.g., coil, etc.	377	...Blade unit rotates on vertical axis
324	.Vehicle heating or cooling	378	...Floor type on vertically elongated stand
325	..Air conditioning		...With exposed blade
326	..Defroster	379	...Plural impeller units, e.g., side by side, etc.
327	..With adjustable louver or door	380	...Wire protective grille
328	.Combined heating and cooling or with diverse element	381Circular grille
329	.Furnace	382	...Blower
330	.Radiator, e.g., spaced enclosed heat exchangers	383	...Bellows
331	..Plant life or scroll type ornamentation	# 385	..Wall or ceiling mount (24)
332	.Portable	386	.Element or attachment, not elsewhere specified
333	..Air conditioner	387	..Flow director (29)
334	..Animal or agricultural heater	388	...Register or diffuser
335	..Heating element protected by grille, grid, etc.	389	...Baseboard type
336	...Circular or cylindrical housing	390	...Circular
337	...Pedestal or pivoting head mount	391	...Arched or curved top
338	...Liquid fuel type, e.g., kerosene, etc.	392	...Adjustable louver or damper
339	...Gas fired type	393	...Vent, ductwork, or element thereof
340	...Quartz type	394	...Stovepipe
341	..Element	395	..Radiator cover or cabinet
342	.Stabile space heater	396	..Stoker
# 343	..Fireplace or solid fuel heating stove (25)	397	..Grate
344	...Fireplace insert	398	...Fireplace type (30)
345	...Masonry or tile-like surround, e.g., architectural type fireplace	399	...Hollow tube circulator with blower unit
# 346	...Ornate cast iron type (26)	400Perforated or expanded metal
347Element therefor, e.g., stove plate, etc.	401Enclosed four sides
348	...Circular horizontal cross section	402	...Stove or furnace type
349	..Simulative	403	..Fireplace element not elsewhere specified
350	...Symmetrical front	404	...Mantle or frame for opening
# 351	.Air conditioner (27)	405	...Lining or enclosure for opening (31)
352	..Circular housing	406	...Screen
353	..Window mount type	407	...Andiron or fire dog
354	..Element, e.g., front panel, etc.	408Simulative
355	.Air treatment		

Title Change
* Newly Established Subclass

@ Indent Change
& Position Change

CLASS D23 ENVIRONMENTAL HEATING AND COOLING; FLUID HANDLING AND SANITARY EQUIPMENT

DECEMBER 2003

HEATING OR COOLING

.Element or attachment, not elsewhere specified
 ..Fireplace element not elsewhere specified
 409 ...Artificial log burner element
 410 ..Coal scuttle or wood holder
 411 ..Fan element
 412 ...Fan guard
 413 ...Fan or ventilator blade
 414 ...With circumferential band
 415 ..Burner or heater coil
 416 ...Oil type
 417 ...Electric
 418 ...Element
 419 ...Radiant
 420 ..Ash pan or sifter
 421 ..Valve or control
 422 ..Fire brick
 499 MISCELLANEOUS

(21) For drain stopper or screen see, respectively, subclasses 260 and 261.
 (22) For drain screen, see subclass 261.
 (23) For infant training seat, see subclass 296. For seat lifter handle, see D8-307.
 (24) Includes element.
 (25) Stoves with upper and lower doors, e.g., for fuel supply and ash removal are included in this subclass.
 (26) Highly surface ornamented parlor or Franklin-type stoves of the late 19th and early 20th century variety. Ornamentation usually formed as part of the casting.
 (27) Includes cooling tower.
 (28) Includes all air freshener articles.
 (29) See air conditioner element, subclass 354 for additional flow director panels.
 (30) Search subclass 405 for grate combined with interior lining.
 (31) Decorative panel for season use.

SEARCH NOTES FOR CLASS D23

- (1) For cap or plug, see subclass 260. For underwater breathing apparatus, valves, or regulators, see D24-110.5+.
- (2) For filter disclosed as part of a faucet, see subclasses 238+ For aerator, see subclass 213.
- (3) For battery water dispenser, see subclass 200.
- (4) For aerator disclosed as part of a faucet, see subclasses 238+. For shower head disclosed with shower unit structure, see subclass 283.
- (5) For hose nozzle or hand held sprayer, see subclasses 223+. For time or control, see subclass 245.
- (6) Container must be shown in full or in broken lines.
- (7) If disclosed with sink, classified in subclasses 284+.
- (8) For gauge or dial, per se, see Class D10.
- (9) Includes spout with provision for diverter control. If provision is made for flow control handle, patent is classified as faucet in subclasses 238+.
- (10) Includes overflow fitting.
- (11) Includes sink stopper.
- (12) Includes urinal screen.
- (13) For faucet combined with sink and/or cabinet, see subclasses 284+.
- (14) For bidet, see subclass 295.
- (15) For front panel or sub-assembly, see subclasses 304+.
- (16) Exclusive of drain or overflow opening.
- (17) For bathtub surround, see subclass 305. For shower head, per se, or with associated plumbing only (such as valve), see subclass 213.
- (18) For tank, per se, see subclass 313.
- (19) For water closet attachment type, see subclass 310.
- (20) Includes leg or support For overflow fitting, see subclass 261 For drain stopper or screen see, respectively, subclasses 260 and 261.

Title Change
 * Newly Established Subclass

@ Indent Change
 & Position Change

CLASS D24 MEDICAL AND LABORATORY EQUIPMENT

DECEMBER 2003

# 100	PHARMACEUTICAL PRODUCT	137	..Viewing (e.g., otoscope, ophthalmoscope, etc.)
# 101	.Tablet or caplet (1)		
# 102	..Simulative (2)	# 138	...Remote (e.g., endoscope, proctoscope, etc.) (26)
103	..Scored for dosage control		
104	.Capsule	139	...Mirror
# 105	PROPHYLACTIC ARTICLE	140	..Guide or gauge
106	.Ear plug or nose clip	# 141	..Body cavity insertion (e.g., tampon or suppository applicator, etc.) (27)
107	EQUIPMENT FOR DIAGNOSIS, ANALYSIS, OR TREATMENT	142	..Reflex or percussive
# 108	.Article for the introduction, removal or collection of fluids (e.g., infusion, extraction, irrigation, etc.) (3)	# 143	..Clamp or forceps (28)
		# 144	..Electrosurgical (e.g., electrolysis type, cauterizer, etc.) (29)
109	..Lacteal extractor	# 145	..Suturing or fastening (e.g., stapling, etc.) (30)
# 110	..Respirator, vaporizer, or inhalation tube (4)	# 146	..Cutting, abrading, scraping or puncturing (31)
110.1	...Mask	# 147	...Manually driven (32)
# 110.2Including eye shield (5)	148Pivoted jaws (e.g., scissors type, etc.)
110.3Helmet type		
110.4Including provision for tube	149Opposed (i.e., double ended)
# 110.5	..Inhalation tube or mouthpiece type (6)	150	..Ophthalmic
		151	..Auricular
110.6Regulator or valve	# 152	..Dental (33)
# 111	..Infusion or irrigation pump (e.g., dental irrigation unit, powered douche unit, etc.) (7)	153	...Pivoted jaws
		154	...Opposed (i.e., double ended)
# 112	..Conduit or nozzle (e.g., syringe, cannula, catheter, etc.) (8)	155	.Prosthesis or implant
113	...Hand actuated flow control (e.g., lever, button, etc.)	# 156	..Dental (34)
		157	..Ocular
114Rectilinear arrangement of actuator and plunger (i.e., straight-line syringe type)	# 158	.Image generation or radiation therapy (35)
# 115Resilient (e.g., squeeze bulb, bellows, etc.) (9)	# 159	..With patient table (36)
		160	..With viewing screen or eyepiece
# 116	...With spoon for ingestion (10)	161	..Film holder
# 117	...With reservoir (11)	# 162	.Filter (37)
# 118Flaccid or flexible (e.g., pouch, bag, etc.) (12)	163	.Incubator
# 119	..Topical applicator (e.g., swab, etc.) (13)	# 164	.Pulmonary (38)
		165	.Sphygmomanometer
120	...Eye cup	166	..Column or dial gauge, or provision therefor
# 121	..Receptacle or vessel (14)	# 167	.Cardiological (39)
# 122	...Urinary specific (15)	# 168	..With external paddle, electrode or contact (40)
# 123	...Basin or bedpan (16)	# 169	.Hematological or intravenous treatment (41)
# 124	..Absorbent (17)	# 170	.Electrosurgical (42)
# 125	...Catamenial (18)	# 171	.Orthopedic or chiropractic (43)
126	...Diaper type or holding garment therefor	# 172	.Ophthalmic (44)
# 127	..Element or attachment (19)	# 173	.Auricular (45)
# 128	...Support, holder or bracket (20)	174	..Hearing aid
# 129	...Connector or flow control fitting (e.g., valve, sensor, manifold, etc.) (21)	175	...Voice reflector
# 130	...Syringe, catheter or needle component (22)	# 176	.Dental (46)
		177	..Patient service unit or console
131Destruction or disposal unit	# 178	...With body support (47)
132	...Cover, liner or cushion for basin or bedpan	179	...Foot operated control
# 133	.Hand manipulated tool or instrument (23)	180	..Orthodontic appliance
		# 181	..Mold, model or form (48)
# 134	..Stethoscope (24)	182	..Articulator
# 135	..Speculum, dilator or retractor (25)	# 183	.Patient table or support (49)
136	...Tongue depressor	184	..Element or attachment
		185	.Patient service unit or console

Title Change
* Newly Established Subclass

@ Indent Change
& Position Change

EQUIPMENT FOR DIAGNOSIS, ANALYSIS, OR TREATMENT	#	LABORATORY EQUIPMENT NOT ELSEWHERE SPECIFIED
# 186 .Patient monitor or diagnostic instrument not elsewhere specified (50)	233	.Electrophoresis
# 187 .Electrode, transducer or contact not elsewhere specified (51)	# 234	.Work station or surface (68)
# 188 .Article for topical care, nursing or rehabilitation (52)		
# 189 ..Bandage for protection or treatment (53)		
# 190 ..Body attached restraint, support or guard (e.g., cast, sling, orthotic device, etc.) (54)		
191 ...Head or neck		
192 ...Foot or ankle		
# 193 ..Pediatric (55)		
# 194 ...Nipple, pacifier or masticator (56)		
195Simulative		
196Nipple		
# 197 ...Nursing bottle or container (57)		
198Simulative		
199Holder or cover		
# 200 ..Kinesitherapy (e.g., massage, thermal treatment or electrical stimulation, etc.) (58)		
201 ...Hydrotherapy		
202Fully enclosed therapy chamber		
203Steam or sauna		
# 204Tank or bath (59)		
205Bilaterally symmetrical		
206 ...Thermal		
# 207Container for fluid (e.g., hot or cold water bottle, bag, etc.) (60)		
208Simulative		
209 ...Solar, light or radiant tube therapy		
# 210 ...Lamp or radiant tube (61)		
211 ...Roller, ball or similar protuberance		
212Foot therapy		
213 ...Foot therapy		
214 ...Hand held or attached		
215 ...Massager or vibrator		
# 216 .Specimen handling, preparation or testing (62)		
217 ..Sterilizer or cleaner		
218 ...Contact lens type		
219 ..Centrifuge		
# 220 ..Mixer or grinder (63)		
221 ...Dental		
222 ..Pipette or burette		
# 223 ..Interrelated indication or reaction set (i.e., "test kit") (64)		
# 224 ..Vessel, specimen holder or reagent material (65)		
225 ...Slide or reagent sheet type		
226 ...Plural divisions		
# 227 ..Tray, rack or vessel holder (66)		
228 ...Wire type		
229 ...Compartmented, or with aperture, clip or recess for retention of plural articles		
230Circular aperture or recess		
# 231 .Miscellaneous (67)		

SEARCH NOTES FOR CLASS D24:

- (1) For counting, checking or dispensing tray, see subclass 227. For storage vessel, see subclass 224.
- (2) Includes letter or numeral.
- (3) This and indented subclasses are limited to fluid introduction or removal articles. For treatment equipment, see coordinate subclasses that follow. For example, hemodialysis units are classified in subclass 169, but blood pumps, per se, are classified in subclass 111; For lung or blood treatment unit, see, respectively, subclasses 164 and 169; For nursing bottle, see subclasses 197+. For puncturing instrument in general (i.e., without fluid flow function), see subclass 147; For transdermal patch, see subclass 189; For inhalation therapy oxygen or air treatment, see subclass 164.
- (4) Includes smelling salts article; For general-use douche or syringe, see subclasses 112+; For pulmonary testing, treating or exercising article, see subclass 164.
- (5) Includes air-supplying outer space or underwater helmet and underwater swim mask that covers both the eyes and nose. For eyewear that does not occlude or filter air for breathing, see D16-300+. For eyepiece element, see D16-101+. For protective headgear combined with transparent eye shield, see D29-110.
- (6) Includes snorkel.
- (7) Includes anesthesia machine; Includes infusion cassette; For blood treatment or analysis unit; see subclass 169; For manually operative unit or gravity controlled, see subclasses 112+.
- (8) Includes nozzle, per se; For biopsy probe, see subclass 147; For pipette, see subclass 222; For fluid delivery article combined with dental work station or console, see subclass 177; For similar article designed to insert solid material into body cavity, e.g., solid medication, see subclass 141. For nursing nipple, see subclass 194.
- (9) Includes dropper type; For dropper combined with "test kit", see subclass 223; For pipette, see subclass 222.
- (10) For spoon, per se, see Class D7-653+.
- (11) Includes reservoir, per se; For vessel used when evacuation is active rather than passive (i.e., urinal or bedpan without conduit element), see subclasses 121+. For nursing bottle see subclass 197.

DECEMBER 2003

- (12) Includes douche or enema bag; For hot water or ice bag, see subclass 207.
- (13) Includes inoculation loop; For between-teeth gum stimulator, see D28-64.
- (14) For similar article including means for conduit delivery (i.e., fountain syringe type), see subclasses 117+; For specimen handling or for medication storage container (e.g., vial, test tube, etc.) see subclass 224.
- (15) For sample vial type, see subclass 224.
- (16) For similar article having a conduit element, see subclasses 117+.
- (17) For bandage, see subclass 189.
- (18) Includes holder; For application device or tool, see subclass 141; For contraceptive article, see subclass 105; For pessary, see subclass 135.
- (19) For tray or rack, see subclass 227. For filter, see subclass 162.
- (20) Includes cover; For general specimen or specimen container holder, see, respectively, subclass 224 and 227; For fluid container holder that is not patient-interactive, e.g., syringe rack, medication tray, etc. see subclass 227.
- (21) For tubing clamp, see subclass 143.
- (22) For clamp, see subclass 143; For needle, catheter or conduit, per se, see subclass 112.
- (23) Element included in this and in indented subclasses; For cardiac resuscitative stimulator, see subclass 167; For kinesitherapy article, see subclass 200; For medical treatment fixed equipment, see following coordinate subclasses; For specimen handling, preparing or testing article, see subclass 216; For holder, see subclass 227; For sphygmomanometer, see subclass 165; For pipette, see subclass 222.
- (24) For generic transducer, see subclass 187; For sphygmomanometer, see subclass 165.
- (25) Includes pessary; For remote or direct viewing instrument, see subclass 137 to 139.
- (26) For direct viewing hand instrument (e.g., optoscope, ophthalmoscope, etc.), see subclass 137.
- (27) For rectilinear piston or plunger fluid delivery article, see subclass 114.
- (28) Includes penile blood flow limiter device; Includes hand manipulated tourniquet; For mechanical or electronic tourniquet, see subclass 169; For sphygmomanometer cuff, see subclass 165.
- (29) Includes laser type; Includes tattooing instrument.
- (30) Includes fastener, per se; Includes stapler; For clamp, see subclass 143.
- (31) For dental drill combined with work station, see subclass 177; For tattooing instrument, see subclass 144; For broach, burr or drill component, see subclasses 147+.
- (32) Includes acupuncture needle; Includes biopsy needle; Includes blade or carrier therefor; Includes broach, burr, drill, etc.; Includes curette or scraper; For between-teeth gum stimulator, see D28-64.
- (33) For dental work station, see subclass 177; For drilling, scraping, brushing or abrading instrument, see subclass 146.
- (34) For cleaning unit, see subclass 217; For orthodontic appliance, see subclass 180; For holder, see subclass 227.
- (35) Includes element, e.g., film or plate holder, etc.; For body or limb support, see subclass 183.
- (36) For patient support, per se, see subclass 183.
- (37) For more comprehensive treatment equipment for air, blood, or other fluids, see subclasses 164 and 169.
- (38) Includes therapy equipment; For blood alcohol level measuring or detecting by means of breath analysis, see subclass 169; For nose or mouth contacting article, e.g., vaporizer, inhaler, mouthpiece or airway tube, see subclass 110. For heart-lung machine, i.e., blood oxygenator, see subclass 169. Includes snore-inhibiting device.
- (39) For general purpose electrode or contact, see subclass 187; For heart-lung machine, i.e., blood oxygenator, see subclass 169.
- (40) Includes paddle, electrode or contact, per se.
- (41) Includes oxygenator or heart-lung machine; Includes blood alcohol percentage measurement device; For chemical or biological testing equipment lacking instrumentation, see subclasses 216+; For filter, see subclass 162; For hemostat or other hand manipulated tool, see subclasses 133+ and 143; For fluid pump or infusion article without treatment characteristic, see subclass 111; For blood pressure measuring instrument, see subclass 165. Includes oximeter, tourniquet, blood gas treatment device and organ fluid warmer.
- (42) For hand manipulated cutting or electrolysis instrument, see subclasses 144 and 147; For body contact, electrode, etc., see subclass 187. Includes laser unit.
- (43) For body support surface, see subclass 183; For therapeutic apparatus (e.g., traction unit, etc.), see subclass 188.

- (44) For contact lens sterilizer, see subclass 218.
- (45) For ear plug, see subclass 106.
- (46) For infant teething article, see subclasses 194+; For kiln or melting crucible, see D15-144.1; For tray, rack or holder, see subclass 227; For amalgam mixer, see subclass 221; For body support, per se, see subclass 183; For irrigation type cleaner, see subclass 111; For denture cleaner, see subclass 217.
- (47) For nondental patient service unit or console, see subclass 185.
- (48) Includes dental molding flask or impression tray; Includes repair shade guide; For mixing slab, see subclass 221.
- (49) For similar support combined with dental service unit, see subclass 178; For body-attached support such as splint, see subclass 190; For kinesitherapy article, see subclass 200. Includes therapeutic pillow or body support.
- (50) Includes uriometer; For specimen testing, e.g., medical testing instrument used in laboratory environment, see subclass 216.
- (51) For stethoscope transducer, see subclass 134; For hearing aid transducer, see subclass 174; For diathermy electrode, see subclass 206.
- (52) Includes, in this subclass, exercise unit not elsewhere specified; For electrode or contact, see subclass 187; For electrotherapeutic equipment or cabinet, see subclass 200.
- (53) Includes adhesive hair removal strip; infusion anchor and nasal anchor; For catamenial article, see subclass 125.
- (54) For passive body support or rest surface, see subclass 183; For orthodontic appliance, see subclass 180; For anti-thumbsucking device, see subclass 193; For traction article, see subclass 188; For penile blood flow limiting device, see subclass 143.
- (55) For diaper, see subclass 126.
- (56) For nursing bottle claimed in combination with nipple, see subclass 197.
- (57) Includes shell for disposable or flaccid type container; For nipple, see subclass 194.
- (58) For generic therapeutic "cabinet", see subclass 188; For cardiac treatment article, see subclass 167; For orthopedic exercise or traction article, see subclass 188.
- (59) Includes foot bath; For water or bubble circulator or generator, per se, see subclass 201.
- (60) For similar article with provision for fluid flow, see subclass 118.
- (61) For x-radiation treatment, see subclass 158.
- (62) Includes microtome; For patient interactive equipment, e.g., syringe, electrocardiographic equipment, dental work station, etc., see preceding coordinate subclasses.
- (63) Includes mortar, pestle, muddler, etc.; Includes pill crusher; For reagent material container or for carrier therefor see, respectively, subclass 224 and 227.
- (64) Includes pregnancy test set; For reagent vessel or test strip, per se, see subclass 224; For vessel holder, per se, see subclasses 227+.
- (65) Includes vessel for medication; For patient - interactive vessel such as urinal, bedpan, etc., see subclass 121.
- (66) For holder for use in centrifuge, see subclass 219; For vessel, per se, see subclass 224.
- (67) Includes white noise generator.
- (68) Includes clean air work station, air lock, etc.

CLASS D25 BUILDING UNITS AND CONSTRUCTION ELEMENTS

DECEMBER 2003

# 1	STRUCTURE	59	...Exterior, e.g., storefront
2	.Swimming pool	# 60	..Surround for door window, panel, etc. (13)
3	.Combined with diverse article, e.g., airport complex, etc.	# 61	.Framing unit, e.g., building frame (14)
4	.Clustered identical units	# 62	STAIR, LADDER, SCAFFOLD, OR SIMILAR SUPPORT
5	.Four or more levels	# 63	.Stepped (15)
6	..Tower	64	..Ladder
7	.Simulative	65	...Step stool type
8	..Animate	66	.Scaffold
9	...Humanoid	67	.Sawhorse
10	..Edible article or container therefor	# 68	.Element or attachment (16)
11	..Vehicle	69	..Stair tread, step or ladder rung
12	.Arena or stadium	100	TRELLIS OR TREILLAGE UNIT
# 13	.Geodesic dome (1)	101	.Simulative
14	.Grain storage	# 102	ARCHITECTURAL STOCK MATERIAL
15	.Greenhouse	103	.Transparent or translucent
# 16	.Single occupant type, i.e., telephone booth, privy, ticket booth, etc. (2)	104	..Simulative
# 17	.Having intersecting angular or curved roofs (3)	105	...Plant life
18	.Having curved or vaulted roof	# 106	..Three or more pattern repeats about axis on side (17)
19	..Dome	107	...Hollow type
20	..Sinuous	108	..Hollow type
21	..Concave, catenary or flexibly suspended	# 109	..Symmetrical on two axes on one side (18)
22	.Having angular roof	110	..Unidirectional repeat pattern
23	..Trapezoidal or triangular surface	# 111	..Random arrangement of pattern elements within repeat unit (19)
24	...Gambrel type	112	.Splash block
25	...Mansard type	# 113	.Construction block or brick type (20)
26	...Pyramidal	# 114	..Perforated or openwork (21)
27	...Zig-zag type, i.e., sawtooth	115	...Symmetrical
28	...Inverted	116	...Arcuate detail
29	...A-frame type	117Circular or oval
30	...Isolated slanted surface	118	...Rectangular or square detail
31	.Circular or oval in plan	# 119	.Extruded shape (22)
32	.Polygonal in plan	120	..Three or more repeats, or uniform configuration, about axis
33	.Fully enclosed	121	..Bilaterally symmetrical
34	..Having carport or garage	122	..With hollow core
# 35	PREFABRICATED UNIT	123	...Parallel repeating ribs or grooves
# 36	.Underground service vault (4)	124	..With hollow core
# 37	.Elevator cab interior (5)	125	..Parallel repeating ribs or grooves
# 38	.Railing unit or fence (6)	126	.Post or beam
39	..Combined, e.g., fence and gate	127	..With cross arm or cantilevered support
40	..Simulative	128	..Three or more repeats, or uniform configuration, about axis
41	..Swimming pool grab rail	129	..Vertically fluted
42	..Post or board extending above rail, e.g., picket type	130	..Simulative
43	..Post and rail type	131	..With notch or tang for receiving attachment (e.g., fencing wire, etc.)
44	...Rail centered on post	132	..Openwork type or with opening
# 45	..Wire type (7)	133	..Element or attachment
46	...Barbed	134	...Cross arm or cantilevered support
# 47	.Closure (8)	135	...Capital or cap
48	..For passage, e.g., door, etc.	# 136	.Elongated molding type (e.g., crown, dentil, etc.) (23)
49	...Flexible or folding	137	..Simulative
50	...Gate	# 138	.Panel, tile or applique or floor, wall, roof, etc. (24)
51Turnstile	139	..Roofing, or wall shingle
52	..Window		
# 53	..Screen or guard (9)		
54	..Window well cover		
# 55	.Finishing unit (10)		
# 56	..Roof or canopy (11)		
57	...Awning type		
# 58	..Partition, wall or ceiling (12)		

Title Change
* Newly Established Subclass

@ Indent Change
& Position Change

	ARCHITECTURAL STOCK MATERIAL	
	.Panel, tile or applique or floor, wall, roof, etc. (24)	(14) Includes cantilever support.
	..Roofing, or wall shingle	(15) For mobile stairs, see D34-30.
140	...Tile type	(16) For component that is adaptable to other article, such as handrail, post, etc., see subclasses 102+.
141	...Stamped, crimped or bent material having uniform thickness	(17) Planar surface not considered.
142	...Perforated or openwork	(18) Planar surface not considered.
143	...Three or more repeats, or uniform configuration, about axis	(19) If repeat protocol is apparent from the disclosure, patent is classified under earlier subclasses. If, however, the disclosed pattern element does not indicate how it can repeat, patent is classified here.
144	...Symmetrical on two axes	(20) For edging, see subclass 164.
# 145	..Relief carving or medallion type (25)	(21) Opening must extend through the article.
146	...Humanoid simulation	(22) To be classified in this subclass, article must have uninterrupted extruded shape. If openings, protrusions, rivets, vertical striations, etc., are disclosed with an elongated article, patent is classified in subclasses 126, 136 or 164. For articles with specific end configuration such as fence picket, see subclasses 126+.
147	...Three or more repeats, or uniform configuration, about axis (e.g., medallion, etc.)	(23) If molding has extruded shape, see subclasses 119+. For corner or end piece, see subclass 102.
148	...Symmetrical on two axes	(24) For generic elongated stock material having indefinite length, see subclass 164.
149	..Simulative, or natural material pattern	(25) For embossed panelwork or for grill, see subclasses 138, 152 or 157.
150	...Wood grain	(26) For brick per se, see subclasses 113+.
# 151	...Brick or stone (26)	(27) Opening must extend through the article. Otherwise patent is classified in subclasses which follow.
# 152	..Perforated or openwork (27)	(28) Exclusive of random acoustic texture within symmetrical pattern unit, or of tongue or groove edge detail.
153	...Symmetrical pattern or pattern unit	(29) Includes railing, edging, etc. However, if railing, etc. has an extruded shape, patent is classified in subclasses 119+. For corner or end piece, see subclass 102.
154Arcuate	
155Circular or oval	
156Rectangular or square	
# 157	..Symmetrical pattern or pattern unit (28)	
158	...Three or more repeats, or uniform configuration, about axis	
159Consisting entirely of material having uniform thickness	
160	...On two axes	
161Consisting entirely of material having uniform thickness	
162	...Consisting entirely of material having uniform thickness	
163	..Textured (e.g., pitted, cratered, drilled, etc)	
# 164	..Elongated (29)	
# 199	MISCELLANEOUS	

SEARCH NOTES FOR CLASS D25.

- (1) For arcuate dome, see subclass 19.
- (2) Includes structures that enclose a person.
- (3) Search subclasses 56+ for roof, per se.
- (4) Includes element.
- (5) For elevator, see D34-33.
- (6) For handrail or post, see respectively, subclasses 119 and 126+.
- (7) Includes element.
- (8) Includes shutter; includes a combination with surround. For surround per se, see subclass 60.
- (9) Includes only screens or guards that are designed solely for window or door. For grille adaptable to other architectural uses, see subclasses 152+. For perforated sheet material, see D5-1+.
- (10) Includes rigid drapery cornice.
- (11) If structure has wall, see subclasses 1+.
- (12) Includes stage set.
- (13) Includes arch structure.

Title Change
* Newly Established Subclass

@ Indent Change
& Position Change

A. DESIGN CLASS MODIFICATIONS

Additions and Modifications to the Class Schedule

CLASS D19 - OFFICE SUPPLIES; ARTISTS' AND TEACHERS' MATERIALS

Project Leader: Charles Rademaker

Under the Exclusion Notes:

Delete: All the Exclusion Notes including the heading.

In the Class Schedule:

Subclass 1: In the Class Schedule

Delete:

(1)

Subclass 2: In the Class Schedule

Delete:

(2)

Insert:

(1)

Subclass 11: In the Class Schedule

Delete:

(3)

Insert:

(2)

Subclass 22: In the Class Schedule

Delete:

(5)

Insert:

(3)

Subclass 23: In the Class Schedule

Delete:

(6)

Insert:

(4)

Subclass 26: In the Class Schedule

Delete:

(7)

Subclass 33: In the Class Schedule

Delete:

(8)

Insert:

(5)

Subclass 35: In the Class Schedule

Delete:

(9)

Subclass 37: In the Class Schedule

Delete:

(10)

Insert:

(6)

Subclass 52: In the Class Schedule

Delete:

(11)

Insert:

(7)

Subclass 53: In the Class Schedule

Delete:

(12)

Insert:

(8)

Subclass 58: In the Class Schedule

Delete:

(13)

Insert:

(9)

Subclass 59: In the Class Schedule

Delete:

(14)

Subclass 62: In the Class Schedule

Delete:

(15)

Insert:

(10)

Subclass 65: In the Class Schedule

Delete:

(16)

Subclass 67: In the Class Schedule

Delete:

(17)

Insert:

(11)

Subclass 70: In the Class Schedule

Delete:

(18)

Insert:

(12)

Subclass 72: In the Class Schedule

Delete:

(19)

Insert:

(13)

Subclass 75: In the Class Schedule

Delete:

(20)

Insert:

(14)

Subclass 86: In the Class Schedule

Delete:

(21)

Insert:

(15)

Subclass 88: In the Class Schedule

Delete:

(22)

Insert:

(16)

Subclass 93: In the Class Schedule

Delete:

(23)

Insert:

(17)

Subclass 95: In the Class Schedule

Delete:

(24)

Insert:

(18)

Subclass 99: In the Class Schedule

Delete:

(25)

Insert:

(19)

Under the Search Notes:

Delete: The search notes numbered as follows:

(1), (7), (9), (14), and (16)

Renumber: The remaining search notes as follows:

(2) renumber as (1)

(3) renumber as (2)

(5) renumber as (3)

(6) renumber as (4)

(8) renumber as (5)

(10) renumber as (6)

(11) renumber as (7)

(12) renumber as (8)

(13) renumber as (9)

(15) renumber as (10)

(17) renumber as (11)

(18) renumber as (12)

(19) renumber as (13)

(20) renumber as (14)

(21) renumber as (15)

(22) renumber as (16)

(23) renumber as (17)

(24) renumber as (18)

(25) renumber as (19)

List: The search notes sequentially from (1) through (19).

A. DESIGN CLASS MODIFICATIONS

Additions and Modifications to the Class Schedule

CLASS D20 – SALES AND ADVERTISING EQUIPMENT

Project Leader: Charles Rademaker

Under the Exclusion Notes:

Delete: All the Exclusion Notes including the heading.

In the Class Schedule:

Subclass 1: In the Class Schedule

Delete:

(1)

Subclass 2: In the Class Schedule

Delete:

(2)

Insert:

(1)

Subclass 5: In the Class Schedule

Delete:

(3)

Insert:

(2)

Subclass 7: In the Class Schedule

Delete:

(4)

Insert:

(3)

Subclass 10: In the Class Schedule

Delete:

(11)

Subclass 12: In the Class Schedule

Delete:

(5)

Insert:

(4)

Subclass 18: In the Class Schedule

Delete:

(6)

Insert:

(5)

Subclass 22: In the Class Schedule

Delete:

(7)

Insert:

(6)

Subclass 31: In the Class Schedule

Delete:

(8)

Insert:

(7)

Subclass 40: In the Class Schedule

Delete:

(9)

Insert:

(8)

Subclass 41: In the Class Schedule

Delete:

(10)

Insert:

(9)

In the Search Notes:

Delete: Notes (1) and (11)

Renumber: The remaining search notes as follows:

(2) renumber as (1)

(3) renumber as (2)

- (4) renumber as (3)
- (5) renumber as (4)
- (6) renumber as (5)
- (7) renumber as (6)
- (8) renumber as (7)
- (9) renumber as (8)
- (10) renumber as (9)

List: The search notes sequentially from (1) through (9).

A. DESIGN CLASS MODIFICATIONS

Additions and Modifications to the Class Schedule

CLASS D22 – ARMS, PYROTECHNICS, HUNTING AND FISHING EQUIPMENT

Project Leader: Charles Rademaker

Under the Exclusion Notes:Delete: All the Exclusion Notes including the headingIn the Class Schedule:

Subclass 100: In the Class Schedule

Delete:

(1)

Subclass 106: In the Class Schedule

Delete:

(2)

Subclass 107: In the Class Schedule

Delete:

(3)

Subclass 115: In the Class Schedule

Delete:

(2)

Subclass 116: In the Class Schedule

Delete:

(e.g., cartridge, etc.)

Subclass 119: In the Class Schedule

Delete:

(2), (3)

Subclass 120: In the Class Schedule

Delete:

(e.g., ultrasonic, chemical, etc.)

Subclass 125: In the Class Schedule

Delete:

(e.g., decoy, etc.)

Subclass 134: In the Class Schedule

Delete:

(2)

Subclass 137: In the Class Schedule

Delete:

(4)

Subclass 138: In the Class Schedule

Delete:

(5)

Subclass 141: In the Class Schedule

Delete:

(e.g., spinning reel, etc.)

Subclass 142: In the Class Schedule

Delete:

(6), (7)

Subclass 148: In the Class Schedule

Delete:

(e.g., signal, etc.)

In the Search Notes:

Delete: All Search Notes including the heading.

A. DESIGN CLASS MODIFICATIONS

Additions and Modifications to the Class Schedule

CLASS D23 – ENVIROMENTAL HEATING AND COOLING; FLUID HANDLING AND
SANITARY EQUIPMENT

Project Leader: Charles Rademaker

Under the Exclusion Notes:

Delete: All the Exclusion Notes including the heading.

In the Class Schedule:

Subclass 200: In the Class Schedule

Delete:

(1)

Subclass 206: In the Class Schedule

Delete:

(2)

Insert:

(1)

Subclass 209: In the Class Schedule

Delete:

(3)

Insert:

(2)

Subclass 212: In the Class Schedule

Delete:

(4)

Insert:

(3)

Subclass 213: In the Class Schedule

Delete:

(5)

Insert:

(4)

Subclass 214: In the Class Schedule

Delete:

(6)

Insert:

(5)

Subclass 225: In the Class Schedule

Delete:

(7)

Insert:

(6)

Subclass 238: In the Class Schedule

Delete:

(8)

Insert:

(7)

Subclass 246: In the Class Schedule

Delete:

(9)

Insert:

(8)

Subclass 255: In the Class Schedule

Delete:

(10)

Insert:

(9)

Subclass 259: In the Class Schedule

Delete:

(11)

Insert:

(10)

Subclass 260: In the Class Schedule

Delete:

(12)

Insert:

(11)

Subclass 261: In the Class Schedule

Delete:

(13)

Insert:

(12)

Subclass 271: In the Class Schedule

Delete:

(14)

Insert:

(13)

Subclass 276: In the Class Schedule

Delete:

(15)

Insert:

(14)

Subclass 277: In the Class Schedule

Delete:

(16)

Insert:

(15)

Subclass 280.1: In the Class Schedule

Delete:

(17)

Insert:

(16)

Subclass 283: In the Class Schedule

Delete:

(18)

Insert:

(17)

Subclass 293.1: In the Class Schedule

Delete:

(17)

Insert:

(16)

Subclass 301: In the Class Schedule

Delete:

(19)

Insert:

(18)

Subclass 302: In the Class Schedule

Delete:

(20)

Insert:

(19)

Subclass 303: In the Class Schedule

Delete:

(21)

Insert:

(20)

Subclass 308: In the Class Schedule

Delete:

(22)

Insert:

(21)

Subclass 310: In the Class Schedule

Delete:

(23)

Insert:

(22)

Subclass 311: In the Class Schedule

Delete:

(24)

Insert:

(23)

Subclass 316: In the Class Schedule

Delete:

(25)

Insert:

(24)

Subclass 343: In the Class Schedule

Delete:

(26)

Insert:

(25)

Subclass 346: In the Class Schedule

Delete:

(27)

Insert:

(26)

Subclass 351: In the Class Schedule

Delete:

(28)

Insert:

(27)

Subclass 366: In the Class Schedule

Delete:

(32)

Insert:

(28)

Subclass 385: In the Class Schedule

Delete:

(25)

Insert:

(24)

In the Search Notes:

Delete:

(1)

Renumber: The remaining search notes (except 30 and 31) as follows:

- (2) renumber as (1)
- (3) renumber as (2)
- (4) renumber as (3)
- (5) renumber as (4)
- (6) renumber as (5)
- (7) renumber as (6)
- (8) renumber as (7)
- (9) renumber as (8)
- (10) renumber as (9)
- (11) renumber as (10)
- (12) renumber as (11)
- (13) renumber as (12)
- (14) renumber as (13)
- (15) renumber as (14)
- (16) renumber as (15)
- (17) renumber as (16)
- (18) renumber as (17)
- (19) renumber as (18)
- (20) renumber as (19)
- (21) renumber as (20)

- (22) renumber as (21)
- (23) renumber as (22)
- (24) renumber as (23)
- (25) renumber as (24)
- (26) renumber as (25)
- (27) renumber as (26)
- (28) renumber as (27)
- (32) renumber as (28)

List: The search notes sequentially from (1) through (31).

A. DESIGN CLASS MODIFICATIONS

Additions and Modifications to the Class Schedule

CLASS D24 – MEDICAL AND LABORATORY EQUIPMENT

Project Leader: Charles Rademaker

Under the Exclusion Notes:

Delete: All the Exclusion Notes including the heading.

In the Class Schedule:

Subclass 100: In the Class Schedule

Delete:

(2)

Subclass 101: In the Class Schedule

Delete:

(3)

Insert:

(1)

Subclass 102: In the Class Schedule

Delete:

(4)

Insert:

(2)

Subclass 105: In the Class Schedule

Delete:

(5)

Subclass 108: In the Class Schedule

Delete:

(6)

Insert:

(3)

Subclass 110: In the Class Schedule

Delete:

(7)

Insert:

(4)

Subclass 110.2: In the Class Schedule

Delete:

(71)

Insert:

(5)

Subclass 110.5: In the Class Schedule

Delete:

(72)

Insert:

(6)

Subclass 111: In the Class Schedule

Delete:

(8)

Insert:

(7)

Subclass 112: In the Class Schedule

Delete:

(9)

Insert:

(8)

Subclass 115: In the Class Schedule

Delete:

(10)

Insert:

(9)

Subclass 116: In the Class Schedule

Delete:

(11)

Insert:

(10)

Subclass 117: In the Class Schedule

Delete:

(12)

Insert:

(11)

Subclass 118: In the Class Schedule

Delete:

(13)

Insert:

(12)

Subclass 119: In the Class Schedule

Delete:

(14)

Insert:

(13)

Subclass 121: In the Class Schedule

Delete:

(15)

Insert:

(14)

Subclass 122: In the Class Schedule

Delete:

(16)

Insert:

(15)

Subclass 123: In the Class Schedule

Delete:

(17)

Insert:

(16)

Subclass 124: In the Class Schedule

Delete:

(18)

Insert:

(17)

Subclass 125: In the Class Schedule

Delete:

(19)

Insert:

(18)

Subclass 127: In the Class Schedule

Delete:

(20)

Insert:

(19)

Subclass 128: In the Class Schedule

Delete:

(21)

Insert:

(20)

Subclass 129: In the Class Schedule

Delete:

(22)

Insert:

(21)

Subclass 130: In the Class Schedule

Delete:

(23)

Insert:

(22)

Subclass 133: In the Class Schedule

Delete:

(24)

Insert:

(23)

Subclass 134: In the Class Schedule

Delete:

(25)

Insert:

(24)

Subclass 135: In the Class Schedule

Delete:

(26)

Insert:

(25)

Subclass 138: In the Class Schedule

Delete:

(27)

Insert:

(26)

Subclass 141: In the Class Schedule

Delete:

(28)

Insert:

(27)

Subclass 143: In the Class Schedule

Delete:

(29)

Insert:

(28)

Subclass 144: In the Class Schedule

Delete:

(30)

Insert:

(29)

Subclass 145: In the Class Schedule

Delete:

(31)

Insert:

(30)

Subclass 146: In the Class Schedule

Delete:

(32)

Insert:

(31)

Subclass 147: In the Class Schedule

Delete:

(33)

Insert:

(32)

Subclass 152: In the Class Schedule

Delete:

(34)

Insert:

(33)

Subclass 156: In the Class Schedule

Delete:

(35)

Insert:

(34)

Subclass 158: In the Class Schedule

Delete:

(36)

Insert:

(35)

Subclass 159: In the Class Schedule

Delete:

(37)

Insert:

(36)

Subclass 162: In the Class Schedule

Delete:

(38)

Insert:

(37)

Subclass 164: In the Class Schedule

Delete:

(39)

Insert:

(38)

Subclass 167: In the Class Schedule

Delete:

(40)

Insert:

(39)

Subclass 168: In the Class Schedule

Delete:

(41)

Insert:

(40)

Subclass 169: In the Class Schedule

Delete:

(42)

Insert:

(41)

Subclass 170: In the Class Schedule

Delete:

(43)

Insert:

(42)

Subclass 171: In the Class Schedule

Delete:

(44)

Insert:

(43)

Subclass 172: In the Class Schedule

Delete:

(45)

Insert:

(44)

Subclass 173: In the Class Schedule

Delete:

(46)

Insert:

(45)

Subclass 176: In the Class Schedule

Delete:

(47)

Insert:

(46)

Subclass 178: In the Class Schedule

Delete:

(48)

Insert:

(47)

Subclass 181: In the Class Schedule

Delete:

(49)

Insert:

(48)

Subclass 183: In the Class Schedule

Delete:

(50)

Insert:

(49)

Subclass 186: In the Class Schedule

Delete:

(51)

Insert:

(50)

Subclass 187: In the Class Schedule

Delete:

(52)

Insert:

(51)

Subclass 188: In the Class Schedule

Delete:

(53)

Insert:

(52)

Subclass 189: In the Class Schedule

Delete:

(54)

Insert:

(53)

Subclass 190: In the Class Schedule

Delete:

(55)

Insert:

(54)

Subclass 193: In the Class Schedule

Delete:

(56)

Insert:

(55)

Subclass 194: In the Class Schedule

Delete:

(57)

Insert:

(56)

Subclass 197: In the Class Schedule

Delete:

(58)

Insert:

(57)

Subclass 200: In the Class Schedule

Delete:

(59)

Insert:

(58)

Subclass 204: In the Class Schedule

Delete:

(60)

Insert:

(59)

Subclass 207: In the Class Schedule

Delete:

(61)

Insert:

(60)

Subclass 210: In the Class Schedule

Delete:

(62)

Insert:

(61)

Subclass 216: In the Class Schedule

Delete:

(63)

Insert:

(62)

Subclass 220: In the Class Schedule

Delete:

(64)

Insert:

(63)

Subclass 223: In the Class Schedule

Delete:

(65)

Insert:

(64)

Subclass 224: In the Class Schedule

Delete:

(66)

Insert:

(65)

Subclass 227: In the Class Schedule

Delete:

(67)

Insert:

(66)

Subclass 231: In the Class Schedule

Delete:

(70)

Insert:

(67)

Subclass 232: In the Class Schedule

Delete:

(68)

Subclass 234: In the Class Schedule

Delete:

(69)

Insert:

(68)

In the Search Notes:

Delete:

(1), (2), (5), (68), and (73)

Renumber: The remaining search notes as follows:

- (3) renumber as (1)
- (4) renumber as (2)
- (6) renumber as (3)
- (7) renumber as (4)
- (71) renumber as (5)
- (72) renumber as (6)
- (8) renumber as (7)
- (9) renumber as (8)
- (10) renumber as (9)
- (11) renumber as (10)
- (12) renumber as (11)
- (13) renumber as (12)
- (14) renumber as (13)
- (15) renumber as (14)

- (16) renumber as (15)
- (17) renumber as (16)
- (18) renumber as (17)
- (19) renumber as (18)
- (20) renumber as (19)
- (21) renumber as (20)
- (22) renumber as (21)
- (23) renumber as (22)
- (24) renumber as (23)
- (25) renumber as (24)
- (26) renumber as (25)
- (27) renumber as (26)
- (28) renumber as (27)
- (29) renumber as (28)
- (30) renumber as (29)
- (31) renumber as (30)
- (32) renumber as (31)
- (33) renumber as (32)
- (34) renumber as (33)
- (35) renumber as (34)
- (36) renumber as (35)
- (37) renumber as (36)
- (38) renumber as (37)
- (39) renumber as (38)
- (40) renumber as (39)
- (41) renumber as (40)
- (42) renumber as (41)
- (43) renumber as (42)

- (44) renumber as (43)
- (45) renumber as (44)
- (46) renumber as (45)
- (47) renumber as (46)
- (48) renumber as (47)
- (49) renumber as (48)
- (50) renumber as (49)
- (51) renumber as (50)
- (52) renumber as (51)
- (53) renumber as (52)
- (54) renumber as (53)
- (55) renumber as (54)
- (56) renumber as (55)
- (57) renumber as (56)
- (58) renumber as (57)
- (59) renumber as (58)
- (60) renumber as (59)
- (61) renumber as (60)
- (62) renumber as (61)
- (63) renumber as (62)
- (64) renumber as (63)
- (65) renumber as (64)
- (66) renumber as (65)
- (67) renumber as (66)
- (69) renumber as (68)
- (70) renumber as (67)

List: The search notes sequentially from (1) through (68).

A. DESIGN CLASS MODIFICATIONS

Additions and Modifications to the Class Schedule

CLASS D25 – BUILDING AND CONSTRUCTION UNITS

Project Leader: Charles Rademaker

Under the Exclusion Notes:Delete: All the Exclusion Notes including the heading.In the Class Schedule:

Subclass 1: In the Class Schedule

Delete:

(1)

Subclass 13: In the Class Schedule

Delete:

(2)

Insert:

(1)

Subclass 16: In the Class Schedule

Delete:

(3)

Insert:

(2)

Subclass 17: In the Class Schedule

Delete:

(4)

Insert:

(3)

Subclass 35: In the Class Schedule

Delete:

(5)

Subclass 36: In the Class Schedule

Delete:

(6)

Insert:

(4)

Subclass 37: In the Class Schedule

Delete:

(7)

Insert:

(5)

Subclass 38: In the Class Schedule

Delete:

(8)

Insert:

(6)

Subclass 45: In the Class Schedule

Delete:

(9)

Insert:

(7)

Subclass 47: In the Class Schedule

Delete:

(10)

Insert:

(8)

Subclass 53: In the Class Schedule

Delete:

(11)

Insert:

(9)

Subclass 55: In the Class Schedule

Delete:

(12)

Insert:

(10)

Subclass 56: In the Class Schedule

Delete:

(13)

Insert:

(11)

Subclass 58: In the Class Schedule

Delete:

(25)

Insert:

(12)

Subclass 60: In the Class Schedule

Delete:

(14)

Insert:

(13)

Subclass 61: In the Class Schedule

Delete:

(15)

Insert:

(14)

Subclass 62: In the Class Schedule

Delete:

(16)

Subclass 63: In the Class Schedule

Delete:

(17)

Insert:

(15)

Subclass 68: In the Class Schedule

Delete:

(18)

Insert:

(16)

Subclass 102: In the Class Schedule

Delete:

(19)

Subclass 106: In the Class Schedule

Delete:

(20)

Insert:

(17)

Subclass 109: In the Class Schedule

Delete:

(21)

Insert:

(18)

Subclass 111: In the Class Schedule

Delete:

(22)

Insert:

(19)

Subclass 113: In the Class Schedule

Delete:

(23)

Insert:

(20)

Subclass 114: In the Class Schedule

Delete:

(24)

Insert:

(21)

Subclass 119: In the Class Schedule

Delete:

(34)

Insert:

(22)

Subclass 136: In the Class Schedule

Delete:

(26)

Insert:

(23)

Subclass 138: In the Class Schedule

Delete:

(27)

Insert:

(24)

Subclass 145: In the Class Schedule

Delete:

(28)

Insert:

(25)

Subclass 151: In the Class Schedule

Delete:

(29)

Insert:

(26)

Subclass 152: In the Class Schedule

Delete:

(30)

Insert:

(27)

Subclass 157: In the Class Schedule

Delete:

(31)

Insert:

(28)

Subclass 164: In the Class Schedule

Delete:

(32)

Insert:

(29)

Subclass 199: In the Class Schedule

Delete:

(33)

In the Search Notes:

Delete:

(1), (5), (16), (19), and (33)

Renumber: The remaining search notes as follows:

- (2) renumber as (1)
- (3) renumber as (2)
- (4) renumber as (3)
- (6) renumber as (4)
- (7) renumber as (5)
- (8) renumber as (6)
- (9) renumber as (7)
- (10) renumber as (8)
- (11) renumber as (9)
- (12) renumber as (10)
- (13) renumber as (11)
- (14) renumber as (12)
- (15) renumber as (14)
- (17) renumber as (15)
- (18) renumber as (16)
- (20) renumber as (17)
- (21) renumber as (18)
- (22) renumber as (19)
- (23) renumber as (20)

- (24) renumber as (21)
- (25) renumber as (13)
- (26) renumber as (23)
- (27) renumber as (24)
- (28) renumber as (25)
- (29) renumber as (26)
- (30) renumber as (27)
- (31) renumber as (28)
- (32) renumber as (29)
- (34) renumber as (22)

List: The search notes sequentially from (1) through (29).

DECEMBER 2, 2003

Project No. Z-6651

C. CHANGES TO THE USPC – LOCARNO CONCORDANCE

There are no changes to the USPC – LOCARNO Concordance resulting from this project.

CLASS D19 – OFFICE SUPPLIES; ARTISTS' AND TEACHERS' MATERIALS

SECTION I – CLASS DEFINITION

This class provides for design patents claiming ornamental designs for:

1. Paper or Pasteboard for Writing or Printing
 2. Credit Card, Certificate, or Stamp
 3. Calendar or Calendar Holder
 4. Bookend
 5. Book, Album, or Cover
 6. Equipment for Writing, Drawing, or for Fine Arts
 7. Teaching Equipment
 8. Office Equipment Not Elsewhere Specified
 9. Miscellaneous
- (1) Note. Design patents in this class are classified by what is claimed and shown in full lines only. Broken, hatched, or stippled lines, which may be included in design patent drawings, are considered as environment only.

SECTION II – REFERENCES TO OTHER CLASSES

SEE OR SEARCH CLASS:

- D2, Apparel and Haberdashery, subclasses 861-864 for apron or bib.
- D3, Travel Goods and Personal Belongings, subclass 206 for pencil box or case for writing implement; subclasses 247-253 for checkbook cover.
- D4, Brushware, subclass 103 for finger cot; subclasses 127-136 for artists'-type paintbrush.
- D5, Textile or Paper Yard Goods; Sheet Material, for sheet wrapping paper; subclasses 7-19 for shelf paper.

- D6, Furnishings, subclasses 300-314 for photograph, picture frame, or easel; subclasses 407-635 for media disc holder or storage container; subclass 419 for lectern or furniture-type book reading stand; subclass 420 for drafting table; subclasses 432-490 for general purpose, enclosed file cabinet or storage furniture; subclass 449 for calling card receiver; subclass 595 for napkin; subclasses 613-616 for placemat.
- D8, Tools and Hardware, subclass 47 for chisel; subclass 48 for staple remover; subclasses 49-50 for stapler; subclasses 51-69 for pliers-type punch; subclasses 75-81 for hammer; subclass 98 for scissors; subclasses 98-105 for sculpting tool, knife, or spatula.
- D9, Packages and Containers for Goods, subclasses 516-575 for ink bottle; subclass 305-306 for packaging bag, wrapper, or envelope.
- D10, Measuring, Testing, or Signalling Instruments, subclasses 61-73 for measuring instrument; subclass 64 for geometric-type drafting template; subclass 65 for protractor, triangle, or T-square; subclasses 71-73 for rule; subclass 73 for caliper or divider.
- D14, Recording, Communication, or Information Retrieval Equipment, subclass 158 for voice synthesizer unit; subclasses 341-347 for electronic book; subclasses 435-438 for data processing cartridge, chip, or card.
- D15, Machines Not Elsewhere Specified, subclasses 127-134 for paper cutter; subclass 144.1 for kiln, crucible, or furnace.
- D16, Photography and Optical Equipment, subclasses 221-236 for film projector or viewer.
- D18, Printing and Office Machinery, subclasses 4.1-4.6 for point-of-sale terminal; subclasses 15-18 for imprinting or embossing stamp; subclasses 50-55 for printing machine or press.
- D20, Sales and Advertising Equipment, subclasses 10-44 for educational material in the form of graphics, e.g., sign, chart, etc., including bulletin board; subclass 11 for decal or transfer.
- D21, Games, Toys, and Sports Goods, subclasses 376-384 for game or gambling-type card; subclasses 468-482 for coordination or hand manipulative toy; subclasses 698-810 for training aid for sport.
- D23, Environmental Heating and Cooling; Fluid Handling and Sanitary Equipment, subclasses 223-227 for air brush.
- D24, Medical and Laboratory Equipment, subclass 175 for speech reflector.

- D27, Tobacco and Smokers' Supplies, subclass 101 for cigarette wrapper; subclass 146 for writing instrument combined with tobacco lighter; subclass 196 for pipe cleaner.
- D29, Equipment for Safety, Protection, and Rescue, subclass 114 for finger stall.

MAINLINE SUBCLASSES

- 1 PAPER OR PASTEBOARD FOR WRITING OR PRINTING:**
Design under the Class Definition for stationery or cardboard used for hand written or printed communication.

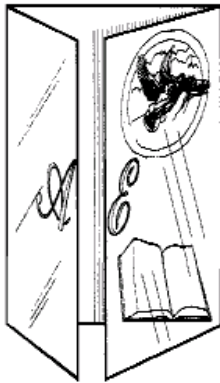

Example of a design for a card for writing.

- (1) Note. Includes carbon paper, greeting card or place card.
- (2) Note. Includes business form.
- (3) Note. Includes planar or sheet material for artwork.

SEE OR SEARCH THIS CLASS, SUBCLASS:

20-25, for calendar.

26, for book or writing tablet.

SEE OR SEARCH CLASS:

- D5, Textile or Paper Yard Goods; Sheet Material, for sheet wrapping paper; subclasses 7-19 for shelf paper; subclass 595 for napkin; subclasses 613-616 for place mat.
- D9, Packages and Containers for Goods, subclasses 305-306 for packaging, bag, wrapper or envelop.

- D20, Sales and Advertising Equipment, subclasses 10-44 for educational material in the form of graph, sign, or chart, including bulletin board; subclass 11 for decal or transfer.
- D21, Games, Toys, and Sports Goods, subclasses 376-384 for game or gambling-type card.
- D27, Tobacco and Smokers' Supplies, subclass 101 for cigarette-type paper.

- 9 CREDIT CARD, CERTIFICATE, OR STAMP:**
Design under the Class Definition for card authorizing purchases by charge or debit account, printed official forms or gummed-type seal.

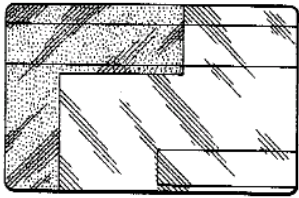

Example of a design for a credit card.

SEE OR SEARCH THIS CLASS, SUBCLASS:

20-25, for calendar or calendar holder.

26-34, for book, album or cover.

SEE OR SEARCH CLASS:

- D14, Recording, Communication, or Information Retrieval Equipment, subclass 117 for data processing record card.
- D18, Printing and Office Machinery, subclass 50-55 for imprinting or embossing stamp; subclasses 50-55 for printing machine or press.
- D20, Sales and Advertising Equipment, subclasses 10-44 for educational material in the form of graph, sign, or chart, including bulletin board; subclass 11 for decal or transfer.
- D21, Games, Toys, and Sports Goods, subclasses 376-384 for game or gambling-type card.

- 20 CALENDAR OR CALENDAR HOLDER:**
Design under the Class Definition for chart showing the day of the week, month, or year or support therefor.

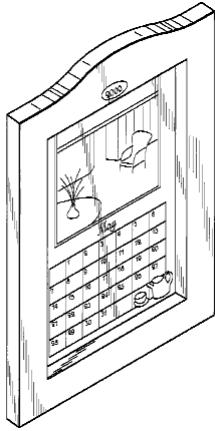

Example of a handheld design for calendar.

- 26 BOOK, ALBUM OR COVER:**
Design under the Class Definition for series of plain, written or printed sheets fastened together at one edge or binding-type surround therefor.

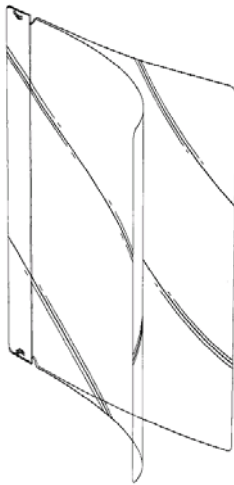

Example of a design for a cover.

- (1) Note. Includes writing tablet.

SEE OR SEARCH THIS CLASS, SUBCLASS:

- 59, for electronic dictionary or speller.

SEE OR SEARCH CLASS:

- D3, Travel Goods and Personal Belongings, subclasses 247-253 for checkbook cover.
- D6, Furnishings, subclass 419 for lectern or furniture-type book reading stand.
- D9, Packages and Containers for Goods, subclasses 305-306 for packaging bag, wrapper or envelope; D18, Printing and Office Machinery, subclasses 50-55 for imprinting or embossing stamp; subclasses 50-55 for printing machine or press.

34.1 BOOKEND:

Design under the Class Definition for support for keeping row of books upright.

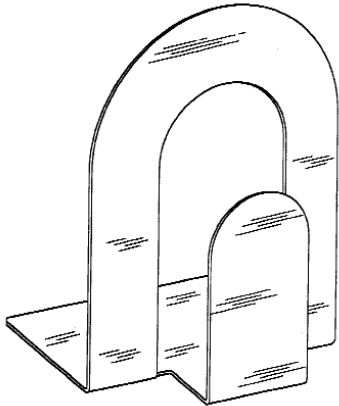

Example of a design for a bookend.

35 EQUIPMENT FOR WRITING, DRAWING, OR FOR FINE ARTS:

Design under the Class Definition for articles for written communication, sketching, or painting.

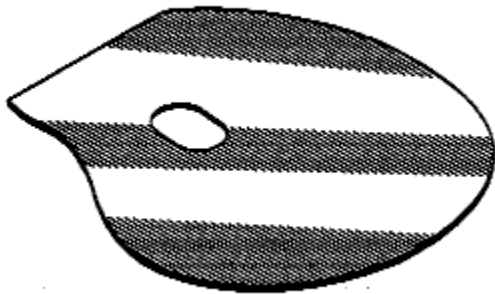

Equipment for writing, drawing, or for fine arts.

(1) Note. Includes only articles for writing, drawing, sculpting not elsewhere specified and elements therefor.

(2) Note. Includes artists' tray or palette.

SEE OR SEARCH THIS CLASS, SUBCLASS:

75-85, for holder or stand.

SEE OR SEARCH CLASS:

- D2, Apparel and Haberdashery, subclasses 861-864 for apron or bib.
- D3, Travel Goods and Personal Belongings, subclass 206 for pencil box or case for writing implement.
- D4, Brushware, subclass 103 for finger cot; subclasses 127-136 for artists'-type paintbrush.
- D6, Furnishings, subclasses 300-314 for photograph, picture frame or easel; subclasses 407-635 for media disc holder or storage container; subclass 420 for drafting table; subclasses 432-490 for general purpose, enclosed file cabinet or storage furniture; subclass 449 for calling card receiver.
- D8, Tools and Hardware, subclass 47 chisel; subclass 48 for staple remover; subclasses 49 and 50 for stapler; subclasses 51-69 for pliers-type punch; subclasses 75-81 for hammer; subclass 98 for scissors; subclasses 98-105 for sculpting tool, knife, or spatula.
- D9, Packages and Containers for Goods, subclasses 516-575 for ink bottle.
- D10, Measuring, Testing, or Signalling Instruments, subclasses 61-73 for measuring instrument; subclass 64 for geometric-type drafting template; subclass 65 for protractor, triangle, or T-square; subclasses 71-73 for rule; subclass 73 for caliper or divider.
- D15, Machines Not Elsewhere Specified, subclasses 127-134 for paper cutter; subclass 144.1 for kiln, crucible, or furnace.
- D16, Photography and Optical Equipment, subclass 221-236 for film projector or viewer.
- D18, Printing and Office Machinery, subclasses 50-55 for imprinting or embossing stamp; subclasses 50-55 for printing machine or press.
- D20, Sales and Advertising Equipment, subclass 11 for decal or transfer.

- D21, Games, Toys, and Sports Goods, subclasses 468-482 for coordination or hand manipulative toy; subclasses 698-810 for sport-type training.
- D23, Environmental Heating and Cooling; Fluid Handling and Sanitary Equipment, subclasses 223-227 for airbrush.
- D24, Medical and Laboratory Equipment, subclass 175 for speech reflector.
- D27, Tobacco and Smokers' Supplies, subclass 146 for writing instrument combined with tobacco lighter; subclass 196 for pipe cleaner.
- D29, Equipment for Safety, Protection, and Rescue, subclass 114 for fingerstall.

59 TEACHING MATERIAL:
Design under the Class Definition for articles used instruction.



Example of a design for teaching material.

- (1) Note. Includes element.
- (2) Note. Includes electronic dictionary or speller.

65 OFFICE EQUIPMENT NOT ELSEWHERE SPECIFIED:
Design under the Class Definition for general-type articles used in a business-type environment not elsewhere provided for.

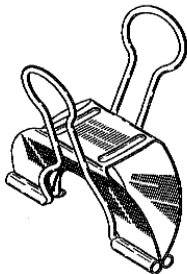

Example of a design for office equipment not elsewhere specified.

- (1) Note. Includes paper fastener or paper clip.

SEE OR SEARCH CLASS:

- D3, Travel Goods and Personal Belongings, subclass 206 for pencil box or case for writing implement.
- D4, Brushware, subclass 103 for finger cot.
- D5, Textile or Paper Yard Goods; Sheet Material, appropriate subclasses for sheet wrapping paper.
- D6, Furnishings, subclasses 300-314 for photograph, picture frame or easel; subclasses 407-635 for media disc holder or storage container; subclass 419 for lectern or furniture-type book reading stand; subclass 420 for drafting table; subclasses 432-490 for general purpose, enclosed file cabinet or storage furniture.
- D8, Tools and Hardware, subclass 48 for staple remover; subclasses 49 and 50, for stapler; subclasses 51-69 for pliers-type punch; subclass 98 for scissors.
- D9, Packages and Containers for Goods, subclasses 516-575 for ink bottle.
- D10, Measuring, Testing, or Signalling Instruments, subclasses 61-73 for measuring instrument; subclass 64 for geometric-type drafting template; subclass 65 for protractor, triangle, or T-square; subclasses 71-73 for rule; subclass 73 for caliper or divider.
- D15, Machines Not Elsewhere Specified, subclasses 127-134 for paper cutter.
- D16, Photography and Optical Equipment, subclasses 221-236 film projector or viewer.
- D18, Printing and Office Machinery, subclasses 50-55 for imprinting or embossing stamp; subclasses 50-55 for printing machine or press.
- D29, Equipment for Safety, Protection, and Rescue, subclass 114 for fingerstall.

99 MISCELLANEOUS:

Design under the Class Definition for office supplies, artists' and teachers' materials not elsewhere specified.

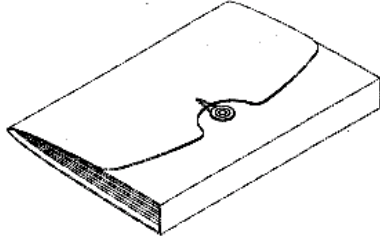

Example of a design for miscellaneous subject matter for this class.

CLASS D20 – SALES AND ADVERTISING EQUIPMENT

SECTION I – CLASS DEFINITION

This class provides for Design patents claiming ornamental Designs for:

1. Vending Machine
 2. Signs or Display Forms
 3. Miscellaneous
- (1) Note. Design patents in this class are classified by what is claimed and shown in full lines only. Broken, hatched, or stippled lines that may be included in design patent drawings is considered as environment only.

SECTION II – REFERENCES TO OTHER CLASSES

SEE OR SEARCH CLASS:

- D5, Textile or Paper Yard Goods; Sheet Material, subclasses 63-66 for cigar band.
- D6, Furnishings, subclasses 300-328 for picture frame, picture mount, or easel-type support; subclasses 396-490 for work surface, storage, merchandising, display unit racks, or holders without mechanical features.
- D7, Equipment for Preparing or Serving Food or Drink Not Elsewhere Specified, subclass 325 for popcorn making machine.
- D11, Jewelry, Symbolic Insignia, and Ornaments, subclasses 131-164 for sculpture, table, or wall ornament.
- D18, Printing and Office Machinery, subclass 3 for coin counting or coin handling machine.
- D99, Miscellaneous, subclasses 34-42 for coin holder or bank.

MAINLINE SUBCLASSES

- 1 VENDING MACHINE:**
Design under the Class Definition for coin operated apparatus that dispenses articles or goods.

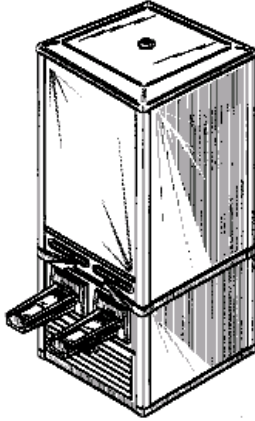

Example of a design for a vending machine.

- (1) Note. Design must be coin operated. Dispensing articles of other types are classified in different design classes.

SEE OR SEARCH CLASS:

- D6, Furnishings, subclasses 396-490 for work surface, storage, merchandising, display unit racks, or holders without mechanical features.
- D7, Equipment for Preparing or Serving Food or Drink Not Elsewhere Specified, subclass 325 for popcorn making machine.
- D18, Printing and Office Machinery, subclass 3 for coin counting or coin handling machine.
- D99, Miscellaneous, subclasses 34-42 for coin holder or bank.

10 SIGNS OR DISPLAY FORMS:

Design under the Class Definition for signboard or visual or physical representation intended to show information or articles.



Example of a design for a sign.

SEE OR SEARCH CLASS:

- D5, Textile or Paper Yard Goods; Sheet Material, subclasses 63-66 for cigar band.
- D6, Furnishings, subclasses 300-328 for picture frame, picture mount, or easel-type support.
- D11, Jewelry, Symbolic Insignia, and Ornaments, subclasses 131-164 for sculpture, table, or wall ornament.

99**MISCELLANEOUS:**

Design under the Class Definition for sales and advertising equipment not elsewhere provided for.

SEE OR SEARCH CLASS:

- D6, Furnishings, subclasses 396-490 for work surface, storage, merchandising, display unit racks, or holders without mechanical features.
- D99, Miscellaneous, subclasses 34-42 for coin holder or bank.

CLASS D22 – ARMS, PYROTECHNICS, HUNTING AND FISHING EQUIPMENT

SECTION I – CLASS DEFINITION

This class provides for design patents claiming ornamental designs for:

1. Projectile Launching Weapon
 2. Explosive of Pyrotechnic Article
 3. Target or Target Launcher
 4. Free Flight Projectile
 5. Trapping, Repelling, or Vermin Destroying
 6. Fishing Equipment
 7. Miscellaneous
- (1) Note. Design patents in this class are classified by what is claimed and shown in full lines only. Broken, hatched, or stippled lines, which may be included in design patent drawings, are considered as environment only.

SECTION II – REFERENCES TO OTHER CLASSES

SEE OR SEARCH CLASS:

- D2, Apparel and Haberdashery, subclasses 829-830 for vest.
- D3, Travel Goods and Personal Belongings, subclass 220 for scabbard or sheath for knife or sword; subclasses 221-225 for body- or belt-attached fishing rod holder or carrier; subclasses 222 and 223 for gun holster; subclass 224 for body-attached cartridge holder; subclasses 254-262 for containers and carrying cases for sports equipment; subclass 260 for fishing creel; subclasses 273-302 for enclosed storage container; Cross Reference Art Collection 904 for sports accessory case; Cross Reference Art Collection 905 for tackle box.
- D10, Measuring, Testing, or Signalling Instruments, subclass 46 for sonar; subclass 107 for buoy; subclasses 114 and 115 for flashing, warning, or directing-type light.
- D12, Transportation, subclass 16.1 for drone, guided missile, or rocket.
- D16, Photography and Optical Equipment, subclass 132 for optical or telescopic gun sight.
- D21, Games, Toys, and Sports Goods, subclasses 302-309 for game-type target (e.g., toy marksman type, dart board, etc.); subclasses 567-575 for toy weapon; subclass 568 for toy sword; subclass 571 for toy bow or crossbow; subclasses 573-575 for toy handgun or rifle; subclasses 834-840 for tent.

D25, Building Units and Construction Elements, subclass 16 for single occupant-type hunting blind.

SUBCLASSES

100 PROJECTILE LAUNCHING WEAPON:
Design under the Class Definition for article used to propel an object of bodily harm.

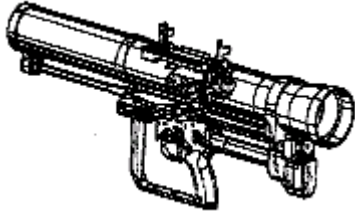

Example of a design for a projectile launching weapon.

(1) Note. Includes firearm, slingshot, bow, or spear.

SEE OR SEARCH THIS CLASS, SUBCLASS:

113, for target launcher.

SEE OR SEARCH CLASS:

D21, Games, Toys, and Sports Goods, subclasses 567-575 for toy weapon; subclass 568 for toy sword; subclasses 573-575 for toy handgun or rifle.

101 Combined:
Design under subclass 100 that includes the disclosure of another design which, if claimed separately, would be classified in a subsequent subclass or class.

102 Spear gun or blow gun:
Design under subclass 100 for a device for mechanically shooting a spear-like projectile underwater or by expelling a projectile with a gust of air from the mouth.



Example of a design for a blowgun.

SEE OR SEARCH CLASS:

D21, Games, Toys, and Sports Goods, subclass 387 for dart; subclasses 401 and 402 for bubble or smoke making toy; subclasses 567-575 for toy weapon.

103 Rifle or shotgun:

Design under subclass 100 for a firearm with an elongated bore for firing from the shoulder.

SEE OR SEARCH CLASS:

D21, Games, Toys, and Sports Goods, subclass 573 for toy rifle.

104 Pistol:

Design under subclass 100 for handheld firearm that includes a bore.



Example of a handheld design for a pistol.

105 Simulative motif:
Design under subclass 104 that includes an ornamental feature or features that shows the ornamental appearance of another article as applied ornamentation.

106 Slingshot:
Design under subclass 100 for a Y-shaped stick having an elastic strap attached to the prongs used for flinging small stones:

(1) Note. Includes element.

107 Bow:
Design under subclass 100 for a weapon consisting of a curved flexible strip of material, strung taut from end to end used to launch arrows.

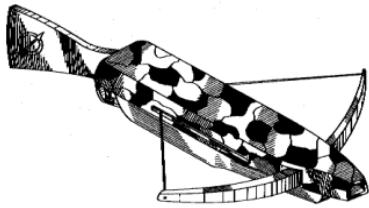

Example of a design for a crossbow.

(1) Note. Includes element.

SEE OR SEARCH CLASS:

D21, Games, Toys, and Sports Goods, subclass 571 for toy bow or crossbow.

108 Firearm element or attachment:
Design under subclass 100 for a part or accessory for a pistol or rifle, capable of firing a projectile using an explosive charge as a propellant.

109 Gunsight, ventilating rib, or mount:
Design under subclass 108 for mechanism for aiming a firearm or support therefor or mechanism for circulating air into a firearm.

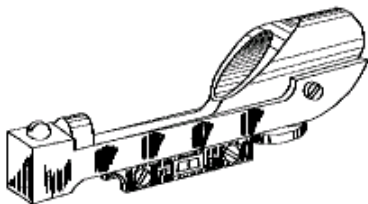

Example of a design for a gunsight.

SEE OR SEARCH CLASS:

D16, Photography and Optical Equipment, subclass 132 for optical or telescopic gun sight.

110 Gunsight mount:

Design under subclass 109 for support for aiming mechanism for hand firearm such as a pistol, gun, or rifle.

SEE OR SEARCH CLASS:

D16, Photography and Optical Equipment, subclass 132 for optical or telescopic gun sight.

111 Recoil pad:

Design under subclass 108 for end cap of a rifle that fits against the shoulder or upper body.

112 EXPLOSIVE OR PYROTECHNIC ARTICLE:

Design under the Class Definition for article that violently bursts or article of fireworks.

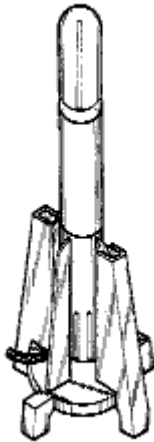

Example of a design for a pyrotechnic article.

SEE OR SEARCH CLASS:

D3, Travel Goods and Personal Belongings, subclass 224 for body attached cartridge holder.

113 TARGET OR TARGET LAUNCHER:

Design under the Class Definition for object or mark one tries to hit by shooting or propelling another article.

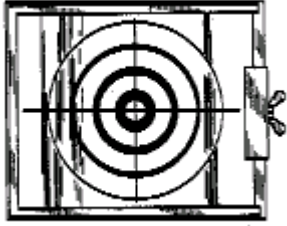

Example of a design for a pyrotechnic article.

(1) Note. Includes clay pigeon and launcher.

SEE OR SEARCH CLASS:

D21, Games, Toys, and Sports Goods, subclasses 302-309 for game-type target, e.g., toy marksman type, dart board, etc.

114 Aerial or disc type:

Design under subclass 113 for trap shooting target, e.g., clay pigeon, etc.

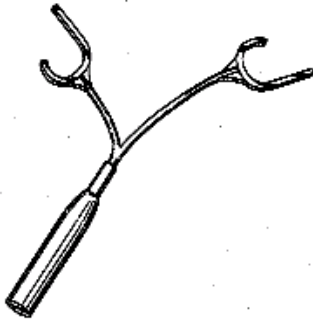

Example of a design for an aerial disc launcher.

SEE OR SEARCH CLASS:

D21, Games, Toys, and Sports Goods, subclasses 302-309 for game-type target, e.g., toy marksman type, dart board, etc.

115 FREE FLIGHT PROJECTILE:

Design under the Class Definition for object of bodily harm projected with force.

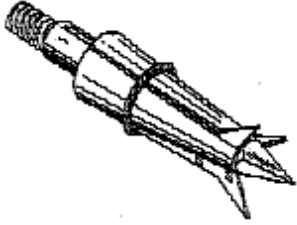

Example of a design for a free flight projectile.

- (1) Note. Includes element.

SEE OR SEARCH CLASS:

D3, Travel Goods and Personal Belongings, subclass 224, body attached cartridge holder.

D21, Games, Toys, and Sports Goods, subclass 387 for dart; subclasses 436-454 for aerial toy.

116 Pellet or bullet:

Design under subclass 115 for firearm projectile or cartridge.

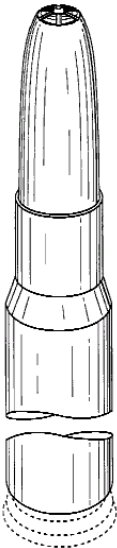

Example of a design for a bullet.

117 HAND HELD WEAPON:

Design under the Class Definition for hand held object of intentional bodily harm not otherwise provided for.

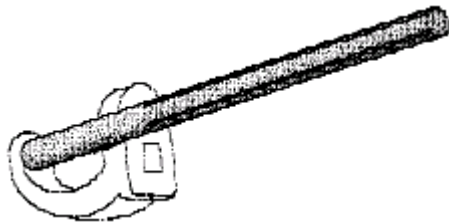

Example of a design for a hand held weapon.

(1) **Note.** Projectile launched weapon excluded.

SEE OR SEARCH THIS CLASS, SUBCLASS:

102, for spear or blow gun.

103, for rifle, shotgun, or pistol.

106, for slingshot.

107, for bow.

SEE OR SEARCH CLASS:

D3, Travel Goods and Personal Belongings, subclass 220 for scabbard or sheath for knife or sword; subclasses 221-225 for body or belt attached fishing rod holder or carrier; subclasses 222 and 223 for gun holster.

D21, Games, Toys, and Sports Goods, subclasses 302-309 for target for game; subclasses 567-575 for toy weapon; subclass 568 for toy sword; subclasses 573-575 for toy handgun or rifle.

118 Sword or knife:

Design under subclass 117 for elongated cutting blade or knife.



Example of a design for a knife.

SEE OR SEARCH THIS CLASS, SUBCLASS:

149, for fisherman's tool.

SEE OR SEARCH CLASS:

D7, Equipment for Preparing or Serving Food or Drink Not Elsewhere Specified, subclasses 649-652 for knife or blade.

D8, Tools and Hardware, subclass 99 for folding or sliding blade.

D21, Games, Toys, and Sports Goods, subclass 568 for toy sword.

119 TRAPPING, REPELLING, OR VERMIN DESTROYING:

Design under the Class Definition for article or device to catch or hold, revolt, or do bodily harm to animal or pest.

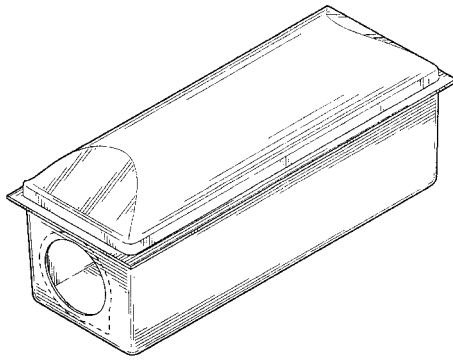

Example of a design for an animal trap.

(1) Note. Element included.

SEE OR SEARCH THIS CLASS, SUBCLASS:

135, for fish scoop or net.

120 Repeller:

Design under subclass 119 for warding or keeping insects away.

(1) Note. Includes ultrasonic and chemical type.

121 Marine life:

Design under subclass 119 directed to fish or water dwelling animals.

122 Insect type:
Design under subclass 119 directed to small arthropod animals characterized by three pairs of legs and a segmented body with or without wings.

(1) Note. Includes fly, cricket, mosquito, beetle, etc.

123 Electrocuting:
Design under subclass 122 directed to use of electricity as means of destruction.

124 Fly swatter:
Design under subclass 122 for implement used to kill insect consisting of a long handle with an attached member for crushing or smashing insect.



Example of a design for a fly swatter.

125 Lure:
Design under subclass 119 for decoy used to bait or attract animals.



Example of a design for a decoy-type lure.

(1) Note. Includes decoy.

126 Fishing:
Design under subclass 125 for marine animals.

127 Wormlike:
Design under subclass 126 with the appearance of a worm or long flexible rounded body without significant appendages.

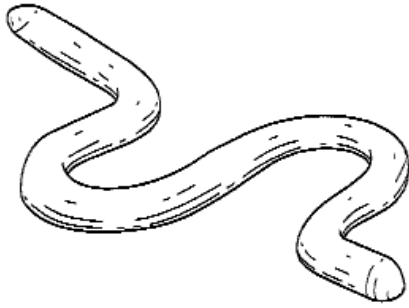

Example of a design for a worm-type lure.

- 128 With fibrous or featherlike appendage:**
Design under subclass 126 with filament- or plume-type appendage.
- 129 Spoon or spinner:**
Design under subclass 126 with flat, oval, or rotating member.
- 130 Simulative:**
Design under subclass 129 that includes an ornamental feature or features that show the ornamental appearance of another article either as applied ornamentation or form.
- 131 Fish:**
Design under subclass 130 that simulates the appearance of a cold-blooded aquatic vertebrate characteristically having fins, gills, and a streamlined body.

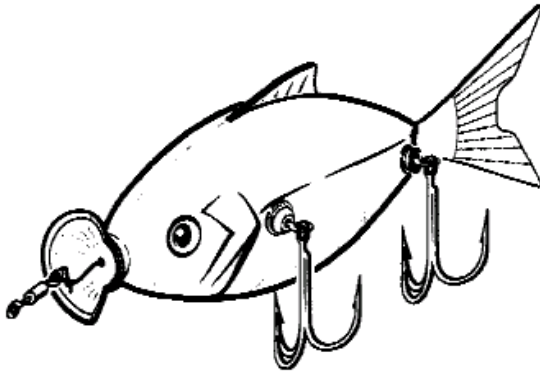

Example of a design for a fish-shaped lure.

- 132 Simulative:**
Design under subclass 126 that includes an ornamental feature or features that show the ornamental appearance of another article either as applied ornamentation or form.
- 133 Fish:**
Design under subclass 132 that simulates the appearance of a cold-blooded aquatic vertebrate characteristically having fins, gills, and a streamlined body.

134 FISHING EQUIPMENT:

Design under the Class Definition for equipment to lure or ensnare fish or cold-blooded animal living wholly in water.

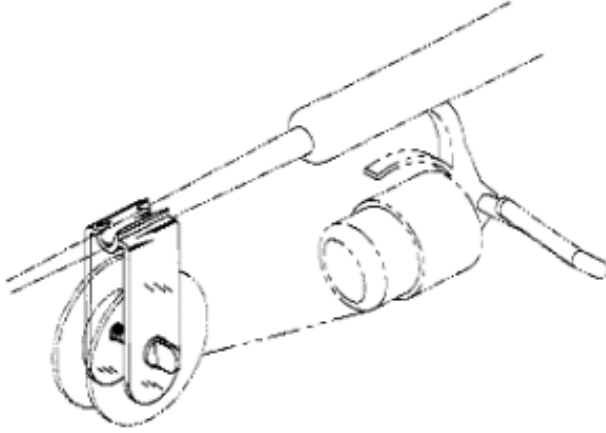

Example of a design for a fishing equipment.

(1) Note. Element included.

SEE OR SEARCH THIS CLASS, SUBCLASS:

135, for fish scoop or net.

SEE OR SEARCH CLASS:

D2, Apparel and Haberdashery, subclasses 829 and 830 for vest.

D3, Travel Goods and Personal Belongings, subclasses 221-225 for body or belt attached fishing rod holder or carrier; subclass 254-262 for containers and carrying cases for sports equipment; subclass 260 for fishing creel; subclasses 273-302 for enclosed storage container; Cross Reference Art Collection 904 for sports accessory case; Cross Reference Art Collection 905 for tackle box.

D10, Measuring, Testing, or Signalling Instruments, subclass 46 for sonar; subclass 107 for buoy; subclasses 114 and 115 for flashing, warning, or directing-type light.

D12, Transportation, subclasses 300-318 for watercraft.

D21, Games, Toys, and Sports Goods, subclasses 834-840 for tent.

D25, Building Units and Construction Elements, subclass 16 for single occupant-type hunting blind.

135 Net or scoop:

Design under subclass 134 for shovel-type tool or open-weave filament for lifting fish from the water.

136 Bait bucket or container:

Design under subclass 134 for pail or vessel for holding food or lure to entice fish.



Example of a design for a bait basket.

SEE OR SEARCH CLASS:

D32, Washing, Cleaning, or Drying Machine, subclasses 53 and 53.1 for bucket or paint bucket.

137 Rod or reel:

Design under subclass 134 for thin straight piece or bar of material used for fishing or a device to wind fishing line or cord.

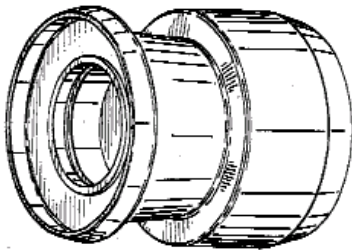

Example of a design for a fishing reel.

138 Combined:

Design under subclass 137 that includes the disclosure of another design.

- 139 With diverse article:**
Design under subclass 138 that includes the disclosure of another design which, if claimed separately, would be classified in a subsequent subclass or class.
- 140 Crank operated reel:**
Design under subclass 137 for cord winding device that includes a handle for transmitting rotary motion.

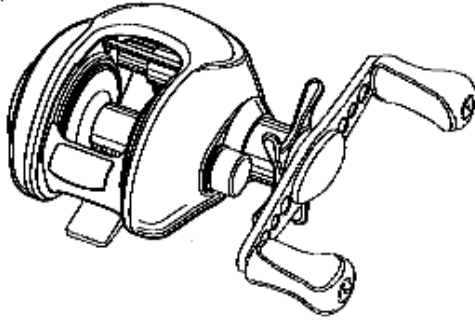

Example of a design for a crank operated fishing reel.

- 141 Reel rotates perpendicular to rod:**
Design under subclass 140 for cord winding device that winds at a right angle to the thin bar member.
- 142 Rod:**
Design under subclass 137 for thin, straight piece or bar of material used for fishing.
- (1) Note. Includes reel support or handle and rod tip.
- (2) Note. Includes element.
- 143 Line guide:**
Design under subclass 137 for fishing cord support or spacer.
- 144 Fishhook or guard:**
Design under subclass 134 for a curved or sharply bended wire member with a sharply pointed end or protective cover therefor.

- 145 Sinker:**
Design under subclass 134 for small weight used in fishing.

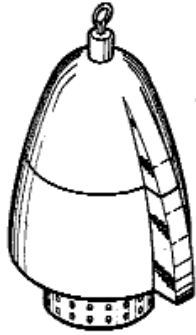

Example of a design for a fishing sinker.

- 146 Float:**
Design under subclass 134 for marking placement or for preventing fishing line and bait from sinking.

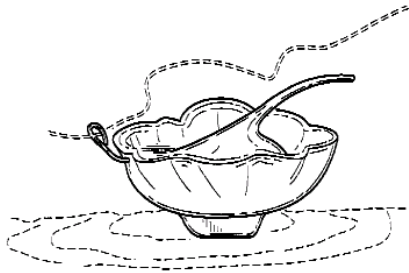

Example of a design for a fishing float.

- 147 Fishing rod holder:**
Design under subclass 134 for supporting bar-type equipment used to fish.
- 148 Combined with diverse article:**
Design under subclass 147 that includes the disclosure of another design which, if claimed separately, would be classified in a subsequent subclass or class.

149 Fisherman's tool:

Design under subclass 134 for facilitating manual work specific to the sport of fishing.

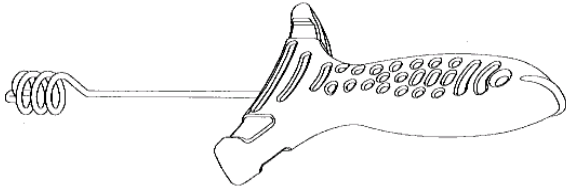

Example of a design for a fisherman's tool.

150 Relatively movable plural handles:

Design under subclass 149 that includes handle members that pivot.

SEE OR SEARCH CLASS:

D8, Tools and Hardware, subclasses 52-58 for tools with jaws activated by movable plural handles, e.g., pliers, etc.

199 MISCELLANEOUS:

Design under the Class Definition for article directed to arms, pyrotechnics, hunting, and fishing equipment not elsewhere provided for.

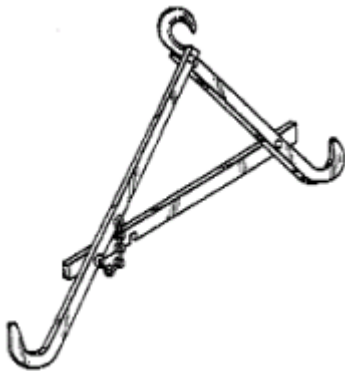

Example of a design for miscellaneous subject matter for this class.

Class D23 – ENVIRONMENTAL HEATING AND COOLING; FLUID HANDLING AND
SANITARY EQUIPMENT

SECTION I – CLASS DEFINITION

This class provides for design patents claiming ornamental designs for:

1. Fluid Handling or Treatment Equipment
 2. Sanitary Fixture or Housing Therefor
 3. Heating or Cooling
 4. Miscellaneous
- (1) Note. Design patents in this class are classified by what is claimed and shown in full lines only. Broken, hatched, or stippled lines, which may be included in design patent drawings, are considered as environment only.

SECTION II – REFERENCES TO OTHER CLASSES

SEE OR SEARCH CLASS:

- D6, Furnishings, subclass 382 for baby dressing table combined with bathing unit; subclasses 432-490 for sink cabinet or “vanity,” per se; subclasses 524-551 for miscellaneous bathroom accessories e.g., holders, racks, shelves, etc.; subclasses 542-545 for nozzle for soap dispenser.
- D7, Equipment for Preparing or Serving Food or Drink Not Elsewhere Specified, subclass 304 for drinking fountain; subclass 324 for solar oven or solar operated food heater; subclasses 397-401 for nozzle for soda fountain or beverage dispenser; subclasses 416 and 417 for fire starter or igniter.
- D8, Tools and Hardware, subclass 1 for root feeder; subclass 10 for fireplace shovel; subclass 14 for fireplace poker; subclass 29.1 for heat gun; subclass 29.2 for defrosting tool; subclass 30 for soldering gun; subclasses 51-70 for fireplace tongs; subclass 307 for seat lifter; subclasses 315-320 for safety grab bar attachment for toilet, tub, etc.
- D9, Packages and Containers for Goods, subclasses 300, 301, and 448 for pump dispenser for disposable package; subclasses 523-528 for fuel carrying can.
- D10, Measuring, Testing, or Signalling Instruments, subclasses 49-51 for pressure regulating instrument.
- D11, Jewelry, Symbolic Insignia, and Ornaments, subclass 131.1 for incense burner.

- D12, Transportation, subclasses 197-201 for caps for automobile gas tanks or radiators; subclass 606 for tire valve or valve stem; subclass 607 for valve cap for tire.
- D13, Equipment for Production, Distribution, or Transformation of Energy, subclass 100 for solid fuel; subclass 102 for solar energy converter.
- D15, Machines Not Elsewhere Specified, subclasses 7-9.3 for pump or fuel supply unit or casing for oil burner; subclass 13 for mobile agricultural sprayer or material distributor; subclasses 144-144.2 for heating devices for laboratory, industrial, or scientific use.
- D21, Games, Toys, and Sports Goods, subclass 524 for toy sink.
- D24, Medical and Laboratory Equipment, subclass 110 for medical treatment vaporizer or inhaler; subclass 110.5 for valve or regulator for underwater breathing apparatus; subclass 110.6 for scuba-type regulator; subclass 123 for medical collection basin or bedpan; subclasses 201-205 for hydrotherapy unit.
- D25, Building Units and Construction Elements, subclass 52 for skylight.
- D28, Cosmetic Products and Toilet Articles, subclasses 12-19 for hair dryer; subclass 38 for hair curling iron; subclass 54.1 for electric hand or face drier.
- D29, Equipment for Safety, Protection, and Rescue, subclasses 125-130 for fire extinguisher.
- D32, Washing, Cleaning, or Drying Machines, subclasses 15-24 for water pressure cleaner or sweeper.
- D34, Material or Article Handling Equipment, subclass 1.1 for incinerator.

MAINLINE SUBCLASSES

- 200 FLUID HANDLING OR TREATMENT:**
Design under the Class Definition for control the flow or to process liquids or fluid-type materials.

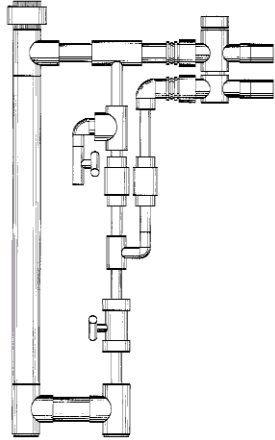

Example of a design for fluid handling means.

SEE OR SEARCH THIS CLASS, SUBCLASS:

270-313, for sanitary fixture such as tub, shower, and sink.

SEE OR SEARCH CLASS:

- D6, Furnishings, subclass 382 for baby dressing table combined with bathing unit; subclasses 432-490 for sink cabinet or "vanity," per se; subclasses 542-545 for nozzle for soap dispenser.
- D7, Equipment for Preparing or Serving Food or Drink Not Elsewhere Specified, subclasses 397-401 for nozzle for soda fountain or beverage dispenser.
- D8, Tools and Hardware, subclass 1 for root feeder.
- D9, Packages and Containers for Goods, subclasses 300, 301, and 448 for pump dispenser for disposable package; subclasses 523-528 for fuel carrying can.
- D10, Measuring, Testing, or Signalling Instruments, subclasses 49-51 for pressure regulating instrument.
- D12, Transportation, subclasses 197-201 for caps for automobile gas tanks or radiators.
- D13, Equipment for Production, Distribution, or Transformation of Energy, subclass 100 for solid fuel; subclass 102 for solar energy converter.
- D15, Machines Not Elsewhere Specified, subclasses 7-9.3 for pump or fuel supply unit or casing for oil burner; subclass 13 for mobile agricultural sprayer or material distributor.

- D21, Games, Toys, and Sports Goods, subclass 524 for toy sink.
- D24, Medical and Laboratory Equipment, subclass 110 for medical treatment vaporizer or inhaler; subclass 110.5 for valve or regulator for underwater breathing apparatus; subclass 110.6 for scuba-type regulator; subclasses 201-205 for hydrotherapy unit.
- D29, Equipment for Safety, Protection, and Rescue, subclasses 125-130 for fire extinguisher.
- D32, Washing, Cleaning, or Drying Machines, subclasses 15-24 for water pressure cleaner or sweeper.

- 270 SANITARY FIXTURE OR HOUSING THEREFOR:**
Design under the Class Definition for the efficient control of sewage or enclosure therefor.



Example of a design for a sanitary fixture.

SEE OR SEARCH CLASS:

- D6, Furnishings, subclass 382 for baby dressing table combined with bathing unit; subclasses 432-490 for sink cabinet or "vanity," per se.
- D8, Tools and Hardware, subclass 307 for seat lifter; subclasses 315-320 for safety grab bar attachment for toilet, tub, etc.
- D21, Games, Toys, and Sports Goods, subclass 524 for toy sink.
- D24, Medical and Laboratory Equipment, subclass 123 for medical collection basin or bedpan; subclasses 201-205 for hydrotherapy unit.

- 314 HEATING OR COOLING:**
Design under the Class Definition for heater, furnace, or air conditioning equipment.

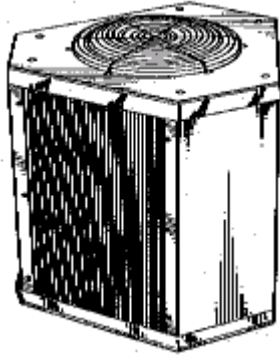

Example of a design for heating equipment.

SEE OR SEARCH CLASS:

- D7, Equipment for Preparing or Serving Food or Drink Not Elsewhere Specified, subclass 324 for solar oven or solar operated food heater; subclasses 416 and 417 for fire starter or igniter.
- D8, Tools and Hardware, subclass 29.1 for heat gun; subclass 29.2 for defrosting tool; subclass 30 for soldering gun.
- D11, Jewelry, Symbolic Insignia, and Ornaments, subclass 131.1 for incense burner.
- D13, Equipment for Production, Distribution, or Transformation of Energy, subclass 100 for solid fuel; subclass 102 for solar energy converter.
- D15, Machines Not Elsewhere Specified, subclasses 7-9.3 for pump or fuel supply unit or casing for oil burner; subclasses 144-144.2 for heating devices for laboratory, industrial, or scientific use.
- D21, Games, Toys, and Sports Goods, subclass 524 for toy stove.
- D24, Medical and Laboratory Equipment, subclasses 201-205 for hydrotherapy unit.
- D28, Cosmetic Products and Toilet Articles, subclasses 12-19 for hair dryer; subclass 38 for hair curling iron; subclass 54.1 for electric hand or face drier.
- D29, Equipment for Safety, Protection, and Rescue, subclasses 125-130 for fire extinguisher.
- D34, Material or Article Handling Equipment, subclass 1.1 for incinerator.

499 MISCELLANEOUS:

Design under the Class Definition for environmental heating and cooling, fluid handling and sanitary equipment not elsewhere provided for.

Class D24 – MEDICAL AND LABORATORY EQUIPMENT

SECTION I – CLASS DEFINITION

This class provides for design patents claiming ornamental designs for:

1. Pharmaceutical Product
2. Prophylactic Article
3. Equipment for Diagnosis, Analysis or Treatment
4. Laboratory Equipment not Elsewhere Specified

- (1) Note: Design patents in this class are classified by what is claimed and shown in full or broken lines.

SECTION II – REFERENCES TO OTHER CLASSES

SEE OR SEARCH CLASS:

- D1, Edible Products, subclass 100 for animal salt lick.
- D2, Apparel and Haberdashery, subclass 711 for athletic supporter or cup; subclass 720 for hospital patient gown; subclass 860 for surgical gown; subclasses 919-922 for patient-type slipper or footwear.
- D3, Travel Goods and Personal Belongings, subclasses 7-9 for cane or crutch; subclass 203 for carrier or storage container for medical equipment; subclass 264 for chemical contact lens sterilizing or storage unit; subclasses 265 and 266 for eyeglass carrier, holder, or storage container.
- D4, Brushware, subclasses 104-113 for toothbrush.
- D6, Furnishings, subclasses 334-381 for dentist's chair; subclasses 406.1 and 406.2 for hospital-type, over-bed tray; subclasses 432-490 for general purpose, enclosed cabinet or storage furniture; subclasses 515-523 for sequential dispenser for adhesive bandages, medicaments, suture supplies, etc.; subclass 602 for surgical drape or bed sheet.
- D7, Equipment for Preparing or Serving Food or Drink Not Elsewhere Specified, subclass 700 for household-type funnel; subclasses 701-708 for nursing or baby bottle rack.
- D9, Packages and Containers for Goods, appropriate subclasses for disposable package or container.

- D10, Measuring, Testing or Signaling Instruments, subclass 47 for radiation detection equipment; subclasses 57 and 58 for thermometer; subclass 81 for measuring instrument, including spectrometer.
- D12, Transportation, subclasses 128-133 for perambulator, invalid chair, or stretcher.
- D14, Recording, Communication, or Information Retrieval Equipment, subclass 155 for radio transmitter for transmitting cardiac data; subclass 358 for computer peripheral transmitter; subclass 482 for photographic transparency or film mount.
- D15, Machines Not Elsewhere Specified, subclass 144.1 for kiln, crucible, scientific, laboratory, or heating equipment.
- D16, Photography and Optical Equipment, subclasses 221-236 for film projector or viewer; subclasses 246-250 for film processing equipment; subclasses 303, 311, and 312 for goggles.
- D19, Office Supplies: Artists' and Teachers' Materials, subclasses 67-69 for bandage tape dispenser.
- D21, Games, Toys, and Sports Goods, subclasses 662-697 for physical conditioning or exercising equipment; subclass 669 for treadmill; subclasses 680-683 for exercise weight (e.g., dumbbell, barbell, etc.).
- D23, Environmental Heating and Cooling; Fluid Handling and Sanitary Equipment, subclass 200 for general purpose-type funnel; subclass 207 for water distillation unit; subclass 266 for generic tubing for fluids; subclasses 284-301 for surgical scrub basin; subclasses 355-358 for environmental humidifier or vaporizer; subclass 364 for ion generator; subclass 365 for air filter.
- D26, Lighting, subclasses 24-112 for surgical lighting.
- D28, Cosmetic Products and Toilet Articles, subclasses 65-68 for toothpick or dental floss holder; subclass 91.2 for back scratcher.
- D29, Equipment For Safety, Protection, and Rescue, subclasses 102-108 for head or face protector; subclass 108 for protective mouthpiece.
- D99, Miscellaneous, subclasses 1-7 for burial casket or body recovery container.

MAINLINE SUBCLASSES:

- 100 PHARMACEUTICAL PRODUCT:**
Design under the Class Definition for medicinal drugs.

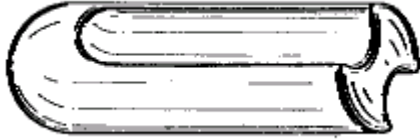

Example of a design for a pharmaceutical product.

- (1) Note. Includes veterinary medicines.

SEE OR SEARCH THIS CLASS, SUBCLASS:

117, for ampule.

189, for transdermal patch.

224, for storage vessel.

227-230, for tray or holder.

SEE OR SEARCH CLASS:

D1, Edible Products, subclass 100 for animal salt lick.

D3, Travel Goods and Personal Belongings, subclass 203 for carrier or storage container for medical equipment.

105 PROPHYLACTIC ARTICLE:

Design under the Class Definition for object for the prevention of disease.

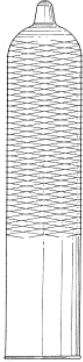

Example of a design for a prophylactic article.

(1) Note. Includes contraceptive article.

SEE OR SEARCH THIS CLASS, SUBCLASS:

141, for instrument for body cavity insertion.

190-192, for body attached restraint support or guard

SEE OR SEARCH CLASS:

D9, Packages and Containers for Goods, for disposable package or container.

D23, Environmental Heating and Cooling; Fluid Handling and Sanitary Equipment, subclasses 355-358 for environmental humidifier or vaporizer; subclass 364 for ion generator; subclass 365 for air filter.

D29, Equipment for Safety, Protection, and Rescue, subclasses 102-108 for head or face protector.

107 EQUIPMENT FOR DIAGNOSIS, ANALYSIS, OR TREATMENT:

Design under the Class Definition for articles used to determine, analyze, relieve, or cure disease.

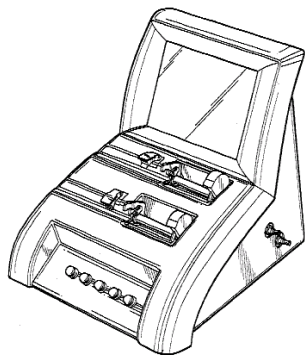

Example of a design for medical analysis or treatment.

SEE OR SEARCH THIS CLASS, SUBCLASS:

106, for ear plug or nose clip.

174, for hearing aid.

SEARCH CLASS:

- D2, Apparel and Haberdashery, subclass 711 for athletic supporter or cup; subclass 720 for hospital patient gown; subclass 860 for surgical gown; subclasses 919-922 for patient-type slipper or footwear.
- D3, Travel Goods and Personal Belongings, subclass 7-9 for cane or crutch; subclass 264 for chemical contact lens sterilizing or storage unit.
- D4, Brushware, subclasses 104-113 for toothbrush.
- D6, Furnishings, subclasses 334-381 for dentist's chair; subclasses 406.1 and 406.2 for hospital-type, over-bed tray; subclasses 515-523 for sequential dispenser for adhesive bandages, medicaments, suture supplies, etc.; subclass 602 for surgical drape or bed sheet.
- D7, Equipment for Preparing or Serving Food or Drink Not Elsewhere Specified, subclass 700 for household-type funnel.
- D9, Packages and Containers for Goods, appropriate subclasses for disposable package or container.
- D10, Measuring, Testing, or Signalling Instruments, subclass 47 for radiation detection equipment; subclasses 57 and 58 for thermometer; subclass 81 for measuring instrument, including spectrometer.
- D12, Transportation, subclasses 128-133 for perambulator, invalid chair, or stretcher.

- D14, Recording, Communication, or Information Retrieval Equipment, subclass 155 for radio transmitter for transmitting cardiac data; subclass 482 for photographic transparency or film mount.
- D15, Machines Not Elsewhere Specified, subclass 144.1 for kiln, crucible, scientific, laboratory, or heating equipment
- D16, Photography and Optical Equipment, subclasses 221-236 for film projector or viewer; subclasses 246-250 for film processing equipment; subclasses 303, 311 and 312 for goggles.
- D19, Office Supplies: Artists' and Teachers' Materials, subclasses 67-69 for bandage tape dispenser.
- D21, Games, Toys, and Sports Goods, subclass 529 for toy medical device; subclasses 662-697 for physical conditioning or exercising equipment; subclass 669 for treadmill; subclasses 680-683 for exercise weight (e.g., dumbbell, barbell, etc.).
- D23, Environmental Heating and Cooling; Fluid Handling and Sanitary Equipment, subclass 200 for general purpose-type funnel; subclass 266 for generic tubing for fluids; subclasses 284-301 for surgical scrub basin; subclasses 355-358 for environmental humidifier or vaporizer; subclass 365 for air filter.
- D26, Lighting, subclasses 24-112 for surgical lighting.
- D28, Cosmetic Products and Toilet Articles, subclasses 65-68 for toothpick or dental floss holder; subclass 91.2 for back scratcher.
- D29, Equipment for Safety, Protection, and Rescue, subclass 108 for protective mouthpiece.
- D99, Miscellaneous, subclasses 1-7 for burial casket or body recovery container.
- 232 LABORATORY EQUIPMENT NOT ELSEWHERE SPECIFIED:**
Design under the Class Definition for articles for medical or scientific experiments not elsewhere provided for.

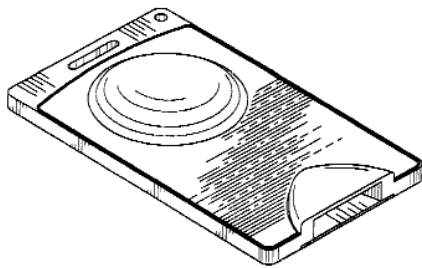

Example of a design for laboratory equipment.

- (1) Note. Includes clean air work station.

SEE OR SEARCH CLASS:

- D6, Furnishings, for general purpose, enclosed cabinet or storage furniture; subclasses 515-523 for sequential dispenser for adhesive bandages, medicaments, suture supplies, etc.
- D7, Equipment for Preparing or Serving Food or Drink Not Elsewhere, subclass 700 for household-type funnel.
- D10, Measuring, Testing, or Signalling Instruments, subclass 47 for radiation detection equipment; subclasses 57 and 58 for thermometer; subclass 81 for measuring instrument, including spectrometer.
- D14, Recording, Communication, or Information Retrieval Equipment, subclass 155 for radio transmitter for transmitting cardiac data; subclass 482 for photographic transparency or film mount.
- D15, Machines Not Elsewhere Specified, subclass 144.1 for kiln, crucible, or scientific, laboratory, or heating equipment.
- D16, Photography and Optical Equipment, subclasses 221-236 for film projector or viewer; subclasses 246-250 for film processing equipment.
- D21, Games, Toys, and Sports Goods, subclass 529 for toy medical device; subclasses 662-697 for physical conditioning or exercising equipment; subclass 669 for treadmill.
- D23, Environmental Heating and Cooling; Fluid Handling and Sanitary Equipment, subclass 200 for general purpose funnel; subclass 207 for water distillation unit; subclass 266 for generic tubing for fluids; subclasses 284-301 for surgical scrub basin; subclasses 355-358 for environmental humidifier or vaporizer; subclass 364 for ion generator; subclass 365 for air filter.

Class D25 – BUILDING UNITS AND CONSTRUCTION ELEMENTS

SECTION I – CLASS DEFINITION

This class provides for design patents claiming ornamental designs for:

1. Structure
 2. Prefabricated Unit
 3. Stair, Ladder, Scaffold or Similar Support
 4. Trellis of Treillage Unit
 5. Architectural Stock Material
 6. Miscellaneous
- (1) Note. Design patents in this class are classified by what is claimed and shown in full lines only. Broken, hatched, or stippled lines, which may be included in design patent drawings, are considered as environment only.

SECTION II – REFERENCES TO OTHER CLASSES

SEE OR SEARCH CLASS:

- D5, Textile or Paper Yard Goods, Sheet Material, appropriate subclasses for cloth, textile, or wallpaper.
- D6, Furnishings, subclasses 421 and 553-574 for structure that encloses telephone only; subclasses 582-594 for linoleum-type floor rug or tiles assembled into floor or wall covering.
- D8, Tools and Hardware, for fence or railing hardware; subclass 1 for plant stake; subclasses 323-329 for gate hinge; subclass 331-335 for gate latch; subclass 377 for track for sliding doors; subclass 384 for concrete wall tie.
- D11, Jewelry, Symbolic Insignia, and Ornaments, subclasses 143-163 for form or flower arrangement.
- D12, Transportation, subclasses 101-106 for mobile home or trailer; subclass 203 for step place for vehicle; subclass 325 for space habitat.
- D14, Recording, Communication, or Information Retrieval Equipment, subclass 219 for grille for audio or video equipment.

- D21, Games, Toys, and Sports Goods, subclasses 484-504 for toy construction building blocks; subclasses 506-511 for toy building; subclass 802 for diving board; subclasses 815 and 816 for portable swimming or wading pool; subclasses 834-838 for tent.
- D23, Environmental Heating and Cooling; Fluid Handling and Sanitary Equipment, subclass 266 for pipe, tubing, or hose; subclass 267 for roof-type gutter; subclass 308 for tiles assembled into countertop; subclass 404 for fireplace mantel.
- D26, Lighting, subclass 68 for lamp combined with post; subclasses 120-124 for lens or glass for lighting fixture.
- D34, Material of Article Handling Equipment, subclass 28 for escalator; subclass 30 for mobile stair for boarding aircraft; subclass 31 for vehicle jack or jack stand; subclass 33 for elevator.
- D99, Miscellaneous, subclasses 1-7 for burial vault.

MAINLINE SUBCLASSES

- 1 STRUCTURE:**
Design under the Class Definition for building, supporting framework, or infrastructure.

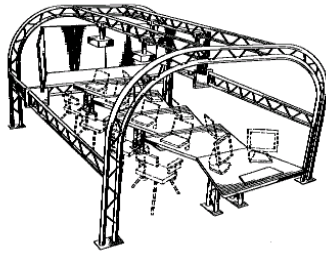

Example of a design for a structure.

- (1) Note. Includes bridge.

SEE OR SEARCH THIS CLASS, SUBCLASS:

56-57, for roof with no structure other than support.

SEE OR SEARCH CLASS:

D6, Furnishings, subclasses 421 and 553-574 for structure that encloses telephone only.

D12, Transportation, subclasses 101-106 for mobile home or trailer; subclass 203 for step place for vehicle; subclass 325 for space habitat.

D21, Games, Toys, and Sports Goods, subclasses 506-511 for toy building, subclasses 834-838 for tent.

D99, Miscellaneous, subclasses 1-7 for burial vault.

35

PREFABRICATED UNIT:

Design under the Class Definition for factory built-type building or enclosure.

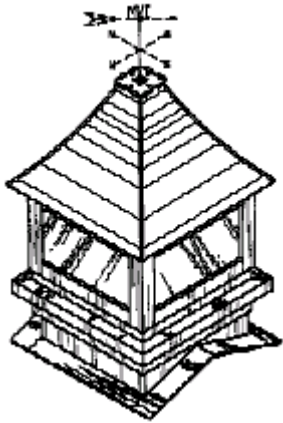

Example of a design for a prefabricated unit.

- (1) Note. Includes only plural components that are preassembled as a unit, such as a steeple, copula, etc.

SEE OR SEARCH THIS CLASS, SUBCLASS:

62-69, for stair, ladder, or scaffold.

100-101, for trellis.

126-135, for post, support, or beam.

102-198, for individual building components.

SEE OR SEARCH CLASS:

- D6, Furnishings, subclasses 421 and 553-574 for structure that encloses telephone only.
- D12, Transportation, subclasses 101-106 for mobile home or trailer; subclass 203 for step place for vehicle; subclass 325 for space habitat.
- D21, Games, Toys, and Sports Goods, subclasses 815 and 816 for portable swimming or wading pool.
- D23, Environmental Heating and Cooling; Fluid Handling and Sanitary Equipment, subclass 308 for tiles assembled into countertop; subclass 404 for fireplace mantel.
- D26, Lighting, subclass 68 for lamp combined with post; subclasses 120-124 for lens or glass for lighting fixture.
- D34, Material of Article Handling Equipment, subclass 28 for escalator; subclass 30 for mobile stair for boarding aircraft; subclass 33 for elevator.

62

STAIR, LADDER, SCAFFOLD, OR SIMILAR SUPPORT:

Design under the Class Definition for flight of fixed steps or non-permanent structure to elevate or channel human body.

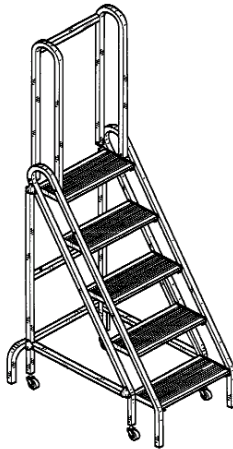

Example of design for a stair.

- (1) Note. Includes ramp.
- (2) Note. Includes bleachers.

SEE OR SEARCH CLASS:

D34, Material of Article Handling Equipment, subclass 28 for escalator; subclass 30 for mobile stair for boarding aircraft; subclass 31 for vehicle jack or jack stand; subclass 33 for elevator.

100 TRELLIS OR TREILLAGE UNIT:

Design under the Class Definition for light framework or structure for supporting climbing plants.

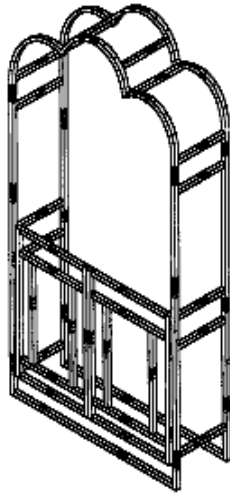

Example of a design for a trellis.

SEE OR SEARCH CLASS:

D11, Jewelry, Symbolic Insignia and Ornaments, subclasses 143-163 for form or holder for flower or flower arrangement.

102 ARCHITECTURAL STOCK MATERIAL:

Design under the Class Definition for fabrication parts for building construction.

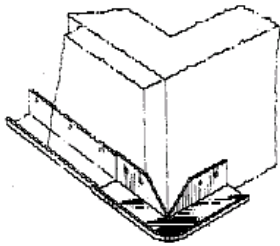

Example of a design for architectural stock material.

SEE OR SEARCH CLASS:

- D5, Textile or Paper Yard Goods, Sheet Material, appropriate subclasses for cloth, textile or wallpaper.
- D6, Furnishings, subclasses 582-594 for linoleum-type floor rug or tiles assembled into floor or wall covering.
- D8, Tools and Hardware, appropriate subclasses for fence or railing hardware; subclass 1 for plant stake; subclasses 323-329 for gate hinge; subclasses 331-335 for gate latch; subclass 377 for track for sliding door; subclass 384 for concrete wall tie.
- D14, Recording, Communication, or Information Retrieval Equipment, subclass 219 for grille for audio or video equipment.
- D21, Games, Toys, and Sports Goods, subclasses 484-504 for toy construction building blocks; subclass 802 for diving board.
- D23, Environmental Heating and Cooling; Fluid Handling and Sanitary Equipment, subclass 266 for pipe, tubing, or hose; subclass 267 for roof-type gutter; subclass 308 for tiles assembled into countertop; subclass 404 for fireplace mantel.
- D26, Lighting, subclass 68 for lamp combined with post; subclasses 120-124 for lens or glass for lighting fixture.

199 MISCELLANEOUS:

Design under the Class Definition directed to a building unit or construction element not elsewhere provided for.