

CLASS 206, SPECIAL RECEPTACLE OR PACKAGE

SECTION I - CLASS DEFINITION

Class 206 is the residual locus for: (a) a container configured to hold a particular article or set of articles or material; (b) a mercantile unit - i.e., means in or by which goods (article or material) are displayed, protected, packaged or arranged in a particular manner, to facilitate sale, transportation in commerce, use or storage or (c) a packet, compact or case carried on the person of a user.

- (1) Note. Containers of this class type must function, by disclosure, to hold contents which in turn are to be eventually removed from the container.
- (2) Note. Generally, specific container (or retainer) structure as defined above, in combination with composition or stock material characteristics of said structure is considered classifiable in Class 206. However, mere "nominal" inclusion of a container (or retainer) in such combination is not considered "specific". For example: "A gas bag of synthetic polyester textile fiber mesh laminated between polyester films," is considered properly classified elsewhere. Similarly, "An acid tank with walls made of leak stopping composition x, y, z" and "A match safe with walls made of fireproof material x, y, z," are considered subject matter for the appropriate composition class. See Lines With Other Classes and Within This Class and References to Other Classes, below.
- (3) Note. Included here is a bale, bundle, roll, pile, stack or nest of articles (or material) which arrangement must be destroyed for use of an individual component or its contents-e.g., a roll of severably connected fasteners, an article or receptacle configured to nest or stack with another article or receptacle, or the knockdown interfitted arrangement of a device or article.
- (4) Note. Generally, unless provided for in some other class as partially indicated under "SEARCH CLASS" below, the combination of an article (or material) and its containment means is to be found in this

(206) class. However, the claimed disclosure of content is ordinarily not a basis for intra class distinctions among the subclasses therein.

- (5) Note. Included here is a package for (or with) a plurality of articles or material, or an arrangement of articles or material, which articles or materials are to be used together (successively or cooperatively) in any operation or to make a definite solution, mixture, composition or assemblage.
- (6) Note. Included here is a container, package or packing element under the class definition having (a) means for displaying an article or material, (b) indicia, a sign, panel or simulation means or (c) an indicator relative to the container or contents.
- (7) Note. Included here is a container wherein the content (article or material) included, or to be included therein, bears some relationship to the container other than mere containment.
- (8) Note. Placement of patents within class schedule. Patents issued since 1940 have been classified, both for original and cross reference placement, in accord with the claimed disclosure. However, patents issued prior to 1940 have generally been evaluated as to total disclosure, and thus placement of these older patents does not necessarily indicate lines of classification.
- (9) Note. The subclass schedule and definitions, as revised and published in late 1973, represent an initial effort toward a realignment of the several receptacle classes-both with respect to each other and to other related classes. See Lines With Other Classes and Within This Class, below, for a further discussion of this topic.

SECTION II - LINES WITH OTHER CLASSES AND WITHIN THIS CLASS

The subclass schedule and definitions, as revised and published in late 1973, represent an initial effort toward a realignment of the several receptacle classes-both with respect to each other and to other related classes. Thus, as of this time (1973) no significant inter-class changes

have been effected except with respect to the transfer from Class 220 into this (206) class of (a) portable carriers for plural beverage receptacles (subclasses 139+) and (b) nesting or stacking features (subclasses 499 - 520). As subsequent changes are completed they will be annotated in this section for emphasis.

Special attention is directed to the major receptacle classes listed below which, except as noted above, have not been modified as a result of this particular reclassification in 1973.

150, Purses, Wallets, and Protective Covers

190, Trunks and Hand-Carried Luggage

215, Bottles and Jars

217, Wooden Receptacles

220, Receptacles

229, Envelopes, Wrappers, and Paperboard Boxes

312, Supports: Cabinet Structure

As between Class 206 and the other receptacle classes, above, claimed disclosure of (a) content (article or material) in combination with the container or retainer structure or (b) specific retainer structure, per se, is classified in Class 206. However, the following language is not considered as "claimed disclosure" for Class 206.

"A container for (a named article or material) ..."

"A container adapted to hold (a named article or material) ..."

"A (named article or material) container ..."

Similarly, a mere multi-compartmented or partitioned container, is not "special" or specific retainer structure for Class 206.

SECTION III - REFERENCES TO OTHER CLASSES

SEE OR SEARCH CLASS:

8, Bleaching and Dyeing: Fluid Treatment and Chemical Modification of Textiles and Fibers, particularly subclasses 524+ for compositions used in the processes named in the class title,

which may be in the form of cakes, tablets, flakes, powders, etc.

30, Cutlery, subclasses 124+ and 535 for cutlery combined with receptacles.

40, Card, Picture, or Sign Exhibiting, subclasses 312+ for boxes having indicia thereon.

42, Firearms, particularly subclasses 49.01+ and 87+ for magazines and magazine chargers.

43, Fishing, Trapping, and Vermin Destroying, subclass 26 for covers and containers to hold sections of jointed rods, subclasses 54.1+ for holders for bait, tackle and the catch, and subclasses 56+ for minnow buckets.

44, Fuel and Related Compositions, subclasses 540 and 541 for a bundled, covered or wrapped fuel product.

47, Plant Husbandry, subclasses 66.1+ for flower pots, and subclasses 50+ for sap buckets.

48, Gas: Heating and Illuminating, subclasses 59+ for carbide cartridges, and subclass 174 for gas holders.

51, Abrasive Tool Making Process, Material, or Composition, subclass 294 for an abradant-filled bag.

53, Package Making, particularly subclasses 394+ for matchbook making and subclasses 396+ for methods of package making.

62, Refrigeration, subclasses 457.1+ for a refrigerator specialized to a portable receptacle.

70, Locks, subclasses 456+ for key holders.

71, Chemistry: Fertilizers, subclasses 64.01+ and the notes thereunder for fertilizers in commercial forms.

73, Measuring and Testing, subclasses 426+ for measuring vessels.

102, Ammunition and Explosives, particularly subclass 282 for bags adapted to contain explosive powder and subclasses 283+ for sticks or bars of explosive substance arranged to modify the rate or manner of burning or exploding.

112, Sewing, subclasses 400+ for a stock material product of a sewing operation. See notes thereunder for the locus of other sewn products.

116, Signals and Indicators, subclass 72 for poison receptacles and alarms.

126, Stoves and Furnaces, subclasses 261+ for heated lunch receptacles.

131, Tobacco, subclasses 347+, particularly subclasses 349+ for packages of tobacco users' appliances combined with ash receptacles. The recitation of significant claimed tobacco product structure or composition-i.e., more than a named article such as a cigar or cigarette will effect classification in Class 131.

- 132, Toilet, particularly subclass 286 for toilet kits.
- 149, Explosive and Thermic Compositions, or Charges.
- 150, Purses, Wallets, and Protective Covers, appropriate subclasses for receptacles used to carry money, credit cards or items of identification on the person, and for flaccid protective article covers not provided for elsewhere.
- 219, Electric Heating, subclasses 385+ for an electric heating device combined with a container or enclosure.
- 220, Receptacles, and the notes appended to the class definition thereof for other receptacles.
- 221, Article Dispensing, appropriate subclasses for article dispensers not otherwise provided for. Class 221 is the residual article dispensing class and takes receptacles having means to eject or release articles therefrom where not otherwise provided for. As between Class 206 and Class 221, if a container, otherwise classifiable in Class 206, includes a dispensing feature recognized as indicative of classification in Class 221, as set forth in the class definition of Class 221, patents are classified therein.
- 222, Dispensing, subclasses 3+ for gas or vapor dispensing. See 20 in the class definition of Class 222 relative to collapsibility as a dispensing feature.
- 223, Apparel Apparatus, subclasses 106+ for spool and implement holders.
- 224, Package and Article Carriers, for animal worn or vehicle carried receptacles which are package or article carriers.
- 242, Winding, Tensioning, or Guiding, subclasses 159+ for a detail of a wound storage package, subclasses 588+ for a randomly oriented coil holder, and subclasses 137+ for a spool holding carrier in which material from a coil remains within in a reusable receptacle.
- 248, Supports, subclasses 200+ for a bracket type soap holder, subclasses 317+ for a suspended type soap holder and subclasses 683+ for a holder which supports the soap while in storage position and remains with the soap while in use.
- 250, Radiant Energy, subclasses 475.2+ for special ray photographic cassettes.
- 252, Compositions, particularly subclass 176 for packages of compositions of the type included in that class.
- 294, Handling: Hand and Hoist-Line Implements, appropriate subclasses for package and article carriers which are not receptacles and which do not form a mercantile unit when holding the article.
- 312, Supports: Cabinet Structure, subclass 351 for a soap dish provided with means to support the soap in spaced relation to the bottom wall of the structure.
- 378, X-Ray or Gamma Ray Systems or Devices, subclasses 167+ for photographic detector supports combined with X-ray devices.
- 396, Photography, subclasses 511+ for means which hold sensitized surfaces during exposure.
- 401, Coating Implements With Material Supply, subclasses 88+ for a holder or wrapper enclosing a piece of self-sustaining coating material with an end of the piece exposed so as to apply to a surface by rubbing contact therewith; subclasses 118+, for the combination of a container for a supply of coating material and a removable hand-manipulable applicator for applying the material to a work surface; subclasses 196+, for a coating implement with material supply having a porous work-engaging portion, through which porous portion the material flows from the supply to the work surface (e.g., a mere porous pad with a pocket for soap, in subclass 201); and subclasses 268+ for a brush, broom or mop with means to retain a piece of soap in direct proximity to the filamentary tool elements.
- 422, Chemical Apparatus and Process Disinfecting, Deodorizing, Preserving, or Sterilizing, subclass 547, for chemical test package or kit; subclasses 500-570 for laboratory receptacles; and other appropriate subclasses for containers for that class. An alternative electronic search of U.S. patents based upon a modification of the European Patent Office Classification (ECLA) System for certain subject matter in this subclass may also be found in Class 422 Cross-Reference Art Collections 908-948. (There are no definitions associated with these Cross-Reference Art Collections. The most available disclosure as to the types of documents contained herein is given in any notes associated with the titles.)
- 424, Drug, Bio-Affecting and Body Treating Compositions, subclasses 14+ for a medicine enclosed in an ingestible capsule, etc., and subclasses 16+ for a base (carrier or vehicle) coated or impregnated with a composition of that class (424).
- 426, Food or Edible Material: Processes, Compositions, and Products, subclasses 106+ for a food package. A food package for Class 426 must

- claim the content as a food either specifically or on the basis of sole disclosure. Recital of food and nonfood as alternative content will effect classification in this (206) class.
- 428, Stock Material or Miscellaneous Articles, appropriate subclasses for structure falling within the Class 428 and further modified by the bare recital that such other structure is (a) in the form of a “roll”, “reel”, “drum”, “coil”, “stack”, “pile”, “bale”, or (b) “packaged” or “within a container”.
- 429, Chemistry: Electrical Current Producing Apparatus, Product, and Process, subclasses 163+, especially 176 for vessels designed specifically for battery elements.
- 435, Chemistry: Molecular Biology and Microbiology, subclasses 243+ for packages of products that contain ferments, that are living fungi.
- 446, Amusement Devices: Toys, subclasses 2+ for money boxes, and subclass 11 for toys in the form of containers or for containers which may be converted into toys.
- 449, Bee Culture, subclass 17 for a container for marketing comb honey.
- 508, Solid Antifriction Devices, Materials Therefor, Lubricant or Separant Compositions for Moving Solid Surfaces, and Miscellaneous Mineral Oil Compositions, for packages of compositions of the type included in that class.
- 510, Cleaning Compositions for Solid Surfaces, Auxiliary Compositions Therefor, or Processes of Preparing the Compositions, particularly subclasses 120, 140, 277, 293, 295+, 406, and 439 for packages of compositions of the type included in that class and subclass.
- 520, Synthetic Resins or Natural Rubbers, appropriate subclasses, particularly Class 523, subclass 134 for a composition containing a synthetic resin or natural rubber having utility as a battery container or battery container cover or to processes of preparing said composition.
- 588, Hazardous or Toxic Waste Destruction or Containment, subclasses 249 through 260 for containment or storage of hazardous or toxic waste.
- 600, Surgery, subclasses 1+ for radioactive substances applied to the body for therapy including radioactive seeds and holders.
- 604, Surgery, subclasses 403+ for a medicator constituting a container or holder for a solid, liquid, or gas.

SUBCLASSES

- .5 INFUSION CONTAINING:**
This subclass is indented under the class definition. Receptacles and packages containing an infusing substance which may be infused directly from or through the walls of the receptacle or package.
- SEE OR SEARCH THIS CLASS, SUBCLASS:
524.1+, for a container with specified material for the cover or content, especially subclass 524.7 for a soluble container.
- SEE OR SEARCH CLASS:
4, Baths, Closets, Sinks, and Spittoons, subclasses 226, 228-231 for disinfecting chemical holders for use in the flush pipes and flush bowls of water closets.
8, Bleaching and Dyeing; Fluid Treatment and Chemical Modification of Textiles and Fibers, subclasses 524+ for compositions used in the processes named which may be in the form of cakes, tablets, powders, etc.
15, Brushing, Scrubbing, and General Cleaning, subclasses 561+ for material applicators of general utility having a work contacting means and a material supply wherein the material permeates the work contacting means.
99, Foods and Beverages: Apparatus, subclass 323 for reusable infusion receptacles for use in preparing beverages.
134, Cleaning and Liquid Contact With Solids, subclass 93 for soap dissolving devices forming part of a cleaning apparatus.
210, Liquid Purification or Separation, subclass 282 for removable cartridges or hand-manipulated containers for particulate material functioning as a separator, and subclass 484 for a unit comprising a filter medium within a foraminous container.
239, Fluid Sprinkling, Spraying, and Diffusing, subclasses 34+ for holders for slow diffusers.

- 424, Drug, Bio-Affecting and Body Treating Compositions, subclasses 411+ for a base (carrier or vehicle) coated or impregnated with a composition, e.g., insecticide, medicine, etc., of that class.
- 426, Food or Edible Material: Processes, Compositions, and Products, subclass 77 for tea, coffee and beverage bags.
- 604, Surgery, subclasses 403+ for receptacles designed to hold medicaments, especially containers facilitating the charging of medicating device.

.6 FOR GAS:

This subclass is indented under the class definition. Receptacles and packages for storing gas.

SEE OR SEARCH CLASS:

- 48, Gas: Heating and Illuminating, subclasses 174+ for gas holders.
- 62, Refrigeration, subclasses 45.1+ for process and apparatus for handling liquefied gas as a commodity including steps or means involving pressure or temperature control special to liquefied gas and more than required for other liquids.
- 141, Fluent Material Handling, With Receiver or Receiver Coating Means, appropriate subclasses for processes and apparatus for filling a receiver with gas.
- 169, Fire Extinguishers, particularly subclasses 11 and 12, for fire extinguishers in which the extinguishing agent is a gas.
- 222, Dispensing, subclasses 3+, for other gas dispensing.
- 424, Drug, Bio-Affecting and Body Treating Compositions, subclasses 43+, for an effervescent composition of that class.

.7 With gas storing absorbent or solvent:

This subclass is indented under subclass .6. Devices containing an absorbent, adsorbent or solvent in which the gas is stored.

- (1) Note. A device for storing hydrogen in the form of a metal hydride, suitable for decomposition in situ to produce hydrogen gas, is classified in this subclass.

SEE OR SEARCH CLASS:

- 252, Compositions, subclass 364, for solvents.
- 312, Supports: Cabinet Structure, subclasses 31+, for containers for non-gaseous materials having slow diffusers or absorbents.
- 423, Chemistry of Inorganic Compounds, subclass 658.2 for a method for producing elemental hydrogen by direct decomposition of a metal hydride.
- 502, Catalyst, Solid Sorbent, or Support Therefor: Product or Process of Making, especially subclasses 60+, 400+ and 526 for a sorbent composition

.8 FOR COIN (E.G., MAT):

This subclass is indented under the class definition. Receptacles and packages for containing or holding coins. For example, in this subclass are mats or pads specially constructed to facilitate picking up of coins lying thereon.

SEE OR SEARCH THIS CLASS, SUBCLASS:

- 37+, for pocket and personal use receptacles for articles other than coins.
- 557+, for trays for articles other than coins.

SEE OR SEARCH CLASS:

- 150, Purses, Wallets, and Protective Covers, subclasses 150+ for a coin-holding pocketbook.
- 211, Supports: Racks, subclass 49.1 for racks for stacking poker chips and other disc form devices similar to coins.
- 229, Envelopes, Wrappers, and Paperboard Boxes, particularly subclasses 87.2 and 92.9 for coin receptacles, packages and wrappers of paper and for coin cards.
- 232, Deposit and Collection Receptacles, particularly subclasses 55+ for coin traps and 64+ for devices for dumping change into a customer's hand.
- 235, Registers, subclasses 2 through 49 for cash and fare registers.
- 312, Supports: Cabinet Structure, for money drawers.

- .81 Combined:**
This subclass is indented under subclass .8. Devices combined with other features, e.g., with a receptacle or pocket for paper money and things other than coins, with indicia, with a mirror, etc.
- SEE OR SEARCH THIS CLASS, SUB-CLASS:
38+, for a combined pocket or personal use container for articles other than coins.
- .815 Bulk coin receptacle having a coin insertion slit or slot (e.g., savings bank type):**
This subclass is indented under subclass .8. Receptacle or package which includes a relatively long narrow opening sized to accept a coin and which is intended to hold randomly arranged coins (i.e., the coins are not held in position).
- SEE OR SEARCH CLASS:
229, Envelopes, Wrappers, and Paperboard Boxes, subclass 92.9 for a coin card.
232, Deposit and Collection Receptacles, subclasses 4+ for a savings box in which money is inserted through an opening one item at a time and is removed in bulk through a different opening.
446, Amusement Devices: Toys, subclasses 8+ for a toy money bank.
- .82 With closing or fastening means:**
This subclass is indented under subclass .8. Devices having either means for closing the same or means for fastening the coins in place.
- .83 Multiple pocket or compartment:**
This subclass is indented under subclass .82. Devices having two or more compartments or pockets for coins.
- SEE OR SEARCH THIS CLASS, SUB-CLASS:
.81, for devices that have one or more pockets or compartments for coins and one or more for other things.
- .84 Multiple pocket or compartment:**
This subclass is indented under subclass .8. Devices having two or more pockets or compartments for coins.
- SEE OR SEARCH THIS CLASS, SUB-CLASS:
.81, for devices that have one or more pockets or compartments for coins and one or more for other things.
.83, for multiple pocket or compartment devices with closing or fastening means.
- 1.5 WITH STRUCTURAL LOCKING MODIFICATION:**
This subclass is indented under the class definition. A container in which the structure is modified to effect a locked condition, the unlocking not being effected by conventional means, but generally by a manipulation of the container or a part thereof.
- SEE OR SEARCH THIS CLASS, SUB-CLASS:
262, for a tobacco product (or pipe) casing formed of hinged covers released by translation of said covers.
- SEE OR SEARCH CLASS:
70, Locks, subclasses 289+ for an operating lock mechanism of a complex or puzzle type.
- 1.7 FOR ARTIST EQUIPMENT:**
This subclass is indented under the class definition. A container which is constructed or configured to hold materials and appliances especially for use by artists.
- SEE OR SEARCH CLASS:
312, Supports: Cabinet Structure, appropriate subclass for artists' receptacles which include features, beyond that for holding the artists' supplies, such as supporting structure for the receptacle or the work.
- 1.8 Paint holder (e.g., color box):**
This subclass is indented under subclass 1.7. A container in the form of a box provided with a plurality of spaced receptacles, each receptacles holding a paint tablet or a container of liquid paint.

1.9 Paint package:

This subclass is indented under subclass 1.7. A container for a disc or wafer of paint put up as a package and sealed against the entry of dust and other foreign matter by means of a protective cover.

3 FOR AMMUNITION:

This subclass is indented under the class definition. A container specifically restricted to the function of containing ammunition for storage and shipping.

SEE OR SEARCH CLASS:

- 42, Firearms, particularly subclasses 87+ for devices holding fixed ammunition ready for insertion into magazines of firearms.
- 217, Wooden Receptacles, subclasses 18+ for cell structures for receptacles.
- 224, Package and Article Carriers, appropriate subclasses, particularly subclasses 196, 199, 223, 239, 600+, and 660+ cross-reference art collection 931 for carriers and holders for cartridges and caps.

5 FOR EYEGLOSS OR SPECTACLE:

This subclass is indented under the class definition. A container comprising cases or covers for a face carried, vision correcting, optical device.

5.1 Contact lens:

This subclass is indented under subclass 5. A container for a small eyeglass of the type that is worn against the eyeball itself.

6 Hinged parts:

This subclass is indented under subclass 5. A container involving hinged parts.

6.1 FOR JEWELRY:

This subclass is indented under the class definition. Subject matter comprising either a container for, or a package including, one or more items of personal adornment.

SEE OR SEARCH THIS CLASS, SUBCLASS:

- 205, for a container including an ancillary article contacting medium (e.g., anti-tarnish composition).

- 301, for a container for a watch or clock.
- 553, for a container for silverware eating utensils.
- 566, for a tray type (i.e., open, shallow) container for jewelry.

8 Hat and headwear:

This subclass is indented under subclass 278. A container comprising hat boxes and cases. Also forms and special devices for retaining hats, etc., in boxes.

9 Rack, frame, or ring:

This subclass is indented under subclass 8. A container for packing a plurality of hats, etc. Also constructions of rings or bands placed around any individual hat to protect it when it is nested or packed with other hats. Includes cases and frames for hats which are modified to permit the display of the hat, provided the packing function is retained.

11 Fur:

This subclass is indented under subclass 278. A container constructed to contain sets of furs, muffs, collars, etc.

14 Violin:

This subclass is indented under subclass 314. A container for violins and like instruments. Also devices for holding violin-bows in the cases.

15 For holding a phonograph cylinder:

This subclass is indented under subclass 307. A container provided with means for holding cylindrical phonograph-records, either a case for a single record or for a plurality of records.

SEE OR SEARCH THIS CLASS, SUBCLASS:

- 309, for holders for phonograph-disks not forming articles of furniture.
- 314, for portable cases for holding any other part of a phonograph.

SEE OR SEARCH CLASS:

- 211, Supports: Racks, subclass 40, for phonograph record type racks.
- 312, Supports: Cabinet Structure, subclasses 9.1+, for phonograph record cabinets.

15.2 Closure supported:

This subclass is indented under subclass 361. A container in which the closure for the receptacle is provided with means to statically support the brush or brush head.

SEE OR SEARCH CLASS:

- 215, Bottles and Jars, subclasses 228+ for receptacles of the type classifiable in Class 215 wherein a brush is supported by the closure.
- 401, Coating Implements With Material Supply, subclasses 126+ for the combination of a container for a supply of coating material, a removable closure for the container, and an applicator to apply the material to a work surface, which applicator depends from the closure in a position to receive coating material from the supply.

15.3 Projecting handle:

This subclass is indented under subclass 15.2. A container in which the receptacle closure is provided with an opening through which the brush handle may extend when it is supported in the receptacle.

SEE OR SEARCH CLASS:

- 401, Coating Implements With Material Supply, subclass 127 for the combination of a container for a supply of coating material, a removable closure for the container and an opening in the closure to receive material from the supply and apply it to a work surface.

18 Watch or clock movement:

This subclass is indented under subclass 301. A container inclosing and protecting watch-movements. Commonly the case is provided with elastic supports for the watch-movement to prevent injury from shocks.

19 SACRAMENTAL:

This subclass is indented under the class definition. A container specifically arranged for sacerdotal use.

37 FOR POCKET OR PERSONAL USE:

This subclass is indented under the class definition. A container which is so constructed or configured that it is conveniently carried in the pocket or otherwise on the person of a user.

- (1) Note. A great many of the containers classified in this (206) class are "small" and can be considered as for pocket or personal use. In part, the rules of subclass schedule superiority have resulted in patents to such containers falling into subclasses higher in the schedule. Only a representative sample of those patents have had a cross reference placed in subclasses 37+ and 38+. Therefore, a full search for features considered of import with respect to size must include such higher subclasses.

SEE OR SEARCH THIS CLASS, SUBCLASS:

- 5+, for a container for eyeglasses.
- 38+, for a pocket or personal use container configured to hold two or more diverse articles or materials.
- 85+, for a container for tobacco with an igniter.
- 96+, for a match packet or container for matches.
- 242+, for a container for tobacco, cigarettes, a pipe or a cigarette holder.
- 352+, for a container for a razor blade.

SEE OR SEARCH CLASS:

- 150, Purses, Wallets, and Protective Covers, subclasses 131+ for a pocket or purse carried container for relatively small personal items (e.g., money, credit cards, items of identification, etc.).

37.1 For a key:

This subclass is indented under subclass 37. Subject matter wherein the container is intended to hold a keys or keys.

37.2 Including external element for ejecting key:

This subclass is indented under subclass 37.1. Subject matter wherein the key container includes means located exteriorly thereof for forcing the key into its use position.

37.3 Key frictionally retained in container:
This subclass is indented under subclass 37.1. Subject matter wherein a key is held in position by pressure from opposing portions of the container.

37.4 Compartmented:
This subclass is indented under subclass 37.1. Subject matter wherein the container includes means for separating two or more keys from one another.

37.5 Includes key retainer of two elements movable relative to each other and to the container:
This subclass is indented under subclass 37.1. Subject matter wherein the container includes two parts which can be moved in relation to each other and the container.

37.6 Includes plural, serially aligned key retainers:
This subclass is indented under subclass 37.1. Subject matter wherein the container includes a plurality of elements for securing keys therein, which elements are linearly arranged.

SEE OR SEARCH THIS CLASS, SUBCLASS:
37.8, for a key container having an element for securing a plurality of keys therein.

37.7 Removable:
This subclass is indented under subclass 37.6. Subject matter wherein the key securing elements are separable (detached) from the container.

37.8 Including key retainer for common mounting of plural keys:
This subclass is indented under subclass 37.1. Subject matter wherein the container includes an element for securing a plurality of keys therein, said element extending through each key.

SEE OR SEARCH THIS CLASS, SUBCLASS:
37.6, for a key container having a plurality of elements for securing keys therein.

38 For pocket or personal use:
This subclass is indented under subclass 216. A container for pocket or personal use provided with two or more compartments specifically arranged to hold diverse articles; or a box or case, having only a single compartment but also including some article of personal use, such as a comb, knife, compass, etc.

SEE OR SEARCH THIS CLASS, SUBCLASS:

37+, for a container for pocket or personal use. See the notes under subclass 37.

SEE OR SEARCH CLASS:

150, Purses, Wallets, and Protective Covers, subclass 106 for a purse combined with personal items, and subclasses 131+ for a pocket or purse carried container for relatively small personal items (e.g., money, credit cards, items of identification, etc.).

221, Article Dispensing, subclasses 92+ for article dispensing devices having plural sources, stacks or compartments.

222, Dispensing, subclasses 129+ for fluent material dispensers having plural sources or compartments for the material to be dispensed.

38.1 Key case:
This subclass is indented under subclass 38. A container under subclass configured either as to shape, interior arrangement, or retaining device for holding a key.

SEE OR SEARCH THIS CLASS, SUBCLASS:

0.81, for a combined coin and key container.

37.1+, for a key container, per se.

39 Ticket case:
This subclass is indented under subclass 37. A container specially constructed to hold tickets, cards, stamps, etc.

(1) Note. Included here is a patent for a currency or note case made of other than cloth, or leather; for which see reference to Class 150 below.

- (2) Note. A container for a “large” sheet is classified in subclasses 449+. See (1) Note under subclass 37.

SEE OR SEARCH THIS CLASS, SUB-CLASS:

425, for a file for plural sheets or cards.

SEE OR SEARCH CLASS:

150, Purses, Wallets, and Protective Covers, subclasses 131+ for a wallet-type container and subclasses 147+ for a pocket carried card container with no specific relationship between the container and the card (e.g., no retaining means).

225, Severing by Tearing or Breaking, appropriate subclasses for a ticket dispensing container combined with a blade or other severing means.

402, Binder Device Releasably Engaging Aperture or Notch of Sheet, appropriate subclasses for an apertured or notched sheet retainer, which sheet can be removed without mutilation of said sheet.

39.1 With means to retain stub:

This subclass is indented under subclass 39. A container including structure for holding or securing a portion-usually with a record indicia-of the ticket or card that is removed from the container.

39.2 Piercing pin type:

This subclass is indented under subclass 39.1. A container wherein the structure to hold or secure a stub portion includes an element stuck through said portion or through an aperture in said portion.

39.3 Plural stacks, coils, or fan-folded strips:

This subclass is indented under subclass 39. A container for two or more separate groups of tickets, cards or stamps.

- (1) Note. Generally, each group is so held that an individual item may selectively be removed or separated from a desired group.

39.4 With ejector mechanism:

This subclass is indented under subclass 39. A container including structure engaging content so that manipulation of said structure projects a portion of the content from the container.

SEE OR SEARCH CLASS:

221, Article Dispensing, appropriate subclasses for a device to eject a single item from a group.

39.5 With opening for ejection by finger:

This subclass is indented under subclass 39. A container including an aperture exposing at least part of a top, bottom or outer content item so that it may be shifted by frictional finger action to expose either (a) a single item or (b) a desired portion of strip content.

SEE OR SEARCH THIS CLASS, SUB-CLASS:

357+, for a razor blade container with mid-blade access for finger.

555+, for a “large” plate or sheet container with access means for manual content removal.

39.6 Pull type:

This subclass is indented under subclass 39.5. A container wherein the aperture is at a container end wall - e.g., a notch - so that an exposed end portion of content is frictionally engaged.

39.7 Folded card or folded sheet content:

This subclass is indented under subclass 39. A container for a distinct content item which is doubled over - at least in part - so as to fit the container.

SEE OR SEARCH THIS CLASS, SUB-CLASS:

494, for a container for a folded sheet-like article.

525+, for a folded blank container where the article, or content, is folded with the blank.

39.8 Coiled strip or fan-folded strip content:

This subclass is indented under subclass 39. A container for a band of tickets, cards or stamps in either a roll configuration or doubled over in accordion-like fashion.

- 45.2 With cover convertible to easel or receptacle support:**
This subclass is indented under subclass 736. A container provided with a cover which is convertible to or includes or carries means to form a support or easel for holding the container in inclined or elevated display position.
- 45.21 Folded blank box:**
This subclass is indented under subclass 45.2. A container of the folder blank type.
- SEE OR SEARCH CLASS:
229, Envelopes, Wrappers, and Paperboard Boxes, subclasses 100+ for a folded, blank paperboard box.
- 45.22 Multiple blank:**
This subclass is indented under subclass 45.21. A container comprising multiple blanks.
- SEE OR SEARCH CLASS:
229, Envelopes, Wrappers, and Paperboard Boxes, subclasses 122.21+, 122.27+, and 122.32+ for multiple blank paper boxes.
- 45.23 Pivoted cover:**
This subclass is indented under subclass 45.2. A container in which the cover is hinged to the container or is connected thereto by pivoted links.
- 45.24 With folding easel or receptacle support:**
This subclass is indented under subclass 736. A container provided with a support or easel for supporting the entire container in display position, the support being foldable or movable to an inoperative position to provide with the container a compact shipping or storage unit.
- SEE OR SEARCH THIS CLASS, SUBCLASS:
45.2+, for covers which are convertible to easels.
- SEE OR SEARCH CLASS:
248, Supports, appropriate subclass, for supports, per se.
- 45.25 Folded blank box:**
This subclass is indented under subclass 45.24. A container of the folded blank type.
- SEE OR SEARCH CLASS:
221, Article Dispensing, subclass 305 for similar structures including a dispensing type outlet.
248, Supports, subclass 152 for supports, per se, of sheet material and subclass 198 for easels formed of sheet material.
- 45.26 Support cut from receptacle wall:**
This subclass is indented under subclass 45.25. A container in which the support is cut from one or more of the box walls.
- 45.27 Multiple blank:**
This subclass is indented under subclass 45.25. A container comprising multiple blanks.
- 45.28 With cover convertible to display card:**
This subclass is indented under subclass 736. A container provided with a cover which when opened functions as an upstanding display card.
- SEE OR SEARCH CLASS:
217, Wooden Receptacles, subclasses 60+ for hinged closures having support means to hold them in open position.
- 45.29 Folded blank box:**
This subclass is indented under subclass 45.28. A container of the folder blank type.
- 45.3 Multiple blank:**
This subclass is indented under subclass 45.29. A container comprising multiple blanks.
- 49 EMBROIDERY, LACE, OR RUCHING:**
This subclass is indented under the class definition. A container including embroidery, laces, trimming, etc. Commonly the package prevents the lace or ruching from being crushed and also provides for a display of a portion of such lace.
- 53 With clamp:**
This subclass is indented under subclass 389. A container including a holder applied to rolls or spools of ribbon, braid, etc., for preventing the unrolling of the fabric.

- 54 Centrally attached:**
This subclass is indented under subclass 53. A container including a holder secured to the center of the roll or spool.
- 55 Layer retained:**
This subclass is indented under subclass 53. A container with one member of the clamp engaging between the layers of the ribbon or braid to retain the clamp in position.
- 63.3 Ligatures:**
This subclass is indented under subclass 438. A container of filamentary material, generally aseptic, specially adapted for use in stitching wounds and other surgical operations.
- SEE OR SEARCH CLASS:
242, Winding, Tensioning, or Guiding, subclasses 134+ for a device for holding spools, subclasses 141+ for a twine holder, and subclasses 159+ for a wound storage package.
606, Surgery, subclasses 228+ for sutures and ligatures.
- 63.5 Dental:**
This subclass is indented under subclass 438. A container of dental materials and articles adapted for use in dental work. Includes also waste receptacles for dental materials and articles.
- SEE OR SEARCH THIS CLASS, SUBCLASS:
364+, for a syringe container.
368+, for a dental tool container.
379, for a bit or drill container.
- 68 FOR AN INCANDESCENT MANTLE:**
This subclass is indented under the class definition. A container for a mantle for incandescent lighting.
- SEE OR SEARCH CLASS:
431, Combustion, subclasses 100+ for an incandescent mantle, per se.
- 69 FOR RUBBER BAG OR TUBE (E.G., PROPHYLACTIC):**
This subclass is indented under the class definition. A container for a rubber bag or tubing commonly water-bags, fountain-syringes, and the like with tubing.
- SEE OR SEARCH THIS CLASS, SUBCLASS:
364, for a hypodermic syringe container.
- 70 Watch spring:**
This subclass is indented under subclass 301. A container for a watch-spring. Commonly a casing encloses the spring and maintains the same in coiled condition ready for insertion into a watch-barrel.
- 71 FOR METALLIC LEAF:**
This subclass is indented under the class definition. A container for "books", rolls, and other packages of metal leaf for gilders' use.
- 77.1 WITH SOAP-HANDLING MEANS:**
This subclass is indented under the class definition. A container provided with means to facilitate the lifting or removal of a piece of soap from the container.
- 81 Combined:**
This subclass is indented under the class definition. A container designed to disclose colors or coatings, as paints, varnishes, etc., for the purpose of comparison or exhibition.
- 83 Multiple pocket or compartment:**
This subclass is indented under the class definition. A container for the display and comparison of artificial teeth.
- 83.5 FOR BALE:**
This subclass is indented under the class definition. A package comprising pressed masses of compressible material formed into packages or bales for transportation or storage and not provided for in preceding subclasses. Such bales may be either self-sustaining (e.g., having no restraining ties or receptacles) or they may include some external means for restraining the compressed mass.
- (1) Note. Relative to self-sustaining masses or blocks of compressible material in

which the specific material thus prepared for shipment or storage is significantly claimed, such subject matter is classifiable in the appropriate composition class and should be placed in this subclass only if no existing composition classification provides for the specific material or materials claimed.

SEE OR SEARCH THIS CLASS, SUBCLASS:

597, for a container with a pallet feature including a binder wrap for content.

SEE OR SEARCH CLASS:

428, Stock Material or Miscellaneous Articles, subclass 2 for bales or bundles identified as being for trash or refuse, subclass 571 for metallic stock material provided along its length with portions of reduced fracture resistance, subclass 576 for an article comprising a mass of metallic material shaped to facilitate its melting, subclass 583 for an intermediate metallic article held together by a mechanical fastener, subclass 588 for a metallic workpiece having parallel components stacked together, and subclass 594 for metallic stock having layers held together by mechanical fastening.

604, Surgery, subclasses 1+ for swabs; subclasses 286+ and 904 for tampons; subclasses 358+ for absorbent pads; and subclass 369 for foam or cellular structures, which are for surgical use but have similarities in their structure to holes.

85 WITH IGNITER FOR TOBACCO CONTENT:

This subclass is indented under the class definition. Container for tobacco or tobacco product (e.g., cigar, cigarette, pipe plug) combined with means to start combustion of said tobacco or product.

(1) Note. See subclass 86, below, for a further combinational feature relating to additional content or configuration for such content.

SEE OR SEARCH THIS CLASS, SUBCLASS:

96+, for a match packet, container or holder, per se.

242+, for a container, per se, for tobacco, pipe or cigarette.

SEE OR SEARCH CLASS:

131, Tobacco, subclass 351 for a significant tobacco product or composition combined with an ignition facilitating means; subclass 185 for a smoking device combined with an igniter; subclass 234 for a smoking device combined with an ash receiver and an igniter and subclass 249 for a cigar or cigarette end cutter combined with an igniter.

221, Article Dispensing, subclasses 136+ for an igniter combined with a cigar or cigarette dispenser.

312, Supports: Cabinet Structure, subclass 86 for a removal facilitating magazine type cabinet for a slender cylindrical article combined with an igniter.

361, Electricity: Electrical Systems and Devices, subclasses 247+ for igniting systems.

431, Combustion, subclasses 129+ and 144+ for a mechanical (e.g., fluid-flint) lighter, per se.

86 Combined:

This subclass is indented under subclass 85. Container including either (a) an additional content (article or material) or (b) an additional container configuration for such other content.

(1) Note. Such added content may be within or outside the tobacco container.

SEE OR SEARCH THIS CLASS, SUBCLASS:

102+, for a match packet or container combined with other than igniter means or ash tray.

216+, for other combinations with container or package structure.

- 87 Igniter is flint-wick type:**
This subclass is indented under subclass 85. Container wherein the combustion means is of the friction-spark and capillary-fuel-supply type.
- SEE OR SEARCH CLASS:
431, Combustion, subclasses 267+ for a friction type igniter and subclasses 298+ for a fibrous wick type flame holder.
- 88 Interrelated ignition and content access:**
This subclass is indented under subclass 87. Container wherein means for operating an igniter also exposes the tobacco content.
- 89 With common access to igniter and content:**
This subclass is indented under subclass 87. Container wherein both igniter and tobacco content are exposed by removal or displacement of the same cover element.
- 90 Igniter is match:**
This subclass is indented under subclass 85. Container wherein the combustion means is a slender piece of flammable material tipped with composition capable of igniting when said composition is abraded.
- SEE OR SEARCH THIS CLASS, SUB-CLASS:
96+, for a match packet, container or holder, per se.
- SEE OR SEARCH CLASS:
44, Fuel and Related Compositions, subclasses 507+ for a match, per se.
- 91 Inner compartment slides relative to outer:**
This subclass is indented under subclass 90. Container wherein the content holder is further encased in a translatable sleeve-like member.
- SEE OR SEARCH THIS CLASS, SUB-CLASS:
121+, for plural matches grouped in a box, per se.
- 92 Swingable container flap or cover provides access to match:**
This subclass is indented under subclass 90. Container wherein a match is exposed by pivoting a closure member.
- 93 Unitary foldable blank container and match cover unit:**
This subclass is indented under subclass 92. Container wherein both product and igniter are encased within a cover construction by erecting the scored or marked portions of a single sheet of material.
- SEE OR SEARCH CLASS:
229, Envelopes, Wrappers, and Paperboard Boxes, subclasses 100+ for a folded blank paperboard box.
- 94 Attached to or carried by external container:**
This subclass is indented under subclass 90. Container wherein a match is secured outside the content casing.
- 95 Having means to receive cover flap of match packet (e.g., tongue and slot connection):**
This subclass is indented under subclass 94. Container wherein a match securement means engages a swingable portion of a match folder.
- 96 MATCH PACKET, CONTAINER, OR HOLDER (E.G., MATCH SAFE):**
This subclass is indented under the class definition. Container for a slender piece of flammable material tipped by a combustible composition which composition is ignited by friction.
- (1) Note. Included here is a comb-type match packet, a box of loose stick matches and holder for loose matches.
- SEE OR SEARCH THIS CLASS, SUB-CLASS:
85+, for an igniter for tobacco content.
- SEE OR SEARCH CLASS:
131, Tobacco, subclasses 185, 234, 239, 249, and 251 for match, igniter or scratcher features combined with a tobacco user's appliance.

- 97 With windguard:**
This subclass is indented under subclass 96. Container including a means to shield the match flame against air current.
- SEE OR SEARCH CLASS:
431, Combustion, subclasses 350+ for a flame holder with windshield means and see search notes thereunder for the loci of other windshield structure.
- 98 Striker surface in withdrawal path of match:**
This subclass is indented under subclass 96. Container wherein a friction or scratch surface is contacted by a match tip as said match is removed from its holder.
- SEE OR SEARCH CLASS:
131, Tobacco, subclass 351 for a tipped tobacco product ignited by a withdrawal of said product from its holder.
- 99 Match comb type:**
This subclass is indented under subclass 98. Container wherein the match is one of plural matches whose individual elongated bodies are formed by parallel slits in an edge of a sheet or card to constitute tooth-like projections secured to a unitary base, back, or strip; which back or base portion is secured to a cover member.
- SEE OR SEARCH THIS CLASS, SUB-CLASS:
103, for disparate articles combined with a comb-type match packet.
104, for a comb-type match pocket.
- 100 Opposed striker surfaces:**
This subclass is indented under subclass 98. Container wherein there are two spaced friction or scratch surfaces between which a match tip moves.
- (1) Note. A corrugated striker surface is considered to provide "opposed striker surfaces".
- 101 Means to secure to person or garment:**
This subclass is indented under subclass 96. Container including means to fasten the container packet to the human body or clothing.
- (1) Note. Included here are means to secure a match holder to a dress, skirt or that, or as to a finger ring mounting.
- 102 With disparate article, article receiver or display feature (not ash tray or tobacco):**
This subclass is indented under subclass 96. Container combined with (a) means to hold an article other than a match, tobacco product or debris; e.g., toothpick, notepaper or (b) means to facilitate visual exposure of content or adverting material.
- 103 Match comb type:**
This subclass is indented under subclass 102. Container wherein the match is one of plural matches whose individual elongated bodies are formed by parallel slits in an edge of a sheet or card to constitute tooth-like projections secured to a unitary base, back or strip.
- SEE OR SEARCH THIS CLASS, SUB-CLASS:
99, for a comb-type match packet with the striker surface in the withdrawal path of the match.
104, for a comb-type match packet.
- 104 Match comb type:**
This subclass is indented under subclass 96. Container wherein the match is one of plural matches whose individual elongated bodies are formed by parallel slits in an edge of a sheet or card to constitute tooth-like projections secured to a unitary base, back or strip.
- SEE OR SEARCH THIS CLASS, SUB-CLASS:
99, for a comb-type match packet with the striker surface in the withdrawal path of the match.
103, for a comb-type match packet combined with a disparate article or display feature.
- SEE OR SEARCH CLASS:
44, Fuel and Related Compositions, subclass 509 for a match card, per se.
- 105 Plural 'books':**
This subclass is indented under subclass 104. Container for two or more packets; i.e., each match comb or set of match combs, has its own

- cover structure in addition to means holding the packets together.
- SEE OR SEARCH THIS CLASS, SUB-CLASS:
122, for plural boxes.
- 106 With accidental ignition prevention means or arrangement:**
This subclass is indented under subclass 104. Container including structure or relative arrangement, other than a mere packet cover, to prevent unintended combustion of remaining matches in a packet while one match is being ignited.
- 107 Discrete holder:**
This subclass is indented under subclass 106. Container including a separate case or retainer for the packet.
- SEE OR SEARCH THIS CLASS, SUB-CLASS:
118, for a comb-type match packet with a discrete holder.
- 108 Striker surface guard or shield:**
This subclass is indented under subclass 106. Container including a means, or structure, to protect or cover the friction surface or portion of the packet.
- 109 Groove or opposed surfaces:**
This subclass is indented under subclass 108. Container wherein the friction portion is recessed or consists of parallel spaced elements.
- SEE OR SEARCH THIS CLASS, SUB-CLASS:
100, for an opposed striker surface structure in the withdrawal path of a match.
- 110 Slide or pivot of match comb:**
This subclass is indented under subclass 108. Container including means to translate or rotate the remaining matches.
- 111 Nonflap type:**
This subclass is indented under subclass 106. Container wherein the cover or case for the matches is other than a "book" or ply or folder type.
- 112 Striker surface on outside of cover flap:**
This subclass is indented under subclass 106. Container wherein a friction surface is exterior of the ply, or folder portion, enclosing the match head.
- (1) Note. In the typical comb-type match packet the match comb is secured between a "tuck" flap and an extended "cover" which is folder over the match and match head back to the tuck flap with the cover end inserted between the comb and the tuck flap. The cover end portion engaging under the tuck flap is called the "cover flap". The exterior of the tuck flap is usually treated to serve as a striker surface.
- 113 Access through tuck-flap aperture:**
This subclass is indented under subclass 112. Container wherein the friction surface is at the outer end of the cover flap and is exposed by an opening in the tuck flap.
- 114 At comb back:**
This subclass is indented under subclass 112. Container wherein the friction surface is at the outer end of the cover adjacent the comb-cover securement.
- 115 Match-head shield:**
This subclass is indented under subclass 106. Container including a distinct means to cover or enclose the combustion composition at the tip of the match.
- (1) Note. The "distinct" means is in addition to the folder or cover ply of the usual match packet.
- 116 Pivotaly mounted comb:**
This subclass is indented under subclass 104. Container wherein the match comb is rotatably, or swing, mounted for access.
- 117 With integral debris receiver:**
This subclass is indented under subclass 104. Container including a unitary holder for spent matches or other trash.

- 118 Discrete case for book:**
This subclass is indented under subclass 104. Container including a separate case or retainer for the match packet-usually for pocket or purse.
- SEE OR SEARCH THIS CLASS, SUB-CLASS:
107, for an accidental ignition prevention means with a discrete holder.
131, for a match box with a discrete case.
- 119 Attachment means:**
This subclass is indented under subclass 104. Container including means to fasten or secure the packet to an article.
- SEE OR SEARCH THIS CLASS, SUB-CLASS:
101, for means to secure a match container to the body or cloth.
- 120 For ash tray:**
This subclass is indented under subclass 119. Container wherein the article is a receiver for burnt tobacco product.
- 121 Plural matches grouped in box:**
This subclass is indented under subclass 96. Container wherein an assemblage of matches are substantially completely wrapped or encased for shipment, sale, display or storage.
- (1) Note. The term "box" includes a tray with a slide sleeve cover, a tray with a hinged or pivoted lid, or a tray, per se.
- SEE OR SEARCH THIS CLASS, SUB-CLASS:
134+, for loose matches exposed in a holder for use.
- 122 Plural boxes grouped in box:**
This subclass is indented under subclass 121. Container for two or more boxes; i.e., each assemblage of matches has its own cover structure in addition to means holding the boxes together.
- SEE OR SEARCH THIS CLASS, SUB-CLASS:
105, for plural comb-type match packets.
- 123 Gravity feed to access port:**
This subclass is indented under subclass 121. Container including structure which allows matches to move, by their own mass, toward a low-positioned opening from which they may be removed from the box.
- 124 Convertible from box:**
This subclass is indented under subclass 123. Container wherein match box structure may be rearranged to provide match feed toward a removal opening.
- SEE OR SEARCH THIS CLASS, SUB-CLASS:
128, for match box structure which may be rearranged to provide support means for the box.
- 125 With debris receiver:**
This subclass is indented under subclass 123. Container including holder for spent matches or other trash.
- SEE OR SEARCH THIS CLASS, SUB-CLASS:
130, for a match box support means with a debris receiver.
132, for a discrete match box case including a debris receiver.
133, for a match box with a debris receiver.
135, for a support for loose matches with a debris receiver.
136, for match packet with a debris receiver.
246, for a tobacco, pipe or cigarette holder with an ash receiver.
567, for a tray-type container for refuse.
- SEE OR SEARCH CLASS:
131, Tobacco, appropriate subclasses for other combinations with an ash receiver.
- 126 Mechanistic means to raise content:**
This subclass is indented under subclass 121. Container including structural means to move a match at least partially up out of its container.
- (1) Note. Mechanistic is used to exclude a mere access opening through which one may shift the position of contents. Such

an opening may be found elsewhere on the basis of other structure.

SEE OR SEARCH THIS CLASS, SUBCLASS:

129, for means to hold a match partially exposed in a box so that it may be readily removed.

127 With means to support or attach box:

This subclass is indented under subclass 121. Container including structure to retain the match box in desired position.

(1) Note. Include here is a support means for a match tray, per se, or a match tray and its slide cover. The slide cover, itself, is not a support means for this subclass.

SEE OR SEARCH THIS CLASS, SUBCLASS:

119+, for attachment means for a comb-type match packet.

121, for a match tray and slide cover, per se.

131+, for a discrete case for a box of matches.

128 Convertible from box:

This subclass is indented under subclass 127. Container wherein match box structure may be rearranged to provide box retainer means.

SEE OR SEARCH THIS CLASS, SUBCLASS:

124, for match box structure which may be rearranged to provide gravity match feed to an access part.

129 With means to expose match:

This subclass is indented under subclass 127. Container including means to make the match content accessible.

SEE OR SEARCH THIS CLASS, SUBCLASS:

121, for a match tray in a slide cover.

130 Including debris receiver:

This subclass is indented under subclass 127. Container having a holder for spent matches or other trash.

(1) Note. See search notes under subclass 125, for the locus of other debris receivers.

131 With discrete case for box:

This subclass is indented under subclass 121. Container including a separate case or retainer for the match box-usually for pocket or purse.

SEE OR SEARCH THIS CLASS, SUBCLASS:

107, for an accidental ignition prevention means with a discrete holder.

118, for a comb-type match packet with a discrete case.

121, for a match tray in a slide cover.

132 Including debris receiver:

This subclass is indented under subclass 131. Container having a holder for spent matches or other trash.

(1) Note. See search notes under subclass 125 for the locus of other debris receivers.

133 With debris receiver:

This subclass is indented under subclass 121. Container including a holder for spent matches or other trash.

(1) Note. See search notes under subclass 125 for the locus of other debris receivers.

134 With support or attachment means (for loose matches):

This subclass is indented under subclass 96. Container consisting of structure to hold or position a plurality of individual matches or matches loosely grouped.

SEE OR SEARCH THIS CLASS, SUBCLASS:

127+, for similar means to hold a box of matches.

135 With debris receiver:

This subclass is indented under subclass 134. Container including a holder for spent matches or other trash.

- (1) Note. See search notes under subclass 125 for the locus of other debris receivers.
- 136 With debris receiver:**
This subclass is indented under subclass 96. Container including a holder for spent matches or other debris.
- (1) Note. See search notes under subclass 125 for the locus of other debris receivers.
- 137 With separate striker member:**
This subclass is indented under subclass 96. Container including a distinct friction or scratch surface removable attached to the container.
- 138 Magazine supply:**
This subclass is indented under subclass 137. Container wherein a friction surface is provided in plural strip, or roll, form so that an unused portion may be shifted into operation position.
- 139 PORTABLE SEGREGATING CARRIER FOR PLURAL CYLINDRICAL BEVERAGE-TYPE RECEPTACLES (E.G., BEER CANS, POP BOTTLES):**
This subclass is indented under the class definition. A transport device, receiver or carrier for two or more cylinder-like containers for potable liquid including both (a) means to maintain a desired spacing, or relative position, between at least two of said containers and (b) hand or finger engaging means to pendulously support the device.
- (1) Note. Included here as “cylinder-like containers for potable liquid” are: beer cans, soda pop bottles, food cans, drinking mugs or glass tumblers.
- (2) Note. The use of such terms as “upper”, “lower”, “top”, “bottom”, etc., refer to the parts of the carrier in normal transport orientation.
- SEE OR SEARCH THIS CLASS, SUBCLASS:
427+, for a similar receiver without spacer means or pendulous hand support means.
561, for a tray-type container including partition means.
562, for a tray-type container including an aperture to hold an article.
- SEE OR SEARCH CLASS:
229, Envelopes, Wrappers, and Paperboard Boxes, subclass 934 for a cross-reference art collection of plural blanks of paperboard or similar material intended for use as a partitioned receptacle to transport bottles.
- 140 Noncollapsible carrier with tongue and aperture-type interlock between exterior walls:**
This subclass is indented under subclass 139. A carrier configured to keep its erected form, once assembled, and having wall panels extending around at least a portion of each retained receptacle a structure tab or edge on one of said panels being engaged in a slot, notch or aperture in another of said panels to secure the panels together.
- SEE OR SEARCH THIS CLASS, SUBCLASS:
171+, for a collapsible carrier having a similar type interlock.
- 141 Handle struck from top wall:**
This subclass is indented under subclass 139. A carrier including a flap portion, formed by a cut in and spaced from the edge of a portion of an upper panel of the carrier, and deflected from the plane of said panel for manual engagement.
- (1) Note. As the cut is spaced from an edge of said panel this subclass includes a handle formed from a panel doubled upon itself where the cut extends to the crease or fold line.

- 142 Handle retainer container mutually coact for grasping receptacles:**
This subclass is indented under subclass 139. A carrier wherein articulation between carrier and manual carrier support means plus contact with contents, effected by manual lift of said carrier support means, retains or further secures the carrier content.
- SEE OR SEARCH CLASS:
294, Handling: Hand and Hoist-Line Implements, subclass 164 for hand-held article carriers wherein the article gripping or retaining means is actuated by lifting the handle.
- 143 Handle means interposed between receptacles:**
This subclass is indented under subclass 142. A carrier wherein opposite face portions of the manual carrier support means are sandwiched by adjacent containers.
- 144 Interlocking carriers:**
This subclass is indented under subclass 139. A carrier including means connecting or joining one carrier to another for common transport.
- 145 Receptacle chime, or closure cap flange, engaging type (e.g., 'six-pack'):**
This subclass is indented under subclass 139. A carrier which holds the contents by contact with (a) a bead or flanged extending radially outwardly from the end portion of each container, (b) a similar bead or flange or edge of the container closure or (c) a radial projection adjacent the end portion of each container.
- SEE OR SEARCH CLASS:
294, Handling: Hand and Hoist-Line Implements, subclass 87.2 for hand-held carriers for plural beverage containers and which engage a chime or flange on the container. Those carriers found in Class 294 are neither of the receptacle or the mercantile unit type.
- 146 Having additional retainer for disparate article:**
This subclass is indented under subclass 145. A carrier including a further means to secure or hold a different thing; e.g., a can opener.
- SEE OR SEARCH THIS CLASS, SUBCLASS:
216+, for a container or retainer to hold diverse articles.
- 147 Unitary retainer or foldable blank packaging unit:**
This subclass is indented under subclass 145. A carrier formed from (a) a panel with contour, aperture or tab elements, (b) a sheath, sleeve or tube, (c) an erectable scored or crease-marked sheet of material or (d) a strand, band or filamentary-like member.
- (1) Note. The sheath, sleeve, band or tube is usually seamless, resilient and embraces the containers so that each and all are yieldably retained.
- SEE OR SEARCH CLASS:
229, Envelopes, Wrappers, and Paperboard Boxes, subclasses 100+ for a folded blank paperboard box.
- 148 Inwardly struck tab engages radially extending shoulder of chime or edge of cap skirt:**
This subclass is indented under subclass 147. A carrier having a flap, cut and folded inside the carrier, and generally parallel to the cylindrical axis of the containers, to contact the chime, cap skirt or container projection.
- (1) Note. The contact is made between flap and outward enlargement normal to the cylindrical surface.
- 149 Inwardly struck tab engages inner cylindrical surface of chime:**
This subclass is indented under subclass 147. A carrier having a flap, cut and folded inside the carrier, and generally parallel to the radial end of the containers, to contact the chime or cap skirt.

- (1) Note. The contact is made between flap and inner cylindrical surface on the end of the container or closure.
- 150 Band or strand type:**
This subclass is indented under subclass 147. A carrier including a flexible web, or strip, loop engaging outer cylindrical surfaces of containers and with at least one edge abutting radial surfaces of the chime or cap flange.
- 151 Unitary retainer grips chime perimetrically:**
This subclass is indented under subclass 147. A carrier including portions which resiliently clasp a bead (or closure flange) around substantially the entire circumference thereof.
- (1) Note. Included here is a carrier which grips only a diametrically opposed points on the perimeter.
- 152 Slots spaced along fold line from retaining apertures:**
This subclass is indented under subclass 147. A carrier including intermittent cuts or openings along a score or crease line, the edges of said cuts engage the chime or flange portions of the containers.
- (1) Note. The cuts, slots, or openings-provided for in this subclass-merely allow for limited protrusion of container elements.
- SEE OR SEARCH THIS CLASS, SUBCLASS:
158, for an aperture in carrier structure which embraces a whole container.
197, for a positioning cutout in a carrier wall which partially engages the outer cylindrical surface of a chime or closure cap.
- 153 Only one end of retained receptacles engaged:**
This subclass is indented under subclass 152. A carrier wherein merely a single extremity of plural containers are held or positioned.
- 154 Chimes at both ends of retained receptacle held in slots:**
This subclass is indented under subclass 152. A carrier wherein the beads or flanges at opposite extremities of plural containers are held or positioned.
- 155 Sleeve-type container with end walls:**
This subclass is indented under subclass 152. A carrier including terminal panels partially, or completely, closing the carrier.
- (1) Note. Generally, the terminal panels are normal to the cylindrical axes of the containers.
- 156 Retaining flap includes periphery of blank:**
This subclass is indented under subclass 147. A carrier including a hinged end portion of the sheet material, which portion provides the chime or flange engaging holder.
- SEE OR SEARCH THIS CLASS, SUBCLASS:
147, for a similar retaining flap not forming an end portion of the blank.
- 157 Flap projects between rows of receptacles:**
This subclass is indented under subclass 156. A carrier wherein the hinged end portion is sandwiched by files of containers.
- 158 Rim of aperture in horizontal wall engages chime:**
This subclass is indented under subclass 147. A carrier wherein edge portions of an opening in an upwardly facing panel (i.e., in the usual carrying position of the carrier) encircles the cylindrical surface of a container and bear against the bead or flange of said container or closure thereof.
- 159 Clip-type retainer interlocks with chimes of juxtaposed receptacles:**
This subclass is indented under subclass 145. A carrier including a plurality of clasping or gripping holders acting in pairs or sets - which clench onto the beads or flanges of adjacent containers to maintain their side-by-side relationship.

160 Spacer abuts side and chimes of receptacles:

This subclass is indented under subclass 145. A carrier including means interposed between containers, to maintain relative positions thereof, which means also engages the end beads or flanges of said containers.

161 Finger-hole carrier means:

This subclass is indented under subclass 145. A carrier including at least one specific aperture for manual support or handling of said carrier and its contents.

162 Pendent from handle:

This subclass is indented under subclass 139. A carrier including a means disposed at the carrier top (i.e., in the usual carrying position of said carrier) for manual engagement so that in normal use the carrier is suspended below said means.

SEE OR SEARCH CLASS:

294, Handling: Hand and Hoist-Line Implements, subclasses 27.1+ for a lifter or carrier for a single container; and subclasses 87.1+ for a lifter or carrier for plural containers (e.g., bottles).

163 Handle bodily shiftable vertically:

This subclass is indented under subclass 162. A carrier wherein the handle means can be moved up or down with respect to the carrier—usually between the containers.

(1) Note. This shift adjustment is usually for the purpose of carrier stacking.

SEE OR SEARCH THIS CLASS, SUBCLASS:

503+, for structural features for vertical stacking of similar receptacles.

164 With hooked end:

This subclass is indented under subclass 162. A container wherein the handle means includes an elongated bent end engaging the carrier.

165 Panel type:

This subclass is indented under subclass 163. A carrier wherein the handle means is (a) a plate-like member with an aperture for manual

engagement or (b) secured to a plate-like member for movement therewith.

166 Retractable into carrier:

This subclass is indented under subclass 165. A carrier wherein the upper edge of the panel type handle can shift below, or even with, the upper edge of the carrier structure.

(1) Note. Included here is a carton, or a generally four-walled carrier with a bottom, wherein the plate-like handle can be shifted within the walls.

167 Part movable to receptacle loading position:

This subclass is indented under subclass 162. A carrier so articulated, or readily foldable, that portion may be relatively shifted to then permit insertion or removal of the containers.

(1) Note. A movable closure or barrier across all, or part, of the egress path is one form of such articulated portion.

168 Bottle neck engaged in wall aperture:

This subclass is indented under subclass 167. A carrier including a panel or flap with at least one opening to receive the reduced-diameter outlet portion of a bottle.

169 Retained in carrying position by handle:

This subclass is indented under subclass 167. A container wherein the means for manual engagement assumes a position for normal transport whereby containers cannot be removed.

(1) Note. Included here is a container where the handle causes side walls to move inwardly as the handle is lifted.

170 Collapsible:

This subclass is indented under subclass 162. A carrier so articulated, or readily foldable, that in a nonuse state (i.e., without containers) it may be repeatedly rearranged without destroying a joint into a relatively flat or compact form for shipment storage.

(1) Note. Merely disassembling an interfitted or interlocked joint— which joint can subsequently be interlocked again by relative position of its element is not “destroying” in the sense of tearing,

delaminating, deforming (beyond elastic limits), or removal of separate fastener elements.

SEE OR SEARCH THIS CLASS, SUB-CLASS:

193+, for a carrier erected from a folded blank which may be restored to its blank form without destroying any joint structure.

171 Having anticollapse latch:

This subclass is indented under subclass 170. A carrier including a disengageable member which in its engaged position maintains the carrier in an erect or container receiving condition.

(1) Note. See (1) Note under subclass 170.

172 Involving middle wall:

This subclass is indented under subclass 171. A carrier including as an element of the latch means, a panel normal to the base or carrier bottom and straddled by the containers therein.

(1) Note. Generally, the term "middle wall" is used with reference to a segregating panel medially situated between and parallel to, the container sides. (See sketch under subclass 175). In the oblong type carrier a segregating panel parallel to the longer length is called a middle or center wall while the shorter segregating cross panel is called a transverse, separator or strap wall.

173 Interlock with bottom:

This subclass is indented under subclass 172. A carrier wherein the interengagement of middle wall and base, or bottom, constitutes the latch means.

174 Individual receptacle positioning means:

This subclass is indented under subclass 170. A carrier including a spacer or holding means for each of the containers therein.

175 Folded blank type:

This subclass is indented under subclass 174. A carrier formed from an erectable scored or crease-marked sheet of material.

(1) Note. The walls, panels, flaps and other carrier portions of the erected carrier are integral along fold lines and not made of separate pieces secured together.

Nomenclature Note. Shown below is atypical erected carrier and the terms applied to the several parts thereof.

SEE OR SEARCH THIS CLASS, SUB-CLASS:

193+, for a noncollapsible folded blank type carrier.

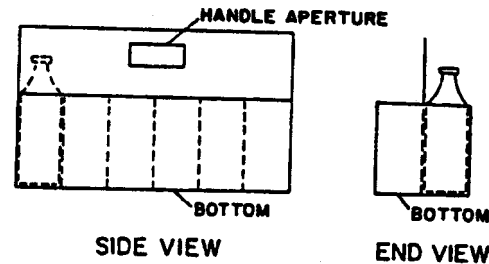
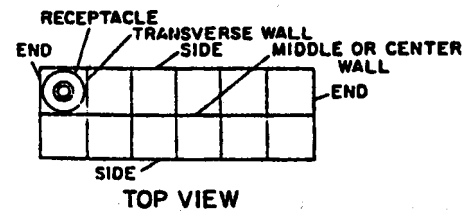

176 Multiple blanks:

This subclass is indented under subclass 175. A carrier formed of a plurality of sheets.

177 Severable blank:

This subclass is indented under subclass 176. A carrier including at least two portions of the erected structure formed by separation from a folded sheet; e.g., a handle member pushed out of a center or middle carrier partition.

178 Separate blank forms transverse wall:

This subclass is indented under subclass 176. A carrier wherein a transverse wall is formed from a sheet other than the sheet forming the side walls of the carrier.

179 U-shaped member:

This subclass is indented under subclass 178. A carrier wherein the separate sheet has a mid-portion parallel to and adjacent, the base (or

middle wall) with two-leg portions erected parallel to each other - said erected portions being normal to the base and parallel to the carrier ends - constituting the transverse separators for containers.

- (1) Note. Such U-shaped member may (a) be slit to straddle the middle or center wall or (b) be at the upper side of the carrier base or have the legs projected through slots in the base.

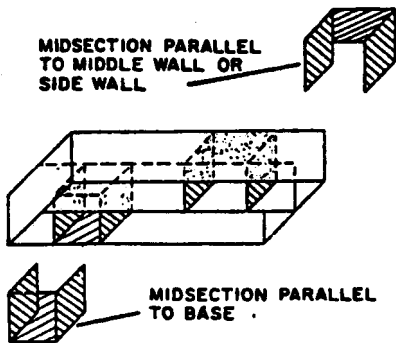

180 Center wall:
This subclass is indented under subclass 175. A carrier including a panel or panel portions, forming a partition medially situated between and parallel to walls of the carrier.

181 Horizontally and vertically folded slide flap forms transverse wall:
This subclass is indented under subclass 180. A carrier including a strap or separator panel erected from an integral extension of a side wall, (a) a first portion doubled up face to face with said side wall (b) and a second portion extending normal to both said doubled portion and the carrier base.

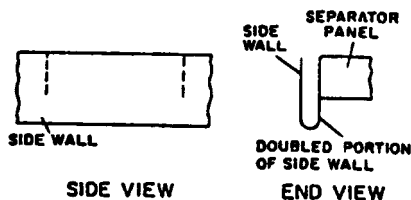

182 Single center wall folded from bottom:
This subclass is indented under subclass 180. A carrier wherein there is only one middle panel erected from a base panel.

183 Confronting center walls folded from bottom:

This subclass is indented under subclass 180. A carrier including a pair of face to face middle panels erected from separate portions of the base.

184 Lower margins of center walls connected at horizontal fold:

This subclass is indented under subclass 180. A carrier including a middle panel generally extending directly from an end or transverse panel, doubled upwardly upon itself along a line parallel to the carrier base.

- (1) Note. A flap folded from a middle panel through a handgrip opening and thence upward from said opening is not considered to constitute a middle panel double upon itself.

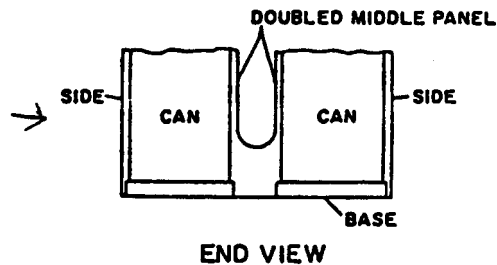

185 Center walls connected at vertically extending fold, one free end wall:

This subclass is indented under subclass 180. A carrier including a middle panel extending from an end panel and doubled upon itself along a line normal, or oblique, to the carrier base.

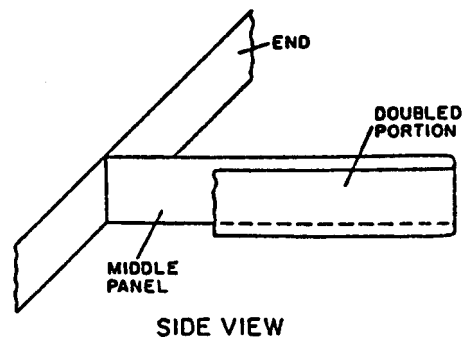

- 186 One center wall folded on horizontal line:**
This subclass is indented under subclass 185. A carrier wherein the middle panel portion, directly erected from the end panel, includes a further panel portion, either panel portion may be doubled downwardly along a line parallel to the base.

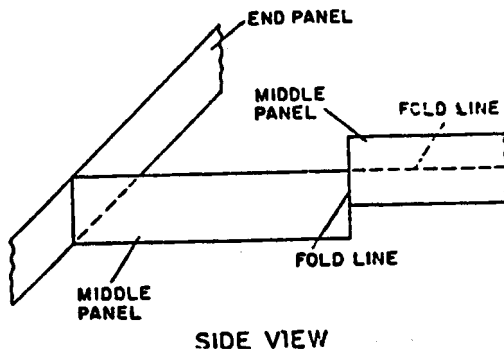

- 187 Two center walls folded on horizontal line:**
This subclass is indented under subclass 186. A carrier wherein the middle panel portion remote from the end panel, and doubled along a line normal to the carrier base, also includes a further panel portion doubled downwardly along a line parallel to the base.
- 188 Doubled center walls folded from different end walls:**
This subclass is indented under subclass 180. A carrier including middle panels extending from opposite end panels, each middle panel doubled downwardly upon itself along a line parallel to the carrier base.
- 189 Sidewalls folded from unitary bottom wall:**
This subclass is indented under subclass 180. A carrier wherein the carrier base is integral with and erected from side panels.
- 190 Transverse wall folded from center wall only:**
This subclass is indented under subclass 189. A carrier wherein a strap or separator panel, on one side of a middle panel, is erected from said middle panel along a crease line substantially normal to the carrier base.

(1) Note. The strap end, remote from the crease line, may be free or secured (sta-

pled or adhered) to an adjacent side panel.

- 191 Transverse wall folded from center wall and sidewall:**
This subclass is indented under subclass 189. A carrier wherein a strap or separator panel, on one side of a middle panel, is erected from both said middle panel and side panel along crease lines substantially normal to the carrier base.
- 192 Divisible carrier:**
This subclass is indented under subclass 162. A carrier which can be separated into two or more smaller carrier units; e.g., with weakened wall portion which can be torn or broken to create two six packs from a twelve pack carton.
- 193 Folded blank with means for receptacle compartment or spacer:**
This subclass is indented under subclass 162. A carrier formed from an erectable scored or crease-marked sheet of material.
- SEE OR SEARCH THIS CLASS, SUBCLASS:
175+, for a collapsible folded blank type carrier.
- 194 With apertured receptacle retaining wall:**
This subclass is indented under subclass 193. A carrier including a panel with an opening which encircles the cylindrical surface of a container.
- (1) Note. Included here is a carrier wherein two panels, each with a notch-like opening along edge, overlap or abut to encircle the container.
- SEE OR SEARCH THIS CLASS, SUBCLASS:
199, for a nonfolded blank carrier with an apertured panel to retain containers.
- 195 Multiple receptacles in single aperture:**
This subclass is indented under subclass 194. A carrier wherein a panel opening retains two or more containers.

- 196 With additional receptacle separator:**
This subclass is indented under subclass 194. A carrier including a distinct means, other than the panel opening, to space or retain a container relative to another container.
- 197 With positioning cutout:**
This subclass is indented under subclass 193. A carrier including a panel slot or opening which engages the outer cylindrical surface of a side portion of a container, container bead or flange, or a container closure cap.
- SEE OR SEARCH THIS CLASS, SUB-CLASS:
152+, for a carrier with spaced slots to secure the chimes or caps of retained containers by engagement which radial surface portions of said elements.
- 198 Tray with center wall forming a handle:**
This subclass is indented under subclass 193. A carrier wherein the erected carrier is an open-topped shallow box with a middle panel-between container rows normal to the carrier base and including manual grip means at the upper portion of said panel.
- 199 Having apertured panel for receptacle:**
This subclass is indented under subclass 162. A carrier including a plate with one or more openings each of which embraces a container.
- SEE OR SEARCH THIS CLASS, SUB-CLASS:
194+, for a folded blank carrier with an apertured panel to retain containers.
- 200 Folded blank carrier with applied handle:**
This subclass is indented under subclass 162. A carrier wherein a carrier erected from a scored or crease-marked sheet includes a distinct manual grip portion secured to said sheet.
- 201 Rigid grid support and retainer:**
This subclass is indented under subclass 162. A carrier wherein the container base or positioning means is an openwork, nonflaccid panel.
- 202 Formed of wire:**
This subclass is indented under subclass 201. A carrier wherein the openwork panel is made of attenuated metal strands or rods.
- 203 Molded plastic tray:**
This subclass is indented under subclass 162. A carrier wherein the carrier is a relatively shallow, open-topped, box of nonmetallic material cast into shape.
- (1) Note. Included here is a box distinguished from a "tray" only by the relative height of the side or end walls.
- SEE OR SEARCH THIS CLASS, SUB-CLASS:
561, for a partitioned container of the tray type.
- 204 WITH MOISTURE ABSORBENT:**
This subclass is indented under the class definition. Container including means for removing water; or water vapor, from the atmosphere within a container or the surface of container content.
- 205 INCLUDING ANCILLARY ARTICLE CONTACTING MEDIUM:**
This subclass is indented under the class definition. A container with a distinct agent or material within which, or against which, content (as article or material) is maintained or copackaged.
- (1) Note. Such material includes an absorbent (other than moisture absorbent), a solvent, a lubricant, an abradant, etc.
- SEE OR SEARCH THIS CLASS, SUB-CLASS:
.6, for a container for gas.
204, for a container with a moisture absorbent.
- SEE OR SEARCH CLASS:
312, Supports: Cabinet Structure, subclasses 31+ for a container with means to treat the contents with a gas or vapor.

206 For fastener:

This subclass is indented under subclass 205. A container, arranged (either as to shape, interior arrangement, or retaining device) for holding a securement means.

SEE OR SEARCH THIS CLASS, SUB-CLASS:

338+, for a container for a fastener.

207 For tool or appliance:

This subclass is indented under subclass 205. A container arranged (either as to shape, interior arrangement, or retaining devices) for holding a tool or an appliance.

(1) Note. See notes under subclass 349 for details as to “tool”, “implement” or “appliance”.

SEE OR SEARCH THIS CLASS, SUB-CLASS:

349+, for a tool container.

208 Razor:

This subclass is indented under subclass 207. A container for a cutting instrumentality for shaving.

SEE OR SEARCH THIS CLASS, SUB-CLASS:

351, for a container for a powered razor.

352+, for a container for a razor blade.

SEE OR SEARCH CLASS:

30, Cutlery, subclasses 32+ for a razor, per se.

209 Brush:

This subclass is indented under subclass 207. Container for a bristle-like implement for cleaning or coating.

(1) Note. Included here is a swab or sponge.

SEE OR SEARCH THIS CLASS, SUB-CLASS:

361+, for a brush container.

SEE OR SEARCH CLASS:

15, Brushing, Scrubbing, and General Cleaning, for a brush, per se.

209.1 Transverse bristle:

This subclass is indented under subclass 209. A container wherein work contacting elements of the brush are normal to the extent of the handle, e.g., a tooth brush.

SEE OR SEARCH THIS CLASS, SUB-CLASS:

362.1, and 362.2, for other transverse bristle containers.

210 Body treatment:

This subclass is indented under subclass 207. A container wherein the tool or instrumentality is employed for medical or dental purposes.

(1) Note. See (1) Note under subclass 363 for scope of “body treatment”, and search notes for related art.

(2) Note. A thermometer is considered to be primarily a measuring instrument and a container for the same is to be found in subclass 212 and subclass 306.

211 For spark plug:

This subclass is indented under subclass 205. A container for a space-jumping spark device commonly used for internal combustion engine ignition.

SEE OR SEARCH THIS CLASS, SUB-CLASS:

327, for a spark plug container, without a contacting medium.

SEE OR SEARCH CLASS:

313, Electric Lamp and Discharge Devices, subclasses 118+ for a spark plug, per se.

212 For thermometer:

This subclass is indented under subclass 205. A container wherein the article is an instrumentality for measuring temperature.

SEE OR SEARCH THIS CLASS, SUB-CLASS:

306, for a container for a thermometer, per se.

213 For apparel:

This subclass is indented under subclass 205. A container wherein the content is an article of clothing, e.g., garment, headwear, footwear.

- (1) Note. Included here is a container for apparel (a) with an insect repellent, or with (b) specific provision for holding such insect repellent.

SEE OR SEARCH THIS CLASS, SUB-CLASS:

278+, for an apparel container.

213.1 Gas medium:

This subclass is indented under subclass 205. A container wherein the ancillary agent is in gaseous or vapor form.

- (1) Note. Subclasses .6+ for patents for a gas container is distinguished from this subclass on disclosure and/or claim as primarily intended for a gas content, while the subclass (213.1) is primarily intended for nongas content plus some "ancillary" gas.
- (2) Note. Some liquid agents may inherently also include a vapor phase, however, unless so specifically recited such agents will not be considered as proper for original classification in this subclass (213.1).

SEE OR SEARCH CLASS:

312, Supports: Cabinet Structure, subclasses 31+ for a cabinet with gas or vapor treatment means.

214 FOR PLURAL STATIONERY IMPLEMENTS:

This subclass is indented under the class definition. A container adapted to house a plurality of implements for (or articles related to) a writing operation, which container includes means for maintaining at least two dissimilar implements or articles apart from one another.

- (1) Note. Included here is a combination of pen and pencil or crayon.

SEE OR SEARCH THIS CLASS, SUB-CLASS:

371, for a container for a desk-clerical or draftsman tool.

SEE OR SEARCH CLASS:

211, Supports: Racks, subclasses 69.1+, for a rack to support writing implements.

215 FOR STATIONERY OR CARBON PAPER:

This subclass is indented under the class definition. A container for (a) sets or correspondence material (i.e., writing paper and/or envelopes) or (b) coated, or treated, paper used to transfer writing or typing onto another underlying surface by pressure of the writing or typing action.

- (1) Note. Included here is a container for a greeting card and an envelope.

SEE OR SEARCH THIS CLASS, SUB-CLASS:

449+, for a container of sheet paper, per se.

216 COMBINED OR CONVERTIBLE:

This subclass is indented under the class definition. A container either (a) for two or more diverse articles (or materials), or (b) wherein the container is structured so that at least a portion thereof is capable of rearrangement for a secondary purpose.

- (1) Note. A mere compartmented container is not considered "combined" and is classified on other features.
- (2) Note. A provision for refuse (trash, ash, spent items, etc.) is also not considered a "combination" feature. See notes under subclass 125 for the locus of debris receivers.
- (3) Note. A container for a named or unnamed article or material combined with a second article or material is classified here; e.g., a container for cigarettes with a clock mounted on the container.

- SEE OR SEARCH THIS CLASS, SUB-CLASS:
 .81, for a coin container combination.
 86, for an igniter for tobacco content combined with other articles.
 102+, for a match packet combination.
 736+, for a container convertible to or from a display.
- 217 Including drinking vessel:**
 This subclass is indented under subclass 216. A container wherein at least one article is a beverage-holding member from which the beverage is consumed.
- SEE OR SEARCH THIS CLASS, SUB-CLASS:
 139+, for a portable segregating carrier for plural cylindrical beverage type receptacles.
 426, for a stemware container, type receptacles.
 427+, for a container for plural beverage-type receptacles.
- 218 Collapsible:**
 This subclass is indented under subclass 217. A container wherein the drinking vessel can be folded, telescoped or otherwise reduced in size when not being used.
- 219 FOR MIXING:**
 This subclass is indented under the class definition. A container for two or more separated materials, which container is modified to permit commingling of said materials by manipulation of said container or a portion thereof.
- SEE OR SEARCH THIS CLASS, SUB-CLASS:
 568, for a container with two or more separate materials to be commingled external of said container. For example, a partitioned can for pigment and oil to be mixed together in another can.
- SEE OR SEARCH CLASS:
 62, Refrigeration, subclass 4 similar subject matter, comprising a chemical cooler (endothermic process).
- 126, Stoves and Furnaces, subclasses 263.01+ for similar subject matter, comprising a chemical heater (exothermic process).
- 220 Including free mixing element (e.g., pestle):**
 This subclass is indented under subclass 219. A container which also encompasses an unrestrained body for agitation of contents.
- 221 Means to manipulate without rupture:**
 This subclass is indented under subclass 219. A container configured to allow commingling of contents without tearing or breaking of a container partition.
- 222 Tear strip or piercer:**
 This subclass is indented under subclass 219. A container with a rip, shear, or punch means to rupture a container partition.
- SEE OR SEARCH THIS CLASS, SUB-CLASS:
 532, for a container with rupture means.
- 223 Packaged assemblage or kit:**
 This subclass is indented under subclass 216. A container wherein the two or more diverse contents are (a) useable in concert to effect a unitary result (e.g., toweling and soap, wrapping paper with string and ribbon) or (b) the disassembled parts of an article.
- (1) Note. Included here is a assemblage of articles used in concert toward some common end and not elsewhere classified.
- (2) Note. A container for plural of diverse "tools" is classifiable elsewhere. Such collection per se is not considered a "kit" for subclasses 223+.
- SEE OR SEARCH THIS CLASS, SUB-CLASS:
 349+, see (1) Note of subclass 349 for a definition of "tool".
- 224 Draftsman or lettering:**
 This subclass is indented under subclass 223. A container for diverse instrumentalities used in making an engineering drawing or the reference symbols for said drawing.

- (1) Note. This subclass is the residual locus for a container for a lettering kit whether used for engineering drawing or any title.
- SEE OR SEARCH THIS CLASS, SUB-CLASS:
 1.7+, for a container for artist equipment.
 214, for a container for plural stationery implements.
- 225 Including wound, or rolled, weblike material:**
 This subclass is indented under subclass 223. A container wherein at least one of the contents is a sheet or strip coiled up upon itself or onto a core element.
- SEE OR SEARCH THIS CLASS, SUB-CLASS:
 389+, for a roll or reel container or package.
 570, for wound or rolled bandage or suture as part of a first aid or doctor kit.
 574, for wound or rolled material in a sewing or dressmaking kit.
- 226 With storage means in core:**
 This subclass is indented under subclass 225. A container wherein the rolled web material encompasses at least one other article, or material, which is useable with the web material.
- (1) Note. Included here is a roll of material with a sample, or fasteners, within the core.
- 227 Including thread or strip:**
 This subclass is indented under subclass 223. A container wherein at least one of the contents is filamentary in nature.
- SEE OR SEARCH THIS CLASS, SUB-CLASS:
 388, for a container for string or thread, per se, in nonspooled form.
 570, for thread or strip material in a first aid or doctor kit.
 574, for thread or strip in a sewing or dressmaking kit.
- 228 With razor:**
 This subclass is indented under subclass 223. A container for a razor as well as a blade or some other article or material, other than a toilet article.
- SEE OR SEARCH THIS CLASS, SUB-CLASS:
 352+, for a container for a razor blade, per se.
- SEE OR SEARCH CLASS:
 30, Cutlery, subclasses 32+ for a razor, per se.
 132, Toilet, subclass 286 for a toilet kit which may include a razor.
- 229 With content applicator or dispenser:**
 This subclass is indented under subclass 223. A container including a distinct instrumentality for spreading securing or ejecting a content material or article.
- SEE OR SEARCH THIS CLASS, SUB-CLASS:
 361+, for a brush container.
- SEE OR SEARCH CLASS:
 401, Coating Implements With Material Supply, subclasses 118+ for a coating supply container with an independent applicator.
- 230 Fastener and tool:**
 This subclass is indented under subclass 229. A container which includes a separate device for applying a fastener and the fastener means.
- SEE OR SEARCH THIS CLASS, SUB-CLASS:
 338+, for a container for a fastener.
 349+, for a container for a tool.
- 231 Including fastener:**
 This subclass is indented under subclass 223. A container including means to secure a content member.
- SEE OR SEARCH THIS CLASS, SUB-CLASS:
 226, for a rolled web with nails within the core.
 574, for a sewing or dressmaking kit.

- 576, for an arts and crafts kit.
582, for a kit including a patch with means to secure said patch.
- 232 Including booklet, leaflet or record means:**
This subclass is indented under subclass 216. A container wherein at least one of the contents is an indicia bearing sheet, card or pamphlet, or a form for receiving some data.
- SEE OR SEARCH THIS CLASS, SUBCLASS:
459.1, for a container with variable information exhibiting means.
459.5, for a container with static information exhibiting means.
- 233 Including tissue 'dispensing' means:**
This subclass is indented under subclass 216. A container wherein at least one of the contents is a roll or supply of, thin sheets so held as to be removable one at a time.
- (1) Note. See the reference to Class 221 under the class definition for "dispensing".
- SEE OR SEARCH CLASS:
221, Article Dispensing, appropriate subclasses, for sheet dispensing.
- 234 Tools:**
This subclass is indented under subclass 38. A container configured either as to shape, interior arrangement, or retaining device for holding a tool.
- SEE OR SEARCH THIS CLASS, SUBCLASS:
349+, and see notes thereunder, for a container for a tool, per se.
- 235 With vanity case:**
This subclass is indented under subclass 38. Container including a mirror or other toiletry feature, not elsewhere provided for.
- SEE OR SEARCH CLASS:
132, Toilet, subclasses 73+ for manicuring kits, and subclasses 286+ for toilet kits or assemblages having only personal grooming devices of the class type. See particularly subclasses
- 301+ for compacts having powder, applicator and mirror.
- 236 With tobacco product:**
This subclass is indented under subclass 38. Container including means to retain tobacco, a cigar or a cigarette.
- SEE OR SEARCH THIS CLASS, SUBCLASS:
242+, for a container for tobacco, pipe or cigarette, per se.
- 237 And paper:**
This subclass is indented under subclass 236. Container including means to retain paper.
- (1) Note. Usually, the paper is for rolling a cigarette.
- 238 And cutting or comminuting means:**
This subclass is indented under subclass 236. Container including a means to sever content or cover material.
- (1) Note. Included here is a separate cutting blade or a container with a sharpened edge.
- SEE OR SEARCH CLASS:
131, Tobacco, subclass 250 for a tobacco receptacle combined with an element for cutting the end of a cigar or cigarette.
- 239 For opening inserted package:**
This subclass is indented under subclass 238. Container wherein said severing means cuts the cover of a tobacco package placed in the container.
- 240 For shaving plug:**
This subclass is indented under subclass 238. Container wherein said severing means cuts a thin slice from a compressed mass of smoking tobacco.
- 241 For cutting quid:**
This subclass is indented under subclass 238. Container wherein said severing means cuts a slice from a compressed mass of chewing tobacco.

242 FOR TOBACCO, PIPE OR CIGARETTE HOLDER:

This subclass is indented under the class definition. Container for (a) tobacco, or tobacco substitute, intended for smoking or chewing or use as snuff, (b) a pipe for smoking tobacco or (c) a holder for a cigar or cigarette.

- (1) Note. Tobacco encased in a wrapper, which wrapper is consumed during smoking, is not a container for this class. See Class 131, below.

SEE OR SEARCH THIS CLASS, SUBCLASS:

- 85+, for an igniter combined with a tobacco package.
236+, for a combined pocket container including a tobacco product.

SEE OR SEARCH CLASS:

- 131, Tobacco, appropriate subclasses, for tobacco products, per se, and appliances specifically adapted for use by smokers.
211, Supports: Racks, subclass 70.3 for a support or rack for holding a cigar, cigarette, or smoking pipe in storage.
229, Envelopes, Wrappers, and Paperboard Boxes, subclasses 87.12 through 87.14 for a cigar, cigarette or tobacco wrapper, per se.

243 Hat supported:

This subclass is indented under subclass 242. Container carried by a head cover.

244 Pipe:

This subclass is indented under subclass 242. Container for a smoking pipe.

245 Laminate wall:

This subclass is indented under subclass 242. Container including cover material formed, at least in part, of multiple bonded layers or materials.

SEE OR SEARCH CLASS:

- 428, Stock Material or Miscellaneous Articles, subclasses 411.1+ and 615+ for nonmetallic and metallic composites, respectively, defined in terms of the composition of their components.

246 With ash holder:

This subclass is indented under subclass 242. Container including a distinct receptacle or retainer for spent or burnt tobacco.

- (1) Note. Included here is (a) a container with plural compartments, each initially holding a tobacco product, one of which receives ash after the tobacco content is removed or (b) a container wherein an ash receiving space is provided between an outer casing and an inner casing when the two are relatively displaced.

SEE OR SEARCH THIS CLASS, SUBCLASS:

- 125, for a match box with an ash receiver and see search notes thereunder for the locus of other ash receivers.

247 With antitampering means:

This subclass is indented under subclass 242. Container including a means which noticeably alters the receptacle, or an indicia member affixed thereof, when said receptacle is opened or contents removed.

- (1) Note. Included here as an indicia member is a revenue stamp.
(2) Note. Included here as "altered" is a receptacle that cannot be refilled once opened.

248 With means for holding package or bag at different levels in outer container:

This subclass is indented under subclass 242. Container including an inner pliable receptacle and interengagement structure between said inner receptacle and the enveloping container to adjustably fix the relative position of said inner receptacle to an outlet of said enveloping container.

- (1) Note. Included here is (a) at least one projection carried by a wall of the enveloping container which engages the bottom of the inner receptacle (b) a hook means on the inner receptacle, or a support element therefor, engageable with the outlet edge of the enveloping container, (c) a support member for the inner receptacle swingable mounted in the

container or (d) an invertible support member for the inner receptacle.

249 With ejector:

This subclass is indented under subclass 242. Container including means for moving content out of a container or to an exposed or more accessible position.

- (1) Note. Included here is a tobacco container having an opening through which a digit may be inserted to shift the content.
- (2) Note. The ejector means is not a “dispenser” in that it does not segregate the content portion exposed or moved from the balance of content material.

250 Content withdrawal synchronized with cover opening:

This subclass is indented under subclass 249. Container wherein the means for moving the content is interrelated to the shift of container closure means.

251 In casing with two hinged complementary covers:

This subclass is indented under subclass 250. Container wherein the container is of the clam shell type with two similar tray-like bodies hinged along one edge and disposed on opposite sides of the tobacco content.

252 Having biasing means:

This subclass is indented under subclass 249. Container wherein the content is resiliently urged toward an opening or to access position.

- (1) Note. Included here as a biasing means is a spring or rubber band.

253 Plunger type:

This subclass is indented under subclass 249. Container wherein the moving means is a elongate member which shifts along its own longitudinal axis.

254 Having pulling means:

This subclass is indented under subclass 249. Container wherein the moving means is a member, or element, manually drawn.

255 Follower type:

This subclass is indented under subclass 249. Container wherein the moving means is manually translatable, rigid content support, which extends across the interior of the container and is shiftable to at least two different support positions relative to a container opening or access.

256 With segregating means:

This subclass is indented under subclass 242. Container including structure separating contents into portions, individual items or groups of items.

- (1) Note. Included here are plural tobacco containers secured together, each container holding one or more items.
- (2) Note. Included here is a clam shell type container with two similar tray-like sections hinged along one edge, each or which includes means to hold cigarettes against its inner surface.
- (3) Note. A container with plural items individually wrapped or boxed is not “segregated” unless some means, other than the wrapper or box, separates one item from another or the wrappers or boxes are so secured as to form a compartment unit.

SEE OR SEARCH THIS CLASS, SUBCLASS:

251, for a clam shell type case with a content ejector synchronized to cover opening.

261+, for a clam shell type case for tobacco content.

257 Displaceable, resiliently joined, plural cell elements:

This subclass is indented under subclass 256. Container including pocket-forming members disposed side by side and yieldably interconnected by elastic means so that adjacent members can be separated to release content from a pocket.

- 258 Flexible web:**
This subclass is indented under subclass 256. Container formed at least one flaccid strip, or band, having plural cells tandemly disposed thereon.
- 259 Reinforcement or case for single cigarette package:**
This subclass is indented under subclass 242. Container including (a) discrete support means for a wall of a disposable type cigarette package or (b) a frame or discrete holder for such disposable type package.
- (1) Note. Usually, the support, frame or holder is applied to the cigarette package for carrying in pocket or purse.
- (2) Note. Included here is a closure forming section, placed over the opened end of a cigarette package and having rigid elongate members extending into said package.
- 260 Pouch type:**
This subclass is indented under subclass 242. Container using flaccid cover material to form a bag of sack.
- SEE OR SEARCH CLASS:
383, Flexible Bags, appropriate subclasses for tobacco pouches, per se. Class 206 includes the combination of a tobacco pouch and contents.
- 261 Casing formed of two hinged complementary covers:**
This subclass is indented under subclass 242. Container wherein the container is of the clam shell type with two similar tray-like bodies hinged along one edge and disposed on opposite sides of the tobacco content.
- SEE OR SEARCH THIS CLASS, SUBCLASS:
251, for a similar case with a content ejector synchronized to cover opening.
256+, for a similar case with segregating means.
- SEE OR SEARCH CLASS:
220, Receptacles, subclasses 4.01+ for sectional receptacles.
- 262 Released by translation of covers:**
This subclass is indented under subclass 261. Container opened by sliding said bodies relative each other.
- 263 Having retaining member:**
This subclass is indented under subclass 261. Container including a positioning means to hold content adjacent one of said bodies.
- 264 With opening or separating means:**
This subclass is indented under subclass 242. Container including parting cover structure to facilitate access to, or exposure of, content.
- (1) Note. Included here as opening, or separating means, is a score line in cover material, a tear string, a pull tab for an adhesive strip, a weakened bonded line or an inner member edge against which an outer cover member can be severed.
- SEE OR SEARCH THIS CLASS, SUBCLASS:
532, for a container with rupture means.
- 265 With closure:**
This subclass is indented under subclass 242. Container including a movable member, or element, for covering or uncovering an opening in the container.
- SEE OR SEARCH THIS CLASS, SUBCLASS:
236, for a tobacco container having means to lock a closure member a predetermined time after some content has been removed.
- 266 Biased:**
This subclass is indented under subclass 265. Container including resilient means urging the closure toward open or closed position.
- 267 Sliding:**
This subclass is indented under subclass 265. Container wherein the closure is a member translatable across the container opening.

- 268 Integral hinge:**
This subclass is indented under subclass 265. Container wherein the closure is a flap, or panel, extending from the cover material of a side, or other wall, of the container.
- 269 Waterproof:**
This subclass is indented under subclass 265. Container including a means to seal against entry of water.
- 270 Telescoping:**
This subclass is indented under subclass 265. Container under subclass including a skirt portion depending from the closure, which skirt is slidably engageable with the container opening.
- 271 Sheet-formed receptacle:**
This subclass is indented under subclass 242. Container using a membranous or web-like panel as cover material.
- 272 Twisted:**
This subclass is indented under subclass 271. Container wherein the container is formed by helical or spiral interengagement of the sheet material.
- 273 Folded blank:**
This subclass is indented under subclass 271. Container wherein said panel or cover material is scored or crease-marked to be erected along such score line or crease line to form a container.
- SEE OR SEARCH CLASS:
229, Envelopes, Wrappers, and Paperboard Boxes, appropriate subclasses for similar folded blank containers.
- 274 Sealed:**
This subclass is indented under subclass 271. Container wherein the content is hermetically enclosed.
- 275 Shield:**
This subclass is indented under subclass 271. Container including a relatively rigid wall, or panel, adjacent which content is placed for protection.
- (1) Note. Generally the containers classified in this subclass are intended for pocket or purse.
- 276 End cover for cigar or cigarette:**
This subclass is indented under subclass 242. Container formed as a cap-like member to conformably engage with an end of a cigar or cigarette.
- 277 FOR SQUEEZE TUBE (E.G., TOOTH-PASTE TUBE):**
This subclass is indented under the class definition. A container for a generally cylindrical-body receptacle, which receptacle is formed of flaccid material and can be compressed to expel the receptacle content.
- 278 FOR APPAREL:**
This subclass is indented under the class definition. A container for an article of clothing; e.g., garment, headwear, footwear.
- (1) Note. Included here is a container for a garment accessory or nonjewelry adornment; e.g., belt, tie, scarf.
- SEE OR SEARCH THIS CLASS, SUBCLASS:
6.1, for a container for, or a package containing, jewelry.
213, for an apparel container including a separate means for insect repellent.
- SEE OR SEARCH CLASS:
2, Apparel, for a garment, per se.
36, Boots, Shoes, and Leggings, for footwear, per se.
128, Surgery, subclasses 425+ for a brassiere, corset or girdle, per se.
190, Trunks and Hand-Carried Luggage, subclasses 19+, for trunks and subclasses 100, for traveling bags.
229, Envelopes, Wrappers, and Paperboard Boxes, subclasses 87.15 through 87.17 for an apparel wrapper, per se.
312, Supports: Cabinet Structure, subclasses 31+ for a cabinet with gas or vapor treatment means.

278.1 Cedar chest type:

This subclass is indented under subclass 278. A container wherein the cover material (a) incorporates and ingredient which repels or kills insects, or (b) is so treated as to repel or kill insects.

SEE OR SEARCH THIS CLASS, SUB-CLASS:

213, for an apparel container with an ancillary contacting medium to repel insects.

524.1+, for a container made of a particular material which may interact with the content.

SEE OR SEARCH CLASS:

312, Supports: Cabinet Structure, subclasses 31+ for a cabinet with gas or vapor treatment means.

279 Means to hold article hanger or support:

This subclass is indented under subclass 278. A container including a retainer releasably securing an apparel holding member on (a) a wall of the container or (b) separate means connected to the container.

280 Reinforced wall:

This subclass is indented under subclass 278. A container including means for stiffening or strengthening a panel thereof.

281 Indicia:

This subclass is indented under subclass 278. A container including (a) symbols, numbers, letters, or other visual means providing information to a user of the container, or (b) structure facilitating placement of such means on the container.

282 Means to facilitate article insertion:

This subclass is indented under subclass 278. A container with an adjunct, or structural arrangement, assisting the placement of an article therein.

283 Wall spreader or swing arm attached to panel:

This subclass is indented under subclass 282. A container having (a) means for temporarily increasing the distance between opposed walls of the container, or (b) an elongate member

swingably mounted on the container and attached to a flaccid wall thereof, movement of said member carrying said wall to a position permitting ready access to the container.

284 Article hanger attachment extended from container:

This subclass is indented under subclass 278. A container including a first member disposed inside the container for directly suspending an article of clothing (or for suspending a hanger which in turn supports said article) and a second member projecting from the container for attachment to an external support, said first and second members being (a) integral, or (b) directly connected, or (c) indirectly connected by means other than mere attachment of both of the members to an exterior wall of the containers.

285 Removable article hangers retained in spaced relation:

This subclass is indented under subclass 284. A container including means for separating, individually or in groups, apparel holding members that can be taken out of the container.

(1) Note. Included here is a container wherein (a) hooks of hangers are suspended from support points spaced a part transversely of the container and (b) lower portions of the hangers contact one another in overlapping relation.

SEE OR SEARCH THIS CLASS, SUB-CLASS:

291, for an article hanger suspended from a container with removable hangers in spaced relation.

286 Bag-type container:

This subclass is indented under subclass 284. A container wherein the container is made of a flaccid material.

SEE OR SEARCH CLASS:

150, Purses, Wallets, and Protective Covers, appropriate subclasses for other flaccid material receptacles.

- 287 Article completely enclosed:**
This subclass is indented under subclass 286. A container forming, when closed; a substantially imperforate envelope around a retained article.
- 287.1 Foldable to compact use configuration:**
This subclass is indented under subclass 287. Subject matter wherein the container, in its filled and closed condition, includes means which allows it to be folded or rolled up itself to facilitate carrying.
- 288 Article hanger integral with container:**
This subclass is indented under subclass 278. A container wherein a support for a retained article is formed from a portion of container cover material.
- 289 Article hanger suspended from container or attached support:**
This subclass is indented under subclass 278. A container wherein an apparel holding member hangs from (a) wall of the container or (b) a separate means connected to the container, e.g., a support bar having its ends respectively attached to opposite walls of the container.
- 290 Plural article hangers:**
This subclass is indented under subclass 289. A container including more than one apparel holding member.
- 291 Removable article hangers retained in spaced relation:**
This subclass is indented under subclass 290. A container including means for separating, individually or in groups, apparel holding members that can be taken out of the container.

SEE OR SEARCH THIS CLASS, SUBCLASS:
285, for an article hanger attachment extended from a container with movable hangers retained in spaced relation.
- 292 Article retainer or positioner:**
This subclass is indented under subclass 278. A container including means for holding a clothing item in a predetermined portion on or in the container.
- (1) Note. Included here is a container compartmented by an interior wall.
- 293 Resilient or elastic member:**
This subclass is indented under subclass 292. A container wherein the holding means tends to return to its original shape or position when deflected, stretched, or otherwise moved.
- 294 Aperture:**
This subclass is indented under subclass 292. A container wherein at least a portion of the retained item is positioned in (a) hole extending through a panel of the container, or (b) a notch formed in the edge of a panel of the container.

SEE OR SEARCH THIS CLASS, SUBCLASS:
292, for a container having article-receiving pockets or compartment.
- 295 Tongue struck from panel:**
This subclass is indented under subclass 292. A container wherein the holding means is a flap, loop or the like, cut at least in part from a wall of the container and then bent, folded or otherwise deflected, either manually or by the retained article, to secure said article to the container.
- 296 Member enters opening in retained article:**
This subclass is indented under subclass 292. A container wherein the holding means is received with an opening in the retained item.
- 297 Separate self-supporting folded blank:**
This subclass is indented under subclass 292. A container wherein the holding means is erected from a discrete self-sustaining creased or score-marked sheet.
- 298 Bar, rod or tube:**
This subclass is indented under subclass 292. A container wherein the holding means is an elongate member either solid or hollow in form.
- 299 Single self-supporting folded blank forms container:**
This subclass is indented under subclass 278. A container formed of one self-sustaining scored or crease-marked sheet erected into a

sheath encircling at least a portion of a retained article, no self-sustaining exterior wall or the container being separate from said sheet.

SEE OR SEARCH CLASS:

229, Envelopes, Wrappers, and Paperboard Boxes, appropriate subclasses for other receptacles erected from scored or crease-marred panels.

300 FOR CLOTHES HANGER:

This subclass is indented under the class definition. A container for a movable suspension support means for an article of clothing.

(1) Note. Included here is a container for packaging a plurality of hangers in a compact manner.

301 FOR TIME MECHANISM OR ELEMENT:

This subclass is indented under the class definition. A container for holding a device to measure, or indicate, time or a subcombination of such device thereof.

SEE OR SEARCH CLASS:

368, Horology: Time Measuring Systems or Devices, appropriate subclasses for a time device, per se.

302 FOR A TIRE VALVE OR PATCH:

This subclass is indented under the class definition. A container for (a) a fluid flow regulating element to inflate or deflate an inner tube or tire or (b) a repair panel for sealing a leak in an inner tube or tire.

SEE OR SEARCH THIS CLASS, SUBCLASS:

582, for kit including a patch with means to secure said patch.

303 FOR AN ANNULAR ARTICLE:

This subclass is indented under the class definition. A container for a toroid shaped articles, e.g., wreath.

SEE OR SEARCH THIS CLASS, SUBCLASS:

309+, for a container for a phonograph disk.
423, for a container for plant or flower formations.

304 Tire or inflated inner tube:

This subclass is indented under subclass 303. A container wherein the annular article is the outer resilient member of a vehicle wheel or an distended inner tube thereof.

SEE OR SEARCH THIS CLASS, SUBCLASS:

69, for a container for a deflated, and generally folded, inner tube.

SEE OR SEARCH CLASS:

152, Resilient Tires and Wheels, appropriate subclasses for a tire, per se.
224, Package and Article Carriers, subclasses 42.12+ for a vehicle-attached cover or casing which receives a tire or wheel.
229, Envelopes, Wrappers, and Paperboard Boxes, subclass 87.01 for a tire wrapper which is a single-use, paper-type covering intended to be discarded when removed.

304.1 Flaccid encasement:

This subclass is indented under subclass 304. Subject matter wherein the container is made of supple material.

SEE OR SEARCH CLASS:

229, Envelopes, Wrappers, and Paperboard Boxes, subclass 87.01 for a tire wrapper which is a single-use, paper-type covering intended to be discarded when removed.

304.2 Partial encasement (i.e., portion of article remains uncovered):

This subclass is indented under subclass 304. Subject matter wherein the container does not completely enclose the tire or distended inner tube.

SEE OR SEARCH CLASS:

224, Package and Article Carriers, subclasses 42.12+ for a vehicle-attached cover or casing which receives a tire or wheel.

305 FOR AN INSTRUMENT (I.E., MEANS TO MEASURE, TEST OR INDICATE):

This subclass is indented under the class definition. Container for a device used to exhibit or gage a quantitative or qualitative characteristic.

- (1) Note. Included here is a container for a ruler, a gage or a meter.
- (2) Note. The term "instrument" is used here in a very limited sense. See subclasses below for other article containers which articles are often referred to as an "instrument".

SEE OR SEARCH THIS CLASS, SUBCLASS:

- 214, for a container for plural stationery implements.
 224, for a draftsman or lettering kit.
 349+, for a container for a tool or appliance.

SEE OR SEARCH CLASS:

- 33, Geometrical Instruments, appropriate subclasses for a device to measure special relationship.
 73, Measuring and Testing, appropriate subclasses for a device to measure quantitative units such as pressure, etc.
 116, Signals and Indicators, for instruments, appropriate subclasses.

306 Thermometer:

This subclass is indented under subclass 305. A container for an instrumentality to measure temperature.

- (1) Note. This subclass takes storage containers for thermometers. For protective shields, see search note below.

SEE OR SEARCH THIS CLASS, SUBCLASS:

- 212, for a container for a thermometer plus a contacting medium.

SEE OR SEARCH CLASS:

- 374, Thermal Measuring and Testing, subclass 158 for a thermometer combined with a protective cover, and subclass 209 for such a protective cover, per se,

the protective covers surrounding the thermometer during use thereof.

307 FOR HOLDING A MACHINE READABLE RECORDING MEDIUM (E.G., COMPACT DISC, PHONOGRAPH RECORD, TAPE, FLOPPY DISK):

This subclass is indented under the class definition. A container including structure for removably containing an information carrier which is configured to include encoded information.

- (1) Note. This and indented subclasses do not include housings for recording medium which remain with the medium during play.

SEE OR SEARCH THIS CLASS, SUBCLASS:

- 389+, for a container for removably holding a roll of film.
 455, for a container for holding a film sheet.
 456, for a container for holding a photos:graphic slide.
 751+, for a recording medium holder which upon opening the cover, converts the holder into a display configuration.

SEE OR SEARCH CLASS:

- 211, Supports: Racks, subclasses 40 and 41.1+ for a rack for holding recording media.
 242, Winding, Tensioning, or Guiding, subclasses 326+ and 335+ for a tape cassette, per se.
 312, Supports: Cabinet Structure, subclasses 9.1+ for a cabinet for holding recording media.
 360, Dynamic Magnetic Information Storage or Retrieval, appropriate subclasses for a permanently housed magnetic computer disk or a magnetic tape cassette with recording/playback means.
 369, Dynamic Information Storage or Retrieval, subclasses 272.1 through 291.1 for a permanently housed optical recording medium.
 720, Dynamic Optical Information Storage or Retrieval, subclasses 718 through 746 for optical storage medium structure.

307.1 For holding plural diverse recording media in the same holder:

This subclass is indented under subclass 307. A container including a structure for holding multiple different recording media.

308 For holding a music roll:

This subclass is indented under subclass 307. A container for an elongate spool which carries a perforate sheet for operating player pianos and the like.

308.1 For holding an optical disc (e.g., compact disc):

This subclass is indented under subclass 307. A container including a structure intended for removably storing a recording medium on which information retrievable by reflected or refracted light is stored.

SEE OR SEARCH CLASS:

- 211, Supports: Racks, subclass 40 for a rack for holding optical discs.
 369, Dynamic Information Storage or Retrieval, subclasses 272.1 through 291.1 for a permanently housed optical recording medium.
 720, Dynamic Optical Information Storage or Retrieval, subclasses 718 through 746 for optical storage medium structure.

308.2 Including structure intended to prevent theft or unauthorized use:

This subclass is indented under subclass 308.1. A container including a structure intended to deter pilferage or unapproved access to the contents.

SEE OR SEARCH THIS CLASS, SUBCLASS:

- 1.5, for a container including a structural locking modification.

308.3 For holding a housed computer disk (e.g., floppy disk):

This subclass is indented under subclass 307. A container including a structure to removably store an encased flat circular recording medium for computer data.

SEE OR SEARCH CLASS:

- 360, Dynamic Magnetic Information Storage or Retrieval, subclass 133 for a housed computer disk, per se.

309 For holding a grooved phonograph disk:

This subclass is indented under subclass 307. A container for holding a thin flat circular form including contour variations which serve as a pattern for the reproduction of audible signals.

SEE OR SEARCH THIS CLASS, SUBCLASS:

- 303, for a container for holding an annular article.

SEE OR SEARCH CLASS:

- 211, Supports: Racks, subclass 40 for a rack for holding phonograph disks.

310 Including spindlelike retainer:

This subclass is indented under subclass 309. A container wherein the disk is maintained by engagement through a central aperture.

- (1) Note. Through a container with such spindlelike retainer means meets the definition of subclass 303 as an annular article retainer-phonograph disk containers are collected here because of the similarity in container details.

SEE OR SEARCH CLASS:

- 294, Handling: Hand and Hoist-Line Implements, subclass 158 for a record carrier having a spindlelike retainer.

311 Album type:

This subclass is indented under subclass 309. A container wherein an individual disk holder, or a plurality of such holders, are bound or secured in a ply-cover like the leaves of a book.

- (1) Note. The individual holder may be of the jacket, or folder, type provided for in subclass 312, below.

312 Jacket or folder:

This subclass is indented under subclass 309. A container wherein a disk is held in a flat pocket, envelope or double ply.

SEE OR SEARCH THIS CLASS, SUB-CLASS:

311, for a container with a jacket or folder secured to a cover along one edge of said jacket, like the page of a book.

- 313 Including a distinct liner, cushion or sleeve:**
This subclass is indented under subclass 312. A container including a discrete element or member, within the jacket or folder, to protect the disk.

SEE OR SEARCH THIS CLASS, SUB-CLASS:

521, for a shock protection type of container.

- 314 FOR A MUSICAL ARTICLE:**
This subclass is indented under the class definition. A container for a musical device or instrument or a specialized component thereof.

(1) Note. Music reproduction devices, e.g., radio, tape, recorder, phonograph are considered "household appliances" for subclass 320, below.

(2) Note. The term "instrument" as used here refers to such articles as: piano, flute, horn, drum, etc.

SEE OR SEARCH CLASS:

84, Music, appropriate subclasses, for a musical instrument, per se, components and accessories.

- 315.1 FOR A SPORT IMPLEMENT, EXERCISE DEVICE OR GAME:**

This subclass is indented under the class definition. Subject matter comprising a receptacle for a device used for amusement, exercise, or competition.

SEE OR SEARCH THIS CLASS, SUB-CLASS:

317, for a container for a weapon (e.g., bow, shotgun).

SEE OR SEARCH CLASS:

124, Mechanical Guns and Projectors, subclass 23.1 for an arrow holder disclosed as being attachable to a bow.

224, Package and Article Carriers, cross-reference art collections 916 for bow or arrow carriers, 917+ for a for a body- or vehicle-attached ski carrier, and 920 and 922 for fishing equipment carriers and holders.

273, Amusement Devices: Games, appropriate subclasses for a sport device, per se.

472, Amusement Devices, for an amusement device, per se, proper therefor.

473, Games Using Tangible Projectile, and its incorporated class (273, Amusement Devices: Games) for a game or sport device, per se, proper therefor.

482, Exercising Devices, for an exercise device, per se, proper therefor.

D3, Travel Goods and Personal Belongings, subclasses 36+ for design patents for golf bags, hunting and fishing bags, and other sporting equipment bags.

- 315.11 For hunting or fishing equipment:**

This subclass is indented under subclass 315.1. Subject matter wherein the device is used for fishing or for hunting game.

- 315.2 For a golf club:**

This subclass is indented under subclass 315.1. Subject matter wherein the device is a golf club.

- 315.3 Golf bag:**

This subclass is indented under subclass 315.2. Subject matter wherein the receptacle is a bag for golf club.

SEE OR SEARCH CLASS:

150, Purses, Wallets, and Protective Covers, subclass 159 for a golf cart or bag protective cover, per se.

- 315.4 Including club head protector or cover:**

This subclass is indented under subclass 315.3. Subject matter wherein the bag includes an element which is adapted to be positioned over or around at least one club head to prevent it from being damaged.

SEE OR SEARCH CLASS:

150, Purses, Wallets, and Protective Covers, subclass 160 for a golf club protective cover, per se.

315.5 Including pocket for golfing accessories:

This subclass is indented under subclass 315.3. Subject matter wherein the bag includes a compartment, other than one containing golf clubs, which is designed or adapted to hold items which are used during a golf game (e.g., balls, tees, etc.).

315.6 Including means for separating club shafts:

This subclass is indented under subclass 315.3. Subject matter wherein the bag includes an element which prevents one golf club shaft from being contacted by another.

315.7 Including means for maintaining bag in upright position:

This subclass is indented under subclass 315.3. Subject matter wherein the bag includes a supporting element which prevents it from falling over when placed in an upright position.

315.8 Including sidewall stiffener or reinforcement:

This subclass is indented under subclass 315.3. Subject matter wherein the bag includes means which rigidify or strengthen the peripheral side wall thereof.

315.9 For a ball:

This subclass is indented under subclass 315.1. Subject matter wherein the devices is a ball.

315.91 Bowling ball:

This subclass is indented under subclass 315.9. Subject matter wherein the receptacle is for a bowling ball.

SEE OR SEARCH CLASS:

473, Games Using Tangible Projectile, subclasses 125+ for a bowling ball, per se.

316.1 FOR AN OPTICAL DEVICE OR ELEMENT (E.G., CAMERA, TELESCOPE, BINOCULARS, MICROSCOPE, LENS, FILTER, ETC.):

This subclass is indented under the class definition. A container for means which performs a basic optical function (i.e., deviates or modifies light).

SEE OR SEARCH THIS CLASS, SUBCLASS:

5, for a container for a face carried, vision correcting lens, (e.g., a pair of eyeglasses, an eyeglass lens, contact lenses, etc.).

305, for a container for a measuring instrument (e.g., light meter, etc.).

387.1+, for a container for a magnetic tape cartridge or cassette, which cartridge or cassette must be disassociated from the container during use. See the SEARCH CLASS reference below for the location of a tape holding cartridge or cassette, per se.

389+, for a container for a roll, spool or reel of photographic film (either developed or undeveloped) or magnetic tape, which roll, spool or reel must be disassociated from the container for winding or unwinding. See the SEARCH CLASS references below for the location of a tape or film holding roll, spool or reel, per se.

449, for a container for pictures or developed negatives.

454, for a container for fragile or light sensitive items.

455, for a container for undeveloped film sheets.

456, for a container for slides or transparencies (glass or film).

573, for a container for a signal, lamp or reflector which is in kit form.

578, for a container for a kit for taking, developing or printing an image by a light sensitive technique.

SEE OR SEARCH CLASS:

40, Card, Picture, or Sign Exhibiting, subclasses 124+ for a card rack which may be used to hold pictures or slides, particularly subclass 124.2 for a card rack which includes pockets, subclass 124.2 for a card rack which includes notches, and subclasses 152+ for a film slide.

224, Package and Article Carriers, subclass 908 for a Cross-Reference Art Collection of carriers for a camera or other photographic equipment, and subclass 909 for a Cross-Reference

- Art Collection of carriers for binoculars.
- 242, Winding, Tensioning, or Guiding, subclasses 326+, 341+, 348+, and 588+ for a coil enclosed within a housing.
- 271, Sheet Feeding or Delivering, various subclasses, particularly subclasses 145+ for a stack of sheet material (e.g., photographic film) in a container for use with a sheet feeding or delivering means of that class type.
- 378, X-Ray or Gamma Ray Systems or Devices, particularly subclasses 167+ for a container having structure limited to use with an X-ray device (e.g., intensifier screen, material opaque to visible light and transparent to X-radiation, structure which coats with the X-ray device, etc.).
- 396, Photography, subclasses 439+, particularly subclasses 511+, for photographic film combined with claimed camera structure, and for removable film-holder units not provided for elsewhere.
- 399, Electrophotography, subclasses 107+ for a housing arrangement that has a replaceable or displaceable configuration for transporting, reconfiguration, maintenance, service, or repair.
- 414, Material or Article Handling, various subclasses, particularly subclass 788.7 for a container holding a stack of articles which are recirculated past a work, treatment or inspection station (e.g., broadly recited camera, viewer, etc.), and subclass 932 for a Cross-Reference Art Collection of Audio and Video Cassettes.
- 430, Radiation Imagery Chemistry: Process, Composition, or Product Thereof, subclasses 496+ for a container holding a single sheet of radiation sensitive material which remains with the container/holder during exposure.

316.2 Camera:

This subclass is indented under subclass 316.1. Subject matter wherein the receptacle is for a camera.

SEE OR SEARCH CLASS:

- 224, Package and Article Carriers, appropriate subclasses for other receptacles having means for attachment to an animate bearer (e.g., shoulder straps).
- 248, Supports, subclasses 163.1+ for a tripod.
- 292, Closure Fasteners, DIG 48 for a fastener for a camera cover.
- 294, Handling: Hand and Hoist-Line Implements, subclasses 137+ for other article carriers carried and gripped by the hand, particularly subclasses 139 and 908 for a camera holder.
- 359, Optical: Systems and Elements, subclasses 507+ for structure to prevent moisture or foreign matter from coming in contact with optical elements.
- 383, Flexible Bags, appropriate subclasses for a bag of general utility.
- 396, Photography, for a camera, per se, and subclasses 419+ for a camera mounting or rest.

316.3 Binoculars:

This subclass is indented under subclass 316.1. Subject matter wherein the receptacle is for binoculars.

317 FOR A WEAPON:

This subclass is indented under the class definition. A container for an armament or ordnance means.

- (1) Note. Included here is a container for both a large or small weapon: e.g., a pistol, a cannon, a rocket missile.

SEE OR SEARCH THIS CLASS, SUBCLASS:

- 3, for a container for ammunition.
- 349+, for a container for a knife.

318 FOR A BEARING OR JOURNAL:

This subclass is indented under the class definition. A container for a device to facilitate motion of one part with respect to another by minimizing frictional forces.

SEE OR SEARCH CLASS:

- 384, Bearings, subclasses for bearing or journal, per se.

319 FOR A MOTOR OR ENGINE:

This subclass is indented under the class definition. Container for an energy conversion mechanism, e.g., electrical to mechanical as an electric motor, mechanical to electrical as a generator, heat to mechanical as a steam or gasoline engine.

- (1) Note. Included here are patents on a container for, or package of, an outboard motor assembly.

320 FOR A HOUSEHOLD APPLIANCE:

This subclass is indented under the class definition. A container for a home or a business establishment mechanism to enhance, sustain, or facilitate functions or operations therein.

- (1) Note. Included here is a container for a plumbing fixture, a sound reproducing device such as a phonograph or tape recorder, a washing machine, a refrigerator, a sewing machine, a typewriter, or an adding machine.
- (2) Note. A hand (held or operated) device e.g., a vacuum cleaner, an egg beater (but not a mixer-bowl combination), a floor sweeper, an electric knife or a poultry shear, etc. is not considered an "appliance".

SEE OR SEARCH THIS CLASS, SUB-CLASS:

349+, for a container for a tool or implement.

576, for a kit including a household or office device, and for a container for a household appliance plus an ancillary attachment.

321 FOR A BUILDING COMPONENT:

This subclass is indented under the class definition. A container for subassemblies and elements of building structure.

- (1) Note. Included here is a container or package, for a brick, window, door, shingle, lumber, tile or hardware; e.g., hinges and doorknobs.

322 Brick, block or tile:

This subclass is indented under subclass 321. A container for a cast or molded block-like construction module generally used to erect a wall or lay a floor.

323 Shingle:

This subclass is indented under subclass 321. A container for a sheet-like laminate, or coated construction panel, generally used for an outer roofing or wall surface.

324 Self-sealing type:

This subclass is indented under subclass 323. A container for a tacky or sticky surfaced panel.

325 Prehung door or window:

This subclass is indented under subclass 321. A container for a framed or mounted portal casement structure.

326 FOR FURNITURE OR DRAPE:

This subclass is indented under the class definition. A container for (a) a structure to support the human body, e.g., chair, bed, stool, or (b) a structure to support or store household utensils, e.g., table, side board, or (c) a curtain.

- (1) Note. Included here is a container for a specialized furniture or drape component or accessory not elsewhere provided for, e.g., a curtain rod container.

327 FOR SPARK PLUG:

This subclass is indented under the class definition. A container for a space-jumping spark device commonly used for internal combination engine ignition.

SEE OR SEARCH THIS CLASS, SUB-CLASS:

211, for a container for a spark plug plus a contacting medium.

SEE OR SEARCH CLASS:

313, Electric Lamp and Discharge Devices, subclasses 118+ for a spark plug, per se.

335 FOR A VEHICLE:

This subclass is indented under the class definition. A container for a land, water, air or space transportation means.

- (1) Note. Included here is a container for a specialized vehicle component, which component container is not specifically provided for elsewhere; e.g., subclasses 318, 319, 327, etc.

SEE OR SEARCH CLASS:

410, Freight Accommodation on Freight Carrier, subclasses 24+ for a multi-level deck freight car body for the transportation of four-wheel vehicles.

336 FOR SAFETY PIN:

This subclass is indented under the class definition. A container for a looped, wire-like, resilient fastener with a shield, or cover, for a pointed end.

SEE OR SEARCH THIS CLASS, SUB-CLASS:

338+, for a container for other fasteners.
348, for a container for a haberdashery-type fastener.
372+, for a container for plural tools, and see search notes thereunder.
380+, for a container for a plurality of straight, or unprotected, pins.

337 FOR FORKED HAIRPIN:

This subclass is indented under the class definition. A container for a generally U-shaped member used to secure or position human hair.

SEE OR SEARCH THIS CLASS, SUB-CLASS:

380+, for a container for straight pins.

338 FOR A FASTENER:

This subclass is indented under the class definition. A container for a securement element.

- (1) Note. Included here are container means for a driven fastener, in the sense that the individual fastener is applied by being pushed through, around or into, material(s) so as to secure (a) a thing to the material or (b) separate portions of mate-

rial(s) together. However, see subclasses 380+ for a pin container.

- (2) Note. See (1) Note under subclass 77 of Class 59 for the line note among Classes 59 and 206.

SEE OR SEARCH THIS CLASS, SUB-CLASS:

230, for a container for a fastener with a tool for applying said fastener.
348, for a container for a haberdashery type securement.

339 Surgical or wound type:

This subclass is indented under subclass 338. A container for a securement means used on living tissue.

340 Staple, clip, belt, or lacing hook:

This subclass is indented under subclass 338. A container for a U-like, or C-like, securement means which usually has its open ends further deformed to effect a holding function.

- (1) Note. Included here is a container for flaccidly or integrally (but severably) connected fasteners.

SEE OR SEARCH THIS CLASS, SUB-CLASS:

343+, for a container for pin-like fasteners that are flaccidly or integrally (but severably) connected.

341 Retained in aperture of support member:

This subclass is indented under subclass 340. A container wherein the fastener is positioned in an opening of a holding element.

SEE OR SEARCH THIS CLASS, SUB-CLASS:

562+, for a tray-type container including an aperture to hold an article.

342 Alternately reversed:

This subclass is indented under subclass 338. A container wherein each fastener is inverted with respect to its adjacent fastener.

343 Flaccidly or integrally (but not severably) connected:

This subclass is indented under subclass 338. A container wherein a fastener is so joined (a) to a limber sheet (web or band) material, or (b) to another fastener, that the fastener may readily be separated from the material or from another fastener.

SEE OR SEARCH THIS CLASS, SUB-CLASS:

340, for a similar container for a staple, clip, belt or lacing hook fastener.

344 Between lamina:

This subclass is indented under subclass 343. A container wherein the fastener is sandwiched by supporting material.

345 Secured to common flaccid member:

This subclass is indented under subclass 343. A container wherein fasteners are held by the same sheet or web of material.

346 Plane of member normal to extent of fastener:

This subclass is indented under subclass 345. A container wherein each fastener is positioned perpendicular to the supporting material.

SEE OR SEARCH THIS CLASS, SUB-CLASS:

383, for a container for pins or needles held normal to a supporting member.

347 Held by aperture in member:

This subclass is indented under subclass 345. A container wherein each fastener is positioned in an opening in the supporting material.

SEE OR SEARCH THIS CLASS, SUB-CLASS:

382, for a container for pins or needles held in openings of supporting material.

562+, for a tray-type container including an aperture to hold an article.

348 FOR HOOK, HANGER, EYE, CHAIN, BUTTON, CLASP (I.E., HABERDASHERY TYPE):

This subclass is indented under the class definition. A container for apparel securement elements.

(1) Note. The fasteners are generally of metal intended for sewing or riveting to clothing items.

SEE OR SEARCH THIS CLASS, SUB-CLASS:

338+, for a container for driven fasteners.

380+, for a container for pins or needles.

349 FOR A TOOL (E.G., KNIFE, SHAVER):

This subclass is indented under the class definition. A container arranged either as to shape, interior compartments, or retaining devices for holding an implement.

(1) Note. As used here, a tool or implement is a means for (a) modifying the condition, state, position, shape or appearance or material, e.g., soldering iron, shovel, wrench, knife, or (b) exerting a force or restraint on an article or material, e.g., hammer, prybar, or (c) applying or removing a fastener, coating or lamina, e.g., screwdriver, brush, vacuum cleaner which means is manipulated (i.e., applied to said article or material) by an operator. The tool may be the entire device as for example an electric hand drill or merely the work contacting element a drill bit. A device which is actuated by an operator but includes other means to establish a tool-work relationship as for example the work support base of a drill press is considered an apparatus rather than a tool, though the work modifying means, per se, is still a tool.

(2) Note. Included hereunder is a container for, or a collection of, plural (or diverse) appliance attachments or tools. Such tools per se are not considered to constitute a "kit" for subclasses 223+.

SEE OR SEARCH THIS CLASS, SUB-CLASS:

207, for a tool container including an ancillary medium contacting such tool, e.g., antirust composition.

229+, for a kit which combines an applicator with the thing or material to be applied, e.g., a container for a fastener plus the fastener driver.

- 234, for a pocket or personal use container combination which includes a tool.
- 304, for a container for a tool combined with a tire.
- 320, for a container for a household appliance.
- 576, for a container for a household appliance plus an ancillary tool.
- SEE OR SEARCH CLASS:
211, Supports: Racks, subclass 70.8 for a support or rack for holding a tool.
- 350 Magnetic holder:**
This subclass is indented under subclass 349. A container wherein the tool is supported by magnetic means.
- SEE OR SEARCH CLASS:
269, Work Holders, subclass 8, for a magnetic workholder and see search note thereunder.
- 351 Powered razor:**
This subclass is indented under subclass 349. A container for a motor driven shaver.
- SEE OR SEARCH CLASS:
30, Cutlery, subclasses 42+, for a powered razor, per se.
- 352 Razor blade:**
This subclass is indented under subclass 349. A container for the cutting element of a shaving instrumentality
- SEE OR SEARCH THIS CLASS, SUBCLASS:
208, for a container for a razor blade including an ancillary contacting medium, e.g., oil.
228, for a razor kit.
- SEE OR SEARCH CLASS:
30, Cutlery, subclasses 32+ for a razor, per se.
- 353 Folded blank or wrapper:**
This subclass is indented under subclass 352. A container erected from a scored or crease-marked sheet of material.
- SEE OR SEARCH CLASS:
229, Envelopes, Wrappers, and Paperboard Boxes, subclasses 100+ for a folded blank paperboard box.
- 354 Plural blades:**
This subclass is indented under subclass 352. A container for two or more razor blades.
- 355 With blade removal means:**
This subclass is indented under subclass 354. Container including structure to facilitate taking a blade out of the container.
- (1) Note. See the reference to Class 221, Article Dispensing, in this (206) class definition under Search Class, for the locus of article dispensing features.
- 356 Providing for razor coaction:**
This subclass is indented under subclass 355. A container wherein the structure for getting a blade out of the container is configured for actuation by a mating portion of a razor.
- (1) Note. This subclass is limited to the container or blade package, per se. The combination of blade container, or package, with a razor is in Class 30.
- SEE OR SEARCH CLASS:
30, Cutlery, subclasses 40+ for a razor combined with a blade magazine.
- 357 Mid-blade access for finger:**
This subclass is indented under subclass 355. Container with an opening for digital contact with a blade to remove it.
- 358 Alternate direction feeding:**
This subclass is indented under subclass 357. A container including means whereby a finger may move a blade out of the container in one direction and the next blade in another direction.
- 359 Plus container for discarded blade:**
This subclass is indented under subclass 354. A container with means to separately hold a "used" blade.

360 Follower function for discard:

This subclass is indented under subclass 359. A container wherein a “used” blade inserted into the discard container moves a “used” blade, or blades, already in said discard container against yielding means to clamp the “used” blades or maintain the “unused” blades in proper position for subsequent removal.

361 Brush (e.g., swab, sponge):

This subclass is indented under subclass 349. A container for a bristle-like implement for cleaning or coating.

- (1) Note. Included here is a swab or sponge container.

SEE OR SEARCH THIS CLASS, SUB-CLASS:

209, for a container for a brush plus a contacting medium.

SEE OR SEARCH CLASS:

15, Brushing, Scrubbing, and General Cleaning, for a brush, per se.

401, Coating Implements With Material Supply, subclass 129 for a supply container with a brush applicator.

362 Plural:

This subclass is indented under subclass 361. A container for two or more brushes.

SEE OR SEARCH THIS CLASS, SUB-CLASS:

372+, for a container for plural tools and see search notes thereunder.

362.1 Transverse bristle:

This subclass is indented under subclass 362. A container wherein work contacting elements of the brush are normal to the extent of the handle.

- (1) Note. The patents for a brush container collected here usually pertain to tooth brush holders.

SEE OR SEARCH CLASS:

211, Supports: Racks, subclasses 65+ for a brush rack.

362.2 Transverse bristle:

This subclass is indented under subclass 361. A container wherein the work contacting elements of the brush are normal to the extent of the handle.

362.3 Projecting handle:

This subclass is indented under subclass 362.2. A container wherein the brush handle extends out of the container.

362.4 Folded blank:

This subclass is indented under subclass 361. A container formed from an erectable scored or crease-marked sheet or material.

363 Body treatment (i.e., surgical, but not cosmetic):

This subclass is indented under subclass 349. A container for a tool or instrumentality employed for medical or dental purposes.

- (1) Note. While the terms “medical” or “dental” are used in a very broad sense, they are not taken to include tools for cosmetic or toilet use. See search notes to Class 132, below.

SEE OR SEARCH THIS CLASS, SUB-CLASS:

210, for a container for a body treatment tool including a tool contacting medium.

306, for a container for a thermometer.

SEE OR SEARCH CLASS:

128, Surgery, appropriate subclasses for surgery tools, per se.

132, Toilet, subclasses 286+ for toilet kits.

570, Organic Compounds, for a therapeutic type kit including tools plus other medicinal articles or materials, e.g., first aid kit.

364 Syringe (e.g., enema or catheter, per se):

This subclass is indented under subclass 363. A container for an instrumentality to induce fluid into the body.

- (a) Included here is a container for an enema or douche bags, a hypodermic syringe, a catheter, etc., and components thereof.

- 365 Hypodermic or needle, per se:**
This subclass is indented under subclass 364. A container for a device, or its component parts, used to inject fluid under or through the skin.
- (1) Note. Included here is a container for a hypodermic needle, per se.
- SEE OR SEARCH THIS CLASS, SUB-CLASS:
210, for a container including an ancillary contacting medium for a body treatment tool.
380+, for a container to hold a plurality of other needle-like tools.
- 366 Plural:**
This subclass is indented under subclass 365. Container for two or more hypodermic devices.
- 367 Vaccine point:**
This subclass is indented under subclass 363. A container wherein the instrumentality is a splinter, or analogous small carrier, charged with a medicinal material, usually cowpox and ordinarily meant to be used once and discarded.
- SEE OR SEARCH CLASS:
604, Surgery, subclasses 46+ for vaccinating needles and holders.
- 368 Dental:**
This subclass is indented under subclass 363. A container for a dental tool.
- SEE OR SEARCH CLASS:
433, Dentistry, subclasses 25+ for a dental tool, per se, especially subclass 116 for a protective cover for a dental tool, employed while using the tool.
- 369 Plural:**
This subclass is indented under subclass 368. A container for two or more dental tools.
- SEE OR SEARCH THIS CLASS, SUB-CLASS:
372+, for a container for plural tools and see search notes thereunder.
- 370 Plural or diverse:**
This subclass is indented under subclass 363. A container for (a) two or more medical tools, or (b) a medical tool plus a tool for some other purpose.
- SEE OR SEARCH THIS CLASS, SUB-CLASS:
372+, for a container for plural tools and see search notes thereunder.
373, for a container for plural diverse tools.
- 371 Desk-clerical, drafting or engineering type:**
This subclass is indented under subclass 349. A container for a hand instrumentality used in (a) secretarial activity or (b) technical drawing.
- (1) Note. Included here is a container for a pen, pencil or drawing compass.
- SEE OR SEARCH THIS CLASS, SUB-CLASS:
224, for a draftman or lettering kit.
- 372 Plural:**
This subclass is indented under subclass 349. A container for two or more tools.
- (1) Note. See (1) Note under subclass 373 for the distinction between “plural” and “diverse”.
- SEE OR SEARCH THIS CLASS, SUB-CLASS:
234, for a pocket container for tools.
305, for a container for plural instruments.
336, for a container for plural safety pins.
337, for a container for plural forked hairpins.
354+, for a container for plural razor blades.
362, for a container for plural brushes.
369, for a container for plural dental tools.
370, for a container for plural or diverse body treatment tools.
- 373 Diverse:**
This subclass is indented under subclass 372. A container wherein at least one of the plural tools is a distinctly different instrumentality, e.g., a hammer and a saw.
- (1) Note. Variations in size or material are not considered a “distinct” difference,

and a container for such multiple tools is classified under "plural" above.

SEE OR SEARCH THIS CLASS, SUB-CLASS:

223+, for a container for an appliance plus ancillary tools.

234, for a pocket container for tools.

370, for a container for diverse body treatment tools.

374 Common handle:

This subclass is indented under subclass 373. A container wherein each of the diverse tools utilizes the same manually held member for actuation.

- (1) Note. Because so many of the wrenches of subclasses 376+ and drills or taps of subclass 379 also utilize a common handle, no cross-references for this feature have been made to this (374) subclass. A full search for a container for diverse tools with a common handle must include subclasses 376+ and 379+.

SEE OR SEARCH THIS CLASS, SUB-CLASS:

275, for a container for plural tools with a common handle.

SEE OR SEARCH CLASS:

16, Miscellaneous Hardware (e.g., Bushing, Carpet Fastener, Caster, Door Closer, Panel Hanger, Attachable or Adjunct Handle, Hinge, Window Sash Balance, etc.), subclasses 110.1+, for a handle, per se, and see search notes thereunder for loci of other handles.

375 Common handle:

This subclass is indented under subclass 372. A container wherein the container also encases a manually held actuation member, which member is the same for all the plural tools.

SEE OR SEARCH THIS CLASS, SUB-CLASS:

374, for a container for diverse tools with a common handle.

376 Wrenches:

This subclass is indented under subclass 372. A container for instrumentalities for applying torque to an article, generally for turning (or holding against turning) of a nut or bolt.

SEE OR SEARCH CLASS:

81, Tools, subclasses 52+ for wrenches, per se.

377 Inserted type:

This subclass is indented under subclass 376. A container wherein the wrenches are of the type which mate internally of an article to be turned, or held against turning.

378 Socket type:

This subclass is indented under subclass 376. A container wherein the wrenches are of the type which mate externally over the end of an article to be turned, or held against turning.

379 Drills or taps:

This subclass is indented under subclass 372. A container for instrumentalities which (a) cut a hole in material by advancing along the axis about which they rotate or (b) cut a thread interior of a hole.

SEE OR SEARCH CLASS:

408, Cutting by Use of Rotating Axially Moving Tool, subclasses 199+ for a drill or tap, per se.

380 Needle type (e.g., sewing, knitting and including pins, toothpicks):

This subclass is indented under subclass 372. A container wherein the tools are slender elongated elements or similar articles not elsewhere classified.

SEE OR SEARCH THIS CLASS, SUB-CLASS:

96+, for a match packet or container. Included with matches are toothpicks when such toothpicks are held as a group rather than as individual members.

338+, for a container for a fastener. Included as a fastener is a nail.

443, for a container for plural rod-like articles.

381 Phonograph 'needle':

This subclass is indented under subclass 380. A container for the stylus of an audio recording or reproducing device.

SEE OR SEARCH CLASS:

369, Dynamic Information Storage or Retrieval, subclass 172 for a stylus holder including a container to hold and permit consecutive replacement of plural styli.

382 Carried in aperture of, or pierced through, retainer:

This subclass is indented under subclass 380. A container wherein the needle or needle-like articles are retained in holes of a supporting member.

SEE OR SEARCH THIS CLASS, SUBCLASS:

347, for a fastener held in the aperture of a support member.
562+, for a tray-type container including an aperture to hold an article.

383 Plane of retainer normal to extent of 'needles':

This subclass is indented under subclass 382. A container wherein the "needles" are held perpendicular to the general plane of the supporting member.

SEE OR SEARCH THIS CLASS, SUBCLASS:

346, for a fastener held in a plane normal to that of a flaccid support member.

384 FOR GREASE GUN CHARGE OR CARTRIDGE:

This subclass is indented under the class definition. A container for a measured volume of a relatively heavy viscous lubricating material adapted to fit into a dispensing means.

385 FOR LIPSTICK OR REFILL CARTRIDGE:

This subclass is indented under the class definition. A container for a waxy colored lip cosmetic or a measured volume thereof to fit into a dispensing means.

SEE OR SEARCH CLASS:

132, Toilet, subclass 286 for a cosmetic stick type toilet kit.

386 WITH PALLET FEATURE:

This subclass is indented under the class definition. A container including a characteristic, or structure, specialized to an article handling skid (platform or package) arranged to be moved by a fork lift truck.

- (1) Note. Included here is a stack of articles so bundled as to provide openings for the forks of a lift truck.

SEE OR SEARCH CLASS:

108, Horizontally Supported Planar Surfaces, subclasses 51.11+ for an industrial platform, or skid, per se.
410, Freight Accommodation on Freight Carrier, subclass 35 for a group of articles packaged together with an on-and-off base for shipment as a unit on board a freight carrier; and wherein interengaging means (e.g., a load lashing means) is provided between the load unit and the freight carrier for retaining or otherwise accommodating the load unit thereon against the hazards of transportation; and subclass 46 for a shipping support unit on which a single article only is prepackaged on an on-and-off base for shipment as a load unit on board a freight carrier, with or without the accommodating means interengagingly reacting between the load unit or the freight carrier.

387.1 For holding a tape cassette:

This subclass is indented under subclass 307. A container including a structure for removably containing an encased elongated strip of recording medium on which information may be stored.

SEE OR SEARCH CLASS:

211, Supports: Racks, especially subclasses 40 and 41.1+ for a rack for holding recording media.
360, Dynamic Magnetic Information Storage or Retrieval, subclass 132 for a housed magnetic tape, per se.

387.11 Including structure intended to prevent theft or unauthorized use:

This subclass is indented under subclass 387.1. A container including a structure intended to deter pilferage or unapproved access to the contents.

SEE OR SEARCH THIS CLASS, SUB-CLASS:

1.5, for a container including a structural locking modification.

387.12 Including a reciprocating support:

This subclass is indented under subclass 387.1. A container including a supporting surface which slides relative to the container for holding the recording medium.

SEE OR SEARCH CLASS:

312, Supports: Cabinet Structure, subclasses 9.1+ for a cabinet for recording media.

387.13 Including book-type cover:

This subclass is indented under subclass 387.1. A container including a spine and panels hinged thereto.

SEE OR SEARCH THIS CLASS, SUB-CLASS:

472, for a book-type cover including an attached article retainer not intended to hold cassettes.

387.14 For plural different sized cassettes or boxed and unboxed cassettes:

This subclass is indented under subclass 387.1. A container including a structure for containing (a) multiple cassettes not of unitary dimensions or (b) both a cassette with a removable housing and an unboxed cassette.

387.15 Including plural slots for plural cassettes:

This subclass is indented under subclass 387.1. A container including multiple narrow grooves for holding multiple cassettes.

388 NONSPOOLED FILAMENTARY MATERIAL (E.G., SKEIN):

This subclass is indented under the class definition. A container for attenuated strand or thread in hank-like form.

(1) Note. Included here as strand or thread are fiber, line, cord, ribbon, twine, braid, etc.

SEE OR SEARCH THIS CLASS, SUB-CLASS:

389, for similar material arranged in roll form with or without a core member.

SEE OR SEARCH CLASS:

242, Winding, Tensioning, or Guiding, subclasses 159+ for similar material in roll form with or without a core member.

389 FOR ROLL OR REEL:

This subclass is indented under the class definition. A container or wrapper, for coiled or wound material with or without supporting structure (e.g., core or spool) wherein the coiling or winding, or unwinding, is disclosed as performed while said material is disassociated from the encompassing container or wrapper.

(1) Note. The material may be (a) relatively wide fabric (e.g., sheeting, wire fencing, batting, floor covering, etc.), (b) narrow band (e.g., tape bandaging, film etc.) (c) attenuated (e.g., strand, tube, wire, cable, etc.) and (d) single or multilayer.

(2) Note. The term "encompassing container or wrapper" includes: (a) a box with or without a lid (b) a bag or envelope (c) a sheet covering-solid, foraminous or articulated (d) a strand, or band, toroid-coiled about the wound material, i.e., transversely through a central axially opening (e) a peripheral band, tube or cylinder with end closures.

(3) Note. The term "disassociated" is used to indicate that there is a destruction (or irreversible modification) of wrapper, package, cover material retainer structure in order to wind or unwind content material. Thus undoing a mere fold, flap or tuck in cover material is not destruction. However, note that subclasses 53, 54 and 55 have been retained in this class (206) though the clamp retainer is not destroyed to wind or unwind content. See search note to Class 242, below.

- (4) Note. In (2) and (3) Notes, above, the “container” or “wrapper” or “securement” may be a single unitary member or put together of multiple elements.
- SEE OR SEARCH THIS CLASS, SUB-CLASS:
 225+, for a kit including wound material.
 308, for a music roll container.
 316.1, for a container for a photographic film roll.
 338+, for a container of fasteners in roll form.
 380+, for a container of needle type tools in roll form.
 387.1+, for a container for a tape cartridge.
 388, for a container for nonspooled filamentary material.
 613+, for a tapelike container for electrical components.
- SEE OR SEARCH CLASS:
 242, Winding, Tensioning, or Guiding, particularly subclasses 326+, 341+, 348+, and 588+ for an enclosed coil holder designed for winding or unwinding while a coil remains with the container, and subclasses 159+ for a coiled storage package, per se.
- 390 Concatenated articles:**
 This subclass is indented under subclass 389. A container wherein content items are joined together so as to form a band or strip, which band or strip is then coiled or wound.
- SEE OR SEARCH THIS CLASS, SUB-CLASS:
 338+, for fasteners coiled in a similar manner.
 380+, for needle type tools supported in similar fashion.
- 391 Plural rolls:**
 This subclass is indented under subclass 389. A container for two or more distinct coils.
- 392 Yarn:**
 This subclass is indented under subclass 391. A container wherein the material is textile filamentary material.
- 393 Material extended between rolls:**
 This subclass is indented under subclass 391. A container wherein the coiled filament, strip or web is continuous from coil to coil.
- 394 Axially aligned rolls:**
 This subclass is indented under subclass 391. A container wherein two or more of the coils extend along the same axis.
- 395 Folded blank:**
 This subclass is indented under subclass 389. A container erected from a scored or crease-marked sheet or panel.
- 396 Having core flap:**
 This subclass is indented under subclass 395. A container including a tab or element struck up from the sheet, which tab engages the central opening of the coil.
- SEE OR SEARCH THIS CLASS, SUB-CLASS:
 303, for a container for an annular article.
 397, for a nonfolded blank container which utilizes the central opening of the coil to secure said coil.
- 397 Wrapped, boxed, or secured through roll core:**
 This subclass is indented under subclass 389. A container which utilizes the central opening of a coil to secure said coil.
- SEE OR SEARCH THIS CLASS, SUB-CLASS:
 303, for a container for an annular article.
 396, for a folded blank container with a core flap.
- 398 Peripheral reel cover:**
 This subclass is indented under subclass 389. A container for a flanged spool with enclosing means, completely or partially, bridging the space between spool flanges or spool ends.
- 399 Slat type:**
 This subclass is indented under subclass 398. A container wherein the enclosing means are a plurality of bar-like members, spaced or abutting each other.

- 400 Single strip encircles reel:**
This subclass is indented under subclass 398. A container wherein said enclosing material is a band or web with juxtaposed and releaseably secured ends.
- SEE OR SEARCH THIS CLASS, SUB-CLASS:
398, for a peripheral fixed sleeve reel cover.
- 401 Sheet segments:**
This subclass is indented under subclass 398. A container wherein said enclosing means are a plurality of panels successively disposed around the spool.
- (1) Note. Included here are sheet segments with edge portions deflected from the arcuate "panel" segments.
- 402 Reel flange closes outlike container:**
This subclass is indented under subclass 397. A container wherein said enclosing means is the cylindrical skirt portion of an open ended can member the radial spool end serving as a terminus for said can member.
- 403 Complementary bodies:**
This subclass is indented under subclass 389. A container wherein two facing casing sections conjointly enclosed coiled or wound material.
- 404 Quick release:**
This subclass is indented under subclass 403. A container including means for rapid or snap opening action of the casing sections.
- (1) Note. Included here are casing sections that effect a quick release by translation relative to each other.
- 405 Central connection:**
This subclass is indented under subclass 404. A container including latching means is a middle portion of the casing sections.
- 406 Resilient retainer:**
This subclass is indented under subclass 405. A container including a yieldable or elastic securement means for said latch.
- 407 Tubular housing with attached end wall:**
This subclass is indented under subclass 389. A container including a cylindrical casing with a distinct radial terminus.
- (1) Note. Included here is a casing formed by a helically wound strip.
- (2) Note. Included here is a casing with concentric, spaced cylindrical walls between which material is disposed.
- 408 With content positioner:**
This subclass is indented under subclass 389. A container including a support or retainer means to hold a coil in fixed location in or on the container.
- 409 With pay-out aperture:**
This subclass is indented under subclass 389. A container having an opening in cover material through which content can be incrementally removed.
- (1) Note. Access to the opening requires destruction of a sealing element or removal of a portion of cover material. See line note to Class 242 in subclass 389 of this (206) class.
- 410 Flaccid wrapper:**
This subclass is indented under subclass 389. A container including a sheet or panel of pliant or supple cover material.
- SEE OR SEARCH THIS CLASS, SUB-CLASS:
548, for a camp or lunch kit with a flaccid wrapper.
- 411 Adhesive tape:**
This subclass is indented under subclass 389. A container wherein the content material has one surface bondable to some other surface subsequent to uncoiling from the container.
- 412 Interleaved roll components:**
This subclass is indented under subclass 389. A container including two or more like or different elements in superposed, unattached relation.

- 413 With end protector:**
This subclass is indented under subclass 389. A container including a radial shield against, or adjacent, the side of coiled material, with means to hold the shield in position.
- SEE OR SEARCH CLASS:
428, Stock Material or Miscellaneous Articles, appropriate subclasses for stock material in the form of a single or plural layer web or pad or sheet, from which the shield protector may be made, and especially subclasses 182+ for a corrugated web or sheet, and subclasses 304.4+ for a composite web or sheet embodying a component or porous or cellular material.
- 414 Circumferential flange type:**
This subclass is indented under subclass 413. A container including a short cylindrical rim portion.
- 415 Core secured:**
This subclass is indented under subclass 413. A container including an element positioned within the axial opening of the coil to hold the shield.
- 416 Opposite end protectors to same core:**
This subclass is indented under subclass 415. A container wherein both sides are shielded and both shields are held by the same element within the axial opening of the coil.
- 417 Batt:**
This subclass is indented under subclass 389. A container wherein the content material is an unwoven mat of lengths of filamentary material.
- 418 FOR A FILAMENT OR SPACE DISCHARGE BULB OR TUBE:**
This subclass is indented under the class definition. A container of an electric light, or electronic valve, in its envelope.
- (1) Note. Included here is a container for (a) an incandescent, fluorescent or flash lamp or (b) a radio TV or radar tube.
- SEE OR SEARCH THIS CLASS, SUBCLASS:
68, for a container for an incandescent mantle.
426, for a container for stemware.
521+, for a shock protection type container.
- 419 Plural:**
This subclass is indented under subclass 418. A container for two or more bulbs or tubes.
- 420 Set:**
This subclass is indented under subclass 419. A container wherein at least several of the bulbs or tubes are of different size or have different electrical characteristics.
- 421 Axially aligned:**
This subclass is indented under subclass 419. A container wherein the bulbs are positioned end to end.
- SEE OR SEARCH THIS CLASS, SUBCLASS:
430, for a container for coaxial abutting receptacles.
- 422 Allochiral arrangement:**
This subclass is indented under subclass 419. A container wherein the bulbs are positioned side by side, with adjacent bulbs inverted end for end.
- (1) Note. Such allochiral arrangement permits limited "nesting" of one bulb with respect to its adjacent bulb.
- 423 FOR A PLANT, FLOWER, OR TREE (INCLUDES CUT OR ARTIFICIAL):**
This subclass is indented under the class definition. A container for holding growing, freshly cut, or imitation vegetation.
- (1) Note. Included here is a container for an imitation floral decoration.
- SEE OR SEARCH THIS CLASS, SUBCLASS:
303, for a container for an annular article (e.g., a floral wreath).

SEE OR SEARCH CLASS:

47, Plant Husbandry, subclasses 41+, 66.1+ and particularly subclass 84 for holders for cut flowers used in floral arrangements, the combination of a growing plant and a receptacle, or a receptacle specialized to preserving the life of a plant.

428, Stock Material or Miscellaneous Articles, subclass 23 for artificial or treated natural vegetation combined with a means, other than a receptacle or container, to support the vegetation.

424 FOR A BOOK:

This subclass is indented under the class definition. A container for sheets or pages bound together by a cover.

425 FILE FOR PLURAL CARDS OR SHEETS:

This subclass is indented under the class definition. A container for paper record items, which container permits removal, inspection or annotation of individual items.

(1) Note. Included here are file subcombinations (such as a follower, per se), not elsewhere classified.

(2) Note. The file may include blank or annotated items.

SEE OR SEARCH THIS CLASS, SUBCLASS:

39+, for a pocket case for tickers, cards, stamps, etc.

424, for a container for "bound" sheets.

556, for a plate or sheet container with a follower.

557, for a tray-type container.

SEE OR SEARCH CLASS:

229, Envelopes, Wrappers, and Paperboard Boxes, subclasses 67.1+ for a file folder or file envelope.

281, Books, Strips, and Leaves, for "bound" records and components thereof.

402, Binder Device Releasably Engaging Aperture or Notch of Sheet, appropriate subclass, for an apertured or notched sheet retainer, which sheet

can be removed without mutilation of said sheet.

426 FOR STEMWARE:

This subclass is indented under the class definition. A container for a goblet type drinking vessel-usually one with a stem and foot.

427 FOR PLURAL BEVERAGE-TYPE RECEPTACLES:

This subclass is indented under the class definition. A container for two or more potable liquid vessels, e.g., cans, bottles or jars.

(1) Note. Included here is a container for articles - other than cans, bottles or jars - when such articles are supported in like manner.

SEE OR SEARCH THIS CLASS, SUBCLASS:

139+, for a similar container which includes spacer means between adjacent cans or bottles and means for pendulously hand supporting the assemblage.

SEE OR SEARCH CLASS:

229, Envelopes, Wrappers, and Paperboard Boxes, subclass 934 for a cross-reference art collection of plural blanks of paperboard or similar material intended for use as a partitioned receptacle to transport bottles.

428 Strap-type handle:

This subclass is indented under subclass 427. A container including a strip of flexible material for manual support.

429 Container exposes one side or row of retained receptacles:

This subclass is indented under subclass 427. A container wherein the side of a file of adjacent cans or bottles is open to view.

(1) Note. Such exposure or opening allows viewing of container content when plural containers are stacked one above the other.

430 Coaxial, abutting receptacles:

This subclass is indented under subclass 427. A container wherein at least two retained vessel are engaged end to end.

- SEE OR SEARCH THIS CLASS, SUB-CLASS:
421, for a container for axially aligned light bulbs.
- 431 Noncylindrical receptacles:**
This subclass is indented under subclass 427. A container wherein the retained vessels are generally of square or rectangular cross-sectional shape.
- 432 Shrink-type wrapper:**
This subclass is indented under subclass 427. A container including a generally thin, flaccid material drawn against the contents or portions of the container itself.
- (1) Note. Usually the shrinking is effected by heat or vacuum treatment.
- SEE OR SEARCH THIS CLASS, SUB-CLASS:
497, for a shrink film package.
- 433 Shock protection:**
This subclass is indented under subclass 427. A container including specific means for preventing, or minimizing, damage to retained vessels during rough handling of the container.
- SEE OR SEARCH THIS CLASS, SUB-CLASS:
521+, for a shock protection type container.
- 434 Four-sided wrapper:**
This subclass is indented under subclass 427. A container including (a) parallel side walls respectively positioned adjacent opposite sides or ends of a row, or parallel rows, of retained vessels and (b) top and bottom walls integrally joined to said side walls and positioned adjacent the ends of said vessels, said container having no end walls.
- 435 Inwardly moving side member:**
This subclass is indented under subclass 427. A container having (a) a base with vessels aligned in a row thereon and (b) a panel, bar, rod, or other elongate component shiftable relative to said base to engage one side of said vessels, thereby holding the vessels, in the container.
- 436 FOR PLURAL TETRAHEDRON RECEPTACLES:**
This subclass is indented under the class definition. A container for two or more four-sided vessels.
- (1) Note. Typically, the vessels are made of flaccid triangular panels closed onto each other to completely encompass the content.
- (2) Note. Included here are arrangements of four-sided receptacles in a container to minimize requirements and provide mutual support.
- 438 FOR BODY TREATMENT ARTICLE OR MATERIAL (I.E., 'SURGICAL' OR THERAPEUTIC TYPE):**
This subclass is indented under the class definition. A container for an object or substance adapted for use in the treatment of wounds or diseased portions of the body.
- (1) Note. See search note under subclass 363 for cosmetic or toilet body treatment.
- SEE OR SEARCH THIS CLASS, SUB-CLASS:
363+, for a container for a therapeutic type tool, per se, or a plurality or kit of such tools.
524.1+, for a container with specified material for the cover or content.
570, for an assemblage or kit of the therapeutic type, e.g., a first aid kit of tools and medicine.
- 439 With gas permeable cover:**
This subclass is indented under subclass 438. A container wherein at least a portion of the container material permits the ingress or egress of a gaseous state substance.
- (1) Note. Generally the gas serves to treat, or protect against treatment of, the content.
- 440 Bandage, drape or dressing:**
This subclass is indented under subclass 438. A container for a wrapping or cover for a wound.

- SEE OR SEARCH CLASS:
602, Surgery: Splint, Brace, or Bandage, subclasses 41+ for bandage structure.
- 441 Short strip type:**
This subclass is indented under subclass 440. A container wherein the wound cover is a relatively narrow band of limited length and generally in flat form.
- 442 BALE-TIE PACKAGE:**
This subclass is indented under the class definition. A container for wire, or strap-like, securement elements used to fasten or hold bundled material.
- SEE OR SEARCH THIS CLASS, SUBCLASS:
83.5, for a bale package, per se.
- SEE OR SEARCH CLASS:
428, Stock Material or Miscellaneous Articles, subclass 594 for metallic stock material having plural layers mechanically fastened together.
- 443 FOR PLURAL RODLIKE ARTICLES:**
This subclass is indented under the class definition. A container for two or more objects generally circular in cross-section and relatively long in an axial direction as compared to the cross-section dimension.
- SEE OR SEARCH THIS CLASS, SUBCLASS:
315.11, for a quiver for arrows.
338+, for a container for nails.
371, for a container for pencils or pens.
379, for a container for drills or taps.
380+, for a container for needle type tools including pins and toothpicks.
- SEE OR SEARCH CLASS:
211, Supports: Racks, subclasses 60.1+ for a support or rack for holding an article having a significant elongated portion.
- 445 FOR PLURAL DISCLIKE ARTICLES (E.G., BOTTLE CAPS):**
This subclass is indented under the class definition. A container for two or more relatively flat, circular panels.
- (1) Note. Usually the panels are stacked with faces aligned to form a cylindrical assemblage within the container.
- 446 FOR CYLINDER:**
This subclass is indented under the class definition. A container for a barrel-like, or drum-like, member.
- (1) Note. Excluded from this subclass is a container for a woundup reel or roll of material, for which see search notes below.
- (2) Note. Included here is a container for a printing roll.
- SEE OR SEARCH THIS CLASS, SUBCLASS:
15, for a phonograph cylinder container.
308, for a music roll container.
389+, for a container for a roll, or reel, of material and see notes thereunder for the locus of other roll, or reel, packages.
- 447 FOR TACKY MATERIAL (E.G., FLY PAPER):**
This subclass is indented under the class definition. A container for a sticky or adhesive faced article, generally so held as to inhibit or avoid cohesion.
- 448 FOR CURVED PANEL (E.G., CURVED AUTO GLASS):**
This subclass is indented under the class definition. A container configured, or including adjunct retainer structure, for a curvilinear plate or plate-like member.
- (1) Note. Included here is a wrap-around windshield container.
- 449 FOR PLATE OR SHEET:**
This subclass is indented under the class definition. A container for a generally flat panel, pane or leaf.
- (1) Note. Generally, plural sheets in this subclass are in face-to-face alignment, e.g., a stack or pack, or in spaced parallel position.

SEE OR SEARCH THIS CLASS, SUB-CLASS:

- 39+, for a pocket type ticket case. See (1) Note under subclass 37.
- 73+, for a tray container for card or sheet.
- 215, for a stationery or carbon paper container.
- 323+, for a shingle container.
- 386, for a container including a pallet feature.
- 389, for a container for textile web-like material.
- 425, for a file for plural cards or sheets.
- 554, for a container for paper bags.

450 Book-type cover with attached retainer:

This subclass is indented under subclass 449. A container including a securement member on a folded ply holder for said panel, pane or leaf.

SEE OR SEARCH CLASS:

- 294, Handling: Hand and Hoist-Line Implements, subclass 138 for a book cover provided with a carrying handle.

451 Bound or clamped package:

This subclass is indented under subclass 449. A container wherein a plurality of panels or panes are secured together, usually by a band or rod-like element or gripper.

- (1) Note. A glued edge or adhesive securement is not "bound".

452 Threaded clamping member:

This subclass is indented under subclass 451. A container wherein the band or rod-like element includes a screw-nut arrangement.

453 Corner or edge protector:

This subclass is indented under subclass 449. A container including a separate element to shield the sharp extremities of the panel or pane.

- (1) Note. Included here is a corner or edge protector, per se.

SEE OR SEARCH CLASS:

- 428, Stock Material or Miscellaneous Articles, appropriate subclasses for stock material in the form of a single or plu-

ral layer web or pad or sheet, from which the shield protector may be made, and especially subclasses 182+ for a corrugated web or sheet, and subclasses 304.4+ for a composite web or sheet embodying a component or porous or cellular material.

454 Fragile or sensitive (e.g., glass mirror):

This subclass is indented under subclass 449. A container for panel or pane that is frail, weak or chemically-physically susceptible to change under normal ambient conditions.

SEE OR SEARCH THIS CLASS, SUB-CLASS:

- 307+, for a container under the class definition for removably containing a machine readable recording medium.
- 309+, for a phonographic disk container.
- 524.1+, for an acid proof container.

455 Photo film or plate:

This subclass is indented under subclass 454. A container for an undeveloped light-sensitive panel.

456 Specimen or photo slide:

This subclass is indented under subclass 454. A container for a microscope, or projection transparency.

457 WITH ORNAMENTATION OR SIMULATION:

This subclass is indented under the class definition. A container exhibiting a desired visual effect by a means which (a) includes coloration, (b) forms a design configuration by relationship of container or content component, (c) assumes the appearance of a disparate object, e.g., animal or human figure.

458 Simulates wearing of article:

This subclass is indented under subclass 457. A container for an item of apparel, or an accessory therefor, (a) so positioned as to display the item as actually worn or (b) an item which appears to be such apparel or accessory being worn.

SEE OR SEARCH THIS CLASS, SUB-CLASS:

- 278+, for a container for apparel.

459.1 WITH INDICATOR (I.E., VARIABLE INFORMATION EXHIBITING MEANS):

This subclass is indented under the class definition. A container including (1) means intended to change in appearance or in any other sensory-evident way for the purpose of conveying information about the container or its contents, or (2) means intended to show a change in the container or its contents.

SEE OR SEARCH THIS CLASS, SUBCLASS:

- 459.5, for a container with static information exhibiting means.
534, for an ampule, capsule, pellet or granule with an indicator.

SEE OR SEARCH CLASS:

- 49, Movable or Removable Closures, subclasses 13+ for a closure of that class type with a condition signal or indicator.
62, Refrigeration, subclasses 125+ for a refrigeration device with an indicator.
73, Measuring and Testing, appropriate subclasses for a measuring or testing indicator which may be used with a receptacle.
99, Foods and Beverages: Apparatus, subclass 285 for a coffee maker with a signal, indicator or observation means and subclass 342 for a cooking device with a signal, indicator or observation means.
109, Safes, Bank Protection, or a Related Device, subclass 31 for a safe with a signal or indicator.
116, Signals and Indicators, appropriate subclasses for a mechanical signal or indicator which may be used on a receptacle, particularly subclasses 200+ for an indicator, per se.
122, Liquid Heaters and Vaporizers, subclass 504.2 for a boiler with an alarm or indicator.
126, Stoves and Furnaces, subclass 388.1 for a fluid fuel burner other than a top-accessible liquid heating vessel and an indicator or signaler feature.
137, Fluid Handling, subclasses 551+ for a fluid handling system or device with indicator, register, recorder alarm or inspection means.

- 138, Pipes and Tubular Conduits, subclass 104 for a pipe with indicating means.
141, Fluent Material Handling, With Receiver or Receiver Coating Means, subclasses 94+ for a device of that subclass type with signal, indicator, recorder, exhibitor or inspection means.
165, Heat Exchange, subclasses 11.1+ for a device of that class type with alarm, indicator, signal, register, recorder test or inspection means.
215, Bottles and Jars, subclasses 365+ for a bottle or jar with content indicating means.
220, Receptacles, Digest 16 for a digest of receptacles with a pressure indicator.
221, Article Dispensing, subclasses 2+ for a dispenser with a recorder, register, indicator, signal or exhibitor and subclass 155 for a dispenser with transparent inspection means without indicia.
232, Deposit and Collection Receptacles, subclasses 34+ for a mail box with a signal or indicator.
312, Supports: Cabinet Structure, subclasses 234+ for a receptacle with supporting means of that class type with an exhibitor or indicator.
340, Communications: Electrical, appropriate subclasses for an electrical indicator which may be used in combination with a receptacle.
426, Food or Edible Material: Processes, Compositions, and Products, subclasses 87+ for a food container or product with indicating means.
428, Stock Material or Miscellaneous Articles, subclass 913 for a cross-reference art collection for a material designed to be responsive to temperature, light moisture, etc.

459.5 WITH INDICIA OR AREA MODIFIED FOR INDICIA:

This subclass is indented under the class definition. A container including a static information exhibiting means or a surface portion specifically modified for static information exhibiting means.

- (1) Note. The information is usually about the container or its contents.

SEE OR SEARCH THIS CLASS, SUB-CLASS:

- 232, for a package in combination with a booklet, leaflet or recording means.
- 281, for a container including indicia which is intended to hold an article of clothing.
- 459.1, for a container with variable information conveying means.
- 534, for an ampule, capsule, pellet or granule with indicia.
- 803, for a cross-reference art collection for a receptacle with a detachable coupon.

SEE OR SEARCH CLASS:

- 40, Card, Picture, or Sign Exhibiting, appropriate subclasses for a card or sign with indicia which may be used in combination with a receptacle, particularly subclasses 306+ for cylindrical box-carried indicia, subclass 308 for basket-carried indicia, subclasses 310+ for bottle-carried indicia, subclasses 312+ for box-carried indicia and subclass 324 for tableware-carried indicia.
- 52, Static Structures (e.g., Buildings), subclasses 311.1+ for a static structure with indicia.
- 215, Bottles and Jars, subclass 203 for a closure for a bottle or jar with visual indicia intended to warn a user as to the bottle contents, subclass 230 for a closure for a bottle or jar with visual indicia, and subclasses 365+ for a bottle or jar with content indicating means.
- 229, Envelopes, Wrappers, and Paperboard Boxes, subclass 921 for a cross-reference art collection for a paper or paperboard receptacle with mailing indicia.
- 283, Printed Matter, appropriate subclasses, particularly subclass 81 for a label for indicia where the invention relates to the printed matter rather than the physical characteristics of the label itself.
- 312, Supports: Cabinet Structure, subclasses 234.1+ for a receptacle with supporting means of that class type with content indicia.

- 426, Food or Edible Material: Processes, Compositions, and Products, subclasses 87+ for a food container or product with indicating means.
- 428, Stock Material or Miscellaneous Articles, subclass 187 for a structurally defined web or sheet with nonplanar uniform thickness in the form of indicia.

460 ARTICLE ADHESIVELY SECURED TO SUPPORT:

This subclass is indented under the class definition. A container consisting of a base or backer member on to which a content item is held by means of a glue, paste or other cementitious substance.

461 ARTICLE HOUSING ATTACHED TO PANEL:

This subclass is indented under the class definition. A container consisting of a relatively rigid plate-like backer member to which an enclosing cover for a content item is affixed.

- (1) Note. Included here are "bubble" or "blister" type packages.

462 Housing projects from panel aperture:

This subclass is indented under subclass 461. A container including an opening in the backer member with the enclosing cover extending through and above the plane of said plate-like member.

463 Projecting from both sides of panel:

This subclass is indented under subclass 462. A container wherein the enclosing cover extends from both sides of the plate-like member.

464 Tongue and slot-type attachment:

This subclass is indented under subclass 461. A container in which enclosing cover and backer member are joined together by a projection or tab on one frictionally fitting into a narrow opening in the other.

465 Housing flanges held in parallel slots in panel:

This subclass is indented under subclass 464. A container wherein flaps or tabs on opposite sides of said enclosing cover extend into parallel narrow openings in the plate-like member.

- 466 Bag-type housing:**
This subclass is indented under subclass 461. A container wherein said enclosing cover is a pouch or sack.
- 467 Movable or detachable housing closure:**
This subclass is indented under subclass 461. A container including a displaceable component for access to the content.
- SEE OR SEARCH CLASS:
220, Receptacles, subclasses 200+ for closures, per se, and see search notes thereunder for the locus of other similar closure.
- 468 Sliding:**
This subclass is indented under subclass 467. A container wherein said movable closure is translated.
- 469 Frangible:**
This subclass is indented under subclass 467. A container wherein said movable closure includes a tear line or weakened wall portion which must be ruptured to permit movement.
- 470 Hinged:**
This subclass is indented under subclass 467. A container wherein said movable closure is swingably connected to either said enclosing cover or said backer member.
- 471 Housing contoured to retain article:**
This subclass is indented under subclass 461. A container wherein the enclosing cover closely conforms to the shape of the content to hold said content.
- (1) Note. Generally, the enclosing cover is a thin film of flaccid sheet material.
- 472 BOOK-TYPE COVER WITH ATTACHED ARTICLE RETAINER:**
This subclass is indented under the class definition. A container wherein a folded ply enclosure includes at least one integral holding means for a content item.
- 473 Diverse retainers for one or more articles:**
This subclass is indented under subclass 472. A container including distinct, different, holders for each of plural content items.
- SEE OR SEARCH THIS CLASS, SUB-CLASS:
483, for diverse retainers for one or more articles held to a base.
- 474 Tongue and slot-type cover closure:**
This subclass is indented under subclass 472. A container wherein the folded ply enclosure includes a flap, or projection, frictionally engaging a narrow opening to maintain a folded closed position.
- 475 Content inspection opening in cover:**
This subclass is indented under subclass 472. A container including an aperture in the folded ply enclosure permitting examination of content.
- 476 ARTICLE IN TONGUE OR FOLD APERTURE:**
This subclass is indented under the class definition. A container consisting of a planar base member with a flap, tab, or loop element and a content item held (a) between said element and the base member or (b) within an opening in said element.
- 477 BASE WITH ATTACHED CLASPING-TYPE ARTICLE RETAINER:**
This subclass is indented under the class definition. A container consisting of a planar backer member to which is secured a holder to grasp the content.
- (1) Note. Included here is a holder such as a clip, clamp or band.
- SEE OR SEARCH THIS CLASS, SUB-CLASS:
560, for a tray-type container with means to latch or lock content against removal.
- SEE OR SEARCH CLASS:
248, Supports, subclass 510 for a clasp-down device, i.e., resilient means clasping an article on opposed sides to hold it onto an underlying support. See, too, subclasses 500+ for a hold-down device; i.e., means including an element which overlies an upwardly facing surface portion of an article to

hold the article onto a base. The overlying element may be resilient.

478 Pliant retainer:

This subclass is indented under subclass 477. A container wherein the holder is a flaccid or flexible element.

SEE OR SEARCH CLASS:

248, Supports, subclass 499 for tie-down structure; i.e., the use of flexible element means to secure an article to a base.

410, Freight Accommodation on Freight Carrier, subclasses 96+, for inventions in load lashing; i.e., the use of flaccid element means to secure lading to the base of a freight carrier during shipment.

479 Plural loops formed from continuous strip or strand:

This subclass is indented under subclass 478. A container wherein the holder is an extended length of band or filamentary material folded into multiple bights.

480 Resiliently biased rigid retainer:

This subclass is indented under subclass 477. A container wherein a stiff, or firm, holder is yieldably urged to grasp the content.

481 Rigid loop-type retainer:

This subclass is indented under subclass 477. A container wherein the holder is a stiff, or firm bight of material extending around at least a portion of the content.

482 Tongue-type retainer struck from base:

This subclass is indented under subclass 477. A container wherein the holder is a flap, or tab, cut and folded from the backer member.

483 Diverse retainers for one or more articles:

This subclass is indented under subclass 477. A container including at least two different holders to grasp a content item or plural content items.

(1) Note. "Different" holders are understood to refer to distinctions in kind rather than shape or size, e.g., a spring clip and a loop.

SEE OR SEARCH THIS CLASS, SUBCLASS:

473, for a folder ply type cover with diverse retainers for one or more articles.

484 LAMINATE SHEET PACKET:

This subclass is indented under the class definition. A container comprising content (an article or material) held between two flaccid sheets said sheets being sealed together completely around the content.

(1) Note. The "flaccid sheets" may themselves be either single or multilayered. See subclass 524.2 for specified multilayered cover construction or material.

SEE OR SEARCH THIS CLASS, SUBCLASS:

524.2, for a container with specified plural different lamina for the cover structure or material.

484.1 With gas permeable cover:

This subclass is indented under subclass 484. A container wherein at least a portion of the sheet cover material permit the ingress or egress of a gaseous state substance.

SEE OR SEARCH THIS CLASS, SUBCLASS:

439, for a container for a body treatment article or material with a gas permeable cover.

484.2 Cover of plural lamina:

This subclass is indented under subclass 484. A container wherein each flaccid sheet includes to or more layers of material.

SEE OR SEARCH THIS CLASS, SUBCLASS:

524.2, for a container including plural different lamina wall structure.

524.9, for a container including plural similar lamina wall structure.

SEE OR SEARCH CLASS:

428, Stock Material or Miscellaneous Articles, appropriate subclasses for laminate structure or material, per se.

485 ARTICLE HELD IN APERTURES OF OPPOSED WALLS:

This subclass is indented under the class definition. A container wherein a content item is supported in the openings of parallel (or facing) container sides or in the openings of parallel (or facing) portions of retainer structure.

485.1 Cuplike article:

This subclass is indented under subclass 485. A container which is intended to support a small handheld receptacle having curved wall structure.

- (1) Note. A cup is normally used to hold food such as a beverage, ice cream, nuts, etc.

SEE OR SEARCH THIS CLASS, SUB-CLASS:

519, for a cup, per se, modified for nesting.

SEE OR SEARCH CLASS:

220, Receptacles, appropriate subclasses for a cup, per se, which is made of a material other than paper or a paper-like material, particularly subclass 675.

486 ARTICLE HELD IN APERTURE IN BASE:

This subclass is indented under the class definition. A container wherein a content item is supported in the opening of a planar panel or sheet.

- (1) Note. Generally, the panel or sheet constitutes the basic "container" or "retainer" structure means for this class.

SEE OR SEARCH THIS CLASS, SUB-CLASS:

562+, for a tray-type container including an aperture to hold an article.

487 Tongue and slot-type base sample connection:

This subclass is indented under subclass 486. A container wherein the item includes a projection which is engaged in a complementary narrow opening of the panel.

SEE OR SEARCH THIS CLASS, SUB-CLASS:

464+, for an article housing attached to a panel by tongue and slot engagement.

488 Supplementary retainer:

This subclass is indented under subclass 486. A container including a separate and distinct support means for the item.

489 Sheet type:

This subclass is indented under subclass 488. A container wherein the separate support means is a flaccid film or lamina.

490 Peripheral aperture:

This subclass is indented under subclass 486. A container wherein the opening is a slot or groove of the edge of the support panel or sheet.

493 RETAINER ENTERS OPENING IN ARTICLE:

This subclass is indented under the class definition. A container which is received, in whole or part, within an aperture of a content item to hold or position said item.

- (1) Note. The retainer may be a projection, post, finger, annular sleeve, spindle, core, etc.

SEE OR SEARCH THIS CLASS, SUB-CLASS:

278+, for an apparel support that enters an opening in the apparel.

303+, for a container for an annular article.

310, for a phonograph disk with a spindle-like retainer.

389+, for a container for a roll or reel.

494 FOR FOLDED SHEETLIKE ARTICLE:

This subclass is indented under the class definition. A container wherein a flaccid panel is doubled upon itself.

- (1) Note. Generally the resultant arrangement is a compact visual display of the panel material.

- (2) Note. Included here is a container for a plurality of empty bags doubled upon themselves.

495 SUPPORT PANEL HAVING ARTICLE PINNED OR WRAPPED THEREON:

This subclass is indented under the class definition. A container consisting of a base or backer member (a) onto which a content item is pegged or pin-fastened or (b) about an edge of which a content item is folded.

- (1) Note. When the item is folded about plural edges it is considered a winding, for which see subclasses 389+.

496 Debris (e.g., ashes):

This subclass is indented under subclass 37. A container for trash; e.g., spent matches, tobacco refuse, discarded chewing gum.

- (1) Note. See search notes under subclass 125 for the locus of other debris receivers.

497 SHRINK FILM PACKAGE (E.G., BY HEAT OR VACUUM):

This subclass is indented under the class definition. A container consisting of a generally thin, flaccid material drawn against the content or portions thereof.

SEE OR SEARCH THIS CLASS, SUBCLASS:

- 432, for a shrink type wrapper for plural beverage type receptacles.

SEE OR SEARCH CLASS:

- 229, Envelopes, Wrappers, and Paperboard Boxes, subclasses 87.01+ for a wrapper, per se.

499 NESTING OR VERTICAL STACKING WITHIN CONTAINER OR WITHIN RETAINER:

This subclass is indented under the class definition. A container including a plurality of content items (a) either piled one on the other or (b) interfitted or mated.

- (1) Note. Included here, as a content item, is an article or a receptacle.

SEE OR SEARCH THIS CLASS, SUBCLASS:

- 501, through 520, for nesting or stacking of receptacles.

- 535+, for ampoules, capsules, pellets or granules stacked within a container.

500 Lamp shades, globes, reflectors:

This subclass is indented under subclass 499. A container for translucent, transparent or opaque lighting accessories which diffuse or direct light rays.

- (1) Note. Usually, those items are fragile and thus a complete search should include subclasses 521+, and see search notes thereunder.

501 DIFFERENT RECEPTACLES WITH MEANS FOR STACKING:

This subclass is indented under the class definition. Two or more containers wherein each of at least two, nonidentical or variant, containers has structure to coat with the structure of another container so that one may be superposed above the other in a relatively stable manner.

SEE OR SEARCH THIS CLASS, SUBCLASS:

- 499+, for nesting or vertical stacking within a container.
503+, for vertical stacking of similar receptacles.

502 Cup and saucer type:

This subclass is indented under subclass 501. Two or more containers wherein said containers are paired or related in use; e.g., culinary articles such as bowl-plate, cream-sugar set.

SEE OR SEARCH THIS CLASS, SUBCLASS:

- 508, for a container closure modification for stacking similar receptacles.

503 STRUCTURAL FEATURES FOR VERTICAL STACKING, I.E., SIMILAR RECEPTACLES:

This subclass is indented under the class definition. A container configured to engage with the configuration of an adjacent portion of another identical superposed container to enhance the stability of such piled containers without any one container occupying an established capacity of another.

- (1) Note. A container with mere planar top and bottom is not considered to have structure for vertical stacking for this subclass.
- (2) Note. In the pile or stack configuration the content of individual containers is not accessible.
- (3) Note. The established capacity of a container is considered to be the interior space disclosed as for content. That is, a flanged or rim portion at the container top to receive a lid is not part of the established capacity.

SEE OR SEARCH THIS CLASS, SUB-CLASS:

- 139+, for a portable segregating carrier for plural beverage type containers.
- 499+, for nesting or stacking within a container.
- 501+, for different receptacles with means for stacking.
- 514+, for nesting of different receptacles.
- 515+, for nesting of identical receptacles or closures.
- 554, for stacking of paper bags.

SEE OR SEARCH CLASS:

- 312, Supports: Cabinet Structure, appropriate subclasses, for pile of plural container-like members with access to the content of individual container-like members.
- 410, Freight Accommodation on Freight Carrier, subclasses 77+ for a device which secures freight unit supports (e.g., pallets) or containers to the carrier during shipment, and may further include the use of the device for attachment to the support or container for stacking one on another; or for a support or container having a particular construction for interfitting with the securement device.

504 Having specified means for lateral stacking:
This subclass is indented under subclass 503. A container including particular structure, or configuration, for side by side pile arrangement.

505 Having specified means for nesting instead of stacking:

This subclass is indented under subclass 503. A container including particular structure, or configuration, which permits selectively (a) piling one container on the other or (b) fitting or telescoping one container within the other.

- (1) Note. The nesting or interfitting of one container within the other totally, or in part, destroys the established capacity of the container.

- (2) Note. See (3) Note under subclass 503.

506 Selectively positioned abutment (e.g., bail or handle):

This subclass is indented under subclass 505. A container wherein an element is movable to (a) provide a support for piling or (b) allow interfitting.

507 By selective orientation of superposed receptacles:

This subclass is indented under subclass 505. A container wherein a relative horizontal rotation of one container with respect to another establishes the pile or interfit relationship.

508 Closure structure specified for stacking:

This subclass is indented under subclass 503. A container wherein the particular configuration of a removable lid provides structure to engage another identical container for piling.

509 Having vertical projecting element or recess for interlock:

This subclass is indented under subclass 503. A container wherein the engaging structure includes either a distinct upward (downward) protuberance or upward (downward) opening cavity.

- (1) Note. Often both a protuberance and a mating cavity are provided for stable piling of containers.

510 Handle type:

This subclass is indented under subclass 509. A container wherein the protuberance is an element disclosed as the means for carrying or moving the container.

511 Plural distinct feet or supports type:

This subclass is indented under subclass 509. A container wherein the protuberance is one of several ground, or base or table, engaging elements for the containers.

512 Corner lug or ear type:

This subclass is indented under subclass 509. A container wherein the protuberance is one of several elements at, or adjacent, the juncture of container sides.

513 Formed from wire or rod of reticulated body fabric:

This subclass is indented under subclass 503. A container formed or consisting substantially of attenuated openwork panels; e.g., milk crate, dish tray.

- (1) Note. Included here is a wire fabric container with a solid sheet bottom or bottom cover.

SEE OR SEARCH CLASS:

220, Receptacles, subclasses 485+, for wire body containers, per se.

514 DIFFERENT RECEPTACLES WITH STRUCTURAL FEATURES FOR NESTING:

This subclass is indented under the class definition. Two or more containers wherein each of at least two, nonidentical or variant, containers has a configuration which permits fitting or telescoping one container within the other.

- (1) Note. The nesting or interfitting one within the other totally or in part destroys the established capacity of the container.

- (2) Note. See (3) Note subclass 503.

SEE OR SEARCH THIS CLASS, SUBCLASS:

515+, for nesting of identical containers or closures.

515 STRUCTURAL FEATURES FOR NESTING IDENTICAL RECEPTACLES OR CLOSURES:

This subclass is indented under the class definition. A container configured to permit fitting one container within another identical container.

- (1) Note. See (1) and (2) Notes under subclass 514.

SEE OR SEARCH THIS CLASS, SUBCLASS:

514, for nesting of different receptacles.

516 With separate cushion or spacer means:

This subclass is indented under subclass 515. A container including a distinct buffer element to prevent a jam, or force fit, of interfitted or telescoped containers.

SEE OR SEARCH THIS CLASS, SUBCLASS:

217, for a drinking vessel combined with content.

519+, for a nestable container with structure to limit interfit.

517 Distortable for nesting or components of 'knockdown' receptacles:

This subclass is indented under subclass 515. A container wherein (a) the normal configuration or shape is changeable to permit interfitting or (b) container sections disclosed as made for repeated assembly and disassembly are configured to all interfit with each other or interfit in sets of like parts.

SEE OR SEARCH THIS CLASS, SUBCLASS:

546, for a knockdown, or nested, kit of the mess gear type.

577, for an assemblage or kit of an article or device in disassembled or collapsed array.

518 Noncircular receptacles (e.g., trays):

This subclass is indented under subclass 515. A container of polyhedron configuration.

519 Having defined means to limit extent of nesting:

This subclass is indented under subclass 515. A container wherein the container or lid has specific structure to fix the interfit of one container within the other.

SEE OR SEARCH THIS CLASS, SUBCLASS:

516, for a container with a separate cushion or spacer to limit interfit.

520 Defined means at closed end of receptacle:

This subclass is indented under subclass 519. A container wherein the structure is at the terminal or bottom wall of the container.

521 SHOCK PROTECTION TYPE (E.G., FREE FALL):

This subclass is indented under the class definition. A container with means to pad, brace, or hold the content so that a blow or acceleration force will not damage said content.

(1) Note. Many of the structural features provided for, in subclasses higher in the class schedule, will protect content against shock; and a careful consideration of such features is required to complete the search for shock protection characteristics.

(2) Note. Classified here is a container with specific means to provide "shock protection" for a content article (or articles) rather than to merely reinforce or strengthen the container itself, though such specific means often further strengthens the container. Where a container itself is encased for "shock protection", such container is considered to be a content article. Reinforcement or multilayer wall structure not disclosed for "shock protection" or a content article is classified in Class 220, subclasses 62.11+. A removable liner, or removable container, disclosed for "shock protection" of a content article is considered a "specific means" for this subclass (subclass 521).

SEE OR SEARCH THIS CLASS, SUBCLASS:

131+, for a discrete case for a match box.

139+, for spacer elements between type receptacles.

259+, for a reinforcement or case for a single cigarette package.

275, for a tobacco container with shield means.

280, for an apparel container with a reinforced wall.

313, for a phonograph record jacket with a cushion or sleeve.

418+, for a light bulb or tube container.

426+, for a stemware container.

454+, for a fragile plate container.

SEE OR SEARCH CLASS:

217, Wooden Receptacles, appropriate subclasses for wooden receptacles with cushioning means to protect the contents.

229, Envelopes, Wrappers, and Paperboard Boxes, subclasses 87.02+ for a wrapper, per se, having shock protecting means.

428, Stock Material or Miscellaneous Articles, appropriate subclasses for stock material in the form of a single or plural layer web or pad or sheet, from which the shield protector may be made, and especially subclasses 182+ for a corrugated web or sheet, and subclasses 304.4+ for a composite web or sheet embodying a component of porous or cellular material.

521.1 For an egg, fruit, or vegetable (e.g., egg carton):

This subclass is indented under subclass 521. Subject matter wherein the container is disclosed for holding one or more eggs, one or more pieces of fruit, or one or more vegetables.

SEE OR SEARCH THIS CLASS, SUBCLASS:

602.1, for a divisible egg carton.

SEE OR SEARCH CLASS:

217, Wooden Receptacles, subclasses 26+ for an egg crate made of wood.

521.15 Divisible container:

This subclass is indented under subclass 521.1. Subject matter wherein the receptacle includes means which facilitate separating it into two or more content-holding portions.

SEE OR SEARCH CLASS:

229, Envelopes, Wrappers, and Paperboard Boxes, subclasses 120.011+ for two or more severably attached boxes.

521.2 Single item:

This subclass is indented under subclass 521.1. Subject matter wherein the container is disclosed for holding only one item.

521.3 Including parallel partitions attached to two opposing container walls by triangular webs:

This subclass is indented under subclass 521.1. Subject matter wherein the container includes elements which divide it into a plurality of content holding sections, the elements being equidistant from one another and attached to opposite walls by means of triangular segments of material.

521.4 Including a transverse partition folded up from the bottom wall:

This subclass is indented under subclass 521.3. Subject matter wherein the container includes a partition which extends cross-wise with respect to the parallel partitions and is formed by folding upwardly part of the bottom wall.

521.5 Including parallel partitions which project through openings in opposed container walls:

This subclass is indented under subclass 521.1. Subject matter wherein the container includes elements which divide it into a plurality of content holding sections, the elements being equidistant from one another and extending through silts or apertures in opposite container walls.

521.6 Item supported in an opening in a retaining element:

This subclass is indented under subclass 521.1. Subject matter wherein at least one of the content items extends through an aperture in an interior element, which maintains the item in a fixed position.

SEE OR SEARCH THIS CLASS, SUBCLASS:

521.2, for a container holding only one item.

521.7 Item supported in openings of spaced retaining elements:

This subclass is indented under subclass 521.6. Subject matter wherein the container includes at least two retaining elements, and at least one of the content items extends through an opening in each element.

521.8 Including a curved or sloping support surface for an item:

This subclass is indented under subclass 521.1. Subject matter wherein one or more content items rest on a surface which is arcuate or oblique to a horizontal plane.

521.9 V-shaped:

This subclass is indented under subclass 521.8. Subject matter wherein the supporting surface is in the shape of a "V".

522 Inflated retainer:

This subclass is indented under subclass 521. A container wherein the content is positioned or held by a gas pressurized bag or bladder.

523 Foamlike retainer:

This subclass is indented under subclass 521. A container wherein a light multicellular material is used to pad or position the content.

SEE OR SEARCH CLASS:

428, Stock Material or Miscellaneous Articles, subclasses 304.4+ for a stock material in the form of a composite web or sheet including a component of porous or cellular material from which the shock protection device may be made.

524 In situ:

This subclass is indented under subclass 523. A container wherein the multicellular material is generated in the container.

524.1 WITH SPECIFIED MATERIAL FOR CONTAINER OR CONTENT:

This subclass is indented under the class definition. A container wherein either the content or cover is particularly delineated in terms of one or more “chemical” constituents.

- (1) Note. The term “chemical” is used here to include compound, composition, alloy, mixture, etc.
- (2) Note. This and indented subclasses are residual, in this class, for “chemical” content and/or cover material so the whole subclass schedule must be screened for a more specific locus before assigning a document here. See, for example, subclasses .5, .6+, 205+, 216+, 219+, 384, 385, 438+, 447, and 484+.
- (3) Note. See (1) Note under the class definition for the general line with composition or stock material classes.
- (4) Note. The term “material” is used here to distinguish from “article”. A specified article content, not provided for in a subclass higher in the class schedule, is not classifiable in this subclass unless some particular “chemical” characteristic is recited with respect to the container. A patent reciting such unprovided for article content is classifiable in subclasses 525+.
- (5) Note. See the appropriate classes for packages of compositions, as exemplified under See or Search Class below.

SEE OR SEARCH THIS CLASS, SUBCLASS:

- .5, for an infusion containing receptacle or package.
- .6, and .7, for a receptacle of package for a gas.
- 37+, for a pocket or personal use package.
- 216+, for a combination package.
- 438+, for a package of surgical supplies.

SEE OR SEARCH CLASS:

- 8, Bleaching and Dyeing; Fluid Treatment and Chemical Modification of Textiles and Fibers, particularly subclasses 524+ for compositions for use in the processes named.
- 44, Fuel and Related Compositions, for fuel packages.
- 48, Gas: Heating and Illuminating, subclasses 59 and 60, for carbide cartridges.
- 53, Package Making, appropriate subclasses for methods of and apparatus for making chemical packages. See particularly subclasses 400, 401, 402, and 428+.
- 102, Ammunition and Explosives, for materials of that type.
- 136, Batteries: Thermoelectric and Photoelectric, for vessels used or designed to hold battery elements.
- 141, Fluent Material Handling, With Receiver or Receiver Coacting Means, appropriate subclasses for processes and apparatus for filling receivers with fluent material.
- 149, Explosive and Thermic Compositions or Charges.
- 252, Compositions, particularly subclass 176 for packages of composition of matter.
- 260, Chemistry of Carbon Compounds, for organic compounds.
- 424, Drug, Bio-Affecting and Body Treating Compositions, for a composition, per se, for preventing, alleviating, treating, curing, or diagnosing a disease or condition of an animal (including human) or to groom or enhance the appearance of a living body or for a biocidal composition, e.g., insecticide, fungicide, etc.
- 426, Food or Edible Material: Processes, Compositions, and Products, subclasses 106+, for a food package.
- 508, Solid Antifriction Devices, Materials Therefor, Lubricant or Separant Compositions for Moving Solid Surfaces, and Miscellaneous Mineral Oil Compositions, for packages of compositions of the type included in that class.
- 510, Cleaning Compositions for Solid Surfaces, Auxiliary Compositions There-

for, or Processes of Preparing the Compositions, particularly subclasses 120, 140, 277, 293, 295+, 406, and 439 for packages of compositions of the type included in that class and subclass.

- 520, Synthetic Resins or Natural Rubbers -- Part of the Class 520 Series, appropriate subclasses, particularly Class 523, subclass 124 for a composition containing a synthetic resin or Natural Rubber utility as a battery container or battery container cover or to processes of preparing said composition.
- 585, Chemistry of Hydrocarbon Compounds, subclasses 1+ for a hydrocarbon compound blended with a stabilizer; and subclass 899 for a process of storing a hydrocarbon compound.
- 600, Surgery, subclasses 1+ for radioactive material seeds and holders.

524.2 Plural different lamina wall:

This subclass is indented under subclass 524.1. A container wherein the cover material is recited as a particular array of varied layer members or in terms of particular layer constituents.

- (1) Note. Generally, a layer for this subclass is a distinct film, sheet, or panel which is contiguous to, or joined to, other like members.

SEE OR SEARCH THIS CLASS, SUBCLASS:

- 484.2, for a laminate packet with plural layered walls.
- 524.3, for a container with a specified lining, coating, or impregnant for the container.

SEE OR SEARCH CLASS:

- 428, Stock Material or Miscellaneous Articles, appropriate subclasses for laminate structure, per se, and see search note to Class 428 under the class definition for a line distinction.

524.3 For container lining, coating, or impregnate:

This subclass is indented under subclass 524.1. A container wherein the cover material includes (a) a distinct inner or outer surface

constituent, or (b) has a distinct infused constituent.

SEE OR SEARCH THIS CLASS, SUBCLASS:

- .5, for a container with infusing substance content which may be infused from or through the walls of said container, and see search notes thereunder.

SEE OR SEARCH CLASS:

- 312, Supports: Cabinet Structure, subclasses 31+ for a cabinet with gas or vapor treatment of material.
- 428, Stock Material or Miscellaneous Articles, appropriate subclasses, for film or lining structure, per se.

524.4 For content inhibitor or stabilizer:

This subclass is indented under subclass 524.1. A container wherein the material in said container includes another material which limits interaction between content and container or undesirable changes in the content material itself.

- (1) Note. A search for inhibitor or stabilization material, per se, requires a consideration of "chemical" classes for which see page IV of the Manual of Classification.

SEE OR SEARCH THIS CLASS, SUBCLASS:

- 213.1, for a container with a gaseous medium contacting the content.

524.5 For caustic or deliquescent content:

This subclass is indented under subclass 524.1. A container wherein the material in the container is recited specifically as (a) either alkaline or acidic, or (b) subject to becoming liquid by absorbing moisture.

SEE OR SEARCH THIS CLASS, SUBCLASS:

- 204, for a container with means for removing water or water vapor from the atmosphere within a container.
- 438+, for a container for body treatment material.

524.6 For container:

This subclass is indented under subclass 524.1. A container wherein the cover material itself is particularly delineated in terms of one or more "chemical" constituents.

(1) Note. See notes under subclass 524.1.

524.7 Soluble container:

This subclass is indented under subclass 524.6. A container wherein the cover material is recited as subject to disintegration, usually in a particular solvent.

(1) Note. Included here are patents, not elsewhere provided for, to a content container combination wherein both can be dissolved when subjected to a particular solvent, e.g., a dye or bleach package.

SEE OR SEARCH THIS CLASS, SUBCLASS:

.5, for an infusion container.

SEE OR SEARCH CLASS:

604, Surgery, subclass 287 for therapeutic material in a container, the container being soluble in a body orifice.

524.8 EVACUATED:

This subclass is indented under the class definition. A container wherein all, or substantially all, gas or vapor content has been removed.

SEE OR SEARCH CLASS:

53, Package Making, subclasses 403+, for methods of packaging including gas evacuating, and subclasses 79+, for packaging apparatus including gas evacuating means.

417, Pumps, subclasses 48+, for electrical or getter type pumps.

524.9 Plural similar lamina:

This subclass is indented under subclass 524.3. A container wherein the cover material includes at least two or more layers of the same material, usually impregnated.

SEE OR SEARCH THIS CLASS, SUBCLASS:

524.2, for cover material with plural different layers.

525 WITH ARTICLE CONTENT:

This subclass is indented under the class definition. A container not falling within the scope of any subclass higher in the class schedule and which has an article associated therewith.

SEE OR SEARCH THIS CLASS, SUBCLASS:

524.1+, for specified material as container content, that is, a particular material rather than an article, is set forth as the container content.

525.1 Content folded with blank:

This subclass is indented under subclass 525. A container combined with a foldable, contained article, wherein the contained article and the sheet material of the container are bent simultaneously.

526 Plural:

This subclass is indented under subclass 525. A container for two or more articles.

(1) Note. The titles and definitions of the subclasses of this (206) class are set forth in the singular. However, unless expressly excluded by title and definition these subclasses include plural content.

SEE OR SEARCH THIS CLASS, SUBCLASS:

540, for a container for plural ampoules, capsules, pellets or granules.

527 MISCELLANEOUS:

This subclass is indented under the class definition. A container not falling within the scope of any subclass higher in the class schedule.

528 FOR AMPULE, CAPSULE, PELLET, OR GRANULE:

This subclass is indented under the class definition. A container for a (a) relatively small receptacle or vial, usually frangible or made of a gelatinous-like substance or (b) a pill, tablet, lozenge or troche; each unit of (a) or (b) usually encompasses a single dose or charge for medication or other purposes-which in instances of plural unit contents include means for limited access to, or limited disposal from, such plural unit container.

- (1) Note. content such as (a) or (b) above which is completely encapsulated between two or more flaccid sheets bonded together, without means for limited access to, or limited disposal from, a plural unit container is considered a laminate packet for subclass 484.
- (2) Note. The term "limited" connotes the inclusion of structure which an operator may manipulate to provide an opening for less than a single action removal of total content.
- (3) Note. Included here are patents for a similar container or package of lighter flints or pyrophoric elements.
- (4) Note. This is only the residual locus for an ampoule or capsule, per se. See notes below for other loci.

SEE OR SEARCH THIS CLASS, SUBCLASS:

- 438+, for a container for a body treatment article or material.
- 484, for a laminate package. See (2) Note, above.

SEE OR SEARCH CLASS:

- 220, Receptacles, subclass 8 for a sectional container with telescoping components.
- 221, Article Dispensing, See References to Other Classes for the line between this Class 206 and Class 221.
- 424, Drug, Bio-Affecting and Body Treating Compositions, subclasses 14+ for a structured dosage unit intended to be used as a whole without disassembly. See II, Class 206 note under the class definition of Class 424.
- 588, Hazardous or Toxic Waste Destruction or Containment, subclasses 249+ for containment or storage of hazardous or toxic waste.
- 604, Surgery, subclasses 403+ for medication holding receptacles which are adapted for charging; and subclass 72 for gaseous substances held in reservoirs or injection.

529 Suppository type:

This subclass is indented under subclass 528. A container wherein the content is a unit which softens or dissolves when inserted into a body opening or subcutaneously.

SEE OR SEARCH CLASS:

- 604, Surgery, subclass 288 for soluble suppositories.

530 Single unit container:

This subclass is indented under subclass 528. A container for one item of content.

531 Structure for 'press-out' of content unit:

This subclass is indented under subclass 528. A container including means whereby manipulation of the container, or parts of the container, rupture or distort the container and force an item of content out through the ruptured or distorted portion.

- (1) Note. Where the manipulation also serves to separate one item from a stack of items for subsequent "disposal" see appropriate subclass of Class 221.

SEE OR SEARCH THIS CLASS, SUBCLASS:

- 532, for a container with rupture means.

532 With rupture means for access:

This subclass is indented under subclass 528. A container with means to tear or sever a portion of the container to allow removal of content.

533 With limited access via radial face of 'pill box':

This subclass is indented under subclass 539. A short can-like container with a restricted opening in a flat end.

- (1) Note. The restricted opening allows passage of only a single unit of content at a time.

SEE OR SEARCH THIS CLASS, SUBCLASS:

- 534.2, for other lateral access means.
- 536+, for limited access, by component manipulation, to content stacked within a container.

534 With indicia or indicator:

This subclass is indented under subclass 528. A container including a means which conveys information relative to the container or its content.

SEE OR SEARCH THIS CLASS, SUB-CLASS:

- 459.1, for a container with variable information exhibiting means.
459.5, for a container with static information exhibiting means.

534.1 Single layer in edge-to-edge array:

This subclass is indented under subclass 528. A container for plural units in one side-by-side tier.

- (1) Note. Included here are patents for a shallow container structured to hold pills or tablets in a common place.

SEE OR SEARCH THIS CLASS, SUB-CLASS:

- 533, for a compartmented container with limited access via a container face parallel to the layer or tier.

SEE OR SEARCH CLASS:

- 229, Envelopes, Wrappers, and Paperboard Boxes, subclass 125.12 for a paperboard box having a slide closure and subclass 125.08 for a paperboard box having a hinged closure.

534.2 With means for lateral access:

This subclass is indented under subclass 534.1. A container including gate structure, generally for removal of content one at a time, which structure is in the container wall normal to the plane of the content layer or tier.

SEE OR SEARCH THIS CLASS, SUB-CLASS:

- 533, for other lateral access means.

535 Stacked within container:

This subclass is indented under subclass 528. A container including content units piled one on the other.

536 Limited access by component manipulation:

This subclass is indented under subclass 535. A container so structured as to permit container parts to be moved relative to each other to provide a restricted opening for passage of a content unit.

- (1) Note. Mere removal of a closure is not considered relative movement for this subclass. See the closure subclasses of Classes 215 and 220.

537 Pocket pen type:

This subclass is indented under subclass 536. A container wherein the container is a slender 3cylinder-like member, usually with a clip, to be carried on the person in the manner of a writing instrument.

538 Compartmented:

This subclass is indented under subclass 528. A partitioned container.

SEE OR SEARCH THIS CLASS, SUB-CLASS:

- 561, for a tray-type container including partition means.

539 Single unit:

This subclass is indented under subclass 538. A container with partitions so arranged as to hold only one unit of content in each section.

540 Plural loose content:

This subclass is indented under subclass 528. A container for two or more units of contents.

SEE OR SEARCH THIS CLASS, SUB-CLASS:

- 526, for other plural content containers.

541 Camp or lunch type:

This subclass is indented under subclass 223. A container wherein the divergent contents constitute related parts of a portable outfit for dining, e.g., at work, while camping or at a picnic.

SEE OR SEARCH THIS CLASS, SUB-CLASS:

- 499, through 520, for stacking and/or nesting of receptacles, per se, and 551 for a pastry wedge container, per se.

SEE OR SEARCH CLASS:

- 190, Trunks and Hand-Carried Luggage, subclass 12 for luggage convertible into a desk or table and partitioned or modified so as to be usable for transportation of lunch or picnic components.
- 229, Envelopes, Wrappers, and Paperboard Boxes, subclass 401 for a cup with an attached spoon.

542 With specified nonfood characteristic; e.g., mirror:

This subclass is indented under subclass 541. A container including structure for accommodating nondining items such as cosmetic or first aide material or tools.

SEE OR SEARCH THIS CLASS, SUBCLASS:

- 349+, for a tool container, per se, and see search notes thereunder.

543 With specified vacuum-type receptacle:

This subclass is indented under subclass 541. A container including a distinct double walled container for heat insulation of content effected by evacuation of any gases between said double walls.

- (1) Note. Patents in this subclass as an original, include the recital of a vacuum type container as part of the claimed subject matter.
- (2) Note. Because of the obvious similarity of disclosure in subclasses 543 and 544 no cross references have been made from one to the other. Thus, a full search for some features may require a search of both subclasses.

SEE OR SEARCH CLASS:

- 215, Bottles and Jars, subclass 13.1, for a vacuum type receptacle, per se.

544 With retainer for vacuum-type receptacle:

This subclass is indented under subclass 541. A container including structure to support or position a double walled container for heat insulation of content by evacuation of any gases between said double walls.

- (1) Note. See (2) Note under subclass 543.

545 With structural, or composition, insulating feature:

This subclass is indented under subclass 541. A container including distinct means configuration or material to minimize heat transfer to or from all or part of the container contents.

SEE OR SEARCH CLASS:

- 220, Receptacles, subclasses 560.12+, 592.01+, and 903 for a container having an insulated wall or jacket for spaced wall or jacket insulating features.
- 229, Envelopes, Wrappers, and Paperboard Boxes, subclass 103.1, for a paperboard box having an insulated wall.

546 Knockdown, or nested, mess gear type:

This subclass is indented under subclass 541. A container wherein (a) normal configuration or shape is changeable to permit interfitting or constituent components or (b) components usually intended for use in food preparation or food serving and disclosed as made for repeated assembly and disassembly are configured to interfit with each other or interfit in sets.

SEE OR SEARCH THIS CLASS, SUBCLASS:

- 517, for nesting of identical receptacles.
- 547, for a container interfitted with a canteen.

547 With canteen container:

This subclass is indented under subclass 541. A container including a distinct drinking water jug or canister.

- (1) Note. Because so many of the components disclosed but not claimed include a drinking water vessel, few cross-references have been made between this subclass and other subclasses under subclass 541.
- (2) Note. Patents in this subclass as an original include the recital of a canteen as part of the claimed subject matter.

548 With flaccid wrapper:

This subclass is indented under subclass 541. A container including an encompassing sheet or panel of pliant or supple cover material.

SEE OR SEARCH THIS CLASS, SUB-CLASS:

410, for a roll or reel receptacle of the flaccid wrapper type.

SEE OR SEARCH CLASS:

229, Envelopes, Wrappers, and Paperboard Boxes, subclasses 87.01+ for a wrapper, per se.

549 With specified means to carry or support:

This subclass is indented under subclass 541. A container including structure to handle or position said container.

- (1) Note. Patents in this subclass, as an original, include the recital of a handle or support means as part of the claimed subject matter.

550 Magnetic holder:

This subclass is indented under subclass 541. A container including an aperture or opening in the outer cover of the kit to allow air circulation.

SEE OR SEARCH CLASS:

454, Ventilation, appropriate subclasses, for specific ventilation means.

551 FOR PASTRY WEDGE, PER SE; E.G., PIE SLICE:

This subclass is indented under the class definition. A container for a sector, or radially cut portion, of a baked dish of crusted food.

SEE OR SEARCH THIS CLASS, SUB-CLASS:

45.32, for a display container for a pie.
541+, for a camp or lunch kit including means to hold or retain a piece of pie.

553 Eating or kitchen type:

This subclass is indented under subclass 349. A container for table flatware or a food utensil.

SEE OR SEARCH THIS CLASS, SUB-CLASS:

207, for a container including an ancillary medium contacting a tool, e.g., anti-tarnish or anti-rust composition.

223+, for a kit including flatware or a food utensil.

SEE OR SEARCH CLASS:

211, Supports: Racks, subclass 70.6 for a support or rack for holding cutlery.

554 PLURAL PAPER BAGS (I.E., STACK OR PACK):

This subclass is indented under the class definition. A container for two or more pliable thin walled pouches or sacks.

- (1) Note. Included here are pliable bags of plastic or foil-like material.

- (2) Note. Generally, the individual bags of the stack or pile are collapsed or folded and empty.

SEE OR SEARCH THIS CLASS, SUB-CLASS:

449+, for a container for plates or sheets.

503+, for other receptacle stacking or nesting structure.

555 With access means for manual content removal (e.g., desk tray):

This subclass is indented under subclass 449. A container including an aperture, notch or opening exposing at least part of a content item so that it may be grasped or pushed and taken out of the container.

- (1) Note. Included here is a secretarial or record tray with a cut out for sheet or letter removal.

SEE OR SEARCH THIS CLASS, SUB-CLASS:

39.5+, for a ticket case with an opening for content ejection by finger.

557+, for a tray-type receptacle, and see search notes thereunder for the line between these subclasses and another class.

SEE OR SEARCH CLASS:

211, Supports: Racks, subclasses 10+, for sorting racks, subclasses 50+, for stacked card or sheet racks and subclasses 126.1+ for tray-type racks.

556 With follower:

This subclass is indented under subclass 555. A container including a pusher or support member urging content toward an access position.

SEE OR SEARCH THIS CLASS, SUBCLASS:

425, for a card file with a follower or for such a follower, per se.

557 TRAY TYPE:

This subclass is indented under the class definition. A container comprising an open shallow container.

- (1) Note. Included here is a generally flat panel with a raised or low rim which includes further article retainer means.
- (2) Note. Also included here and in indented subclass is a tray insert or retainer, per se, which holds or supports an article, which insert or retainer is not provided for elsewhere.
- (3) Note. Also included here is a configured panel, which configuration holds or positions one or more articles of mating configuration either in whole or in contacting part.
- (4) Note. Compartments, partitions or cells combined with tray structure are also included here where such features are specific or peculiar to the article content. (Classes 217, 220, and 229 for general compartmented containers).
- (5) Note. The noun "tray" in a claim without some structural modification falling within the above definition, is not enough for classification in this subclass. For example, a mere "medicine tray" or a "serving tray" is not classified here, while a "shallow tray" or a "tray with a flange" may be classified here.

(6) Note. Many of the features provided for in subclasses higher in this class schedule are of the "tray type". A careful consideration of such features is required to complete the search for "tray" characteristics.

(7) Note. The "tray" may be made of wood, plastic, paper, metal, etc.

(8) Note. This and indented subclasses (557+) provide for tray structure with or without additional article retainer means. See the search notes below for trays or tray-like structure in multiple array.

SEE OR SEARCH THIS CLASS, SUBCLASS:

.8+, for a coin tray.
 5+, for an eyeglass or spectacle tray.
 96+, for match and debris tray structure.
 215, for a stationery or carbon paper container.
 246, for tobacco and ash tray structure.
 425, for a file for plural cards or sheets.
 553, for a flatware or kitchen tool tray.
 554+, for a desk tray with access for manual content removal.
 736+, for a container convertible to or from a display configuration.

SEE OR SEARCH CLASS:

40, Card, Picture, or Sign Exhibiting, subclasses 446+, for tray structure combined with changeable exhibitor means, 380+, for tray structure combined with shiftable display means, and 124+, for card rack means.
 211, Supports: Racks, appropriate subclasses for trays or tray-like structure in multiple array. Class 211 provides for two or more trays structurally related so that content of each tray is simultaneously accessible.
 294, Handling: Hand and Hoist-Line Implements, subclasses 144 and 172 for article carrying trays which are not specially configured for supporting a particular article.
 312, Supports: Cabinet Structure, appropriate subclasses for a tray combined with enclosing structure, with or with-

out means to shift such tray relative to its enclosure.

- 402, Binder Device Releasably Engaging Aperture or Notch of Sheet, appropriate subclasses for a releasable sheet (card or panel) impaling retainer. Nominal recital of tray or container combined with such retainer is provided for in Class 402. The inclusion of specific structural details of a tray will effect classification in this (557+) subclass.

558 Plural lateral array:

This subclass is indented under subclass 557. A container including two or more open shallow containers in side by side position.

- (1) Note. Included here is a patent to plural trays in lateral array which are also displaced vertically.
- (2) Note. Included here is a patent to a single tray with features for grouping a plurality of such trays in lateral array.

SEE OR SEARCH THIS CLASS, SUBCLASS:

- 499, for nesting or stacking within a container.
- 501+, for different receptacles with means for stacking.
- 503+, for vertical stacking of similar receptacles, especially subclasses 505+, for nesting or stacking.
- 514, for different receptacles with nesting features.
- 515, for nesting of similar receptacles.

559 With content manipulator means:

This subclass is indented under subclass 557. A container including structure to move or shift an article.

SEE OR SEARCH THIS CLASS, SUBCLASS:

- 39.4, for a ticket case with ejector mechanism.
- 555+, for a plate or sheet container with access means for content removal.

560 With content latch means:

This subclass is indented under subclass 557. A container including structure to lock or secure an article against removal.

- (1) Note. Means for a mere resilient grasping of an article is not considered a latch structure for this subclass.

SEE OR SEARCH THIS CLASS, SUBCLASS:

- 477+, for a base with attached clasping type article retainer.
- 493, for an article with a retainer in an aperture of said article.

SEE OR SEARCH CLASS:

- 211, Supports: Racks, subclasses 4+ for a rack with article locking structure.
- 312, Supports: Cabinet Structure, subclasses 215 through 222 for lock or latch means to secure cabinet components.

561 With partition:

This subclass is indented under subclass 577. A container divided into two or more compartments or cells.

- (1) Note. The divider structure may be integral with the container or a separate member.
- (2) Note. See Classes 215, 220, and 229 under subclass entitled "compartmented", "cell" or "partition" for other loci of similar structure, and search note thereunder for still further loci.

SEE OR SEARCH THIS CLASS, SUBCLASS:

- 180+, for specific partition structure in a carrier for plural cylindrical beverage type receptacles.
- 203, for a plural cylindrical beverage type receptacle tray carrier of molded plastic.
- 538+, for a compartmented ampule or capsule container.

SEE OR SEARCH CLASS:

- 220, Receptacles, subclasses 600+ for a compartmented receptacle.

562 With aperture for article:

This subclass is indented under subclass 557. A container including an opening within which an article is supported or positioned.

SEE OR SEARCH THIS CLASS, SUBCLASS:

- 194+, for cylindrical beverage type receptacles held in apertures of a retainer.
- 341, for a staple of clip held in an aperture of a support member.
- 347, for a fastener held in aperture of a member.
- 382+, for pin-like articles held in retainer apertures.
- 485, for an article held in apertures of opposed walls.
- 486+, for an article held in aperture in base.

563 Specified shape:

This subclass is indented under subclass 562. A container wherein the aperture is contoured for a particular article.

SEE OR SEARCH CLASS:

- 132, Toilet, subclasses 286+ for a toilet kit having shaped apertures for accommodating specific grooming articles.

564 With recess or groove for article:

This subclass is indented under subclass 557. A container including a hollow, indentation or niche to hold or position an article.

- (1) Note. A slot or notch at the edge of a panel or sheet is considered an aperture for subclass 562 above.

565 With article retainer:

This subclass is indented under subclass 557. A container including an article retainer.

- (1) Note. Many of the subclasses of Class 206, both higher and lower in the subclass schedule, include retainer features. A careful consideration of features is required to complete the search for "retainer" characteristics.
- (2) Note. See (2) Note under subclass 557.
- (3) Note. A lid or cover for a tray is not a "retainer."

SEE OR SEARCH CLASS:

- 24, Buckles, Buttons, Clasps, etc., appropriate subclasses, for the several specific kinds of article holders, per se, included therein.
- 211, Supports: Racks, appropriate subclasses, for rack structure combined with retainer structure.
- 248, Supports, appropriate subclasses, for the several specific kinds of article holders, per se, included therein.
- 312, Supports: Cabinet Structure, appropriate subclasses, for enclosures combined with article retainer structure.

566 For jewelry:

This subclass is indented under subclass 557. A container for an adornment article.

SEE OR SEARCH THIS CLASS, SUBCLASS:

- 6.1, for a package including jewelry or a container for jewelry, which container is not a tray type container.
- 205, for a container including an ancillary medium contacting a content article, e.g., anti-tarnish composition.
- 301, for a container for a watch or clock.
- 553, for a container for silverware eating utensils.
- 736+, for a convertible display type of tray.

567 For refuse:

This subclass is indented under subclass 557. A container for debris, e.g., discarded or burnt tobacco products.

SEE OR SEARCH THIS CLASS, SUBCLASS:

- 136, for a match container or packet including a debris receiver, and use the collected search note under subclass 125 for other similar loci.

SEE OR SEARCH CLASS:

- 131, Tobacco, subclasses 231+, for a tobacco user appliance combined with an ash tray.

568 Specified mixture components:

This subclass is indented under subclass 223. A container for two or more particular (or named) separate materials, disclosed for commingling external of said container.

SEE OR SEARCH THIS CLASS, SUBCLASS:

219+, for a container with two or more separate materials, which container is modified to permit commingling by manipulation of said container or a portion thereof.

SEE OR SEARCH CLASS:

426, Food or Edible Material: Processes, Compositions, and Products, appropriate subclasses, for a food package with separate materials.

569 Test (e.g., diagnostic or indicator):

This subclass is indented under subclass 223. A container wherein content items are usable to exhibit or gauge a quantitative or qualitative characteristic.

SEE OR SEARCH THIS CLASS, SUBCLASS:

305+, for a container for a measuring or testing instrument, and see search notes thereunder for other related loci.

570 Therapeutic type (e.g., first aid, doctor kit):

This subclass is indented under subclass 223. A container including content items or materials adapted for use in the treatment of wounds or diseased portion of the body.

(1) Note. See search note under subclass 363 for cosmetic or toilet use content.

(2) Note. A mere assemblage of plural or diverse tools for therapeutic use is not considered a kit for this and indented subclasses. See search note below to subclasses 363+, for such "kit."

(3) Note. Unlike the tools, referred to in (2) Note above, an assemblage of diverse materials for therapeutic use is classified in this and indented subclasses rather than in subclasses 438+ below. Sub-

classes 438+ provide for a container for single or plural articles or materials.

SEE OR SEARCH THIS CLASS, SUBCLASS:

210, for a container including an ancillary contacting medium for a body treatment tool, e.g., a sterilization fluid.

363+, for a container for a therapeutic type tool, per se, or a collection of such tools, per se, e.g., subclass 370 for a container for plural or diverse surgical tools, per se.

438+, for a container of therapeutic material, per se.

581, for a cosmetic or toilet kit including nongrooming means.

SEE OR SEARCH CLASS:

128, Surgery, appropriate subclasses for surgery tools, per se.

132, Toilet, subclasses 286+ for a toilet kit.

433, Dentistry, subclasses 25+ for dental tools, per se.

571 Syringe, hypodermic or catheter:

This subclass is indented under subclass 570. A container including a means to induce material, generally fluid, into the body.

(1) Note. Included here is an assemblage of an injection type tool (or tools) and the material (or materials) for such injection.

SEE OR SEARCH THIS CLASS, SUBCLASS:

364+, for a container for a syringe or hypodermic, per se.

572, for a container for other type tools with medicinal material.

828, for cross-reference collection relating to medicinal content.

572 Material with tool:

This subclass is indented under subclass 570. A container including a body treatment tool and a body treatment material.

(1) Note. Included here is the typical "first aid" kit assemblage of surgical tools, dressings, and medicines.

(2) Note. A complete search for this type kit must include subclass 571.

SEE OR SEARCH THIS CLASS, SUB-CLASS:

438+, for a container for a single (or plural) body treatment article (or material); however, see (3) Note under subclass 570, for diverse articles or materials for body treatment.

571, for a container for a syringe-type tool with material.

573 Signal, lamp or reflector:

This subclass is indented under subclass 223. A container for content items or materials which, as disclosed, either (a) convey information or attract attention, or (b) provide illumination, or (c) are mirror-like.

574 Needlework or dressmaking:

This subclass is indented under subclass 223. A container including articles or materials used for sewing, stitching, knitting, crocheting, etc., or clothing making.

(1) Note. Attention is directed to subclasses lower in the schedule (such as 225+, 227, 231, and 232) which include some characteristics similar to those of a needlework or dressmaking kit.

575 Arts, crafts or sign:

This subclass is indented under subclass 223. A container including means for the production of (a) an article generally within the category of aesthetic or artistic endeavor, e.g., carving, painting, scale model making, mosaic assembly, etc., or (b) a lettered or symbol display.

(1) Note. Included here is a kit for constructing a purse, a pair of moccasin slippers, a model airplane, or a poster announcement.

SEE OR SEARCH THIS CLASS, SUB-CLASS:

1.7+, for a container for artist equipment.

576 Household or office equipment (e.g., mixer-grinder, recording kit):

This subclass is indented under subclass 223. A container including (1) a generally dynamic device, or appliance, used in and around a home or business headquarter to enhance, sustain, or facilitate functions or operations

therein together with, (2) an ancillary attachment and/or material used by the device.

(1) Note. Included here is a container for a vacuum cleaner plus its attachments and container for a chain saw plus its attachments.

(2) Note. See (1) Note under subclass 349.

(3) Note. See (2) Note under subclass 320.

(4) Note. See (2) Note under subclass 223.

SEE OR SEARCH THIS CLASS, SUB-CLASS:

320, for a container for a household or office appliance, per se.

349+, for a container for a tool attachment, per se.

577 Knockdown:

This subclass is indented under subclass 223. A container or assemblage for an article or device with component parts in disassembled or collapsed array.

SEE OR SEARCH THIS CLASS, SUB-CLASS:

517, for components of a knockdown receptacle in nested array.

600, for a container with a pallet feature of the knockdown type.

578 Photography:

This subclass is indented under subclass 223. A container for articles, devices, or materials used in conjunction with taking, developing, or printing an image by a light sensitive technique.

SEE OR SEARCH THIS CLASS, SUB-CLASS:

316.1+, for a container for a photos:graphic device, per se.

579 Game, sport or education:

This subclass is indented under subclass 223. A container for articles, devices, or materials used in conjunction with amusement, exercise, competitive, or learning activity.

- SEE OR SEARCH THIS CLASS, SUB-CLASS:
315.1, for a container for a manual device, per se, used in a game for amusement, exercise, or competition.
- SEE OR SEARCH CLASS:
434, Education and Demonstration, and Cryptography, appropriate subclasses for a teaching means, per se.
- 580 Lock with key:**
This subclass is indented under subclass 223. A container for a fastening or latch mechanism with the operative tool for such mechanism.
- SEE OR SEARCH CLASS:
70, Locks, appropriate subclasses for a lock or key, per se.
- 581 Cosmetic or toilet:**
This subclass is indented under subclass 223. A container wherein the contents include means for personal grooming combined with disparate means.
- SEE OR SEARCH CLASS:
132, Toilet, subclasses 286+ for a toilet kit limited to grooming devices.
- 582 Patch (e.g., tire, tank, roof):**
This subclass is indented under subclass 223. A container for a repair panel (or sheet) with the securement means for said panel (or sheet).
- (1) Note. Included here is a repair item which requires that it, or the member to which the item is applied, be trimmed prior to or after application.
- SEE OR SEARCH THIS CLASS, SUB-CLASS:
231, for a container or kit including other than patch content items with associated fastener means.
302, for a container for a tire patch, per se.
- 583 With sling or suspension means:**
This subclass is indented under subclass 521. A container wherein the content is supported or hung in a pendent-like or hammock-like fashion.
- (1) Note. Included here is a container with content supported at both top and bottom (or between sides) by attenuated means in festoon-like or catenary-like fashion.
- (2) Note. An article supported between parallel yieldable sheets or pads is not "suspended".
- (3) Note. An article supported by or between springs making substantial surface contact with the article is not a "suspension" arrangement.
- (4) Note. Generally, "suspended" connotes limited point contact between the supported content and the container. Such support allowing for resilient movement between said points plus a measure of twisting from the unstressed plane of support.
- (5) Note. Included here is an enwrapped content, which wrapper is then suspended or slung.
- SEE OR SEARCH THIS CLASS, SUB-CLASS:
591+, for yieldable content support means which afford substantial surface contact between said support means and the container.
- 584 With surround or flowable or particulate-like material; e.g., 'pop corn':**
This subclass is indented under subclass 521. A container wherein the content is supported by a mass of particles which mass behaves like a fluid to generally conform to content configuration.
- (1) Note. The size of the "particles" is not critical for placement in this subclass so long as such "particles" exhibit flow characteristics with respect to the contents during and after packaging.
- 585 Stack, pile or nest arrangement:**
This subclass is indented under subclass 521. A container wherein the content array, or relative position of its components, provides the protection.

- SEE OR SEARCH THIS CLASS, SUB-CLASS:
499, for nesting or stacking within a container.
- 586 With distinct corner or edge protector:**
This subclass is indented under subclass 521. A container including a separate member to shield sharp extremities of the content.
- SEE OR SEARCH THIS CLASS, SUB-CLASS:
453, for a sheet or plate container including a separate member to protect a corner or edge, or such member, per se.
- SEE OR SEARCH CLASS:
229, Envelopes, Wrappers, and Paperboard Boxes, Digest 1, for a corner pad.
- 587 With groovelike support:**
This subclass is indented under subclass 521. A container wherein the content is held or positioned in an elongated furrow-like recess.
- (1) Note. See (1) Note under subclass 592.
- SEE OR SEARCH THIS CLASS, SUB-CLASS:
592, for a yieldable retainer configured for the article.
- 588 With article aperture in retainer:**
This subclass is indented under subclass 521. A container including a retainer with an aperture for content support.
- SEE OR SEARCH THIS CLASS, SUB-CLASS:
485, for opposed walls, each with an aperture, to hold the same article.
486+, for a support or base with an aperture to hold an article.
- 589 Plural apertures for plural article:**
This subclass is indented under subclass 588. A container wherein a retainer has two or more apertures for different articles.
- 590 Plural apertures for article:**
This subclass is indented under subclass 588. A container wherein a retainer has two or more apertures for the same article.
- 591 With yieldable retainer:**
This subclass is indented under subclass 521. A container including a resilient, crushable or collapsible holding means.
- SEE OR SEARCH THIS CLASS, SUB-CLASS:
523+, for “yieldable” retainer of foam-like material.
- 592 Configured for article:**
This subclass is indented under subclass 591. A container wherein the yieldable retainer is shaped, in whole or in part, to match the content contour for a “significant” extent of supporting contact.
- (1) Note. Groove or furrow support is generally distinguished from “significant” extent of support, as afforded by contour configuration, in that the groove or furrow provide line contact or corner contact with the content. Where the content is a simple cylindrical shape and the furrow is a mating concavity, the support is more than “groove-like”.
- SEE OR SEARCH THIS CLASS, SUB-CLASS:
587, for a container wherein the content is supported in a groove or furrow.
- 593 Separator between articles:**
This subclass is indented under subclass 591. A container wherein the yieldable retainer is intermediate adjacent articles.
- SEE OR SEARCH THIS CLASS, SUB-CLASS:
814, for a space filler.
- 594 Distinct liner:**
This subclass is indented under subclass 591. A container wherein the yieldable retainer is a separate member between the content article and the container.
- SEE OR SEARCH THIS CLASS, SUB-CLASS:
313, for a phono-record jacket with a distinct liner.
453, for a plate or sheet container with a distinct corner or edge protector.

SEE OR SEARCH CLASS:

- 217, Wooden Receptacles, subclasses 3+ for lining structure; subclass 27 for box cell structure with plate-like cushion means; subclass 35 for cushion means on strips forming the compartments in a box; subclasses 52+ for cushioned crates, and subclass 127 for bottle mailing cases.
- 220, Receptacles, subclasses 23.9 and 495.01+ for lining structure.
- 229, Envelopes, Wrappers, and Paperboard Boxes, subclasses 117.27+ and 164.2 for a lined box.

595 With handling aperture in content:

This subclass is indented under subclass 386. A container wherein the content arrangement provides one or more openings for engagement by manipulative means.

- (1) Note. A typical handling means is a forklift truck; however, "handling means" may also include a single (rather than dual) engagement means.

596 Specified multiple handling aperture pairs:

This subclass is indented under subclass 386. A container including two or more distinct sets of dual openings for manipulative means.

- (1) Note. The term "specified" as used here indicates that the patents classifiable in this subclass claim the particular structure set forth.

SEE OR SEARCH CLASS:

- 108, Horizontally Supported Planar Surfaces, subclass 58 for an industrial platform, per se, with manipulative means entry from all sides.

597 Binder wrap for content:

This subclass is indented under subclass 386. A container including a strand (band, wire, rope, etc.) securement to hold content together or onto a skid.

SEE OR SEARCH THIS CLASS, SUBCLASS:

- 83.5, for a bale package, per se.

SEE OR SEARCH CLASS:

- 24, Buckles, Buttons, Clasps, etc., subclasses 16+ for bale and package ties, per se.
- 100, Presses, subclasses 1+ for binding apparatus and processes.
- 229, Envelopes, Wrappers, and Paperboard Boxes, subclasses 87.01+ for a wrapper, per se.

598 Specified handling aperture:

This subclass is indented under subclass 386. A container including a distinct or particular opening for handling.

- (1) Note. See (1) Note under subclass 596 for "specified".

599 Specified pallet legs:

This subclass is indented under subclass 386. A container including distinct support members which space the skid, platform or content from the ground.

- (1) Note. See (1) Note under subclass 596 for "specified".

600 Knockdown or collapsible type:

This subclass is indented under subclass 386. A container capable of rearrangement in a generally more compact or disassembled array.

- (1) Note. Such collapse or knockdown is performed without element destruction or stress beyond elastic limits.

SEE OR SEARCH THIS CLASS, SUBCLASS:

- 517, for components of a knockdown receptacle in nested array.
- 577, for a combined or convertible container of the knockdown type.

701 HOLDER FOR A REMOVABLE ELECTRICAL COMPONENT:

This subclass is indented under the class definition. A container for: (a) a subassembly or an element, specialized for use in an electrical or electronic device; or (b) an electrical energy storage cell; in which the component is intended to be disassociated from the container before the component is used.

- (1) Note. This subclass does not take an integrated circuit or any other component having a, per se, nonremovable "package."
- (2) Note. This subclass does not take a component housing, such as a container intended to remain with the component when placed in the end-product electronic device.
- (3) Note. This subclass does not take a removable package for a complete electrical device.

SEE OR SEARCH THIS CLASS, SUBCLASS:

- 319, for a container for a motor or engine.
- 320, for a container for a household appliance.
- 389+, for a container for coiled wire.
- 418+, for a container for a filament or space discharge bulb or tube.
- 521+, for a shock protection type package.
- 820, for a cross-reference art collection of separably linked articles joined in a striplike manner.

SEE OR SEARCH CLASS:

- 118, Coating Apparatus, subclasses 500+ for a work holder intended to hold an electronic component or the stock material of an electronic component during a coating or etching process.
- 211, Supports: Racks, for a rack intended to hold a plurality of electrical components, particularly subclass 41.9.
- 312, Supports: Cabinet Structure, for a cabinet intended to hold a plurality of electronic components.
- 324, Electricity: Measuring and Testing, for a housing or holder for an electronic component which includes structure to facilitate testing of the component.
- 361, Electricity: Electrical Systems and Devices, subclasses 600+ for a permanent housing with plural diverse electronic components and subclasses 212+ for (a) an electrical component claimed in combination with static electricity dissipation means, (b) static electricity dissipation means

- particularly configured to interact with an electrical component, or (c) electric shielding means which is used to maintain a charge in a component.
- 429, Chemistry: Electrical Current Producing Apparatus, Product, and Process, for a permanent battery housing or for a battery holder intended to hold the battery while it is being charged or discharged.
- 432, Heating, for a housing or holder for an electronic component intended to hold the component during a heating process, particularly subclass 239 and subclasses 253+.
- 439, Electrical Connectors, for a housing or holder for an electronic component, in which the housing or holder includes electrical conducting means for electrically contacting with a lead or terminal of the component, whereby either (a) the electrical contact is intended to operate the component or (b) the housing or holder is intended to remain with the component when the component is placed in an electrical device.

702 For an electrical cord:

This subclass is indented under subclass 701. A container for an elongated flexible means for conveying an electrical current, wherein the means is made of wire encased in electrical insulation.

SEE OR SEARCH CLASS:

- 174, Electricity: Conductors and Insulators, subclass 135 for an electrical cord adjunct that remains with the cord during use.
- 242, Winding, Tensioning, or Guiding, for a container with an electrical cord which unwinds from the container.

703 For a battery:

This subclass is indented under subclass 701. A container for an electrical storage cell which produces electricity by a chemical reaction (e.g., dry cell or wet cell battery).

SEE OR SEARCH CLASS:

429, Chemistry: Electrical Current Producing Apparatus, Product, and Process, subclasses 163+ for a battery housing, and subclasses 96+ for a battery pack.

704 Button battery (e.g., watch battery):

This subclass is indented under subclass 703. A container wherein the electrical storage cell has a height of less than its width or diameter (e.g., button battery for a watch or thin calculator).

705 Dry cell:

This subclass is indented under subclass 703. A container wherein the chemical reactants in the electrical storage cell are in the form of a paste.

706 For a circuit board:

This subclass is indented under subclass 701. A container for an insulated board or panel on which interconnected circuits and other components are mounted or printed.

SEE OR SEARCH CLASS:

211, Supports: Racks, subclass 41.17 for a rack for circuit boards.
361, Electricity: Electrical Systems and Devices, for a permanent housing or holder for a circuit board.

707 Having plural grooves for retaining circuit boards:

This subclass is indented under subclass 706. A container for holding multiple circuit boards and including elongated recesses for holding the circuit boards.

708 On adjustable panels:

This subclass is indented under subclass 707. A container wherein the elongated recesses are located on movable partitions.

(1) Note. The panels are generally adjustable for holding different sized circuit boards.

709 Including shielding means for static electricity:

This subclass is indented under subclass 706. A container including means for preventing damage to the components from the effects

caused by the accumulation of an electric charge.

SEE OR SEARCH CLASS:

361, Electricity: Electrical Systems and Devices, subclasses 212+ for (a) an electrical component claimed in combination with static electricity dissipation means, (b) static electricity dissipation means particularly configured to interact with an electrical component, or (c) electric shielding means which is used to maintain a charge in a component.

710 For a semiconductor wafer:

This subclass is indented under subclass 701. A container for a substrate having, or intended to have, a plurality of individual micro-electronic circuit components layered thereon (e.g., a silicon disklike wafer which constitutes a plurality of unseparated, integrated circuit chips).

SEE OR SEARCH THIS CLASS, SUBCLASS:

832, for a cross-reference art collection of semiconductor wafer boats.

SEE OR SEARCH CLASS:

118, Coating Apparatus, subclasses 500+ for a work holder intended to hold an electronic component or the stock material of an electronic component, during a coating or etching process.
211, Supports: Racks, subclass 41.1 for a rack for platelike electrical components.
432, Heating, for a housing or holder for an electronic component intended to hold the component during a heating process.

711 Having plural grooves for retaining wafers:

This subclass is indented under subclass 710. A container for holding multiple semiconductor wafers, and having elongated recesses for holding the semiconductor wafers.

(1) Note. The containers in this subclass have covers or other structure to differentiate them from a mere rack for holding semiconductors.

- SEE OR SEARCH CLASS:
211, Supports: Racks, subclass 41.18 for a rack for semiconductor wafers.
- 712 Tray having plural circular pockets:**
This subclass is indented under subclass 710. A container comprising an open shallow container or a configured supporting panel which includes round, recessed compartments.
- SEE OR SEARCH THIS CLASS, SUBCLASS:
557+, for a tray-type container, per se.
- 713 Bar or tapelike carrier for plural components:**
This subclass is indented under subclass 701. A container comprising an elongated, narrow rod or strip having means for retaining multiple components.
- SEE OR SEARCH CLASS:
439, Electrical Connectors, for similar structure including contacts for electrically contacting with a lead or terminal of the component, whereby either (a) the electrical contact is intended to operate the component, or (b) the housing or holder is intended to remain with the component when the component is placed in an electrical device.
- 714 Component retaining pockets:**
This subclass is indented under subclass 713. A container including recesses formed therein for holding components.
- 715 Leads retained between layers:**
This subclass is indented under subclass 713. A container wherein the strip includes juxtaposed elongated sheets or sheet portions and wherein elongated electrical contacts of the components are sandwiched between the sheets.
- 716 Component retaining apertures:**
This subclass is indented under subclass 713. A container including holes for containing the component or a portion thereof.
- 717 Plural components integrally formed with bar or tapelike carrier:**
This subclass is indented under subclass 713. A container wherein the bar or tapelike carrier is formed in one piece and connected with plural components, in which the connections are intended to be severed before use or placement of a component into an electrical device.
- 718 For aligned, contiguous components:**
This subclass is indented under subclass 701. A container for plural abutting components arranged end to end or side to side.
- 719 Including electrical field, magnetic field, or static electricity shielding:**
This subclass is indented under subclass 701. A container including means for preventing damage to the component from (a) the effects of an electrically charged region of space, (b) the effects of a magnetically influenced region of space, or (c) the effects of the accumulation of electric charge.
- SEE OR SEARCH THIS CLASS, SUBCLASS:
709, for a container for a circuit board including static electricity shielding means.
- SEE OR SEARCH CLASS:
361, Electricity: Electrical Systems and Devices, subclasses 212+ for (a) an electrical component claimed in combination with static electricity dissipation means, (b) static electricity dissipation means particularly configured to interact with an electrical component, or (c) static electricity shielding means which is used to maintain a charge in a component.
- 720 Bag:**
This subclass is indented under subclass 719. A container comprising a pouchlike container made of shielding material.
- SEE OR SEARCH CLASS:
383, Flexible Bags, for bag structure in general.

- 721 Box formed from foldable sheet material:**
This subclass is indented under subclass 719. A container comprising shielding material folded to erect the container and wherein the container has a bottom portion for supporting content, peripheral wall structure surrounding the content, and an access opening for the insertion or removal of content.
- SEE OR SEARCH CLASS:
229, Envelopes, Wrappers, and Paperboard Boxes, for box structure in general.
- 722 Including component positioning means:**
This subclass is indented under subclass 701. A container including means, in addition to the mere containment by the container, for restricting the position or orientation of the component by the container.
- 723 In closed box:**
This subclass is indented under subclass 722. A container having a bottom portion for supporting content, peripheral wall structure surrounding the content, an access opening for the insertion or removal of content and a closure for the access opening and wherein the component positioning means are within the container.
- 724 Frame for containing single component:**
This subclass is indented under subclass 722. A container comprising a peripheral structure which completely encompasses the perimeter of a single component about only one axis, such that the container is open at opposite ends of said axis.
- SEE OR SEARCH CLASS:
439, Electrical Connectors, for similar structure including electrical conducting means for electrically contacting with a lead or terminal of the component.
- 725 Pockets for plural articles:**
This subclass is indented under subclass 722. A container including more than one hollow indentation or niche in the container wall structure, each for holding an article in position.
- 726 Including lead or terminal retainer:**
This subclass is indented under subclass 722. A container wherein the positioning means includes means to retain a contact element of the component in fixed position (e.g., a groove or aperture in which a lead wire is disposed, or a wall which lead wires straddle).
- SEE OR SEARCH CLASS:
439, Electrical Connectors, subclasses 149+ for a cover which protects the only the leads of an electrical component.
- 727 Lead sandwiched between panels:**
This subclass is indented under subclass 726. A container including juxtaposed sheets or sheet portions and wherein elongated electrical contacts of the component are retained between the sheets.
- 728 Groove or aperture for containing lead:**
This subclass is indented under subclass 726. A container wherein the positioning means includes (a) a channel or (b) an opening for retaining the lead.
- 730 STOCK AND SAMPLE:**
This subclass is indented under the class definition. A container including a first compartment for holding a relatively large number or amount of similar content and including a second compartment for holding a relatively smaller number or amount of the same kind of content.
- SEE OR SEARCH CLASS:
312, Supports: Cabinet Structure, subclasses 118+ for a cabinet of the show case type having stock and sample compartments.
- 731 Wall portion movable to expose sample only:**
This subclass is indented under subclass 730. A container wherein a part of the outer structure of the container is relocated to reveal only the sample.

732 Sample attached to stock closure:
This subclass is indented under subclass 730. A container including a cover for opening of the container, and wherein the sample is connected to the cover.

733 Sample held in aperture:
This subclass is indented under subclass 730. A container including a hole for receiving the sample.

734 Sample held in recess:
This subclass is indented under subclass 730. A container including a cavity for receiving the sample.

735 Means to elevate sample above stock:
This subclass is indented under subclass 730. A container including structure to move the sample upwardly from the stock.

736 CONVERTIBLE TO OR FROM DISPLAY CONFIGURATION (E.G., FROM OR TO SHIPPING CONFIGURATION):
This subclass is indented under the class definition. A container which includes structure to (a) modify it from a shipping or storage mode to a mode for exhibiting the container or its content, or (b) modify it from an exhibiting mode to a mode for shipping or storing the content.

- (1) Note. A cover which is intended to be removed to expose content is not proper for this area unless the cover adds to the display beyond mere removal or the content is specially displayed or arranged.
- (2) Note. Content removable to provide an individual self-supporting display is proper for this area. A removable side wall intended to expose the content for display also is proper.
- (3) Note. Appropriate other subclasses may be searched for nonconvertible display features.

SEE OR SEARCH THIS CLASS, SUBCLASS:

6.1, for a jewelry container.
216+, for a nondisplay convertible container.

278+, for a nonconvertible display container for apparel.

457+, for a simulated or ornamental container.

459.1, for a container with an indicator.

459.5, for a container with indicia.

460, through 495, for a card type container which may have a display feature, which does not include a convertible characteristic required for these subclasses.

525+, for a container with article content which may include a display feature.

557+, for a tray-type "display" container which does not include a convertible.

775+, for a container having positioning means and a window characteristic.

SEE OR SEARCH CLASS:

40, Card, Picture, or Sign Exhibiting, subclasses 312+ for a box having label thereon.

211, Supports: Racks, for a rack intended for use as a display device.

217, Wooden Receptacles, subclasses 9, 10, 11, 58, and 63 for a wooden display box or a display closure.

220, Receptacles, subclasses 602, 662, and 377 for a container of that class type including a transparent portion.

229, Envelopes, Wrappers, and Paperboard Boxes, subclass 71 for a display envelope, subclass 102.5 for a paperboard box including a fixed upwardly extending display card, and 125.015 for a paperboard box including a transparent closure.

312, Supports: Cabinet Structure, subclasses 114+ for a display cabinet of the show case type.

737 Tilting vertical wall providing flared volume for viewing card or sheet:

This subclass is indented under subclass 736. A container, including an upright outer structural portion that is pivotable from the upright orientation to an inclined orientation for changing the configuration of the interior of the container to one which gradually widens from bottom to top, and which is intended for planar shaped content.

738 Having removal facilitating means:

This subclass is indented under subclass 736. A container including structure to assist with the withdrawal of the content.

SEE OR SEARCH CLASS:

- 221, Article Dispensing, appropriate subclasses for a similar device including means to release, eject or control the discharge of articles from the display receptacle. See sections I and II of the class definition of Class 221 for identification of features which are considered to establish a structure as a dispensing structure for Class 221 as distinguished from mere removal facilitating structure for this subclass.
- 222, Dispensing, for a fluent material dispenser in general.
- 229, Envelopes, Wrappers, and Paperboard Boxes, subclasses 125.04 and 125.42 for a dispensing paperboard box.
- 312, Supports: Cabinet Structure, subclasses 35+ for a cabinet for containing articles in a magazine and having removal facilitating structure associated therewith.

739 Plural contents manipulated for removal:

This subclass is indented under subclass 738. A container wherein the content is repositioned to facilitate selectively withdrawing some of the content from the container.

740 Terraced or stepped shelves:

This subclass is indented under subclass 736. A container including upper and lower supports for the content, wherein a lower support is offset horizontally from an upper support.

SEE OR SEARCH CLASS:

- 108, Horizontally Supported Planar Surfaces, subclasses 92+ for terraced plural related surfaces.
- 190, Trunks and Hand-Carried Luggage, subclasses 16+ for a sample case having terraced trays.
- 211, Supports: Racks, subclasses 128.1+ for a rack including terraced trays.

741 Inclination of container creates stepped shelves:

This subclass is indented under subclass 740. A container intended to be repositioned to change the angle of orientation of the shelves or trays with respect to the horizontal by less than ninety degrees in order to form the terraced or stepped shelves.

742 Cover is attached or includes stepped shelf:

This subclass is indented under subclass 740. A container including a closure, wherein a portion of the closure contributes to the formation of a terraced or stepped shelf.

743 Including movable linked shelves:

This subclass is indented under subclass 740. A container wherein the terraced or stepped shelves are adapted to be moved with respect to each other while remaining connected.

744 Including exposable shelves:

This subclass is indented under subclass 740. A container wherein a portion thereof is movable so as to reveal the terraced or stepped shelves.

745 Sectional or multiple movable compartment type:

This subclass is indented under subclass 736. A container including either (a) a plurality of substantially complete content holding sections that are pivotally or otherwise interconnected so as to convert from a generally compact arrangement to an expanded arrangement or (b) including a single content area having separable wall portions so that sections of the container formed thereby may be separated from each other or pivoted about each other to form a multiple distinct content areas.

SEE OR SEARCH THIS CLASS, SUBCLASS:

- 740+, for a display container having terraced or stepped shelves or trays.

SEE OR SEARCH CLASS:

- 220, Receptacles, subclasses 4.01+ for a sectional container and subclasses 500+ for a compartmented container.
- 312, Supports: Cabinet Structure, for a cabinet having similar structure.

746 Having rupturable wall portion:

This subclass is indented under subclass 745. A container wherein the sections are integrally connected by a scored or weakened outer part to permit separation of the sections at the weakened part.

SEE OR SEARCH CLASS:

- 221, Article Dispensing, subclass 25 for a progressively destroyed cellular magazine type supply source dispensing device. These devices, in some cases, have the construction provided for in this subclass, combined therewith means to assist the discharge of the magazine from a holding receptacle or of the articles from the magazine.
- 229, Envelopes, Wrappers, and Paperboard Boxes, subclasses 120.011 and 101+ for a paperboard box having similar structure.

747 Sections pivotally movable:

This subclass is indented under subclass 745. A container including content holding portions that are interconnected by a hinge or fold.

748 Three or more sections:

This subclass is indented under subclass 747. A container including more than two content holding portions interconnected by hinges or folds.

749 Pivoted about horizontal axis:

This subclass is indented under subclass 747. A container wherein the line of the hinge or fold is oriented generally normal to vertical.

750 Folded blank:

This subclass is indented under subclass 749. A container comprising material that is creased to form the container.

751 Cover-operated positioning means:

This subclass is indented under subclass 736. A container including a closure for opening the container and structure for locating the content, wherein (a) the locating structure is moved with the closure in its opening movement or (b) the content is tilted or is projected by the movement of closure into the open position.

SEE OR SEARCH THIS CLASS, SUBCLASS:

- 45.2+, for a device wherein the receptacle itself may be moved to display position by opening the cover.
- 759+, for noncover type pivotable content positioning means

SEE OR SEARCH CLASS:

- 190, Trunks and Hand-Carried Luggage, subclass 17 for a sample case having link supported trays.
- 220, Receptacles, subclasses 521+ for a container of that class type including a compartmented closure.
- 312, Supports: Cabinet Structure, subclass 269, for a cabinet having continuously level compartments, shelves or other article supports revolvable about a horizontal axis and interconnected with rigid housing wall pivoted on fixed axis and subclasses 272.5, 274, and 275+ for cabinet components interconnected with a rigid housing wall pivoted on fixed axis so that movement of one causes constrained relative motion of the other.

752 Positioning means on cover:

This subclass is indented under subclass 751. A container wherein the closure comprises a content compartment or a means for attaching the closure to the content.

753 Positioning means enlargable:

This subclass is indented under subclass 752. A container wherein the positioning means is an expandable closure compartment.

754 Cover opening forces movement of positioning means:

This subclass is indented under subclass 751. A container (a) wherein the closure is interconnected to a maneuverable content supporting or retaining means or (b) wherein a portion of the closure abuts and pushes the content supporting or retaining means into a different location or orientation.

- 755 Through pivotal link (e.g., hinge or fold line):**
This subclass is indented under subclass 754. A container including an interconnection between the closure and the positioning means that allows the positioning means to change its orientation with respect to the closure.
- 756 Having content positioning means:**
This subclass is indented under subclass 736. A container including structure for locating the content with regard to remainder of the container.
- (1) Note. Mere partitions, per se, without additional positioning structure are not considered proper for this area.
- 757 Located on or formed by outwardly swingable sidewall:**
This subclass is indented under subclass 756. A container including an outer upright portion of the container that is hinged or folded with respect to the remainder of the container for pivoting exteriorly thereof and that defines the positioning means.
- 758 Slidable:**
This subclass is indented under subclass 756. A container wherein the positioning means reciprocates with respect to the remainder of the container.
- 759 Pivotaly mounted:**
This subclass is indented under subclass 756. A container wherein the positioning means is connected to the remainder of the container by a fold or hinge.
- 760 At material fold:**
This subclass is indented under subclass 759. A container wherein the pivoting structure comprises a crease in material.
- 761 Follower or adjustable bottom:**
This subclass is indented under subclass 756. A container wherein the positioning means is capable of being placed in selective, vertical levels within the container.
- SEE OR SEARCH CLASS:
217, Wooden Receptacles, subclass 64 for a follower for a wooden box and subclass 86 for a follower for a wooden barrel.
- 221, Article Dispensing, subclasses 56+, 226+, and 279+ for article dispensing combinations including follower structure.
- 222, Dispensing, subclasses 386+ for a dispensing container with a follower.
- 312, Supports: Cabinet Structure, subclasses 61 and 71 for an article containing magazine type cabinet having article removal facilitating means associated therewith and including follower structure.
- 762 Movable to inclined support position:**
This subclass is indented under subclass 756. A container wherein the positioning means is relocatable to a tilted orientation.
- 763 Aperture:**
This subclass is indented under subclass 756. A container wherein the positioning means is an orifice intended for receiving the content therethrough.
- 764 Having separate stand:**
This subclass is indented under subclass 756. A container including an easel or receptacle support that is or can become independent of the remainder of the container.
- 765 Supporting bed or platform on receptacle bottom:**
This subclass is indented under subclass 756. A container wherein the positioning means is spaced above the lowest portion of the container and is intended to support the weight of the content.
- 766 Pivotal wall providing side display:**
This subclass is indented under subclass 736. A container including an upright outer structure of the container that is hinged or folded to the remainder of the container for the purpose of swinging outwardly thereof in order to reveal the content.
- 767 Having movable display card:**
This subclass is indented under subclass 736. A container including a panel which is relocated in order to exhibit indicia.

- 768 Exposable pop-up display card:**
This subclass is indented under subclass 767. A container wherein the container structure is moved to reveal the display card which is then moveable to a new position.
- 769 Having window or transparent wrapper:**
This subclass is indented under subclass 736. A container or package including (a) an aperture within a wall or (b) a see-through material constructed to enable inspection of the content therethrough.
- SEE OR SEARCH CLASS:
220, Receptacles, subclasses 662+ for a receptacle having a transparent wall portion.
229, Envelopes, Wrappers, and Paperboard Boxes, subclasses 162.1 through 162.7 and 125.015 for a paperboard box having a viewing window or transparent portion.
- 770 Transparent wrapper:**
This subclass is indented under subclass 769. A container including an inner supporting means, which may be the content or a substantially rigid box, wherein the sheet of see-through material substantially covers all sides of the inner supporting means.
- SEE OR SEARCH CLASS:
229, Envelopes, Wrappers, and Paperboard Boxes, subclasses 87.01+ for a wrapper, per se.
- 771 Entirely covers a wall:**
This subclass is indented under subclass 769. A container wherein the transparent sheet completely overlies a facet of the outer shape of the container.
- SEE OR SEARCH THIS CLASS, SUBCLASS:
770, for a transparent wrapper which cover substantially the entire package.
- 772 Exposed by moving panel:**
This subclass is indented under subclass 769. A container including a portion which relocates to reveal the window or transparent section.
- SEE OR SEARCH CLASS:
229, Envelopes, Wrappers, and Paperboard Boxes, subclass 162.3 for a paperboard box having a portion which temporarily obstructs the view through the viewing window or transparent portion.
- 773 Pivoted:**
This subclass is indented under subclass 772. A container wherein the moving part is hinged or folded with the remainder of the container.
- 774 Portion moves to expose content:**
This subclass is indented under subclass 736. A container wherein a part thereof repositions to reveal the articles in the container.
- 775 HAVING POSITIONING MEANS AND DISPLAY OPENING:**
This subclass is indented under the class definition. A container including (a) a particular structure for sustaining the weight of the content or locating the content with regard to remainder of the container and (b) an opening through which the content is viewed.
- 776 Transparent window:**
This subclass is indented under subclass 775. A container wherein the window comprises a see-through material.
- SEE OR SEARCH CLASS:
229, Envelopes, Wrappers, and Paperboard Boxes, subclasses 162.1 through 162.7 and 125.015 for a paperboard box having a viewing window or transparent portion.
- 777 Across aperture:**
This subclass is indented under subclass 776. A container wherein the transparent flexible sheet is surrounded on four sides by opaque material which defines an opening.
- 778 Transparent flexible sheet:**
This subclass is indented under subclass 776. A container wherein the transparent window is a flaccid material.

- 779 Article projects from display opening:**
This subclass is indented under subclass 775. A container wherein the content extends through the window.
- 780 Opposed holes:**
This subclass is indented under subclass 779. A container wherein the positioning means or window comprises a first enclosing aperture located above a second enclosing aperture.
- 781 Window common to top wall and side wall:**
This subclass is indented under subclass 775. A container including an upper, level panel and an adjacent, upright panel connected to the level panel, wherein the window is extends into each of the upright and level panels.
- SEE OR SEARCH CLASS:
229, Envelopes, Wrappers, and Paperboard Boxes, subclass 162.7 for a paperboard box having a viewing window or transparent portion that is common to multiple surfaces.
- 782 Plural windows:**
This subclass is indented under subclass 775. A container including more than one window.
- SEE OR SEARCH CLASS:
229, Envelopes, Wrappers, and Paperboard Boxes, subclass 162.6 for a paperboard box having multiple viewing windows or transparent portions.
- 783 Window defined by flaps:**
This subclass is indented under subclass 775. A container wherein the window bordered by bent tabs.
- 784 FOLDED BLANK HAVING POSITIONING MEANS THEREIN:**
This subclass is indented under the class definition. A container including bent sheet material and including structure for sustaining the weight of the content or locating the content with regard to remainder of the container.
- CROSS-REFERENCE ART COLLECTIONS
- 800 CHEWING GUM:**
Container or holder for gum - i.e., wrapped sticks or chewed material.
- 802 SHIRRED SAUSAGE CASING:**
Sausage casings folded in accordion-like pleats so as to greatly reduce the tubular length.
- 803 EMERGENCY (E.G., FLARE, FIRST AID, SURVIVAL PACK):**
Container for, or package of, an article(s) or material(s) disclosed for use in accident or accident prevention.
- 804 WITH MEANS TO LIFT OR DRAW OUT CONTENT:**
Container including structure that can be manipulated to shift content at least partially out of the container.
- 805 RUBBER BAND:**
Container or retainer for a group of relatively narrow elastic loop-like elements.
- 806 SUSPENSION:**
Structure to pendulously support container content.
- 807 TAMPER PROOF:**
Structure to inhibit or minimize unauthorized removal of container content.
- 809 X-TYPE:**
Cross form container.
- 810 ZIPPER (I.E., RECEPTACLE SECUREMENT):**
Container fasteners of the zipper type.
- 811 WATERPROOF:**
Container structure to keep content free of external moisture.
- 812 PACKAGED TOWEL:**
Container or package for a generally moistened sheet of wiping material.
- 813 ADHESIVE:**
Container related tacky means to secure closure or enwrapment.
- 814 SPACE FILLER:**
Structure to occupy unused volume in container.

- 815 FINGER OPENING:**
Container aperture to allow holding or manipulating by hand digit.
- 816 FLEXIBLE CLOSURE (E.G., SLIDING DESKTOP TYPE):**
Container closure of the articulated panel type.
- 817 FOLLOWER:**
A resilient, or gravity, means bearing against container content.
- 818 MAGNET:**
Holder or retainer which utilizes magnetic characteristics.
- 819 MATERIAL:**
Specialized or unconventional material or compositions used in container or retainer structure.
- 820 SEPARABLE, STRIPLIKE PLURAL ARTICLES:**
Articles linked to each other in concatenated fashion but capable of easy separation.
- 821 STACKING MEMBER:**
Element used between items to allow stable stacking.
- 822 SPECIAL SHAPE:**
Unusual configured containers relating to the shape of content.
- 823 COSMETIC, TOILET, POWDER PUFF:**
Container for vanity or personal adornment content.
- 824 TEAR APERTURES FOR ROLL, STRIP, OR SHEET:**
Openings (slits, holes, notches, etc.) through wound material, a panel or band to facilitate severing of such material.
- 825 RECOIL-TYPE RETAINER:**
A prestressed content holder which prestresses as content is reduced, causes the holder to curl or roll so as to continue to secure the remaining content; e.g., plastic sheet between layers of soft drink packages.
- 828 MEDICINAL CONTENT:**
Container or package for a therapeutic article or material, generally intended for ingestion rather than external application.
- 829 VACUUM, OR SUCTION, CUP ADJUNCT:**
Reduced pressure device generally for container support or content handling.
- 830 BISCUIT PACKAGE:**
Biscuit dough container, generally cylindrical, and usually designed for easy opening.
- 831 DETACHABLE COUPON:**
A container having a premium-like element removable therefrom.
- 832 SEMICONDUCTOR WAFER BOAT:**
This subclass is indented under the class definition. An open container configured to hold a plurality of substrates having, or intended to have, a plurality of individual micro-electronic circuit components layered thereon, the container intended to be used to hold the substrates during a treatment process.
- SEE OR SEARCH THIS CLASS, SUBCLASS:
710+, for a container for a semiconductor wafer.
- SEE OR SEARCH CLASS:
118, Coating Apparatus, subclasses 500+ for a work holder intended to hold an electronic component or the stock material of an electronic component during a coating or etching process.
211, Supports: Racks, for a rack intended to hold a plurality of electrical components, particularly subclass 41.9.
432, Heating, for a housing or holder for an electronic component intended to hold the component during a heating process, particularly subclass 239 and 253+.
- 833 Apertured side walls:**
Container under art collection 832 including holes in the side walls intended to retain semiconductor wafers.

END