

MARKS PUBLISHED FOR OPPOSITION

The following marks are published in compliance with section 12(a) of the Trademark Act of 1946. Applications for the registration of marks in more than one class have been filed as provided in section 30 of said act as amended by Public Law 772, 87th Congress, approved Oct. 9, 1962, 76 Stat. 769. Opposition under section 13 may be filed within thirty days of the date of this publication. See rules 2.101 to 2.105.

A separate fee of two hundred dollars for opposing each mark in each class must accompany the opposition.

SECTION 1.— INTERNATIONAL CLASSIFICATION

The short titles associated below with the international class numbers are terms designed merely for quick identification and are not an official part of the international classification. The full names of international classes are given in section 6.1 of the trademark rules of practice.

The designation "U.S. Cl." appearing in this section refers to the U.S. class in effect prior to Sep. 1, 1973 rather than the international class which applies to applications filed on or after that date. For adoption of international classification see notice in the OFFICIAL GAZETTE of Jun. 26, 1973 (911 O.G. TM 210).

Application in more than one class

SN 74-655,203. IDG BOOKS WORLDWIDE, INC., FOSTER CITY, CA. BY ASSIGNMENT; BY MERGER INTERNATIONAL DATA GROUP, INC., FRAMINGHAM, MA. FILED S.R. 4-4-1995; AM. P.R. 12-8-2001.

FOR DUMMIES

OWNER OF U.S. REG. NOS. 1,759,840, 1,852,364 AND OTHERS.

CLASS 16—PAPER GOODS AND PRINTED MATTER

FOR BOOKS, MAGAZINES, CATALOGUES, MANUALS, BROCHURES, PAMPHLETS, GUIDES AND NEWSLETTERS IN THE FIELD OF CHILD CARE (U.S. CLS. 2, 5, 22, 23, 29, 37, 38 AND 50).

CLASS 42—SCIENTIFIC, COMPUTER AND LEGAL SERVICES

FOR PROVIDING ON-LINE ACCESS THROUGH THE USE OF A COMPUTER TO MAGAZINES AND NEWSLETTERS IN THE FIELD OF CHILD CARE (U.S. CLS. 100 AND 101).

SN 75-065,088. JUDITH SAMS ENTERPRISES LIMITED, TORONTO, ONTARIO M4V 1H7, CANADA, FILED 2-29-1996.

THE FOOD GANG

PRIORITY CLAIMED UNDER SEC. 44(D) ON CANADA APPLICATION NO. 800633, FILED 12-22-1995, REG. NO. TMA539,141, DATED 1-4-2001, EXPIRES 1-4-2016.

NO CLAIM IS MADE TO THE EXCLUSIVE RIGHT TO USE "FOOD", APART FROM THE MARK AS SHOWN.

CLASS 9—ELECTRICAL AND SCIENTIFIC APPARATUS

FOR PRE-RECORDED VIDEO TAPES IN THE AREA OF CULINARY ARTS AND ETIQUETTE (U.S. CLS. 21, 23, 26, 36 AND 38).

CLASS 16—PAPER GOODS AND PRINTED MATTER

FOR BOOKS RELATING TO CULINARY ARTS AND ETIQUETTE (U.S. CLS. 2, 5, 22, 23, 29, 37, 38 AND 50).

CLASS 41—EDUCATION AND ENTERTAINMENT

FOR ENTERTAINMENT SERVICES IN THE NATURE OF AN ONGOING TELEVISION PROGRAM FEATURING INSTRUCTION ON CULINARY ARTS AND ETIQUETTE; AND EDUCATIONAL SERVICES, NAMELY, PROVIDING CLASSES, SEMINARS, WORKSHOPS AND COURSES OF INSTRUCTION IN THE FIELD OF CULINARY ARTS AND ETIQUETTE AND DISTRIBUTION OF COURSE MATERIALS IN CONNECTION THEREWITH (U.S. CLS. 100, 101 AND 107).

SN 75-138,471. LABATT BREWING COMPANY LIMITED, TORONTO, ONTARIO, CANADA, FILED 7-23-1996.



PRIORITY CLAIMED UNDER SEC. 44(D) ON CANADA APPLICATION NO. 810,397, FILED 4-19-1996, REG. NO. 511801, DATED 5-13-1999, EXPIRES 5-13-2014.

OWNER OF U.S. REG. NOS. 646,601, 1,845,823 AND OTHERS.

NO CLAIM IS MADE TO THE EXCLUSIVE RIGHT TO USE "SELECT", APART FROM THE MARK AS SHOWN.

CLASS 25—CLOTHING

FOR WEARING APPAREL FOR MEN AND WOMEN NAMELY, T-SHIRTS; SWEATSHIRTS, SHIRTS OF ALL KINDS; SWEAT PANTS, SWEAT SUITS; TRACK SUITS, SKI SUITS, SKI JACKETS, SKI PANTS, BATHING SUITS, SHORTS, VESTS, SWEATERS, PANTS, COATS, JACKETS, GLOVES, WRISTBANDS, LEG WARMERS, TIES, BELTS; SUSPENDERS; HEADWEAR NAMELY, HATS, CAPS, VISORS, EAR MUFFS, HEAD BANDS (U.S. CLS. 22 AND 39).

CLASS 32—LIGHT BEVERAGES

FOR ALCOHOLIC BREWERY BEVERAGES, NAMELY, ALE, BEER, LAGER, MALT LIQUOR, PORTER AND STOUT (U.S. CLS. 45, 46 AND 48).

SN 75-191,190. SIEMENS STROMBERG-CARLSON, LAKE MARY, FL. FILED 11-1-1996.

SERVICEGATE**CLASS 9—ELECTRICAL AND SCIENTIFIC APPARATUS**

FOR COMPUTER PROGRAMS FOR USE IN THE FIELD OF TELECOMMUNICATION NETWORK MANAGEMENT, ADMINISTRATION AND CONTROL (U.S. CLS. 21, 23, 26, 36 AND 38).

CLASS 42—SCIENTIFIC, COMPUTER AND LEGAL SERVICES

FOR DESIGN OF COMPUTER PROGRAMS FOR USE IN THE FIELD OF TELECOMMUNICATION NETWORK MANAGEMENT, ADMINISTRATION AND CONTROL (U.S. CLS. 100 AND 101).

SN 75-209,682. MOBILE SYSTEMS INTERNATIONAL PLC, LONDON E14 9GE, UNITED KINGDOM, FILED 12-9-1996.

MSI**CLASS 9—ELECTRICAL AND SCIENTIFIC APPARATUS**

FOR TELECOMMUNICATIONS APPARATUS AND INSTRUMENTS; NAMELY TELEPHONES, RADIO PAGERS, RADIO RECEIVERS, AND CELLULAR TELEPHONE RELAYS, FOR USE IN WIRELESS TELECOMMUNICATIONS NETWORKS, AND FIXED TELECOMMUNICATIONS NETWORKS; AND APPARATUS FOR DATA LOGGING AND ANALYSIS, NAMELY, NETWORK PLANNING TOOLS AND PERFORMANCE MANAGEMENT TOOLS IN THE NATURE OF COMPUTER SOFTWARE FOR MOBILE TELEPHONE NETWORKS (U.S. CLS. 21, 23, 26, 36 AND 38).

CLASS 38—COMMUNICATION

FOR TELECOMMUNICATIONS SERVICES, NAMELY, LOCAL AND LONG DISTANCE TELEPHONE, FACSIMILE AND ELECTRONIC MESSAGE SERVICES; BROADCASTING SERVICES, NAMELY, RADIO AND CELLULAR TELEPHONE BROADCASTING; RADIO AND TELEPHONE PAGING SERVICES; RENTAL OF TELECOMMUNICATIONS, BROADCASTING, RADIO AND TELEPHONE EQUIPMENT (U.S. CLS. 100, 101 AND 104).

CLASS 42—SCIENTIFIC, COMPUTER AND LEGAL SERVICES

FOR CONSULTING AND ADVISORY SERVICES - NAMELY ENGINEERING DESIGN AND TECHNICAL RESEARCH, NETWORK PLANNING, FREQUENCY PLANNING, TRAFFIC ANALYSIS, SYSTEM OPTIMIZATION, ALL RELATING TO THE FIELDS OF TELECOMMUNICATIONS, BROADCASTING, RADIO PAGING AND TELEPHONE SYSTEMS, AND CONSULTANCY SERVICES IN THE FIELDS OF TELECOMMUNICATIONS, BROADCASTING, RADIO PAGING AND TELEPHONE SYSTEMS (U.S. CLS. 100 AND 101).

SN 75-244,446. MLADEK, ING. IVAN, 252 29 DOBRICHOVICE, CZECH REPUBLIC, FILED 2-20-1997.

GUITARIANO/NO STRING GUITAR

OWNER OF CZECH REPUBLIC REG. NO. 202542, DATED 1-17-1997, EXPIRES 1-17-2007.

NO CLAIM IS MADE TO THE EXCLUSIVE RIGHT TO USE "NO STRING GUITAR", APART FROM THE MARK AS SHOWN.

CLASS 9—ELECTRICAL AND SCIENTIFIC APPARATUS

FOR MUSICAL JUKEBOXES (U.S. CLS. 21, 23, 26, 36 AND 38).

CLASS 15—MUSICAL INSTRUMENTS

FOR MUSICAL INSTRUMENTS, NAMELY, GUITARS (U.S. CLS. 2, 21 AND 36).

CLASS 41—EDUCATION AND ENTERTAINMENT

FOR EDUCATION, NAMELY, CONDUCTING CLASSES AND SEMINARS IN THE FIELD OF MUSIC; ENTERTAINMENT IN THE NATURE OF LIVE MUSICAL PERFORMANCES; ENTERTAINMENT, NAMELY, LIVE PERFORMANCES BY A MUSICAL BAND (U.S. CLS. 100, 101 AND 107).

SN 75-328,631. TECHNOLOGY MARKETING CORPORATION, NORWALK, CT. FILED 7-22-1997.

CALL CENTER SOLUTIONS

NO CLAIM IS MADE TO THE EXCLUSIVE RIGHT TO USE "CALL CENTER", APART FROM THE MARK AS SHOWN.

CLASS 35—ADVERTISING AND BUSINESS

FOR ARRANGING AND CONDUCTING TRADE SHOWS IN THE FIELD OF COMPUTER-TELEPHONY INTEGRATION, TELECOMMUNICATIONS, CALL CENTERS AND TELEMARKETING SERVICES AND TECHNOLOGIES (U.S. CLS. 100, 101 AND 102).

CLASS 41—EDUCATION AND ENTERTAINMENT

FOR EDUCATIONAL SERVICES, NAMELY, CONDUCTING CONFERENCES AND SEMINARS IN THE FIELD OF COMPUTER-TELEPHONY INTEGRATION, TELECOMMUNICATIONS, CALL CENTERS AND TELE-MARKETING SERVICES AND TECHNOLOGIES (U.S. CLS. 100, 101 AND 107).

SN 75-460.668. BRITISH-AMERICAN TOBACCO (HOLDINGS) LIMITED, MIDDLESEX, ENGLAND, FILED 4-1-1998.

BRITISH AMERICAN TOBACCO

NO CLAIM IS MADE TO THE EXCLUSIVE RIGHT TO USE "TOBACCO", APART FROM THE MARK AS SHOWN.

SN 75-357.007. L.L. KNICKERBOCKER CO. INC., THE, LAKE FOREST, CA. FILED 9-15-1997.

KNICKERBOCKER**CLASS 20—FURNITURE AND ARTICLES NOT OTHERWISE CLASSIFIED**

FOR FIGURINES OF BONE, IVORY, PLASTER, PLASTIC, WAX OR WOOD (U.S. CLS. 2, 13, 22, 25, 32 AND 50).

CLASS 21—HOUSEWARES AND GLASS

FOR FIGURINES OF CHINA, CRYSTAL, GLASS, PORCELAIN OR EARTHENWARE (U.S. CLS. 2, 13, 23, 29, 30, 33, 40 AND 50).

CLASS 6—METAL GOODS

FOR METAL KEY RINGS AND METAL KEY FOBS (U.S. CLS. 2, 12, 13, 14, 23, 25 AND 50).

CLASS 12—VEHICLES

FOR MOTOR CARS; MOTORCYCLES, AUTOMOBILE BODIES, AUTOMOBILE TIRES, AND PARTS FOR LAND VEHICLES, NAMELY, BRAKES, UPHOLSTERY, DOORS, ENGINES, GEAR BOXES AND STEERING WHEELS (U.S. CLS. 19, 21, 23, 31, 35 AND 44).

CLASS 14—JEWELRY

FOR WATCHES AND JEWELRY (U.S. CLS. 2, 27, 28 AND 50).

CLASS 16—PAPER GOODS AND PRINTED MATTER

FOR BOOKS, MAGAZINES, CATALOGS, PRINTED PUBLICATIONS IN THE NATURE OF NEWSLETTERS AND INFORMATIONAL LETTERS, ALL FEATURING INFORMATION OF GENERAL INTEREST TO THE CUSTOMERS AND EMPLOYEES OF A TOBACCO PRODUCTS MANUFACTURER; DIARIES; PENS; PENCILS; ENVELOPES (U.S. CLS. 2, 5, 22, 23, 29, 37, 38 AND 50).

SN 75-392.125. TOPEX-ETIKETTIERMASCHINEN GMBH, 73268 ERKENBRECHTSWEILER, FED REP GERMANY, FILED 11-18-1997.

CLASS 18—LEATHER GOODS

FOR UMBRELLAS, LUGGAGE, BRIEFCASES, HANDBAGS, WALLETS, PURSES (U.S. CLS. 1, 2, 3, 22 AND 41).

CLASS 20—FURNITURE AND ARTICLES NOT OTHERWISE CLASSIFIED

FOR NON METAL KEY RINGS (U.S. CLS. 2, 13, 22, 25, 32 AND 50).

CLASS 25—CLOTHING

FOR BELTS, BOOTS, CAPS, RAIN COATS, LONG COATS, HALF COATS, OVERCOATS, TOP COATS, GLOVES, HATS, JACKETS, PANTS, SCARVES, HAWAIIAN SHIRTS, SHOES, BODY SHIRTS, SWEAT SHIRTS, SPORTS SHIRTS, DRESS SHIRTS, POLO SHIRTS, T-SHIRTS, SOCKS, SWEATERS, TROUSERS (U.S. CLS. 22 AND 39).

OWNER OF FED REP GERMANY REG. NO. 2102286, DATED 2-20-1991, RENEWED AS REG. NO. 2102286, DATED 2-20-1991, EXPIRES 2-28-2011.

CLASS 7—MACHINERY

FOR MOTOR DRIVEN DEVICES, NAMELY MOTOR DRIVEN LABELLING MACHINES, IN PARTICULAR FOR SELF STICKING LABELS, AND REPLACEMENT PARTS THEREFOR; INDUSTRIAL LABEL PRINTING MACHINES FOR PRINTING LABELS WITH CHARACTERS (U.S. CLS. 13, 19, 21, 23, 31, 34 AND 35).

CLASS 16—PAPER GOODS AND PRINTED MATTER

FOR SELF STICKING NON-TEXTILE LABELS IN THE FORM OF ROLLS FOR LABEL PRINTING MACHINES FOR COMMERCIAL OR INDUSTRIAL USE (U.S. CLS. 2, 5, 22, 23, 29, 37, 38 AND 50).

CLASS 41—EDUCATION AND ENTERTAINMENT

FOR ORGANIZING ENTERTAINMENT EVENTS OF LIGHT-MOTOR VEHICLE RACING, HORSE RACES, BICYCLE RACES, BOAT RACES, GOLF TOURNAMENTS, BASEBALL GAMES, BOXING MATCHES, SOCCER GAMES, AMERICAN FOOTBALL GAMES, CANOE TOURNAMENTS, KARATE CONTESTS, BALLOON CONTESTS, SURFING CONTESTS, SCUBA DIVING, ROPE PULLING CONTESTS, WALKING CONTESTS, VOLLEYBALL CONTESTS, MARATHON CONTESTS, LACROSSE GAMES, AND PROVIDING SPORTS FACILITIES THEREFOR (U.S. CLS. 100, 101 AND 107).

SN 75-462,224. THOMAS INTERNATIONAL LIMITED, GB2, ENGLAND, BY ASSIGNMENT TMS MANAGEMENT SYSTEMS, INC., TUCSON, AZ. FILED 4-6-1998.

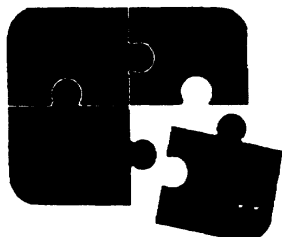

CLASS 41—EDUCATION AND ENTERTAINMENT

FOR EDUCATIONAL SERVICES, NAMELY, CONDUCTING SEMINARS, MEETINGS AND CONFERENCES IN THE FIELD OF HUMAN RESOURCES FOR THE PURPOSE OF IMPROVING THE PERFORMANCE AND EFFECTIVENESS OF PERSONNEL IN THEIR JOBS (U.S. CLS. 100, 101 AND 107).

FIRST USE 1-31-1973; IN COMMERCE 1-31-1973.

CLASS 42—SCIENTIFIC, COMPUTER AND LEGAL SERVICES

FOR TESTING TO DETERMINE EMPLOYMENT SKILLS; VOCATIONAL GUIDANCE; PSYCHOLOGICAL TESTING; HUMAN RESOURCES CONSULTATION (U.S. CLS. 100 AND 101).

FIRST USE 1-31-1973; IN COMMERCE 1-31-1973.

SN 75-484,258. RIBOZYME PHARMACEUTICALS INCORPORATED, BOULDER, CO. FILED 5-13-1998.

HEPAZYME

CLASS 1—CHEMICALS

FOR MEDICINAL AND BIOLOGICAL PREPARATIONS FOR RESEARCH AND LABORATORY USE, NAMELY, PREPARATIONS FOR THE MODULATION OF GENE EXPRESSION WORKING AT DNA, TRANSCRIPTION, RNA OR TRANSLATION PROCESSES (U.S. CLS. 1, 5, 6, 10, 26 AND 46).

CLASS 5—PHARMACEUTICALS

FOR MEDICINAL AND BIOLOGICAL PREPARATIONS FOR PHARMACEUTICAL, CLINICAL OR MEDICAL LABORATORY USE, NAMELY, PREPARATIONS FOR THE MODULATION OF GENE EXPRESSION WORKING AT DNA, TRANSCRIPTION, RNA OR TRANSLATION PROCESSES (U.S. CLS. 6, 18, 44, 46, 51 AND 52).

SN 75-512,743. PAYNET COMMUNICATIONS, INC., BRYAN, TX. FILED 7-2-1998.

PAYNET

CLASS 38—COMMUNICATION

FOR ELECTRONIC MAIL SERVICES (U.S. CLS. 100, 101 AND 104).

FIRST USE 12-0-1996; IN COMMERCE 12-0-1996.

CLASS 42—SCIENTIFIC, COMPUTER AND LEGAL SERVICES

FOR PROVIDING ACCESS TO GLOBAL COMPUTER COMMUNICATIONS NETWORKS FOR THE TRANSFER AND DISSEMINATION OF A WIDE RANGE OF INFORMATION, NAMELY, PROVIDING COMPUTER NETWORK DATABASES ALLOWING USE OF WORD PROCESSING, GRAPHICS, SPREAD SHEET AND FINANCIAL SOFTWARE (U.S. CLS. 100 AND 101).

FIRST USE 12-0-1996; IN COMMERCE 12-0-1996.

SN 75-557,819. ARANGO, INC., MIAMI, FL. FILED 9-22-1998.

ARANGO

SEC. 2(F).

CLASS 35—ADVERTISING AND BUSINESS

FOR RETAIL AND WHOLESALE STORES FEATURING FURNITURE AND ACCESSORIES FOR HOME AND OFFICE, NAMELY, DESK AND WALL CLOCKS, MAGAZINE RACKS, COAT RACKS, DESK SETS, PENS, FRAMES, BOOKENDS, WASTEBASKETS, VASES, LIGHTING, JEWELRY, TOYS, BOOKS, APPAREL, TABLEWARE, NAMELY CHINA; CRYSTAL AND FLATWARE TABLE SERVICE AND TABLE ORNAMENTS, KITCHENWARE, NAMELY, POTS AND PANS, COOKING UTENSILS, SPICE SETS, NAPKIN RINGS, BAR SERVICE, AND LINENS (U.S. CLS. 100, 101 AND 102).

FIRST USE 9-1-1959; IN COMMERCE 9-1-1959.

CLASS 42—SCIENTIFIC, COMPUTER AND LEGAL SERVICES

FOR INTERIOR DECORATING SERVICES (U.S. CLS. 100 AND 101).

FIRST USE 9-1-1959; IN COMMERCE 9-1-1959.

SN 75-573,415. BABCO ELECTRIC & ENGINEERING LTD, STATION D, EDMONTON, ALBERTA, CANADA, FILED 10-19-1998.



PRIORITY CLAIMED UNDER SEC. 44(D) ON CANADA APPLICATION NO. 875,641, FILED 4-20-1998, REG. NO. 545194, DATED 5-16-2001, EXPIRES 5-16-2016.

CLASS 9—ELECTRICAL AND SCIENTIFIC APPARATUS

FOR ELECTRICAL EQUIPMENT, NAMELY, SWITCH GEAR, CIRCUIT BREAKERS, SWITCHES, TRANSFORMERS, DRIVES, NAMELY, ALTERNATING CURRENT INVERTER DRIVES AND DIRECT CURRENT VARIABLE SPEED DRIVES, POWER FACTOR CORRECTION UNITS, ENERGY MANAGEMENT UNITS, PROGRAMMABLE LOGIC CONTROLLERS, MULTI-METER POWER PEDESTALS, PORTABLE POWER DISTRIBUTION UNITS, METAL ENCLOSURES FOR ELECTRICAL EQUIPMENT (U.S. CLS. 21, 23, 26, 36 AND 38).

CLASS 40—MATERIAL TREATMENT

FOR MANUFACTURE FOR OTHERS OF ELECTRICAL EQUIPMENT, NAMELY, SWITCH GEAR, POWER DISTRIBUTION, INSTRUMENTATION, AND CONTROL EQUIPMENT (U.S. CLS. 100, 103 AND 106).

CLASS 9—ELECTRICAL AND SCIENTIFIC APPARATUS

FOR ELECTRONIC DEVICES, NAMELY, COMMUNICATION SYSTEMS COMPRISING TRANSMITTERS OF ULTRAVIOLET, VISIBLE AND INFRARED SIGNALS AND RECEIVERS OF ULTRAVIOLET, VISIBLE AND INFRARED SIGNALS, ELECTRICAL COMMUNICATIONS CIRCUITRY, LIGHTING BALLASTS, ELECTRICAL POWER SUPPLIES, LIGHTING BALLASTS, POWER SYSTEMS, LIGHT EMITTING DIODES INCLUDING SUBASSEMBLIES, ELECTRICAL COMPONENTS, NAMELY CIRCUIT BOARDS, TELEPHONE TRANSMITTERS, RADIO TRANSMITTERS, MICROWAVE RADIO TRANSMITTERS, BATTERY OPERATED RADIO TRANSMITTERS AND TELEPHONE RECEIVERS ELECTROMAGNETIC ANTENNAE, ELECTRO-OPTICAL TELEVISION TRANSMITTERS, OPTICALLY SENSITIVE SEMICONDUCTORS INCLUDING OPTICALLY SENSITIVE SEMICONDUCTORS COMPOSED OF SILICON AND GALLIUM ARSENIDE, ELECTRICAL COILS, ELECTRICAL INDUCTORS, CAPACITORS, RADAR ANTENNAE, LOUDSPEAKERS, KLYSTRONS, CATHODE RAY TUBES, VACUUM TUBES, ELECTRICAL ARC WELDERS, WELDING ELECTRODES, ELECTRIC SAFETY WARNING LIGHTS, NAMELY BUOY LIGHTS, COMPUTERS INCLUDING PALMTOP COMPUTERS AND HANDHELD DATA PROCESSING COMPUTERS, LIGHT EMITTING ELECTROLUMINESCENT DISPLAY PANELS, AUDIO RECEIVERS, PHOTOCELLS, DATA PROCESSING COMPUTERS, AUDIO TRANSMISSION RECEIVERS USED FOR DISPLAY PURPOSES, ASSISTIVE PURPOSES, MILITARY PURPOSES, UNDERWATER COMMUNICATION PURPOSES, EDUCATIONAL PURPOSES, VEHICLE COMMUNICATION PURPOSES, AIRCRAFT PURPOSES, TRANSPORTATION COMMUNICATION PURPOSES, MARKING PURPOSES, WAYFINDING, ORIENTEERING, POSITIONING SYSTEMS, MAPPING SYSTEMS, EMERGENCY OR RESCUE SYSTEMS AND ENTERTAINMENT APPLICATIONS (U.S. CLS. 21, 23, 26, 36 AND 38).

SN 75-575,293. WORLD KITCHEN, INC., ELMIRA, NY. BY CHANGE OF NAME CORNING CONSUMER PRODUCTS COMPANY, CORNING, NY. FILED 10-23-1998.

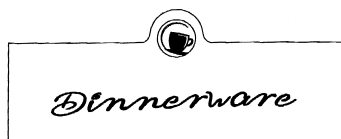

NO CLAIM IS MADE TO THE EXCLUSIVE RIGHT TO USE "DINNERWARE", APART FROM THE MARK AS SHOWN.

CLASS 21—HOUSEWARES AND GLASS

FOR PLATES, BOWLS, SAUCERS, CUPS, GLASSES, FLATWARE, BAKEWARE, MUGS, BAKING DISHES, SALT AND PEPPER SHAKERS, CREAMERS, SUGAR BOWLS, AND GRAVY BOATS (U.S. CLS. 2, 13, 23, 29, 30, 33, 40 AND 50).

CLASS 24—FABRICS

FOR CLOTH NAPKINS, TABLECLOTHS (NOT OF PAPER), TOWELS (NOT OF PAPER) AND TABLE LINENS (U.S. CLS. 42 AND 50).

SN 75-586,398. LUPTON, ELMER C, BOSTON, MA. FILED 11-20-1998.

TALKING LIGHTS

NO CLAIM IS MADE TO THE EXCLUSIVE RIGHT TO USE "LIGHTS", APART FROM THE MARK AS SHOWN.

CLASS 11—ENVIRONMENTAL CONTROL APPARATUS

FOR ELECTRONIC DEVICES, NAMELY ILLUMINATION SOURCES, NAMELY ELECTRIC LIGHT BULBS, LIGHTING SUPPLIES NAMELY ELECTRICAL LIGHTING FIXTURES; LAMPS, NAMELY FLUORESCENT LAMPS, HIGH INTENSITY DISCHARGE LAMPS, SODIUM VAPOR LAMPS, MERCURY VAPOR LAMPS, METAL VAPOR LAMPS HIGH INTENSITY DISCHARGE ELECTRICAL LIGHTING FIXTURES, INCANDESCENT LAMPS, COMPACT FLUORESCENT LAMPS, ARC LAMPS, COLD CATHODE FLUORESCENT LAMPS, PORTABLE LIGHTS, NAMELY FLASHLIGHTS AND FLUORESCENT FLASHLIGHTS, SEARCHLIGHTS, LANDING AND RUNWAY LIGHT FOR AIRPORTS, ELECTRIC STREET LIGHTS AND ELECTRIC HIGHWAY LIGHTS, LIGHTS FOR MOTOR VEHICLES, NAMELY INTERIOR ILLUMINATION LIGHTS, UNDERWATER ILLUMINATION LIGHT FOR SWIMMING POOLS, USED FOR DISPLAY PURPOSES, ASSISTIVE PURPOSES, MILITARY PURPOSES, UNDERWATER PURPOSES, TESTING PURPOSES, EDUCATIONAL PURPOSES, VEHICLE COMMUNICATION PURPOSES, AIRCRAFT COMMUNICATION PURPOSES, AUTO AND TRACK COMMUNICATION PURPOSES, SHIP AND BOAT COMMUNICATION PURPOSES, TRANSPORTATION COMMUNICATION PURPOSES, MARKING PURPOSES, WAYFINDING, ORIENTEERING POSITIONING SYSTEMS, MAPPING SYSTEMS, EMERGENCY OR RESCUE SYSTEMS AND ENTERTAINMENT APPLICATIONS (U.S. CLS. 13, 21, 23, 31 AND 34).

SN 75-597,402. FIELDING CHEMICAL TECHNOLOGIES INC., MISSISSAUGA, ONTARIO, CANADA, FILED 12-1-1998.

SN 75-605,265. MIYUKI EUROPE (HOLDING) S.A.R.L., LU-9753 HEINERSCHIED, LUXEMBOURG, FILED 12-14-1998.



PRIORITY CLAIMED UNDER SEC. 44(D) ON CANADA APPLICATION NO. 880888, FILED 6-9-1998, REG. NO. 522750, DATED 2-8-2000, EXPIRES 2-8-2015.

CLASS 35—ADVERTISING AND BUSINESS

FOR DISTRIBUTORSHIP SERVICES IN THE FIELDS OF CUSTOM MANUFACTURING OF CHEMICALS, CHEMICAL PROCESSING UTILIZING DISTILLATION, FRACTIONIZATION, PERVAPORATION, ESTERIFICATION, DEHYDRATION, CHEMICAL DRYING AND FILTRATION PROCESSES, AND HAZARDOUS WASTE TREATMENT (U.S. CLS. 100, 101 AND 102).
FIRST USE 2-1-1998; IN COMMERCE 2-1-1998.

CLASS 37—CONSTRUCTION AND REPAIR

FOR HAZARDOUS WASTE DISPOSAL; DISPOSAL OF GASEOUS CHEMICALS (U.S. CLS. 100, 103 AND 106).

CLASS 39—TRANSPORTATION AND STORAGE

FOR CUSTOM PACKAGING OF CHEMICALS FOR OTHERS FOR TRANSPORT; TRANSPORTATION OF HAZARDOUS WASTE AND HAZARDOUS MATERIALS; AND CHEMICAL STORAGE; CHEMICAL NEUTRALIZATION, BLENDING OF VIRGIN AND RECLAIMED SOLVENTS AND CHEMICALS, INCLUDING FUELS, CHEMICAL AND REFRIGERANT PACKAGING FOR OTHERS; CUSTOM MANUFACTURING OF CHEMICALS, CHEMICAL PROCESSING UTILIZING DISTILLATION, FRACTIONIZATION, PERVAPORATION, ESTERIFICATION, DEHYDRATION, CHEMICAL DRYING AND FILTRATION PROCESSES, HAZARDOUS WASTE TREATMENT OF CHEMICALS FOR TRANSPORT (U.S. CLS. 100 AND 105).

CLASS 40—MATERIAL TREATMENT

FOR RECYCLING OF CHEMICALS, SOLVENTS, REFRIGERANT, CARBON AND GASEOUS CHEMICALS (U.S. CLS. 100, 103 AND 106).

CLASS 42—SCIENTIFIC, COMPUTER AND LEGAL SERVICES

FOR RESEARCH AND DEVELOPMENT SERVICES RELATING TO THE SAFE USE AND RE-USE OF CHEMICALS; CONSULTING SERVICES RELATING TO THE USE, RE-USE, PROCESSING, AND STORAGE OF CHEMICALS; AND CONSULTING SERVICES RELATING TO LEGISLATION AND STANDARDS COMPLIANCE (U.S. CLS. 100 AND 101).

EASY-STAR

PRIORITY CLAIMED UNDER SEC. 44(D) ON ERPNCMNTY TM OFC APPLICATION NO. 000862896, FILED 6-18-1998, REG. NO. 862896, DATED 4-17-2000, EXPIRES 6-18-2008.

CLASS 21—HOUSEWARES AND GLASS

FOR HOUSEHOLD AND KITCHEN APPLIANCES AND CONTAINERS FOR THE HOUSEHOLD AND KITCHEN, NOT FORMED OF PRECIOUS METAL OR COATED THEREWITH, NAMELY, CONTAINERS FOR HOUSEHOLD AND KITCHEN USE, PANS, POTS, SKILLETS, BUCKETS, MANUALLY-OPERATED PEPPER AND COFFEE GRINDERS AND JUICERS; HAIR COMBS AND CLEANING COMBS; SPONGES FOR HOUSEHOLD PURPOSES; HAIR BRUSHES, TOOTHBRUSHES, CLOTHES BRUSHES, AND BRUSHES FOR GENERAL HOUSEHOLD CLEANING PURPOSES; STEELWOOL FOR CLEANING PURPOSES; PORCELAIN AND EARTHENWARE FOR HOUSEHOLD AND KITCHEN USE AND GLASSWARE FOR THE HOUSEHOLD AND KITCHEN, NAMELY, BEVERAGE AND TABLE GLASSWARE; AND ART OBJECTS MADE OF GLASS, PORCELAIN AND EARTHENWARE, NAMELY, STATUES, FIGURINES, CANDLESTICKS, AND VASES (U.S. CLS. 2, 13, 23, 29, 30, 33, 40 AND 50).

CLASS 28—TOYS AND SPORTING GOODS

FOR CHRISTMAS TREE STANDS (U.S. CLS. 22, 23, 38 AND 50).

SN 75-605,605. ENERCOM, INC., NEWNAN, GA. FILED 12-14-1998.

ENERCOM

CLASS 35—ADVERTISING AND BUSINESS

FOR ON LINE RETAIL STORE SERVICES FEATURING A WIDE VARIETY OF PRODUCTS AND SERVICES, SUCH AS TELEPHONES, PAGERS, PERSONAL COMMUNICATION DEVICES, LIGHTING FIXTURES AND LAMPS, ELECTRICAL SURGE PROTECTION DEVICES, POWER QUALITY DEVICES, SECURITY SYSTEMS AND DEVICES, ELECTRONIC METERING AND CONTROL DEVICES, CARBON MONOXIDE DETECTORS, SMOKE ALARMS, ENERGY AND WATER EFFICIENCY PRODUCTS, HOME CONTROLS AND CONVENIENCE PRODUCTS, HOME SECURITY SYSTEMS, COMMUNICATION PRODUCTS, INTERNET ACCESS PRODUCTS, AND BOOKS; RATE AND BILLING ANALYSIS; DEVELOPMENT OF MARKETING AND ADVERTISING PLANS FOR OTHERS AND CONSULTATION RENDERED IN CONNECTION THEREWITH (U.S. CLS. 100, 101 AND 102).

FIRST USE 1-0-1997; IN COMMERCE 1-0-1997.

CLASS 42—SCIENTIFIC, COMPUTER AND LEGAL SERVICES

FOR CONDUCTING BUSINESS OR HOME ENERGY USAGE PROFILES, SURVEYS AND ANALYSES; ANALYZING HOME AND BUSINESS ENERGY CONSUMPTION FACTORS, AND RECOMMENDING HOME ENERGY SAVINGS MODIFICATIONS BY COMPUTER; RESOURCE AUDITING ANALYSIS AND ASSESSMENT OF ENERGY AND WATER USE; PROVIDING TECHNICAL INFORMATION IN THE FIELDS OF ENERGY, WATER AND RESOURCE USE AND CONSERVATION; COMPUTER SOFTWARE PROGRAMMING AND RELATED CONSULTING FOR OTHERS; CREATING AND MAINTAINING WEB PAGES FOR OTHERS (U.S. CLS. 100 AND 101).

FIRST USE 5-1-1976; IN COMMERCE 5-15-1976.

SN 75-624,879. MARGARETE STEIFF GMBH, 89537 GIENGEN, FED REP GERMANY, FILED 1-20-1999.



PRIORITY CLAIMED UNDER SEC. 44(D) ON ERP N CMNTY TM OFC APPLICATION NO. 1007467, FILED 12-4-1998, REG. NO. 1007467, DATED 4-6-2001, EXPIRES 12-4-2008. OWNER OF U.S. REG. NOS. 1,354,416, 2,233,180 AND OTHERS.

"KNOPF IM OHR" CAN BE TRANSLATED AS "BUTTON IN EAR".

SN 75-619,325. BRACE AR, S-112 27 STOCKHOLM, SWEDEN, FILED 1-12-1999.

THINWORKS

OWNER OF SWEDEN REG. NO. 338355, DATED 6-13-2001, EXPIRES 6-13-2011.

CLASS 9—ELECTRICAL AND SCIENTIFIC APPARATUS

FOR COMPUTERS; COMPUTER PERIPHERAL; BLANK MAGNETIC AND OPTICAL DATA MEDIA, NAMELY, CD-ROMS AND FLASHROMS; COMPUTER MEMORIES; COMPUTER SOFTWARE, NAMELY, THIN CLIENT SOFTWARE, FOR PROVIDING ACCESS TO SOFTWARE APPLICATIONS AND THE INTERNET FROM MOBILE OR STATIONARY TERMINALS IN THE FIELDS OF BUSINESS, EDUCATION, AND GENERAL CONSUMER USE; COMPUTER SOFTWARE, NAMELY, INFORMATION APPLIANCE SOFTWARE FOR PROVIDING ACCESS VIA THE INTERNET TO DOMESTIC APPLIANCES AND DEDICATED HOME TERMINALS IN THE FIELDS OF HOTELS, HOSPITALS AND GENERAL CONSUMER USE; COMPUTER SOFTWARE, NAMELY, GENERAL PURPOSE COMMUNICATIONS CONNECTIVITY SOFTWARE USED TO ESTABLISH AND MANAGE CONNECTIONS BETWEEN A COMPUTER AND COMPUTER NETWORKS (U.S. CLS. 21, 23, 26, 36 AND 38).

CLASS 38—COMMUNICATION

FOR TELECOMMUNICATION SERVICES, NAMELY, ELECTRONIC COMPUTER AIDED TRANSMISSION OF MESSAGES AND IMAGES; ELECTRONIC MAIL SERVICES (U.S. CLS. 100, 101 AND 104).

CLASS 42—SCIENTIFIC, COMPUTER AND LEGAL SERVICES

FOR RENTAL OF COMPUTERS; COMPUTER CONSULTATION, NAMELY, CONSULTATION IN THE FIELD OF COMPUTER HARDWARE; COMPUTER PROGRAMMING FOR OTHERS; MAINTENANCE OF COMPUTER SOFTWARE; UPDATING AND DESIGN OF COMPUTER SOFTWARE FOR OTHERS; COMPUTER SYSTEMS ANALYSIS (U.S. CLS. 100 AND 101).

CLASS 6—METAL GOODS

FOR FIGURINES OF COMMON METAL (U.S. CLS. 2, 12, 13, 14, 23, 25 AND 50).

CLASS 14—JEWELRY

FOR FIGURINES OF PRECIOUS METAL (U.S. CLS. 2, 27, 28 AND 50).

CLASS 20—FURNITURE AND ARTICLES NOT OTHERWISE CLASSIFIED

FOR FIGURINES OF SYNTHETIC RESIN (U.S. CLS. 2, 13, 22, 25, 32 AND 50).

CLASS 21—HOUSEWARES AND GLASS

FOR FIGURINES OF GLASS, PORCELAIN, AND EARTHENWARE (U.S. CLS. 2, 13, 23, 29, 30, 33, 40 AND 50).

SN 75-633,998. CALIFORNIA SUNCARE, INC., LOS ANGELES, CA. FILED 2-5-1999.

LAVA2140**CLASS 38—COMMUNICATION**

FOR TELECOMMUNICATION INFORMATION SERVICES, NAMELY, PERSONAL COMMUNICATION SERVICE, WIRELESS TRANSMISSION OF VOICE, VIDEO, MESSAGES AND DATA (U.S. CLS. 100, 101 AND 104).

CLASS 42—SCIENTIFIC, COMPUTER AND LEGAL SERVICES

FOR COMPUTER SOFTWARE DEVELOPMENT FOR OTHERS IN THE FIELD OF INTERACTIVE WIRELESS TELECOMMUNICATION GATEWAY SERVICES, NAMELY, PROVIDING TECHNICAL LINKS TO COMPUTER DATABASES AND GLOBAL COMPUTER INFORMATION NETWORKS (U.S. CLS. 100 AND 101).

SN 75-637,480. TELOGY, INC., MENLO PARK, CA. FILED 2-10-1999.

SN 75-654,099. JET CONNECTION BUSINESSFLIGHT AG, D-651B9 WEISBADEN, FED REP GERMANY, FILED 3-8-1999.

TECENTRAL

CLASS 35—ADVERTISING AND BUSINESS

FOR TELEPHONE AND ON-LINE ORDERING OF NEW AND REFURBISHED ELECTRONIC TEST EQUIPMENT (U.S. CLS. 100, 101 AND 102).

FIRST USE 4-23-1996; IN COMMERCE 4-23-1996.

CLASS 42—SCIENTIFIC, COMPUTER AND LEGAL SERVICES

FOR RENTAL AND LEASING OF NEW AND USED ELECTRONIC TEST EQUIPMENT (U.S. CLS. 100 AND 101).

FIRST USE 4-23-1996; IN COMMERCE 4-23-1996.

SN 75-654,076. CRISPLANT A/S, 8200 ARHUS N, DENMARK, FILED 3-8-1999.



CLASS 7—MACHINERY

FOR SORTING MACHINES AND STRUCTURAL PARTS THEREFOR FOR SORTING VARIOUS PRODUCTS FOR INDUSTRIAL AND COMMERCIAL USE; METAL PARTS FOR SORTING MACHINES, NAMELY, FRAMES, TRAYS, CARTS, REALIGNMENTS RAILS, AND SORTER TRACKS; TILTING ACTUATORS AND LINEAR DRIVES IN THE NATURE OF MOTORS OR ENGINES FOR SORTING MACHINES (U.S. CLS. 13, 19, 21, 23, 31, 34 AND 35).

FIRST USE 0-0-1992; IN COMMERCE 0-0-1992.

CLASS 9—ELECTRICAL AND SCIENTIFIC APPARATUS

FOR COMPUTER HARDWARE FOR STEERING AND CONTROL OF SORTING MACHINES; COMPUTER SOFTWARE FOR THE CONTROLLING AND STEERING OPERATIONS OF SORTING MACHINES (U.S. CLS. 21, 23, 26, 36 AND 38).

FIRST USE 0-0-1992; IN COMMERCE 0-0-1992.

CLASS 37—CONSTRUCTION AND REPAIR

FOR INSTALLATION, MAINTENANCE, AND REPAIR OF SORTING MACHINES (U.S. CLS. 100, 103 AND 106).

FIRST USE 0-0-1992; IN COMMERCE 0-0-1992.

CLASS 42—SCIENTIFIC, COMPUTER AND LEGAL SERVICES

FOR DESIGN OF SORTING MACHINES FOR OTHERS; CONSULTATION IN THE FIELD OF PLANNING, INSTALLATION, FUNCTION, AND MAINTENANCE OF SORTING MACHINES (U.S. CLS. 100 AND 101).

FIRST USE 0-0-1992; IN COMMERCE 0-0-1992.

JET CONNECTION

PRIORITY CLAIMED UNDER SEC. 44(D) ON FED REP GERMANY APPLICATION NO. A9878467, FILED 9-9-1998, REG. NO. 39851538, DATED 11-20-1998, EXPIRES 9-30-2008.

NO CLAIM IS MADE TO THE EXCLUSIVE RIGHT TO USE "JET", APART FROM THE MARK AS SHOWN.

CLASS 35—ADVERTISING AND BUSINESS

FOR ACQUISITION SERVICES, NAMELY, PURCHASING AIRCRAFT IN FRACTIONAL INTERESTS FOR OTHERS; BUSINESS CONSULTATION SERVICES IN THE FIELD OF AIRPORT OPERATIONS; PURCHASING AGENT SERVICES FOR AIRCRAFT AND FRACTIONAL INTERESTS IN AIRCRAFT; AND BUSINESS MANAGEMENT OF AIR CARRIERS (U.S. CLS. 100, 101 AND 102).

CLASS 36—INSURANCE AND FINANCIAL

FOR FINANCING SERVICES RELATED TO AIRCRAFT; AIRCRAFT CHARTER BROKERAGE SERVICES; CONSULTING SERVICES IN THE FIELD OF AIRCRAFT FINANCING (U.S. CLS. 100, 101 AND 102).

CLASS 39—TRANSPORTATION AND STORAGE

FOR AIRCRAFT TRANSPORTATION SERVICES; HIRING AND CHARTERING OF TRANSPORT AIRCRAFT; AIRCRAFT CHARTERING SERVICES; CARGO TRANSPORT BROKERAGE; AIRCRAFT FREIGHT TRANSPORT BROKERAGE; TRANSPORT AND FREIGHT BROKERAGE SERVICES; AIRCRAFT LEASING SERVICES; AND TRANSPORTATION RESERVATION SERVICES (U.S. CLS. 100 AND 105).

CLASS 42—SCIENTIFIC, COMPUTER AND LEGAL SERVICES

FOR RESERVING CATERING SERVICES FOR OTHERS; COMPUTER CONSULTATION SERVICES; AND TECHNICAL CONSULTATION IN THE FIELD OF AIRPORT OPERATIONS (U.S. CLS. 100 AND 101).

SN 75-657,238. GILLIGAN, ROBERT, NEW YORK, NY, FILED 3-10-1999.

INNERSPACE/OUTERSPACE HEALTH AND BEAUTY

NO CLAIM IS MADE TO THE EXCLUSIVE RIGHT TO USE "HEALTH AND BEAUTY", APART FROM THE MARK AS SHOWN.

CLASS 3—COSMETICS AND CLEANING PREPARATIONS

FOR HEALTH AND BEAUTY AIDS, NAMELY, AFTER SHAVE LOTIONS, AFTER-SUN LOTIONS, ANTI-AGING CREAM, ANTI-BACTERIAL SOAP, ASTRINGENTS FOR COSMETIC PURPOSES, BABY HAIR CONDITIONER, BATH GELS, BATH OILS, BATH PEARLS, BATH POWDER, NON-MEDICATED BATH SALTS, BEAUTY MASKS, BODY CREAM, BODY EMULSIONS, BODY MASK CREAMS, BODY MASK LOTIONS, BODY MASK POWDERS, BODY MASKS, BODY OILS, BODY POWDERS, BODY SCRUBS, COSMETIC PENCILS, EYE CREAM, HAND CREAM, NIGHT CREAM, SHAVING CREAM, SKIN CREAM, SKIN CLEANSING CREAM, EYE GELS, EYE MAKEUP REMOVER, EYE MAKEUP, EYE PENCILS, EYE SHADOW, FACIAL CLEANSERS, FACIAL CREAMS, FACIAL EMULSIONS, FACIAL MASKS, FACIAL SCRUBS, HAIR GEL, SHAVING GEL, SHOWER GEL, HAIR CARE PREPARATIONS, HAIR LOTION, HAIR POMADES, LIP GLOSS, LIP LINERS, LIPSTICKS, MAKEUP REMOVER, FACIAL MAKEUP, FOUNDATION MAKEUP, SKIN MOISTURIZER, NAIL POLISH, SHAMPOO-CONDITIONERS, SKIN SOAP AND SUN TAN LOTION (U.S. CLS. 1, 4, 6, 50, 51 AND 52).

CLASS 4—LUBRICANTS AND FUELS

FOR CANDLES (U.S. CLS. 1, 6 AND 15).

CLASS 5—PHARMACEUTICALS

FOR NUTRITIONAL SUPPLEMENTS (U.S. CLS. 6, 18, 44, 46, 51 AND 52).

CLASS 16—PAPER GOODS AND PRINTED MATER

FOR PRINTED DIET PLANS (U.S. CLS. 2, 5, 22, 23, 29, 37, 38 AND 50).

SN 75-658,403. GENLYTE THOMAS GROUP LLC, LOUISVILLE, KY. BY ASSIGNMENT GENLYTE GROUP INCORPORATED, THE, UNION, NJ. FILED 3-11-1999.

KNIGHTWATCH**CLASS 9—ELECTRICAL AND SCIENTIFIC APPARATUS**

FOR MOTION SENSOR CONTROLLERS (U.S. CLS. 21, 23, 26, 36 AND 38).
FIRST USE 3-0-1999; IN COMMERCE 3-0-1999.

CLASS 11—ENVIRONMENTAL CONTROL APPARATUS

FOR LIGHTING FIXTURES WITH MOTION SENSORS SOLD AS A UNIT (U.S. CLS. 13, 21, 23, 31 AND 34).
FIRST USE 3-0-1999; IN COMMERCE 3-0-1999.

SN 75-678,737. LINKGUARD LIMITED, SALFORD M7 4AS, ENGLAND, FILED 4-9-1999.

LINKGUARD

PRIORITY CLAIMED UNDER SEC. 44(D) ON UNITED KINGDOM APPLICATION NO. 2190290, FILED 2-26-1999, REG. NO. 2190290, DATED 2-26-1999, EXPIRES 2-26-2009.

CLASS 9—ELECTRICAL AND SCIENTIFIC APPARATUS

FOR COMPUTER HARDWARE, SOFTWARE AND FIRMWARE, ALL FOR MONITORING AND/OR MODIFYING AND/OR UPDATING WEB PAGES AND/OR LINKS TO SUCH PAGES, AND FOR NOTIFYING SUBSCRIBERS OF CHANGES TO WEB PAGES (U.S. CLS. 21, 23, 26, 36 AND 38).

CLASS 42—SCIENTIFIC, COMPUTER AND LEGAL SERVICES

FOR COMPUTER SERVICES, NAMELY, MONITORING STATUS OF GLOBAL COMPUTER NETWORK PAGES FOR OTHERS; CHECKING AND/OR MODIFYING AND/OR UPDATING WEB PAGES AND/OR LINKS TO SUCH PAGES FOR OTHERS; NOTIFYING SUBSCRIBERS OF CHANGES TO WEB PAGES (U.S. CLS. 100 AND 101).

SN 75-679,631. BTP CHEMICALS PLC, MANCHESTER, M44 5BX, UNITED KINGDOM, FILED 4-12-1999.

ARCHIMICA**CLASS 1—CHEMICALS**

FOR CHEMICALS AND CHEMICAL PRODUCTS FOR USE IN THE MANUFACTURE OF AGROCHEMICALS, PHARMACEUTICALS AND SPECIALTY CHEMICALS (U.S. CLS. 1, 5, 6, 10, 26 AND 46).

CLASS 5—PHARMACEUTICALS

FOR PHARMACEUTICAL PREPARATIONS USED TO TREAT; COMMON COLDS, ASTHMA, LIVER DISEASE, WARTS, BLEMISHES, CANCER, AND AIDS; PHARMACEUTICAL PREPARATIONS CLASSIFIED AS ANTI-INFLAMMATORIES, ANTI-CANCER, CARDIAC DEPRESSANTS, ANTI-ARRHYTHMICS, ANTI-VIRALS; DIETARY SUPPLEMENTS, NUTRITIONAL SUPPLEMENTS; ADDITIVES IN MILK FOR NUTRITION IN BABY FOOD; DIURETICS; INTRAVENOUS ANESTHETICS, LOCAL ANESTHETICS, TRANQUILIZERS, CORONARY VASODILATORS, ANTI-ANGINALS, ANALGESICS; VETERINARY PREPARATIONS CLASSIFIED AS - VETERINARY ANTIBACTERIAL; SANITIZERS FOR INDUSTRIAL OR HOUSEHOLD USE (U.S. CLS. 6, 18, 44, 46, 51 AND 52).

SN 75-680,873. LEYBOLD MATERIALS GMBH, 63450 HANAU, FED REP GERMANY, FILED 4-7-1999.

LEYBOLD MATERIALS

PRIORITY CLAIMED UNDER SEC. 44(D) ON FED REP GERMANY APPLICATION NO. 39857722.6, FILED 10-8-1998.
NO CLAIM IS MADE TO THE EXCLUSIVE RIGHT TO USE "MATERIALS", APART FROM THE MARK AS SHOWN.

CLASS 1—CHEMICALS

FOR ADHESIVES, NAMELY, THERMALLY STABLE ADHESIVES, ADHESIVES CONTAINING EPOXY RESINS, AND ADHESIVES CONTAINING SILICON, ALL IN THE NATURE OF A COATING FOR USE IN THE PREPARATION OF SPUTTER CATHODES (U.S. CLS. 1, 5, 6, 10, 26 AND 46).

CLASS 6—METAL GOODS

FOR SOLDERS USED IN THE FIELD OF PREPARATION OF SPUTTER CATHODES; UNSHAPED, PARTIALLY SHAPED, AND FULLY SHAPED NON-NOBLE METALS AND NON-METAL AND THEIR ALLOYS, NAMELY, ALUMINUM, IRON, SILICON, MOLYBDENUM, TUNGSTEN, COBALT, COPPER, NICKEL, CHROMIUM, INDIUM, TIN, SILICON, ALLOYS CONTAINING ZINC; METAL COMPONENTS IN THE FORM OF FORMED PIECES, NAMELY, CAST PIECES, PRESSED PIECES, SINTERED PIECES FOR USE IN CATHODE SPUTTERING AND ALSO FOR USE IN THE ELECTRONIC, DATA STORAGE TECHNOLOGY, GLASS, SOLAR TECHNOLOGY, CONSTRUCTION, AND AUTOMOBILE INDUSTRIES, NAMELY, FOR THE REACTIVE OR NON-REACTIVE PLASMA PRODUCED LAYERS OF MAGNETIC STORAGE CAPABILITY, TRIBOLOGIC LAYERS, LOW-E GLASS LAYERS, DECORATIVE LAYERS, REFLECTIVE COATINGS, ANTI-REFLECTION COATINGS, RESISTANCE COATING, CONDUCTIVE COATINGS, DIFFUSION COATINGS, AND TRANSPARENT COATINGS (U.S. CLS. 2, 12, 13, 14, 23, 25 AND 50).

CLASS 11—ENVIRONMENTAL CONTROL APPARATUS

FOR MATERIAL FOR VAPORIZATION, ESPECIALLY METAL AND METAL ALLOYS PRODUCTS, IN PARTICULAR THOSE MADE ESSENTIALLY OF ALUMINUM, LEAD, CHROMIUM, IRON, GERMANIUM, GOLD, INDIUM, COPPER, NICKEL, TITANIUM, PALLADIUM, PLATINUM, SILVER, TIN, ZINC, ZIRCONIUM-CONTAINING ALLOYS AS WELL AS METAL OXIDES, IN PARTICULAR ALUMINUM OXIDE, BARIUM TITANATE, CERIUM OXIDE, CHROMIUM OXIDE, HAFNIUM OXIDE, MAGNESIUM OXIDE, SILICON DIOXIDE, SILICON MONOXIDE, TANTALUM OXIDE, TITANIUM OXIDE, TITANIUM DIOXIDE, ZIRCONIUM OXIDE CONTAINING ALLOYS IS AS WELL AS FLUORIDES IN PARTICULAR, MAGNESIUM FLUORIDES, CRYOLITH, LANTHANUM FLUORIDE, LITHIUM FLUORIDE, AS WELL AS IN PARTICULAR METAL SULFIDES ESPECIALLY ANTIMONY SULFIDE, ZINC SULFIDE, INDIUM ANTIMONY CONTAINING ALLOYS AS WELL AS SELENIUM COMPOUNDS, IN PARTICULAR WISMUTH, SELENIDE, CADMIUM SELENIDE, INDIUM ARSENIDE, INDIUM SELENIDE, LEAD SELENIDE, ZINC SELENIDE CONTAINING ALLOYS AS WELL AS TELLURIDES, IN PARTICULAR CADMIUM TELLURIDES, LEAD TELLURIDES, ZINC TELLURIDES CONTAINING ALLOYS; SOURCES OF VAPORIZATION IN PARTICULAR CRYSTALS OF HIGH MELTING MATERIALS MADE OF MOLYBDENUM, TANTALUM TUNGSTATE, AND GRAPHITE FOR MELTING AND VAPORIZATION OF METALS FOR METAL ALLOYS IN PARTICULAR COPPER, GOLD, ALUMINUM, SILVER, CHROMIUM, NICKEL, MAGNESIUM, AS WELL AS SILICON CONTAINING ALLOYS FOR REACTIVE OR NON-REACTIVE COATINGS OF REFLECTION, ANTI-REFLECTION, LOW-E, DECORATIVE OR DIFFUSION COATINGS ON SUBSTANCES (U.S. CLS. 13, 21, 23, 31 AND 34).

CLASS 14—JEWELRY

FOR UNSHAPED, PARTIALLY SHAPED, FULLY SHAPED PRECIOUS METALS AND THEIR ALLOYS, NAMELY, TITANIUM, GOLD, PLATINUM, PALLADIUM, RUTHENIUM, AND OSMIUM; PRECIOUS METAL COMPONENTS IN THE FORM OF FORMED PIECES, NAMELY, CAST PIECES, PRESSED PIECES, SINTERED PIECES, AND WORK PIECES FOR USE IN CATHODE SPUTTERING AND ALSO FOR USE IN THE ELECTRONIC, DATA STORAGE TECHNOLOGY, GLASS, SOLAR TECHNOLOGY, CONSTRUCTION, AND AUTOMOBILE INDUSTRIES, NAMELY, FOR THE REACTIVE OR NON-REACTIVE PLASMA PRODUCED LAYERS OF MAGNETIC STORAGE CAPABILITY, TRIBOLOGIC LAYERS, LOW-E GLASS LAYERS, DECORATIVE LAYERS, REFLECTIVE COATINGS, ANTI-REFLECTION COATINGS, RESISTANCE COATING, CONDUCTIVE COATINGS, DIFFUSION COATINGS, AND TRANSPARENT COATINGS (U.S. CLS. 2, 27, 28 AND 50).

CLASS 40—MATERIAL TREATMENT

FOR MATERIAL TREATMENT SERVICES IN THE FIELD OF SPUTTERING TARGETS AND SPUTTERING MATERIALS; CUSTOM MANUFACTURING OF SPUTTERING TARGETS AND SPUTTERING MATERIALS FOR OTHERS (U.S. CLS. 100, 103 AND 106).

SN 75-683,701. YOUNG'S, INC., DUNDEE, MI. FILED 4-15-1999.

BERRY HILL BEARS

NO CLAIM IS MADE TO THE EXCLUSIVE RIGHT TO USE "BEARS", APART FROM THE MARK AS SHOWN.

CLASS 9—ELECTRICAL AND SCIENTIFIC APPARATUS

FOR DECORATIVE MAGNETS (U.S. CLS. 21, 23, 26, 36 AND 38).
FIRST USE 1-1-1998; IN COMMERCE 1-1-1998.

CLASS 11—ENVIRONMENTAL CONTROL APPARATUS

FOR LAMPS (U.S. CLS. 13, 21, 23, 31 AND 34).
FIRST USE 1-1-1998; IN COMMERCE 1-1-1998.

CLASS 15—MUSICAL INSTRUMENTS

FOR MUSIC BOXES (U.S. CLS. 2, 21 AND 36).
FIRST USE 1-1-1998; IN COMMERCE 1-1-1998.

CLASS 16—PAPER GOODS AND PRINTED MATTER

FOR GREETING CARDS AND PHOTOGRAPHIC ALBUMS (U.S. CLS. 2, 5, 22, 23, 29, 37, 38 AND 50).
FIRST USE 1-1-1998; IN COMMERCE 1-1-1998.

CLASS 20—FURNITURE AND ARTICLES NOT OTHERWISE CLASSIFIED

FOR FIGURINES MADE OF PLASTIC (U.S. CLS. 2, 13, 22, 25, 32 AND 50).
FIRST USE 1-1-1998; IN COMMERCE 1-1-1998.

CLASS 21—HOUSEWARES AND GLASS

FOR FIGURINES MADE OF CERAMICS; FIGURINES MADE OF DOLOMITE; SOAP DISPENSERS; TOOTHBRUSH HOLDERS; TEA SETS; AND FLOWER POTS (U.S. CLS. 2, 13, 23, 29, 30, 33, 40 AND 50).
FIRST USE 1-1-1998; IN COMMERCE 1-1-1998.

CLASS 28—TOYS AND SPORTING GOODS

FOR CHRISTMAS TREE ORNAMENTS (U.S. CLS. 22, 38 AND 50).
FIRST USE 1-1-1998; IN COMMERCE 1-1-1998.

SN 75-683,746. PROGRAMMERS' CONSORTIUM, INC., THE, RESTON, VA. FILED 4-15-1999.

SN 75-697,788. RESTAURANTS RAYMICK INC., SHERBROOKE, QUEBEC, CANADA, FILED 5-4-1999.

DIGITAL MOVEMENT OF VOICE

NO CLAIM IS MADE TO THE EXCLUSIVE RIGHT TO USE "DIGITAL", APART FROM THE MARK AS SHOWN.

CLASS 9—ELECTRICAL AND SCIENTIFIC APPARATUS

FOR COMPUTER SOFTWARE DEVELOPMENT TOOLS FOR FACILITATING DICTATION AND TRANSCRIPTION DIGITALLY ACROSS COMPUTER NETWORKS AND ON-LINE GLOBAL COMPUTER NETWORKS (U.S. CLS. 21, 23, 26, 36 AND 38).
FIRST USE 2-2-1996; IN COMMERCE 2-16-1996.

CLASS 42—SCIENTIFIC, COMPUTER AND LEGAL SERVICES

FOR INTEGRATION OF COMPUTER SYSTEMS AND NETWORKS FOR FACILITATING DICTATION AND TRANSCRIPTION DIGITALLY ACROSS COMPUTER NETWORKS AND ON-LINE GLOBAL COMPUTER NETWORKS (U.S. CLS. 100 AND 101).
FIRST USE 2-2-1996; IN COMMERCE 2-16-1996.



PRIORITY CLAIMED UNDER SEC. 44(D) ON CANADA APPLICATION NO. 895,748, FILED 11-10-1998, REG. NO. 528596, DATED 5-30-2000, EXPIRES 5-30-2015.

NO CLAIM IS MADE TO THE EXCLUSIVE RIGHT TO USE "POULET ROTI ET BURGER", APART FROM THE MARK AS SHOWN.

THE ENGLISH TRANSLATION OF "POULET ROTI ET BURGER" IS "ROASTED CHICKEN AND BURGER".

CLASS 29—MEATS AND PROCESSED FOODS

FOR ROASTED AND GRILLED CHICKEN, CHICKEN PIECES, FRENCH FRIED POTATOES AND MASHED POTATOES (U.S. CL. 46).

CLASS 30—STAPLE FOODS

FOR FISH SANDWICHES, CHICKEN SANDWICHES, AND RICE PILAF (U.S. CL. 46).

CLASS 42—SCIENTIFIC, COMPUTER AND LEGAL SERVICES

FOR RESTAURANTS SERVICES, FEATURING HOME DELIVERY (U.S. CLS. 100 AND 101).

SN 75-693,085. PRICE CURTIN WARREN BOROSKY, INC., SAN FRANCISCO, CA. FILED 4-28-1999.

SN 75-711,031. EIRCOM PUBLIC LIMITED COMPANY, DUBLIN 2, IRELAND, BY CHANGE OF NAME BORD TELECOM EIREANN PLC, DUBLIN 2, IRELAND, FILED 5-19-1999.

ELEVEN

CLASS 35—ADVERTISING AND BUSINESS

FOR ADVERTISING SERVICES, NAMELY, THE PRODUCTION OF RADIO AND TELEVISION COMMERCIALS AND THE PUBLICATION OF PRINT ADVERTISEMENTS; MEDIA BUYING OF ADVERTISING TIME AND SPACE FOR OTHERS; DEVELOPING NON-BROADCAST CORPORATE CAMPAIGNS FOR BUSINESSES; AND CONSULTATION SERVICES, NAMELY, CONSULTATION REGARDING BRANDS AND NAMES FOR THE PRODUCTS AND SERVICES OF OTHERS (U.S. CLS. 100, 101 AND 102).

CLASS 42—SCIENTIFIC, COMPUTER AND LEGAL SERVICES

FOR COMPUTER SERVICES, NAMELY, CREATING WEB SITES FOR OTHERS (U.S. CLS. 100 AND 101).



PRIORITY CLAIMED UNDER SEC. 44(D) ON IRELAND APPLICATION NO. 99/1065, FILED 3-26-1999, REG. NO. 213823, DATED 3-26-1999, EXPIRES 3-26-2006.

THE MARK CONSISTS OF A PART CIRCLE OR GLOBE INCORPORATING STRIPES EXTENDING PARTIALLY FROM LEFT TO RIGHT AS A MEANS OF PORTRAYING ROTATION.

CLASS 9—ELECTRICAL AND SCIENTIFIC APPARATUS

FOR ELECTRONIC COMMUNICATION APPARATUS, INSTRUMENTS AND INSTALLATIONS, NAMELY, MOBILE AND HAND HELD TELEPHONES, MODEMS; TELECOMMUNICATIONS SOFTWARE, NAMELY, SOFTWARE FOR USE IN ACCESSING AND TRANSMITTING SWITCHED PACKET DATA VIA INTERCONNECTED COMPUTER NETWORKS LINKED BY COMMON COMMUNICATIONS PROTOCOLS; TELECOMMUNICATIONS SOFTWARE FOR USE IN OPERATING PUBLIC SWITCH TELEPHONE NETWORK SYSTEMS AND MOBILE TELEPHONY NETWORKS (U.S. CLS. 21, 23, 26, 36 AND 38).

CLASS 38—COMMUNICATION

FOR TELECOMMUNICATIONS SERVICES, NAMELY, TELEPHONE AND ELECTRONIC TRANSMISSION OF SOUND, VOICE AND DATA (U.S. CLS. 100, 101 AND 104).

SN 75-721,018, PENNZOIL-QUAKER STATE COMPANY, HOUSTON, TX. FILED 6-3-1999.

ROADSIDE**CLASS 1—CHEMICALS**

FOR CHEMICAL COMPOUNDS FOR SEALING AND INFLATING TIRES OF VEHICLES, AUTOMOTIVE CHEMICAL ADDITIVES, NAMELY, CHEMICAL FUEL AND MOTOR OIL ADDITIVES FOR INTERNAL COMBUSTION ENGINES, CHEMICAL ADDITIVES FOR ENGINE AND FUEL TREATMENT, CHEMICAL PREPARATIONS FOR USE IN THE MANUFACTURE OF MOTOR OIL AND FUEL ADDITIVES (U.S. CLS. 1, 5, 6, 10, 26 AND 46).

CLASS 4—LUBRICANTS AND FUELS

FOR EMERGENCY FUEL FOR VEHICLES, NAMELY GASOLINE AND DIESEL FUELS (U.S. CLS. 1, 6 AND 15).

CLASS 9—ELECTRICAL AND SCIENTIFIC APPARATUS

FOR SAFETY MARKERS, BATTERY BOOSTER CABLES, AND BATTERY CHARGERS (U.S. CLS. 21, 23, 26, 36 AND 38).

SN 75-725,752, MIX PROMOTIONS INC., LAVAL, PROVINCE OF QUEBEC, CANADA, FILED 6-8-1999.

MIRADOR HOUSEWARES

OWNER OF CANADA REG. NO. TMA546193, DATED 6-5-2001, EXPIRES 6-5-2016.

NO CLAIM IS MADE TO THE EXCLUSIVE RIGHT TO USE "HOUSEWARES", APART FROM THE MARK AS SHOWN.

CLASS 7—MACHINERY

FOR ELECTRIC HOUSEHOLD APPLIANCES, NAMELY, FOOD MIXERS AND STRUCTURAL PARTS THEREOF AND ATTACHMENTS THEREFOR SOLD AS A UNIT, THE ATTACHMENTS COMPRISING BOWLS, MEAT GRINDER, FRUIT AND VEGETABLE SLICER AND SHREDDER, LIQUID MIXER OR BEATER, KNIFE SHARPENER, CAN OPENERS; JUICE EXTRACTOR AND BOWL SOLD AS A UNIT; COFFEE GRINDERS (U.S. CLS. 13, 19, 21, 23, 31, 34 AND 35).

CLASS 9—ELECTRICAL AND SCIENTIFIC APPARATUS

FOR ELECTRIC HOUSEHOLD APPLIANCES, NAMELY, STEAM IRONS (U.S. CLS. 21, 23, 26, 36 AND 38).

CLASS 11—ENVIRONMENTAL CONTROL APPARATUS

FOR ELECTRIC HOUSEHOLD APPLIANCES, NAMELY, ICE CREAM FREEZERS; TOASTERS; COFFEE MAKERS AND STRUCTURAL PARTS THEREOF (U.S. CLS. 13, 21, 23, 31 AND 34).

SN 75-729,908, WEST AGRO, INC., KANSAS CITY, MO. BY MERGER K-KLEAN CHEMICAL CO., INC., DALLAS, TX. FILED 10-30-1999.



NO CLAIM IS MADE TO THE EXCLUSIVE RIGHT TO USE "QUALITY", "SERVICE" AND "INC.", APART FROM THE MARK AS SHOWN.

CLASS 41—EDUCATION AND ENTERTAINMENT

FOR EDUCATIONAL SERVICES, NAMELY, CONDUCTING TRAINING SESSIONS AND CLASSES IN THE FIELD OF SANITATION AND SANITATION SAFETY (U.S. CLS. 100, 101 AND 107).
FIRST USE 5-1-1976; IN COMMERCE 5-1-1976.

CLASS 42—SCIENTIFIC, COMPUTER AND LEGAL SERVICES

FOR SANITATION CONSULTING SERVICES, NAMELY, CREATING AND DEVELOPING CLEANING AND SANITIZING PROCEDURES FOR OTHERS AND MONITORING SANITATION PRACTICES FOR OTHER (U.S. CLS. 100 AND 101).
FIRST USE 5-1-1976; IN COMMERCE 5-1-1976.

SN 75-736,458, EPLUS, INC., HERNDON, VA. BY CHANGE OF NAME MLC HOLDINGS, INC., HERNDON, VA. FILED 6-24-1999.

EPLUS**CLASS 35—ADVERTISING AND BUSINESS**

FOR ONLINE RETAIL AND INVENTORY CONTROL SERVICES IN THE FIELD OF COMPUTER AND TELECOMMUNICATIONS EQUIPMENT (U.S. CLS. 100, 101 AND 102).
FIRST USE 10-25-1999; IN COMMERCE 11-1-1999.

CLASS 36—INSURANCE AND FINANCIAL

FOR FINANCING OF COMPUTER AND TELECOMMUNICATIONS EQUIPMENT (U.S. CLS. 100, 101 AND 102).
FIRST USE 10-25-1999; IN COMMERCE 11-1-1999.

CLASS 38—COMMUNICATION

FOR LEASING OF TELECOMMUNICATIONS EQUIPMENT (U.S. CLS. 100, 101 AND 104).
FIRST USE 10-25-1999; IN COMMERCE 11-1-1999.

CLASS 42—SCIENTIFIC, COMPUTER AND LEGAL SERVICES

FOR LEASING OF COMPUTER EQUIPMENT (U.S. CLS. 100 AND 101).
FIRST USE 10-25-1999; IN COMMERCE 11-1-1999.

SN 75-742,768. POLAROID CORPORATION, CAMBRIDGE, MA. FILED 7-2-1999.

RE-LIVE YOUR MILLENNIUM FUN AT 12:01

CLASS 1—CHEMICALS

FOR UNEXPOSED PHOTOGRAPHIC FILM (U.S. CLS. 1, 5, 6, 10, 26 AND 46).

CLASS 9—ELECTRICAL AND SCIENTIFIC APPARATUS

FOR PHOTOGRAPHIC CAMERAS; DIGITAL AND ELECTRONIC CAMERAS FOR TAKING PHOTOGRAPHS; COMPUTER PRINTERS; COMPUTER PERIPHERALS, NAMELY, SCANNERS, CONNECTING DEVICES, ADAPTERS; COMPUTERS; BLANK VIDEO CASSETTES; PRE-RECORDED COMPACT DISCS; SUNGLASSES; SUNGLASS AND EYEGLASS FRAMES, LENSES, FILTERS, AND SMALL CARRYING CASES THEREOF; COMPUTER SOFTWARE FOR MANIPULATING, MANAGING, AND INTEGRATING DATA, PHOTOGRAPHS, IMAGES, AND SOUND; DIGITAL COLOR PROOFING SOFTWARE FOR GRAPHIC ARTS APPLICATIONS; VIDEO CAMERAS; DATABASE SYSTEM COMPRISING COMPUTER HARDWARE AND OPERATING SOFTWARE FOR PROCESSING PHOTOGRAPHS; BATTERIES; CAMERA TRIPODS AND CAMERA STANDS; OVERHEAD AND SLIDE PROJECTORS; CAMERA VIEWFINDERS; PHOTOGRAPHIC FLASHBULBS; AUTOMATIC INSTANT FILM PROCESSORS; COLOR CALIBRATION SOFTWARE FOR ADJUSTING COLOR IN SCANNED PHOTOGRAPHS; CLOSE-UP STANDS FOR CAMERAS (U.S. CLS. 21, 23, 26, 36 AND 38).

CLASS 16—PAPER GOODS AND PRINTED MATTER

FOR GREETING CARDS (U.S. CLS. 2, 5, 22, 23, 29, 37, 38 AND 50).

SN 75-749,670. INFOMATEC INTEGRATED INFORMATION SYSTEMS AG, D-86167 AUGSBURG, FED REP GERMANY, FILED 7-13-1999.

INFOMATEC

OWNER OF FED REP GERMANY REG. NO. 39864419, DATED 11-26-1998, EXPIRES 11-30-2008.

CLASS 9—ELECTRICAL AND SCIENTIFIC APPARATUS

FOR DATA PROCESSORS, COMPUTERS, COMPUTER SOFTWARE ALLOWING USERS TO PERFORM ECOMMERCE BUSINESS TRANSACTIONS, TO ACCESS DATABASES, DATA MANAGEMENT, TO MANAGE CATALOG DATA, TO INTEGRATE WORLD WIDE WEB TELEVISION SYSTEMS, TO CONFIGURE WORLD WIDE WEB CONFIGURATION SYSTEMS, ALL FOR USE WITH GLOBAL COMMUNICATIONS NETWORKS (U.S. CLS. 21, 23, 26, 36 AND 38).

CLASS 42—SCIENTIFIC, COMPUTER AND LEGAL SERVICES

FOR DEVELOPMENT, INSTALLATION AND MAINTENANCE OF SOFTWARE PROGRAMS FOR - GLOBAL COMMUNICATION NETWORK SUPPORT, AND FOR DATA PROCESSING AND FOR SYSTEM TECHNOLOGY CONCERNING RETAIL; ECONOMIC, PAYROLL PREPARATION, LABEL PRINTING, PERSONNEL MANAGEMENT AND INFORMATION SYSTEMS; TECHNICAL CONSULTATION IN THE FIELD OF COMPUTERS (U.S. CLS. 100 AND 101).

SN 75-761,699. INDUSTRIAS EL GAMO, S.A., 08830 SANT BOI DE LLOBREGAT, SPAIN, FILED 7-27-1999.



PRIORITY CLAIMED UNDER SEC. 44(D) ON SPAIN APPLICATION NO. 2,210,116, FILED 1-27-1999, REG. NO. 2210116, DATED 6-3-1999, EXPIRES 6-3-2009.

PRIORITY CLAIMED UNDER SEC. 44(D) ON SPAIN APPLICATION NO. 2,210,115, FILED 1-27-1999, REG. NO. 2210115, DATED 6-3-1999, EXPIRES 6-3-2009.

PRIORITY CLAIMED UNDER SEC. 44(D) ON SPAIN APPLICATION NO. 2,210,114, FILED 1-27-1999, REG. NO. 2210114, DATED 6-3-1999, EXPIRES 6-3-2009.

PRIORITY CLAIMED UNDER SEC. 44(D) ON SPAIN APPLICATION NO. 2,210,113, FILED 1-27-1999, REG. NO. 2210113, DATED 6-21-1999, EXPIRES 6-21-2009.

OWNER OF U.S. REG. NOS. 2,115,108 AND 2,239,335.
THE ENGLISH TRANSLATION OF THE WORD "GAMO" IN THE MARK IS "DEER".

CLASS 9—ELECTRICAL AND SCIENTIFIC APPARATUS

FOR SIGHTS FOR FIREARMS AND SUNGLASSES EXCLUDING RADIO AND TELEVISION APPARATUS, MONOCULARS, BINOCULARS, LASERS FOR NON-MEDICAL USE, MICROSCOPES, TELEMETERS, TELESCOPES, DIRECTIONAL COMPASSES, EMERGENCY SIGNAL LANTERNS (U.S. CLS. 21, 23, 26, 36 AND 38).

CLASS 13—FIREARMS

FOR FIREARMS, AMMUNITION AND PROJECTILES, EXPLOSIVES, AND FIREWORKS (U.S. CLS. 2 AND 9).

CLASS 25—CLOTHING

FOR CLOTHING, NAMELY, COATS, JACKETS, PANTS, SUITS, DRESSES, SHIRTS, BLOUSES, SWEATERS, SKIRTS, NECKTIES, BERMUDA SHORTS, SHORTS, SWEATSHIRTS AND SWEATPANTS, TRACK SUITS, T-SHIRTS, TROUSERS, TAILOR-MADE PERIOD COSTUMES, LOUNGE WEAR, BLAZERS, WAISTCOATS, RAINWEAR, OVERCOATS, WIND-RESISTANT JACKETS, MUFFS, SCARVES, STOLES, GIRDLES, FOU-LARDS, SOCKS AND STOCKINGS, SLEEPWEAR; CLOTHING FOR SPORTS EXCEPT FOR CLOTHING FOR DIVING, NAMELY, BATHING SUITS, BATH ROBES, CAPS, CYCLING PANTS, LEGGINGS, SPORT LEGGINGS, SWIMWEAR; UNDERCLOTHES; BELTS, GLOVES, FOOTWEAR EXCEPT FOR ORTHOPEDIC FOOTWEAR AND HEADWEAR (U.S. CLS. 22 AND 39).

CLASS 28—TOYS AND SPORTING GOODS

FOR GAMES AND PLAYTHINGS, NAMELY, HAND-HELD DEVICE FOR PLAYING COMPUTER AND VIDEO GAMES; TOY AIR GUNS, TARGET BULLS, BITS OF POWDERED PERCUSSION PIECES FOR TOY GUNS, MAGIC TRICKS, PLUSHES AND DOLLS, ADAPTED CARRYBAGS; GYMNAS TIC AND SPORTING ARTI-CLES, NAMELY FISHING LINES, FISHING FLYRODS, ELBOW PATCHES, SHINPADS, PROTECTIVE SHOULDER PADS, SKIS, TENNIS RACKETS, BASKET-BALLS, FOOTBALLS, TENNIS BALLS AND SOCCER BALLS; DECORATIONS FOR CHRISTMAS TREES (U.S. CLS. 22, 23, 38 AND 50).

SN 75-766,141. HANGAR ONE, INC., CARROLLTON, GA. FILED 8-2-1999.

HANGAR ONE

NO CLAIM IS MADE TO THE EXCLUSIVE RIGHT TO USE "HANGAR", APART FROM THE MARK AS SHOWN.

CLASS 35—ADVERTISING AND BUSINESS

FOR DEALERSHIP SERVICES IN THE FIELD OF AIRCRAFT AND AIRCRAFT PARTS AND ACCESSORIES (U.S. CLS. 100, 101 AND 102).
FIRST USE 3-0-1999; IN COMMERCE 3-0-1999.

CLASS 37—CONSTRUCTION AND REPAIR

FOR AIRCRAFT REFURBISHMENT, REPAIR, MAINTENANCE, REFUELING AND CLEANING SERVICES (U.S. CLS. 100, 103 AND 106).
FIRST USE 3-0-1999; IN COMMERCE 3-0-1999.

CLASS 39—TRANSPORTATION AND STORAGE

FOR AIRCRAFT RENTAL, AIRCRAFT CHARTER TRANSPORTATION SERVICES AND GENERAL AVIATION FIXED BASE OPERATIONS (U.S. CLS. 100 AND 105).
FIRST USE 3-0-1999; IN COMMERCE 3-0-1999.

CLASS 41—EDUCATION AND ENTERTAINMENT

FOR AIRCRAFT FLIGHT INSTRUCTION AND TRAINING IN THE USE AND OPERATION OF AIRCRAFT (U.S. CLS. 100, 101 AND 107).
FIRST USE 3-0-1999; IN COMMERCE 3-0-1999.

SN 75-770,191. HEIMANN, JURGEN STEFFEN, SHERMAN OAKS, CA. FILED 8-30-1999.

PUPHEDZ**CLASS 9—ELECTRICAL AND SCIENTIFIC APPARATUS**

FOR PRERECORDED MOTION PICTURE FILMS AND VIDEO TAPES FEATURING ANIMATED CHARACTERS (U.S. CLS. 21, 23, 26, 36 AND 38).

CLASS 28—TOYS AND SPORTING GOODS

FOR DOLLS, BOARD GAMES AND TOY ACTION FIGURES (U.S. CLS. 22, 23, 38 AND 50).

SN 75-772,899. HEALTHANSWERS, INC., RESTON, VA. BY ASSIGNMENT MEDICAL CONSUMER MEDIA, INC., RESTON, VA. FILED 8-9-1999.

NET.SCORE**CLASS 41—EDUCATION AND ENTERTAINMENT**

FOR PROVIDING ONLINE EDUCATIONAL TESTING OF STUDENTS IN THE HEALTHCARE FIELDS FEATURING CONDUCTING TESTS, GRADING TESTS, COLLECTION OF TEST GRADES INTO AN ON-LINE DATABASE, AND ISSUING TEST RESULTS TO STUDENTS VIA A GLOBAL COMPUTER NETWORK (U.S. CLS. 100, 101 AND 107).

CLASS 42—SCIENTIFIC, COMPUTER AND LEGAL SERVICES

FOR TESTING AND EVALUATING STUDENT PRACTITIONERS, AND INDUSTRY PERSONNEL FOR THE PURPOSE OF ISSUING MEDICAL CERTIFICATION STATEMENTS (U.S. CLS. 100 AND 101).

SN 75-773,992. WONDERCLICK.COM, INC., WASHINGTON, DC. BY CHANGE OF NAME ABOVECABLE.COM, INC., WASHINGTON, DC. FILED 8-12-1999.

ABOVECABLE.COM**CLASS 35—ADVERTISING AND BUSINESS**

FOR PROMOTING THE GOODS AND SERVICES OF OTHERS BY PLACING ADVERTISEMENTS AND PROMOTIONAL DISPLAYS IN AN ELECTRONIC SITE ACCESSED THROUGH COMPUTER NETWORKS; PROVIDING ON-LINE COMPUTER DATABASES IN THE FIELDS OF BUSINESS AND SHOPPING; COMPUTERIZED ON-LINE ORDERING SERVICES VIA TELEPHONE, CABLE AND COMPUTER TERMINALS IN THE FIELDS OF BUSINESS AND SHOPPING (U.S. CLS. 100, 101 AND 102).

CLASS 38—COMMUNICATION

FOR TELECOMMUNICATIONS SERVICES, NAMELY ELECTRONIC TRANSMISSION OF DATA, IMAGES AND DOCUMENTS VIA COMPUTER TERMINALS; ELECTRONIC MAIL SERVICES; FACSIMILE TRANSMISSION; PROVIDING ON-LINE ELECTRONIC BULLETIN BOARDS FOR TRANSMISSION OF MESSAGES AMONG COMPUTER USERS CONCERNING BUSINESS, FINANCE, NEWS, WEATHER, SPORTS, COMPUTING, COMPUTER SOFTWARE, GAMES, MUSIC, THEATER, MOVIES, ENTERTAINMENT, TRAVEL, SHOPPING, COMPUTER SUPPORT, EDUCATION, LIFESTYLES AND HOBBIES; COMPUTER SERVICES, NAMELY, PROVIDING MULTIPLE-USER ACCESS TO AN INTERACTIVE COMPUTER DATABASE IN THE FIELDS OF NEWS, WEATHER, COMPUTING, COMPUTER SOFTWARE, COMPUTER SUPPORT, LIFESTYLES AND HOBBIES (U.S. CLS. 100, 101 AND 104).

CLASS 42—SCIENTIFIC, COMPUTER AND LEGAL SERVICES

FOR PROVIDING ON-LINE COMPUTER DATABASES IN THE FIELDS OF NEWS, WEATHER, COMPUTING, COMPUTER SOFTWARE, COMPUTER SUPPORT, LIFESTYLES, AND HOBBIES; COMPUTER CONSULTATION SERVICES (U.S. CLS. 100 AND 101).

SN 75-778,301. CENDANT PUBLISHING, INC., AURORA, CO. FILED 8-19-1999.

COMPLETEHOME

OWNER OF U.S. REG. NO. 1,795,446.

CLASS 36—INSURANCE AND FINANCIAL

FOR REAL ESTATE BROKERAGE SERVICES, REAL ESTATE LEASING, MORTGAGE LENDING SERVICES, MORTGAGE BROKERAGE SERVICES AND REAL ESTATE MANAGEMENT SERVICES; AND PROVIDING INFORMATION IN THE FIELD OF REAL ESTATE, REAL ESTATE FINANCING AND MORTGAGES, REAL ESTATE AGENTS, THE PURCHASE, SALE AND RENTAL OF REAL ESTATE VIA WEBSITES ON GLOBAL COMPUTER NETWORKS (U.S. CLS. 100, 101 AND 102).

CLASS 37—CONSTRUCTION AND REPAIR

FOR PROVIDING INFORMATION IN THE FIELD OF HOME REPAIR AND REMODELING SERVICES AND PRODUCTS VIA WEBSITES ON GLOBAL COMPUTER NETWORKS (U.S. CLS. 100, 103 AND 106).

CLASS 39—TRANSPORTATION AND STORAGE

FOR TRANSPORTATION OF PEOPLE, PETS AND/OR GOODS BY AIR, TRUCK AND RAIL; PROVIDING INFORMATION IN THE FIELD OF TRANSPORTATION AND STORAGE SERVICES VIA WEBSITES ON GLOBAL COMPUTER NETWORKS (U.S. CLS. 100 AND 105).

CLASS 42—SCIENTIFIC, COMPUTER AND LEGAL SERVICES

FOR PROVIDING INFORMATION IN THE FIELDS OF HOME DECORATING PRODUCTS AND SERVICES VIA WEBSITES ON GLOBAL COMPUTER NETWORKS (U.S. CLS. 100 AND 101).

SN 75-784,247. LINKLATERS BUSINESS SERVICES, LONDON EC2Y 8HQ, ENGLAND, FILED 8-25-1999.

LINKLATERS

PRIORITY CLAIMED UNDER SEC. 44(D) ON UNITED KINGDOM APPLICATION NO. 2200536, FILED 6-17-1999, REG. NO. 2200536, DATED 4-21-2000, EXPIRES 6-17-2010.

CLASS 9—ELECTRICAL AND SCIENTIFIC APPARATUS

FOR COMPUTER SOFTWARE CONTAINING LEGAL INFORMATION AND LEGAL DOCUMENTS; COMPUTER SOFTWARE FOR USE IN DOCUMENT MANAGEMENT, FOR WORD PROCESSING AND FOR DATABASE CREATION AND MANAGEMENT, ALL FOR USE IN THE FIELD OF LAW (U.S. CLS. 21, 23, 26, 36 AND 38).

CLASS 16—PAPER GOODS AND PRINTED MATTER

FOR PRINTED PUBLICATIONS, NAMELY, LEAFLETS, BROCHURES, MANUALS, BOOKS AND INSTRUCTIONAL AND TEACHING MATERIALS IN THE FORM OF MANUALS AND BOOKS ALL RELATING TO LEGAL SERVICES (U.S. CLS. 2, 5, 22, 23, 29, 37, 38 AND 50).

CLASS 35—ADVERTISING AND BUSINESS

FOR BUSINESS RESEARCH; BUSINESS INVESTIGATIONS AND INQUIRIES; BUSINESS CONSULTING SERVICES RELATING TO BUSINESS MANAGEMENT, BUSINESS ORGANIZATION, MERGERS AND ACQUISITIONS, LICENSING AND FRANCHISING; CONSULTING IN THE FIELD OF BUSINESS RESEARCH, BUSINESS INVESTIGATIONS AND INQUIRIES AND BUSINESS INSOLVENCY AND LIQUIDATION; TAX ASSESSMENT, PREPARATION AND CONSULTATION; PREPARING BUSINESS REPORTS; AND PROVIDING CORPORATE SECRETARY SERVICES TO BUSINESSES (U.S. CLS. 100, 101 AND 102).

CLASS 36—INSURANCE AND FINANCIAL

FOR FINANCIAL ANALYSIS AND CONSULTING SERVICES FOR INVESTING, ACTUARIAL AND PENSION SERVICES AND TRUSTEESHIPS; BUSINESS INSOLVENCY AND LIQUIDATION SERVICES; AND DEBT RECOVERY AND COLLECTION AGENCIES AND CONSULTATION THEREFOR (U.S. CLS. 100, 101 AND 102).

CLASS 41—EDUCATION AND ENTERTAINMENT

FOR ARRANGING AND CONDUCTING EDUCATION AND TRAINING CONFERENCES AND SEMINARS RELATING TO LAW, FINANCE AND COMMERCE (U.S. CLS. 100, 101 AND 107).

CLASS 42—SCIENTIFIC, COMPUTER AND LEGAL SERVICES

FOR LEGAL SERVICES RELATING TO BUSINESS AND TAXATION, TAX PLANNING AND TAX ASSESSMENT SERVICES AND CONSULTATION FOR THE FOREMENTIONED LEGAL SERVICES; LEGAL SERVICES; LEGAL RESEARCH AND CONSULTATION THEREFOR; INTELLECTUAL PROPERTY SERVICES, NAMELY, PATENT AND TRADEMARK AGENCIES, PATENT AND TRADEMARK MONITORING AND CONSULTATION THEREFOR; ARBITRATION, MEDIATION, CONCILIATION AND DISPUTE RESOLUTION SERVICES AND CONSULTATION THEREFOR (U.S. CLS. 100 AND 101).

SN 75-784,401. MEDIA FRONTIERS, INC., NEW YORK, NY.
FILED 8-25-1999.

MEDIA FRONTIERS

NO CLAIM IS MADE TO THE EXCLUSIVE RIGHT TO USE "MEDIA", APART FROM THE MARK AS SHOWN.

CLASS 35—ADVERTISING AND BUSINESS

FOR DEVELOPING PROMOTIONAL CAMPAIGNS FOR BUSINESS, NAMELY PUBLIC INTEREST AND NON-PROFIT ORGANIZATIONS (U.S. CLS. 100, 101 AND 102).

FIRST USE 8-3-1998; IN COMMERCE 8-3-1998.

CLASS 41—EDUCATION AND ENTERTAINMENT

FOR EDUCATION AND ENTERTAINMENT SERVICES, NAMELY PRODUCTION OF EDUCATIONAL TELEVISION PROGRAMS, DOCUMENTARY MOTION PICTURES, PROGRAMS PROVIDED VIA A GLOBAL COMPUTER NETWORK AND VIDEOTAPES FOR OTHERS, NAMELY PUBLIC INTEREST AND NON-PROFIT ORGANIZATIONS; CONDUCTING SEMINARS, WORKSHOPS, CONFERENCES AND CLASSES ON THE CREATION OF EDUCATIONAL TELEVISION PROGRAMS, DOCUMENTARY FILMS, PROGRAMS PROVIDED VIA A GLOBAL COMPUTER NETWORK AND VIDEOTAPES; PRODUCTION AND DISTRIBUTION OF DOCUMENTARY MOTION PICTURES; PROVIDING INFORMATION ABOUT FILM PRODUCTION AND THE CREATION AND DISTRIBUTION OF MEDIA PRODUCTS VIA A GLOBAL COMPUTER NETWORK (U.S. CLS. 100, 101 AND 107).

FIRST USE 8-3-1998; IN COMMERCE 8-3-1998.

CLASS 42—SCIENTIFIC, COMPUTER AND LEGAL SERVICES

FOR CONSULTING SERVICES IN THE FIELD OF FILM PRODUCTION AND DISTRIBUTION (U.S. CLS. 100 AND 101).

FIRST USE 8-3-1998; IN COMMERCE 8-3-1998.

SN 75-789,305. EDUCATIONAL MULTIMEDIA CORPORATION, WALTHAM, MA. FILED 8-31-1999.



NO CLAIM IS MADE TO THE EXCLUSIVE RIGHT TO USE "EDUCATIONAL MULTIMEDIA CORPORATION", APART FROM THE MARK AS SHOWN.

CLASS 9—ELECTRICAL AND SCIENTIFIC APPARATUS

FOR COMPUTER SOFTWARE FOR USE IN EVALUATING A STUDENT'S LEVEL OF EXPERTISE ON COMPUTER AND BUSINESS RELATED SUBJECTS IN ORDER TO DEVELOP CUSTOMIZED CURRICULUM FOR THE STUDENT, SOFTWARE FOR HUMAN RESOURCES EMPLOYEE SKILL ASSESSMENT, AND SOFTWARE FOR TRAINING ON A VARIETY OF BUSINESS SUBJECTS (U.S. CLS. 21, 23, 26, 36 AND 38).

FIRST USE 12-1-1998; IN COMMERCE 12-1-1998.

CLASS 41—EDUCATION AND ENTERTAINMENT

FOR EDUCATIONAL SERVICES, NAMELY, CONDUCTING ONLINE INTERACTIVE CLASSES, SEMINARS, AND WORKSHOPS IN THE FIELDS OF INFORMATION TECHNOLOGY AND A VARIETY OF BUSINESS SUBJECTS, NAMELY, BUSINESS ADMINISTRATION, BUSINESS MARKETING, BUSINESS PLANNING, AND BUSINESS CONSULTATION, AND PROVIDING MULTIMEDIA COURSE MATERIALS IN CONNECTION THEREWITH FOR TRAINING PURPOSES (U.S. CLS. 100, 101 AND 107).

FIRST USE 12-1-1998; IN COMMERCE 12-1-1998.

SN 75-792,444. HONEYBAR PRODUCTS INTERNATIONAL INC., NEPEAN, ONTARIO, FILED 9-3-1999.



NO CLAIM IS MADE TO THE EXCLUSIVE RIGHT TO USE "PRODUCTS INTERNATIONAL INC.", APART FROM THE MARK AS SHOWN.

CLASS 29—MEATS AND PROCESSED FOODS

FOR NUT-BASED AND FRUIT-BASED SNACK FOOD MADE FROM NATURAL INGREDIENTS CONTAINING ANY OF THE FOLLOWING: PEANUTS, ALMONDS, RAISINS, SESAME SEEDS, SUNFLOWER SEEDS, PUMPKIN SEEDS, HEMP SEEDS, FLAX, COCONUT, MOLASSES, BANANAS, APRICOTS, PINEAPPLE AND PAPAYA (U.S. CL. 46).

FIRST USE 2-7-1998; IN COMMERCE 2-7-1998.

CLASS 30—STAPLE FOODS

FOR RICE-BASED AND OAT-BASED SNACK FOOD MADE FROM NATURAL INGREDIENTS (U.S. CL. 46).

FIRST USE 2-7-1998; IN COMMERCE 2-7-1998.

SN 75-795,579. IMYOURMUSIC.COM, INC., EDISON, NJ. BY ASSIGNMENT VENTRESCA, EDWARD, CRANFORD, NJ. FILED 10-5-1999.

IMYOURRADIO

CLASS 35—ADVERTISING AND BUSINESS

FOR ADVERTISING SERVICES, NAMELY, DISTRIBUTING ADVERTISEMENTS FOR OTHERS IN CONNECTION WITH DIGITAL PROGRAMMING OVER A GLOBAL COMPUTER NETWORK (U.S. CLS. 100, 101 AND 102).

CLASS 38—COMMUNICATION

FOR COMMUNICATION SERVICES, NAMELY, PROVIDING FOR TRANSMISSION OF DIGITIZED AUDIO AND VIDEO SIGNALS FOR SPORTS, TRAFFIC, RADIO, TELEVISION, ENTERTAINMENT, BUSINESS AND MUSIC EVENTS AND TALK SHOWS OVER A GLOBAL COMPUTER NETWORK (U.S. CLS. 100, 101 AND 104).

CLASS 41—EDUCATION AND ENTERTAINMENT

FOR ENTERTAINMENT SERVICES, NAMELY PROVIDING THE DISTRIBUTION OF DIGITAL PROGRAMMING FOR OTHERS FOR SPORTS, RADIO, TELEVISION, ENTERTAINMENT, CORPORATE, BUSINESS AND MUSIC EVENTS AND TALK SHOWS IN DIGITIZED AUDIO AND VIDEO SIGNAL FORM OVER A GLOBAL COMPUTER NETWORK (U.S. CLS. 100, 101 AND 107).

SN 75-802,942. AL SAFA HALAL LTD., SILVER SPRING, MD. FILED 9-20-1999.



NO CLAIM IS MADE TO THE EXCLUSIVE RIGHT TO USE "HALAL" AND THE ARABIC CHARACTERS THAT TRANSLITERATE AS "HALAL", APART FROM THE MARK AS SHOWN.

THE TRANSLITERATION OF THE ARABIC CHARACTERS IN "HALAL" WHICH MEANS "IN ACCORDANCE WITH ARABIC DIETARY LAWS".

CLASS 29—MEATS AND PROCESSED FOODS

FOR ALL HALAL MEAT PRODUCTS, NAMELY, BEEF, POULTRY, LAMB, VEAL, GOAT, MUTTON AND OTHER HALAL SPECIAL MEATS; ALL HALAL PREPARED PROCESSED MEAT PRODUCTS, NAMELY, DELI, SLICED MEATS, WEINERS AND SAUSAGE; HALAL PREPARED SEAFOOD PRODUCTS, NAMELY, BREADED FISH; HALAL PREPARED FALAFEL MIX (U.S. CL. 46).

FIRST USE 7-0-1999; IN COMMERCE 7-0-1999.

CLASS 30—STAPLE FOODS

FOR HALAL PREPARED FROZEN FOODS, NAMELY, PIZZAS (U.S. CL. 46).

FIRST USE 7-0-1999; IN COMMERCE 7-0-1999.

SN 75-807,213. BAY, BRICE J., GREENVILLE, SC. FILED 9-23-1999.

CONSUMER'S10BEST.COM

CLASS 35—ADVERTISING AND BUSINESS

FOR DISSEMINATION OF ADVERTISING FOR OTHERS VIA AN ONLINE ELECTRONIC COMMUNICATIONS NETWORK (U.S. CLS. 100, 101 AND 102).

CLASS 42—SCIENTIFIC, COMPUTER AND LEGAL SERVICES

FOR PROVIDING ONLINE INFORMATION, NAMELY, RANKED AND UNRANKED LISTS OF VARIOUS GOODS AND SERVICES, TRANSMITTED THROUGH A GLOBAL COMPUTER NETWORK (U.S. CLS. 100 AND 101).

SN 75-821,716. TRES PIEDRAS, L.L.C., TUCSON, AZ. FILED 10-13-1999.

NUESTROLOSANGELES.COM

THE FOREIGN WORDING IN THE MARK TRANSLATES INTO ENGLISH AS "OUR LOS ANGELES".

CLASS 35—ADVERTISING AND BUSINESS

FOR COMPUTER SERVICES, NAMELY, PROVIDING ON-LINE DATABASES FEATURING TRADE AND BUSINESS INFORMATION WITH SPECIAL ATTENTION TO THE HISPANIC COMMUNITY; DISSEMINATION OF ADVERTISING FOR OTHERS VIA GLOBAL COMPUTER NETWORKS; AND COMPUTER SERVICES, NAMELY, ON-LINE RETAILING IN THE FIELDS OF FOOD, HEALTH PRODUCTS, HOME FASHION, APPAREL, SPORTS EQUIPMENT, BOOKS, VIDEOS AND TAPES, AND LUGGAGE (U.S. CLS. 100, 101 AND 102).

CLASS 41—EDUCATION AND ENTERTAINMENT

FOR COMPUTER SERVICES, NAMELY, PROVIDING ON-LINE DATABASES FEATURING INFORMATION ON SPORTS, ENTERTAINMENT, GENERAL AND LOCAL NEWS, AND EDUCATION, WITH SPECIAL ATTENTION TO THE HISPANIC COMMUNITY (U.S. CLS. 100, 101 AND 107).

CLASS 42—SCIENTIFIC, COMPUTER AND LEGAL SERVICES

FOR COMPUTER SERVICES, NAMELY, PROVIDING ON-LINE DATABASES FEATURING INFORMATION ON SERVICES RELATING TO HEALTH AND MEDICINE, FASHION, FOOD AND RESTAURANTS, AND SEARCH ENGINES FOR LOCATING INFORMATION, RESOURCES AND WEBSITES OF OTHERS ON A GLOBAL COMPUTER NETWORK ON A WIDE RANGE OF GENERAL INFORMATION OF INTEREST WITH SPECIAL ATTENTION TO THE HISPANIC COMMUNITY (U.S. CLS. 100 AND 101).

SN 75-823,701. PAN PA' YA LTDA., SANTAFE DE BOGOTA, D.C. COLOMBIA, FILED 10-15-1999.



NO CLAIM IS MADE TO THE EXCLUSIVE RIGHT TO USE "PAN", APART FROM THE MARK AS SHOWN.

THE ENGLISH TRANSLATION OF THE SPANISH (COLOMBIAN) SLANG "PAN PA' YA" IS "BREAD FOR NOW".

CLASS 29—MEATS AND PROCESSED FOODS

FOR FOOD PRODUCTS, NAMELY, MILK, CHEESE IN GENERAL, YOGURT, BUTTER, EGGS (U.S. CL. 46).

CLASS 30—STAPLE FOODS

FOR BREAD, CAKES, PIZZA, CRACKERS, BROWNIES, COFFEE, FLAVORED SWEETENED GELATIN DESSERTS, AND TAMALES (U.S. CL. 46).

SN 75-827,529. RIGHT BRAIN TRUST, LLC, THE, COLORADO SPRINGS, CO. FILED 10-20-1999.



SN 75-824,241. IDIOM TECHNOLOGIES, INC., CAMBRIDGE, MA. FILED 10-15-1999.

IDIOM

NO CLAIM IS MADE TO THE EXCLUSIVE RIGHT TO USE "SENIOR CHANNEL", APART FROM THE MARK AS SHOWN.

CLASS 38—COMMUNICATION

FOR TELEVISION, CABLE TELEVISION AND RADIO BROADCASTING SERVICES (U.S. CLS. 100, 101 AND 104).

CLASS 9—ELECTRICAL AND SCIENTIFIC APPARATUS

FOR SOFTWARE TO ALLOW WEBSITES TO FUNCTION IN MULTIPLE FOREIGN LANGUAGES (U.S. CLS. 21, 23, 26, 36 AND 38).

FIRST USE 7-0-1998; IN COMMERCE 7-0-1998.

CLASS 41—EDUCATION AND ENTERTAINMENT

FOR PRODUCTION OF TELEVISION, CABLE TELEVISION AND RADIO PROGRAMMING; SYNDICATION OF TELEVISION, CABLE TELEVISION, AND RADIO PROGRAMS (U.S. CLS. 100, 101 AND 107).

CLASS 35—ADVERTISING AND BUSINESS

FOR BUSINESS CONSULTATION IN THE FIELD OF CONDUCTING ON-LINE BUSINESS IN FOREIGN COUNTRIES (U.S. CLS. 100, 101 AND 102).

FIRST USE 7-0-1998; IN COMMERCE 7-0-1998.

SN 75-827,532. RIGHT BRAIN TRUST, LLC, THE, COLORADO SPRINGS, CO. FILED 10-20-1999.

SN 75-826,045. AMFM OPERATING INC., AUSTIN, TX. BY MERGER CHANCELLOR MEDIA CORPORATION OF LOS ANGELES, DALLAS, TX. FILED 10-5-1999.



OWNER OF U.S. REG. NO. 1,622,902.
THE LINING IS FOR SHADING PURPOSES ONLY AND DOES NOT INDICATE COLOR.

CLASS 38—COMMUNICATION

FOR RADIO BROADCASTING SERVICES (U.S. CLS. 100, 101 AND 104).

FIRST USE 12-30-1946; IN COMMERCE 12-30-1946.

CLASS 38—COMMUNICATION

FOR TELEVISION, CABLE TELEVISION AND RADIO BROADCASTING SERVICES (U.S. CLS. 100, 101 AND 104).

CLASS 41—EDUCATION AND ENTERTAINMENT

FOR RADIO PROGRAMMING SERVICES (U.S. CLS. 100, 101 AND 107).

FIRST USE 12-30-1946; IN COMMERCE 12-30-1946.

CLASS 41—EDUCATION AND ENTERTAINMENT

FOR PRODUCTION OF TELEVISION, CABLE TELEVISION AND RADIO PROGRAMMING; SYNDICATION OF TELEVISION, CABLE TELEVISION, AND RADIO PROGRAMS (U.S. CLS. 100, 101 AND 107).



SN 75-827,749. JORE CORPORATION, RONAN, MT. FILED 10-14-1999.

MASTER CHUCK

NO CLAIM IS MADE TO THE EXCLUSIVE RIGHT TO USE "CHUCK", APART FROM THE MARK AS SHOWN.

CLASS 7—MACHINERY

FOR POWER TOOL ACCESSORIES, NAMELY, DRILL BITS, SPADE BITS, MASONRY BITS, SCREW DRIVER BITS, SCREW GUIDES, MAGNETIC DRIVE GUIDES, DRILL AND DRIVERS AND SURFACE PREPARATION DISKS (U.S. CLS. 13, 19, 21, 23, 31, 34 AND 35).
FIRST USE 7-21-1999; IN COMMERCE 7-21-1999.

CLASS 8—HAND TOOLS

FOR HAND TOOLS, NAMELY, SOCKET AND BIT DRIVERS (U.S. CLS. 23, 28 AND 44).
FIRST USE 7-21-1999; IN COMMERCE 7-21-1999.

SN 75-828,727. GUARDIAN ANGEL HOLDINGS, INC., SAN FRANCISCO, CA. FILED 10-22-1999.

GUARDIAN ANGEL

CLASS 9—ELECTRICAL AND SCIENTIFIC APPARATUS

FOR PORTABLE CHEMICAL-BASED APPARATUS FOR MEASURING PERSONAL ALCOHOL CONSUMPTION LEVELS USING BIOLOGICAL FLUID SAMPLES (U.S. CLS. 21, 23, 26, 36 AND 38).

CLASS 35—ADVERTISING AND BUSINESS

FOR BUSINESS CONSULTATION SERVICES FOR INSURANCE COMPANIES; BUSINESS CONSULTATION SERVICES IN FIELD OF ALCOHOL CONSUMPTION (U.S. CLS. 100, 101 AND 102).

SN 75-837,179. SAMSONITE CORPORATION, DENVER, CO. FILED 11-1-1999.

HAVE KID WILL TRAVEL

CLASS 16—PAPER GOODS AND PRINTED MATTER

FOR LITTER BAGS (U.S. CLS. 2, 5, 22, 23, 29, 37, 38 AND 50).

CLASS 18—LEATHER GOODS

FOR LUGGAGE, LUGGAGE STRAPS, LUGGAGE TAGS, BACKPACKS, ATTACHE CASES, BRIEFCASES, TRAVELING BAGS, DUFFEL BAGS, MONEY HOLDERS, WALLETS, WAIST PACKS, TOILETRY KITS SOLD EMPTY, TOILETRY CASES SOLD EMPTY, ALL PURPOSE ATHLETIC BAGS, GARMENT BAGS FOR TRAVEL, UMBRELLAS, GAME BAGS, BABY BACKPACKS, BABY CARRIERS WORN ON THE BODY, DIAPER BAGS, AUTOMOBILE CONSOLE ORGANIZERS, CUP HOLDERS, AUTOMOBILE SEAT BACK ORGANIZERS (U.S. CLS. 1, 2, 3, 22 AND 41).

CLASS 20—FURNITURE AND ARTICLES NOT OTHERWISE CLASSIFIED

FOR WINDOW SHADES FOR CARS (U.S. CLS. 2, 13, 22, 25, 32 AND 50).

CLASS 28—TOYS AND SPORTING GOODS

FOR CHILDREN'S GAMES DESIGNED FOR TRAVEL (U.S. CLS. 22, 23, 38 AND 50).

CLASS 35—ADVERTISING AND BUSINESS

FOR RETAIL STORE SERVICES IN THE FIELD OF CHILDREN'S TRAVEL EQUIPMENT (U.S. CLS. 100, 101 AND 102).

CLASS 39—TRANSPORTATION AND STORAGE

FOR TRAVEL INFORMATION SERVICES; TRAVEL AGENCY SERVICES, NAMELY, MAKING RESERVATIONS AND BOOKINGS FOR TRANSPORTATION (U.S. CLS. 100 AND 105).

SN 75-842,782. FTH, INC., FELS POINT, MD. FILED 11-8-1999.



THE DESIGN IS OF A CRAB WEARING A SAILOR'S HAT, HAVING AN EYE-PATCH SMOKING A PIPE, AND HAVING A GOATEE.

CLASS 25—CLOTHING

FOR CLOTHING, NAMELY, T-SHIRTS, SWEAT-SHIRTS, SHORTS, AND HEADWEAR FOR ADULTS AND CHILDREN (U.S. CLS. 22 AND 39).
FIRST USE 11-0-1998; IN COMMERCE 11-0-1998.

CLASS 29—MEATS AND PROCESSED FOODS

FOR JAMS, JELLIES, FRUIT SAUCES, PROCESSED EDIBLE NUTS, AND PROCESSED EDIBLE SEEDS (U.S. CL. 46).
FIRST USE 11-0-1998; IN COMMERCE 11-0-1998.

CLASS 30—STAPLE FOODS

FOR COFFEES, CANDIES, HOT SAUCES, FRUIT SALSAS, AND SALSAS (U.S. CL. 46).
FIRST USE 11-0-1998; IN COMMERCE 11-0-1998.

CLASS 35—ADVERTISING AND BUSINESS

FOR RETAIL STORE SERVICES FEATURING OCEAN AND BAY THEMED MERCHANDISE, LOCALLY PRODUCED FOOD PRODUCTS, CLOTHING, SOUVENIRS, AND NOVELTY ITEMS (U.S. CLS. 100, 101 AND 102).
FIRST USE 11-0-1998; IN COMMERCE 11-0-1998.

CLASS 42—SCIENTIFIC, COMPUTER AND LEGAL SERVICES

FOR RESTAURANTS (U.S. CLS. 100 AND 101).
FIRST USE 11-0-1998; IN COMMERCE 11-0-1998.

SN 75-844,427. KORES CE GMBH, 1190 WIEN, AUSTRIA,
FILED 11-10-1999.

KORES

PRIORITY CLAIMED UNDER SEC. 44(D) ON AUSTRIA
APPLICATION NO. AM3801/99, FILED 6-25-1999.

CLASS 2—PAINTS

FOR FILLED INK JET CARTRIDGES AND TONER
CARTRIDGES (U.S. CLS. 6, 11 AND 16).

CLASS 16—PAPER GOODS AND PRINTED MATTER

FOR CARBON PAPER; COATED PAPER FOR PRINTING AND COPYING AND FOR FACSIMILE MACHINES; CARD FILES; CARDBOARD CONTAINERS, FILE FOLDERS AND FILE JACKETS; PLASTIC WRAP; WRAPPING PAPER AND PAPER GIFT-WRAPPING RIBBONS; STATIONERY, WRITING UTENSILS; ADHESIVES AND SELF-ADHESIVE PRODUCTS FOR STATIONERY AND HOUSEHOLD PURPOSES, NAMELY, ADHESIVE NOTE PADS, REMOVABLE SELF-STICK NOTES, SELF-ADHESIVE LABELS, SELF-ADHESIVE BOOK COVERS, AND SELF-ADHESIVE TAPES; DESK-TOP DISPENSERS FOR SELF-ADHESIVE TAPES; GLUE STICKS FOR STATIONERY AND HOUSEHOLD PURPOSES; HOLDERS FOR DESK ACCESSORIES; FOUNTAIN PEN INK; INK FOR DRAWING UTENSILS AND STAMP PADS; FLUIDS, TABS, PENS AND STICKS FOR CORRECTING TYPING ERRORS AND PRINT ERRORS; ROLL-ON CORRECTORS FOR TYPE AND PRINT; OFFICE REQUISITES, NAMELY, CORRECTING FILM, PENCILS AND TAPE FOR TYPE, STAPLERS, PAPER HOLE PUNCHERS, TYPEWRITER RIBBONS, TYPEWRITER CORRECTION RIBBONS, TYPEWRITER CORRECTION RIBBONS, TYPEWRITER AND COMPUTER INK RIBBONS, TYPEWRITER AND COMPUTER INK RIBBON CASSETTES; PAPER FOR INKJET PRINTERS, RUBBER STAMPS, STAMP INK PADS, PAPER CLIPS, AND STAPLES; HIGH RESOLUTION PAPER FOR COLOR INK JET PRINTERS; PLASTIC TRANSPARENCIES FOR INK JET PRINTERS (U.S. CLS. 2, 5, 22, 23, 29, 37, 38 AND 50).

SN 75-845,234. TIMESYS CORPORATION, PITTSBURGH,
PA. FILED 11-30-1999.

REAL-TIME... REAL SOLUTIONS.**CLASS 9—ELECTRICAL AND SCIENTIFIC APPARATUS**

FOR COMPUTER SOFTWARE, NAMELY OPERATING SYSTEM SOFTWARE, MIDDLEWARE SOFTWARE THAT INTEGRATES MULTIPLE SOFTWARE APPLICATIONS WITH EMBEDDED CONSTRAINTS, END-TO-END QUALITY OF SERVICE SUPPORT OR HIGH AVAILABILITY REQUIREMENTS, DEVELOPMENT SOFTWARE, AND DEBUGGING SOFTWARE FOR USE IN THE FIELDS OF REAL TIME SOFTWARE AND EMBEDDED SOFTWARE (U.S. CLS. 21, 23, 26, 36 AND 38).

FIRST USE 6-1-1997; IN COMMERCE 6-1-1997.

CLASS 41—EDUCATION AND ENTERTAINMENT

FOR EDUCATIONAL AND TRAINING SERVICES, NAMELY PROVIDING TRAINING AND EDUCATIONAL SEMINARS IN THE FIELDS OF REAL TIME SOFTWARE AND EMBEDDED SOFTWARE (U.S. CLS. 100, 101 AND 107).

FIRST USE 6-1-1997; IN COMMERCE 6-1-1997.

CLASS 42—SCIENTIFIC, COMPUTER AND LEGAL SERVICES

FOR SOFTWARE ENGINEERING AND COMPUTER SOFTWARE DESIGN SERVICES FOR OTHERS IN THE FIELDS OF REAL TIME SOFTWARE AND EMBEDDED SOFTWARE (U.S. CLS. 100 AND 101).

FIRST USE 6-1-1997; IN COMMERCE 6-1-1997.

SN 75-845,508. SD TELECOMMUNICATIONS, INC., SIMON BLITZ FLUSHING, NY. FILED 12-2-1999.

VIRGIN WIRELESS

NO CLAIM IS MADE TO THE EXCLUSIVE RIGHT TO USE "WIRELESS", APART FROM THE MARK AS SHOWN.

CLASS 35—ADVERTISING AND BUSINESS

FOR RETAIL STORE SERVICES FEATURING WIRED AND WIRELESS COMMUNICATION PHONES, VIDEO AND AUDIO INSTRUMENTS, APPLIANCES AND ACCESSORIES; ON-LINE RETAIL STORE SERVICES FEATURING WIRED AND WIRELESS COMMUNICATION PHONES, VIDEO AND AUDIO INSTRUMENTS (U.S. CLS. 100, 101 AND 102).

CLASS 38—COMMUNICATION

FOR TELECOMMUNICATION SERVICES, NAMELY, PERSONAL COMMUNICATION SERVICES, ISDN SERVICES, NETWORK, SUB-NETWORK AND INTRANETWORK COMMUNICATION SERVICES FEATURING HIGH SPEED WIDE BAND DSL FOR BUSINESS TO BUSINESS USE, AND VIDEO COMMUNICATION SERVICES FEATURING VIDEO CONFERENCING AND VIDEO MONITORING SERVICES OVER LOCAL AREA NETWORKS AND A GLOBAL COMPUTER NETWORK; TELEPHONE COMMUNICATION SERVICES; WIRELESS COMMUNICATION SERVICES NAMELY CELLULAR TELEPHONE SERVICES, DATA TRANSMISSION SERVICES, AND PAGING SERVICES; PROVIDING TELECOMMUNICATIONS CONNECTIONS TO A GLOBAL COMPUTER NETWORK (U.S. CLS. 100, 101 AND 104).

SN 75-845,511. SD TELECOMMUNICATIONS, INC., SIMON BLITZ FLUSHING, NY. FILED 12-2-1999.

VIRGIN MOBILE

NO CLAIM IS MADE TO THE EXCLUSIVE RIGHT TO USE "MOBILE", APART FROM THE MARK AS SHOWN.

CLASS 35—ADVERTISING AND BUSINESS

FOR RETAIL STORE SERVICES FEATURING WIRED AND WIRELESS COMMUNICATION PHONES, VIDEO AND AUDIO INSTRUMENTS, APPLIANCES AND ACCESSORIES; ON-LINE RETAIL STORE SERVICES FEATURING WIRED AND WIRELESS COMMUNICATION PHONES, VIDEO AND AUDIO INSTRUMENTS (U.S. CLS. 100, 101 AND 102).

CLASS 38—COMMUNICATION

FOR TELECOMMUNICATION SERVICES, NAMELY, PERSONAL COMMUNICATION SERVICES, ISDN SERVICES, NETWORK, SUB-NETWORK AND INTRANETWORK COMMUNICATION SERVICES FEATURING HIGH SPEED WIDE BAND DSL FOR BUSINESS TO BUSINESS USE, AND VIDEO COMMUNICATION SERVICES FEATURING VIDEO CONFERENCING AND VIDEO MONITORING SERVICES OVER LOCAL AREA NETWORKS AND A GLOBAL COMPUTER NETWORK; TELEPHONE COMMUNICATION SERVICES; WIRELESS COMMUNICATION SERVICES NAMELY CELLULAR TELEPHONE SERVICES, DATA TRANSMISSION SERVICES, AND PAGING SERVICES; PROVIDING TELECOMMUNICATIONS CONNECTIONS TO A GLOBAL COMPUTER NETWORK (U.S. CLS. 100, 101 AND 104).

SN 75-847,091. FINKEL, BRIAN JOSEPH, DBA ADVANCED SOLUTIONS GROUP, READING, PA. FILED 11-12-1999.

MINDCIRCLE**CLASS 9—ELECTRICAL AND SCIENTIFIC APPARATUS**

FOR COMPUTER SOFTWARE USED FOR ESTABLISHING COMMUNICATIONS AMONG AND CONNECTING USERS OF A NETWORK, TRANSMITTING AND RECEIVING ELECTRONIC MAIL AND MESSAGES, MAINTAINING AND PROVIDING ACCESS TO A DIRECTORY OF SERVICES SUBSCRIBERS, AND MANAGING AND PROVIDING ACCESS TO A DATABASE OF REFERENCE MATERIALS (U.S. CLS. 21, 23, 26, 36 AND 38).

FIRST USE 6-4-1999; IN COMMERCE 6-4-1999.

CLASS 38—COMMUNICATION

FOR PROVIDING ON-LINE COMMUNICATIONS SERVICES, NAMELY, ELECTRONIC BULLETIN BOARDS, CHAT ROOMS, AND ELECTRONIC MAIL, FOR TRANSMISSION OF MESSAGES AMONG USERS CONCERNING ALL AREAS OF INTEREST (U.S. CLS. 100, 101 AND 104).

FIRST USE 6-4-1999; IN COMMERCE 6-4-1999.

SN 75-848,788. PALMEDICA, INC., READING, MA. FILED 11-15-1999.

PHARMHAND**CLASS 9—ELECTRICAL AND SCIENTIFIC APPARATUS**

FOR COMPUTER SOFTWARE FOR USE IN PROVIDING FORMULARY AND PROVIDER DATA ON PRESCRIPTION MEDICATIONS, AND PERFORMING ANALYSES AND GENERATING REPORTS ON SUCH DATA, FOR USE ON HANDHELD COMPUTERS; DOWNLOADABLE SOFTWARE FOR PROVIDING FORMULARY AND PROVIDER DATA ON PRESCRIPTION MEDICATIONS, AND PERFORMING ANALYSES AND GENERATING REPORTS ON SUCH DATA, FOR USE ON HANDHELD COMPUTERS (U.S. CLS. 21, 23, 26, 36 AND 38).

CLASS 42—SCIENTIFIC, COMPUTER AND LEGAL SERVICES

FOR PROVIDING TEMPORARY USE OF ON-LINE NON-DOWNLOADABLE SOFTWARE FOR PROVIDING FORMULARY AND PROVIDER DATA ON PRESCRIPTION MEDICATIONS, AND PERFORMING ANALYSES AND GENERATING REPORTS ON SUCH DATA, FOR USE ON HANDHELD COMPUTERS (U.S. CLS. 100 AND 101).

SN 75-849,524. ADVANCED INTEGRATED SOLUTIONS, INC., LOS ALAMITOS, CA. FILED 11-17-1999.

**CLASS 41—EDUCATION AND ENTERTAINMENT**

FOR TRAINING IN THE USE OF COMPUTER NETWORKS AND COMPUTER ADMINISTRATION SYSTEMS (U.S. CLS. 100, 101 AND 107).

FIRST USE 3-0-1998; IN COMMERCE 3-0-1998.

CLASS 42—SCIENTIFIC, COMPUTER AND LEGAL SERVICES

FOR COMPUTER SERVICES, NAMELY, DESIGNING, IMPLEMENTING AND MAINTAINING COMPUTER NETWORKS AND SOFTWARE FOR OTHERS; INTEGRATION OF COMPUTER SYSTEMS AND NETWORKS; TECHNICAL SUPPORT SERVICES, NAMELY, PROVIDING SOFTWARE, HARDWARE, EQUIPMENT AND INTEGRATION SUPPORT SERVICES VIA TELEPHONE, E-MAIL, DOCUMENTATION, AND IN PERSON (U.S. CLS. 100 AND 101).

FIRST USE 3-0-1998; IN COMMERCE 3-0-1998.

SN 75-851,854. SMARTAXIS B.V., 1012 GL AMSTERDAM, NETHERLANDS, FILED 11-17-1999.

THE E-WAY TO PAY**CLASS 9—ELECTRICAL AND SCIENTIFIC APPARATUS**

FOR COMPUTER SOFTWARE IN THE FIELD OF ELECTRONIC FINANCIAL TRANSFERS AND COMMERCIAL PAYMENTS AND TRANSACTIONS FOR USE IN DATABASE MANAGEMENT (U.S. CLS. 21, 23, 26, 36 AND 38).

CLASS 35—ADVERTISING AND BUSINESS

FOR BUSINESS INFORMATION CONCERNING PAYMENTS BY THIRD PARTIES (U.S. CLS. 100, 101 AND 102).

CLASS 36—INSURANCE AND FINANCIAL

FOR TRANSFER OF PAYMENTS, NAMELY, ELECTRONIC FUNDS TRANSFER (U.S. CLS. 100, 101 AND 102).

SN 75-855,979. AVENTIS RESEARCH & TECHNOLOGIES GMBH & CO. KG, D-65926 FRANKFURT AM MAIN, FED REP GERMANY, FILED 11-22-1999.

AXIVA

OWNER OF FED REP GERMANY REG. NO. 39915810.3, DATED 5-6-1999, EXPIRES 3-31-2009.

CLASS 35—ADVERTISING AND BUSINESS

FOR BUSINESS MANAGEMENT CONSULTATION (U.S. CLS. 100, 101 AND 102).

CLASS 42—SCIENTIFIC, COMPUTER AND LEGAL SERVICES

FOR CONSULTING SERVICES IN THE DEVELOPMENT AND OPTIMIZATION OF PRODUCTION PROCESSES IN THE FIELDS OF BIOLOGY, INDUSTRIAL CHEMISTRY AND PHYSICS; SCIENTIFIC PROJECT STUDIES IN THE FIELDS OF BIOLOGY, INDUSTRIAL CHEMISTRY AND PHYSICS; CONSULTING SERVICES IN THE DEVELOPMENT AND CONSTRUCTION OF PRODUCTION FACILITIES (U.S. CLS. 100 AND 101).

SN 75-857,895. BARBOUR INTERNATIONAL, INC., BRANDON, MS. FILED 11-26-1999.

BAYOU BUDDY

CLASS 11—ENVIRONMENTAL CONTROL APPARATUS

FOR PORTABLE OUTDOOR FOOD COOKER FIRED BY CHARCOAL, GAS, OR OTHER COMBUSTIBLE FUEL SOURCES USED FOR GRILLING, STEAMING, BOILING AND DEEP FRYING (U.S. CLS. 13, 21, 23, 31 AND 34).
FIRST USE 8-1-1999; IN COMMERCE 8-1-1999.

CLASS 21—HOUSEWARES AND GLASS

FOR COOKWARE, NAMELY A PORTABLE NON-ELECTRIC FOOD COOKER FOR GRILLING, STEAMING, BOILING AND DEEP FRYING (U.S. CLS. 2, 13, 23, 29, 30, 33, 40 AND 50).
FIRST USE 8-1-1999; IN COMMERCE 8-1-1999.

SN 75-858,271. SUPERFUTURE CORPORATION, MINATOKU TOKYO, JAPAN, FILED 11-26-1999.

SUPERFUTURE

CLASS 16—PAPER GOODS AND PRINTED MATTER

FOR PRINTED TRAVEL GUIDES AND BOOKS (U.S. CLS. 2, 5, 22, 23, 29, 37, 38 AND 50).
FIRST USE 2-0-1999; IN COMMERCE 2-0-1999.

CLASS 39—TRANSPORTATION AND STORAGE

FOR TRAVEL GUIDE INFORMATION SERVICES VIA GLOBAL COMPUTER NETWORKS AND WIRELESS TELECOMMUNICATION DEVICES (U.S. CLS. 100 AND 105).
FIRST USE 2-0-1999; IN COMMERCE 2-0-1999.

CLASS 42—SCIENTIFIC, COMPUTER AND LEGAL SERVICES

FOR GRAPHIC ART DESIGN AND CONSULTATION, DESIGN FOR OTHERS IN THE FIELD OF COMPUTERS, COMPUTER SERVICES, NAMELY DESIGNING AND IMPLEMENTING NETWORK WEB PAGES FOR OTHERS, COMPUTER CONSULTATION, INDUSTRIAL DESIGN AND CONSULTATION (U.S. CLS. 100 AND 101).

FIRST USE 2-0-1999; IN COMMERCE 2-0-1999.

SN 75-858,864. BARBOUR INTERNATIONAL, INC., BRANDON, MS. FILED 11-26-1999.

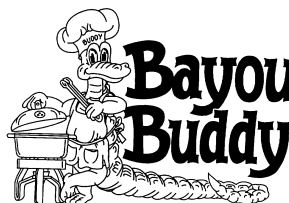

CLASS 11—ENVIRONMENTAL CONTROL APPARATUS

FOR PORTABLE OUTDOOR FOOD COOKER FIRED BY CHARCOAL, GAS, OR OTHER COMBUSTIBLE FUEL SOURCES USED FOR GRILLING, STEAMING, BOILING AND DEEP FRYING (U.S. CLS. 13, 21, 23, 31 AND 34).
FIRST USE 8-1-1999; IN COMMERCE 8-1-1999.

CLASS 21—HOUSEWARES AND GLASS

FOR COOKWARE, NAMELY A PORTABLE NON-ELECTRIC FOOD COOKER FOR GRILLING, STEAMING, BOILING AND DEEP FRYING (U.S. CLS. 2, 13, 23, 29, 30, 33, 40 AND 50).
FIRST USE 8-1-1999; IN COMMERCE 8-1-1999.

SN 75-861,527. KVAERNER E & C UK LIMITED, WHITELY HAMPSHIRE PO15 7AY, UNITED KINGDOM, BY CHANGE OF NAME KVAERNER PROCESS UK LIMITED, HAMPSHIRE PO15 7AY, UNITED KINGDOM, FILED 12-1-1999.

ECXTRA

OWNER OF UNITED KINGDOM REG. NO. 2215830, DATED 11-30-1999, EXPIRES 11-30-2009.

CLASS 39—TRANSPORTATION AND STORAGE

FOR ELECTRONIC STORAGE OF DOCUMENTS, ALL IN THE FIELD OF ENGINEERING AND CONSTRUCTION (U.S. CLS. 100 AND 105).

CLASS 42—SCIENTIFIC, COMPUTER AND LEGAL SERVICES

FOR PROVIDING AN ON-LINE COMPUTER DATABASE IN THE FIELD OF ENGINEERING (U.S. CLS. 100 AND 101).

SN 75-861,621. MELBOURNE IT LTD., MELBOURNE, VICTORIA 3000, AUSTRALIA, FILED 12-1-1999.

INWW

PRIORITY CLAIMED UNDER SEC. 44(D) ON AUSTRALIA APPLICATION NO. 799139, FILED 7-1-1999, REG. NO. 799139, DATED 7-1-1999, EXPIRES 7-1-2009.

CLASS 9—ELECTRICAL AND SCIENTIFIC APPARATUS

FOR COMPUTER HARDWARE AND SOFTWARE, NAMELY, CUSTOMIZED SOFTWARE AND HARDWARE TO ENABLE CONNECTIONS TO DATABASES AND PUBLICATIONS IN ELECTRONIC FORM SUPPLIED ON-LINE FROM COMPUTER DATABASES OR FROM FACILITIES PROVIDED BY A GLOBAL COMPUTER NETWORK; COMPUTER SOFTWARE AND HARDWARE WHICH ENABLES THE SEARCHING OF DATA; COMPUTER HARDWARE AND SOFTWARE, NAMELY, HARDWARE AND SOFTWARE FOR DIGITAL CERTIFICATION SYSTEMS USED ON COMPUTERS (U.S. CLS. 21, 23, 26, 36 AND 38).

CLASS 35—ADVERTISING AND BUSINESS

FOR BUSINESS SERVICES, NAMELY, PROVIDING COMMERCIAL INFORMATION AND DIRECTORY SERVICES FEATURING DIRECTORIES FOR LOCATING COMPUTER NETWORK ADDRESSES AND DEMOGRAPHIC INFORMATION OF ENTITIES; BUSINESS SERVICES, NAMELY, PROVIDING AN ONLINE DIRECTORY OF BUSINESS ORGANIZATIONS, INDIVIDUALS, ADDRESSES AND RESOURCES; BUSINESS CONSULTANCY AND ADMINISTRATION SERVICES IN THE FIELD OF DOMAIN NAMES, DATABASE AND DIRECTORIES MANAGEMENT; PROVIDING A DIRECTORY OF ORGANIZATIONS, INDIVIDUALS, ADDRESSES AND RESOURCES ACCESSIBLE THROUGH THE USE OF A GLOBAL COMPUTER NETWORK (U.S. CLS. 100, 101 AND 102).

CLASS 42—SCIENTIFIC, COMPUTER AND LEGAL SERVICES

FOR REGISTRATION OF DOMAIN NAMES FOR IDENTIFICATION OF USERS ON A GLOBAL COMPUTER NETWORK (U.S. CLS. 100 AND 101).

SN 75-862,286. UPSHER-SMITH LABORATORIES, INC., MINNEAPOLIS, MN. FILED 12-2-1999.

UPSHER-SMITH

OWNER OF U.S. REG. NO. 1,852,186.

CLASS 3—COSMETICS AND CLEANING PREPARATIONS

FOR NON-MEDICATED SKIN MOISTURIZING LOTIONS (U.S. CLS. 1, 4, 6, 50, 51 AND 52).
FIRST USE 3-7-1997; IN COMMERCE 3-7-1997.

CLASS 5—PHARMACEUTICALS

FOR PHARMACEUTICAL PREPARATIONS, NAMELY AMIODARONE HYDROCHLORIDE USED IN THE TREATMENT OF CARDIAC AND CIRCULATORY DISORDERS, CHOLESTYRAMINE, NAMELY, A BILE SEQUESTRANT FOR REDUCING UNDESIRABLY HIGH BLOOD CHOLESTEROL LEVELS; ANTIDEPRESSANTS AND HERBAL SUPPLEMENTS; MEDICATED SKIN CARE CREAMS FOR MOISTURIZING; DIETARY SUPPLEMENTS, NAMELY, ANTI-STRESS TABLETS AND ANTI-STRESS TABLETS WITH ZINC; MINERAL SUPPLEMENTS, NAMELY ZINC SULFATE; VITAMIN SUPPLEMENTS; MULTIVITAMIN SUPPLEMENTS AND MULTIVITAMIN SUPPLEMENTS WITH MINERALS (U.S. CLS. 6, 18, 44, 46, 51 AND 52).
FIRST USE 7-11-1997; IN COMMERCE 7-11-1997.

SN 75-863,078. MUSICMUSICMUSIC, INC., TORONTO, ONTARIO M6K 3J8, CANADA, FILED 12-2-1999.

MUSICMUSICMUSIC

NO CLAIM IS MADE TO THE EXCLUSIVE RIGHT TO USE "MUSIC", APART FROM THE MARK AS SHOWN.

CLASS 9—ELECTRICAL AND SCIENTIFIC APPARATUS

FOR COMPUTER SOFTWARE FOR PROCESSING, MANIPULATING, TRANSMITTING, RECEIVING AND PLAYING AUDIO PROGRAMS AND MUSIC OVER ELECTRONIC COMMUNICATIONS NETWORKS FOR USE BY BUSINESSES AND INDIVIDUALS (U.S. CLS. 21, 23, 26, 36 AND 38).
FIRST USE 12-25-1997; IN COMMERCE 12-25-1997.

CLASS 38—COMMUNICATION

FOR ELECTRONIC TRANSMISSION OF MUSIC, AUDIO, GRAPHICS, VIDEO OR MULTIMEDIA DATA (U.S. CLS. 100, 101 AND 104).
FIRST USE 12-25-1997; IN COMMERCE 12-25-1997.

CLASS 41—EDUCATION AND ENTERTAINMENT

FOR ENTERTAINMENT SERVICES, NAMELY, PROVIDING MUSIC AND ENTERTAINMENT NEWS AND INFORMATION VIA ELECTRONIC COMMUNICATIONS NETWORK; MUSIC PUBLISHING SERVICES (U.S. CLS. 100, 101 AND 107).
FIRST USE 12-25-1997; IN COMMERCE 12-25-1997.

SN 75-863,079. MUSICMUSICMUSIC, INC., TORONTO, ONTARIO M6K 3J8, CANADA, FILED 12-2-1999.



NO CLAIM IS MADE TO THE EXCLUSIVE RIGHT TO USE "MUSIC", APART FROM THE MARK AS SHOWN.

CLASS 9—ELECTRICAL AND SCIENTIFIC APPARATUS

FOR COMPUTER SOFTWARE FOR PROCESSING, MANIPULATING, TRANSMITTING, RECEIVING AND PLAYING AUDIO PROGRAMS AND MUSIC OVER ELECTRONIC COMMUNICATIONS NETWORKS FOR USE BY BUSINESSES AND INDIVIDUALS (U.S. CLS. 21, 23, 26, 36 AND 38).
FIRST USE 12-25-1997; IN COMMERCE 12-25-1997.

CLASS 38—COMMUNICATION

FOR ELECTRONIC TRANSMISSION OF MUSIC, AUDIO, GRAPHICS, VIDEO OR MULTIMEDIA DATA (U.S. CLS. 100, 101 AND 104).
FIRST USE 12-25-1997; IN COMMERCE 12-25-1997.

CLASS 41—EDUCATION AND ENTERTAINMENT

FOR ENTERTAINMENT SERVICES, NAMELY, PROVIDING MUSIC AND ENTERTAINMENT NEWS AND INFORMATION VIA ELECTRONIC COMMUNICATIONS NETWORK; MUSIC PUBLISHING SERVICES (U.S. CLS. 100, 101 AND 107).
FIRST USE 12-25-1997; IN COMMERCE 12-25-1997.

SN 75-863,708. MARCO DISTRIBUTING, INCORPORATED, IDAHO FALLS, ID. FILED 12-1-1999.

HARD DRIVE

CLASS 9—ELECTRICAL AND SCIENTIFIC APPARATUS

FOR PROTECTIVE HELMETS AND FACE SHIELDS USED WHILE RIDING A MOTOR VEHICLE (U.S. CLS. 21, 23, 26, 36 AND 38).

CLASS 12—VEHICLES

FOR STORAGE BAGS IN THE NATURE OF GEAR-CARRYING TRAVEL BAGS DESIGNED FOR USE WITH MOTOR VEHICLES SUCH AS MOTORCYCLES, SNOWMOBILES AND ATVs, NAMELY, BACKPACKS, HELMET BAGS, MAP POUCHES, SADDLE BAGS, FUEL TANK BAGS, TAIL BAGS FOR USE AT THE TAIL END OF MOTOR VEHICLES, TRUNK BAGS, HANDLEBAR POUCHES, WINDSHIELD BAGS AND BACKREST BAGS (U.S. CLS. 19, 21, 23, 31, 35 AND 44).

CLASS 25—CLOTHING

FOR CLOTHING, NAMELY, JACKETS, SHIRTS, PANTS, INSULATED BIBS FOR PROTECTION AGAINST COLD FOR USE IN MOTOR SPORTS AND SNOW SPORTS, VESTS, THERMALLY INSULATED SUITS FOR PROTECTION AGAINST COLD FOR USE IN MOTOR SPORTS AND SNOW SPORTS, RACING SUITS OF THE TYPE USED WHILE RIDING A MOTOR VEHICLE, UNDERGARMENTS, THERMALLY INSULATED FACE MASKS, SCARVES, GLOVES, MITTENS, AND HATS, ALL OF THE FOREGOING SOLD ONLY THROUGH SPECIALTY WHOLESALE DISTRIBUTORS AND RETAILERS DEALING EXCLUSIVELY IN CLOTHING AND GEAR USED IN MOTOR SPORTS, MOTORCYCLE DEALERSHIPS OR MOTOR SPORTS TRADE SHOWS (U.S. CLS. 22 AND 39).

SN 75-863,914. GROUPE PROCYCLE INC./PROCYCLE GROUP INC., DBA ROCKY MOUNTAIN BICYCLES, QUEBEC, CANADA, FILED 12-3-1999.



PRIORITY CLAIMED UNDER SEC. 44(D) ON CANADA APPLICATION NO. 1017912, FILED 6-3-1999, REG. NO. TMA543679, DATED 4-10-2001, EXPIRES 4-10-2016.

CLASS 12—VEHICLES

FOR BICYCLE AND PARTS THEREFORE, NAMELY, BICYCLE FRAMES, HANDLE BARS AND SADDLES (U.S. CLS. 19, 21, 23, 31, 35 AND 44).

CLASS 18—LEATHER GOODS

FOR BAGS, NAMELY, ALL PURPOSE SPORT BAGS (U.S. CLS. 1, 2, 3, 22 AND 41).

CLASS 25—CLOTHING

FOR CLOTHING, NAMELY, SHIRTS, T-SHIRTS, PANTS, SHORTS, TIGHTS, JACKETS, PULLOVERS, VESTS, GLOVES, WARM-UPS, JERSEYS, SOCKS, HATS AND CAPS (U.S. CLS. 22 AND 39).

SN 75-866,663. NEARLIFE, INC., CAMBRIDGE, MA. FILED 12-8-1999.

LIVING ENTERTAINMENT

NO CLAIM IS MADE TO THE EXCLUSIVE RIGHT TO USE "ENTERTAINMENT", APART FROM THE MARK AS SHOWN.

CLASS 9—ELECTRICAL AND SCIENTIFIC APPARATUS

FOR VIDEO GAMES, CD-ROMS, COMPUTER PROGRAMS FEATURING INTERACTIVE VIRTUAL REALITY AND GRAPHIC ANIMATION ENTERTAINMENT; CELLULAR TELEPHONES; PORTABLE WIRELESS DEVICES, NAMELY, PAGERS, DIGITAL ASSISTANTS, DIGITAL PHONES AND PORTABLE COMPUTING DEVICES, NAMELY, HANDHELD COMPUTERS, PALM PCS, CELLULAR TELEPHONES, TWO-WAY PAGERS, PERSONAL DIGITAL ASSISTANTS, COMPUTER GAMING DEVICES, AND HAND-HELD UNITS FOR PLAYING VIDEO GAMES (U.S. CLS. 21, 23, 26, 36 AND 38).

CLASS 41—EDUCATION AND ENTERTAINMENT

FOR ENTERTAINMENT, NAMELY, INTERACTIVE VIRTUAL REALITY ENVIRONMENTS AND GRAPHIC ANIMATION PROGRAMMING DISPLAYED AT EXHIBITS, AMUSEMENT PARKS, MUSEUMS, AND TRANSMITTED VIA A GLOBAL COMPUTER INFORMATION NETWORK (U.S. CLS. 100, 101 AND 107).

SN 75-868,620. R T I RESEARCH LTD., LANGLEY, BRITISH COLUMBIA, CANADA, FILED 12-13-1999.

ACCUPRO.COM

OWNER OF U.S. REG. NO. 1,900,567.

CLASS 13—FIREARMS

FOR FIREARM AND FIREARM ACCESSORY CARE PRODUCTS, NAMELY BORE SWABS, BORE BRUSHES, BORE PATCHES, ONE PIECE GUN CLEANING RODS, JOINTED GUN CLEANING RODS, FLEXIBLE GUN CLEANING RODS, SLOTTED PATCH RETAINING TIPS, PATCH CLEANING JAGS, GUN CLEANING KITS COMPRISING CLEANING ROD, PATCHES OPTICS CLEANING SOLUTION, SOLVENTS, OIL PRESERVATIVE FOR WOOD AND METAL, AND CASE FOR THE FOREGOING; HARD AND SOFT COVER PROTECTIVE GUN CASES, PROTECTIVE AMMO CASES, PADDED LEATHER RIFLE SLINGS AND FIREARM EPOXY BARREL BEDDING COMPOUND WITH RELEASE AGENT (U.S. CLS. 2 AND 9).

CLASS 35—ADVERTISING AND BUSINESS

FOR ON-LINE RETAIL STORE SERVICES FEATURING GUN CARE PRODUCTS (U.S. CLS. 100, 101 AND 102).

SN 75-869,086. AMERICA'S CUP PROPERTIES, INC., ALBANY, NY. FILED 12-10-1999.

AMERICA'S CUP**CLASS 6—METAL GOODS**

FOR METAL KEY CHAINS AND NAME BADGES (U.S. CLS. 2, 12, 13, 14, 23, 25 AND 50).

CLASS 9—ELECTRICAL AND SCIENTIFIC APPARATUS

FOR PHOTOGRAPHIC AND CINEMATOGRAPHIC INSTRUMENTS AND APPARATUS, NAMELY, PHOTOGRAPHIC SLIDES (U.S. CLS. 21, 23, 26, 36 AND 38).

CLASS 24—FABRICS

FOR TEXTILES AND TEXTILE GOODS, NAMELY, CLOTH FLAGS (U.S. CLS. 42 AND 50).

CLASS 34—SMOKERS' ARTICLES

FOR SMOKERS ARTICLES, NAMELY, MATCHES AND ASHTRAYS NOT OF PRECIOUS METAL (U.S. CLS. 2, 8, 9 AND 17).

SN 75-869,352. NEW JERSEY TRANSIT CORPORATION, NEWARK, NJ. FILED 12-13-1999.

NJ TRANSIT THE WAY TO GO

NO CLAIM IS MADE TO THE EXCLUSIVE RIGHT TO USE "NJ", APART FROM THE MARK AS SHOWN.

CLASS 9—ELECTRICAL AND SCIENTIFIC APPARATUS

FOR DECORATIVE REFRIGERATOR MAGNETS (U.S. CLS. 21, 23, 26, 36 AND 38).
FIRST USE 6-0-1993; IN COMMERCE 6-0-1993.

CLASS 20—FURNITURE AND ARTICLES NOT OTHERWISE CLASSIFIED

FOR HAND HELD MIRRORS AND CHIP BAG CLOSURES NOT OF METAL (U.S. CLS. 2, 13, 22, 25, 32 AND 50).
FIRST USE 6-0-1993; IN COMMERCE 6-0-1993.

CLASS 21—HOUSEWARES AND GLASS

FOR HOUSEWARES AND GIFTS, NAMELY, MUGS, CUPS, SPORTS BOTTLES SOLD EMPTY AND FLOWER POTS SOLD EMPTY (U.S. CLS. 2, 13, 23, 29, 30, 33, 40 AND 50).
FIRST USE 6-0-1993; IN COMMERCE 6-0-1993.

CLASS 31—NATURAL AGRICULTURAL PRODUCTS

FOR LIVE FLOWERING PLANTS AND LIVING PLANTS (U.S. CLS. 1 AND 46).
FIRST USE 6-0-1993; IN COMMERCE 6-0-1993.

SN 75-870,736. PATENT & LICENSE EXCHANGE, INC., THE, PASADENA, CA. FILED 12-6-1999.

THE PATENT & LICENSE EXCHANGE

NO CLAIM IS MADE TO THE EXCLUSIVE RIGHT TO USE "PATENT" AND "LICENSE", APART FROM THE MARK AS SHOWN.

CLASS 35—ADVERTISING AND BUSINESS

FOR AUCTION SERVICES IN THE FIELD OF INTELLECTUAL PROPERTY VIA A GLOBAL COMPUTER NETWORK (U.S. CLS. 100, 101 AND 102).
FIRST USE 1-11-1999; IN COMMERCE 1-11-1999.

CLASS 36—INSURANCE AND FINANCIAL

FOR VALUATION SERVICES AND RISK MANAGEMENT SERVICES IN THE FIELD OF INTELLECTUAL PROPERTY VIA A GLOBAL COMPUTER NETWORK (U.S. CLS. 100, 101 AND 102).

FIRST USE 1-11-1999; IN COMMERCE 1-11-1999.

CLASS 42—SCIENTIFIC, COMPUTER AND LEGAL SERVICES

FOR CONDUCTING SEARCH SERVICES IN THE FIELD OF INTELLECTUAL PROPERTY; AND PROVIDING INFORMATION IN THE FIELD OF INTELLECTUAL PROPERTY VIA A GLOBAL COMPUTER NETWORK (U.S. CLS. 100 AND 101).

FIRST USE 1-11-1999; IN COMMERCE 1-11-1999.

SN 75-873,138. PACIFICARE HEALTH SYSTEMS, INC., CYPRESS, CA. FILED 12-16-1999.

SECUREHORIZONS.COM

OWNER OF U.S. REG. NOS. 1,375,260 AND 1,911,733.

CLASS 35—ADVERTISING AND BUSINESS

FOR ELECTRONIC RETAILING SERVICES VIA COMPUTER FEATURING INSURANCE AND FINANCIAL SERVICES; ELECTRONIC RETAILING SERVICES VIA COMPUTER FEATURING HEALTH CARE PRODUCTS AND SERVICES (U.S. CLS. 100, 101 AND 102).

CLASS 36—INSURANCE AND FINANCIAL

FOR INSURANCE BROKERAGE IN THE FIELD OF HEALTHCARE VIA A GLOBAL COMPUTER NETWORK; PROVIDING INSURANCE AND FINANCIAL INFORMATION VIA A GLOBAL COMPUTER INFORMATION NETWORK (U.S. CLS. 100, 101 AND 102).

CLASS 38—COMMUNICATION

FOR PROVIDING ON-LINE ELECTRONIC BULLETIN BOARDS FOR TRANSMISSION OF MESSAGES AMONG COMPUTER USERS CONCERNING HEALTH AND WELLNESS (U.S. CLS. 100, 101 AND 104).

CLASS 42—SCIENTIFIC, COMPUTER AND LEGAL SERVICES

FOR PROVIDING HEALTH, MEDICAL, HEALTH CARE, WELLNESS, FITNESS, AND NUTRITION INFORMATION VIA A GLOBAL COMPUTER INFORMATION NETWORK (U.S. CLS. 100 AND 101).

SN 75-874,244. TEXAS NETWORKING, INC., AUSTIN, TX. FILED 12-18-1999.

DATAFOUNDRY**CLASS 38—COMMUNICATION**

FOR TELECOMMUNICATION SERVICES, NAMELY, PROVIDING MULTIPLE USER ACCESS TO ELECTRONIC BUSINESS SERVICES OF OTHERS VIA A GLOBAL COMPUTER NETWORK; PROVIDING MULTIPLE USER ACCESS TO DATABASES AND COMPUTER SERVICES OF OTHERS VIA A GLOBAL COMPUTER NETWORK; AND PROVIDING MULTIPLE USER ACCESS TO A GLOBAL COMPUTER NETWORK (U.S. CLS. 100, 101 AND 104).

CLASS 42—SCIENTIFIC, COMPUTER AND LEGAL SERVICES

FOR PROVIDING TELECOMMUNICATIONS CONSULTATION SERVICES FOR USERS REGARDING TELECOMMUNICATIONS CONNECTIVITY AND NETWORKING RELATED TO GLOBAL COMPUTER NETWORK; COMPUTER SERVICES, NAMELY INTERNET AND NETWORK MANAGEMENT SERVICES, NAMELY MANAGING COMPUTER NETWORKS, LOCAL AREA NETWORKS WIDE AREA NETWORKS, VIRTUAL PRIVATE NETWORKS AND WEB SITES ON GLOBAL COMPUTER NETWORKS FOR OTHERS; OPERATING AND MAINTAINING INTERNET DATA CENTERS FOR OTHERS, NAMELY OPERATING AND MAINTAINING SERVERS ON WHICH COMPUTER SERVICES AND DATABASES ARE HOSTED FOR OTHERS; HOSTING OF WEB SITES OF OTHERS ON A SERVER FOR A GLOBAL COMPUTER NETWORK, AND COLLOCATION OF SERVERS; COMPUTER NETWORK MONITORING AND BANDWIDTH USAGE, CONNECTIVITY, AND AVAILABILITY MONITORING ON A GLOBAL COMPUTER NETWORK; PROVIDING COMPUTER NETWORK SECURITY SERVICES, NAMELY INTRUSION DETECTION MONITORING; MAINTAINING AND ESTABLISHING FIREWALLS ON COMPUTER NETWORKS; PROVIDING SERVER LOAD BALANCING, AUTOMATIC PROTECTION SWITCHING, DISK MIRRORING, NAMELY, WRITING DATA TO TWO DUPLICATE DISKS SIMULTANEOUSLY, AND RAID ARRAY DATA MANAGEMENT ON COMPUTER NETWORKS, NAMELY, PROVIDING REDUNDANT ARRAYS OF INDEPENDENT DISKS FOR FAULT TOLERANCE AND PERFORMANCE; COMPUTER CONSULTING SERVICES IN THE FIELD OF GLOBAL COMPUTER NETWORKS (U.S. CLS. 100 AND 101).

SN 75-877,619. EIFERMAN, SHAWN, HENDERSON, NV. FILED 12-16-1999.

EPSTEIN'S MOTHER**CLASS 9—ELECTRICAL AND SCIENTIFIC APPARATUS**

FOR PRE-RECORDED COMPACT DISCS FEATURING MUSICAL SOUND RECORDINGS OF MODERN ROCK (U.S. CLS. 21, 23, 26, 36 AND 38).

FIRST USE 8-1-1998; IN COMMERCE 8-1-1998.

CLASS 25—CLOTHING

FOR CLOTHING, NAMELY, HATS, T-SHIRTS AND SWEAT SHIRTS (U.S. CLS. 22 AND 39).

FIRST USE 8-1-1998; IN COMMERCE 8-1-1998.

SN 75-878,119. SEIKO INSTRUMENTS KABUSHIKI KAISHA, TA SEIKO INSTRUMENTS INC., MIHAMA-KU, CHIBA-SHI, JAPAN, FILED 12-22-1999.

SII ●

CLASS 14—JEWELRY

FOR CLOCKS, WATCHES, PARTS AND ACCESSORIES THEREOF (U.S. CLS. 2, 27, 28 AND 50).

CLASS 37—CONSTRUCTION AND REPAIR

FOR REPAIR OF CLOCKS AND WATCHES (U.S. CLS. 100, 103 AND 106).

SN 75-879,323. HEARING RESEARCH INSTITUTE, INC., THE, SUNRISE, FL. FILED 12-27-1999.



The Hearing Research Institute

SN 75-879,108. NOKIA MOBILE PHONES LTD., 02150 ESPOO, FINLAND, FILED 12-23-1999.

VIVOCE

PRIORITY CLAIMED UNDER SEC. 44(D) ON FINLAND APPLICATION NO. T199902460, FILED 8-4-1999, REG. NO. 220801, DATED 5-15-2001, EXPIRES 5-15-2011.

CLASS 9—ELECTRICAL AND SCIENTIFIC APPARATUS

FOR ELECTRICAL SYSTEMS, SOFTWARE AND APPARATUS, NAMELY, ANALOG AND DIGITAL RADIO TRANSCEIVERS OR RECEIVERS, TELEPHONES, CORDLESS, WIRELESS OR SATELLITE TELEPHONES, COMPUTERS, DEDICATED NETWORK TERMINALS FOR TELECOMMUNICATIONS, FACSIMILES, COMMUNICATORS, PERSONAL DIGITAL ASSISTANTS, SMART PHONES, MEDIA PHONES, PAYPHONES, CAMERAS, VIDEOCAMERAS, SMART CARDS, SMART CARD READERS, REMOTE CONTROL UNITS, COMPUTER SOFTWARE AND PROGRAMS USED FOR RECORDING, STORING, TRANSMISSION, RECEIVING OR REPRODUCING OF DATA, SOUND, IMAGES AND VIDEO TRANSMISSION; ELECTRICAL SYSTEMS, SOFTWARE AND APPARATUS FOR SCRAMBLING, DESCRAMBLING, ENCODING AND DECODING OF VOICE, DATA, IMAGE AND VIDEO TRANSMISSIONS, ELECTRONIC DATA INPUT AND OUTPUT APPARATUS, NAMELY, COMPUTER AND TELECOMMUNICATIONS TERMINALS, RECEIVERS, TRANSMITTERS, DECODERS AND TRANSCEIVERS CAPABLE OF PROCESSING BROADCAST, SATELLITE, FACSIMILE, TELEVISION, TELECOMMUNICATION, NETWORK, INFRARED, VIDEO GAME AND COMPUTER DATA SIGNALS; TELECOMMUNICATION NETWORK EQUIPMENT, NAMELY, RADIO LINKS, RADIO RELAYS, MICROWAVE RADIOS, TELECOMMUNICATION AND COMPUTER NETWORK EXCHANGES, ACCESS NODES, SERVERS, ROUTERS, MULTIPLEXERS, INTERFACES, ANTENNAS, TRANSMITTERS, DIGITAL RADIO RECEIVERS, SIGNAL PROCESSORS, MICROWAVE RADIO LINKS, CABLE LINKS, CABINETS FOR HOLDING POWER SUPPLIES AND NETWORK ELEMENTS, SWITCHING PLATFORMS, ANALOG AND DIGITAL SWITCHES FOR TELECOMMUNICATIONS NETWORKS, ANALOG AND DIGITAL RADIO TRANSCEIVERS, FACSIMILE AND COMPUTERS CONNECTED TO THE GLOBAL COMMUNICATIONS NETWORKS, WIRELESS TELEPHONES, RADIO PAGERS (U.S. CLS. 21, 23, 26, 36 AND 38).

CLASS 38—COMMUNICATION

FOR SATELLITE, TELEPHONE, TELEGRAM, TELEX, FACSIMILE AND E-MAIL COMMUNICATION SERVICES; TELECOMMUNICATIONS SERVICES, NAMELY, PROVIDING ACCESS TO COMPUTER, COMMUNICATIONS AND TELECOMMUNICATIONS NETWORKS, TO GLOBAL COMPUTER NETWORK AND TO LOCAL AREA NETWORK (U.S. CLS. 100, 101 AND 104).

NO CLAIM IS MADE TO THE EXCLUSIVE RIGHT TO USE "THE HEARING RESEARCH INSTITUTE", APART FROM THE MARK AS SHOWN.

CLASS 16—PAPER GOODS AND PRINTED MATTER

FOR EDUCATIONAL MATERIAL, NAMELY, BOOKS AND BROCHURES FEATURING HEARING IMPROVEMENT AND HEARING SCREENING FOR CHILDREN AND INDIGENTS (U.S. CLS. 2, 5, 22, 23, 29, 37, 38 AND 50).

FIRST USE 6-29-1990; IN COMMERCE 6-29-1990.

CLASS 41—EDUCATION AND ENTERTAINMENT

FOR EDUCATIONAL SERVICES, NAMELY, CONDUCTING TRAINING CLASSES, SEMINARS, CONFERENCES AND WORKSHOPS IN THE FIELD OF HEARING IMPROVEMENT FOR CHILDREN, AND FOR THE DISTRIBUTION OF INSTRUCTIONAL MATERIAL IN CONNECTION THEREWITH (U.S. CLS. 100, 101 AND 107).

FIRST USE 6-29-1990; IN COMMERCE 6-29-1990.

SN 75-879,614. NORTHERN WILDERNESS ADVENTURES, INC., WASILLA, AK. FILED 10-14-1999.



NO CLAIM IS MADE TO THE EXCLUSIVE RIGHT TO USE "ALASKA" AND "NORTHERN WILDERNESS ADVENTURES, INC.", APART FROM THE MARK AS SHOWN.

CLASS 39—TRANSPORTATION AND STORAGE

FOR ARRANGING TRAVEL TOURS IN THE NATURE OF GUIDED AND UNGUIDED FISHING TOURS; GUIDED AND UNGUIDED HUNTING TOURS; GUIDED AND UNGUIDED WILDLIFE VIEWING AND PHOTOGRAPHY TOURS (U.S. CLS. 100 AND 105).

FIRST USE 1-1-1984; IN COMMERCE 1-1-1984.

CLASS 42—SCIENTIFIC, COMPUTER AND LEGAL SERVICES

FOR MAKING RESERVATIONS AND BOOKING FOR TEMPORARY LODGING IN THE NATURE OF FISHING LODGES; TRAVEL AGENCY SERVICES, NAMELY MAKING RESERVATIONS AND BOOKING FOR TEMPORARY LODGING IN THE NATURE OF MOBILE TENT CAMPS AND LOG CABINS (U.S. CLS. 100 AND 101).

FIRST USE 1-1-1984; IN COMMERCE 1-1-1984.

SN 75-879,854. VTEL CORPORATION, AUSTIN, TX. FILED 12-23-1999.

PIXELGRAM**CLASS 35—ADVERTISING AND BUSINESS**

FOR LICENSING OF COMPUTER SOFTWARE TO PROVIDE MULTIMEDIA MESSAGING CAPABILITIES OVER A GLOBAL COMPUTER NETWORK, NAMELY, SOFTWARE THAT PROVIDES THE INTEGRATION OF AUDIO, VIDEO, AND GRAPHICS IN ELECTRONIC MESSAGES (U.S. CLS. 100, 101 AND 102).

CLASS 42—SCIENTIFIC, COMPUTER AND LEGAL SERVICES

FOR COMPUTER SOFTWARE DESIGN FOR OTHERS IN THE FIELD OF SOFTWARE THAT PROVIDES MULTIMEDIA MESSAGING CAPABILITIES OVER A GLOBAL COMPUTER NETWORK, NAMELY, THE INTEGRATION OF AUDIO, VIDEO, AND GRAPHICS IN ELECTRONIC MESSAGES; COMPUTER CONSULTATION SERVICES REGARDING MULTIMEDIA MESSAGING CAPABILITIES OVER A GLOBAL COMPUTER NETWORK, NAMELY, THE INTEGRATION OF AUDIO, VIDEO, AND GRAPHICS IN ELECTRONIC MESSAGES (U.S. CLS. 100 AND 101).

SN 75-883,957. HANDANGO.COM, INC., HURST, TX. BY CHANGE OF NAME GOPDA.COM, INC., HURST, TX. FILED 12-30-1999.

HANDANGO.COM**CLASS 35—ADVERTISING AND BUSINESS**

FOR COMPUTERIZED ONLINE RETAIL AND ORDERING SERVICES IN THE FIELDS OF HANDHELD COMPUTER DEVICES, PERSONAL DIGITAL ASSISTANT DEVICES, COMPUTER HARDWARE, LAND AND CELLULAR TELEPHONES, AND ACCESSORIES FOR USE IN CONNECTION WITH SOFTWARE PLATFORMS IN USE WITH SAME, AND COMPUTER PERIPHERALS, NAMELY, MODEMS, CASES, POWER CORDS, STYLUSES AND THE LIKE (U.S. CLS. 100, 101 AND 102).

CLASS 38—COMMUNICATION

FOR PROVIDING ON-LINE INFORMATION REGARDING RESOURCES FOR WIRELESS FACSIMILE MAIL SERVICES AND WIRELESS DIGITAL MESSAGING SERVICES, AND FOR MULTIPLE USER ACCESS AND TELECOMMUNICATIONS CONNECTIONS TO A GLOBAL COMPUTER INFORMATION NETWORK (U.S. CLS. 100, 101 AND 104).

CLASS 42—SCIENTIFIC, COMPUTER AND LEGAL SERVICES

FOR DESIGNING AND IMPLEMENTING CUSTOM CONFIGURATIONS OF HANDHELD COMPUTER DEVICES AND PERSONAL DIGITAL ASSISTANT DEVICES FOR OTHERS, HOSTING A WEBSITE FEATURING INFORMATION AND LINKS TO DOWNLOADABLE THIRD-PARTY COMPUTER SOFTWARE RELATING TO HANDHELD COMPUTER DEVICES, PERSONAL DIGITAL ASSISTANT DEVICES AND SOFTWARE PLATFORMS FOR USE WITH SAME, PROVIDING A WEBSITE FEATURING NEWS AND INFORMATION RELATING TO HANDHELD COMPUTER DEVICES, PERSONAL DIGITAL ASSISTANT DEVICES AND SOFTWARE PLATFORMS FOR USE WITH SAME, AND PROVIDING TECHNICAL CONSULTATION AND SUPPORT SERVICES RELATED TO SAME (U.S. CLS. 100 AND 101).

SN 75-884,688. TOUCHPOINT, INC., EMERYVILLE, CA. BY CHANGE OF NAME CARDSTORE.COM, INC., EMERYVILLE, CA. FILED 12-30-1999.



NO CLAIM IS MADE TO THE EXCLUSIVE RIGHT TO USE "CARD STORE.COM", APART FROM THE MARK AS SHOWN.

CLASS 16—PAPER GOODS AND PRINTED MATTER

FOR GREETING CARDS (U.S. CLS. 2, 5, 22, 23, 29, 37, 38 AND 50).

CLASS 35—ADVERTISING AND BUSINESS

FOR ONLINE ORDERING, RETAIL AND WHOLESALE SERVICES IN THE FIELD OF STANDARD AND CUSTOMIZED GREETING CARDS; ADDRESSING OF ENVELOPES (U.S. CLS. 100, 101 AND 102).

CLASS 39—TRANSPORTATION AND STORAGE

FOR MAILING GREETING CARDS FOR OTHERS (U.S. CLS. 100 AND 105).

CLASS 40—MATERIAL TREATMENT

FOR CUSTOM MANUFACTURING OF GREETING CARDS OF ALL TYPES (U.S. CLS. 100, 103 AND 106).

CLASS 42—SCIENTIFIC, COMPUTER AND LEGAL SERVICES

FOR CREATION, GENERAL DESIGN, AND CUSTOMIZED DESIGN FOR OTHERS OF GREETING CARDS OF ALL TYPES, FEATURING STANDARD GREETINGS, DESIGNS AND PHOTOGRAPHS AND CUSTOMERS' SELECTED CUSTOMIZED GREETINGS, DESIGNS, PHOTOGRAPHS, ADDRESSES AND SIGNATURES, VIA THE INTERNET AND THROUGH TRADITIONAL MEANS (U.S. CLS. 100 AND 101).

CLASS 25—CLOTHING

FOR BASED ON USE IN COMMERCE 1(A) SHIRTS, TANKTOPS, AND HEADWEAR; BASED ON INTENT TO USE 1(B) CLOTHING, NAMELY, SCARVES, KERCHIEFS WITH TIES, RAGLANS, TOPS, SWEATERS, JACKETS; PEASANT HATS (U.S. CLS. 22 AND 39).

FIRST USE 8-10-1999; IN COMMERCE 8-10-1999.

CLASS 41—EDUCATION AND ENTERTAINMENT

FOR BASED ON INTENT TO USE 1(B) ENTERTAINMENT SERVICES, NAMELY, LIVE MUSICAL PERFORMANCES; PROVIDING INFORMATION ABOUT PERFORMANCES, RECORDINGS, APPEARANCES, THE BIOGRAPHY AND OTHER INFORMATION ABOUT A MUSIC GROUP VIA WEBSITES ON A GLOBAL COMPUTER NETWORK; PROVIDING MUSIC SELECTABLE BY INDIVIDUAL USERS BY MEANS OF A GLOBAL COMPUTER NETWORK (U.S. CLS. 100, 101 AND 107).

SN 75-887,143. TAYLOR MADE GROUP, INC., GLOVERSVILLE, NY. FILED 1-5-2000.

TAYLOR MADE GROUP

OWNER OF U.S. REG. NOS. 724,435, 1,924,537 AND OTHERS.

NO CLAIM IS MADE TO THE EXCLUSIVE RIGHT TO USE "GROUP", APART FROM THE MARK AS SHOWN.

CLASS 11—ENVIRONMENTAL CONTROL APPARATUS

FOR AIR CONDITIONERS, REFRIGERATION UNITS, AND REPLACEMENT PARTS THEREFOR, FOR BOATS AND RECREATIONAL VEHICLES (U.S. CLS. 13, 21, 23, 31 AND 34).

FIRST USE 9-0-1999; IN COMMERCE 9-0-1999.

CLASS 16—PAPER GOODS AND PRINTED MATTER

FOR TOILET PAPER, AND PAPER PENNANTS (U.S. CLS. 2, 5, 22, 23, 29, 37, 38 AND 50).

FIRST USE 10-1-1999; IN COMMERCE 10-1-1999.

SN 75-887,436. A PERFECT CIRCLE, LOS ANGELES, CA. FILED 1-5-2000.

A PERFECT CIRCLE

SN 75-887,435. A PERFECT CIRCLE, LOS ANGELES, CA. FILED 1-5-2000.

CLASS 9—ELECTRICAL AND SCIENTIFIC APPARATUS

FOR BASED ON INTENT TO USE 1(B) SERIES OF MUSICAL SOUND RECORDINGS AND MUSICAL VIDEO RECORDINGS; DOWNLOADABLE MUSICAL SOUND RECORDINGS (U.S. CLS. 21, 23, 26, 36 AND 38).

CLASS 25—CLOTHING

FOR BASED ON INTENT TO USE 1(B) CLOTHING, NAMELY, SCARVES, KERCHIEFS WITH TIES, RAGLANS, TOPS, SWEATERS, JACKETS; HEADWEAR, PEASANT HATS, HATS, BEANIES, AND CAPS; BASED ON USE IN COMMERCE 1(A) SHIRTS AND TANKTOPS (U.S. CLS. 22 AND 39).

FIRST USE 8-10-1999; IN COMMERCE 8-10-0999.

CLASS 41—EDUCATION AND ENTERTAINMENT

FOR BASED ON USE IN COMMERCE 1(A) ENTERTAINMENT SERVICES, NAMELY, LIVE MUSICAL PERFORMANCES; PROVIDING INFORMATION ABOUT PERFORMANCES, RECORDINGS, APPEARANCES, THE BIOGRAPHY AND OTHER INFORMATION ABOUT A MUSIC GROUP VIA WEBSITES ON A GLOBAL COMPUTER NETWORK; PROVIDING MUSIC SELECTABLE BY INDIVIDUAL USERS BY MEANS OF A GLOBAL COMPUTER NETWORK (U.S. CLS. 100, 101 AND 107).

FIRST USE 8-10-1999; IN COMMERCE 8-10-1999.

CLASS 9—ELECTRICAL AND SCIENTIFIC APPARATUS

FOR BASED ON INTENT TO USE 1(B) SERIES OF MUSICAL SOUND RECORDINGS AND MUSICAL VIDEO RECORDINGS; DOWNLOADABLE MUSICAL SOUND RECORDINGS (U.S. CLS. 21, 23, 26, 36 AND 38).

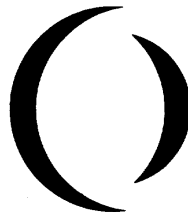

SN 75-887,708. BEUCHAT NORTH AMERICA, INC., MIAMI, FL. FILED 1-5-2000.

Get Into It.

INTELLIGENT
TECHNOLOGY

CLASS 9—ELECTRICAL AND SCIENTIFIC APPARATUS

FOR DIVING EQUIPMENT FOR SCUBA DIVING AND SNORKELING, NAMELY, VESTS AND REGULATORS (U.S. CLS. 21, 23, 26, 36 AND 38).

FIRST USE 6-0-1999; IN COMMERCE 6-0-1999.

CLASS 28—TOYS AND SPORTING GOODS

FOR DIVING EQUIPMENT FOR SCUBA DIVING AND SNORKELING, NAMELY, DIVING MASKS, DIVING FINS, SNORKELS AND WEIGHTS (U.S. CLS. 22, 23, 38 AND 50).

FIRST USE 6-0-1999; IN COMMERCE 6-0-1999.

SN 75-889,702. BLUBAY YACHTS S.A., CANNES, FRANCE, FILED 1-7-2000.

BLUBAY

CLASS 12—VEHICLES

FOR BOATS AND YACHTS, AND THEIR STRUCTURAL PARTS (U.S. CLS. 19, 21, 23, 31, 35 AND 44).

FIRST USE 7-22-1999; IN COMMERCE 7-22-1999.

CLASS 25—CLOTHING

FOR ARTICLES OF CLOTHING, NAMELY, FOOTWEAR, HEADBANDS, CAPS AND HATS (U.S. CLS. 22 AND 39).

FIRST USE 7-22-1999; IN COMMERCE 7-22-1999.

CLASS 42—SCIENTIFIC, COMPUTER AND LEGAL SERVICES

FOR PRODUCT RESEARCH FOR OTHERS, NAMELY SCIENTIFIC AND INDUSTRIAL RESEARCH SERVICES IN THE FIELD OF BOATS AND YACHTS; ARCHITECTURAL DESIGN FOR OTHERS IN THE FIELD OF NAVAL ARCHITECTURE (U.S. CLS. 100 AND 101).

FIRST USE 7-22-1999; IN COMMERCE 7-22-1999.

SN 75-894,460. CENTRAL GLASS COMPANY, LIMITED, YAMAGUCHI-KEN, JAPAN, FILED 1-12-2000.

CGAC

CLASS 12—VEHICLES

FOR LAND VEHICLE PARTS, NAMELY, WINDSHIELDS, FINISHED GLASS WINDOWS FOR VEHICLES (U.S. CLS. 19, 21, 23, 31, 35 AND 44).

CLASS 19—NON-METALLIC BUILDING MATERIALS

FOR BUILDING GLASS, NAMELY, GLASS PANELS AND PANES, SMOOTH PLATE GLASS, COMMON SHEET GLASS, FIGURED OR ROLLED GLASS, WIRED GLASS, TEMPERED GLASS, LAMINATED GLASS, COLORED SHEET GLASS, FANCY SHEET GLASS, GLASS TILE, GLASS BRICK, GLASS ROOFING TILE, DECORATION GLASS, ULTRAVIOLET ABSORBING GLASS, INFRARED ABSORBING GLASS, RADIAL INTERCEPTION GLASS, LUMINOUS GLASS AND INFRARED REFLECTING GLASS; WINDOW GLASS, INSULATED GLASS, AND GLASS FOR SAFETY PURPOSES, NAMELY, COMMON SHEET GLASS, FIGURED OR ROLLED GLASS, WIRED GLASS, TEMPERED GLASS, LAMINATED GLASS, COLORED SHEET GLASS, ULTRAVIOLET ABSORBING GLASS, INFRARED ABSORBING GLASS, INFRARED REFLECTING GLASS, RADIAL INTERCEPTION GLASS, SENSITIVE GLASS, ELECTRIC CONDUCTION GLASS AND LUMINOUS GLASS (U.S. CLS. 1, 12, 33 AND 50).

CLASS 21—HOUSEWARES AND GLASS

FOR UNFINISHED WINDOW GLASS FOR VEHICLE WINDOWS INCLUDING COMMON SHEET GLASS, FIGURED OR ROLLED GLASS, WIRED GLASS, TEMPERED GLASS, LAMINATED GLASS, COLORED SHEET GLASS, FANCY SHEET GLASS, DECORATION GLASS, ULTRAVIOLET ABSORBING GLASS, INFRARED ABSORBING GLASS, INFRARED REFLECTING GLASS, RADIAL INTERCEPTION GLASS, SENSITIVE GLASS, ELECTRIC CONDUCTION GLASS AND LUMINOUS GLASS; STAINED GLASS FOR DECORATION; UNWROUGHT GLASS, NAMELY, COMMON SHEET GLASS, FIGURED OR ROLLED GLASS, WIRED GLASS, TEMPERED GLASS, LAMINATED GLASS, COLORED SHEET GLASS, FANCY SHEET GLASS, DECORATION GLASS, ULTRAVIOLET ABSORBING GLASS, INFRARED ABSORBING GLASS, INFRARED REFLECTING GLASS, RADIAL INTERCEPTION GLASS, SENSITIVE GLASS, ELECTRIC CONDUCTION GLASS AND LUMINOUS GLASS (U.S. CLS. 2, 13, 23, 29, 30, 33, 40 AND 50).

SN 75-894,464. CENTRAL GLASS COMPANY, LIMITED, YAMAGUCHI-KEN, JAPAN, FILED 1-12-2000.

CGA

CLASS 12—VEHICLES

FOR LAND VEHICLE PARTS, NAMELY, WINDSHIELDS, FINISHED GLASS WINDOWS FOR VEHICLES (U.S. CLS. 19, 21, 23, 31, 35 AND 44).

CLASS 19—NON-METALLIC BUILDING MATERIALS

FOR BUILDING GLASS, NAMELY, GLASS PANELS AND PANES, SMOOTH PLATE GLASS, COMMON SHEET GLASS, FIGURED OR ROLLED GLASS, WIRED GLASS, TEMPERED GLASS, LAMINATED GLASS, COLORED SHEET GLASS, FANCY SHEET GLASS, GLASS TILE, GLASS BRICK, GLASS ROOFING TILE, DECORATION GLASS, ULTRAVIOLET ABSORBING GLASS, INFRARED ABSORBING GLASS, RADIAL INTERCEPTION GLASS, LUMINOUS GLASS AND INFRARED REFLECTING GLASS; WINDOW GLASS, INSULATED GLASS, AND GLASS FOR SAFETY PURPOSES, NAMELY, COMMON SHEET GLASS, FIGURED OR ROLLED GLASS, WIRED GLASS, TEMPERED GLASS, LAMINATED GLASS, COLORED SHEET GLASS, ULTRAVIOLET ABSORBING GLASS, INFRARED ABSORBING GLASS, INFRARED REFLECTING GLASS, RADIAL INTERCEPTION GLASS, SENSITIVE GLASS, ELECTRIC CONDUCTION GLASS AND LUMINOUS GLASS (U.S. CLS. 1, 12, 33 AND 50).

CLASS 21—HOUSEWARES AND GLASS

FOR UNFINISHED WINDOW GLASS FOR VEHICLE WINDOWS INCLUDING COMMON SHEET GLASS, FIGURED OR ROLLED GLASS, WIRED GLASS, TEMPERED GLASS, LAMINATED GLASS, COLORED SHEET GLASS, FANCY SHEET GLASS, DECORATION GLASS, ULTRAVIOLET ABSORBING GLASS, INFRARED ABSORBING GLASS, INFRARED REFLECTING GLASS, RADIAL INTERCEPTION GLASS, SENSITIVE GLASS, ELECTRIC CONDUCTION GLASS AND LUMINOUS GLASS; STAINED GLASS FOR DECORATION; UNWROUGHT GLASS, NAMELY, COMMON SHEET GLASS, FIGURED OR ROLLED GLASS, WIRED GLASS, TEMPERED GLASS, LAMINATED GLASS, COLORED SHEET GLASS, FANCY SHEET GLASS, DECORATION GLASS, ULTRAVIOLET ABSORBING GLASS, INFRARED ABSORBING GLASS, INFRARED REFLECTING GLASS, RADIAL INTERCEPTION GLASS, SENSITIVE GLASS, ELECTRIC CONDUCTION GLASS AND LUMINOUS GLASS (U.S. CLS. 2, 13, 23, 29, 30, 33, 40 AND 50).

SN 75-894,467. CENTRAL GLASS COMPANY, LIMITED, YAMAGUCHI-KEN, JAPAN, FILED 1-12-2000.

VGC**CLASS 12—VEHICLES**

FOR LAND VEHICLE PARTS, NAMELY, WINDSHIELDS, FINISHED GLASS WINDOWS FOR VEHICLES (U.S. CLS. 19, 21, 23, 31, 35 AND 44).

CLASS 19—NON-METALLIC BUILDING MATERIALS

FOR BUILDING GLASS, NAMELY, GLASS PANELS AND PANES, SMOOTH PLATE GLASS, COMMON SHEET GLASS, FIGURED OR ROLLED GLASS, WIRED GLASS, TEMPERED GLASS, LAMINATED GLASS, COLORED SHEET GLASS, FANCY SHEET GLASS, GLASS TILE, GLASS BRICK, GLASS ROOFING TILE, DECORATION GLASS, ULTRAVIOLET ABSORBING GLASS, INFRARED ABSORBING GLASS, RADIAL INTERCEPTION GLASS, LUMINOUS GLASS AND INFRARED REFLECTING GLASS; WINDOW GLASS, INSULATED GLASS, AND GLASS FOR SAFETY PURPOSES, NAMELY, COMMON SHEET GLASS, FIGURED OR ROLLED GLASS, WIRED GLASS, TEMPERED GLASS, LAMINATED GLASS, COLORED SHEET GLASS, ULTRAVIOLET ABSORBING GLASS, INFRARED ABSORBING GLASS, INFRARED REFLECTING GLASS, RADIAL INTERCEPTION GLASS, SENSITIVE GLASS, ELECTRIC CONDUCTION GLASS AND LUMINOUS GLASS (U.S. CLS. 1, 12, 33 AND 50).

CLASS 21—HOUSEWARES AND GLASS

FOR UNFINISHED WINDOW GLASS FOR VEHICLE WINDOWS INCLUDING COMMON SHEET GLASS, FIGURED OR ROLLED GLASS, WIRED GLASS, TEMPERED GLASS, LAMINATED GLASS, COLORED SHEET GLASS, FANCY SHEET GLASS, DECORATION GLASS, ULTRAVIOLET ABSORBING GLASS, INFRARED ABSORBING GLASS, INFRARED REFLECTING GLASS, RADIAL INTERCEPTION GLASS, SENSITIVE GLASS, ELECTRIC CONDUCTION GLASS AND LUMINOUS GLASS; STAINED GLASS FOR DECORATION; UNWROUGHT GLASS, NAMELY, COMMON SHEET GLASS, FIGURED OR ROLLED GLASS, WIRED GLASS, TEMPERED GLASS, LAMINATED GLASS, COLORED SHEET GLASS, FANCY SHEET GLASS, DECORATION GLASS, ULTRAVIOLET ABSORBING GLASS, INFRARED ABSORBING GLASS, INFRARED REFLECTING GLASS, RADIAL INTERCEPTION GLASS, SENSITIVE GLASS, ELECTRIC CONDUCTION GLASS AND LUMINOUS GLASS (U.S. CLS. 2, 13, 23, 29, 30, 33, 40 AND 50).

SN 75-894,497. CENTRAL GLASS COMPANY, LIMITED, YAMAGUCHI-KEN, JAPAN, FILED 1-12-2000.

WINLEX**CLASS 12—VEHICLES**

FOR LAND VEHICLE PARTS, NAMELY, WINDSHIELDS, FINISHED GLASS WINDOWS FOR VEHICLES (U.S. CLS. 19, 21, 23, 31, 35 AND 44).

CLASS 19—NON-METALLIC BUILDING MATERIALS

FOR BUILDING GLASS, NAMELY, GLASS PANELS AND PANES, SMOOTH PLATE GLASS, COMMON SHEET GLASS, FIGURED OR ROLLED GLASS, WIRED GLASS, TEMPERED GLASS, LAMINATED GLASS, COLORED SHEET GLASS, FANCY SHEET GLASS, GLASS TILE, GLASS BRICK, GLASS ROOFING TILE, DECORATION GLASS, ULTRAVIOLET ABSORBING GLASS, INFRARED ABSORBING GLASS, RADIAL INTERCEPTION GLASS, LUMINOUS GLASS AND INFRARED REFLECTING GLASS; WINDOW GLASS, INSULATED GLASS, AND GLASS FOR SAFETY PURPOSES, NAMELY, COMMON SHEET GLASS, FIGURED OR ROLLED GLASS, WIRED GLASS, TEMPERED GLASS, LAMINATED GLASS, COLORED SHEET GLASS, ULTRAVIOLET ABSORBING GLASS, INFRARED ABSORBING GLASS, INFRARED REFLECTING GLASS, RADIAL INTERCEPTION GLASS, SENSITIVE GLASS, ELECTRIC CONDUCTING GLASS AND LUMINOUS GLASS (U.S. CLS. 1, 12, 33 AND 50).

CLASS 21—HOUSEWARES AND GLASS

FOR UNFINISHED WINDOW GLASS FOR VEHICLE WINDOWS INCLUDING COMMON SHEET GLASS, FIGURED OR ROLLED GLASS, WIRED GLASS, TEMPERED GLASS, LAMINATED GLASS, COLORED SHEET GLASS, FANCY SHEET GLASS, DECORATION GLASS, ULTRAVIOLET ABSORBING GLASS, INFRARED ABSORBING GLASS, INFRARED REFLECTING GLASS, RADIAL INTERCEPTION GLASS, SENSITIVE GLASS, ELECTRIC CONDUCTION GLASS AND LUMINOUS GLASS; STAINED GLASS FOR DECORATION; UNWROUGHT GLASS, NAMELY, COMMON SHEET GLASS, FIGURED OR ROLLED GLASS, WIRED GLASS, TEMPERED GLASS, LAMINATED GLASS, COLORED SHEET GLASS, FANCY SHEET GLASS, DECORATION GLASS, ULTRAVIOLET ABSORBING GLASS, INFRARED ABSORBING GLASS, INFRARED REFLECTING GLASS, RADIAL INTERCEPTION GLASS, SENSITIVE GLASS, ELECTRIC CONDUCTION GLASS AND LUMINOUS GLASS (U.S. CLS. 2, 13, 23, 29, 30, 33, 40 AND 50).

SN 75-894,949. BURNADISC CORP., CARMEL, CA. FILED 1-13-2000.

MOVEDIGITAL**CLASS 35—ADVERTISING AND BUSINESS**

FOR COMPUTERIZED ON-LINE RETAIL SERVICES IN THE FIELD OF CD-ROM'S, DVD'S, AND OTHER COMPUTER-READABLE MEDIA (U.S. CLS. 100, 101 AND 102).

CLASS 41—EDUCATION AND ENTERTAINMENT

FOR PRODUCTION OF CD-ROMS AND DIGITAL VERSATILITY DISCS FEATURING ONE OR MORE OF THE FOLLOWING - MUSIC, VIDEOS, TELEVISION SHOWS, ACTION, ADVENTURE, COMEDY AND DRAMA MOVIES, ANIMATION AND COMPUTER SOFTWARE (U.S. CLS. 100, 101 AND 107).

SN 75-895,899. EMCOR GROUP, INC., NORWALK, CT.
FILED 1-12-2000.

SN 75-901,196. SOPHIA INSTITUTE, MANCHESTER, NH.
FILED 1-21-2000.



CLASS 35—ADVERTISING AND BUSINESS

FOR FACILITIES MANAGEMENT SERVICES (U.S. CLS. 100, 101 AND 102).
FIRST USE 12-0-1994; IN COMMERCE 12-0-1994.

CLASS 37—CONSTRUCTION AND REPAIR

FOR MANAGING, CONTRACTING, PROVIDING MECHANICAL AND ELECTRICAL AND CONSTRUCTION SERVICES; AND MAINTENANCE SERVICES TO PUBLIC, PRIVATE, INSTITUTIONAL AND COMMERCIAL BUILDINGS (U.S. CLS. 100, 103 AND 106).
FIRST USE 12-0-1994; IN COMMERCE 12-0-1994.

SOPHIA INSTITUTE

NO CLAIM IS MADE TO THE EXCLUSIVE RIGHT TO USE "INSTITUTE", APART FROM THE MARK AS SHOWN.

CLASS 35—ADVERTISING AND BUSINESS

FOR SAMPLE DISTRIBUTION SERVICES, NAMELY, DISTRIBUTION OF RELIGIOUS PUBLICATIONS TO CLERGY, PRIESTS AND PRISONERS (U.S. CLS. 100, 101 AND 102).
FIRST USE 2-16-1983; IN COMMERCE 2-16-1983.

CLASS 41—EDUCATION AND ENTERTAINMENT

FOR PUBLICATION OF RELIGIOUS BOOKS, TEXTS, PERIODICALS AND PAMPHLETS (U.S. CLS. 100, 101 AND 107).
FIRST USE 2-16-1983; IN COMMERCE 2-16-1983.

SN 75-895,903. THORN SECURE SCIENCE LIMITED, HAYES, MIDDLESEX, UNITED KINGDOM, FILED 1-14-2000.

SN 75-903,828. THORN SECURE SCIENCE LIMITED, SWINDON, SN2 5AZ, UNITED KINGDOM, FILED 1-27-2000.

QMARK

CLASS 9—ELECTRICAL AND SCIENTIFIC APPARATUS

FOR BLANK MAGNETIC DATA CARRIERS AND DATA STRIPS; RECORDING MEDIA, NAMELY, BLANK AUDIO TAPES, AUDIO AND VIDEO CASSETTES AND COMPACT DISCS; DATA PROCESSORS AND COMPUTERS; SCIENTIFIC APPARATUS AND INSTRUMENTS, NAMELY, TICKETS, VOUCHERS, PAPER TOKENS AND PERSONAL DOCUMENTS, ALL OF WHICH ARE MAGNETICALLY CODED; MAGNETIC CODED CARD READERS, MAGNETIC CARD ENCODERS AND DECODERS; SCIENTIFIC APPARATUS AND INSTRUMENTS FOR CONTROLLING ACCESS TO RESTRICTED AREAS, NAMELY, MAGNETICALLY CODED TICKETS, CARDS, PERSONAL DOCUMENTS, UNLOCKING UNITS; ELECTRONIC SECURITY PRODUCTS, NAMELY TOKENS, TICKETS, CARDS, SERVERS, AND ENCRYPTION UNITS, BLANK SMART CARDS, PRINTERS FOR PRINTING A SEQUENCE OF NUMBERS (U.S. CLS. 21, 23, 26, 36 AND 38).

CLASS 16—PAPER GOODS AND PRINTED MATTER

FOR PAPER CARDS, TICKETS, VOUCHERS, PAPER TOKENS AND DOCUMENTS, BEARING VISUALLY ENCODED INFORMATION, FOR USE IN BUSINESS TRANSACTIONS, NAMELY DOCUMENTS OF COMMERCIAL, SECURITY OR MONETARY VALUE; PRINTED CONTROL TICKETS, CONTROL TOKENS MADE OF PAPER FOR USE AS ADMISSIONS PASSES; MANUAL FRANKING MACHINES; PAPER TAPES AND CARDS FOR THE RECORDING OF COMPUTER DATA; PRINTED MATTER, NAMELY STOCK CERTIFICATES, BOND CERTIFICATES, SHARE CERTIFICATES, BANK NOTES, PASSPORTS, CONCERT TICKETS AND OTHER TICKETS, PAPER TOKENS, PERSONAL PAPERS AND PASSES; NUMBERING MACHINES, EMBOSSERS (U.S. CLS. 2, 5, 22, 23, 29, 37, 38 AND 50).



THE DRAWING IS LINED FOR COLOR. THE LEFT PORTION OF THE BACKGROUND IS BLUE, THE REST OF THE BACKGROUND IS YELLOW. THE LEFT PORTION OF THE LETTER "Q" IS YELLOW, THE RIGHT PORTION OF THE LETTER "Q" IS BLUE, THE LETTERS "MARK" ARE BLUE AND THE INTERIOR OF THE "Q" IS WHITE, THE UNDERLING IS WHITE.

CLASS 9—ELECTRICAL AND SCIENTIFIC APPARATUS

FOR BLANK MAGNETIC DATA CARRIERS AND DATA STRIPS; RECORDING MEDIA, NAMELY, BLANK AUDIO TAPES, AUDIO AND VIDEO CASSETTES AND COMPACT DISCS; DATA PROCESSORS AND COMPUTERS; SCIENTIFIC APPARATUS AND INSTRUMENTS, NAMELY, TICKETS, VOUCHERS, PAPER TOKENS AND PERSONAL DOCUMENTS, ALL OF WHICH ARE MAGNETICALLY CODED; MAGNETIC CODED CARD READERS, MAGNETIC CARD ENCODERS AND DECODERS; SCIENTIFIC APPARATUS AND INSTRUMENTS FOR CONTROLLING ACCESS TO RESTRICTED AREAS, NAMELY, MAGNETICALLY CODED TICKETS, CARDS, PERSONAL DOCUMENTS, UNLOCKING UNITS; ELECTRONIC SECURITY PRODUCTS, NAMELY TOKENS, TICKETS, CARDS, SERVERS, AND ENCRYPTION UNITS, BLANK SMART CARDS, PRINTERS FOR PRINTING A SEQUENCE OF NUMBERS (U.S. CLS. 21, 23, 26, 36 AND 38).

CLASS 16—PAPER GOODS AND PRINTED MATTER

FOR PAPER CARDS, TICKETS, VOUCHERS, PAPER TOKENS AND DOCUMENTS, BEARING VISUALLY ENCODED INFORMATION, FOR USE IN BUSINESS TRANSACTIONS, NAMELY DOCUMENTS OF COMMERCIAL, SECURITY OR MONETARY VALUE; PRINTED CONTROL TICKETS, CONTROL TOKENS MADE OF PAPER FOR USE AS ADMISSIONS PASSES; MANUAL FRANKING MACHINES; PAPER TAPES AND CARDS FOR THE RECORDING OF COMPUTER DATA; PRINTED MATTER, NAMELY STOCK CERTIFICATES, BOND CERTIFICATES, SHARE CERTIFICATES, BANK NOTES, PASSPORTS, CONCERT TICKETS AND OTHER TICKETS, PAPER TOKENS, PERSONAL PAPERS AND PASSES; NUMBERING MACHINES, EMBOSSEERS (U.S. CLS. 2, 5, 22, 23, 29, 37, 38 AND 50).

SN 75-904,476. TLG MEDIA, INC., HOUSTON, TX. FILED 1-28-2000.

q u e s t i a

**CLASS 9—ELECTRICAL AND SCIENTIFIC APPARATUS**

FOR COMPUTER SOFTWARE FOR USE IN DATA BASE MANAGEMENT, WORD PROCESSING, AND ON-LINE PUBLISHING AND USER MANUALS SOLD THEREWITH; COMPUTER SOFTWARE FOR USE IN DATA BASE MANAGEMENT, WORD PROCESSING AND ON-LINE PUBLISHING THAT MAY BE DOWNLOADED FROM A GLOBAL COMPUTER NETWORK, AND USER MANUALS SOLD THEREWITH; COMPUTER SOFTWARE FOR USE IN ACCESSING, RETRIEVING AND DISPLAYING STORED DOCUMENTS AND OTHER MEDIA, NAMELY, LITERARY, PICTORIAL MUSICAL AND ARCHITECTURAL WORKS VIA THE GLOBAL COMPUTER NETWORK, AND USER MANUALS SOLD THEREWITH (U.S. CLS. 21, 23, 26, 36 AND 38).

FIRST USE 4-15-2000; IN COMMERCE 1-22-2001.

CLASS 35—ADVERTISING AND BUSINESS

FOR COMPUTERIZED DATA BASE MANAGEMENT; COMPUTERIZED ON-LINE ORDERING SERVICES IN THE FIELD OF DOCUMENTS AND OTHER MEDIA, NAMELY, LITERARY, PICTORIAL, MUSICAL AND ARCHITECTURAL WORKS; COMPUTERIZED ON-LINE RETAIL SERVICES IN THE FIELD OF DOCUMENTS AND OTHER MEDIA, NAMELY, LITERARY, PICTORIAL, MUSICAL AND ARCHITECTURAL WORKS; PROVIDING AN ON LINE COMPUTER DATABASE IN THE FIELD OF BUSINESS (U.S. CLS. 100, 101 AND 102).

FIRST USE 4-15-2000; IN COMMERCE 1-22-2001.

CLASS 38—COMMUNICATION

FOR PROVIDING ON-LINE CHAT ROOMS FOR TRANSMISSION OF MESSAGES AMONG COMPUTER USERS CONCERNING TOPICS OF GENERAL INTEREST; PROVIDING MULTIPLE USER ACCESS TO GLOBAL COMPUTER INFORMATION NETWORK FOR THE TRANSFER AND DISSEMINATION OF A WIDE RANGE OF INFORMATION (U.S. CLS. 100, 101 AND 104).

FIRST USE 4-15-2000; IN COMMERCE 1-22-2001.

CLASS 39—TRANSPORTATION AND STORAGE

FOR ELECTRONIC STORAGE OF DOCUMENTS AND OTHER MEDIA, NAMELY, LITERARY, PICTORIAL, MUSICAL AND ARCHITECTURAL WORKS; ELECTRONIC REPOSITORY SERVICES OF DOCUMENTS AND OTHER MEDIA, NAMELY, LITERARY, PICTORIAL, MUSICAL AND ARCHITECTURAL WORKS (U.S. CLS. 100 AND 105).

FIRST USE 4-15-2000; IN COMMERCE 1-22-2001.

CLASS 41—EDUCATION AND ENTERTAINMENT

FOR EDUCATIONAL RESEARCH; DEVELOPMENT AND DISSEMINATION OF EDUCATIONAL MATERIALS IN THE FIELDS OF MATHEMATICS, SCIENCE, HUMANITIES, SOCIAL SCIENCES, BUSINESS AND EDUCATION; PROVIDING DISPLAY OF ON-LINE MEDIA, NAMELY, LITERARY, PICTORIAL, MUSICAL AND ARCHITECTURAL WORKS AND EDUCATIONAL MATERIALS IN THE FIELDS OF MATHEMATICS, SCIENCE, HUMANITIES, SOCIAL SCIENCES, BUSINESS AND EDUCATION VIA A GLOBAL COMPUTER NETWORK; PROVIDING AN ON LINE COMPUTER DATABASE IN THE FIELD OF EDUCATION (U.S. CLS. 100, 101 AND 107).

FIRST USE 4-15-2000; IN COMMERCE 1-22-2001.

CLASS 42—SCIENTIFIC, COMPUTER AND LEGAL SERVICES

FOR COMPUTER SERVICES, NAMELY, PROVIDING SEARCH ENGINES FOR OBTAINING DATA ON A GLOBAL COMPUTER NETWORK; WRITTEN TEXT EDITING; EDITORIAL CONSULTATION; PROVIDING AN ON LINE COMPUTER DATABASE IN THE FIELDS OF MATHEMATICS, SCIENCE, HUMANITIES, AND SOCIAL SCIENCES (U.S. CLS. 100 AND 101).

FIRST USE 4-15-2000; IN COMMERCE 1-22-2001.

SN 75-904,477. TLG MEDIA, INC., HOUSTON, TX. FILED 1-28-2000.

QUESTIA

CLASS 9—ELECTRICAL AND SCIENTIFIC APPARATUS

FOR COMPUTER SOFTWARE FOR USE IN DATA BASE MANAGEMENT, WORD PROCESSING, AND ON-LINE PUBLISHING AND USER MANUALS SOLD THEREWITH; COMPUTER SOFTWARE FOR USE IN DATA BASE MANAGEMENT, WORD PROCESSING AND ON-LINE PUBLISHING THAT MAY BE DOWNLOADED FROM A GLOBAL COMPUTER NETWORK, AND USER MANUALS SOLD THEREWITH; COMPUTER SOFTWARE FOR USE IN ACCESSING, RETRIEVING AND DISPLAYING STORED DOCUMENTS AND OTHER MEDIA, NAMELY, LITERARY, PICTORIAL MUSICAL AND ARCHITECTURAL WORKS VIA THE GLOBAL COMPUTER NETWORK, AND USER MANUALS SOLD THEREWITH (U.S. CLS. 21, 23, 26, 36 AND 38).

FIRST USE 4-15-2000; IN COMMERCE 1-22-2001.

CLASS 35—ADVERTISING AND BUSINESS

FOR COMPUTERIZED DATA BASE MANAGEMENT; COMPUTERIZED ON-LINE ORDERING SERVICES IN THE FIELD OF DOCUMENTS AND OTHER MEDIA, NAMELY, LITERARY, PICTORIAL, MUSICAL AND ARCHITECTURAL WORKS; COMPUTERIZED ON-LINE RETAIL SERVICES IN THE FIELD OF DOCUMENTS AND OTHER MEDIA, NAMELY, LITERARY, PICTORIAL, MUSICAL AND ARCHITECTURAL WORKS; PROVIDING AN ON LINE COMPUTER DATABASE IN THE FIELD OF BUSINESS (U.S. CLS. 100, 101 AND 102).

FIRST USE 4-15-2000; IN COMMERCE 1-22-2001.

CLASS 38—COMMUNICATION

FOR PROVIDING ON-LINE CHAT ROOMS FOR TRANSMISSION OF MESSAGES AMONG COMPUTER USERS CONCERNING TOPICS OF GENERAL INTEREST; PROVIDING MULTIPLE USER ACCESS TO GLOBAL COMPUTER INFORMATION NETWORK FOR THE TRANSFER AND DISSEMINATION OF A WIDE RANGE OF INFORMATION (U.S. CLS. 100, 101 AND 104).

FIRST USE 4-15-2000; IN COMMERCE 1-22-2001.

CLASS 39—TRANSPORTATION AND STORAGE

FOR ELECTRONIC STORAGE OF DOCUMENTS AND OTHER MEDIA, NAMELY, LITERARY, PICTORIAL, MUSICAL AND ARCHITECTURAL WORKS; ELECTRONIC REPOSITORY SERVICES OF DOCUMENTS AND OTHER MEDIA, NAMELY, LITERARY, PICTORIAL, MUSICAL AND ARCHITECTURAL WORKS (U.S. CLS. 100 AND 105).

FIRST USE 4-15-2000; IN COMMERCE 1-22-2001.

CLASS 41—EDUCATION AND ENTERTAINMENT

FOR EDUCATIONAL RESEARCH; DEVELOPMENT AND DISSEMINATION OF EDUCATIONAL MATERIALS IN THE FIELDS OF MATHEMATICS, SCIENCE, HUMANITIES, SOCIAL SCIENCES, BUSINESS AND EDUCATION; PROVIDING DISPLAY OF ON-LINE MEDIA, NAMELY, LITERARY, PICTORIAL, MUSICAL AND ARCHITECTURAL WORKS AND EDUCATIONAL MATERIALS IN THE FIELDS OF MATHEMATICS, SCIENCE, HUMANITIES, SOCIAL SCIENCES, BUSINESS AND EDUCATION VIA A GLOBAL COMPUTER NETWORK; PROVIDING AN ON LINE COMPUTER DATABASE IN THE FIELD OF EDUCATION (U.S. CLS. 100, 101 AND 107).

FIRST USE 4-15-2000; IN COMMERCE 1-22-2001.

CLASS 42—SCIENTIFIC, COMPUTER AND LEGAL SERVICES

FOR COMPUTER SERVICES, NAMELY, PROVIDING SEARCH ENGINES FOR OBTAINING DATA ON A GLOBAL COMPUTER NETWORK; WRITTEN TEXT EDITING; EDITORIAL CONSULTATION; PROVIDING AN ON LINE COMPUTER DATABASE IN THE FIELDS OF MATHEMATICS, SCIENCE, HUMANITIES, SOCIAL SCIENCES (U.S. CLS. 100 AND 101).

FIRST USE 4-15-2000; IN COMMERCE 1-22-2001.

SN 75-904,665. DELAWARE CAPITAL FORMATION, INC., WILMINGTON, DE. BY ASSIGNMENT MARATHON EQUIPMENT COMPANY, VERNON, AL. FILED 1-28-2000.

SIGNATURE SERIES

NO CLAIM IS MADE TO THE EXCLUSIVE RIGHT TO USE "SERIES", APART FROM THE MARK AS SHOWN.

CLASS 6—METAL GOODS

FOR METAL COMPACTION AND OPEN TOP TRASH CONTAINERS AND RECYCLING CONTAINERS FOR INDUSTRIAL AND COMMERCIAL USE (U.S. CLS. 2, 12, 13, 14, 23, 25 AND 50).

FIRST USE 1-0-1990; IN COMMERCE 1-0-1990.

CLASS 7—MACHINERY

FOR TRASH COMPACTORS, TRASH BALERS, SHREDDERS, GRINDERS, GRANULATORS, HOISTS, AND PRECRUSHERS (U.S. CLS. 13, 19, 21, 23, 31, 34 AND 35).

FIRST USE 1-0-1990; IN COMMERCE 1-0-1990.

SN 75-911,815. ZUGA.NET, LAS VEGAS, NV. FILED 2-4-2000.

ZUGA.ORG**CLASS 35—ADVERTISING AND BUSINESS**

FOR ONLINE ORDERING SERVICES FEATURING PHOTOGRAPHY AND ART (U.S. CLS. 100, 101 AND 102).

CLASS 42—SCIENTIFIC, COMPUTER AND LEGAL SERVICES

FOR COMMERCIAL PHOTOGRAPHY SERVICES; STOCK PHOTOGRAPHY SERVICES, NAMELY LEASING REPRODUCTION RIGHTS OF PHOTOGRAPHS AND TRANSPARENCIES TO OTHERS; PHOTOGRAPHIC COMPOSITION FOR OTHERS; DIGITAL PROOFING SERVICES; RENTAL OF PHOTOGRAPHIC EQUIPMENT; HOSTING THE WEBSITES OF OTHERS ON A COMPUTER SERVER FOR A GLOBAL COMPUTER NETWORK; DISSEMINATION OF INFORMATION ABOUT PHOTOGRAPHY, DIGITAL IMAGING, AND ABOUT RELATED GOODS AND SERVICES; ALL OF THE SAME VIA GLOBAL COMPUTER NETWORK (U.S. CLS. 100 AND 101).

SN 75-913,713. KRAVET FABRICS, INC., BETHPAGE, NY. FILED 2-3-2000.



OWNER OF U.S. REG. NOS. 1,240,403 AND 1,242,131.

CLASS 20—FURNITURE AND ARTICLES NOT OTHERWISE CLASSIFIED

FOR FURNITURE (U.S. CLS. 2, 13, 22, 25, 32 AND 50).
FIRST USE 8-1-1999; IN COMMERCE 8-1-1999.

CLASS 24—FABRICS

FOR FABRICS AND TEXTILES USED FOR AND IN THE MANUFACTURE OF HOME FURNISHINGS, NAMELY UPHOLSTERY, DRAPERIES, WALLCOVERINGS, LINENS, PILLOWS, SHEETS, BED COVERS, CURTAINS (U.S. CLS. 42 AND 50).

FIRST USE 8-1-1999; IN COMMERCE 8-1-1999.

CLASS 26—FANCY GOODS

FOR FABRIC AND FURNISHING TRIMMINGS NAMELY ORNAMENTAL RIBBONS MADE OF TEXTILES, LACE TRIMMING, TASSELS, CORD, BRAID (U.S. CLS. 37, 39, 40, 42 AND 50).
FIRST USE 8-1-1999; IN COMMERCE 8-1-1999.

SN 75-917,499. UNDOO.COM, INC., NEWPORT BEACH, CA. FILED 2-8-2000.

UNDOO

CLASS 35—ADVERTISING AND BUSINESS

FOR DATABASE MANAGEMENT SERVICES (U.S. CLS. 100, 101 AND 102).

CLASS 39—TRANSPORTATION AND STORAGE

FOR DATA STORAGE, CACHING, AND DELIVERY SERVICES FOR THE NETWORKS OF OTHERS (U.S. CLS. 100 AND 105).

CLASS 42—SCIENTIFIC, COMPUTER AND LEGAL SERVICES

FOR PROTECTION AND RECOVERY OF DATA; DATA BACKUP FOR COMPUTERS AND OTHER ELECTRONIC DEVICES CONNECTED TO OR NETWORKED WITH THE GLOBAL COMPUTER NETWORK, EXTRANETS, OR INTRANETS; COMPUTER CONSULTING SERVICES, NAMELY, CONSULTING WITH REGARD TO NETWORKING PERSONAL COMPUTERS AND ENTERPRISE SERVERS, APPLICATION MANAGEMENT, FILE SHARING FILE SYSTEMS, SYSTEM RECOVERY, GLOBAL COMPUTER NETWORK SYSTEM ACCESS, AND SYSTEM DATA TRANSPORTATION (U.S. CLS. 100 AND 101).

SN 75-914,082. HOLLYWOOD ENTERTAINMENT CORPORATION, WILSONVILLE, OR. FILED 2-8-2000.

FILM REEL

OWNER OF U.S. REG. NO. 2,263,412.

CLASS 16—PAPER GOODS AND PRINTED MATTER

FOR PUBLICATIONS, NAMELY, BOOKS, INFORMATIONAL BROCHURES, NEWSLETTERS, AND MAGAZINES IN THE FIELD OF ENTERTAINMENT AND THE ENTERTAINMENT INDUSTRY; CATALOGS FEATURING ENTERTAINMENT PRODUCTS, NAMELY, AUDIO AND AUDIO VIDEO RECORDINGS AND ASSOCIATED ELECTRONIC EQUIPMENT, MUSIC AND RELATED HOME ENTERTAINMENT PRODUCTS AND EQUIPMENT, VIDEO AND COMPUTER GAMES AND ASSOCIATED ELECTRONIC EQUIPMENT AND ACCESSORIES, GAMES, BOOKS, CLOTHING, TOYS, AND COMPUTER SOFTWARE AND HARDWARE (U.S. CLS. 2, 5, 22, 23, 29, 37, 38 AND 50).

SN 75-919,568. EXPRESS LINK UP, SURREY KT8 0SU, ENGLAND, FILED 2-15-2000.

CLASS 35—ADVERTISING AND BUSINESS

FOR RETAIL STORE SERVICES FEATURING AUDIO AND AUDIO VIDEO RECORDINGS AND ASSOCIATED ELECTRONIC EQUIPMENT, MUSIC AND RELATED HOME ENTERTAINMENT PRODUCTS AND EQUIPMENT, VIDEO AND COMPUTER GAMES AND ASSOCIATED ELECTRONIC EQUIPMENT AND ACCESSORIES, GAMES, BOOKS, MAGAZINES, FOODSTUFFS, CLOTHING, TOYS, AND COMPUTER SOFTWARE AND HARDWARE, ALL PROVIDED VIA A GLOBAL COMPUTER NETWORK; ADVERTISING SERVICES, NAMELY, PREVIEWS OF FILMS OFFERED FOR SALE OR RENTAL ON VIDEO CASSETTE AND VIDEO DISC, PROVIDED VIA A GLOBAL COMPUTER NETWORK (U.S. CLS. 100, 101 AND 102).



NO CLAIM IS MADE TO THE EXCLUSIVE RIGHT TO USE "LINK", APART FROM THE MARK AS SHOWN.
THE MARK CONSISTS OF THE TERM "EXPRESS" RENDERED AS A TRAIN EMITTING SMOKE, PLUS THE TERM "LINK UP" AND A CARTOON-CHARACTER BIRD LEAPING INTO THE AIR.

CLASS 41—EDUCATION AND ENTERTAINMENT

FOR RADIO AND TELEVISION PROGRAMMING; PROVIDING A WIDE VARIETY OF NEWS AND INFORMATION ABOUT MOVIES, FILMS, GAMES, MUSIC, COMPUTER AND VIRTUAL REALITY GAMES, AND OTHER RELATED ENTERTAINMENT AND CULTURAL TOPICS VIA A GLOBAL COMPUTER NETWORK; RENTAL OF AUDIO AND AUDIO-VIDEO RECORDINGS, COMPUTER AND VIDEO GAMES, AND ASSOCIATED ELECTRONIC EQUIPMENT VIA A GLOBAL COMPUTER NETWORK (U.S. CLS. 100, 101 AND 107).

CLASS 36—INSURANCE AND FINANCIAL

FOR CHARITABLE FUND-RAISING SERVICES (U.S. CLS. 100, 101 AND 102).

CLASS 42—SCIENTIFIC, COMPUTER AND LEGAL SERVICES

FOR RENTAL OF COMPUTER SOFTWARE AND COMPUTER HARDWARE VIA A GLOBAL COMPUTER NETWORK (U.S. CLS. 100 AND 101).

CLASS 41—EDUCATION AND ENTERTAINMENT

FOR EDUCATION SERVICES, NAMELY, PROVIDING DISTANCE LEARNING, AND TRAINING IN THE USE AND OPERATION OF COMPUTERS, TO CHILDREN AND YOUNG PEOPLE WHO ARE IN THE HOSPITAL OR OTHERWISE OUT OF SCHOOL; PROVIDING AN EDUCATIONAL OUTREACH PROGRAM TO HELP SUCH CHILDREN MAINTAIN CONTACT WITH THEIR SCHOOLS, FAMILIES AND FRIENDS (U.S. CLS. 100, 101 AND 107).

SN 75-929,563. RAINBOW MEADOW, INC., JACKSON, MI.
FILED 2-28-2000.



CLASS 3—COSMETICS AND CLEANING PREPARATIONS

FOR ESSENTIAL OILS FOR USE IN THE MANUFACTURE OF AROMATHERAPY PRODUCTS; VEGETABLE OILS FOR USE IN THE MANUFACTURE OF SOAPS AND COSMETICS (U.S. CLS. 1, 4, 6, 50, 51 AND 52).
FIRST USE 6-30-1996; IN COMMERCE 6-30-1996.

CLASS 4—LUBRICANTS AND FUELS

FOR WAXES AND CANDLE SUPPLIES (U.S. CLS. 1, 6 AND 15).
FIRST USE 6-30-1996; IN COMMERCE 6-30-1996.

SN 75-931,251. NATIONTAX ONLINE, INC., BIRMINGHAM, AL. FILED 2-29-2000.

NTO.COM

CLASS 35—ADVERTISING AND BUSINESS

FOR ISSUANCE OF PERMITS, LICENSES AND REGISTRATIONS FOR GOVERNMENTAL AGENCIES (U.S. CLS. 100, 101 AND 102).

CLASS 36—INSURANCE AND FINANCIAL

FOR TAX PAYMENT PROCESSING SERVICES AND THE PROVISION OF OTHER GOVERNMENT-RELATED SERVICES, NAMELY, PAYMENT AND PROCESSING OF FEES, FINES AND ASSESSMENTS (U.S. CLS. 100, 101 AND 102).

SN 75-932,175. TAIBI, GIUSEPPE, 92100 AGRIGENTO, ITALY, AND AGRO, LEANDRO, 20129 MILANO, ITALY, FILED 3-2-2000.



THE ENGLISH TRANSLATION OF "ALTO PROFILO" IS "HIGH PROFILE".

CLASS 35—ADVERTISING AND BUSINESS

FOR CONSULTING SERVICES IN THE FIELD OF BUSINESS STRATEGY AND MANAGEMENT (U.S. CLS. 100, 101 AND 102).

CLASS 42—SCIENTIFIC, COMPUTER AND LEGAL SERVICES

FOR CONSULTING SERVICES IN THE FIELD OF INFORMATION TECHNOLOGY (U.S. CLS. 100 AND 101).

SN 75-932,727. GLEMAIN, GERARD, 91450 SOISY SUR SEINE, FRANCE, FILED 2-24-2000.

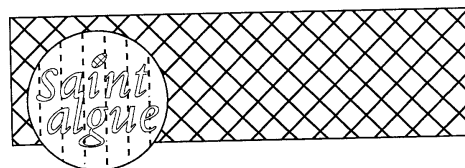

OWNER OF FRANCE REG. NO. 99781500, DATED 3-18-1999, EXPIRES 3-18-2009.

THE MARK CONSISTS OF A REDDISH-ORANGE RECTANGLE, BLUE CIRCLE, WHITE WORDING "SAINT ALGUE", AND A REDDISH-ORANGE DOT OVER THE LETTER "I".

THE ENGLISH TRANSLATION OF "ALGUE" IS "SEAWEED".

CLASS 3—COSMETICS AND CLEANING PREPARATIONS

FOR PERFUME, TOILET PRODUCTS, NAMELY TOILET MILK, TOILET SOAP; DEODORIZING SKIN SOAPS; SPRAYS; SKIN LOTIONS; SKIN TANNING LOTIONS, COSMETICS PRODUCTS, NAMELY POWDER, MAKE-UP AND MAKE-UP REMOVAL LOTIONS, EYE SHADOW, LIPSTICK, MASCARA; BEAUTY MASKS, COSMETIC PENCILS, ESSENTIAL OILS FOR PERSONAL USE; SLIMMING PRODUCTS, NAMELY SLIMMING CREAMS; PRODUCTS FOR THE BATH, NAMELY BATH GELS; BASE NAIL COAT, NAIL POLISH; HAIR CARE PRODUCTS, NAMELY NON-MEDICAL HAIR SHAMPOO, HAIR MOUSSE AND GEL, HAIR CONDITIONER, HAIR COLOR AND DYES, HAIR REMOVAL WAX, DEPILATORIES, SHAVING PREPARATIONS; AND COSMETIC KITS CONSISTING PRIMARILY OF LIPSTICK, FOUNDATION MAKEUP, AND MASCARA (U.S. CLS. 1, 4, 6, 50, 51 AND 52).

CLASS 35—ADVERTISING AND BUSINESS

FOR FRANCHISING, NAMELY OFFERING TECHNICAL ASSISTANCE IN THE ESTABLISHMENT AND OPERATION OF HAIR CARE SALONS AND BEAUTY SALONS, TRANSFER AND PROVISION OF KNOW HOW AND CONCESSION OF LICENSES FOR THE ESTABLISHMENT AND OPERATION OF HAIR CARE SALONS AND BEAUTY SALONS (U.S. CLS. 100, 101 AND 102).

CLASS 42—SCIENTIFIC, COMPUTER AND LEGAL SERVICES

FOR HAIR CARE SALONS; BEAUTY AND MASSAGE SALONS; COSMETIC RESEARCH FOR OTHERS; AND CONSULTATION SERVICES IN THE FIELD OF HAIRDRESSING, BEAUTY AND HYGIENE (U.S. CLS. 100 AND 101).

SN 75-933,088. VELOCITY SOLUTIONS, INC., ROCHESTER, NH. FILED 2-23-2000.

FINAL MILE COMMUNICATIONS

NO CLAIM IS MADE TO THE EXCLUSIVE RIGHT TO USE "COMMUNICATIONS", APART FROM THE MARK AS SHOWN.

CLASS 9—ELECTRICAL AND SCIENTIFIC APPARATUS

FOR COMPUTER HARDWARE, NAMELY CABLES (U.S. CLS. 21, 23, 26, 36 AND 38).

CLASS 37—CONSTRUCTION AND REPAIR

FOR INSTALLATION OF COMPUTER HARDWARE (U.S. CLS. 100, 103 AND 106).

CLASS 42—SCIENTIFIC, COMPUTER AND LEGAL SERVICES

FOR COMPUTER AND COMPUTER SOFTWARE SERVICES, NAMELY, CONSULTATION SERVICES, NETWORK DESIGN, INSTALLATION OF COMPUTER SOFTWARE; INTEGRATION OF COMPUTER SYSTEMS AND NETWORKS, INSTALLATION OF VOICE NETWORKS, AND DATA CONVERSION OF COMPUTER PROGRAMS AND INFORMATION (U.S. CLS. 100 AND 101).

SN 75-941,578. CAPRARI S.P.A., 41100 MODENA, ITALY, FILED 3-10-2000.

SPARESTUTOR

PRIORITY CLAIMED UNDER SEC. 44(D) ON ERPNCMNTY TM OFC APPLICATION NO. 1341072, FILED 12-4-2000, REG. NO. 1341072, DATED 12-4-2000, EXPIRES 12-4-2010.

CLASS 7—MACHINERY

FOR HYDRAULIC PUMPS FOR LIQUIDS AND PUMPS DRIVEN BY AN ELECTRIC MOTOR, NAMELY, VERTICAL LINESHAFTS PUMPS, HORIZONTAL SHAFT PUMPS, SUBMERSIBLE PUMPS, SUBMERSIBLE DRAINAGE AND SEWAGE PUMPS, CENTRIFUGAL PUMPS, PUMPS FOR IRRIGATION, INDUSTRIAL AND CIVIL APPLICATIONS, SUCTION PUMPS, SUMP PUMPS, PUMPS FOR WATERWORKS, PUMPS FOR WATER TREATMENT PLANTS, PUMPS FOR WATER PURIFICATION SYSTEMS, PUMPS FOR SEWAGE SYSTEMS, PUMPS FOR USE IN GREEN HOUSES AND GARDENING, PUMPS FOR FIRE FIGHTING SYSTEMS, PUMPS FOR DOMESTIC WATER SUPPLY, PUMPS FOR WATER SYSTEMS FOR LEISURE PARKS, PUMPS FOR STOCK FARMING, DRAINAGE PUMPS, PUMPS FOR SNOWMAKING SYSTEMS, PUMPS FOR INDUSTRIAL WASHING, PUMPS FOR CAR WASHING, PUMPS FOR AIR CONDITIONING SYSTEMS, PUMPS FOR LAND RECLAMATION, PUMPS FOR FISH-FARMING SYSTEMS, PUMPS FOR FOUNTAINS AND VERTICAL AND HORIZONTAL MONOBLOC PUMPS (U.S. CLS. 13, 19, 21, 23, 31, 34 AND 35).

CLASS 9—ELECTRICAL AND SCIENTIFIC APPARATUS

FOR PRERECORDED MAGNETIC TAPES, OPTICAL DISKS AND CD ROM'S FEATURING CATALOGS IN THE FIELD OF PUMPS; COMPUTER SOFTWARE ALLOWING THE USER TO SELECT SPARE PARTS OF PUMPS IN AN ELECTRONIC CATALOG; COMPUTER NETWORK COMMUNICATION SOFTWARE ALLOWING THE USER TO CONNECT A PUMP CATALOG ON A GLOBAL COMPUTER NETWORK OR INTERNAL COMPUTER NETWORK (U.S. CLS. 21, 23, 26, 36 AND 38).

CLASS 42—SCIENTIFIC, COMPUTER AND LEGAL SERVICES

FOR COMPUTER SERVICES, NAMELY, PROVIDING ON-LINE CATALOGS IN THE FIELD OF PUMPS (U.S. CLS. 100 AND 101).

SN 75-942,084. ITT INDUSTRIES, INC., WHITE PLAINS, NY. FILED 3-11-2000.

FLUID HANDLING UNIVERSITY

NO CLAIM IS MADE TO THE EXCLUSIVE RIGHT TO USE "FLUID HANDLING", APART FROM THE MARK AS SHOWN.

CLASS 35—ADVERTISING AND BUSINESS

FOR PROVIDING PRODUCT INFORMATION IN THE FIELD OF HYDRONICS VIA A WEBSITE ON A GLOBAL COMPUTER NETWORK (U.S. CLS. 100, 101 AND 102). FIRST USE 1-0-1999; IN COMMERCE 1-0-1999.

CLASS 37—CONSTRUCTION AND REPAIR

FOR PROVIDING INFORMATION ABOUT THE REPAIR AND MAINTENANCE OF HYDRONICS PRODUCTS VIA A WEBSITE ON A GLOBAL COMPUTER NETWORK (U.S. CLS. 100, 103 AND 106). FIRST USE 1-0-1999; IN COMMERCE 1-0-1999.

SN 75-942,569. COLOMA, DR.TOMAS ANTONIO SANTA, BUENOS AIRES, ARGENTINA, FILED 3-13-2000.

OLIGOBODY

CLASS 1—CHEMICALS

FOR SYNTHETIC ANTIBODIES CONSTRUCTED WITH OLIGONUCLEOTIDES USED AS REAGENTS IN RESEARCH (U.S. CLS. 1, 5, 6, 10, 26 AND 46).

CLASS 5—PHARMACEUTICALS

FOR SYNTHETIC ANTIBODIES CONSTRUCTED WITH OLIGONUCLEOTIDES USED AS REAGENTS IN MEDICAL DIAGNOSIS AND TREATMENT (U.S. CLS. 6, 18, 44, 46, 51 AND 52).

SN 75-942,981. CURON MEDICAL, INC., SUNNYVALE, CA. BY CHANGE OF NAME CONWAY STUART MEDICAL, INC., SUNNYVALE, CA. FILED 3-13-2000.

CURON MEDICAL

NO CLAIM IS MADE TO THE EXCLUSIVE RIGHT TO USE "MEDICAL", APART FROM THE MARK AS SHOWN.

CLASS 10—MEDICAL APPARATUS

FOR MEDICAL DEVICES AND INSTRUMENTS, NAMELY, RADIOFREQUENCY ELECTROSURGICAL ENERGY GENERATORS AND HANDHELD RADIOFREQUENCY ELECTROSURGICAL ENERGY DELIVERY DEVICES FOR TREATING GASTROESOPHAGEAL REFLUX DISEASE; RADIOFREQUENCY ELECTROSURGICAL ENERGY GENERATORS AND HANDHELD RADIOFREQUENCY ELECTROSURGICAL ENERGY DEVICES DELIVERY FOR TREATING INCONTINENCE; RADIOFREQUENCY ELECTROSURGICAL ENERGY GENERATORS AND HANDHELD RADIOFREQUENCY ELECTROSURGICAL ENERGY DELIVERY DEVICES FOR TREATING GASTROENTEROLOGICAL DISORDERS; AND PARTS AND ACCESSORIES FOR ALL OF THE FOREGOING MEDICAL DEVICES AND INSTRUMENTS (U.S. CLS. 26, 39 AND 44).

CLASS 41—EDUCATION AND ENTERTAINMENT

FOR EDUCATIONAL SERVICES, NAMELY, ORGANIZING AND CONDUCTING PHYSICIAN TRAINING, SEMINARS, WORKSHOPS AND CONFERENCES IN THE FIELD OF MEDICINE (U.S. CLS. 100, 101 AND 107).

CLASS 42—SCIENTIFIC, COMPUTER AND LEGAL SERVICES

FOR MEDICAL SERVICES, NAMELY, TECHNICAL AND PROFESSIONAL CONSULTATION IN THE FIELD OF MEDICAL DEVICES AND INSTRUMENTS, MEDICAL THERAPY, CONSULTATION WITH PHYSICIANS AND MEDICAL RESEARCHERS REGARDING MEDICAL APPARATUS AND SALE OF MEDICAL APPARATUS TO PHYSICIANS, CLINICS, AND HOSPITALS; PROVIDING ON-LINE PHYSICIAN INFORMATION AND PATIENT GUIDES IN THE FIELD OF MEDICINE (U.S. CLS. 100 AND 101).

SN 75-943,915. I:FAO AKTIENGESELLSCHAFT, D-60318 FRANKFURT AM MAIN, FED REP GERMANY, FILED 3-14-2000.

CYTRIC

CLASS 39—TRANSPORTATION AND STORAGE

FOR PROVIDING ON LINE TRAVEL AGENCY SERVICES, NAMELY, MAKING RESERVATIONS AND BOOKINGS FOR TRANSPORTATION (U.S. CLS. 100 AND 105).

CLASS 42—SCIENTIFIC, COMPUTER AND LEGAL SERVICES

FOR DESIGN AND CUSTOMIZATION OF SOFTWARE FOR OTHERS USED FOR MAKING BOOKINGS AND RESERVATIONS FOR TRANSPORTATION AND LODGINGS (U.S. CLS. 100 AND 101).

SN 75-979,585. PEAPOD, INC., SKOKIE, IL. FILED 9-17-1998.

PEAPOD PACKAGES

NO CLAIM IS MADE TO THE EXCLUSIVE RIGHT TO USE "PACKAGES", APART FROM THE MARK AS SHOWN.

CLASS 35—ADVERTISING AND BUSINESS

FOR ONLINE ORDERING SERVICES FEATURING A WIDE VARIETY OF CONSUMER GOODS; ONLINE SERVICES IN THE NATURE OF DISSEMINATION OF ADVERTISEMENTS AND PROMOTIONS FOR OTHERS IN THE FIELD OF SHOPPING FOR CONSUMER GOODS AND RELATED CONSUMER INFORMATION VIA ONLINE ELECTRONIC COMMUNICATIONS AND MULTI-USER GLOBAL COMMUNICATIONS NETWORKS; MARKET RESEARCH AND ANALYSIS SERVICES FOR OTHERS, PROVIDING INFORMATION RELATING TO ONLINE ORDERING OF A WIDE VARIETY OF CONSUMER GOODS VIA ONLINE ELECTRONIC COMMUNICATIONS AND MULTI-USER GLOBAL COMPUTER NETWORKS (U.S. CLS. 100, 101 AND 102).

FIRST USE 10-4-1999; IN COMMERCE 10-4-1999.

CLASS 39—TRANSPORTATION AND STORAGE

FOR DELIVERY SERVICES RENDERED VIA A SHIPPING CARRIER IN THE FIELDS OF A WIDE VARIETY OF PERSONAL CONSUMER GOODS AND OTHER HOUSEHOLD RELATED GOODS (U.S. CLS. 100 AND 105).

FIRST USE 10-4-1999; IN COMMERCE 10-4-1999.

SN 75-981,195. FLUENT BABY, INC., PALO ALTO, CA. FILED 9-22-2000.

BABY PORTUGUESE

NO CLAIM IS MADE TO THE EXCLUSIVE RIGHT TO USE "BABY", APART FROM THE MARK AS SHOWN.

CLASS 18—LEATHER GOODS

FOR BABY-ORIENTED TOTE BAGS AND BACKPACKS (U.S. CLS. 1, 2, 3, 22 AND 41).

CLASS 25—CLOTHING

FOR CLOTHING FOR BABIES, INFANTS AND TODDLERS, NAMELY, T-SHIRTS, SWEATSHIRTS AND HATS (U.S. CLS. 22 AND 39).

SN 76-003,325. ZNETIX, INC., BAINBRIDGE ISLAND, WA. BY CHANGE OF NAME PROJECT X, INC., BAINBRIDGE ISLAND, WA. FILED 3-17-2000.

PHYSIOTRAK

CLASS 41—EDUCATION AND ENTERTAINMENT

FOR HEALTH CLUBS PROVIDING PREVENTIVE CARE AND EXERCISE PRESCRIPTION FACILITIES INTEGRATING PRE- AND POST-OPERATIVE MEDICAL MODALITIES; PHYSICAL FITNESS INSTRUCTION; PHYSICAL EDUCATION SERVICES; PROVIDING FACILITIES FOR RECREATIONAL ACTIVITIES (U.S. CLS. 100, 101 AND 107).

CLASS 42—SCIENTIFIC, COMPUTER AND LEGAL SERVICES

FOR HEALTH CARE, NAMELY CARDIOLOGY, ORTHOPEDICS, NEUROLOGY AND GENERAL HEALTH ASSESSMENT; CHIROPRACTIC SERVICES; MASSAGE THERAPY; SPORTS PHYSICAL THERAPY; PHYSICAL REHABILITATION; FOOD NUTRITION CONSULTATION; PHYSICAL FITNESS CONSULTATION; COUNSELING IN THE FIELD OF HEALTH, MAINTAINING FILES AND RECORDS CONCERNING THE GENERAL HEALTH AND MEDICAL CONDITION OF INDIVIDUALS AND SPECIFICALLY KEEPING SUCH RECORDS IN A FORMAT DISTRIBUTABLE ON A GLOBAL COMMUNICATIONS DIGITAL NETWORK (U.S. CLS. 100 AND 101).

SN 76-012,274. COUTRELIS & ASSOCIES, 75116 PARIS, FRANCE, FILED 3-29-2000.

**CLASS 16—PAPER GOODS AND PRINTED MATTER**

FOR PRINTED MATERIALS, NAMELY, PUBLICATION PAPERS, MEMORANDUM BOOKS, AND BOOKS IN THE FIELD OF LAW; PRINTED INSTRUCTION, EDUCATIONAL, AND TEACHING MATERIALS IN THE FIELD OF LAW (U.S. CLS. 2, 5, 22, 23, 29, 37, 38 AND 50).

FIRST USE 7-16-1999; IN COMMERCE 7-16-1999.

CLASS 41—EDUCATION AND ENTERTAINMENT

FOR ARRANGING AND CONDUCTING EDUCATIONAL CONFERENCES, CONDUCTING WORKSHOPS AND SEMINARS IN THE FIELD OF LAW (U.S. CLS. 100, 101 AND 107).

FIRST USE 12-16-1999; IN COMMERCE 12-16-1999.

CLASS 42—SCIENTIFIC, COMPUTER AND LEGAL SERVICES

FOR LEGAL SERVICES AND LEGAL COUNSELING; LOBBYING SERVICES, NAMELY, PROMOTING THE INTERESTS OF INTERNATIONAL COMPANIES IN THE FIELD OF POLITICS, LEGISLATION, AND REGULATION (U.S. CLS. 100 AND 101).

FIRST USE 2-0-1997; IN COMMERCE 3-10-1997.

SN 76-003,870. RELATABLE, LLC., ALEXANDRIA, VA. FILED 3-20-2000.



COLOR IS PART OF THE MARK TO THIS EXTENT: THE INNER CIRCLE IS A LIGHTER SHADE OF GRAY, WHEREAS THE FOUR CIRCLES INTERSECTING THE INNER CIRCLE ARE DARKER GRAY AND THE DARKER GRAY OVERLAYS PORTIONS OF THE INNER CIRCLE CORRESPONDING TO THE FOUR CIRCLES.

CLASS 9—ELECTRICAL AND SCIENTIFIC APPARATUS

FOR COMPUTER SOFTWARE FOR TRACKING AND CUSTOMIZING CONTENT AND COMMERCE OFFERINGS, AND GATHERING MARKETING DATA AND INFORMATION FOR BUSINESSES, BASED ON PERSONAL PREFERENCES AND CONTENT CHARACTERISTICS FOR USE IN BROWSER PLUG-INS, WEB MUSIC PLAYERS, DESKTOP MUSIC PLAYERS, WEB SITES, CABLE TELEVISION AND BROADBAND PROGRAM DELIVERY AND CHANNEL SWITCHING INTERFACES, SMART PHONES AND OTHER WIRELESS HANDHELD DEVICE INTERFACES (U.S. CLS. 21, 23, 26, 36 AND 38).

CLASS 35—ADVERTISING AND BUSINESS

FOR TRACKING, CAPTURING AND CUSTOMIZING DATA AND INFORMATION FOR OTHER BUSINESSES BASED ON PERSONAL USER PREFERENCES FOR PERSONALIZATION AND RECOMMENDATION PURPOSES FOR COMPUTER DYNAMIC MUSIC PLAYLIST GENERATION, FOR COMPUTER DYNAMIC PROGRAM GUIDE GENERATION, FOR WEB SITE AND WEB INTERFACE CUSTOMIZATION AND PERSONALIZATION FOR ADVERTISING PURPOSES, FOR WIRELESS SERVICES PERSONALIZATION, AND FOR CUSTOMIZED PROGRAMMING SERVICES IN TELEVISION AND AUDIO CHANNELS ALL RELATING TO ADVERTISING AND MARKETING (U.S. CLS. 100, 101 AND 102).

SN 76-018,379. ELFIN EQUITY COMPANY, L.L.C., ELMHURST, IL. FILED 4-4-2000.

HEARTY CREATIONS**CLASS 29—MEATS AND PROCESSED FOODS**

FOR PACKAGED MEAL KITS CONSISTING PRIMARILY OF VEGETABLES WITH NOODLES, SEASONING AND/OR BREAD CRUMBS, AND A PIE CRUST (U.S. CL. 46).

CLASS 30—STAPLE FOODS

FOR PACKAGED MEAL KITS CONSISTING PRIMARILY OF NOODLES WITH VEGETABLES, SEASONING AND/OR BREAD CRUMBS, AND A PIE CRUST (U.S. CL. 46).

SN 76-018,445. BTP, PLC, MANCHESTER, UNITED KINGDOM, FILED 4-5-2000.



CLASS 1—CHEMICALS

FOR CHEMICALS USED IN THE MANUFACTURE OF DRUGS, PAINT ADDITIVES, DEICERS, COSMETICS, TOILETRIES, AGRICULTURAL CROP TREATMENT FORMULATIONS, AGRICULTURAL CHEMICAL INTERMEDIATES, BIOCIDES, SILICONES, CIRCUIT BOARDS, PHARMACEUTICAL INTERMEDIATES, BULK ACTIVE COMPOUNDS, ELECTRONIC DEVICES, COMPOSITE MATERIALS, CONSTRUCTION MATERIALS, AND RUBBER (U.S. CLS. 1, 5, 6, 10, 26 AND 46).

CLASS 5—PHARMACEUTICALS

FOR PHARMACEUTICAL PREPARATIONS USED TO TREAT HEART CONDITIONS AND CANCERS; SANITIZERS FOR HOUSEHOLD USE; VETERINARY PREPARATIONS USED IN CONTROLLING DISEASE WITHIN AND PROVIDING NOURISHMENT FOR LIVESTOCK (U.S. CLS. 6, 18, 44, 46, 51 AND 52).

SN 76-018,834. CHEN, DAVID TAI-AN, RICHMOND, BC, CANADA, FILED 4-5-2000.

ANSER

CLASS 2—PAINTS

FOR FILLED INK JET CARTRIDGES FOR INDUSTRIAL-GRADE INK JET PRINTERS (U.S. CLS. 6, 11 AND 16).
FIRST USE 10-14-1997; IN COMMERCE 10-14-1997.

CLASS 9—ELECTRICAL AND SCIENTIFIC APPARATUS

FOR INDUSTRIAL-GRADE INK JET PRINTERS AND ACCESSORIES, NAMELY PRINT HEADS (U.S. CLS. 21, 23, 26, 36 AND 38).
FIRST USE 10-14-1997; IN COMMERCE 10-14-1997.

SN 76-018,933. TRIBUNE INTERACTIVE, INC., CHICAGO, IL, FILED 4-5-2000.

CHICAGOSPORTS.COM

CLASS 16—PAPER GOODS AND PRINTED MATTER

FOR PRINTED MATERIALS, NAMELY, MAGAZINES, NEWSPAPERS AND NEWSLETTERS FEATURING A WIDE VARIETY OF SPORTS INFORMATION (U.S. CLS. 2, 5, 22, 23, 29, 37, 38 AND 50).

CLASS 41—EDUCATION AND ENTERTAINMENT

FOR PROVIDING A WIDE VARIETY OF SPORTS INFORMATION VIA A GLOBAL COMPUTER NETWORK AND ENTERTAINMENT SERVICES IN THE NATURE OF AN ONGOING SERIES OF TELEVISION PROGRAMS FEATURING A WIDE VARIETY OF SPORTS INFORMATION (U.S. CLS. 100, 101 AND 107).

SN 76-023,713. COALITION OF SERVICE INDUSTRIES RESEARCH AND EDUCATION FOUNDATION, THE, WASHINGTON, D.C., DC, FILED 4-12-2000.

WORLD SERVICES CONGRESS

NO CLAIM IS MADE TO THE EXCLUSIVE RIGHT TO USE "WORLD SERVICES", APART FROM THE MARK AS SHOWN.

CLASS 16—PAPER GOODS AND PRINTED MATTER

FOR PUBLICATIONS, NAMELY, BOOKS, MAGAZINES, NEWSLETTERS AND PAMPHLETS ON THE SUBJECT OF TRADE ISSUES (U.S. CLS. 2, 5, 22, 23, 29, 37, 38 AND 50).
FIRST USE 2-0-1999; IN COMMERCE 2-0-1999.

CLASS 35—ADVERTISING AND BUSINESS

FOR COMPUTER SERVICES, NAMELY, PROVIDING ON-LINE INFORMATION PERTAINING TO WORLD TRADE ISSUES WITHIN THE SERVICE INDUSTRIES (U.S. CLS. 100, 101 AND 102).
FIRST USE 11-0-1998; IN COMMERCE 11-0-1998.

SN 76-026,141. GENESIS PHARMACEUTICAL, INC., HAZEL PARK, MI, FILED 4-17-2000.

E-DISPENSING

CLASS 35—ADVERTISING AND BUSINESS

FOR ON-LINE RETAIL STORE SERVICES FEATURING COSMETIC; PLACING AND PREPARING ADVERTISEMENTS FOR OTHERS; CO-OPERATIVE ADVERTISING AND MARKETING; PROVIDING INFORMATION ON MEDICAL PRODUCTS VIA INTERNET (U.S. CLS. 100, 101 AND 102).
FIRST USE 3-8-2000; IN COMMERCE 3-8-2000.

CLASS 42—SCIENTIFIC, COMPUTER AND LEGAL SERVICES

FOR PROVIDING MEDICAL INFORMATION, NAMELY, MEDICAL PROCEDURES AND METHODS (U.S. CLS. 100 AND 101).
FIRST USE 3-8-2000; IN COMMERCE 3-8-2000.

SN 76-026,663. SHOP AT HOME, INC., ANTIOCH, TN. FILED 4-14-2000.

PEACE OF MIND GUARANTEE

NO CLAIM IS MADE TO THE EXCLUSIVE RIGHT TO USE "GUARANTEE", APART FROM THE MARK AS SHOWN.

CLASS 35—ADVERTISING AND BUSINESS

FOR ON-LINE ORDERING SERVICES FEATURING WHOLESALE AND RETAIL STORE SERVICES IN THE FIELD OF ANTIQUES, MEMORABILIA, AND OTHER COLLECTIBLE MERCHANDISE AND A WIDE VARIETY OF CONSUMER GOODS; PROVIDING ON-LINE TRADING SERVICES IN WHICH SELLER POSTS ITEMS TO BE AUCTIONED AND BIDDING IS DONE ELECTRONICALLY (U.S. CLS. 100, 101 AND 102).

CLASS 36—INSURANCE AND FINANCIAL

FOR PROVIDING EXTENDED WARRANTY CONTRACTS FOR ANTIQUES, MEMORABILIA, OTHER COLLECTIBLE MERCHANDISE, AND A WIDE VARIETY OF CONSUMER GOODS (U.S. CLS. 100, 101 AND 102).

CLASS 42—SCIENTIFIC, COMPUTER AND LEGAL SERVICES

FOR COMPUTER SERVICES, NAMELY, PROVIDING SEARCH ENGINES FOR OBTAINING DATA ON A GLOBAL COMPUTER NETWORK (U.S. CLS. 100 AND 101).

SN 76-027,032. CHUM LIMITED, TORONTO, ONTARIO, M4T 1Y1, CANADA, FILED 4-17-2000.

NEXT.NEW.NOW

PRIORITY CLAIMED UNDER SEC. 44(D) ON CANADA APPLICATION NO. 1032482, FILED 10-15-1999.

CLASS 38—COMMUNICATION

FOR TELEVISION BROADCASTING SERVICES; PROVIDING ON-LINE CHAT ROOMS FOR TRANSMISSION OF MESSAGES AMONG COMPUTER USERS CONCERNING NEW PRODUCT DESIGN, TECHNOLOGY, MEDIA, SCIENCE, SPIRITUALITY AND ART; ELECTRONIC MAIL SERVICES; BROADCASTING PROGRAMS VIA A GLOBAL COMPUTER NETWORK; AND SATELLITE TRANSMISSION SERVICES (U.S. CLS. 100, 101 AND 104).

CLASS 41—EDUCATION AND ENTERTAINMENT

FOR ENTERTAINMENT IN THE NATURE OF ONGOING TELEVISION PROGRAMS IN THE FIELDS OF NEW PRODUCT DESIGN, TECHNOLOGY, MEDIA, SCIENCE, SPIRITUALITY AND ART; AND PRODUCTION AND PROGRAMMING OF TELEVISION PROGRAMS CABLE TELEVISION PROGRAMMING SERVICES; TELEVISION PROGRAMMING SERVICES, DISTRIBUTION OF TELEVISION PROGRAMMING TO CABLE TELEVISION SYSTEMS (U.S. CLS. 100, 101 AND 107).

SN 76-027,983. WASHINGTONPOST.NEWSWEEK INTERACTIVE COMPANY, LLC, ARLINGTON, VA. BY CHANGE OF NAME WASHINGTONPOST.NEWSWEEK INTERACTIVE COMPANY, ARLINGTON, VA. FILED 4-18-2000.

KIDSPOST.COM

CLASS 38—COMMUNICATION

FOR PROVIDING ELECTRONIC BULLETIN BOARDS AND CHAT ROOMS FOR TRANSMISSION OF MESSAGES AMONG COMPUTER USERS COVERING A WIDE VARIETY OF INFORMATION GENERALLY FOUND IN NEWSPAPERS FOR GENERAL CIRCULATION, AND INFORMATION OF INTEREST TO CHILDREN; PROVIDING ONLINE FACILITIES FOR INTERACTION WITH OTHER COMPUTER USERS CONCERNING TOPICS OF GENERAL INTEREST VIA LIST SERVES (U.S. CLS. 100, 101 AND 104).

CLASS 41—EDUCATION AND ENTERTAINMENT

FOR ENTERTAINMENT SERVICES, NAMELY, PROVIDING ONLINE COMPUTER GAMES THAT MAY BE ACCESSED NETWORK-WIDE BY NETWORK USERS; PROVIDING INFORMATION IN THE FIELDS OF GAMES, TOYS, SPORTS, EDUCATION, AND ENTERTAINMENT BY MEANS OF A GLOBAL COMPUTER NETWORK (U.S. CLS. 100, 101 AND 107).

CLASS 42—SCIENTIFIC, COMPUTER AND LEGAL SERVICES

FOR COMPUTER SERVICES, NAMELY, PROVIDING INFORMATION GENERALLY FOUND IN NEWSPAPERS FOR GENERAL CIRCULATION AND INFORMATION OF INTEREST TO CHILDREN; PROVIDING ELECTRONIC DELIVERY OF CUSTOMIZED NEWS AND INFORMATION GENERALLY FOUND IN NEWSPAPERS FOR GENERAL CIRCULATION AND INFORMATION OF INTEREST TO CHILDREN (U.S. CLS. 100 AND 101).

SN 76-029,154. MARMOT MOUNTAIN LTD., SANTA ROSA, CA. FILED 4-19-2000.

DRICLIME

CLASS 18—LEATHER GOODS

FOR BACKPACKS (U.S. CLS. 1, 2, 3, 22 AND 41).
FIRST USE 0-0-1999; IN COMMERCE 0-0-1999.

CLASS 20—FURNITURE AND ARTICLES NOT OTHERWISE CLASSIFIED

FOR SLEEPING BAGS (U.S. CLS. 2, 13, 22, 25, 32 AND 50).
FIRST USE 0-0-1995; IN COMMERCE 0-0-1995.

CLASS 25—CLOTHING

FOR CLOTHING, NAMELY JACKETS, PANTS, SWEATERS, TIGHTS, CLOTH BIBS, UNDERWEAR, HATS, GLOVES AND PARKAS (U.S. CLS. 22 AND 39).
FIRST USE 0-0-1991; IN COMMERCE 0-0-1991.

SN 76-029,156. MARMOT MOUNTAIN LTD., SANTA ROSA, CA. FILED 4-19-2000.

MARMOT FOR LIFE

OWNER OF U.S. REG. NOS. 1,461,945 AND 1,462,942.

CLASS 18—LEATHER GOODS

FOR BACKPACKS (U.S. CLS. 1, 2, 3, 22 AND 41).
FIRST USE 0-0-1999; IN COMMERCE 0-0-1999.

CLASS 20—FURNITURE AND ARTICLES NOT OTHERWISE CLASSIFIED

FOR SLEEPING BAGS (U.S. CLS. 2, 13, 22, 25, 32 AND 50).
FIRST USE 0-0-1996; IN COMMERCE 0-0-1996.

CLASS 22—CORDAGE AND FIBERS

FOR TENTS (U.S. CLS. 1, 2, 7, 19, 22, 42 AND 50).
FIRST USE 0-0-1997; IN COMMERCE 0-0-1997.

CLASS 25—CLOTHING

FOR CLOTHING, NAMELY JACKETS, PANTS, SWEATERS, SHIRTS, SHORTS, CLOTH BIBS, HATS, GLOVES, PARKAS (U.S. CLS. 22 AND 39).
FIRST USE 0-0-1996; IN COMMERCE 0-0-1996.

SN 76-029,157. MARMOT MOUNTAIN LTD., SANTA ROSA, CA. FILED 4-19-2000.

MARMOT

OWNER OF U.S. REG. NOS. 1,461,945 AND 1,462,942.

CLASS 18—LEATHER GOODS

FOR LUGGAGE, BACKPACKS, DUFFEL BAGS (U.S. CLS. 1, 2, 3, 22 AND 41).

CLASS 20—FURNITURE AND ARTICLES NOT OTHERWISE CLASSIFIED

FOR SLEEPING BAGS, BED PADS FOR SLEEPING BAGS (U.S. CLS. 2, 13, 22, 25, 32 AND 50).

CLASS 22—CORDAGE AND FIBERS

FOR TENTS AND BIVY SACKS (U.S. CLS. 1, 2, 7, 19, 22, 42 AND 50).

CLASS 25—CLOTHING

FOR CLOTHING, NAMELY, SHORTS, SHIRTS, JACKETS, PANTS, SWEATERS, CLOTH BIBS, HATS, GLOVES, PARKAS AND FOOTWEAR (U.S. CLS. 22 AND 39).

SN 76-029,159. MARMOT MOUNTAIN LTD., SANTA ROSA, CA. FILED 4-19-2000.

MEMBRAIN

OWNER OF U.S. REG. NO. 2,074,576.

CLASS 20—FURNITURE AND ARTICLES NOT OTHERWISE CLASSIFIED

FOR SLEEPING BAGS (U.S. CLS. 2, 13, 22, 25, 32 AND 50).
FIRST USE 0-0-1999; IN COMMERCE 0-0-1999.

CLASS 25—CLOTHING

FOR CLOTHING, NAMELY JACKETS, CLOTH BIBS, SWEATERS, PANTS, GLOVES, PARKAS (U.S. CLS. 22 AND 39).
FIRST USE 0-0-1996; IN COMMERCE 0-0-1996.

SN 76-029,160. ARDIS COMPANY, RESTON, VA. FILED 4-19-2000.



CLASS 9—ELECTRICAL AND SCIENTIFIC APPARATUS

FOR TELECOMMUNICATIONS EQUIPMENT, NAMELY, TELEPHONES AND WIRELESS AND MOBILE TELEPHONES FOR VOICE, DATA, AND FAX COMMUNICATIONS; HAND-HELD DEVICES FOR WIRELESS ACCESS TO GLOBAL COMMUNICATIONS NETWORKS AND E-MAIL; PAGERS; WIRELESS PHONES; COMPUTERS, COMPUTER TERMINALS, COMPUTER SERVERS, COMPUTER BUFFERS, AND COMPUTER HARDWARE FOR USE IN THE TELECOMMUNICATIONS INDUSTRY; TELEPHONE MODEMS AND RADIO MODEMS; INTEGRATED CIRCUIT MEMORIES; COMPUTER SOFTWARE FOR USE IN WIRELESS COMMUNICATIONS SYSTEMS; COMPUTER PROGRAMS UTILIZING RADIO COMMUNICATIONS NETWORKS, LOCAL AND/OR WIDE AREA COMMUNICATION NETWORKS, TERMINALS AND PAGERS FOR FACILITATING WIRELESS RADIO COMMUNICATION; COMPUTER PROGRAMS FOR RECORDING, PROCESSING, RECEIVING, REPRODUCING, TRANSMITTING, MODIFYING, COMPRESSING, BROADCASTING, MERGING OR ENHANCING DATA FOR USE IN WIRELESS COMMUNICATIONS; DATA COMPRESSION SOFTWARE (U.S. CLS. 21, 23, 26, 36 AND 38).

CLASS 16—PAPER GOODS AND PRINTED MATTER

FOR PUBLICATIONS, NAMELY, BOOKS, MAGAZINES, PAMPHLETS, BROCHURES, CIRCULARS, ALL FEATURING INFORMATION REGARDING THE TELECOMMUNICATIONS INDUSTRY (U.S. CLS. 2, 5, 22, 23, 29, 37, 38 AND 50).

CLASS 35—ADVERTISING AND BUSINESS

FOR BUSINESS CONSULTING SERVICES IN THE FIELD OF TELECOMMUNICATIONS; PROMOTING THE GOODS AND SERVICES OF OTHERS THROUGH THE PROVISION OF CONSULTING SERVICES IN THE FIELD OF WIRELESS COMMUNICATIONS; PROVIDING BUSINESS AND COMMERCIAL CONSULTATION AND ADVISORY SERVICES RELATING TO COMPUTERS, COMPUTER SOFTWARE, AND COMMUNICATIONS NETWORKS AND INFORMATION TECHNOLOGY USE IN THE FIELD OF TELECOMMUNICATIONS GENERALLY AND WIRELESS COMMUNICATIONS; ARRANGING AND CONDUCTING BUSINESS AND COMMERCIAL SEMINARS, CONVENTIONS AND CONFERENCES RELATED TO WIRELESS COMMUNICATIONS AND THE TELECOMMUNICATIONS INDUSTRY; PROVIDING COMPUTERIZED BUSINESS INFORMATION VIA A WIRELESS COMMUNICATIONS NETWORK (U.S. CLS. 100, 101 AND 102).

CLASS 38—COMMUNICATION

FOR TELECOMMUNICATIONS SERVICES, NAMELY WIRELESS COMMUNICATIONS SERVICES; SATELLITE TELECOMMUNICATIONS SERVICE, NAMELY THE PROVISION AND TRANSMISSION OF SATELLITE AND TERRESTRIAL TELECOMMUNICATIONS SERVICES; PROVIDING SATELLITE AND TERRESTRIAL SERVICES FOR MOBILE USERS FOR VOICE, DATA AND FAX COMMUNICATIONS; RADIO COMMUNICATION SERVICES; PROVIDING COMPUTER COMMUNICATIONS AND DATA TRANSMISSION SERVICES VIA RADIO AT REMOTE LOCATIONS; WIRELESS TRANSMISSION AND NETWORKING OF MESSAGES, COMMUNICATIONS AND OF DATA; ELECTRONIC MAIL SERVICES; PAGING SERVICES; RENTAL OF COMMUNICATIONS EQUIPMENT; DATA COMMUNICATION SERVICES, NAMELY WIRELESS DATA COMMUNICATIONS SERVICES; ELECTRONIC TRANSMISSION OF INFORMATION RELATED TO TELECOMMUNICATIONS AND RELATED BUSINESS AND COMMERCIAL ACTIVITIES AND ISSUES VIA GLOBAL COMPUTER NETWORKS (U.S. CLS. 100, 101 AND 104).

CLASS 42—SCIENTIFIC, COMPUTER AND LEGAL SERVICES

FOR CONSULTING AND ADVISORY SERVICES IN THE FIELD OF TELECOMMUNICATIONS GENERALLY, WIRELESS COMMUNICATIONS, COMPUTERS, COMPUTER SOFTWARE, COMPUTER AND COMMUNICATIONS NETWORKS AND INFORMATION TECHNOLOGY; COMPUTER SYSTEM INTEGRATION SERVICES; COMPUTER INTERCOMMUNICATION SERVICES, NAMELY, THE PROVISION OF CONSULTING SERVICES IN THE FIELD OF WIRELESS TELECOMMUNICATIONS (U.S. CLS. 100 AND 101).

CLASS 9—ELECTRICAL AND SCIENTIFIC APPARATUS

FOR TELECOMMUNICATIONS EQUIPMENT, NAMELY, TELEPHONES AND WIRELESS AND MOBILE TELEPHONES FOR VOICE, DATA, AND FAX COMMUNICATIONS; HAND-HELD DEVICES FOR WIRELESS ACCESS TO GLOBAL COMMUNICATIONS NETWORKS AND E-MAIL; PAGERS; WIRELESS PHONES; COMPUTERS, COMPUTER TERMINALS, COMPUTER SERVERS, COMPUTER BUFFERS, AND COMPUTER HARDWARE FOR USE IN THE TELECOMMUNICATIONS INDUSTRY; TELEPHONE MODEMS AND RADIO MODEMS; INTEGRATED CIRCUIT MEMORIES; COMPUTER SOFTWARE FOR USE IN WIRELESS COMMUNICATIONS SYSTEMS; COMPUTER PROGRAMS UTILIZING RADIO COMMUNICATIONS NETWORKS, LOCAL AND/OR WIDE AREA COMMUNICATION NETWORKS, TERMINALS AND PAGERS FOR FACILITATING WIRELESS RADIO COMMUNICATION; COMPUTER PROGRAMS FOR RECORDING, PROCESSING, RECEIVING, REPRODUCING, TRANSMITTING, MODIFYING, COMPRESSING, BROADCASTING, MERGING OR ENHANCING DATA FOR USE IN WIRELESS COMMUNICATIONS; DATA COMPRESSION SOFTWARE (U.S. CLS. 21, 23, 26, 36 AND 38).

CLASS 16—PAPER GOODS AND PRINTED MATTER

FOR PUBLICATIONS, NAMELY, BOOKS, MAGAZINES, PAMPHLETS, BROCHURES, CIRCULARS, ALL FEATURING INFORMATION REGARDING THE TELECOMMUNICATIONS INDUSTRY (U.S. CLS. 2, 5, 22, 23, 29, 37, 38 AND 50).

CLASS 35—ADVERTISING AND BUSINESS

FOR BUSINESS CONSULTING SERVICES IN THE FIELD OF TELECOMMUNICATIONS; PROMOTING THE GOODS AND SERVICES OF OTHERS THROUGH THE PROVISION OF CONSULTING SERVICES IN THE FIELD OF WIRELESS COMMUNICATIONS; PROVIDING BUSINESS AND COMMERCIAL CONSULTATION AND ADVISORY SERVICES RELATING TO COMPUTERS, COMPUTER SOFTWARE, AND COMMUNICATIONS NETWORKS AND INFORMATION TECHNOLOGY USE IN THE FIELD OF TELECOMMUNICATIONS GENERALLY AND WIRELESS COMMUNICATIONS; ARRANGING AND CONDUCTING BUSINESS AND COMMERCIAL SEMINARS, CONVENTIONS AND CONFERENCES RELATED TO WIRELESS COMMUNICATIONS AND THE TELECOMMUNICATIONS INDUSTRY; PROVIDING COMPUTERIZED BUSINESS INFORMATION VIA A WIRELESS COMMUNICATIONS NETWORK (U.S. CLS. 100, 101 AND 102).

CLASS 38—COMMUNICATION

FOR TELECOMMUNICATIONS SERVICES, NAMELY WIRELESS COMMUNICATIONS SERVICES; SATELLITE TELECOMMUNICATIONS SERVICE, NAMELY THE PROVISION AND TRANSMISSION OF SATELLITE AND TERRESTRIAL TELECOMMUNICATIONS SERVICES; PROVIDING SATELLITE AND TERRESTRIAL SERVICES FOR MOBILE USERS FOR VOICE, DATA AND FAX COMMUNICATIONS; RADIO COMMUNICATION SERVICES; PROVIDING COMPUTER COMMUNICATIONS AND DATA TRANSMISSION SERVICES VIA RADIO AT REMOTE LOCATIONS; WIRELESS TRANSMISSION AND NETWORKING OF MESSAGES, COMMUNICATIONS AND OF DATA; ELECTRONIC MAIL SERVICES; PAGING SERVICES; RENTAL OF COMMUNICATIONS EQUIPMENT; DATA COMMUNICATION SERVICES, NAMELY WIRELESS DATA COMMUNICATIONS SERVICES; ELECTRONIC TRANSMISSION OF INFORMATION RELATED TO TELECOMMUNICATIONS AND RELATED BUSINESS AND COMMERCIAL ACTIVITIES AND ISSUES VIA GLOBAL COMPUTER NETWORKS (U.S. CLS. 100, 101 AND 104).

SN 76-029,161. ARDIS COMPANY, RESTON, VA. FILED 4-19-2000.

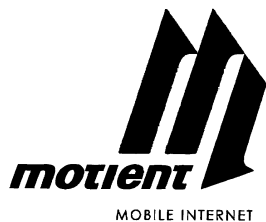

NO CLAIM IS MADE TO THE EXCLUSIVE RIGHT TO USE "MOBILE INTERNET", APART FROM THE MARK AS SHOWN.

CLASS 42—SCIENTIFIC, COMPUTER AND LEGAL SERVICES

FOR CONSULTING AND ADVISORY SERVICES IN THE FIELD OF TELECOMMUNICATIONS GENERALLY, WIRELESS COMMUNICATIONS, COMPUTERS, COMPUTER SOFTWARE, COMPUTER AND COMMUNICATIONS NETWORKS AND INFORMATION TECHNOLOGY; COMPUTER SYSTEM INTEGRATION SERVICES; COMPUTER INTERCOMMUNICATION SERVICES, NAMELY, THE PROVISION OF CONSULTING SERVICES IN THE FIELD OF WIRELESS TELECOMMUNICATIONS (U.S. CLS. 100 AND 101).

SN 76-033,793. GAPI S.R.L., BERGAMO, ITALY, FILED 4-26-2000.

GAPI

PRIORITY CLAIMED UNDER SEC. 44(D) ON ITALY APPLICATION NO. MI2000C00224, FILED 2-29-2000, REG. NO. 00817616, DATED 6-12-2000, EXPIRES 6-12-2010.

CLASS 2—PAINTS

FOR CERAMIC AND VITREOUS ENAMELS FOR INDUSTRIAL AND CHEMICAL TANKS AND PIPING; ENAMELS FOR POTTERY, INDUSTRIAL EQUIPMENT AND MACHINERY, AUTOMOBILES, MODEL AIRPLANES AND MODEL CARS; ENAMELS IN THE NATURE OF HOUSE PAINT; PAINTS FOR ARTS AND CRAFTS; HOUSE PAINT; EXTERIOR PAINT; INTERIOR PAINT; PAINT FOR INDUSTRIAL EQUIPMENT AND MACHINERY, MODEL AIRPLANES AND MODEL CARS; PAINT FOR USE IN THE MANUFACTURE OF AUTOMOBILES, CERAMICS AND FURNITURE (U.S. CLS. 6, 11 AND 16).

CLASS 17—RUBBER GOODS

FOR SEALS; SEMI-FINISHED PLASTIC IN THE FORM OF SHEETS, PLATES, RIBBONS OR RODS FOR USE IN MANUFACTURING; EXTRUDED SECTION MEMBERS OF PLASTIC OR NON-METALLIC COMPOSITE MATERIAL FOR GENERAL INDUSTRIAL USE (U.S. CLS. 1, 5, 12, 13, 35 AND 50).

CLASS 19—NON-METALLIC BUILDING MATERIALS

FOR NON-METALLIC RIGID AND FLEXIBLE TUBES FOR BUILDING (U.S. CLS. 1, 12, 33 AND 50).

SN 76-029,165. MARMOT MOUNTAIN LTD., SANTA ROSA, CA. FILED 4-19-2000.

DRICLIME**CLASS 24—FABRICS**

FOR FABRIC USED IN THE MANUFACTURE OF CLOTHING, TENTS, SLEEPING BAGS, BACKPACKS AND CAMPING GEAR (U.S. CLS. 42 AND 50).

CLASS 25—CLOTHING

FOR CLOTHING, NAMELY, JACKETS, PANTS, SWEATERS, CLOTH BIBS, HATS, GLOVES, PARKAS, SHORTS, SHIRTS AND FOOTWEAR (U.S. CLS. 22 AND 39).

SN 76-033,503. RIXONWAY KITCHENS LIMITED, DEWSBURY WF12 7RD, UNITED KINGDOM, FILED 4-25-2000.

KEENCOST

PRIORITY CLAIMED UNDER SEC. 44(D) ON UNITED KINGDOM APPLICATION NO. 2214178, FILED 11-12-1999, REG. NO. 2214178, DATED 11-12-1999, EXPIRES 11-12-2009.

CLASS 11—ENVIRONMENTAL CONTROL APPARATUS

FOR ELECTRIC AND GAS OVENS; GAS BURNERS; REFRIGERATORS; FREEZERS; WATER CLOSETS; SINKS; BATH TUBS; SHOWERS; BIDETS; VENTILATING HOODS FOR COOKING; LIGHTING EQUIPMENT, NAMELY, FLUORESCENT AND INCANDESCENT LIGHT FIXTURES; PARTS AND FITTINGS FOR ALL THE AFORESAID GOODS; ALL THE ABOVE GOODS FOR DOMESTIC OR HOUSEHOLD USE (U.S. CLS. 13, 21, 23, 31 AND 34).

CLASS 20—FURNITURE AND ARTICLES NOT OTHERWISE CLASSIFIED

FOR FITTED KITCHEN CUPBOARDS; FITTED KITCHEN DRAWERS; COUNTER TOPS FOR KITCHENS; KITCHEN TABLES; KITCHEN CHAIRS; PICTURE FRAMES; MIRRORS; PARTS AND FITTINGS FOR ALL THE AFORESAID GOODS (U.S. CLS. 2, 13, 22, 25, 32 AND 50).

SN 76-034,189. HAGAR, ELDAD, LOS ANGELES, CA. FILED 4-25-2000.

COMILLION**CLASS 35—ADVERTISING AND BUSINESS**

FOR RETAIL STORE SERVICES AND ELECTRONIC RETAILING SERVICES VIA A COMPUTER FEATURING COMPUTERS, COMPUTER SOFTWARE, AND COMPUTER ACCESSORIES AND PARTS THEREFOR (U.S. CLS. 100, 101 AND 102).

CLASS 37—CONSTRUCTION AND REPAIR

FOR COMPUTER REPAIR (U.S. CLS. 100, 103 AND 106).

SN 76-034,766. OPTIMUM LOGISTICS LTD., STAMFORD, CT. FILED 4-24-2000.



CLASS 9—ELECTRICAL AND SCIENTIFIC APPARATUS

FOR COMPUTER OPERATING SOFTWARE FOR USE IN INTEGRATED LOGISTICS SERVICES, TO AID IN CREATING AND MANAGING SHIPMENTS OF BULK MATERIALS THROUGH ALL PHASES OF THE BULK MATERIALS SUPPLY CHAIN (U.S. CLS. 21, 23, 26, 36 AND 38).

CLASS 42—SCIENTIFIC, COMPUTER AND LEGAL SERVICES

FOR PROVIDING TEMPORARY USE OF NON-DOWNLOADABLE OPERATING SOFTWARE FOR USE IN INTEGRATED LOGISTICS SERVICES, TO AID IN CREATING AND MANAGING SHIPMENTS OF BULK MATERIALS THROUGH ALL PHASES OF THE BULK MATERIALS SUPPLY CHAIN INDUSTRY (U.S. CLS. 100 AND 101).

SN 76-034,920. CITADEL ARCHITECTURAL PRODUCTS, INC., INDIANAPOLIS, IN. FILED 4-26-2000.

CLEANCOTE

CLASS 6—METAL GOODS

FOR WALL AND CEILING PANELS COMPOSED OF A CORE MATERIAL WITH METAL FACING (U.S. CLS. 2, 12, 13, 14, 23, 25 AND 50).
FIRST USE 8-12-1991; IN COMMERCE 8-12-1991.

CLASS 19—NON-METALLIC BUILDING MATERIALS

FOR WALL AND CEILING PANELS COMPOSED OF A CORE MATERIAL WITH FACING NOT OF METAL (U.S. CLS. 1, 12, 33 AND 50).
FIRST USE 8-12-1991; IN COMMERCE 8-12-1991.

SN 76-035,808. SMITH'S FOOD & DRUG CENTERS, INC., SALT LAKE CITY, UT. FILED 4-26-2000.

SMITH'S CALL 'N CARD

OWNER OF U.S. REG. NO. 1,521,351 AND OTHERS.
NO CLAIM IS MADE TO THE EXCLUSIVE RIGHT TO USE "CALLING CARD", APART FROM THE MARK AS SHOWN.

CLASS 9—ELECTRICAL AND SCIENTIFIC APPARATUS

FOR PRE-PAID MAGNETICALLY ENCODED TELEPHONE CALLING CARDS (U.S. CLS. 21, 23, 26, 36 AND 38).

CLASS 16—PAPER GOODS AND PRINTED MATTER

FOR PRE-PAID NON-MAGNETICALLY ENCODED TELEPHONE CALLING CARDS (U.S. CLS. 2, 5, 22, 23, 29, 37, 38 AND 50).

SN 76-036,617. SHENZHEN BAOAN SHAJING AQUATIC PRODUCT CO., SHAJING TOWN, BAOAN DISTRICT 518000, CHINA, FILED 4-28-2000.



沙井

THE TRANSLITERATION OF THE CHARACTERS APPEARING IN THE MARK IS "SHAJING". THE TERM "SHAJING" HAS NO ENGLISH MEANING.

CLASS 29—MEATS AND PROCESSED FOODS

FOR PICKLES AND CHILI OIL (U.S. CL. 46).

CLASS 30—STAPLE FOODS

FOR PICKLE FLAVORING, TOMATO KETCHUP, OYSTER SAUCE, FISH SAUCE, FERMENTED SOY BEAN SAUCE AND FOOD FLAVORINGS (U.S. CL. 46).

SN 76-038,876. SIGNATURE BIOSCIENCE, INC., BURLINGAME, CA. FILED 5-1-2000.

SIGNATURE BIOSCIENCE

NO CLAIM IS MADE TO THE EXCLUSIVE RIGHT TO USE "BIOSCIENCE", APART FROM THE MARK AS SHOWN.

CLASS 9—ELECTRICAL AND SCIENTIFIC APPARATUS

FOR LABORATORY ANALYTICAL INSTRUMENTS FOR USE IN TAKING RADIO AND MICROWAVE SPECTRA OF MOLECULES AND FOR USE IN DETECTING MOLECULAR AND CELLULAR INTERACTIONS AND IN MEASURING AND COMPARING MOLECULAR AND CELLULAR SPECIES, AND PARTS AND ATTACHMENTS THEREOF, AND DISPOSABLE SAMPLE RECEPTACLES FOR USE THEREWITH; COMPUTER PROGRAMS FOR USE IN TAKING MICROWAVE SPECTRA OF MOLECULES AND FOR USE MEASURING AND COMPARING MOLECULAR AND CELLULAR INTERACTIONS (U.S. CLS. 21, 23, 26, 36 AND 38).

CLASS 42—SCIENTIFIC, COMPUTER AND LEGAL SERVICES

FOR PROVIDING AN ON LINE COMPUTER DATABASE IN THE FIELD OF RADIO AND MICROWAVE SPECTRA AND MOLECULAR AND CELLULAR INTERACTIONS (U.S. CLS. 100 AND 101).

SN 76-042,256. SPACEDISK PTE LTD., SINGAPORE 427456, SINGAPORE, FILED 5-5-2000.

SN 76-045,227. PLASMANET, INC., NEW YORK, NY. FILED 5-10-2000.

SPACEDISK

CLASS 38—COMMUNICATION

FOR PROVIDING MULTIPLE USER ACCESS TO A GLOBAL COMPUTER NETWORK; ELECTRONIC AND DIGITAL TRANSMISSION OF DATA, DOCUMENTS, INFORMATION, IMAGES, MESSAGES AND APPLICATIONS IN THE FORM OF TEXT (U.S. CLS. 100, 101 AND 104).

FIRST USE 9-1-1999; IN COMMERCE 9-1-1999.

CLASS 39—TRANSPORTATION AND STORAGE

FOR ELECTRONIC STORAGE OF DIGITAL DATA, DOCUMENTS, INFORMATION, IMAGES, MESSAGES AND APPLICATIONS IN THE FORM OF TEXT (U.S. CLS. 100 AND 105).

FIRST USE 9-1-1999; IN COMMERCE 9-1-1999.

CLASS 42—SCIENTIFIC, COMPUTER AND LEGAL SERVICES

FOR COMPUTER SERVICES, NAMELY, COMPUTER SYSTEMS ANALYSIS SERVICES FOR OTHERS, COMPUTER SYSTEM INTEGRATION SERVICES, CREATING COMPUTER PROGRAMS FOR OTHERS FOR DATA PROCESSING, CREATING COMPUTER PROGRAMS FOR OTHERS FOR CONVERSATION OF DATA, COMPUTER APPLICATIONS HOSTING FOR OTHERS (U.S. CLS. 100 AND 101).

FIRST USE 9-1-1999; IN COMMERCE 9-1-1999.



NO CLAIM IS MADE TO THE EXCLUSIVE RIGHT TO USE "WIN CASH NOW", APART FROM THE MARK AS SHOWN.

CLASS 35—ADVERTISING AND BUSINESS

FOR PROMOTING THE GOODS AND SERVICES OF OTHERS THROUGH PROMOTIONAL CONTESTS (U.S. CLS. 100, 101 AND 102).

CLASS 41—EDUCATION AND ENTERTAINMENT

FOR ENTERTAINMENT SERVICES, NAMELY, PROVIDING ONLINE COMPUTER GAMES; CONDUCTING SWEEPSTAKES (U.S. CLS. 100, 101 AND 107).

SN 76-045,319. CORRECT CRAFT, INC., ORLANDO, FL. FILED 5-10-2000.

SN 76-042,417. BOYD, SONDRRA, YORK, PA. FILED 5-5-2000.

SIMPLE ACTS OF KINDNESS INC.

NO CLAIM IS MADE TO THE EXCLUSIVE RIGHT TO USE "INC.", APART FROM THE MARK AS SHOWN.

CLASS 30—STAPLE FOODS

FOR SALSA (U.S. CL. 46).

CLASS 42—SCIENTIFIC, COMPUTER AND LEGAL SERVICES

FOR CHARITABLE SERVICES, NAMELY, PROVIDING SERVICES FOR THE BASIC NECESSITIES OF LIFE FOR NATIVE AMERICANS IN THE NATURE OF FOOD, APPAREL, MEDICINE AND MEDICAL SUPPLIES, COMPUTER/ELECTRONIC GOODS, EDUCATIONAL MATERIALS, EXERCISE EQUIPMENT, HOUSEHOLD FURNISHINGS, TOOLS AND ALL TYPES OF VEHICLES AND VEHICLE PARTS AND CONSTRUCTION EQUIPMENT (U.S. CLS. 100 AND 101).



CLASS 12—VEHICLES

FOR BOATS, NAMELY, SKI BOATS, WAKEBOARD BOATS, AND RUNABOUTS (U.S. CLS. 19, 21, 23, 31, 35 AND 44).

FIRST USE 8-0-1999; IN COMMERCE 8-0-1999.

CLASS 16—PAPER GOODS AND PRINTED MATTER

FOR MAGAZINES IN THE FIELD OF BOATS PUBLISHED PERIODICALLY (U.S. CLS. 2, 5, 22, 23, 29, 37, 38 AND 50).

FIRST USE 8-0-1999; IN COMMERCE 8-0-1999.

CLASS 18—LEATHER GOODS

FOR BAGS, NAMELY, BACKPACKS AND DUFFEL BAGS (U.S. CLS. 1, 2, 3, 22 AND 41).

FIRST USE 8-0-1999; IN COMMERCE 8-0-1999.

CLASS 25—CLOTHING

FOR CLOTHING, NAMELY, SWEATSHIRTS, T-SHIRTS, POLO SHIRTS, SHIRTS, JACKETS, SHORTS AND HATS (U.S. CLS. 22 AND 39).

FIRST USE 8-0-1999; IN COMMERCE 8-0-1999.

SN 76-049,591. AUTOMOTIVE TECHNICAL RESOURCES, INCORPORATED, TROY, MI. FILED 5-16-2000.



OWNER OF U.S. REG. NO. 2,342,563.
THE STIPPLING IN THE DRAWING IS FOR SHADING PURPOSES ONLY AND IS NOT INTENDED TO INDICATE COLOR.

CLASS 9—ELECTRICAL AND SCIENTIFIC APPARATUS

FOR PORTABLE COMPUTERS; COMPUTER SOFTWARE FOR USE IN BUSINESS PROCESS AUTOMATION; COMPUTER SOFTWARE FOR USE IN THE MANAGEMENT, TRANSFER, DISSEMINATION, INTERPRETATION, MANIPULATION, DISPLAY AND INDEXING OF A WIDE ARRAY OF DATA AND INFORMATION; COMPUTER SOFTWARE IN THE USE MANAGEMENT TRANSFER, DISSEMINATION, INTERPRETATION, MANIPULATION, DISPLAY AND INDEXING OF AUTOMOTIVE DIAGNOSTIC AND REPAIR DATA AND INFORMATION (U.S. CLS. 21, 23, 26, 36 AND 38).

CLASS 37—CONSTRUCTION AND REPAIR

FOR PROVIDING INFORMATION IN THE FIELD OF AUTOMOTIVE VEHICLE OPERABILITY, AND AUTOMOTIVE DIAGNOSTIC AND REPAIR INFORMATION (U.S. CLS. 100, 103 AND 106).

SN 76-049,592. AUTOMOTIVE TECHNICAL RESOURCES, INCORPORATED, TROY, MI. FILED 5-16-2000.

JUST IN TIME SYSTEMS BY ATRI

CLASS 9—ELECTRICAL AND SCIENTIFIC APPARATUS

FOR PORTABLE COMPUTERS; COMPUTER SOFTWARE FOR USE IN BUSINESS PROCESS AUTOMATION; COMPUTER SOFTWARE FOR USE IN THE MANAGEMENT, TRANSFER, DISSEMINATION, INTERPRETATION, MANIPULATION, DISPLAY AND INDEXING OF A WIDE ARRAY OF DATA AND INFORMATION; COMPUTER SOFTWARE IN THE USE MANAGEMENT TRANSFER, DISSEMINATION, INTERPRETATION, MANIPULATION, DISPLAY AND INDEXING OF AUTOMOTIVE DIAGNOSTIC AND REPAIR DATA AND INFORMATION (U.S. CLS. 21, 23, 26, 36 AND 38).

CLASS 37—CONSTRUCTION AND REPAIR

FOR PROVIDING INFORMATION IN THE FIELD OF AUTOMOTIVE VEHICLE OPERABILITY, AND AUTOMOTIVE DIAGNOSTIC AND REPAIR INFORMATION (U.S. CLS. 100, 103 AND 106).

SN 76-049,593. AUTOMOTIVE TECHNICAL RESOURCES, INCORPORATED, TROY, MI. FILED 5-16-2000.

RIGHT HERE, RIGHT NOW!

CLASS 9—ELECTRICAL AND SCIENTIFIC APPARATUS

FOR PORTABLE COMPUTERS; COMPUTER SOFTWARE FOR USE IN BUSINESS PROCESS AUTOMATION; COMPUTER SOFTWARE FOR USE IN THE MANAGEMENT, TRANSFER, DISSEMINATION, INTERPRETATION, MANIPULATION, DISPLAY AND INDEXING OF A WIDE ARRAY OF DATA AND INFORMATION; COMPUTER SOFTWARE IN THE USE MANAGEMENT TRANSFER, DISSEMINATION, INTERPRETATION, MANIPULATION, DISPLAY AND INDEXING OF AUTOMOTIVE DIAGNOSTIC AND REPAIR DATA AND INFORMATION (U.S. CLS. 21, 23, 26, 36 AND 38).

CLASS 37—CONSTRUCTION AND REPAIR

FOR PROVIDING INFORMATION IN THE FIELD OF AUTOMOTIVE VEHICLE OPERABILITY, AND AUTOMOTIVE DIAGNOSTIC AND REPAIR INFORMATION (U.S. CLS. 100, 103 AND 106).

SN 76-050,139. SUSSEX TECHNOLOGY, INC., SPARTA, NJ. FILED 5-16-2000.

TWIST-FLOW

CLASS 20—FURNITURE AND ARTICLES NOT OTHERWISE CLASSIFIED

FOR NON-METAL BOTTLE CAPS (U.S. CLS. 2, 13, 22, 25, 32 AND 50).

CLASS 21—HOUSEWARES AND GLASS

FOR BOTTLES, SOLD EMPTY (U.S. CLS. 2, 13, 23, 29, 30, 33, 40 AND 50).

SN 76-050,140. SUSSEX TECHNOLOGY, INC., SPARTA, NJ. FILED 5-16-2000.

DISK-LOK

CLASS 20—FURNITURE AND ARTICLES NOT OTHERWISE CLASSIFIED

FOR NON-METAL BOTTLE CAPS (U.S. CLS. 2, 13, 22, 25, 32 AND 50).

CLASS 21—HOUSEWARES AND GLASS

FOR BOTTLES, SOLD EMPTY (U.S. CLS. 2, 13, 23, 29, 30, 33, 40 AND 50).

SN 76-050,511. DINO FLEX MANUFACTURING LTD., SALMON ARM, B.C. V1E 4S1, CANADA, FILED 5-16-2000.

SN 76-051,681. SOUTHERN NEW ENGLAND TELECOMMUNICATIONS CORPORATION, NEW HAVEN, CT. FILED 5-18-2000.



DINO FLEX Manufacturing LTD.

NO CLAIM IS MADE TO THE EXCLUSIVE RIGHT TO USE "MANUFACTURING LTD.", APART FROM THE MARK AS SHOWN.

CLASS 19—NON-METALLIC BUILDING MATERIALS

FOR RUBBERIZED OUTDOOR WALKING, PLAYGROUND AND SPORTS SURFACES IN THE FORM OF PADS, TILES, RAMPS AND CURBS (U.S. CLS. 1, 12, 33 AND 50).

FIRST USE 2-20-1995; IN COMMERCE 10-16-1995.

CLASS 27—FLOOR COVERINGS

FOR INDOOR RUBBER MATS AND WALKING, PLAYGROUND AND SPORTS SURFACES IN THE FORM OF SHEETS OR INTER-LOCKING MATS (U.S. CLS. 19, 20, 37, 42 AND 50).

FIRST USE 4-23-1993; IN COMMERCE 5-10-1995.

SN 76-050,701. OPTIMUM LOGISTICS LTD, STAMFORD, CT. FILED 5-17-2000.



TransRelationship

CLASS 9—ELECTRICAL AND SCIENTIFIC APPARATUS

FOR COMPUTER OPERATING SOFTWARE FOR USE IN INTEGRATED LOGISTICS SERVICES, TO AID IN CREATING AND MANAGING SHIPMENTS OF BULK MATERIALS THROUGH ALL PHASES OF THE BULK MATERIALS SUPPLY CHAIN (U.S. CLS. 21, 23, 26, 36 AND 38).

CLASS 42—SCIENTIFIC, COMPUTER AND LEGAL SERVICES

FOR PROVIDING TEMPORARY USE OF NON-DOWNLOADABLE OPERATING SOFTWARE FOR USE IN INTEGRATED LOGISTICS SERVICES, TO AID IN CREATING AND MANAGING SHIPMENTS OF BULK MATERIALS THROUGH ALL PHASES OF THE BULK MATERIALS SUPPLY CHAIN INDUSTRY (U.S. CLS. 100 AND 101).

AIRBUCKS

CLASS 35—ADVERTISING AND BUSINESS

FOR PROMOTING THE SALE OF TELECOMMUNICATION SERVICES THROUGH THE ADMINISTRATION OF INCENTIVE AWARD PROGRAMS (U.S. CLS. 100, 101 AND 102).

CLASS 38—COMMUNICATION

FOR PROVIDING WIRELESS TELEPHONE SERVICES IN CONJUNCTION WITH PREPAID AIRTIME MINUTES (U.S. CLS. 100, 101 AND 104).

SN 76-054,021. I—TECH CORPORATION, BILLINGS, MT. FILED 5-23-2000.

I TECH

CLASS 35—ADVERTISING AND BUSINESS

FOR FINANCIAL ACCOUNTING SERVICES; FINANCIAL DATA PROCESSING SERVICES (U.S. CLS. 100, 101 AND 102).

CLASS 36—INSURANCE AND FINANCIAL

FOR PROVIDING ON-LINE BANKING SERVICES VIA A GLOBAL COMPUTER NETWORK; PROVIDING CASH TRANSACTIONS VIA AUTOMATED TELLER MACHINES; SAVINGS AND LOAN SERVICES; BANKING SERVICES FEATURING INDIVIDUAL RETIREMENT ACCOUNTS, CERTIFICATES OF DEPOSIT, ASSET LIABILITY MANAGEMENT AND FINANCIAL MANAGEMENT; AGENCIES IN THE FIELD OF BONDS AND OTHER SECURITIES (U.S. CLS. 100, 101 AND 102).

SN 76-054,815. PHAZE-X, INC., NEW YORK, NY. FILED 5-22-2000.

DREAMKITTENS

CLASS 9—ELECTRICAL AND SCIENTIFIC APPARATUS

FOR SERIES OF PRE-RECORDED CD-ROMS, PRE-RECORDED DIGITAL VIDEO DISCS (DVDs), AND PRE-RECORDED VIDEO CASSETTES, ALL FEATURING ADULT ENTERTAINMENT (U.S. CLS. 21, 23, 26, 36 AND 38).

FIRST USE 3-5-1999; IN COMMERCE 4-10-1999.

CLASS 16—PAPER GOODS AND PRINTED MATTER

FOR PHOTOGRAPHS, MOUNTED AND UNMOUNTED; CALENDARS; ADULT ENTERTAINMENT MAGAZINES AND BOOKS; PLAYING CARDS; AND POSTERS (U.S. CLS. 2, 5, 22, 23, 29, 37, 38 AND 50).

FIRST USE 3-5-1999; IN COMMERCE 4-10-1999.

CLASS 41—EDUCATION AND ENTERTAINMENT

FOR ENTERTAINMENT IN THE NATURE OF LIVE DANCE, MUSICAL, AND ACTING PERFORMANCES; MODELING FOR ARTISTS AND ENTERTAINMENT PURPOSES; PERSONAL APPEARANCES BY ADULT ENTERTAINMENT CELEBRITIES; LIVE PERFORMANCE ART EXHIBITIONS; VIDEOTAPE PRODUCTION SERVICES; ENTERTAINMENT SERVICES, NAMELY PROVIDING INTERACTIVE ADULT-ORIENTED ENTERTAINMENT VIA A GLOBAL COMPUTER NETWORK WEBSITE, NAMELY, PICTURES, GRAPHICS, ARTICLES, VIDEOS, AND COMMENTARY (U.S. CLS. 100, 101 AND 107).

FIRST USE 3-5-1999; IN COMMERCE 4-10-1999.

SN 76-055,127. MATRIX SERVICE COMPANY, TULSA, OK. FILED 5-24-2000.



NO CLAIM IS MADE TO THE EXCLUSIVE RIGHT TO USE "SERVICE", APART FROM THE MARK AS SHOWN.

CLASS 37—CONSTRUCTION AND REPAIR

FOR SERVICING, MAINTENANCE AND/OR REPAIR OF MULTI-PURPOSE LIQUID STORAGE TANKS CONTAINING A WIDE RANGE OF LIQUIDS USED IN A VARIETY OF INDUSTRIES, AND ROOFS THEREFOR; AND CONSTRUCTION, REPAIR, REBUILDING, REFURBISHING AND MODIFICATION OF SUCH MULTI-PURPOSE LIQUID STORAGE TANKS TO THE SPECIFICATIONS OF OTHERS (U.S. CLS. 100, 103 AND 106).

FIRST USE 8-0-1999; IN COMMERCE 8-0-1999.

CLASS 42—SCIENTIFIC, COMPUTER AND LEGAL SERVICES

FOR TECHNICAL SUPERVISION AND INSPECTION IN THE FIELD OF REFINERY PLANT SERVICES OF THE TYPE EMPLOYED IN A WIDE VARIETY OF INDUSTRIES (U.S. CLS. 100 AND 101).

FIRST USE 8-0-1999; IN COMMERCE 8-0-1999.

SN 76-055,580. GOVDEALS.COM, INC., MONTGOMERY, AL. FILED 5-24-2000.



CLASS 35—ADVERTISING AND BUSINESS

FOR DISSEMINATION OF ADVERTISING FOR OTHERS VIA AN ON-LINE ELECTRONIC COMMUNICATIONS NETWORK; BUSINESS MANAGEMENT; ON-LINE AUCTION OF GOVERNMENT SURPLUS (U.S. CLS. 100, 101 AND 102).

FIRST USE 11-13-1999; IN COMMERCE 12-21-1999.

CLASS 36—INSURANCE AND FINANCIAL

FOR GOVERNMENT SURPLUS BROKERAGE (U.S. CLS. 100, 101 AND 102).

FIRST USE 11-13-1999; IN COMMERCE 12-21-1999.

CLASS 38—COMMUNICATION

FOR PROVIDING ON-LINE ELECTRONIC BULLETIN BOARDS FOR TRANSMISSION OF MESSAGES AMONG COMPUTER USERS CONCERNING GOVERNMENT PROCUREMENT, GOVERNMENT DISPOSITION, AND THE ON-LINE AUCTION OF GOVERNMENT SURPLUS (U.S. CLS. 100, 101 AND 104).

FIRST USE 11-13-1999; IN COMMERCE 12-21-1999.

CLASS 41—EDUCATION AND ENTERTAINMENT

FOR PROVIDING INFORMATION IN THE FIELDS OF GOVERNMENT PROCUREMENT, GOVERNMENT DISPOSITION, AND THE ON-LINE AUCTION OF GOVERNMENT SURPLUS, VIA A GLOBAL COMPUTER INFORMATION NETWORK (U.S. CLS. 100, 101 AND 107).

FIRST USE 11-13-1999; IN COMMERCE 12-21-1999.

SN 76-055,816. VECTANT, INC., NEW YORK, NY. BY CHANGE OF NAME GLOBAL BANDWIDTH SOLUTIONS, INC., NEW YORK, NY. FILED 5-24-2000.

VECTANT

CLASS 38—COMMUNICATION

FOR TELECOMMUNICATIONS SERVICES, NAMELY, OPERATING FIBER OPTIC CABLE SYSTEMS; PROVIDING ACCESS TO A TRANSOCEANIC AND TERRESTRIAL FIBER OPTIC CABLE SYSTEM TO TELECOMMUNICATIONS COMPANIES, INTERNET SERVICE PROVIDERS, AND COMPANIES ENGAGED IN ELECTRONIC COMMERCE; PROVIDING FIBER OPTIC NETWORK SERVICES (U.S. CLS. 100, 101 AND 104).

CLASS 42—SCIENTIFIC, COMPUTER AND LEGAL SERVICES

FOR COMPUTER SERVICES, NAMELY, ACTING AS AN APPLICATION SERVICE PROVIDER (ASP) TO HOST AND DELIVER THE USER WEB-BASED COMPUTER SOFTWARE APPLICATIONS ENABLING INFORMATION AND DATA TO BE DOWNLOAD FROM THE INTERNET OR AN INTRANET TO BE DIRECTED TO ANOTHER COMPUTER FOR FURTHER USE, DOWNLOADING, STORAGE AND MANAGEMENT (U.S. CLS. 100 AND 101).

SN 76-056,089. BLUE FROG SOFTWARE.COM, INC., CASSELBERRY, FL. FILED 5-24-2000.

FLUIDITY OF TEXTONOMY

CLASS 9—ELECTRICAL AND SCIENTIFIC APPARATUS

FOR COMPUTER PROGRAMS FOR USE IN DATABASE MANAGEMENT TO MIMIC HUMAN REASONING IN PURCHASING DECISIONS (U.S. CLS. 21, 23, 26, 36 AND 38).

CLASS 35—ADVERTISING AND BUSINESS

FOR ON-LINE CLASSIFIED ADVERTISING SERVICES, NAMELY PROVIDING FOR INDIVIDUALS AND BUSINESSES DATABASE INFORMATION LISTINGS AND INFORMATION TO BUSINESSES AND CONSUMERS FOR BUYING AND SELLING NEW AND USED PRODUCTS AND SERVICES ON THE WORLD WIDE WEB (U.S. CLS. 100, 101 AND 102).

SN 76-056,445. SILVERTHORN PRODUCTION COMPANY, SEATTLE, WA. FILED 5-25-2000.

COGNIGEN

CLASS 35—ADVERTISING AND BUSINESS

FOR BUSINESS MARKETING CONSULTING SERVICES IN THE FIELD OF TELECOMMUNICATION VIA A GLOBAL COMPUTER NETWORK (U.S. CLS. 100, 101 AND 102).
FIRST USE 0-0-1994; IN COMMERCE 0-0-1994.

CLASS 38—COMMUNICATION

FOR TELECOMMUNICATION SERVICES, NAMELY, LOCAL AND LONG DISTANCE TELEPHONE SERVICES, PROVIDING WIRELESS VOICE AND DATA COMMUNICATION SERVICES (U.S. CLS. 100, 101 AND 104).
FIRST USE 0-0-1994; IN COMMERCE 0-0-1994.

CLASS 42—SCIENTIFIC, COMPUTER AND LEGAL SERVICES

FOR COMPUTER SERVICES, NAMELY, CREATING AND MAINTAINING WEBSITES FOR OTHERS (U.S. CLS. 100 AND 101).
FIRST USE 0-0-1994; IN COMMERCE 0-0-1994.

SN 76-058,915. EMHART INC., NEWARK, DE. FILED 5-30-2000.

PFRESH PFINISHES

CLASS 6—METAL GOODS

FOR BATH FIXTURES, NAMELY, METAL HOOKS FOR HOLDING GARMENTS AND ROBES (U.S. CLS. 2, 12, 13, 14, 23, 25 AND 50).
FIRST USE 4-30-2000; IN COMMERCE 4-30-2000.

CLASS 11—ENVIRONMENTAL CONTROL APPARATUS

FOR PLUMBING FITTINGS AND FIXTURES, NAMELY, VALVES, FAUCETS, AERATORS FOR FAUCETS, SPOUTS, SHOWER HEADS, HANDLES, POP-UP DRAINS, SINGLE LEVER FIXTURES FOR LAVATORIES AND SINKS, FLUSH LEVERS AND DRAINS, FAUCET FILTERS; ELECTRIC LIGHTING FIXTURES (U.S. CLS. 13, 21, 23, 31 AND 34).
FIRST USE 4-30-2000; IN COMMERCE 4-30-2000.

CLASS 21—HOUSEWARES AND GLASS

FOR BATH FIXTURES, NAMELY, TOWEL BARS, TOWEL RINGS, TOILET PAPER HOLDERS, SOAP DISHES, TUMBLER AND TOOTH BRUSH HOLDERS (U.S. CLS. 2, 13, 23, 29, 30, 33, 40 AND 50).
FIRST USE 4-30-2000; IN COMMERCE 4-30-2000.

SN 76-058,916. EMHART INC., NEWARK, DE. FILED 5-30-2000.

PFRESH PFEATURES

CLASS 6—METAL GOODS

FOR BATH FIXTURES, NAMELY, METAL HOOKS FOR HOLDING GARMENTS AND ROBES (U.S. CLS. 2, 12, 13, 14, 23, 25 AND 50).
FIRST USE 4-30-2000; IN COMMERCE 4-30-2000.

CLASS 11—ENVIRONMENTAL CONTROL APPARATUS

FOR PLUMBING FITTINGS AND FIXTURES, NAMELY, VALVES, FAUCETS, AERATORS FOR FAUCETS, SPOUTS, SHOWER HEADS, HANDLES, POP-UP DRAINS, SINGLE LEVER FIXTURES FOR LAVATORIES AND SINKS, FLUSH LEVERS AND DRAINS, FAUCET FILTERS; ELECTRIC LIGHTING FIXTURES (U.S. CLS. 13, 21, 23, 31 AND 34).
FIRST USE 4-30-2000; IN COMMERCE 4-30-2000.

CLASS 21—HOUSEWARES AND GLASS

FOR BATH FIXTURES, NAMELY, TOWEL BARS, TOWEL RINGS, TOILET PAPER HOLDERS, SOAP DISHES, TUMBLER AND TOOTH BRUSH HOLDERS (U.S. CLS. 2, 13, 23, 29, 30, 33, 40 AND 50).
FIRST USE 4-30-2000; IN COMMERCE 4-30-2000.

SN 76-058,918. EMHART INC., NEWARK, DE. FILED 5-30-2000.

PFRESH

CLASS 6—METAL GOODS

FOR BATH FIXTURES, NAMELY, METAL HOOKS FOR HOLDING GARMENTS AND ROBES (U.S. CLS. 2, 12, 13, 14, 23, 25 AND 50).
FIRST USE 4-30-2000; IN COMMERCE 4-30-2000.

CLASS 11—ENVIRONMENTAL CONTROL APPARATUS

FOR PLUMBING FITTINGS AND FIXTURES, NAMELY, VALVES, FAUCETS, AERATORS FOR FAUCETS, SPOUTS, SHOWER HEADS, HANDLES, POP-UP DRAINS, SINGLE LEVER FIXTURES FOR LAVATORIES AND SINKS, FLUSH LEVERS AND DRAINS, FAUCET FILTERS; ELECTRIC LIGHTING FIXTURES (U.S. CLS. 13, 21, 23, 31 AND 34).
FIRST USE 4-30-2000; IN COMMERCE 4-30-2000.

CLASS 21—HOUSEWARES AND GLASS

FOR BATH FIXTURES, NAMELY, TOWEL BARS, TOWEL RINGS, TOILET PAPER HOLDERS, SOAP DISHES, TUMBLER AND TOOTH BRUSH HOLDERS (U.S. CLS. 2, 13, 23, 29, 30, 33, 40 AND 50).
FIRST USE 4-30-2000; IN COMMERCE 4-30-2000.

SN 76-059,422. KRISHNASWAMI, RAVI, JERSEY CITY, NJ.
FILED 5-30-2000.

CHARMING

CLASS 9—ELECTRICAL AND SCIENTIFIC APPARATUS

FOR PRE-RECORDED RECORDS, AUDIO AND VIDEO CASSETTES, AND COMPACT DISCS FEATURING MUSICAL ENTERTAINMENT (U.S. CLS. 21, 23, 26, 36 AND 38).

FIRST USE 11-11-1994; IN COMMERCE 11-11-1994.

CLASS 41—EDUCATION AND ENTERTAINMENT

FOR ENTERTAINMENT SERVICES IN THE NATURE OF LIVE PERFORMANCES BY A MUSICAL GROUP (U.S. CLS. 100, 101 AND 107).

FIRST USE 11-11-1994; IN COMMERCE 11-11-1994.

SN 76-059,692. BAYER S.P.A., 20156 MILAN, ITALY, FILED 5-30-2000.



PRIORITY CLAIMED UNDER SEC. 44(D) ON ITALY APPLICATION NO. 2000C001818, FILED 2-18-2000, REG. NO. 001818, DATED 2-18-2000, EXPIRES 2-18-2010.

NO CLAIM IS MADE TO THE EXCLUSIVE RIGHT TO USE "COLLECTION", APART FROM THE MARK AS SHOWN.

CLASS 3—COSMETICS AND CLEANING PREPARATIONS

FOR WAX FOR LEATHER AND ANIMAL SKIN CLEANING (U.S. CLS. 1, 4, 6, 50, 51 AND 52).

CLASS 4—LUBRICANTS AND FUELS

FOR GREASE FOR LEATHER AND ANIMAL SKIN CARE (U.S. CLS. 1, 6 AND 15).

SN 76-060,153. FOCINT, INC., NEW YORK, NY. FILED 5-30-2000.

FOCINT

CLASS 35—ADVERTISING AND BUSINESS

FOR PREPARING ADVERTISEMENTS FOR OTHERS; PREPARING ADVERTISING BANNERS DISSEMINATED VIA THE INTERNET FOR OTHERS; ADVERTISING AGENCIES; DISSEMINATION OF ADVERTISING FOR OTHERS VIA AN ON-LINE ELECTRONIC COMMUNICATIONS NETWORK, WIRELESS TECHNOLOGIES, AND EMAIL (U.S. CLS. 100, 101 AND 102).

FIRST USE 10-1-1999; IN COMMERCE 10-1-1999.

CLASS 42—SCIENTIFIC, COMPUTER AND LEGAL SERVICES

FOR COMPUTER SERVICES, NAMELY, CREATING, DESIGNING, IMPLEMENTING AND MAINTAINING WEB SITES FOR OTHERS; DESIGNING AND IMPLEMENTING NETWORK WEB PAGES FOR OTHERS; COMMERCIAL ART DESIGN; COMPUTER SITE DESIGN; GRAPHIC ART DESIGN; DESIGN FOR OTHERS IN THE FIELD OF COMPUTERS; DESIGNING CORPORATE LOGOS FOR OTHERS (U.S. CLS. 100 AND 101).

FIRST USE 10-1-1999; IN COMMERCE 10-1-1999.

SN 76-060,418. MEDIAONE GROUP, INC., ENGLEWOOD, CO. FILED 5-31-2000.



NO CLAIM IS MADE TO THE EXCLUSIVE RIGHT TO USE "BOSTONCARGUIDE.COM", APART FROM THE MARK AS SHOWN.

CLASS 35—ADVERTISING AND BUSINESS

FOR ADVERTISING AND MARKETING SERVICES, NAMELY, PROMOTING THE GOODS AND SERVICES OF OTHERS BY PREPARING AND PLACING ADVERTISEMENTS IN AN ELECTRONIC MAGAZINE ACCESSED THROUGH A GLOBAL COMPUTER NETWORK; PROVIDING AUTOMOBILE SHOPPERS' GUIDE INFORMATION VIA ON-LINE COMPUTER ELECTRONIC WEBSITE; PROVIDING RETAIL INFORMATION SERVICES FOR PROSPECTIVE PURCHASERS OF AUTOMOBILES VIA GLOBAL COMPUTER NETWORKS (U.S. CLS. 100, 101 AND 102).

CLASS 37—CONSTRUCTION AND REPAIR

FOR PROVIDING AUTOMOBILE REPAIR AND MAINTENANCE INFORMATION VIA A GLOBAL COMPUTER NETWORK (U.S. CLS. 100, 103 AND 106).

CLASS 39—TRANSPORTATION AND STORAGE

FOR PROVIDING INFORMATION ON THE LEASING OF AUTOMOBILES VIA A GLOBAL COMPUTER NETWORK (U.S. CLS. 100 AND 105).

CLASS 41—EDUCATION AND ENTERTAINMENT

FOR PROVIDING AUTOMOBILE RACES INFORMATION VIA A GLOBAL COMPUTER NETWORK (U.S. CLS. 100, 101 AND 107).

SN 76-060,710. I/O CONTROLS CORPORATION, AZUSA, CA.
FILED 5-30-2000.

DINEX
Link

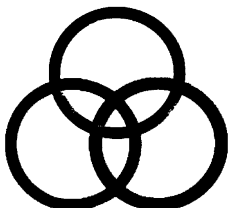

NO CLAIM IS MADE TO THE EXCLUSIVE RIGHT TO USE "LINK", APART FROM THE MARK AS SHOWN.

CLASS 9—ELECTRICAL AND SCIENTIFIC APPARATUS

FOR COMPUTER HARDWARE AND SOFTWARE FOR REMOTE DIAGNOSIS, TESTING AND MAINTENANCE OF CONTROL NETWORKS AND ELECTRONIC SYSTEMS (U.S. CLS. 21, 23, 26, 36 AND 38).

CLASS 38—COMMUNICATION

FOR PROVIDING MULTIPLE-USER ACCESS TO A GLOBAL COMPUTER INFORMATION NETWORK (U.S. CLS. 100, 101 AND 104).

CLASS 42—SCIENTIFIC, COMPUTER AND LEGAL SERVICES

FOR ON-LINE COMPUTER SERVICES, NAMELY, PROVIDING ON-LINE INFORMATION REGARDING CONTROL NETWORKS AND DIAGNOSIS OF CONTROL NETWORKS, AND PROVIDING INFORMATION ABOUT PARTS SUPPLIERS OVER A DISTRIBUTED ELECTRONIC NETWORK (U.S. CLS. 100 AND 101).

SN 76-060,742. STAN LEE MEDIA, INC., ENCINO, CA.
FILED 5-30-2000.

WHIPSAW

CLASS 16—PAPER GOODS AND PRINTED MATTER

FOR CALENDARS, POSTERS; PUBLICATIONS, NAMELY BOOKS ON THE SUBJECT OF ANIMATED AND ADVENTURE STORIES, NOTEBOOKS, COMIC BOOKS, AND MAGAZINES FEATURING ARTICLES, REVIEWS, AND INFORMATION RELATED TO ANIMATED CARTOON CHARACTERS AND ADVENTURE STORIES, AND STORIES IN ILLUSTRATED FORM; TRADING CARDS; PENCIL CASES, PENCIL SHARPENERS, BOOKMARKS, PLAYING CARDS, GREETING CARDS, POSTCARDS, STATIONERY, DRAWING AND UNGRADUATED RULERS, STICKERS, DECALS, WRAPPING PAPER, STICKER BOOKS, PAPER NAPKINS, PAPER AND PLASTIC PLACEMATS, PAPER PARTY HATS, PAPER TABLE CLOTHS, ALL FEATURING ANIMATED CARTOON CHARACTERS (U.S. CLS. 2, 5, 22, 23, 29, 37, 38 AND 50).

CLASS 35—ADVERTISING AND BUSINESS

FOR RETAIL STORE SERVICES FEATURING CLOTHING, TOYS, GAMES, AND ELECTRONIC MEDIA, ALL OF WHICH FEATURE ANIMATED CARTOON CHARACTERS (U.S. CLS. 100, 101 AND 102).

SN 76-063,797. VIDEOGRAPHIC ENTERPRISES, INC., NEW YORK, NY. FILED 6-2-2000.



CLASS 35—ADVERTISING AND BUSINESS

FOR BUSINESS MARKETING CONSULTING SERVICES; PREPARING AUDIO-VISUAL PRESENTATIONS FOR USE IN ADVERTISING AND MARKETING; CORPORATE PLANNING SERVICES, NAMELY, ARRANGING AND CONDUCTING TRADE SHOW EXHIBITIONS IN THE FIELD OF ADVERTISING AND MULTIMEDIA PRESENTATIONS; AND ADVISING CORPORATE CLIENTS ON THE APPROPRIATE MEDIUM FOR COMMUNICATING THEIR PRESENTATIONS (U.S. CLS. 100, 101 AND 102).

CLASS 42—SCIENTIFIC, COMPUTER AND LEGAL SERVICES

FOR COMPUTER SERVICES, NAMELY, CREATING WEB SITES FOR OTHERS; COMPUTER SOFTWARE DESIGN FOR OTHERS; AND GRAPHIC ART DESIGN (U.S. CLS. 100 AND 101).

SN 76-064,658. HIMMELSTEIN, RICHARD B., PALERMO, NJ. FILED 6-7-2000.

REACHPEOPLE

CLASS 9—ELECTRICAL AND SCIENTIFIC APPARATUS

FOR COMPUTER SOFTWARE FOR ACCESSING AND RETRIEVING INFORMATION FROM A LOCAL OR GLOBAL COMPUTER INFORMATION NETWORK AND FOR USE IN COMMUNICATION WITH INDIVIDUALS OR COMPANIES THROUGH E-MAIL, FACSIMILE, WEBSITE ADDRESSES OR VOICE TRANSMISSION (U.S. CLS. 21, 23, 26, 36 AND 38).

CLASS 38—COMMUNICATION

FOR ONLINE SERVICE PROVIDING ACCESS TO LOCAL OR GLOBAL COMPUTER INFORMATION NETWORK AND RETRIEVAL OF INFORMATION FOR USE IN COMMUNICATING WITH INDIVIDUALS OR COMPANIES THROUGH E-MAIL, FACSIMILE, WEBSITE ADDRESSES OR VOICE TRANSMISSION (U.S. CLS. 100, 101 AND 104).

SN 76-065,111. PEGASUS COMMUNICATIONS CORPORATION, BALA CYNWYD, PA. FILED 6-7-2000.

SN 76-066,411. FLUOROWARE, INC., CHASKA, MN. FILED 6-8-2000.



CLASS 9—ELECTRICAL AND SCIENTIFIC APPARATUS

FOR COMPUTER HARDWARE AND COMPUTER SOFTWARE FOR VIEWING SATELLITE, CABLE AND INTERNET PROGRAMS IN THE ACADEMIC, CULTURAL, LEISURE AND PROFESSIONAL FIELDS (U.S. CLS. 21, 23, 26, 36 AND 38).

CLASS 35—ADVERTISING AND BUSINESS

FOR PROVIDING TELEVISION ADVERTISING FOR OTHERS (U.S. CLS. 100, 101 AND 102).

CLASS 42—SCIENTIFIC, COMPUTER AND LEGAL SERVICES

FOR RENTAL OF COMPUTERS AND SOFTWARE (U.S. CLS. 100 AND 101).

SN 76-065,144. RCT RESEARCH CONSULTING TECHNOLOGY GESELLSCHAFT FUR INFORMATIONSSYSTEME MBH, D-5540 HAAR, FED REP GERMANY, FILED 6-7-2000.

SHOETING

PRIORITY CLAIMED UNDER SEC. 44(D) ON FED REP GERMANY APPLICATION NO. 39977061.5, FILED 12-7-1999, REG. NO. 39977061, DATED 1-17-2000, EXPIRES 12-31-2009.

CLASS 9—ELECTRICAL AND SCIENTIFIC APPARATUS

FOR COMPUTER PROGRAM FOR INFORMATION MANAGEMENT FOR USE IN THE FIELD OF SHOE MANUFACTURING AND PRODUCTION (U.S. CLS. 21, 23, 26, 36 AND 38).

CLASS 42—SCIENTIFIC, COMPUTER AND LEGAL SERVICES

FOR COMPUTER PROGRAMMING FOR OTHERS, NAMELY, FOR COMPANIES ENGAGED IN THE SHOE MANUFACTURING AND PRODUCTION BUSINESS (U.S. CLS. 100 AND 101).

MATERIALS ENTEGRITY

OWNER OF U.S. REG. NO. 1,848,496.

NO CLAIM IS MADE TO THE EXCLUSIVE RIGHT TO USE "MATERIALS", APART FROM THE MARK AS SHOWN.

CLASS 7—MACHINERY

FOR EQUIPMENT THAT WASHES AND DRIES SEMICONDUCTOR AND MAGNETIC DISK CARRIERS, BOXES AND SHIPPING CONTAINERS, NAMELY, A SELF-CONTAINED OPENABLE ENCLOSURE THAT WASHES WITH FLUIDS AND DRIES WITH AIR OR OTHER GASES (U.S. CLS. 13, 19, 21, 23, 31, 34 AND 35).

CLASS 9—ELECTRICAL AND SCIENTIFIC APPARATUS

FOR PLASTIC ARTICLES USED IN LABORATORIES, IN THE PHARMACEUTICAL, BIOTECHNOLOGY AND CHEMICAL PROCESSING INDUSTRIES, AND IN INDUSTRIAL MANUFACTURING PLANTS NAMELY, CARRIERS FOR SEMICONDUCTOR WAFERS AND SUBSTRATES AND HANDLES THEREFOR, STORAGE BOXES AND COVERS FOR SEMICONDUCTOR WAFERS AND SUBSTRATES, SHIPPING CONTAINERS AND HANDLING TRAYS FOR SEMICONDUCTOR WAFERS AND PHOTOPLATES; SEMICONDUCTOR WAFER, CHIP AND PHOTOPLATE IDENTIFYING MATERIALS NAMELY CLIP-ON IDENTIFICATION TAGS AND IDENTIFICATION TAGS FOR TRAYS, CARRIER HOLDING TRAYS, PHOTOPLATE CARRIERS, ADJUSTABLE CARRIERS; SEMICONDUCTOR WAFER CARRIERS AND TRAYS; CARRIERS FOR MAGNETIC STORAGE DISKS, STORAGE BOXES AND COVERS AND SHIPPING CONTAINERS FOR MAGNETIC STORAGE DISKS; LABORATORY EQUIPMENT NAMELY, GRADUATED MEASURING CONTAINERS, BEAKERS, LIQUID STORING PANS, VACUUM PROBES, GAUGE PROTECTORS AND SOLENOID VALVES; CHEMICAL RESISTANT SENSORS, PROBES AND CONNECTING CABLES, DETECTION EQUIPMENT FOR THE PRESENCE OR ABSENCE OF FLUIDS IN PROCESSING ENVIRONMENTS, NAMELY, AUDIO, VISUAL AND ELECTRONIC ALARMS AND MONITORS, BAR CODE TAGS, TRACKING AND READING EQUIPMENT FOR BAR CODE TAGS, RADIO FREQUENCY TRANSPONDER TAGS, EQUIPMENT FOR READING AND TRACKING RADIO FREQUENCY TRANSPONDER TAGS (U.S. CLS. 21, 23, 26, 36 AND 38).

CLASS 17—RUBBER GOODS

FOR PLASTIC TUBES AND PIPES, PLASTIC CONNECTORS AND FITTINGS FOR TUBES AND PIPES NAMELY, UNIONS, REDUCERS, MALE CONNECTORS, TEES, ELBOWS, PANEL MOUNTS, CAPS, PLUGS, NIPPLES, FERRULE NUTS AND PLUGS, BARB FITTINGS, AND TUBE TO PIPE ADAPTERS, AND TUBE TO BARREL CONNECTORS AND COUPLERS, ALL FOR GENERAL INDUSTRIAL USE (U.S. CLS. 1, 5, 12, 13, 35 AND 50).

CLASS 20—FURNITURE AND ARTICLES NOT OTHERWISE CLASSIFIED

FOR PLASTIC SPRAY NOZZLES AND PLASTIC FASTENERS NAMELY, SCREWS, NUTS, AND BOLTS; POWERED AND MANUALLY OPERATED PLASTIC VALVES, PLASTIC BARRELS FOR STORING AND DISPENSING CHEMICALS, PLASTIC LINERS FOR BARRELS FOR STORING AND DISPENSING CHEMICALS, PLASTIC SPRING OPERATED CHECK VALVES, AND PLASTIC PNEUMATICALLY OPERATED VALVES (U.S. CLS. 2, 13, 22, 25, 32 AND 50).

SN 76-066,654. ACTIVELAW.COM, LLC, ANAHEIM, CA. FILED 6-9-2000.

SN 76-066,722. POETIC DIGITAL GROUP, INC., SAN FRANCISCO, CA. FILED 6-5-2000.

ACTIVELAW.COM

CLASS 35—ADVERTISING AND BUSINESS

FOR ADVERTISING SERVICES AND DIRECTORY SERVICES, NAMELY, PROMOTING THE GOODS AND SERVICES OF LAWYERS AND THOSE SELLING TO LAWYERS, ADVERTISING AGENCY SERVICES; PLACING ADVERTISEMENTS FOR OTHERS, BUSINESS MARKETING CONSULTING SERVICES; PROVIDING INFORMATION TO THE PUBLIC ABOUT THE PRODUCTS AND SERVICES OF OTHERS; BUSINESS SERVICES, NAMELY, BUSINESS MANAGEMENT, MARKETING, AND ADVERTISING CONSULTATION; ADVISORY SERVICES FOR LAWYERS IN THE FIELD OF BUSINESS, ADVERTISING, DIRECTORY AND PROMOTION SERVICES, NAMELY, PROMOTING THE SALES OF GOODS AND SERVICES OF OTHERS BY PLACING ADVERTISEMENTS AND DIRECTORY LISTINGS IN ELECTRONIC DATA CENTERS ACCESSED THROUGH A GLOBAL COMPUTER NETWORK (U.S. CLS. 100, 101 AND 102).

CLASS 42—SCIENTIFIC, COMPUTER AND LEGAL SERVICES

FOR ONLINE SOFTWARE APPLICATION SERVICE PROVIDER FEATURING SOFTWARE IN THE FIELD OF LEGAL COMMUNICATION, DATABASE MANAGEMENT, INFORMATION SEARCHING, INFORMATION, NEWS, REFERENCE MATERIALS, COUNSELING AND SERVICES FOR LAWYERS AND CONSUMERS; COMPUTERIZED ON-LINE SERVICES, NAMELY ON-LINE DISTRIBUTION OF INFORMATION OF INTEREST TO LAWYERS AND CONSUMERS LIKELY TO REQUIRE LEGAL SERVICES VIA A GLOBAL COMPUTER NETWORK (U.S. CLS. 100 AND 101).

SN 76-066,694. CALWOOD NUTRITIONALS, INC., BALTIMORE, MD. FILED 6-9-2000.

NUTRAMINE

CLASS 5—PHARMACEUTICALS

FOR ESSENTIAL AMINO ACID SUPPLEMENT FOR USE IN FITNESS TRAINING (U.S. CLS. 6, 18, 44, 46, 51 AND 52).

CLASS 30—STAPLE FOODS

FOR HERBAL FOOD BEVERAGES CONTAINING ESSENTIAL AMINO ACID SUPPLEMENT FOR USE IN FITNESS TRAINING (U.S. CL. 46).

CLASS 32—LIGHT BEVERAGES

FOR NON-CARBONATED, NON-ALCOHOLIC BEVERAGES, NAMELY WATER, FRUIT JUICES, CONTAINING ESSENTIAL AMINO ACIDS AND NUTRITIONAL SUPPLEMENTS (U.S. CLS. 45, 46 AND 48).

SAVOIR FAIRE

CLASS 16—PAPER GOODS AND PRINTED MATTER

FOR MAGAZINE FEATURING INFORMATION ON DIGITAL ANIMATION PRODUCTION AND DIGITAL IMAGE MANIPULATION SERVICES (U.S. CLS. 2, 5, 22, 23, 29, 37, 38 AND 50).

CLASS 41—EDUCATION AND ENTERTAINMENT

FOR COMPUTER SERVICES, NAMELY PROVIDING AN ON-LINE MAGAZINE IN THE FIELD OF DIGITAL ANIMATION PRODUCTION AND DIGITAL IMAGE MANIPULATION (U.S. CLS. 100, 101 AND 107).

SN 76-067,322. BEHLES, MARKUS, D-73033 GOEPPINGEN, FED REP GERMANY, FILED 6-9-2000.

BIOTON

OWNER OF FED REP GERMANY REG. NO. 39985285, DATED 2-10-2000, EXPIRES 12-31-2009.

CLASS 6—METAL GOODS

FOR AMULETS MADE OF METAL; METAL IDENTIFICATION AMULETS FOR HOSPITAL USE (U.S. CLS. 2, 12, 13, 14, 23, 25 AND 50).

CLASS 10—MEDICAL APPARATUS

FOR MEDICAL AND PARAMEDICAL AMULETS, NAMELY, AMULET-SHAPED DEVICES WHICH OPERATE ON THE PRINCIPAL OF BIORESONANCE (U.S. CLS. 26, 39 AND 44).

CLASS 14—JEWELRY

FOR AMULETS (U.S. CLS. 2, 27, 28 AND 50).

SN 76-067,517. LIFETRONICS MEDICAL INC., TORONTO, ONTARIO, CANADA, FILED 6-9-2000.

LIFETRONICS

CLASS 10—MEDICAL APPARATUS

FOR ANESTHETIC DELIVERY APPARATUS AND AN APPARATUS FOR ARTIFICIAL RESPIRATION (U.S. CLS. 26, 39 AND 44).

CLASS 41—EDUCATION AND ENTERTAINMENT

FOR EDUCATION SERVICES, NAMELY, CONDUCTING SEMINARS AND CONDUCTING ON-SITE TRAINING, AND DISTRIBUTING EDUCATION MATERIALS IN CONNECTION THEREWITH RELATED TO MEDICAL PRODUCTS FOR RESPIRATION, CARDIOLOGY AND ANESTHESIOLOGY (U.S. CLS. 100, 101 AND 107).

SN 76-068,707. STAN LEE MEDIA, INC., ENCINO, CA.
FILED 6-13-2000.

CLASS 9—ELECTRICAL AND SCIENTIFIC APPARATUS

FOR SCREEN SAVER COMPUTER SOFTWARE; PRE-RECORDED VIDEO TAPES, VIDEO DISCS AND VIDEO CASSETTES FEATURING MUSIC AND LIVE ACTION OR ANIMATED CARTOONS; CARTRIDGES AND SOFTWARE FOR HANDHELD GAME SYSTEMS; VIDEO GAME CARTRIDGES AND SOFTWARE PROGRAMS FOR VIDEO GAMES; AND COMPUTER GAME PROGRAMS (U.S. CLS. 21, 23, 26, 36 AND 38).

CLASS 25—CLOTHING

FOR CLOTHING, NAMELY HALLOWEEN COSTUMES, SLEEPWEAR, UNDERWEAR, SWIMWEAR, SHIRTS, SHORTS, JACKETS, FOOTWEAR, HEADWEAR, RAINWEAR, SWEAT SHIRTS, PLAY SUITS, AND HOSIERY (U.S. CLS. 22 AND 39).

CLASS 28—TOYS AND SPORTING GOODS

FOR TOYS, GAMES AND PLAYTHINGS, NAMELY, TOY ACTION FIGURES AND ACCESSORIES THEREFORE, BENDABLE FIGURINES, BOARD GAMES, KITES, YO-YOS, TOY WEAPONS, AND INFLATABLE TOYS (U.S. CLS. 22, 23, 38 AND 50).

CLASS 35—ADVERTISING AND BUSINESS

FOR RETAIL STORE SERVICES FEATURING CLOTHING, TOYS, GAMES, AND ELECTRONIC MEDIA, ALL FEATURING ANIMATED CARTOON CHARACTERS (U.S. CLS. 100, 101 AND 102).

SN 76-069,020. AUCLAIR, DENIS JUDE, DBA AUCLAIR'S MARKET, SOMERSET, MA. FILED 6-14-2000.

AUCLAIR'S MARKET

NO CLAIM IS MADE TO THE EXCLUSIVE RIGHT TO USE "MARKET", APART FROM THE MARK AS SHOWN. SEC. 2(F).

CLASS 29—MEATS AND PROCESSED FOODS

FOR MEATS; SEAFOOD; POULTRY AND GAME; FROZEN FRUITS AND VEGETABLES; DAIRY PRODUCTS EXCLUDING ICE CREAM, ICE MILK, AND FROZEN YOGURT; FROZEN ENTRIES CONSISTING PRIMARILY OF MEAT, FISH, OR POULTRY (U.S. CL. 46).

FIRST USE 0-0-1918; IN COMMERCE 0-0-1918.

CLASS 30—STAPLE FOODS

FOR BAKERY GOODS; ICE CREAM, ICE MILK, AND FROZEN YOGURT; MUSTARD; VINEGAR; SAUCES (CONDIMENTS); SPICES (U.S. CL. 46).

FIRST USE 0-0-1918; IN COMMERCE 0-0-1918.

SN 76-069,140. SPECTRA MARKETING SYSTEMS, INC., CHICAGO, IL. FILED 6-13-2000.

TRADE DIMENSIONS

NO CLAIM IS MADE TO THE EXCLUSIVE RIGHT TO USE "TRADE", APART FROM THE MARK AS SHOWN.

CLASS 9—ELECTRICAL AND SCIENTIFIC APPARATUS

FOR ELECTRONIC DATABASES IN THE FIELD OF RETAIL MARKETING AND SALES RECORDED ON COMPUTER MEDIA (U.S. CLS. 21, 23, 26, 36 AND 38).

FIRST USE 10-1-1996; IN COMMERCE 10-1-1996.

CLASS 16—PAPER GOODS AND PRINTED MATTER

FOR NEWSLETTERS FEATURING INFORMATION RELATED TO BUSINESS, MARKETING, DEVELOPMENTS, TRENDS AND LEGAL ISSUES RELATED TO THE FIELD OF RETAIL MARKETING AND SALES (U.S. CLS. 2, 5, 22, 23, 29, 37, 38 AND 50).

FIRST USE 10-1-1996; IN COMMERCE 10-1-1996.

CLASS 35—ADVERTISING AND BUSINESS

FOR PROVIDING AN ON-LINE COMPUTER DATABASE FEATURING TRADE INFORMATION AND MARKET RESEARCH INFORMATION IN THE FIELD OF RETAIL MARKETING AND SALES; AND RETAIL MARKET RESEARCH AND CONSULTING SERVICES (U.S. CLS. 100, 101 AND 102).

FIRST USE 10-1-1996; IN COMMERCE 10-1-1996.

SN 76-069,245. WAUSAU FINANCIAL SYSTEMS INC., WAUSAU, WI. FILED 6-13-2000.

WAUSAU FINANCIAL SYSTEMS

NO CLAIM IS MADE TO THE EXCLUSIVE RIGHT TO USE "FINANCIAL SYSTEMS", APART FROM THE MARK AS SHOWN.

SEC. 2(F).

CLASS 9—ELECTRICAL AND SCIENTIFIC APPARATUS

FOR FINANCIAL PROCESSING SOFTWARE USED BY BANKS, OTHER FINANCIAL INSTITUTIONS AND COMMERCIAL BUSINESSES TO PROCESS CHECKS, REMITTANCES, DEPOSIT SLIPS AND WITHDRAWALS AND MANUALS AND DOCUMENTATION DISTRIBUTED THEREWITH (U.S. CLS. 21, 23, 26, 36 AND 38).

FIRST USE 9-0-1988; IN COMMERCE 9-0-1988.

CLASS 36—INSURANCE AND FINANCIAL

FOR FINANCIAL PROCESSING SERVICES USED BY BANKS, OTHER FINANCIAL INSTITUTIONS AND COMMERCIAL BUSINESSES TO PROCESS CHECKS, REMITTANCES, DEPOSIT SLIPS AND WITHDRAWALS (U.S. CLS. 100, 101 AND 102).

FIRST USE 9-0-1988; IN COMMERCE 9-0-1988.

SN 76-069,950. SYNHRGY HR TECHNOLOGIES, INC.,
HOUSTON, TX. FILED 6-14-2000.

SN 76-069,951. SYNHRGY HR TECHNOLOGIES, INC.,
HOUSTON, TX. FILED 6-14-2000.



SYNHRGY

CLASS 9—ELECTRICAL AND SCIENTIFIC APPARATUS

FOR COMPUTER SOFTWARE FOR USE IN DATA BASE MANAGEMENT IN THE FIELD OF HUMAN RESOURCE MANAGEMENT, AND MANUALS SOLD THEREWITH; COMPUTER SOFTWARE FOR USE IN DATA BASE MANAGEMENT IN THE FIELD OF HUMAN RESOURCE MANAGEMENT THAT MAY BE DOWNLOADED FROM A GLOBAL COMPUTER NETWORK, AND MANUALS SOLD THEREWITH; COMPUTER SOFTWARE USED TO DISPLAY GRAPHS AND CHARTS OF STATISTICAL DATA IN THE FIELD OF HUMAN RESOURCE MANAGEMENT, AND MANUALS SOLD THEREWITH (U.S. CLS. 21, 23, 26, 36 AND 38).

CLASS 35—ADVERTISING AND BUSINESS

FOR COMPUTERIZED DATA BASE MANAGEMENT; PROVIDING INFORMATION IN THE FIELD OF HUMAN RESOURCE MANAGEMENT VIA THE GLOBAL COMPUTER NETWORK; PROVIDING DATA BASES IN THE FIELD OF HUMAN RESOURCES (U.S. CLS. 100, 101 AND 102).

CLASS 38—COMMUNICATION

FOR PROVIDING MULTIPLE-USER ACCESS TO A GLOBAL COMPUTER INFORMATION NETWORK; PROVIDING AN ON-LINE BULLETIN BOARD FOR TRANSMISSION OF MESSAGES AMONG COMPUTER USERS IN THE FIELD OF HUMAN RESOURCES (U.S. CLS. 100, 101 AND 104).

CLASS 39—TRANSPORTATION AND STORAGE

FOR ELECTRONIC STORAGE OF HUMAN RESOURCE INFORMATION; ELECTRONIC DOCUMENT REPOSITORY SERVICES OF HUMAN RESOURCE INFORMATION (U.S. CLS. 100 AND 105).

CLASS 41—EDUCATION AND ENTERTAINMENT

FOR DEVELOPMENT AND DISSEMINATION OF EDUCATION MATERIALS IN THE FIELD OF HUMAN RESOURCES (U.S. CLS. 100, 101 AND 107).

CLASS 9—ELECTRICAL AND SCIENTIFIC APPARATUS

FOR COMPUTER SOFTWARE FOR USE IN DATA-BASE MANAGEMENT IN THE FIELD OF HUMAN RESOURCE MANAGEMENT, AND MANUALS SOLD THEREWITH; COMPUTER SOFTWARE FOR USE IN DATABASE MANAGEMENT IN THE FIELD OF HUMAN RESOURCE MANAGEMENT THAT MAY BE DOWNLOADED FROM A GLOBAL COMPUTER NETWORK, AND MANUALS SOLD THEREWITH; COMPUTER SOFTWARE USED TO DISPLAY GRAPHS AND CHARTS OF STATISTICAL DATA IN THE FIELD OF HUMAN RESOURCE MANAGEMENT, AND MANUALS SOLD THEREWITH (U.S. CLS. 21, 23, 26, 36 AND 38).

CLASS 35—ADVERTISING AND BUSINESS

FOR COMPUTERIZED DATA BASE MANAGEMENT; PROVIDING INFORMATION IN THE FIELD OF HUMAN RESOURCE MANAGEMENT VIA THE GLOBAL COMPUTER NETWORK; PROVIDING DATA BASES IN THE FIELD OF HUMAN RESOURCES (U.S. CLS. 100, 101 AND 102).

CLASS 38—COMMUNICATION

FOR PROVIDING MULTIPLE-USER ACCESS TO A GLOBAL COMPUTER INFORMATION NETWORK; PROVIDING AN ON-LINE BULLETIN BOARD FOR TRANSMISSION OF MESSAGES AMONG COMPUTER USERS IN THE FIELD OF HUMAN RESOURCES (U.S. CLS. 100, 101 AND 104).

CLASS 39—TRANSPORTATION AND STORAGE

FOR ELECTRONIC STORAGE OF HUMAN RESOURCE INFORMATION; ELECTRONIC DOCUMENT REPOSITORY SERVICES OF HUMAN RESOURCE INFORMATION (U.S. CLS. 100 AND 105).

CLASS 41—EDUCATION AND ENTERTAINMENT

FOR DEVELOPMENT AND DISSEMINATION OF EDUCATION MATERIALS IN THE FIELD OF HUMAN RESOURCES (U.S. CLS. 100, 101 AND 107).

SN 76-069,998. SPYLINK, CORPORATION, TAMPA, FL.
FILED 6-14-2000.

SPYLINK

CLASS 9—ELECTRICAL AND SCIENTIFIC APPARATUS

FOR COMPUTER PROGRAMS FOR USE IN PROMOTING BUSINESS AND PROGRAMS USED TO EXCHANGE DATA ON THE INTERNET (U.S. CLS. 21, 23, 26, 36 AND 38).

CLASS 35—ADVERTISING AND BUSINESS

FOR PROVIDING BUSINESS PRESENTATIONS FOR OTHERS (U.S. CLS. 100, 101 AND 102).

CLASS 42—SCIENTIFIC, COMPUTER AND LEGAL SERVICES

FOR COMPUTER SERVICES, NAMELY, DESIGNING, MAINTAINING AND HOSTING WEB SITES FOR OTHERS (U.S. CLS. 100 AND 101).

SN 76-070,559. MERCHANTS OF WOW, STUDIO CITY, CA. FILED 6-15-2000.

JEEPER’S CREEPERS

CLASS 9—ELECTRICAL AND SCIENTIFIC APPARATUS

FOR PRE-RECORDED AUDIO TAPES, COMPACT DISCS, VIDEOTAPES, AND DVDS FEATURING BOTH CHILDREN’S STORIES AND CHILDREN’S PROGRAMS CONTAINING DRAMA, COMEDY, AND CHILDREN’S MUSIC (U.S. CLS. 21, 23, 26, 36 AND 38).

CLASS 16—PAPER GOODS AND PRINTED MATTER

FOR PRINTED PUBLICATIONS, NAMELY BOOKS, MAGAZINES, NEWSLETTERS, AND SONGBOOKS FEATURING CHILDREN’S MUSIC AND CHILDREN’S STORIES; PRINTED SHEET MUSIC (U.S. CLS. 2, 5, 22, 23, 29, 37, 38 AND 50).

CLASS 28—TOYS AND SPORTING GOODS

FOR TOYS, NAMELY, PLUSH TOYS, BOARD GAMES, COMPUTER HANDHELD AND SOFTWARE BASED GAMES, TOY STATUES, PLAY ACTION FIGURES, AND PLAYGROUND BALLS, SOCCER BALLS, AND SPORTS BALLS (U.S. CLS. 22, 23, 38 AND 50).

CLASS 41—EDUCATION AND ENTERTAINMENT

FOR TELEVISION PROGRAMMING FEATURING CHILDREN’S STORIES (U.S. CLS. 100, 101 AND 107).

SN 76-071,956. IWATT CORP., CAMPBELL, CA. FILED 6-16-2000.

IWATT

CLASS 9—ELECTRICAL AND SCIENTIFIC APPARATUS

FOR SEMICONDUCTOR DEVICES USED FOR POWER CONVERTERS (U.S. CLS. 21, 23, 26, 36 AND 38).

CLASS 42—SCIENTIFIC, COMPUTER AND LEGAL SERVICES

FOR DESIGN OF POWER CONVERTERS FOR OTHERS (U.S. CLS. 100 AND 101).

SN 76-071,957. IWATT CORP., CAMPBELL, CA. FILED 6-16-2000.

DIGIWATT

CLASS 9—ELECTRICAL AND SCIENTIFIC APPARATUS

FOR SEMICONDUCTOR DEVICES USED FOR POWER CONVERTERS (U.S. CLS. 21, 23, 26, 36 AND 38).

CLASS 42—SCIENTIFIC, COMPUTER AND LEGAL SERVICES

FOR DESIGN OF POWER CONVERTERS FOR OTHERS (U.S. CLS. 100 AND 101).

SN 76-071,988. HISPANEX, INC., BOSTON, MA. FILED 6-16-2000.

VISTA

THE ENGLISH TRANSLATION OF "VISTA" ALSO MEANS "VIEW" IN SPANISH.

CLASS 9—ELECTRICAL AND SCIENTIFIC APPARATUS

FOR EDUCATIONAL AND TEACHING MATERIALS RELATING TO LANGUAGE INSTRUCTION AT THE COLLEGE LEVEL - NAMELY, EDUCATIONAL SOFTWARE FEATURING LANGUAGE INSTRUCTION AND PRE-RECORDED AUDIO AND VIDEO TAPES FEATURING LANGUAGE INSTRUCTION (U.S. CLS. 21, 23, 26, 36 AND 38).

CLASS 16—PAPER GOODS AND PRINTED MATTER

FOR PRINTED EDUCATIONAL AND TEACHING MATERIALS RELATING TO LANGUAGE INSTRUCTION AT THE COLLEGE LEVEL (U.S. CLS. 2, 5, 22, 23, 29, 37, 38 AND 50).

SN 76-072,308. MOBILIAN CORPORATION, HILLSBORO, OR. FILED 6-15-2000.



CLASS 9—ELECTRICAL AND SCIENTIFIC APPARATUS

FOR COMPUTER HARDWARE, NAMELY, ANALOG AND DIGITAL INTEGRATED CIRCUITS, COMPUTER CHIPS, SEMICONDUCTORS AND CIRCUIT BOARDS, COMPUTER SOFTWARE, AND COMPUTER FIRMWARE, ALL FOR WIRELESS VOICE AND DATA COMMUNICATION BETWEEN ELECTRONIC DEVICES (U.S. CLS. 21, 23, 26, 36 AND 38).

CLASS 38—COMMUNICATION

FOR TELECOMMUNICATIONS SERVICES IN THE FIELDS OF VOICE AND DATA COMMUNICATIONS, NAMELY, WIRELESS VOICE AND DATA TRANSMISSION BETWEEN ELECTRONIC DEVICES (U.S. CLS. 100, 101 AND 104).

CLASS 42—SCIENTIFIC, COMPUTER AND LEGAL SERVICES

FOR NETWORK DESIGN AND ARCHITECTURE SERVICES FOR OTHERS (U.S. CLS. 100 AND 101).

SN 76-074,460. ATHLITIKI ENOSI KONSTANTINOPOLEOS AEK PODOSFERIKI AE, TA A.E.K. P.A.E., ATHENS, GREECE, FILED 6-21-2000.



SN 76-073,650. NEUMAYER HOLDING GMBH, 77756 HAUSACH/DE, FED REP GERMANY, FILED 6-20-2000.

OWNER OF GREECE REG. NO. 119957, DATED 5-18-1995, EXPIRES 5-18-2005.

CLASS 3—COSMETICS AND CLEANING PREPARATIONS

FOR PERFUME (U.S. CLS. 1, 4, 6, 50, 51 AND 52).

CLASS 6—METAL GOODS

FOR KEYHOLDERS, KEY CHAINS AND KEY RINGS, ALL MADE OF METAL (U.S. CLS. 2, 12, 13, 14, 23, 25 AND 50).

CLASS 14—JEWELRY

FOR CLOCKS AND WATCHES (U.S. CLS. 2, 27, 28 AND 50).

CLASS 16—PAPER GOODS AND PRINTED MATTER

FOR PLAYING CARDS; PAPER ARTICLES, NAMELY, POSTERS, STATIONERY, WRITING PAPER, NOTE PAPER, BOOKMARKS, EXERCISE BOOKS, PICTURE BOOKS, SPORTS BOOKS AND SCORE BOOKS; OFFICE REQUISITES, NAMELY, PENS, PENCILS, PEN AND PENCIL BOXES, CASES, HOLDERS AND TRAYS, PAPERWEIGHTS, PENCIL SHARPENERS AND RUBBER BANDS (U.S. CLS. 2, 5, 22, 23, 29, 37, 38 AND 50).

CLASS 18—LEATHER GOODS

FOR BAGS, NAMELY, ALL PURPOSE ATHLETIC AND SPORT BAGS, SCHOOL BAGS, TOTE BAGS AND TRAVEL BAGS; UMBRELLAS AND PARASOLS; KEY CASES AND KEY FOBS MADE OF LEATHER (U.S. CLS. 1, 2, 3, 22 AND 41).

CLASS 20—FURNITURE AND ARTICLES NOT OTHERWISE CLASSIFIED

FOR KEYHOLDERS, KEY CHAINS AND KEY RINGS, ALL NON-METAL (U.S. CLS. 2, 13, 22, 25, 32 AND 50).

CLASS 21—HOUSEWARES AND GLASS

FOR WORRY BEADS, NAMELY, STRINGS OF DECORATIVE GLASS BEADS (U.S. CLS. 2, 13, 23, 29, 30, 33, 40 AND 50).

CLASS 24—FABRICS

FOR TOWELS AND CLOTH FLAGS (U.S. CLS. 42 AND 50).

NFT

PRIORITY CLAIMED UNDER SEC. 44(D) ON FED REP GERMANY APPLICATION NO. 39981073.0/0, FILED 12-21-1999, REG. NO. 39981073.0, DATED 12-21-1999, EXPIRES 12-31-2009.

CLASS 6—METAL GOODS

FOR NON-PRECIOUS METALS AND THEIR ALLOYS, NAMELY, FOR USE IN PASSENGER CARS AND LORRIES; BUILDING MATERIALS OF METAL, NAMELY, NUTS, TWO-PIECE NUTS, SECURITY NUTS; LOCKSMITH'S PRODUCTS, NAMELY, NUTS, BOLTS, SHAFTS AND FASTENERS FOR USE IN PASSENGER CARS AND LORRIES; IRONMONGERY; METAL FASTENING ELEMENTS, NAMELY, RESHAPING AND FORGING PARTS, NAMELY, HUBS, SPINDLES, CV-JOINTS, GEAR PARTS, SHAFTS, DIFFERENTIAL PARTS, TIEROD ENDS, STARTER PARTS, ALTERNATOR CORES, AXLE SHAFTS, BEARING PARTS (U.S. CLS. 2, 12, 13, 14, 23, 25 AND 50).

CLASS 12—VEHICLES

FOR PARTS AND MECHANICAL ELEMENTS FOR THE AUTOMOTIVE INDUSTRY, NAMELY, RESHAPING AND FORGING PARTS, NAMELY, HUBS, SPINDLES, CV-JOINTS, GEAR PARTS, GEAR SHAFTS, DIFFERENTIAL PARTS, TIEROD ENDS, STARTER PARTS, ALTERNATOR CORES, AXLE SHAFTS, BEARING PARTS, MAGNETIC YOKES, BRAKE PISTONS, PINS, PLUGS, PINIONS, CONNECTING RODS, FREE WHEEL RINGS, GEARBOX SHAFTS, BEVEL GEARS, AND INNER RACES (U.S. CLS. 19, 21, 23, 31, 35 AND 44).

CLASS 25—CLOTHING

FOR CLOTHING, NAMELY, SHIRTS, T-SHIRTS, SPORT SHIRTS, POLO SHIRTS AND GOLF SHIRTS, PANTS, JACKETS, COATS, GLOVES, PULLOVERS, RAIN WEAR, SCARVES, SHORTS, SLEEP WEAR, SOCKS, TIES, TOPS, UNDERWEAR AND VESTS; AND SHOES (U.S. CLS. 22 AND 39).

CLASS 28—TOYS AND SPORTING GOODS

FOR ATHLETIC AND SPORTING GOODS, NAMELY, PROTECTIVE PADDING FOR PLAYING SOCCER, EXERCISE MACHINES, GOALKEEPERS' GLOVES, GOLF BAGS, ANKLE, LEG, SHIN AND KNEE GUARDS FOR ATHLETIC USE, SHIN PADS FOR USE IN SOCCER, SOCCER BALLS, SPORTS BALLS (U.S. CLS. 22, 23, 38 AND 50).

CLASS 33—WINES AND SPIRITS

FOR WINES, SPIRITS, NAMELY, BRANDY SPIRITS, DISTILLED SPIRITS, POTABLE SPIRITS, GIN, OUZO, VODKA AND WHISKEY, AND LIQUEURS (U.S. CLS. 47 AND 49).

CLASS 34—SMOKERS' ARTICLES

FOR CIGARETTE LIGHTERS NOT OF PRECIOUS METAL (U.S. CLS. 2, 8, 9 AND 17).

SN 76-076,741. WATT'S ALIMENTOS, S.A., SAN BERNARDO, SANTIAGO, CHILE, FILED 6-26-2000.



THE MARK CONSISTS OF A RED BACKGROUND DESIGN.

CLASS 29—MEATS AND PROCESSED FOODS

FOR MARMALADE AND JAM (U.S. CL. 46).

CLASS 30—STAPLE FOODS

FOR KETCHUP (U.S. CL. 46).

CLASS 32—LIGHT BEVERAGES

FOR CONCENTRATED MIXTURES FOR MAKING FRUIT DRINKS (U.S. CLS. 45, 46 AND 48).

SN 76-075,957. BURKE, SARA, NEW YORK, NY, AND BURKE, PATRICK, NEW YORK, NY. FILED 6-23-2000.



OWNER OF U.S. REG. NO. 2,178,678.
NO CLAIM IS MADE TO THE EXCLUSIVE RIGHT TO USE "FINE FOOD EATERY", APART FROM THE MARK AS SHOWN.

CLASS 30—STAPLE FOODS

FOR COFFEE, COFFEE BEANS, TEA, AND PREPARED SANDWICHES (U.S. CL. 46).
FIRST USE 0-0-1997; IN COMMERCE 0-0-1997.

CLASS 42—SCIENTIFIC, COMPUTER AND LEGAL SERVICES

FOR RESTAURANT, COFFEE SHOP AND DELICATESSEN SERVICES; CATERING SERVICES; PREPARATION OF CUSTOMIZED GIFT BASKETS WITH SELECTED ITEMS REGARDING PARTICULAR OCCASIONS AND/OR THEMES (U.S. CLS. 100 AND 101).
FIRST USE 0-0-1997; IN COMMERCE 0-0-1997.

SN 76-078,714. SYNHRGY HR TECHNOLOGIES, INC., HOUSTON, TX. FILED 6-27-2000.



NO CLAIM IS MADE TO THE EXCLUSIVE RIGHT TO USE "HR", APART FROM THE MARK AS SHOWN.

CLASS 9—ELECTRICAL AND SCIENTIFIC APPARATUS

FOR COMPUTER SOFTWARE FOR USE IN DATABASE MANAGEMENT IN THE FIELD OF HUMAN RESOURCE MANAGEMENT, AND MANUALS SOLD THEREWITH; COMPUTER SOFTWARE FOR USE IN DATABASE MANAGEMENT IN THE FIELD OF HUMAN RESOURCE MANAGEMENT THE MAY BE DOWNLOADED FROM A GLOBAL COMPUTER NETWORK, AND MANUALS SOLD THEREWITH; COMPUTER SOFTWARE USED TO DISPLAY GRAPHS AND CHARTS OF STATISTICAL DATA IN THE FIELD OF HUMAN RESOURCE MANAGEMENT, AND MANUALS SOLD THEREWITH (U.S. CLS. 21, 23, 26, 36 AND 38).

CLASS 35—ADVERTISING AND BUSINESS

FOR COMPUTERIZED DATA BASE MANAGEMENT; PROVIDING INFORMATION IN THE FIELD OF HUMAN RESOURCE MANAGEMENT VIA THE GLOBAL COMPUTER NETWORK; PROVIDING DATA BASES IN THE FIELD OF HUMAN RESOURCES (U.S. CLS. 100, 101 AND 102).

CLASS 38—COMMUNICATION

FOR PROVIDING MULTIPLE-USER ACCESS TO A GLOBAL COMPUTER INFORMATION NETWORK; PROVIDING AN ON-LINE BULLETIN BOARD FOR TRANSMISSION OF MESSAGES AMONG COMPUTER USERS IN THE FIELD OF HUMAN RESOURCES (U.S. CLS. 100, 101 AND 104).

SN 76-080,634. LG AD, ENGLEWOOD CLIFFS, NJ. FILED 6-30-2000.

JOYPHONE**CLASS 39—TRANSPORTATION AND STORAGE**

FOR ELECTRONIC STORAGE OF HUMAN RESOURCE INFORMATION; ELECTRONIC DOCUMENT REPOSITORY SERVICES OF HUMAN RESOURCE INFORMATION (U.S. CLS. 100 AND 105).

CLASS 9—ELECTRICAL AND SCIENTIFIC APPARATUS

FOR WIRELESS TELEPHONES, CELLULAR TELEPHONES, RADIO PAGERS, AND PERSONAL DIGITAL ASSISTANTS (U.S. CLS. 21, 23, 26, 36 AND 38).

CLASS 41—EDUCATION AND ENTERTAINMENT

FOR DEVELOPMENT AND DISSEMINATION OF EDUCATION MATERIALS IN THE FIELD OF HUMAN RESOURCES (U.S. CLS. 100, 101 AND 107).

CLASS 38—COMMUNICATION

FOR TELEPHONE COMMUNICATION SERVICES (U.S. CLS. 100, 101 AND 104).

SN 76-082,462. MICROGAMING SYSTEMS ANSTALT, VA-DUZ, LIECHTENSTEIN, FILED 6-30-2000.

SN 76-080,271. MEDIUM4.COM, INC., NEW YORK, NY. FILED 6-29-2000.

MEDIUM4.COM PULSE**MEGASPIN****CLASS 9—ELECTRICAL AND SCIENTIFIC APPARATUS**

FOR COMPUTER SOFTWARE WHICH FACILITATES DIRECT MARKETING COMMUNICATIONS BETWEEN BUSINESSES AND CUSTOMERS (U.S. CLS. 21, 23, 26, 36 AND 38).

CLASS 9—ELECTRICAL AND SCIENTIFIC APPARATUS

FOR COMPUTER SOFTWARE WHICH ENABLES THE USER TO ACCESS AND PLAY GAMES OF CHANCE OR GAMING OR CASINO-STYLE GAMING; INSTRUCTIONAL MANUALS AND OTHER WRITTEN MATERIALS SOLD OR LICENSED TOGETHER WITH THE SOFTWARE (U.S. CLS. 21, 23, 26, 36 AND 38).

CLASS 35—ADVERTISING AND BUSINESS

FOR COMPUTER SERVICES, NAMELY, PROVIDING DIRECT MARKETING COMMUNICATIONS BETWEEN BUSINESSES AND CUSTOMERS VIA A GLOBAL COMPUTER NETWORK (U.S. CLS. 100, 101 AND 102).

CLASS 41—EDUCATION AND ENTERTAINMENT

FOR ENTERTAINMENT SERVICES, NAMELY, PROVIDING ON-LINE GAMES OF CHANCE AND CASINO-STYLE GAMING SERVICES VIA GLOBAL COMPUTER NETWORKS (U.S. CLS. 100, 101 AND 107).

SN 76-080,442. JLS FOODS INTERNATIONAL, INC., SCHAUMBURG, IL. FILED 6-28-2000.

AMERIPRO

SN 76-082,649. ABC IMAGING, LLC, WASHINGTON, DC. FILED 7-3-2000.

ABC IMAGING

NO CLAIM IS MADE TO THE EXCLUSIVE RIGHT TO USE "IMAGING", APART FROM THE MARK AS SHOWN.

CLASS 29—MEATS AND PROCESSED FOODS

FOR MILK, EGG, AND DAIRY PROTEINS FOR USE AS A FOOD ADDITIVE (U.S. CL. 46).
FIRST USE 7-6-1993; IN COMMERCE 7-6-1993.

CLASS 35—ADVERTISING AND BUSINESS

FOR DIRECT MAIL ADVERTISING; DEVELOPING PROMOTIONAL CAMPAIGNS FOR BUSINESS, NAMELY NEWSLETTERS, FLYERS, MULTIMEDIA PRESENTATIONS; COPYING DOCUMENTS FOR OTHERS; DOCUMENT REPRODUCTION; SALES VOLUME TRACKING FOR OTHERS; RETAIL STORE SERVICES FEATURING SUPPLIES FOR COPIERS AND REPRODUCTION EQUIPMENT NAMELY, COPYING MACHINES, DIAZO MACHINES, LARGE FORMAT PLOTTERS, BINDERY MACHINES, AND LAMINATING MACHINES (U.S. CLS. 100, 101 AND 102).
FIRST USE 6-0-1985; IN COMMERCE 6-0-1985.

CLASS 30—STAPLE FOODS

FOR ADDITIVES FOR NON-NUTRITIONAL PURPOSES FOR USE AS FLAVORING, INGREDIENT, OR FILLER FOR USE IN FOOD PROCESSING (U.S. CL. 46).
FIRST USE 7-6-1993; IN COMMERCE 7-6-1993.

CLASS 37—CONSTRUCTION AND REPAIR

FOR INSTALLATION, CLEANING, AND REPAIR OF COPYING MACHINES, DIAZO MACHINES, LARGE FORMAT PLOTTERS, BINDERY MACHINES, AND LAMINATING MACHINES (U.S. CLS. 100, 103 AND 106).
FIRST USE 6-0-1985; IN COMMERCE 6-0-1985.

CLASS 40—MATERIAL TREATMENT

FOR LAMINATING, BINDING, AND DRYMOUNTING OF BOOKS, PROPOSALS, POSTERS, PHOTOS, EXHIBITS AND BLUEPRINTS (U.S. CLS. 100, 103 AND 106).
FIRST USE 6-0-1985; IN COMMERCE 6-0-1985.

CLASS 42—SCIENTIFIC, COMPUTER AND LEGAL SERVICES

FOR COMPUTER SERVICES, NAMELY, DESIGNING AND IMPLEMENTING WEB SITES FOR OTHERS; COMPUTER PROGRAMMING FOR OTHERS; COMPUTER SERVICES, NAMELY CREATING AND MAINTAINING WEB SITES FOR OTHERS; COMPUTER SOFTWARE DESIGN FOR OTHERS; RENTAL OF COMPUTERS; PORTRAIT PHOTOGRAPHY SERVICES; OFFSET PRINTING; TYPESETTING; GRAPHIC ARTS DESIGN; DESIGN OF TRADE SHOW EXHIBITS; BLUEPRINTING, COMPUTER-AIDED DESIGN AND DRAFTING; SCANNING OF PHOTOGRAPHIC IMAGES, ARTWORK, PAINTINGS, BLUEPRINTS BOOKS, THREE DIMENSIONAL IMAGES, AND POSTERS; COLOR PRINTING; COLOR PLOTTING; DUPLICATION OF CD-ROM RECORDINGS (U.S. CLS. 100 AND 101).
FIRST USE 6-0-1985; IN COMMERCE 6-0-1985.

SN 76-083,168. UP SCIENCE, INC., YOKOHAMA, KANAGAWA-PREFECTURE, 244-8588, JAPAN, FILED 7-5-2000.

UpScience

CLASS 1—CHEMICALS

FOR CHEMICALS, NAMELY, SMALL ORGANIC MOLECULES AND SYNTHETIC ORGANIC COMPOUNDS FOR USE IN LABORATORY RESEARCH AND THE PHARMACEUTICAL INDUSTRY; SCIENTIFIC AND RESEARCH CHEMICALS, NAMELY, ANTIBODIES, PEPTIDES, PROTEINS, RECOMBINANT CELL LINES, BUFFERS AND OTHER REAGENTS AND SOLUTIONS FOR IN VITRO DIAGNOSIS OF NEURODEGENERATIVE DISEASES (U.S. CLS. 1, 5, 6, 10, 26 AND 46).

CLASS 5—PHARMACEUTICALS

FOR CHEMICAL RESINS TO PURIFY DNA AND OTHER BIOLOGICAL MOLECULES FOR MEDICAL AND DIAGNOSTIC USES; SANITARY PREPARATIONS, NAMELY, MEDICAL SHAMPOOS, ANTIBACTERIAL FACE LOTIONS, AND ANTIBACTERIAL HAND WASHING AGENTS; SANITARY PREPARATIONS IN THE NATURE OF SANITIZERS FOR HOUSEHOLD, HOSPITAL, INSTITUTIONAL AND INDUSTRIAL USE; PHARMACEUTICAL PREPARATIONS FOR THE TREATMENT OF CANCER AND INFLAMMATION (U.S. CLS. 6, 18, 44, 46, 51 AND 52).

CLASS 42—SCIENTIFIC, COMPUTER AND LEGAL SERVICES

FOR QUALITY CONTROL OF PHARMACEUTICAL PRODUCTS FOR OTHERS IN THE FIELD OF THE ADMISSION OF NEW MEDICAMENTS; DEVELOPMENT OF PHARMACEUTICAL QUALITY CONTROL METHODS FOR OTHERS IN THE FIELD OF THE ADMISSION OF NEW MEDICAMENTS; CLINICAL TESTS AND STUDIES FOR OTHERS ON THE EFFICIENCY OF MEDICAMENTS; ENVIRONMENTAL CONSULTATION REGARDING CHEMICAL ANALYSES; DEVELOPMENT OF BIOLOGICAL TECHNOLOGICAL PROCESSES FOR OTHERS IN THE FIELD OF MEDICAMENTS; PHARMACEUTICAL CONSULTING, CHEMICAL ANALYSIS OF MEDICAMENTS FOR OTHERS; DEVELOPMENT OF PHARMACEUTICAL PRODUCTS AND SUBSTANCES FOR OTHERS (U.S. CLS. 100 AND 101).

SN 76-083,698. HIGHJUMP SOFTWARE, INC., EDEN PRAIRIE, MN. BY CHANGE OF NAME DATA COLLECTION SYSTEMS, INC., EDEN PRAIRIE, MN. FILED 7-5-2000.

HIGHJUMP SOFTWARE

NO CLAIM IS MADE TO THE EXCLUSIVE RIGHT TO USE "SOFTWARE", APART FROM THE MARK AS SHOWN.

CLASS 9—ELECTRICAL AND SCIENTIFIC APPARATUS

FOR COMPUTER SOFTWARE AND HARDWARE FOR COLLECTING, MANAGING AND WAREHOUSING DATA, FULFILLING ELECTRONIC ORDERS, AND PROVIDING WAREHOUSE MANAGEMENT SOLUTIONS (U.S. CLS. 21, 23, 26, 36 AND 38).
FIRST USE 7-12-2000; IN COMMERCE 7-21-2000.

CLASS 37—CONSTRUCTION AND REPAIR

FOR INSTALLATION AND MAINTENANCE OF COMPUTER SOFTWARE AND HARDWARE FOR COLLECTING, MANAGING AND WAREHOUSING DATA, FULFILLING ELECTRONIC ORDERS, AND PROVIDING WAREHOUSE MANAGEMENT SOLUTIONS (U.S. CLS. 100, 103 AND 106).
FIRST USE 7-21-2000; IN COMMERCE 7-21-2000.

CLASS 41—EDUCATION AND ENTERTAINMENT

FOR PROVIDING TRAINING IN THE FIELD OF DATA COLLECTION, WAREHOUSE MANAGEMENT AND ELECTRONIC FULFILLMENT (U.S. CLS. 100, 101 AND 107).
FIRST USE 7-21-2000; IN COMMERCE 7-21-2000.

CLASS 42—SCIENTIFIC, COMPUTER AND LEGAL SERVICES

FOR DESIGN AND DEVELOPMENT SERVICES FOR OTHERS, NAMELY, PROVIDING DATA COLLECTION, WAREHOUSE MANAGEMENT AND ELECTRONIC FULFILLMENT SERVICES INCORPORATING COMPUTER SOFTWARE AND HARDWARE, AND ASSOCIATED TECHNICAL SUPPORT (U.S. CLS. 100 AND 101).
FIRST USE 7-21-2000; IN COMMERCE 7-21-2000.

SN 76-084,053. NITAL TRADING COMPANY INC., CORAL GABLES, FL. FILED 7-6-2000.

EL TINAJON

THE ENGLISH TRANSLATION OF "EL TINAJON" IS "LARGE EARTHENWARE JAR".

CLASS 29—MEATS AND PROCESSED FOODS

FOR PROCESSED MEATS BEEF, PORK, POULTRY, FRESH BEEF; COTTAGE CHEESE, CREAM CHEESE, HOLLAND CHEESE, PROCESSED CHEESE LOAVES; EVAPORATED AND CONDENSED MILK; FROZEN VEGETABLES, DRIED RED, BLACK, WHITE BEANS; PROCESSED LEGUMES; EDIBLE OILS, AND LARD (U.S. CL. 46).

CLASS 30—STAPLE FOODS

FOR COFFEE; SUGAR; AND RICE (U.S. CL. 46).

SN 76-085,693. MARUO CALCIUM COMPANY LIMITED, HOYGO, JAPAN, FILED 7-7-2000.

CALFOOD

CLASS 1—CHEMICALS

FOR CHEMICALS, NAMELY, INORGANIC SALTS FOR USE IN THE PLASTIC INDUSTRY, FOR USE IN SCIENCE, PHOTOGRAPHY, AGRICULTURE, HORTICULTURE AND FORESTRY (U.S. CLS. 1, 5, 6, 10, 26 AND 46).

CLASS 5—PHARMACEUTICALS

FOR PHARMACEUTICAL PREPARATIONS, NAMELY, NUTRIENT SUPPLEMENTS, TONICS, NAMELY, MEDICAL TONICS FOR THE PREVENTION AND TREATMENT OF OSTEOPOROSIS, AND MEDICINAL ALTERNATIVES, NAMELY, CALCIUM PREPARATIONS; FOOD FOR INFANTS (U.S. CLS. 6, 18, 44, 46, 51 AND 52).

CLASS 29—MEATS AND PROCESSED FOODS

FOR MEAT, FISH FOR FOOD PURPOSES, TOFU, BOILED FISH PASTE, POULTRY AND GAME; MEAT EXTRACTS; PRESERVED, DRIED AND COOKED FRUITS AND VEGETABLES, JELLIES, JAMS, FRUIT SAUCES; MILK AND MILK PRODUCTS, NAMELY, CREAM, CHEESE, BUTTER, LACTIC DRINKS, POWDERED MILK, CONDENSED MILK, SOY BEAN MILK (U.S. CL. 46).

CLASS 30—STAPLE FOODS

FOR COFFEE, TEA, COCOA, ARTIFICIAL COFFEE; FLOUR AND PREPARATIONS MADE FROM CEREALS, NAMELY, BREAD, PASTRY AND CONFECTIONERY CAKES, HONEY, CHIPS FOR BAKING, BISCUITS; CONDIMENTS, NAMELY, KETCHUP, MUSTARD, MAYONNAISE, SAUCES, SALAD DRESSINGS, HONEY, SPICES (U.S. CL. 46).

CLASS 32—LIGHT BEVERAGES

FOR MINERAL AND AERATED WATER AND OTHER NON-ALCOHOLIC DRINKS, NAMELY, FRUIT DRINKS AND FRUIT JUICES; SYRUPS AND OTHER PREPARATIONS, NAMELY, POWDERS AND LIQUIDS FOR MAKING BEVERAGES, NAMELY, LEMONADES, CIDER, ISOTONIC BEVERAGES, NON-ALCOHOLIC NECTARS, VEGETABLE JUICES, ORANGE JUICES, GRAPE JUICE, PINEAPPLE JUICE (U.S. CLS. 45, 46 AND 48).

SN 76-087,163. BERRY, STEVEN E., TOLUCA, CA. FILED 7-11-2000.

AAH4

CLASS 41—EDUCATION AND ENTERTAINMENT

FOR EDUCATIONAL SERVICES, NAMELY ORGANIZING AND CONDUCTING LECTURES, WORKSHOPS, SEMINARS, CLASSES, INDIVIDUAL INSTRUCTION, AND OTHER PROGRAMS IN THE FIELDS OF PSYCHOLOGY, SPIRITUAL AWARENESS, SELF-IMPROVEMENT, PERSONAL DEVELOPMENT, RELIGIOUS TEACHINGS, CIVIC RESPONSIBILITY, UNDERSTANDING AND COOPERATING WITH DIFFERING CULTURES AND RELIGIOUS SECTORS, AND RELATED INSPIRATIONAL SUBJECTS, AND DISTRIBUTING COURSE MATERIAL, LITERATURE, AND PUBLICATIONS IN CONNECTION THEREWITH (U.S. CLS. 100, 101 AND 107).

CLASS 42—SCIENTIFIC, COMPUTER AND LEGAL SERVICES

FOR CHARITABLE AND RELIGIOUS SERVICES TO FOSTER GLOBAL UNDERSTANDING, NAMELY, PROMOTING PUBLIC AWARENESS OF THE NEED FOR FELLOWSHIP, COMMUNITY AWARENESS, AND FAMILY VIRTUES; PROVIDING AN ONLINE WEBSITE VIA A GLOBAL COMPUTER NETWORK FEATURING INFORMATION IN THE FIELD OF CHARITABLE AND RELIGIOUS SERVICES (U.S. CLS. 100 AND 101).

SN 76-088,004. TRESPA INTERNATIONAL B.V., WEERT, NETHERLANDS, FILED 7-13-2000.

VIRTUON

PRIORITY CLAIMED UNDER SEC. 44(D) ON BENELUX APPLICATION NO. 0964595, FILED 5-12-2000, REG. NO. 0670757, DATED 5-12-2000, EXPIRES 5-12-2010.

CLASS 19—NON-METALLIC BUILDING MATERIALS

FOR NON-METAL PANELS FOR BUILDING; BOARDS FOR WALL PANELING AND FACADES; NON-METAL PARTITION WALLS (U.S. CLS. 1, 12, 33 AND 50).

CLASS 20—FURNITURE AND ARTICLES NOT OTHERWISE CLASSIFIED

FOR FURNITURE PARTS, NAMELY, BOARDS AND PANELS USED AS COMPONENT PARTS OF FURNITURE FOR HOUSEHOLD AND INDUSTRIAL PURPOSES (U.S. CLS. 2, 13, 22, 25, 32 AND 50).

SN 76-089,259. ZEBANK, SOCIETE ANONYME, PARIS, FRANCE, BY CHANGE OF NAME IFP SOCIETE ANONYME, 59700 MARCQ EN BAROEUL, FRANCE, FILED 7-14-2000.

ZE CREDIT

OWNER OF FRANCE REG. NO. 99824651, DATED 11-23-1999, EXPIRES 11-23-2009.

NO CLAIM IS MADE TO THE EXCLUSIVE RIGHT TO USE "CREDIT", APART FROM THE MARK AS SHOWN.

CLASS 9—ELECTRICAL AND SCIENTIFIC APPARATUS

FOR DATA PROCESSING EQUIPMENT, NAMELY DATA PROCESSORS, COMPUTERS, COMPUTER PROGRAMS AND COMPUTER SOFTWARE FOR USE IN DATABASE MANAGEMENT IN THE FIELD OF INSURANCE AND FINANCE, BLANK OPTICAL COMPACT DISCS, BLANK AUDIO AND VIDEO COMPACT DISCS (U.S. CLS. 21, 23, 26, 36 AND 38).

CLASS 35—ADVERTISING AND BUSINESS

FOR ADVERTISING AGENCIES, BUSINESS MANAGEMENT, BUSINESS CONSULTING, BUSINESS INVESTIGATIONS; ORGANIZATION OF EXHIBITS AND EVENTS FOR COMMERCIAL OR ADVERTISING PURPOSES, NAMELY, RENTAL OF ADVERTISING SPACE; ADVERTISING MANAGEMENT; COMPUTERIZED FILE MANAGEMENT (U.S. CLS. 100, 101 AND 102).

CLASS 36—INSURANCE AND FINANCIAL

FOR INSURANCE SERVICES, NAMELY, INSURANCE AND REINSURANCE UNDERWRITING SERVICES IN THE FIELD OF FIRE, ACCIDENT, MISCELLANEOUS RISKS, CASUALTY, CREDIT, PERSONAL LIABILITY, LIFE, MARITAL, MARINE, PROPERTY, UNIVERSAL LIABILITY, PREPAID LEGAL EXPENSE AND TRIP CANCELLATION INSURANCE; INSURANCE BROKERAGE; FINANCIAL AFFAIRS, NAMELY, FINANCIAL FUND INVESTMENTS CONSULTANCY; FUND INVESTMENTS CAPITAL INVESTMENT CONSULTATION; BROKERAGE ASSETS MANAGEMENT; MUTUAL FUNDS INVESTMENTS AND FUND INVESTMENTS; FINANCIAL PLANNING AND FINANCIAL PORTFOLIO MANAGEMENT, FINANCIAL ANALYSIS AND CONSULTATION, FINANCIAL MANAGEMENT, FINANCIAL RESEARCH, PROVIDING FINANCIAL INFORMATION, FINANCIAL EVALUATION AND ESTIMATION OF PERSONAL PROPERTY AND REAL ESTATE; WEALTH AND ASSET MANAGEMENT; AND ADMINISTRATION AND MANAGEMENT OF ASSETS ON BEHALF OF INSURANCE COMPANIES, MONETARY AFFAIRS, NAMELY, THE PURCHASE AND SALE OF DOMESTIC AND FOREIGN MONIES, THE ISSUANCE AND REDEMPTION OF MONEY ORDERS; BANKING; REAL ESTATE AFFAIRS NAMELY, MANAGEMENT OF REAL ESTATE, REAL ESTATE ESTIMATION AND VALUATION SERVICES, REAL PROPERTY MANAGEMENT SERVICES, REAL ESTATE AGENCY SERVICE, RENTAL OF RESIDENTIAL REAL ESTATE, AND RECOVERY OF RENTAL HOUSING; FINANCIAL CONSULTANCY; SAVINGS BANK SERVICES, BANKING SERVICES AND MORTGAGE SERVICES; STOCKS AND BONDS BROKERAGE; FINANCIAL MANAGEMENT; PROVIDING INFORMATION IN THE FIELD OF BANKING AND FINANCE; PROVIDING A COMPUTER DATABASE IN THE FIELD OF FINANCE (U.S. CLS. 100, 101 AND 102).

CLASS 38—COMMUNICATION

FOR TELECOMMUNICATIONS SERVICES, NAMELY, DELIVERY OF MESSAGES BY ELECTRONIC TRANSMISSION VIA CELL PHONE OR COMPUTER; ELECTRONIC TRANSMISSION OF COMMUNICATIONS, NAMELY, MESSAGES AND DATA, BY COMPUTER TERMINALS; TELECOMMUNICATIONS BY RADIO, BY TELEPHONE, RADIO BROADCASTING; TELEVISION BROADCASTING; ELECTRONIC MAIL; INFORMATION TRANSMISSION VIA TELEMATICS, AND IN PARTICULAR FINANCIAL ORDER MAILING; ELECTRONIC COMMUNICATIONS TRANSMISSION ON ANY MULTIMEDIA CARRIERS NAMELY, CELL PHONES AND COMPUTERS IN PARTICULAR FINANCIAL ORDER MAILING, NAMELY; TELECOMMUNICATIONS SERVICES, NAMELY, PROVIDING ON-LINE ACCESS TO THE COMPUTER DATABASES OF OTHERS; PROVIDING MULTIPLE USER ACCESS TO A GLOBAL COMPUTER NETWORK (U.S. CLS. 100, 101 AND 104).

CLASS 42—SCIENTIFIC, COMPUTER AND LEGAL SERVICES

FOR COMPUTER PROGRAMMING FOR OTHERS; NEWS AGENCIES AND INFORMATION AGENCIES, NAMELY GATHERING AND DISSEMINATION OF NEWS (U.S. CLS. 100 AND 101).

SN 76-090,176. HANIMAX, LLC, NEW YORK, NY. FILED 7-14-2000.

NICOLETTA VON HEIDEGGER

CLASS 18—LEATHER GOODS

FOR BAGS, NAMELY, TOTE BAGS, SHOULDER BAGS, ALL-PURPOSE SPORTS BAGS, BACKPACK BAGS, TRAVEL BAGS, BEACH BAGS, HANDBAGS, WALLETS, PURSES, BUSINESS CARD AND CREDIT CARD AND CALLING CARD CASES, KEY CASES; MAKE-UP BAGS, TOILETRY BAGS AND COSMETIC CASES SOLD EMPTY; LIPSTICK HOLDERS AND UMBRELLAS (U.S. CLS. 1, 2, 3, 22 AND 41).

CLASS 21—HOUSEWARES AND GLASS

FOR COSMETIC BRUSHES (U.S. CLS. 2, 13, 23, 29, 30, 33, 40 AND 50).

SN 76-090,203. FRIATEC AKTIENGESELLSCHAFT, D-68229 MANNHEIM, FED REP GERMANY, FILED 7-17-2000.

FRIAFIT

OWNER OF FED REP GERMANY REG. NO. 2084053, DATED 11-7-1994, EXPIRES 11-7-2004.

OWNER OF U.S. REG. NOS. 1,456,091, 2,264,226 AND OTHERS.

CLASS 7—MACHINERY

FOR PIPE TAPPING DRILLS AND MOTORIZED PIPE CUTTERS (U.S. CLS. 13, 19, 21, 23, 31, 34 AND 35).

CLASS 8—HAND TOOLS

FOR MANUALLY OPERATED PIPE SCRAPERS, MANUALLY OPERATED PIPE CUTTERS, MANUALLY OPERATED PIPE TAPPING DRILLS, MANUALLY OPERATED PIPE CLAMPS (U.S. CLS. 23, 28 AND 44).

CLASS 9—ELECTRICAL AND SCIENTIFIC APPARATUS

FOR POWER SUPPLIES FOR ELECTROFUSION WELDING, ELECTROFUSION WELDING POWER CABLES, ELECTROFUSION WELDING CONTROL UNITS, AND ELECTRICAL CONNECTORS FOR ELECTROFUSION WELDING POWER CABLES (U.S. CLS. 21, 23, 26, 36 AND 38).

CLASS 17—RUBBER GOODS

FOR PLASTIC PIPES, INSPECTION WELL CONNECTION ADAPTERS FOR PLASTIC PIPES, PLASTIC INSERTION SLEEVES FOR NON-METAL PIPE CONNECTORS, PLASTIC PIPE CONNECTION SLEEVES, NON-METAL SEALING RINGS FOR PIPE CONNECTIONS, ELECTROFUSION PLASTIC PIPE WELDING COLLARS PREDOMINANTLY OF PLASTIC, PLASTIC PIPE TAPPING SADDLES, PLASTIC PIPE ELBOWS, PLASTIC PIPE TEES, PLASTIC PIPE BRANCHING Y'S, PIPE REDUCING COLLARS FOR PLASTIC PIPE, EX-CENTRIC TRANSITION FITTINGS FOR PLASTIC PIPE, PUSH FIT PIPE CONNECTORS FOR PLASTIC PIPE, PLASTIC PIPE SPIGOT ENDS, PLASTIC LINERS FOR METAL OR NON-METAL WASTE OR SEWER PIPES, PLASTIC LINERS FOR CONCRETE CATCH BASINS, SEWERS AND INSPECTION WELLS (U.S. CLS. 1, 5, 12, 13, 35 AND 50).

CLASS 19—NON-METALLIC BUILDING MATERIALS

FOR PREFABRICATED CONCRETE INSPECTION WELLS FOR UNDERGROUND PIPES (U.S. CLS. 1, 12, 33 AND 50).

SN 76-090,848. BIOENERGY INC., HAM LAKE, MN. FILED 7-18-2000.

THE CORVALEN PROGRAM

NO CLAIM IS MADE TO THE EXCLUSIVE RIGHT TO USE "PROGRAM", APART FROM THE MARK AS SHOWN.

CLASS 41—EDUCATION AND ENTERTAINMENT

FOR EDUCATION AND TRAINING IN THE FIELD OF NUTRITION, SELECTION AND USE OF NUTRITIONAL SUPPLEMENTS, HEALTH AND FITNESS AND EXERCISE PROGRAMS, PROVIDED IN SEMINARS, PUBLICATIONS AND THROUGH A GLOBAL COMPUTER NETWORK (U.S. CLS. 100, 101 AND 107).

CLASS 42—SCIENTIFIC, COMPUTER AND LEGAL SERVICES

FOR CONSULTING SERVICES IN THE FIELD OF NUTRITION, SELECTION AND USE OF NUTRITIONAL SUPPLEMENTS, HEALTH AND FITNESS AND EXERCISE PROGRAMS HOSTING AN INTERACTIVE WEB SITE THAT TRACKS INFORMATION ON SPECIFIC INDIVIDUALS WITH REGARD TO NUTRITION, SELECTION AND USE OF NUTRITIONAL SUPPLEMENTS, HEALTH, AND FITNESS AND EXERCISE PROGRAMS HOSTING A WEB SITE THAT PROVIDES GENERAL INFORMATION WITH REGARD TO NUTRITION, SELECTION AND USE OF NUTRITIONAL SUPPLEMENTS, HEALTH AND FITNESS AND EXERCISE PROGRAMS (U.S. CLS. 100 AND 101).

SN 76-090,991. HEIDELBERGER DRUCKMASCHINEN AKTIENGESELLSCHAFT, 69115 HEIDELBERG, FED REP GERMANY, FILED 7-18-2000.

HYDROSTAR

PRIORITY CLAIMED UNDER SEC. 44(D) ON FED REP GERMANY APPLICATION NO. 30004973.0, FILED 1-25-2000, REG. NO. 30004973, DATED 3-17-2000, EXPIRES 1-31-2010.

CLASS 7—MACHINERY

FOR CENTRAL SUPPLY DEVICES FOR SUPPLYING DAMPENING SOLUTION FOR PRESS ROOM MACHINES, IN PARTICULAR FOR SHEET-FED OFFSET PRINTING PRESSES (U.S. CLS. 13, 19, 21, 23, 31, 34 AND 35).

CLASS 9—ELECTRICAL AND SCIENTIFIC APPARATUS

FOR CONTROL CONSOLES, CONTROL DEVICES, AND SOFTWARE FOR CONTROLLING DAMPENING SOLUTION SUPPLY DEVICES FOR PRESSROOM MACHINES (U.S. CLS. 21, 23, 26, 36 AND 38).

SN 76-091,412. SAUFLON PHARMACEUTICALS LIMITED, MIDDLESEX, TW1 3LP, UNITED KINGDOM, FILED 7-18-2000.

SAUFLON MULTIVUE

PRIORITY CLAIMED UNDER SEC. 44(D) ON ERPN CMNTY TM OFC APPLICATION NO. 1662964, FILED 5-10-2000, REG. NO. 1662964, DATED 5-10-2000, EXPIRES 5-10-2010.

CLASS 5—PHARMACEUTICALS

FOR STERILIZING SOLUTIONS, PROTEIN REMOVERS WETTING SOLUTIONS AND CLEANING PREPARATIONS FOR CONTACT LENSES; OPHTHALMIC AND OPHTHALMOLOGICAL PREPARATIONS FOR THE CARE OF CONTACT LENSES; EYEWASH; EYE DROPS; EYE LOTIONS AND EYE MOISTURIZERS FOR MEDICAL USE; DIAGNOSTIC PREPARATIONS FOR MEDICAL AND OPHTHALMIC USE (U.S. CLS. 6, 18, 44, 46, 51 AND 52).

CLASS 9—ELECTRICAL AND SCIENTIFIC APPARATUS

FOR CONTACT LENSES; TINTED, SOFT, HARD, GAS PERMEABLE AND DISPOSABLE CONTACT LENSES; CASES, HOLDERS AND CONTAINERS FOR CONTACT LENSES; OPHTHALMIC, AND OPTICAL FRAMES, LENSES, GLASS AND GLASSES; SUNGLASSES; MONOCLES; EYEGASSES AND SPECTACLES; CASES, HOLDERS AND CONTAINERS FOR SUNGLASSES, MONOCLES, EYEGASSES AND SPECTACLES; CASES, HOLDERS AND CONTAINERS FOR CLEANING SUNGLASSES; MONOCLES, EYEGASSES AND SPECTACLES; PROTECTIVE EYE SHADES; CHAINS AND CORDS FOR SUNGLASSES, MONOCLES, EYEGASSES AND SPECTACLES (U.S. CLS. 21, 23, 26, 36 AND 38).

CLASS 10—MEDICAL APPARATUS

FOR OPHTHALMOLOGICAL FRAMES, LENSES, GLASS AND GLASSES; OPHTHALMIC, OPTOMETRIC AND OPHTHALMOLOGICAL APPARATUS AND INSTRUMENTS ALL FOR MEDICAL USE IN THE TREATMENT OF EYE DISEASES AND CONDITIONS; MEDICAL APPARATUS AND INSTRUMENTS FOR USE IN THE TREATMENT OF EYE DISEASES AND CONDITIONS, NAMELY, EYE BATHS, EYE SHIELDS AND EYE TRAYS; ARTIFICIAL EYES; INTRACULAR LENSES FOR SURGICAL IMPLANTATION (U.S. CLS. 26, 39 AND 44).

SN 76-091,705. MYWEATHER, LLC, MADISON, WI. FILED 7-19-2000.

MYWEATHER**CLASS 9—ELECTRICAL AND SCIENTIFIC APPARATUS**

FOR COMPUTER SOFTWARE FOR COLLECTING, ANALYZING, AND DISPLAYING REAL-TIME AND HISTORICAL WEATHER INFORMATION (U.S. CLS. 21, 23, 26, 36 AND 38).

CLASS 42—SCIENTIFIC, COMPUTER AND LEGAL SERVICES

FOR PROVIDING WEATHER-RELATED INFORMATION VIA THE INTERNET (U.S. CLS. 100 AND 101).

SN 76-091,687. ABOUT.COM, INC., NEW YORK, NY. FILED 7-17-2000.

THE HUMAN INTERNET

NO CLAIM IS MADE TO THE EXCLUSIVE RIGHT TO USE "INTERNET", APART FROM THE MARK AS SHOWN.

SN 76-091,966. COMPRO-TAX, INC., BEAUMONT, TX. FILED 7-20-2000.

CLASS 35—ADVERTISING AND BUSINESS

FOR PROVIDING NEWS AND INFORMATION IN THE FIELD OF BUSINESS BY MEANS OF A GLOBAL COMPUTER NETWORK (U.S. CLS. 100, 101 AND 102).
FIRST USE 6-0-2000; IN COMMERCE 6-0-2000.

CLASS 36—INSURANCE AND FINANCIAL

FOR PROVIDING NEWS AND INFORMATION IN THE FIELD OF FINANCE BY MEANS OF A GLOBAL COMPUTER NETWORK (U.S. CLS. 100, 101 AND 102).
FIRST USE 6-0-2000; IN COMMERCE 6-0-2000.

**CLASS 39—TRANSPORTATION AND STORAGE**

FOR PROVIDING NEWS AND INFORMATION IN THE FIELD OF TRAVEL BY MEANS OF A GLOBAL COMPUTER NETWORK (U.S. CLS. 100 AND 105).
FIRST USE 6-0-2000; IN COMMERCE 6-0-2000.

CLASS 41—EDUCATION AND ENTERTAINMENT

FOR PROVIDING NEWS AND INFORMATION IN THE FIELDS OF ENTERTAINMENT, ARTS, CULTURE, EDUCATION, AND SPORTS BY MEANS OF A GLOBAL COMPUTER NETWORK (U.S. CLS. 100, 101 AND 107).
FIRST USE 6-0-2000; IN COMMERCE 6-0-2000.

CLASS 42—SCIENTIFIC, COMPUTER AND LEGAL SERVICES

FOR PROVIDING NEWS AND INFORMATION IN THE FIELDS OF CAREERS, COMPUTING, SCIENCE, RELIGION, FAMILIES, HEALTH, HOBBIES, FOOD, RELATIONSHIPS, AND SOCIAL EVENTS OF LOCAL INTEREST ALL BY MEANS OF A GLOBAL COMPUTER NETWORK (U.S. CLS. 100 AND 101).
FIRST USE 6-0-2000; IN COMMERCE 6-0-2000.

NO CLAIM IS MADE TO THE EXCLUSIVE RIGHT TO USE "TAX RETURN PROCESSING SERVICES" AND "INC.", APART FROM THE MARK AS SHOWN.

CLASS 35—ADVERTISING AND BUSINESS

FOR TAX PREPARATION, BOOKKEEPING, ACCOUNT SERVICES AND SMALL BUSINESS CONSULTATION (U.S. CLS. 100, 101 AND 102).
FIRST USE 7-1-1984; IN COMMERCE 7-1-1984.

CLASS 41—EDUCATION AND ENTERTAINMENT

FOR SEMINARS AND CLASSES IN THE FIELD OF TAX PREPARATION AND FEDERAL INCOME TAX LAWS (U.S. CLS. 100, 101 AND 107).
FIRST USE 7-1-1984; IN COMMERCE 7-1-1984.

SN 76-092,399. BROADWAY ENTERTAINMENT MARKETING, INC., DBA CELEBRITY EDGE, SANTA MONICA, CA. FILED 7-19-2000.



NO CLAIM IS MADE TO THE EXCLUSIVE RIGHT TO USE "CELEBRITY", APART FROM THE MARK AS SHOWN. THE STIPPLING SHOWN IN THE DRAWING IS A FEATURE OF THE MARK AND IS NOT INTENDED TO INDICATE COLOR.

CLASS 35—ADVERTISING AND BUSINESS

FOR BUSINESS MARKETING CONSULTING SERVICES FOR OTHERS IN THE ENTERTAINMENT INDUSTRY AND DEVELOPING PROMOTIONAL CAMPAIGNS FOR OTHERS IN THE ENTERTAINMENT INDUSTRY (U.S. CLS. 100, 101 AND 102).
FIRST USE 12-15-1998; IN COMMERCE 12-15-1998.

CLASS 38—COMMUNICATION

FOR TELEVISION BROADCASTING IN THE NATURE OF AN ONGOING SERIES ABOUT A WIDE RANGE OF SUBJECTS FOCUSED UPON THE ENTERTAINMENT INDUSTRY (U.S. CLS. 100, 101 AND 104).
FIRST USE 12-15-1998; IN COMMERCE 12-15-1998.

CLASS 41—EDUCATION AND ENTERTAINMENT

FOR PROVIDING INFORMATION ABOUT A WIDE RANGE OF SUBJECTS FOCUSED UPON THE ENTERTAINMENT INDUSTRY (U.S. CLS. 100, 101 AND 107).
FIRST USE 12-15-1998; IN COMMERCE 12-15-1998.

SN 76-095,816. ESENTIA SYSTEMS, INC., OAK BROOK, IL. FILED 7-25-2000.

ESENTIA

CLASS 35—ADVERTISING AND BUSINESS

FOR BUSINESS MANAGEMENT SERVICES, NAMELY MANAGEMENT AND DEVELOPMENT OF CUSTOMER RELATIONS; COMPUTERIZED DATABASE MANAGEMENT; AND BUSINESS CONSULTATION SERVICES, NAMELY PROJECT MANAGEMENT FOR OTHERS (U.S. CLS. 100, 101 AND 102).
FIRST USE 1-0-2000; IN COMMERCE 1-0-2000.

CLASS 42—SCIENTIFIC, COMPUTER AND LEGAL SERVICES

FOR COMPUTER SERVICES, NAMELY DESIGNING AND IMPLEMENTING WEB SITES AND CUSTOM WEB BASED APPLICATIONS FOR OTHERS, SOFTWARE DESIGN FOR OTHERS; COMPUTER CONSULTATION; AND DATABASE DEVELOPMENT (U.S. CLS. 100 AND 101).
FIRST USE 1-0-2000; IN COMMERCE 1-0-2000.

SN 76-096,208. AUCTION BROKER SOFTWARE, INC., TAMPA, FL. FILED 7-25-2000.

SILANTA

CLASS 9—ELECTRICAL AND SCIENTIFIC APPARATUS

FOR COMPUTER SOFTWARE FOR USE IN ORGANIZING, AND OPERATING ONLINE AUCTIONS INCLUDING DATABASE MANAGEMENT, INVENTORY MANAGEMENT AND AUCTION BIDDING IN THE FIELDS OF AUCTIONS AND INTERACTIVE ELECTRONIC COMMERCE (U.S. CLS. 21, 23, 26, 36 AND 38).

CLASS 35—ADVERTISING AND BUSINESS

FOR BUSINESS CONSULTATION SERVICES, NAMELY PROVIDING WEB SITE MARKETING CONSULTING SERVICES FOR OTHERS AND BUSINESS PLANNING, NAMELY STRATEGIC PLANNING (U.S. CLS. 100, 101 AND 102).

CLASS 42—SCIENTIFIC, COMPUTER AND LEGAL SERVICES

FOR COMPUTER SERVICES, NAMELY DESIGNING AND MAINTAINING WEB SITES FOR OTHERS, INTEGRATION OF COMPUTER SYSTEMS AND NETWORKS, COMPUTER PROGRAMMING FOR OTHERS IN THE FIELDS OF THE GLOBAL COMPUTER NETWORKS AND AUCTIONS (U.S. CLS. 100 AND 101).

SN 76-096,443. CHIRIKJIAN, PH.D., DR. JACK G., POTO-MAC, MD. FILED 7-26-2000.

INSTASTAIN

CLASS 1—CHEMICALS

FOR DRY FORM STABILIZED DYES TO STAIN BIOMOLECULES FOR SCIENTIFIC AND RESEARCH USE (U.S. CLS. 1, 5, 6, 10, 26 AND 46).
FIRST USE 10-0-1999; IN COMMERCE 10-0-1999.

CLASS 5—PHARMACEUTICALS

FOR DRY FORM STABILIZED DYES TO STAIN BIOMOLECULES FOR MEDICAL DIAGNOSTIC USE (U.S. CLS. 6, 18, 44, 46, 51 AND 52).
FIRST USE 10-0-1999; IN COMMERCE 10-0-1999.

SN 76-096,539. IDS SCHEER, INC., BERWYN, PA. FILED 7-24-2000.

COMMERSCAPE

CLASS 9—ELECTRICAL AND SCIENTIFIC APPARATUS

FOR COMPUTER ELECTRONIC COMMERCE SOFTWARE TO ALLOW USERS TO PERFORM ELECTRONIC BUSINESS TRANSACTIONS VIA A GLOBAL COMPUTER NETWORK (U.S. CLS. 21, 23, 26, 36 AND 38).

CLASS 35—ADVERTISING AND BUSINESS

FOR BUSINESS CONSULTING SERVICES RELATING TO THE DESIGN, DEVELOPMENT, IMPLEMENTATION AND SUPPORT OF BUSINESS MANAGEMENT AND BUSINESS PROCESS REENGINEERING FUNCTIONS AND THE USE OF COMPUTERIZED DATA AND INFORMATION PROCESSING SYSTEMS; AND DATABASE MANAGEMENT SERVICES (U.S. CLS. 100, 101 AND 102).

CLASS 42—SCIENTIFIC, COMPUTER AND LEGAL SERVICES

FOR COMPUTER CONSULTING SERVICES RELATING TO THE DESIGN, DEVELOPMENT, IMPLEMENTATION AND SUPPORT OF COMPUTING, DATA STORAGE, DATABASE AND COMMUNICATIONS SYSTEMS; APPLICATION SERVICE PROVIDER SERVICES, NAMELY, DEVELOPING COMPUTER SOFTWARE PROGRAMS AND HOSTING COMPUTER SOFTWARE PROGRAMS ON A COMPUTER SERVER FOR OTHERS TO ACCESS; AND PROVIDING TO OTHERS A WEB-BASED SUITE OF APPLICATIONS THAT ALLOWS THE USER TO MANAGE DOCUMENTATION AND FILES, SEND ELECTRONIC MAIL, INTEGRATE INTERNAL AND EXTERNAL APPLICATIONS AND ESTABLISH GLOBAL AND LOCAL COMMUNICATION NETWORK LINKS (U.S. CLS. 100 AND 101).

SN 76-098,785. OLIVER, JON, BOSTON, MA. FILED 7-31-2000.

SELF-CONTROL TIME**CLASS 16—PAPER GOODS AND PRINTED MATTER**

FOR EDUCATIONAL KIT CONSISTING PRIMARILY OF - POSTERS, GUIDE BOOKS, CHILDREN'S BOOKS, AND WORKBOOKS FOR CHILDREN IN PRE-KINDERGARTEN, KINDERGARTEN, AND GRADES 1 THROUGH 5 ABOUT CHILDREN'S SAFETY, SURVIVAL AND SUCCESS IN SCHOOL, HOME, AND THEIR COMMUNITIES, AND EDUCATIONAL TOYS, NAMELY, PICK-UP STICKS, BUBBLE MAKING WAND AND SOLUTION SETS, AND TOY MUSICAL INSTRUMENTS (U.S. CLS. 2, 5, 22, 23, 29, 37, 38 AND 50).

FIRST USE 0-0-1990; IN COMMERCE 0-0-1990.

CLASS 41—EDUCATION AND ENTERTAINMENT

FOR EDUCATIONAL SERVICES, NAMELY, CONDUCTING WORKSHOPS, SEMINARS, AND CONFERENCES IN THE FIELD OF CHILDREN'S SAFETY, SURVIVAL AND SUCCESS IN SCHOOL, AT HOME AND IN THEIR COMMUNITY, AND DISTRIBUTION OF COURSE MATERIALS IN CONNECTION THEREWITH (U.S. CLS. 100, 101 AND 107).

FIRST USE 0-0-1990; IN COMMERCE 0-0-1990.

SN 76-099,207. AQUA-GULF TRANSPORT, INC., DEERFIELD BEACH, FL. FILED 7-28-2000.

SN 76-098,784. OLIVER, JON, BOSTON, MA. FILED 7-31-2000.

SUPER SILENT CHEER**CLASS 16—PAPER GOODS AND PRINTED MATTER**

FOR EDUCATIONAL KIT CONSISTING PRIMARILY OF - POSTERS, GUIDE BOOKS, CHILDREN'S BOOKS, AND WORKBOOKS FOR CHILDREN IN PRE-KINDERGARTEN, KINDERGARTEN, AND GRADES 1 THROUGH 5 ABOUT CHILDREN'S SAFETY, SURVIVAL AND SUCCESS IN SCHOOL, HOME, AND THEIR COMMUNITIES, AND EDUCATIONAL TOYS, NAMELY, PICK-UP STICKS, BUBBLE MAKING WAND AND SOLUTION SETS, AND TOY MUSICAL INSTRUMENTS (U.S. CLS. 2, 5, 22, 23, 29, 37, 38 AND 50).

FIRST USE 0-0-1986; IN COMMERCE 0-0-1986.

CLASS 41—EDUCATION AND ENTERTAINMENT

FOR EDUCATIONAL SERVICES, NAMELY, CONDUCTING WORKSHOPS, SEMINARS, AND CONFERENCES IN THE FIELD OF CHILDREN'S SAFETY, SURVIVAL AND SUCCESS IN SCHOOL, AT HOME AND IN THEIR COMMUNITY, AND DISTRIBUTION OF COURSE MATERIALS IN CONNECTION THEREWITH (U.S. CLS. 100, 101 AND 107).

FIRST USE 0-0-1986; IN COMMERCE 0-0-1986.



NO CLAIM IS MADE TO THE EXCLUSIVE RIGHT TO USE "SERVICES", APART FROM THE MARK AS SHOWN.

CLASS 35—ADVERTISING AND BUSINESS

FOR LOGISTICS MANAGEMENT SERVICES IN THE FIELD OF INTERNATIONAL AND DOMESTIC INTERMODAL FREIGHT TRANSPORTATION (U.S. CLS. 100, 101 AND 102).

FIRST USE 5-0-1984; IN COMMERCE 5-0-1984.

CLASS 39—TRANSPORTATION AND STORAGE

FOR FREIGHT TRANSPORTATION BY TRUCK; TRANSPORTATION BROKERAGE; FREIGHT TRANSPORTATION BY SHIP, PLANE, TRUCK AND TRAIN; AND WAREHOUSING (U.S. CLS. 100 AND 105).

FIRST USE 5-0-1984; IN COMMERCE 5-0-1984.

SN 76-099,674. AQUA-GULF TRANSPORT, INC., DEERFIELD BEACH, FL. FILED 7-28-2000.



NO CLAIM IS MADE TO THE EXCLUSIVE RIGHT TO USE "TRANSPORT", APART FROM THE MARK AS SHOWN.

CLASS 35—ADVERTISING AND BUSINESS

FOR LOGISTICS MANAGEMENT SERVICES IN THE FIELD OF INTERNATIONAL AND DOMESTIC INTERMODAL FREIGHT TRANSPORTATION (U.S. CLS. 100, 101 AND 102).

FIRST USE 5-0-1984; IN COMMERCE 5-0-1984.

CLASS 39—TRANSPORTATION AND STORAGE

FOR TRANSPORTATION BROKERAGE; FREIGHT TRANSPORTATION BY SHIP, PLANE, TRUCK AND TRAIN; AND WAREHOUSING (U.S. CLS. 100 AND 105).

FIRST USE 5-0-1984; IN COMMERCE 5-0-1984.

SN 76-099,913. ALLISON-LOBUE GROUP, LLC, LAS VEGAS, NV. FILED 7-31-2000.

THE NEXT STEP IN ENTERPRISE EVOLUTION

NO CLAIM IS MADE TO THE EXCLUSIVE RIGHT TO USE "ENTERPRISE", APART FROM THE MARK AS SHOWN.

CLASS 35—ADVERTISING AND BUSINESS

FOR BUSINESS CONSULTATION IN THE FIELDS OF BUSINESS MODELS, ORGANIZATIONAL MODELS, MANAGEMENT METHODS, HUMAN RESOURCE MANAGEMENT, TRAINING, COMMUNICATION, PERFORMANCE DEVELOPMENT, EDUCATION, COACHING, LEADERSHIP, KNOWLEDGE DEVELOPMENT, AND SCENARIO DEVELOPMENT (U.S. CLS. 100, 101 AND 102).

CLASS 41—EDUCATION AND ENTERTAINMENT

FOR BUSINESS TRAINING SERVICES, NAMELY, PROVIDING SEMINARS AND WORKSHOPS ON THE TOPICS OF BUSINESS MODELS, ORGANIZATIONAL MODELS, MANAGEMENT METHODS, HUMAN RESOURCE MANAGEMENT, TRAINING, COMMUNICATION, PERFORMANCE DEVELOPMENT, EDUCATION, COACHING, LEADERSHIP, KNOWLEDGE DEVELOPMENT, AND SCENARIO DEVELOPMENT (U.S. CLS. 100, 101 AND 107).

SN 76-100,278. PATMOS INTERNATIONAL CORPORATION, OCEAN CITY, MD. FILED 8-1-2000.



NO CLAIM IS MADE TO THE EXCLUSIVE RIGHT TO USE "INTERNATIONAL CORPORATION", APART FROM THE MARK AS SHOWN.

CLASS 9—ELECTRICAL AND SCIENTIFIC APPARATUS

FOR COMPUTER HARDWARE, NAMELY, COMPUTERS, MONITORS AND SERVERS, COMPUTER CPU'S, CIRCUIT BOARDS, ELECTRICAL PIN CONNECTORS FOR SAME AND MODULAR HOUSING CONTAINING SAME, AND PARTS AND FITTINGS THEREFOR; COMPUTER SOFTWARE USED TO CONFIGURE, ADMINISTER, MONITOR, DIAGNOSE, MAINTAIN, AND REPAIR COMPUTERS AND SERVERS; ELECTRONIC STORAGE DEVICES, NAMELY, HARD DRIVES AND COMPUTER MEMORY; COMPUTER FIRMWARE USED IN PARALLEL PROCESSING; NODES; AND COMPUTER AND SERVER COMPONENTS, NAMELY, FIBER OPTIC SENSORS (U.S. CLS. 21, 23, 26, 36 AND 38).

CLASS 42—SCIENTIFIC, COMPUTER AND LEGAL SERVICES

FOR MONITORING, CONFIGURATION, ADMINISTRATION, DIAGNOSTIC, MAINTENANCE AND REPAIR SERVICES OF SOFTWARE PROVIDED ON-LINE, VIA A GLOBAL COMPUTER NETWORK (U.S. CLS. 100 AND 101).

SN 76-100,690. MARTY SUSSMAN ORGANIZATION, INC., JENKINTOWN, PA. FILED 8-1-2000.

HEALTHCAR

CLASS 36—INSURANCE AND FINANCIAL

FOR ADMINISTRATION OF AN AUTOMOBILE REPAIR AND MAINTENANCE SERVICE PLAN OVER A GLOBAL COMPUTER NETWORK, NAMELY, COORDINATING OTHER SERVICE PROVIDERS TO PERFORM AUTOMOBILE REPAIR AND MAINTENANCE (U.S. CLS. 100, 101 AND 102).

CLASS 42—SCIENTIFIC, COMPUTER AND LEGAL SERVICES

FOR PROVIDING QUALITY ASSURANCE SERVICES IN THE FIELD OF AUTOMOBILE REPAIR AND MAINTENANCE, NAMELY, MONITORING REPAIR AND MAINTENANCE SERVICES PROVIDED TO AUTOMOBILE OWNERS PARTICIPATING IN AN AUTOMOBILE REPAIR AND MAINTENANCE SERVICE PLAN AS TO ACCURACY AND PRICING (U.S. CLS. 100 AND 101).

SN 76-102,612. HORIZON'S EDGE EXCURSIONS, LLC, LYNN, MA. FILED 8-4-2000.



THE STIPPLING SHOWN IN THE DRAWING IS A FEATURE OF THE MARK AND IS NOT INTENDED TO INDICATE COLOR.

CLASS 39—TRANSPORTATION AND STORAGE

FOR BOAT CRUISES (U.S. CLS. 100 AND 105). FIRST USE 4-20-2000; IN COMMERCE 4-20-2000.

CLASS 41—EDUCATION AND ENTERTAINMENT

FOR ENTERTAINMENT SERVICES IN THE NATURE OF CASINOS ON A CRUISE SHIP (U.S. CLS. 100, 101 AND 107). FIRST USE 4-20-2000; IN COMMERCE 4-20-2000.

SN 76-102,948. CHRISTOPHER NEWPORT UNIVERSITY, NEWPORT NEWS, VA. FILED 8-4-2000.



NO CLAIM IS MADE TO THE EXCLUSIVE RIGHT TO USE "1960" AND "UNIVERSITY", APART FROM THE MARK AS SHOWN. THE NAME "CHRISTOPHER NEWPORT" IS NOT THE NAME OF ANY PARTICULAR LIVING INDIVIDUAL.

CLASS 16—PAPER GOODS AND PRINTED MATTER

FOR BOOKS FEATURING LITERATURE, ARTS, MATH, SCIENCE AND SPORTS; STATIONERY, NOTE PAPER, BROCHURES FEATURING LITERATURE, ARTS, MATH, SCIENCE AND SPORTS; PRINTED TICKETS, 3-RING BINDERS, FOLDERS (U.S. CLS. 2, 5, 22, 23, 29, 37, 38 AND 50). FIRST USE 12-0-1970; IN COMMERCE 12-0-1970.

CLASS 25—CLOTHING

FOR CLOTHING, NAMELY, MEN'S, WOMEN'S AND CHILDREN'S SHIRTS, SWEAT SUITS, HATS, JACKETS, T-SHIRTS, SHORTS, GOLF SHIRTS, PANTS, TANK TOPS, SWEATERS, SOCKS AND WOMEN'S BLOUSES, SKIRTS AND DRESSES (U.S. CLS. 22 AND 39). FIRST USE 12-0-1970; IN COMMERCE 12-0-1970.

CLASS 41—EDUCATION AND ENTERTAINMENT

FOR EDUCATIONAL SERVICES, NAMELY, PROVIDING COURSES, SEMINARS, CLASSES AND WORKSHOPS AT THE COLLEGE LEVEL; SPORTING ACTIVITIES IN THE NATURE OF CONDUCTING ATHLETIC COMPETITIONS AND EXHIBITIONS AND ENTERTAINMENT SERVICES, NAMELY, MUSICALS, THEATRICALS AND DANCE PERFORMANCES (U.S. CLS. 100, 101 AND 107). FIRST USE 12-0-1970; IN COMMERCE 12-0-1970.

SN 76-103,169. ENCOMPASS SERVICES CORPORATION, HOUSTON, TX. FILED 8-4-2000.

ENCOMPASS

OWNER OF U.S. REG. NO. 2,489,299.

CLASS 37—CONSTRUCTION AND REPAIR

FOR REPAIR, REPLACEMENT AND MAINTENANCE OF HEATING, VENTILATION AND AIR CONDITIONING EQUIPMENT AND SYSTEMS; BUILDING CONSTRUCTION AND RENOVATION (U.S. CLS. 100, 103 AND 106).

CLASS 42—SCIENTIFIC, COMPUTER AND LEGAL SERVICES

FOR ARCHITECTURAL BUILDING DESIGN SERVICES (U.S. CLS. 100 AND 101).

SN 76-103,225. NATIONAL ASSOCIATION OF PROFESSIONAL EMPLOYER ORGANIZATIONS, ALEXANDRIA, VA. FILED 8-4-2000.

NAPEO - THE VOICE OF THE PEO INDUSTRY

OWNER OF U.S. REG. NOS. 1,894,456, 2,325,659 AND OTHERS. NO CLAIM IS MADE TO THE EXCLUSIVE RIGHT TO USE "THE PEO INDUSTRY", APART FROM THE MARK AS SHOWN.

CLASS 16—PAPER GOODS AND PRINTED MATTER

FOR PRINTED MATERIALS, NAMELY, PRINTED INSTRUCTIONAL, EDUCATIONAL, AND TEACHING MATERIALS, NEWSLETTERS, AND MAGAZINES ALL FEATURING MATTERS OF INTEREST TO PROFESSIONAL EMPLOYER ORGANIZATIONS (U.S. CLS. 2, 5, 22, 23, 29, 37, 38 AND 50). FIRST USE 9-19-1996; IN COMMERCE 11-1-1996.

CLASS 42—SCIENTIFIC, COMPUTER AND LEGAL SERVICES

FOR ASSOCIATION SERVICES, NAMELY PROMOTING THE INTERESTS OF PROFESSIONAL EMPLOYER ORGANIZATIONS (U.S. CLS. 100 AND 101).
FIRST USE 9-19-1996; IN COMMERCE 11-1-1996.

SN 76-103,419. ENCOMPASS SERVICES CORPORATION, HOUSTON, TX. FILED 8-4-2000.



SN 76-103,412. ENCOMPASS SERVICES CORPORATION, HOUSTON, TX. FILED 8-4-2000.



OWNER OF U.S. REG. NO. 2,489,299.

CLASS 37—CONSTRUCTION AND REPAIR

FOR REPAIR, REPLACEMENT AND MAINTENANCE OF HEATING, VENTILATION AND AIR CONDITIONING EQUIPMENT AND SYSTEMS; BUILDING CONSTRUCTION AND RENOVATION (U.S. CLS. 100, 103 AND 106).

NO CLAIM IS MADE TO THE EXCLUSIVE RIGHT TO USE "SERVICES CORPORATION", APART FROM THE MARK AS SHOWN.

CLASS 37—CONSTRUCTION AND REPAIR

FOR REPAIR, REPLACEMENT AND MAINTENANCE OF HEATING, VENTILATION AND AIR CONDITIONING EQUIPMENT AND SYSTEMS; BUILDING CONSTRUCTION AND RENOVATION (U.S. CLS. 100, 103 AND 106).

CLASS 42—SCIENTIFIC, COMPUTER AND LEGAL SERVICES

FOR ARCHITECTURAL BUILDING DESIGN SERVICES (U.S. CLS. 100 AND 101).

CLASS 42—SCIENTIFIC, COMPUTER AND LEGAL SERVICES

FOR ARCHITECTURAL BUILDING DESIGN SERVICES (U.S. CLS. 100 AND 101).

SN 76-103,928. PIERCE INVESTMENT CORP, SARASOTA, FL. FILED 8-4-2000.

WEBCHICKEN**CLASS 35—ADVERTISING AND BUSINESS**

FOR BUSINESS MARKETING CONSULTING SERVICES; PROMOTING THE GOODS AND SERVICES OF OTHERS BY PREPARING AND PLACING ADVERTISEMENTS IN AN ELECTRONIC MAGAZINE ACCESSED THROUGH A GLOBAL COMPUTER NETWORK; ON-LINE RETAIL STORE SERVICES FEATURING SOFTWARE, BOOKS, E-BOOKS, MANUALS AND COURSE MATERIALS, AND ON-LINE CLASSES IN THE FIELD OF WEB SITE DESIGN, WEB PAGE DESIGN, INTERNET MARKETING AND PROMOTION, AND DIRECT SALES MARKETING (U.S. CLS. 100, 101 AND 102).
FIRST USE 9-23-1999; IN COMMERCE 9-23-1999.

SN 76-103,413. ENCOMPASS SERVICES CORPORATION, HOUSTON, TX. FILED 8-4-2000.



OWNER OF U.S. REG. NO. 2,489,299.

CLASS 42—SCIENTIFIC, COMPUTER AND LEGAL SERVICES

FOR COMPUTER CONSULTATION NAMELY, PLANNING, DESIGNING, CREATING, IMPLEMENTING, AND MAINTAINING WEB SITES FOR OTHERS (U.S. CLS. 100 AND 101).
FIRST USE 9-23-1999; IN COMMERCE 9-23-1999.

CLASS 37—CONSTRUCTION AND REPAIR

FOR REPAIR, REPLACEMENT AND MAINTENANCE OF HEATING, VENTILATION AND AIR CONDITIONING EQUIPMENT AND SYSTEMS; BUILDING CONSTRUCTION AND RENOVATION (U.S. CLS. 100, 103 AND 106).

SN 76-104,407. INNERCURE TECHNOLOGIES, INC., SANFORD, FL. FILED 8-7-2000.

INNERCURE**CLASS 42—SCIENTIFIC, COMPUTER AND LEGAL SERVICES**

FOR ARCHITECTURAL BUILDING DESIGN SERVICES (U.S. CLS. 100 AND 101).

CLASS 17—RUBBER GOODS

FOR PIPELINE REHABILITATIVE PRODUCTS FOR THE INTERIOR WALLS OF NEW AND RESTORED PIPELINES, NAMELY, LEAK STOPPING AND INSULATING MATERIALS (U.S. CLS. 1, 5, 12, 13, 35 AND 50).

CLASS 37—CONSTRUCTION AND REPAIR

FOR PIPELINE REHABILITATIVE SERVICES, REPAIRS AND INSTALLATION FOR NEW AND RESTORED PIPELINES (U.S. CLS. 100, 103 AND 106).

SN 76-104,463. KRAUSS-MAFFEI KUNSTSTOFFTECHNIK GMBH, 80997 MUNCHEN, FED REP GERMANY, FILED 8-7-2000.

OPTICOLOR

PRIORITY CLAIMED UNDER SEC. 44(D) ON FED REP GERMANY APPLICATION NO. 30041360.2/0, FILED 5-30-2000, REG. NO. 30041360, DATED 10-24-2000, EXPIRES 5-31-2010.

CLASS 7—MACHINERY

FOR INJECTION MOLDING MACHINES AND REPLACEMENT PARTS THEREFORE (U.S. CLS. 13, 19, 21, 23, 31, 34 AND 35).

CLASS 37—CONSTRUCTION AND REPAIR

FOR MAINTENANCE AND REPAIR OF INJECTION MOLDING MACHINES (U.S. CLS. 100, 103 AND 106).

CLASS 41—EDUCATION AND ENTERTAINMENT

FOR EDUCATIONAL SERVICES, NAMELY CONDUCTING CLASSES, SEMINARS, WORKSHOPS IN THE FIELD OF OPERATION, MAINTENANCE AND REPAIR OF INJECTION MOLDING MACHINES AND EQUIPMENT AND DISTRIBUTION OF COURSE MATERIAL IN CONNECTION THEREWITH (U.S. CLS. 100, 101 AND 107).

SN 76-105,031. CURRICULUM MANAGEMENT AUDIT CENTERS, INC., HUXLEY, IA. FILED 8-8-2000.

**CURRICULUM
MANAGEMENT AUDIT
CENTER**

SEC. 2(F).

CLASS 41—EDUCATION AND ENTERTAINMENT

FOR EDUCATIONAL SERVICES, NAMELY, CONDUCTING SEMINARS, LECTURES, CONFERENCES, WORKSHOPS AND CLASSES IN THE FIELD OF CURRICULUM INVESTIGATION AND ANALYSIS IN THE AREAS OF QUALITY CONTROL, GOVERNANCE AND MANAGEMENT, ADMINISTRATIVE STRUCTURE, DIRECTION FOR TEACHERS IN TERMS OF EXPECTATIONS OR RESULTS FOR LEARNERS, CURRICULUM EQUITY AND CONNECTIVITY, TYPES AND USAGE OF FACILITIES AND ENVIRONMENTS, PRODUCTIVE USE OF RESOURCES, AND ORGANIZATIONAL EFFECTIVENESS ALL FOR THE PURPOSE OF MAXIMIZING TEACHING AND LEARNING (U.S. CLS. 100, 101 AND 107).

FIRST USE 1-1-1996; IN COMMERCE 1-1-1996.

CLASS 42—SCIENTIFIC, COMPUTER AND LEGAL SERVICES

FOR INVESTIGATION AND ANALYSIS SERVICES FOR EDUCATIONAL INSTITUTIONS IN THE AREAS OF QUALITY CONTROL, GOVERNANCE AND MANAGEMENT, ADMINISTRATIVE STRUCTURE, DIRECTION FOR TEACHERS IN TERMS OF EXPECTATIONS OR RESULTS FOR LEARNERS, CURRICULUM EQUITY AND CONNECTIVITY, TYPES AND USAGE OF FACILITIES AND ENVIRONMENTS, PRODUCTIVE USE OF RESOURCES, AND ORGANIZATIONAL EFFECTIVENESS ALL FOR THE PURPOSE OF MAXIMIZING TEACHING AND LEARNING (U.S. CLS. 100 AND 101).
FIRST USE 1-1-1996; IN COMMERCE 1-1-1996.

SN 76-105,291. CYBERASP, INC., ATLANTA, GA. FILED 8-8-2000.

CYBER-ASP**CLASS 36—INSURANCE AND FINANCIAL**

FOR CONSULTING SERVICES IN THE FIELD OF INSURANCE CLAIMS WORKFLOW PROCESSING (U.S. CLS. 100, 101 AND 102).

CLASS 42—SCIENTIFIC, COMPUTER AND LEGAL SERVICES

FOR APPLICATION SERVICE PROVIDER OF SOFTWARE RELATED TO THE INSURANCE CLAIMS WORKFLOW PROCESS, NAMELY PROVIDING TEMPORARY USE OF ON-LINE NON-DOWNLOADABLE SOFTWARE FOR USE IN THE INSURANCE CLAIMS WORKFLOW PROCESS (U.S. CLS. 100 AND 101).

SN 76-105,566. JAPAN TOBACCO INC., TOKYO, JAPAN, FILED 8-8-2000.

PUREINTRO**CLASS 31—NATURAL AGRICULTURAL PRODUCTS**

FOR GENETICALLY MODIFIED LIVING PLANTS AND GENETICALLY MODIFIED PLANT SEEDS (U.S. CLS. 1 AND 46).

CLASS 42—SCIENTIFIC, COMPUTER AND LEGAL SERVICES

FOR TECHNICAL CONSULTATION AND RESEARCH IN THE FIELD OF GENETICALLY MODIFIED PLANTS AND SEEDS (U.S. CLS. 100 AND 101).

SN 76-107,480. ENZYME TECHNOLOGIES, INC., PORTLAND, OR. FILED 8-10-2000.

BIOSHARK SYSTEMS

NO CLAIM IS MADE TO THE EXCLUSIVE RIGHT TO USE "SYSTEMS", APART FROM THE MARK AS SHOWN.

CLASS 1—CHEMICALS

FOR WATER TREATMENT PRODUCTS USING BACTERIA AND ENZYMES, NAMELY BIOCHEMICAL PREPARATIONS USED TO DEGRADE CONTAMINANTS IN VEHICLE WASH, MARINE, AND INDUSTRIAL FACILITIES (U.S. CLS. 1, 5, 6, 10, 26 AND 46).
FIRST USE 3-1-2000; IN COMMERCE 3-1-2000.

CLASS 35—ADVERTISING AND BUSINESS

FOR TECHNICAL ASSISTANCE IN THE ESTABLISHMENT AND OR OPERATION OF RETAIL VEHICLE WASH, MARINE AND INDUSTRIAL FACILITIES (U.S. CLS. 100, 101 AND 102).
FIRST USE 3-1-2000; IN COMMERCE 3-1-2000.

SN 76-109,686. SUBURBAN PROPANE, L.P., WHIPPANY, NJ. FILED 8-15-2000.



OWNER OF U.S. REG. NO. 778,025.
NO CLAIM IS MADE TO THE EXCLUSIVE RIGHT TO USE "HEATING COOLING", APART FROM THE MARK AS SHOWN.

CLASS 35—ADVERTISING AND BUSINESS

FOR RETAIL STORE SERVICES FEATURING HVAC EQUIPMENT AND OTHER HOME APPLIANCES (U.S. CLS. 100, 101 AND 102).

CLASS 37—CONSTRUCTION AND REPAIR

FOR INSTALLATION AND REPAIR OF HVAC EQUIPMENT AND OTHER HOME APPLIANCES (U.S. CLS. 100, 103 AND 106).

SN 76-111,513. GLOBAL STONE CORPORATION, ROSWELL, GA. FILED 8-16-2000.

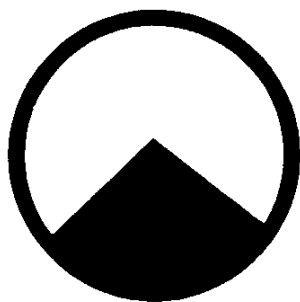

CLASS 1—CHEMICALS

FOR AGRICULTURAL LIME AND LIMESTONE (U.S. CLS. 1, 5, 6, 10, 26 AND 46).
FIRST USE 10-0-1992; IN COMMERCE 10-0-1992.

CLASS 19—NON-METALLIC BUILDING MATERIALS

FOR NON-AGRICULTURAL LIME AND LIMESTONE (U.S. CLS. 1, 12, 33 AND 50).
FIRST USE 10-0-1992; IN COMMERCE 10-0-1992.

SN 76-112,705. INDUSTRIELACK AG, CH-8853 LACHEN AM SEE, SWITZERLAND, FILED 8-18-2000.

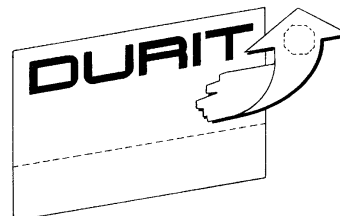

PRIORITY CLAIMED UNDER SEC. 44(D) ON SWITZERLAND APPLICATION NO. 02959/2000, FILED 3-13-2000, REG. NO. 474283, DATED 10-26-2000, EXPIRES 10-26-2020.
THE MARK CONSISTS OF THE COLOR RED IN THE ARROW IN UPPER RIGHT PORTION OF THE MARK EXCEPT IN THE OCTAGON, AND ONE OR MORE COLORS IN THE LOWER STRIPED PART OF THE MARK.

CLASS 1—CHEMICALS

FOR NON-STICK CHEMICALS AND LOW-FRICTION COMPOUNDS FOR USE IN THE MANUFACTURE OF UTENSILS, BAKING-FORMS, COOKING UTENSILS, PANS, DOMESTIC UTENSILS AND FOR TECHNICAL UTENSILS (U.S. CLS. 1, 5, 6, 10, 26 AND 46).

CLASS 21—HOUSEWARES AND GLASS

FOR NON-STICK CHEMICALS AND LOW-FRICTION COMPOUNDS SOLD AS AN INTEGRAL COMPONENT OF UTENSILS, BAKING-FORMS, COOKING UTENSILS, PANS, DOMESTIC UTENSILS AND FOR TECHNICAL UTENSILS (U.S. CLS. 2, 13, 23, 29, 30, 33, 40 AND 50).

SN 76-114,308. GROUND ZERO NETWORK DEVELOPMENT, INC., ATLANTA, GA. FILED 8-22-2000.



CLASS 35—ADVERTISING AND BUSINESS

FOR TELECOMMUNICATIONS NETWORK DEVELOPMENT SERVICES FOR WIRELESS AND LINED TELECOMMUNICATIONS COMPANIES, NAMELY, PROVIDING INFORMATION FOR OTHERS AND ACTING AS A LIASON BETWEEN WIRELESS AND LINED TELECOMMUNICATIONS COMPANIES AND GOVERNMENTAL AGENCIES FOR THE OBTAINING OF AND COMPLIANCE WITH ZONING AND OTHER GOVERNMENTAL PERMITS IN CONNECTION WITH TELECOMMUNICATIONS INFRASTRUCTURE (U.S. CLS. 100, 101 AND 102).
FIRST USE 8-4-1998; IN COMMERCE 8-4-1998.

CLASS 37—CONSTRUCTION AND REPAIR

FOR TELECOMMUNICATIONS NETWORK DEVELOPMENT SERVICES FOR WIRELESS AND LINED TELECOMMUNICATIONS COMPANIES, NAMELY, REAL ESTATE SITE SELECTION FOR THE ACQUISITION OF SITES FOR WIRELESS TELECOMMUNICATIONS TOWERS AND BASE STATIONS; TELECOMMUNICATIONS NETWORK DEVELOPMENT SERVICES FOR WIRELESS AND LINED TELECOMMUNICATIONS COMPANIES, NAMELY, COORDINATING AND MANAGING CONSTRUCTION, INSTALLATION, AND REPAIR OF WIRELESS TELECOMMUNICATIONS TOWERS AND BASE STATIONS AND FIBER OPTICS NETWORKS (U.S. CLS. 100, 103 AND 106).

FIRST USE 8-4-1998; IN COMMERCE 8-4-1998.

CLASS 42—SCIENTIFIC, COMPUTER AND LEGAL SERVICES

FOR TELECOMMUNICATIONS NETWORK DEVELOPMENT SERVICES FOR WIRELESS AND LINED TELECOMMUNICATIONS COMPANIES, NAMELY, COORDINATING AND MANAGING RADIO FREQUENCY (RF) DESIGN FOR OTHERS IN CONNECTION WITH TELECOMMUNICATIONS INFRASTRUCTURE (U.S. CLS. 100 AND 101).

FIRST USE 8-4-1998; IN COMMERCE 8-4-1998.

SN 76-114,919. GROUND ZERO NETWORK DEVELOPMENT, INC., ATLANTA, GA. FILED 8-22-2000.

GROUND ZERO**CLASS 35—ADVERTISING AND BUSINESS**

FOR TELECOMMUNICATIONS NETWORK DEVELOPMENT SERVICES FOR WIRELESS AND LINED TELECOMMUNICATIONS COMPANIES, NAMELY, PROVIDING INFORMATION FOR OTHERS AND ACTING AS A LIASON BETWEEN WIRELESS AND LINED TELECOMMUNICATIONS COMPANIES AND GOVERNMENTAL AGENCIES FOR THE OBTAINING OF AND COMPLIANCE WITH ZONING AND OTHER GOVERNMENTAL PERMITS IN CONNECTION WITH TELECOMMUNICATIONS INFRASTRUCTURE (U.S. CLS. 100, 101 AND 102).

FIRST USE 8-4-1998; IN COMMERCE 8-4-1998.

CLASS 37—CONSTRUCTION AND REPAIR

FOR TELECOMMUNICATIONS NETWORK DEVELOPMENT SERVICES FOR WIRELESS AND LINED TELECOMMUNICATIONS COMPANIES, NAMELY, REAL ESTATE SITE SELECTION FOR THE ACQUISITION OF SITES FOR WIRELESS TELECOMMUNICATIONS TOWERS AND BASE STATIONS; TELECOMMUNICATIONS NETWORK DEVELOPMENT SERVICES FOR WIRELESS AND LINED TELECOMMUNICATIONS COMPANIES, NAMELY, COORDINATING AND MANAGING CONSTRUCTION, INSTALLATION, AND REPAIR OF WIRELESS TELECOMMUNICATIONS TOWERS AND BASE STATIONS AND FIBER OPTICS NETWORKS (U.S. CLS. 100, 103 AND 106).

FIRST USE 8-4-1998; IN COMMERCE 8-4-1998.

CLASS 42—SCIENTIFIC, COMPUTER AND LEGAL SERVICES

FOR TELECOMMUNICATIONS NETWORK DEVELOPMENT SERVICES FOR WIRELESS AND LINED TELECOMMUNICATIONS COMPANIES, NAMELY, COORDINATING AND MANAGING RADIO FREQUENCY (RF) DESIGN FOR OTHERS IN CONNECTION WITH TELECOMMUNICATIONS INFRASTRUCTURE (U.S. CLS. 100 AND 101).

FIRST USE 8-4-1998; IN COMMERCE 8-4-1998.

SN 76-114,824. RXHOPE.COM, INC., HACKETTSTOWN, NJ. FILED 8-21-2000.

**HEART OF THE
PHARMACEUTICAL
INDUSTRY**

NO CLAIM IS MADE TO THE EXCLUSIVE RIGHT TO USE "PHARMACEUTICAL", APART FROM THE MARK AS SHOWN.

CLASS 35—ADVERTISING AND BUSINESS

FOR SUPPLYING PRESCRIPTION DRUGS TO INDIGENT PATIENTS WHO DO NOT HAVE ACCESS TO PRESCRIPTION INSURANCE OR GOVERNMENT FUNDED PROGRAMS, AND SUPPLYING STARTER KITS AND SAMPLES TO DOCTORS FOR DISTRIBUTION IN CONNECTION THEREWITH (U.S. CLS. 100, 101 AND 102).

FIRST USE 2-2-2000; IN COMMERCE 2-2-2000.

CLASS 42—SCIENTIFIC, COMPUTER AND LEGAL SERVICES

FOR PHARMACEUTICAL ADVICE; AND MEDICAL COUNSELING (U.S. CLS. 100 AND 101).

FIRST USE 2-2-2000; IN COMMERCE 2-2-2000.

SN 76-116,823. CABG, INC., DALLAS, TX. FILED 8-25-2000.

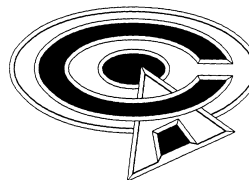

THE MARK CONSISTS OF THE STYLIZED LETTERS "C" AND "A".

CLASS 9—ELECTRICAL AND SCIENTIFIC APPARATUS

FOR COMPUTER PUSH SOFTWARE THAT ALLOWS THE TRANSFER OF INFORMATION TO USERS (U.S. CLS. 21, 23, 26, 36 AND 38).

FIRST USE 3-1-2000; IN COMMERCE 3-1-2000.

CLASS 42—SCIENTIFIC, COMPUTER AND LEGAL SERVICES

FOR INTEGRATED SERVICE PROVIDER (ISP) SERVICES, SPECIFICALLY, INTEGRATION OF SOFTWARE COMPONENTS FOR PROVIDING COMPLETE SOLUTIONS FOR THE STORAGE, TARGETING, DELIVERY AND MANAGEMENT OF VIDEO, AUDIO, SOFTWARE AND OTHER FILES OVER THE INTERNET, AND CUSTOMIZATION OF USER INTERFACES TO PROVIDE SEPARATE COMMUNICATIONS CHANNELS, PROVIDING PUSH TECHNOLOGY USED TO TRANSFER INFORMATION TO USERS, INTEGRATED SYSTEMS FOR TARGETING AND REPORTING MEDIA DIGITIZATION, AND NETWORK PLATFORMS TO DELIVER DIGITIZED FILES TO SPECIFIC AUDIENCES (U.S. CLS. 100 AND 101).

FIRST USE 3-1-2000; IN COMMERCE 3-1-2000.

SN 76-116,931. BYNUM, V. EUNICE, NEW ORLEANS, LA. FILED 8-28-2000.

FOR FEET SAKE**CLASS 35—ADVERTISING AND BUSINESS**

FOR RETAIL STORE SERVICES, WHOLESALE DISTRIBUTORSHIP SERVICES, AND COMPUTERIZED ONLINE ORDERING OF GOODS AND SERVICES, ALL FEATURING MEDICAL SUPPLIES, EQUIPMENT, BOOKS, AUDIO AND VIDEO ITEMS, COMPACT DISCS, SHOES, AND ORTHOTICS-RELATED PRODUCTS, ALL RELATING TO MEDICAL FOOT CARE AND HEALTH (U.S. CLS. 100, 101 AND 102).

CLASS 41—EDUCATION AND ENTERTAINMENT

FOR EDUCATIONAL SERVICES, NAMELY CONDUCTING CLASSES, SEMINARS, CONFERENCES, AND WORKSHOPS IN THE FIELD OF FOOT CARE AND HEALTH (U.S. CLS. 100, 101 AND 107).

CLASS 42—SCIENTIFIC, COMPUTER AND LEGAL SERVICES

FOR MEDICAL AND SURGICAL FOOT CLINICS (U.S. CLS. 100 AND 101).

SN 76-117,556. PERSONNEL DECISIONS INTERNATIONAL CORPORATION, MINNEAPOLIS, MN. FILED 8-28-2000.

PDI DEVELOPMENT PIPELINE

NO CLAIM IS MADE TO THE EXCLUSIVE RIGHT TO USE "DEVELOPMENT", APART FROM THE MARK AS SHOWN.

CLASS 16—PAPER GOODS AND PRINTED MATTER

FOR PRINTED MATERIALS CONCERNING ORGANIZATIONAL EFFECTIVENESS, FINANCIAL OPTIMIZATION FOR HUMAN RESOURCES IN COMPANIES AND TO DEVELOPMENT, TRAINING, SELECTION, ASSESSMENT AND RETENTION OF EMPLOYEES (U.S. CLS. 2, 5, 22, 23, 29, 37, 38 AND 50).

CLASS 35—ADVERTISING AND BUSINESS

FOR CONSULTING SERVICES CONCERNING DEVELOPMENT, TRAINING, SELECTION, ASSESSMENT AND RETENTION OF EMPLOYEES AND TO ORGANIZATION EFFECTIVENESS AND FINANCIAL OPTIMIZATION FOR HUMAN RESOURCES IN COMPANIES (U.S. CLS. 100, 101 AND 102).

SN 76-117,744. YAMANOUCHI CONSUMER INC., PLEASANTON, CA. BY CHANGE OF NAME SHAKLEE CORPORATION, PLEASANTON, CA. FILED 8-28-2000.

HAIR PHYSICS

NO CLAIM IS MADE TO THE EXCLUSIVE RIGHT TO USE "HAIR", APART FROM THE MARK AS SHOWN.

CLASS 5—PHARMACEUTICALS

FOR HAIR CARE PREPARATIONS, NAMELY, MEDICATED SHAMPOO, MEDICATED SKIN CARE PREPARATIONS AND TOPICAL ANALGESICS (U.S. CLS. 6, 18, 44, 46, 51 AND 52).

CLASS 9—ELECTRICAL AND SCIENTIFIC APPARATUS

FOR PRERECORDED VIDEO AND AUDIO CD'S, TAPE CASSETTES, FEATURING INFORMATION OF A MOTIVATIONAL AND/OR INSTRUCTIONAL NATURE CONCERNING MULTI-LEVEL MARKETING OF PROVIDER'S GOODS AND SERVICES IN THE FIELD OF HEALTH CARE MANAGEMENT AND HEALTH CARE PRODUCTS, DIRECTED TO DISTRIBUTORS, PROSPECTIVE DISTRIBUTORS AND/OR CUSTOMERS (U.S. CLS. 21, 23, 26, 36 AND 38).

CLASS 14—JEWELRY

FOR ORNAMENTAL PINS (U.S. CLS. 2, 27, 28 AND 50).

CLASS 16—PAPER GOODS AND PRINTED MATTER

FOR PRINTED FORMS, NAMELY, LITERATURE, BUSINESS KITS, BROCHURES, PROFILERS, REGIMEN CARDS, ORDER FORMS, POSTCARDS, FLYERS, INFORMATION SHEETS, PRODUCT BRIEFS, TECHNICAL BULLETINS, AND FACT SHEETS RELATED TO HEALTH CARE MANAGEMENT AND HEALTH CARE PRODUCTS (U.S. CLS. 2, 5, 22, 23, 29, 37, 38 AND 50).

CLASS 18—LEATHER GOODS

FOR LUGGAGE, NAMELY, BRIEFCASES, TRAVEL BAGS, DUFFEL BAGS, AND ATTACHE CASES (U.S. CLS. 1, 2, 3, 22 AND 41).

CLASS 21—HOUSEWARES AND GLASS

FOR BOTTLES, SOLD EMPTY, HAIR BRUSHES AND HAIR COMBS (U.S. CLS. 2, 13, 23, 29, 30, 33, 40 AND 50).

CLASS 25—CLOTHING

FOR T-SHIRTS (U.S. CLS. 22 AND 39).

CLASS 26—FANCY GOODS

FOR HAIR PINS (U.S. CLS. 37, 39, 40, 42 AND 50).

CLASS 42—SCIENTIFIC, COMPUTER AND LEGAL SERVICES

FOR PROVIDING MANAGED HEALTH CARE SERVICES; PROVIDING HEALTH CARE INFORMATION AND INFORMATION ABOUT HEALTH CARE PRODUCTS VIA A GLOBAL COMPUTER NETWORK (U.S. CLS. 100 AND 101).

CLASS 42—SCIENTIFIC, COMPUTER AND LEGAL SERVICES

FOR WEB SITE DEVELOPMENT AND DESIGN FOR MEMBER CREDIT UNIONS (U.S. CLS. 100 AND 101). FIRST USE 1-0-2000; IN COMMERCE 1-0-2000.

SN 76-118,636. KMC PRODUCTS, INC., RIVERSIDE, CA. FILED 8-29-2000.

METAL OBJX

NO CLAIM IS MADE TO THE EXCLUSIVE RIGHT TO USE "METAL", APART FROM THE MARK AS SHOWN.

CLASS 12—VEHICLES

FOR MOTOR VEHICLE WHEELS; PARTS FOR MOTOR VEHICLE WHEELS, NAMELY WHEEL CAPS, LUG NUTS AND VALVE STEMS (U.S. CLS. 19, 21, 23, 31, 35 AND 44).

CLASS 25—CLOTHING

FOR CLOTHING, NAMELY, T-SHIRTS, SWEAT-SHIRTS, SWEATPANTS, JACKETS, CAPS, HATS, COATS, AND SHORTS (U.S. CLS. 22 AND 39).

SN 76-119,528. MID-STATES CORPORATE FEDERAL CREDIT UNION, WARRENVILLE, IL. FILED 8-30-2000.



CLASS 36—INSURANCE AND FINANCIAL

FOR PROVIDING FINANCIAL SERVICES TO MEMBER CREDIT UNIONS, NAMELY, INVESTMENT PRODUCTS IN THE FIELDS OF REGULAR SHARE CERTIFICATES, SPECIAL SHARE CERTIFICATES, CALLABLE SHARE CERTIFICATES, STEP-UP CERTIFICATES AND CD BROKERAGE SERVICES; LIQUIDITY SERVICES IN THE FIELDS OF GENERAL LINES OF CREDITS, COLLATERALIZED LINES OF CREDIT AND NETWORK LIQUIDITY PROGRAMS; CORRESPONDENT SERVICES IN THE FIELDS OF CASH MANAGEMENT, ELECTRONIC MONEY TRANSFER PROGRAMS, ELECTRONIC FUNDS TRANSFERS, COMMERCIAL MONEY TRANSFERS, COIN AND CURRENCY DELIVERY PROGRAMS, PROCESSING OF CHECK ITEMS THROUGH CLEARINGHOUSES, AUTOMATIC TELLER MACHINE SERVICES AND DEBIT CARD SERVICES (U.S. CLS. 100, 101 AND 102).

FIRST USE 1-0-1976; IN COMMERCE 1-0-1976.

SN 76-119,624. PRIME RESOURCES CORPORATION, BRIDGEPORT, CT. FILED 8-22-2000.

YOUR E-SOURCE FOR PRODUCTS THAT PROMOTE

OWNER OF U.S. REG. NO. 2,234,086.

CLASS 35—ADVERTISING AND BUSINESS

FOR WHOLE SALE DISTRIBUTORSHIP SERVICES OF CONSUMER PRODUCTS IN THE FIELD OF OFFICE SUPPLIES, KNIVES, LIGHTS, TOOLS, ELECTRONICS, MARBLE ART PRODUCTS, CLOCKS, PENS, KEY TAGS, TIE TACKS, MOUSE PADS, NOTE PADS, CIGAR CUTTERS, MAGNIFYING GLASSES, BINOCULARS, STOP WATCHES, BODY MASSAGERS, LUGGAGE TAGS, LOCKS, TRAVEL KITS, LINT BRUSHES, MAKE-UP MIRRORS, SEWING KITS, EXECUTIVE TOYS, MEASURING DEVICES, GOLF ACCESSORIES, AND STRESS BALLS, FOR USE AS PROMOTIONAL PRODUCTS BY OTHERS (U.S. CLS. 100, 101 AND 102).

FIRST USE 4-1-2000; IN COMMERCE 4-1-2000.

CLASS 40—MATERIAL TREATMENT

FOR CUSTOM MANUFACTURE OF CONSUMER PRODUCTS IN THE FIELD OF OFFICE SUPPLIES, KNIVES, LIGHTS, TOOLS, ELECTRONICS, MARBLE ART PRODUCTS, CLOCKS, PENS, KEY TAGS, TIE TACKS, MOUSE PADS, NOTE PADS, CIGAR CUTTERS, MAGNIFYING GLASSES, BINOCULARS, STOP WATCHES, BODY MASSAGERS, LUGGAGE TAGS, LOCKS, TRAVEL KITS, LINT BRUSHES, MAKE-UP MIRRORS, SEWING KITS, EXECUTIVE TOYS, MEASURING DEVICES, GOLF ACCESSORIES, AND STRESS BALLS FOR USE AS PROMOTIONAL PRODUCTS BY OTHERS (U.S. CLS. 100, 103 AND 106).

FIRST USE 4-1-2000; IN COMMERCE 4-1-2000.

CLASS 42—SCIENTIFIC, COMPUTER AND LEGAL SERVICES

FOR CUSTOM IMPRINTING SERVICES OF A WIDE VARIETY OF CONSUMER PRODUCTS, INCLUDING BUT NOT LIMITED TO OFFICE SUPPLIES, KNIVES, LIGHTS, TOOLS, ELECTRONICS, AND MARBLE ART PRODUCTS, CLOCKS, PENS, KEY TAGS, TIE TACKS, MOUSE PADS, NOTE PADS, CIGAR CUTTERS, MAGNIFYING GLASSES, BINOCULARS, STOP WATCHES, BODY MASSAGERS, LUGGAGE TAGS, LOCKS, TRAVEL KITS, LINT BRUSHES, MAKE-UP MIRRORS, SEWING KITS, EXECUTIVE TOYS, MEASURING DEVICES, GOLF ACCESSORIES, AND STRESS BALLS, FOR USE AS PROMOTIONAL PRODUCTS BY OTHERS (U.S. CLS. 100 AND 101).

FIRST USE 4-1-2000; IN COMMERCE 4-1-2000.

SN 76-119,784. STOWE, DWAYNE J., JAMAICA, NY. FILED 8-30-2000.

SN 76-121,777. VARIAN SEMICONDUCTOR EQUIPMENT ASSOCIATES, INC., GLOUCESTER, MA. FILED 8-30-2000.

STOLEN TEARS PUBLISHING

NO CLAIM IS MADE TO THE EXCLUSIVE RIGHT TO USE "PUBLISHING" FOR INTERNATIONAL CLASS 41, APART FROM THE MARK AS SHOWN.

CLASS 35—ADVERTISING AND BUSINESS

FOR MAIL ORDER AND ONLINE RETAIL SERVICES FEATURING SWEATSHIRTS, T-SHIRTS, BOOKS, BOOKMARKS, BATH AND BODY OILS AND INCENSE (U.S. CLS. 100, 101 AND 102).

FIRST USE 1-11-1999; IN COMMERCE 1-11-1999.

CLASS 41—EDUCATION AND ENTERTAINMENT

FOR BOOK PUBLISHING SERVICES (U.S. CLS. 100, 101 AND 107).

FIRST USE 1-11-1999; IN COMMERCE 1-11-1999.

SN 76-120,784. VIRTUES INITIATION PROGRAM, LLC, THE, MINNEAPOLIS, MN. FILED 8-31-2000.

V.I.P. VIRTUES INITIATION PROGRAM

NO CLAIM IS MADE TO THE EXCLUSIVE RIGHT TO USE "PROGRAM", APART FROM THE MARK AS SHOWN.

CLASS 14—JEWELRY

FOR JEWELRY (U.S. CLS. 2, 27, 28 AND 50).

CLASS 28—TOYS AND SPORTING GOODS

FOR TOYS, NAMELY, BOARD GAMES AND CARD GAMES (U.S. CLS. 22, 23, 38 AND 50).

SN 76-121,345. DFS GROUP L.P., SAN FRANCISCO, CA. FILED 9-1-2000.

GUAM PARADISE

NO CLAIM IS MADE TO THE EXCLUSIVE RIGHT TO USE "GUAM", APART FROM THE MARK AS SHOWN.

CLASS 29—MEATS AND PROCESSED FOODS

FOR CANDIED NUTS, SHELLED ROASTED OR OTHERWISE PROCESSED NUTS (U.S. CL. 46).

CLASS 30—STAPLE FOODS

FOR CONFECTIONERY, NAMELY, CHOCOLATE, CANDY COOKIES AND CHOCOLATE COVERED NUTS (U.S. CL. 46).

VCARE

CLASS 9—ELECTRICAL AND SCIENTIFIC APPARATUS

FOR COMPUTER SOFTWARE, NAMELY, DOWNLOADABLE SOFTWARE WHICH DELIVERS SCHEMATICS AND DIAGRAMS OF SEMICONDUCTOR MANUFACTURING EQUIPMENT, WHICH PROVIDES INFORMATION REGARDING THE FUNCTION, DESIGN, MAINTENANCE, AND REPAIR OF SEMICONDUCTOR MANUFACTURING EQUIPMENT, WHICH FACILITATES THE ORDERING OF SEMICONDUCTOR MANUFACTURING EQUIPMENT PARTS AND THE ARRANGEMENT OF APPOINTMENTS WITH SEMICONDUCTOR MANUFACTURING EQUIPMENT TECHNICIANS, AND WHICH REMOTELY MONITORS THE CONDITION AND FUNCTIONALITY OF SEMICONDUCTOR MANUFACTURING EQUIPMENT AND TRIGGERS PARAMETRIC, TIME-BASED AND WAFER-BASED MAINTENANCE NOTIFICATIONS; AND COMPUTER SYSTEMS COMPRISED OF NETWORK SERVERS AND COMPUTER SOFTWARE WHICH REMOTELY AND LOCALLY COLLECT DATA REGARDING THE CONDITION AND FUNCTIONALITY OF SEMICONDUCTOR MANUFACTURING EQUIPMENT, ORGANIZE THE DATA INTO A SUMMARY FORMAT AND FORWARD THE DATA TO TECHNICAL SUPPORT PERSONNEL FOR ANALYSIS (U.S. CLS. 21, 23, 26, 36 AND 38).

CLASS 37—CONSTRUCTION AND REPAIR

FOR INSTALLATION, MAINTENANCE AND REPAIR SERVICES IN THE FIELD OF SEMICONDUCTOR MANUFACTURING EQUIPMENT (U.S. CLS. 100, 103 AND 106).

CLASS 38—COMMUNICATION

FOR PROVIDING AN ONLINE FORUM IN THE NATURE OF A WEB SITE FOR THE EXCHANGE OF DATA AND INFORMATION IN THE FIELD OF PRODUCT AND TECHNICAL SUPPORT FOR SEMICONDUCTOR MANUFACTURING EQUIPMENT (U.S. CLS. 100, 101 AND 104).

CLASS 42—SCIENTIFIC, COMPUTER AND LEGAL SERVICES

FOR PROVIDING AN ONLINE COMPUTER DATABASE WHICH DELIVERS SCHEMATICS AND DIAGRAMS OF SEMICONDUCTOR MANUFACTURING EQUIPMENT AND WHICH PROVIDES INFORMATION REGARDING THE FUNCTION, DESIGN, MAINTENANCE, AND REPAIR OF SEMICONDUCTOR MANUFACTURING EQUIPMENT; REMOTE MONITORING OF THE CONDITION AND FUNCTIONALITY OF SEMICONDUCTOR MANUFACTURING EQUIPMENT (U.S. CLS. 100 AND 101).

SN 76-122,615. PICKWICK S.N.C. DI DIEGO BARBARESI E MARCO NICOLINI, 00199 ROME, ITALY, FILED 9-1-2000.



PRIORITY CLAIMED UNDER SEC. 44(D) ON ITALY APPLICATION NO. RM2000C00391, FILED 6-19-2000, REG. NO. 848692, DATED 6-19-2000, EXPIRES 6-19-2010.

NO CLAIM IS MADE TO THE EXCLUSIVE RIGHT TO USE "COLOUR GROUP" AND "ACTION APPAREL", APART FROM THE MARK AS SHOWN.

CLASS 16—PAPER GOODS AND PRINTED MATTER

FOR PRINTED MATTER, NAMELY BROCHURES AND NEWSLETTERS AND PUBLICATIONS, NAMELY MAGAZINES ON THE SUBJECT OF FASHION; NEWSPAPERS, PERIODICALS, NAMELY MAGAZINES AND BOOKS ALL ON THE SUBJECT OF FASHION AND CASUAL WEAR; PAPER AND CARDBOARD ARTICLES, NAMELY ENVELOPES, NOTEBOOKS, EXERCISE-BOOKS, STATIONERY, DIARIES, CALENDARS, POSTERS, UNMOUNTED PHOTOGRAPHS AND GRAPHIC ART REPRODUCTIONS, PLAYING CARDS, OFFICE AND SCHOOL STATIONERY ARTICLES, NAMELY NOTEPADS, WRITING PAPER, EXERCISE-BOOKS, DIARIES (U.S. CLS. 2, 5, 22, 23, 29, 37, 38 AND 50).

CLASS 18—LEATHER GOODS

FOR LEATHER AND IMITATION OF LEATHER GOODS, NAMELY PURSES, WALLETS, KEY-CASES AND HANDBAGS; BAGS NAMELY HANDBAGS, CARRY-ON BAGS, TEXTILE SHOPPING BAGS, BEACH BAGS, BOOK BAGS, ALL PURPOSE ATHLETIC BAGS, RUCKSACKS AND BACKPACKS, TRUNKS, SUITCASES AND TRAVELING BAGS, PURSES, WALLETS AND KEY-CASES, ANIMAL SKINS, UMBRELLAS, PARASOLS AND WALKING STICKS, WHIPS, HARNESS AND SADDLERY (U.S. CLS. 1, 2, 3, 22 AND 41).

CLASS 25—CLOTHING

FOR CLOTHING ARTICLES, NAMELY TROUSERS, PANTS, SLACKS, SHORTS, SHIRTS, SPORT SHIRTS, SWEATERS, JUMPERS, T-SHIRTS, DRESSES, SUITS, SKIRTS, JACKETS, COATS, RAINCOATS, BATHROBES, UNDERWEAR, PAJAMAS, GLOVES, SCARVES, TIES, BELTS, SOCKS, FOOTWEAR AND HEADWEAR (U.S. CLS. 22 AND 39).

SN 76-122,671. SCOTT-GROSS CO., INC., LEXINGTON, KY. FILED 9-5-2000.

SCOTT-GROSS

CLASS 1—CHEMICALS

FOR INDUSTRIAL AND CRYOGENIC LIQUIDS FOR USE IN WELDING, CUTTING METALS, AND MANUFACTURING PROCESSES IN MANUFACTURING PLANTS AND GASES (U.S. CLS. 1, 5, 6, 10, 26 AND 46). FIRST USE 11-2-1990; IN COMMERCE 1-23-1995.

CLASS 5—PHARMACEUTICALS

FOR CRYOGENIC LIQUIDS FOR USE IN HOSPITALS, PHYSICIAN'S OFFICES, AND DENTIST'S OFFICES, FOR USE WITH SURGICAL TOOLS, AND FOR BREATHING PURPOSES (U.S. CLS. 6, 18, 44, 46, 51 AND 52).

FIRST USE 11-2-1990; IN COMMERCE 1-3-1995.

SN 76-124,458. PREMIER POWER WELDER LLC, CARBONDALE, CO. FILED 9-11-2000.



CLASS 7—MACHINERY

FOR MACHINERY, NAMELY ELECTRIC WELDING MACHINES, AND PARTS THEREFOR, NAMELY ELECTRICAL ALTERNATORS AND GENERATORS (U.S. CLS. 13, 19, 21, 23, 31, 34 AND 35).

FIRST USE 3-17-1994; IN COMMERCE 3-17-1994.

CLASS 25—CLOTHING

FOR CLOTHING, NAMELY CAPS, HATS, AND T-SHIRTS (U.S. CLS. 22 AND 39).

FIRST USE 3-17-1994; IN COMMERCE 3-17-1994.

SN 76-125,138. BERCO INDUSTRIES, INC., ST. LOUIS, MO. FILED 9-8-2000.



CLASS 9—ELECTRICAL AND SCIENTIFIC APPARATUS

FOR ELECTRIC CABLES AND ELECTRICAL RECEPTACLES FOR USE WITH FURNITURE, NAMELY TABLES; POWER TABLES WITH INTEGRATED POWER SOURCE (U.S. CLS. 21, 23, 26, 36 AND 38).

CLASS 20—FURNITURE AND ARTICLES NOT OTHERWISE CLASSIFIED

FOR FURNITURE, NAMELY, CHAIRS, OFFICE AND BUSINESS CHAIRS, TABLES, OFFICE AND BUSINESS TABLES; TABLE PARTS, NAMELY TABLE TOPS, PEDESTALS, MOUNTING PLATES, CASTERS AND NON-METAL TABLE STORAGE RACKS; FOLDING TABLES; COMPUTER WORKSTATIONS COMPRISING POWER AND DATA MANAGEMENT TABLES (U.S. CLS. 2, 13, 22, 25, 32 AND 50).

SN 76-126,468. BRAMBLES AUSTRALIA LIMITED (AUSTRALIA COMPANY), SYDNEY, NEW SOUTH WALES 2000, AUSTRALIA, FILED 9-12-2000.

RESTORE

CLASS 35—ADVERTISING AND BUSINESS

FOR DOCUMENT MANAGEMENT SERVICES, NAMELY, BUSINESS RECORDS MANAGEMENT SERVICES, DOCUMENT INVENTORY AND FILING SERVICES, AND COMPUTERIZED DOCUMENT DATABASE MANAGEMENT FOR OTHERS (U.S. CLS. 100, 101 AND 102).

CLASS 39—TRANSPORTATION AND STORAGE

FOR ELECTRONIC STORAGE OF FILES AND DOCUMENTS (U.S. CLS. 100 AND 105).

SN 76-126,699. HATLEY LITTLE BLUE HOUSE, LENNOXVILLE, CANADA, FILED 9-11-2000.



Hatley

SEC. 2(F).

CLASS 16—PAPER GOODS AND PRINTED MATTER

FOR STATIONERY, NAMELY, MAGNETIC LIST PADS, MAGNETIC NOTE AND MEMO PADS, BLANK WRITING JOURNALS, ADDRESS BOOKS AND WRAPPING PAPER (U.S. CLS. 2, 5, 22, 23, 29, 37, 38 AND 50).
FIRST USE 1-1-1990; IN COMMERCE 1-1-1990.

CLASS 25—CLOTHING

FOR ADULT AND CHILD TEE-SHIRTS, NIGHTDRESSES, SLEEPSHIRTS, BOXER SHORTS, PANTS, DAY ROMPERS, JACKETS AND APRONS (U.S. CLS. 22 AND 39).
FIRST USE 1-1-1990; IN COMMERCE 1-1-1990.

SN 76-127,628. VORTALLOGIC, INC., ROSWELL, GA. FILED 9-13-2000.

CLUB LOGIC

NO CLAIM IS MADE TO THE EXCLUSIVE RIGHT TO USE "CLUB", APART FROM THE MARK AS SHOWN.

CLASS 9—ELECTRICAL AND SCIENTIFIC APPARATUS

FOR COMPUTER SOFTWARE FOR MANAGING THE WEBSITES OF PRIVATE CLUBS AND RECREATIONAL RESORTS FEATURING SOFTWARE APPLICATIONS FOR WEB SITE CONTENT MANAGEMENT, MEMBERSHIP INFORMATION MANAGEMENT, SCHEDULING ACTIVITIES, EVENTS AND RESERVATIONS, FACILITATING COMMUNICATION BETWEEN MEMBERS AND BETWEEN MEMBERS AND MANAGEMENT; COMPUTER SOFTWARE FOR USE IN WEB SITE MANAGEMENT OF RETAIL STORES IN THE NATURE OF DRUG STORES, PRO SHOPS AND SOUVENIR STORES AT PRIVATE CLUBS AND RECREATIONAL RESORTS, AND USER MANUALS SOLD THEREWITH AS A UNIT (U.S. CLS. 21, 23, 26, 36 AND 38).
FIRST USE 6-21-2000; IN COMMERCE 6-21-2000.

CLASS 42—SCIENTIFIC, COMPUTER AND LEGAL SERVICES

FOR WEB SITE DESIGN AND DEVELOPMENT SERVICES, NAMELY DESIGNING AND DEVELOPING ORGANIZATIONAL, SCHEDULING, MANAGEMENT, COMMUNICATIONS AND RETAIL COMPUTER SOFTWARE APPLICATIONS FOR OTHERS FOR USE ON COMPUTER NETWORKS, AND HOSTING THE WEB SITES OF OTHERS ON A COMPUTER SERVER FOR A GLOBAL COMPUTER NETWORK; SOFTWARE MAINTENANCE AND CONFIGURATION MANAGEMENT SERVICES; COMPUTER CONSULTATION, CONFIGURATION AND INTEGRATION OF COMPUTER SYSTEMS AND NETWORKS (U.S. CLS. 100 AND 101).
FIRST USE 6-21-2000; IN COMMERCE 6-21-2000.

SN 76-128,992. ELLIS FIBRE LIMITED, DUNEDIN, NEW ZEALAND, FILED 9-15-2000.

AROMASLEEP

PRIORITY CLAIMED UNDER SEC. 44(D) ON NEW ZEALAND APPLICATION NO. 610407, FILED 3-15-2000, REG. NO. 610407, DATED 3-15-2000, EXPIRES 3-15-2007.

PRIORITY CLAIMED UNDER SEC. 44(D) ON NEW ZEALAND APPLICATION NO. 610408, FILED 3-15-2000, REG. NO. 610408, DATED 3-15-2000, EXPIRES 3-15-2007.

CLASS 20—FURNITURE AND ARTICLES NOT OTHERWISE CLASSIFIED

FOR PILLOWS (U.S. CLS. 2, 13, 22, 25, 32 AND 50).

CLASS 24—FABRICS

FOR DUVETS, BED BLANKETS, MATTRESS COVERS AND PADS AND BED LINEN (U.S. CLS. 42 AND 50).

SN 76-130,286. NATIONAL STRATEGY GROUP, INC., WINDSOR, CO. FILED 9-18-2000.

FIND YOUR SPOT

CLASS 35—ADVERTISING AND BUSINESS

FOR PROVIDING A DATABASE OF INFORMATION ABOUT EMPLOYMENT AND RELOCATION OPPORTUNITIES IN DIFFERENT GEOGRAPHIC LOCATIONS AND COMMUNITIES (U.S. CLS. 100, 101 AND 102).
FIRST USE 8-25-2000; IN COMMERCE 8-25-2000.

CLASS 42—SCIENTIFIC, COMPUTER AND LEGAL SERVICES

FOR COMPUTER SERVICES, NAMELY, PROVIDING AN ONLINE SURVEY TO HELP USERS DETERMINE THE BEST GEOGRAPHIC LOCATION AND EMPLOYMENT OPPORTUNITIES SUITED TO THEIR INDIVIDUAL PREFERENCES AND PROVIDING A DATABASE OF INFORMATION ABOUT SPECIFIC GEOGRAPHIC AREAS AND COMMUNITIES, AND THE EMPLOYMENT AND RELOCATION OPPORTUNITIES WITHIN THOSE AREAS (U.S. CLS. 100 AND 101).

FIRST USE 8-25-2000; IN COMMERCE 8-25-2000.

SN 76-132,713. COMPAGNIE FRANCAISE D'ASSURANCE POUR LE COMMERCE EXTERIEUR, 92800 PUTEAUX, FRANCE, FILED 9-21-2000.

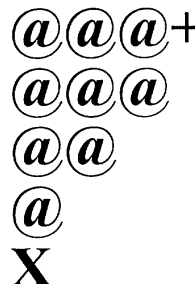

SN 76-130,871. SUDDEN IMPACT RACING, FRACKVILLE, PA. FILED 9-19-2000.

ERADICATOR

CLASS 25—CLOTHING

FOR CLOTHING, NAMELY, HAT AND SHIRTS (U.S. CLS. 22 AND 39).

FIRST USE 11-1-1994; IN COMMERCE 11-1-1994.

OWNER OF FRANCE REG. NO. 003016149, DATED 3-22-2000, EXPIRES 3-22-2010.

CLASS 41—EDUCATION AND ENTERTAINMENT

FOR ENTERTAINMENT SERVICES IN THE NATURE OF MONSTER TRUCK COMPETITIONS AND EXHIBITIONS (U.S. CLS. 100, 101 AND 107).

FIRST USE 1-0-1995; IN COMMERCE 1-0-1995.

CLASS 9—ELECTRICAL AND SCIENTIFIC APPARATUS

FOR COMPUTER SOFTWARE FOR USE IN DATABASE FILE MANAGEMENT IN THE FIELD OF INSURANCE AND IN THE FIELD OF FINANCE AND IN THE FIELD OF COMMERCIAL INFORMATION (U.S. CLS. 21, 23, 26, 36 AND 38).

SN 76-130,947. ASCOM HASLER MAILING SYSTEMS, INC., SHELTON, CT. FILED 9-19-2000.

SAFEPOST

CLASS 35—ADVERTISING AND BUSINESS

FOR BUSINESS MANAGEMENT; BUSINESS ADMINISTRATION, NAMELY, PREPARING BUSINESS REPORTS, AUDITING; BUSINESS ORGANIZATION CONSULTANCY; INFORMATION IN THE FIELD OF BUSINESS AND COMPANIES; BUSINESS ENQUIRIES IN THE FIELD OF COMPANIES AND MARKETS; COMPUTERIZED FILE MANAGEMENT SERVICES; BUSINESS APPRAISALS; ECONOMIC FORECASTING AND ANALYSIS (U.S. CLS. 100, 101 AND 102).

CLASS 9—ELECTRICAL AND SCIENTIFIC APPARATUS

FOR COMPUTER HARDWARE; COMPUTER SOFTWARE FOR CALCULATING, PRINTING, DETERMINING, TRANSMITTING AND GENERATING POSTAGE, SORTING AND SHIPPING PACKAGES AND LETTERS, DATABASE MANAGEMENT OF MAILING, SHIPPING, AND POSTAGE, ACCESSING WORLD POST SPECIFICATIONS, TRACKING SHIPPING AND TRACKING POSTAGE USE, CALCULATING WORLDWIDE POSTAGE RATE AND WORLDWIDE POSTAL SPECIFICATIONS, AND SOFTWARE FOR USE IN CODING AND DECODING CONFIDENTIAL AND/OR FINANCIAL INFORMATION (U.S. CLS. 21, 23, 26, 36 AND 38).

CLASS 36—INSURANCE AND FINANCIAL

FOR CREDIT-INSURANCE SERVICES; BANKING; GENERATING OF FINANCIAL EXPERT REPORTS; FINANCIAL ANALYSIS AND CONSULTATION, FISCAL ASSESSMENT AND EVALUATION (U.S. CLS. 100, 101 AND 102).

CLASS 42—SCIENTIFIC, COMPUTER AND LEGAL SERVICES

FOR PROVIDING HARDWARE AND SOFTWARE COMPUTER SOLUTIONS THAT FACILITATE POSTAGE AND SHIPPING, NAMELY, CONSULTATION SERVICES IN THE FIELD OF POSTAGE AND SHIPPING, INTEGRATING, FACILITATING, AND ANALYZING HARDWARE AND COMPUTER SOFTWARE TO FACILITATE POSTAGE AND SHIPPING, COMPUTER SOFTWARE DESIGN AND DEVELOPMENT SERVICES FOR OTHERS IN THE FIELD OF POSTAGE AND SHIPPING PROVIDING ENCODING SERVICES FOR USE WITH CONFIDENTIAL AND/OR FINANCIAL INFORMATION, NAMELY, DATA ENCRYPTION SERVICES (U.S. CLS. 100 AND 101).

CLASS 38—COMMUNICATION

FOR ELECTRONIC MAIL SERVICES; ELECTRONIC TRANSMISSION OF DATA AND DOCUMENTS VIA COMPUTER TERMINALS; COMMUNICATION SERVICES, NAMELY, DELIVERY OF MESSAGES BY ELECTRONIC TRANSMISSION COMMUNICATIONS; TELEMATIC COMMUNICATIONS SERVICES, NAMELY, TRANSMISSION OF DIGITAL DATA STREAMS TO VIDEO TERMINALS AND TELECOMMUNICATION SERVICES BY MEANS OF DATA TRANSMISSION FROM A COMPUTER MODEM; PROVIDING MULTI-USER ACCESS TO A GLOBAL COMPUTER INFORMATION NETWORK (U.S. CLS. 100, 101 AND 104).

CLASS 42—SCIENTIFIC, COMPUTER AND LEGAL SERVICES

FOR NEWS AGENCIES, NAMELY, GATHERING AND DISSEMINATION OF NEWS (U.S. CLS. 100 AND 101).

SN 76-133,270. CMC MAGNETICS CORPORATION, TAIPEI, TAIWAN, FILED 9-21-2000.

SN 76-133,696. HIREABILITY.COM LLC, MANCHESTER, NH. FILED 9-22-2000.



CLASS 38—COMMUNICATION

FOR ELECTRONIC MAIL SERVICES (U.S. CLS. 100, 101 AND 104).
FIRST USE 3-22-2000; IN COMMERCE 3-22-2000.

CLASS 42—SCIENTIFIC, COMPUTER AND LEGAL SERVICES

FOR COMPUTER SERVICES, NAMELY, CONDUCTING SEARCHES FOR CHINESE AND ENGLISH DOMAIN NAMES FOR OTHERS ON A GLOBAL COMPUTER NETWORK, PROVIDING SEARCH ENGINES FOR OBTAINING DATA ON A GLOBAL COMPUTER NETWORK, PROVIDING INFORMATION RELATING TO DOMAIN NAMES ON A GLOBAL COMPUTER NETWORK, MANAGEMENT AND ADMINISTRATION OF DOMAINS AND DOMAIN NAMES ON A GLOBAL COMPUTER NETWORK; REGISTRATION OF CHINESE AND ENGLISH DOMAIN NAMES FOR IDENTIFICATION OF USERS ON A GLOBAL COMPUTER NETWORK; HOSTING THE WEB SITES OF OTHERS ON A COMPUTER SERVER FOR A GLOBAL COMPUTER NETWORK; HOSTING DOMAIN NAMES OF OTHERS ON A COMPUTER SERVER FOR A GLOBAL COMPUTER NETWORK (U.S. CLS. 100 AND 101).
FIRST USE 3-22-2000; IN COMMERCE 3-22-2000.

SN 76-133,307. AVENTIS PHARMA HOLDING GMBH, FED REP GERMANY, FILED 9-20-2000.

SOLOSTAR

PRIORITY CLAIMED UNDER SEC. 44(D) ON FED REP GERMANY APPLICATION NO. 30052775.6, FILED 7-14-2000, REG. NO. 30052775, DATED 7-14-2000, EXPIRES 7-31-2010.

CLASS 5—PHARMACEUTICALS

FOR INSULIN PREPARATIONS (U.S. CLS. 6, 18, 44, 46, 51 AND 52).

CLASS 10—MEDICAL APPARATUS

FOR MEDICAL DEVICES AND APPARATUS, NAMELY PENS FOR INSULIN (U.S. CLS. 26, 39 AND 44).

TALENT TRADER

CLASS 35—ADVERTISING AND BUSINESS

FOR EMPLOYMENT SERVICES, NAMELY, PROVIDING AN ON-LINE COMPUTER DATABASE FOR EMPLOYERS REGARDING INDEPENDENT CONTRACTORS AND FOR INDEPENDENT CONTRACTORS REGARDING POTENTIAL EMPLOYMENT OPPORTUNITIES, VIA A GLOBAL COMPUTER NETWORK; PAYROLL SERVICES, NAMELY, PAYROLL PREPARATION (U.S. CLS. 100, 101 AND 102).

CLASS 36—INSURANCE AND FINANCIAL

FOR PAYROLL SERVICES, NAMELY, PAYROLL TAX DEBITING SERVICES (U.S. CLS. 100, 101 AND 102).

SN 76-134,793. BUSINESS TELECOM, INC., RALEIGH, NC. FILED 9-26-2000.

MAX COMMERCE

NO CLAIM IS MADE TO THE EXCLUSIVE RIGHT TO USE "COMMERCE", APART FROM THE MARK AS SHOWN.

CLASS 35—ADVERTISING AND BUSINESS

FOR BUSINESS MARKETING CONSULTING SERVICES; DISSEMINATION OF ADVERTISING VIA AN ON-LINE ELECTRONIC COMMUNICATIONS NETWORK; PLACING ADVERTISEMENTS FOR OTHERS; AND PREPARING ADVERTISEMENTS FOR OTHERS (U.S. CLS. 100, 101 AND 102).
FIRST USE 1-1-1999; IN COMMERCE 1-1-1999.

CLASS 42—SCIENTIFIC, COMPUTER AND LEGAL SERVICES

FOR DESIGNING AND IMPLEMENTING NETWORK WEB SITES FOR OTHERS; COMPUTER CONSULTING SERVICES, NAMELY, CONSULTATION REGARDING BUSINESS USE OF GLOBAL COMPUTER NETWORK TECHNOLOGY, NAMELY INTERNET AND WORLD WIDE WEB BUSINESS STRATEGIES (U.S. CLS. 100 AND 101).
FIRST USE 1-1-1999; IN COMMERCE 1-1-1999.

SN 76-136,426. VAONE CO., LTD., SEOUL, REPUBLIC OF KOREA, FILED 9-28-2000.



CLASS 9—ELECTRICAL AND SCIENTIFIC APPARATUS

FOR TELEVISION APPARATUS, NAMELY, INTERNET SET-TOP BOXES FOR TELEVISIONS FOR PROVIDING CONNECTIONS TO THE INTERNET; COMPUTER HARDWARE, COMPUTER PERIPHERALS, NAMELY, HARD DISKS AND TELEVISION SETS (U.S. CLS. 21, 23, 26, 36 AND 38).

CLASS 38—COMMUNICATION

FOR CABLE TELEVISION BROADCASTING; CABLE TELEVISION TRANSMISSION; VIDEO BROADCASTING OVER THE INTERNET AND VIDEO-ON-DEMAND TRANSMISSION SERVICES (U.S. CLS. 100, 101 AND 104).

CLASS 41—EDUCATION AND ENTERTAINMENT

FOR PRODUCTION AND DISTRIBUTION OF CABLE TELEVISION PROGRAMS; PRODUCTION AND DISTRIBUTION OF TELEVISION MUSIC ENTERTAINMENT PROGRAMS; PRODUCTION OF TELEVISION PROGRAMS OVER THE INTERNET; CABLE TELEVISION AND SATELLITE TELEVISION BROADCASTING SERVICES; PROVIDING ENTERTAINMENT INFORMATION, PROVIDING ONLINE MUSIC VIA A GLOBAL COMPUTER AND CABLE NETWORK (U.S. CLS. 100, 101 AND 107).

CLASS 42—SCIENTIFIC, COMPUTER AND LEGAL SERVICES

FOR COMPUTER CONSULTATION; COMPUTER PROGRAMMING FOR OTHERS; COMPUTER SITE DESIGN; COMPUTER SOFTWARE DESIGN FOR OTHERS (U.S. CLS. 100 AND 101).

SN 76-138,324. GALLUP, INC., LINCOLN, NE. FILED 9-29-2000.

Q12

CLASS 16—PAPER GOODS AND PRINTED MATTER

FOR QUESTIONNAIRES AND SURVEYS WHICH ENABLE EMPLOYERS TO GATHER AND INTERPRET DATA TO HELP MEASURE THE QUALITY OF THE WORKPLACE, AND WORKPLACE SATISFACTION (U.S. CLS. 2, 5, 22, 23, 29, 37, 38 AND 50).

FIRST USE 1-1-1992; IN COMMERCE 1-1-1992.

CLASS 35—ADVERTISING AND BUSINESS

FOR BUSINESS MANAGEMENT CONSULTATION, NAMELY, CONSULTING BUSINESSES IN IMPROVING THE QUALITY OF THE WORKPLACE, AND WORKPLACE SATISFACTION, THROUGH THE USE AND IMPLEMENTATION OF QUALITY IMPROVEMENT PROCESSES (U.S. CLS. 100, 101 AND 102).

FIRST USE 1-1-1992; IN COMMERCE 1-1-1992.

SN 76-138,987. BUSH - CHENEY 2000 INC., AUSTIN, TX. FILED 10-2-2000.

BUSH CHENEY

CLASS 25—CLOTHING

FOR CLOTHING, INCLUDING T-SHIRTS, SWEATSHIRTS, AND HATS AND CAPS (U.S. CLS. 22 AND 39).

FIRST USE 8-0-2000; IN COMMERCE 8-0-2000.

CLASS 42—SCIENTIFIC, COMPUTER AND LEGAL SERVICES

FOR FEDERAL CAMPAIGN COMMITTEE SERVICES, INCLUDING, PROMOTING AND ADVOCATING THE ELECTION OF GEORGE W BUSH FOR THE OFFICE OF PRESIDENT OF THE UNITED STATES AND RICHARD CHENEY FOR THE OFFICE OF VICE PRESIDENT OF THE UNITED STATES IN THE FIELD OF POLITICS; AND PROVIDING INFORMATION IN THE FIELD OF POLITICS BY MEANS OF A GLOBAL COMPUTER NETWORK (U.S. CLS. 100 AND 101).

FIRST USE 8-0-2000; IN COMMERCE 8-0-2000.

SN 76-139,168. DAIHAN PAINT & INK CO., LTD., GYOUNG-GI-DO, REPUBLIC OF KOREA, FILED 10-2-2000.

DPI CO., LTD.

NO CLAIM IS MADE TO THE EXCLUSIVE RIGHT TO USE "CO., LTD.", APART FROM THE MARK AS SHOWN.

CLASS 1—CHEMICALS

FOR UNSATURATED POLYESTER RESIN FOR USE IN THE COATING INDUSTRY; POLYESTER RESIN FOR USE IN THE MANUFACTURE OF PAINT; POLYURETHANE RESIN FOR USE IN THE MANUFACTURE OF PAINT; UNPROCESSED ACRYLIC RESIN FOR USE IN THE PAINT INDUSTRY; ARTIFICIAL UNPROCESSED ACRYLIC RESIN FOR USE IN THE PAINT INDUSTRY; PHENOL RESIN FOR USE IN THE MANUFACTURE OF INK; POLYETHYLENE RESIN FOR USE IN THE MANUFACTURE OF PAINT; FLUORINE RESIN FOR USE IN THE PAINT INDUSTRY; POLYVINYL CHLORIDE RESIN FOR USE IN THE MANUFACTURE OF PLASTIC PIPE; TWO-PART EPOXY RESIN FOR USE IN THE MANUFACTURE OF PAINT; ANTISEPTIC AGENT FOR USE IN THE MANUFACTURE OF PAINT; INDUSTRIAL WATER REPELLENT CHEMICALS, NAMELY, SILICONE COMPOSITIONS; ADHESIVE FOR THE MANUFACTURE OF EPOXY RESIN USED IN CONSTRUCTION (U.S. CLS. 1, 5, 6, 10, 26 AND 46).

CLASS 2—PAINTS

FOR EXTERIOR PAINT; INTERIOR PAINT; VARNISH; FIRE RESISTING PAINT; SYNTHETIC RESIN PAINT; CHEMICAL RESISTANT PAINT; FLUORESCENT PAINT; WATER PROOFING PAINT; GLAZIERS' PUTTY FOR COATING; PAINT THINNER; WATER PAINT; LACQUER IN THE NATURE OF A COATING; ENAMEL COATINGS IN THE NATURE OF PAINTS; SULFUR DYES; PRINTING INK; STENCIL INK; ROTOGRAVURE INK; SCREEN PAINTING INK (U.S. CLS. 6, 11 AND 16).

CLASS 35—ADVERTISING AND BUSINESS

FOR IMPORT-EXPORT AGENCY SERVICES; RETAIL STORE SERVICES FEATURING PAINTS; PIGMENTS, DYES, AND RELATED PAINTING ACCESSORIES AND WORKING CLOTHES FOR PAINTING SALES AGENCY (U.S. CLS. 100, 101 AND 102).

CLASS 37—CONSTRUCTION AND REPAIR

FOR PAINT MANUFACTURING FACTORY CONSTRUCTION; PAINTING IN THE FIELD OF HOMES, BUILDINGS, AND FACTORIES; VARNISHING IN THE FIELD OF HOMES, BUILDINGS, AND FACTORIES; SIGNBOARD PAINTING; TRAFFIC SIGNAL APPARATUS PAINTING; HANGING WALLPAPER (U.S. CLS. 100, 103 AND 106).

SN 76-139,173. DAIHAN PAINT & INK CO., LTD. GYOUNG-GI-DO, REPUBLIC OF KOREA, FILED 10-2-2000.

DPI**CLASS 1—CHEMICALS**

FOR UNSATURATED POLYESTER RESIN FOR USE IN THE COATING INDUSTRY; POLYESTER RESIN FOR USE IN THE MANUFACTURE OF PAINT; POLYURETHANE RESIN FOR USE IN THE MANUFACTURE OF PAINT; UNPROCESSED ACRYLIC RESIN FOR USE IN THE PAINT INDUSTRY; ARTIFICIAL UNPROCESSED ACRYLIC RESIN FOR USE IN THE PAINT INDUSTRY; PHENOL RESIN FOR USE IN THE MANUFACTURE OF INK; POLYETHYLENE RESIN FOR USE IN THE MANUFACTURE OF PAINT; FLUORINE RESIN FOR USE IN THE PAINT INDUSTRY; POLYVINYL CHLORIDE RESIN FOR USE IN THE MANUFACTURE OF PLASTIC PIPE; TWO-PART EPOXY RESIN FOR USE IN THE MANUFACTURE OF PAINT; ANTISTATIC AGENT FOR USE IN THE MANUFACTURE OF PAINT; INDUSTRIAL WATER REPELLENT CHEMICALS, NAMELY, SILICONE COMPOSITIONS; ADHESIVE FOR THE MANUFACTURE OF EPOXY RESIN USED IN CONSTRUCTION (U.S. CLS. 1, 5, 6, 10, 26 AND 46).

CLASS 2—PAINTS

FOR EXTERIOR PAINT; INTERIOR PAINT; VARNISH; FIRE RESISTING PAINT; SYNTHETIC RESIN PAINT; CHEMICAL RESISTANT PAINT; FLUORESCENT PAINT; WATER PROOFING PAINT; GLAZIERS' PUTTY FOR COATING; PAINT THINNER; WATER PAINT; LACQUER IN THE NATURE OF A COATING; ENAMEL COATINGS IN THE NATURE OF PAINTS; SULFUR DYES; PRINTING INK; STENCIL INK; ROTOGRAVURE INK; SCREEN PAINTING INK (U.S. CLS. 6, 11 AND 16).

CLASS 35—ADVERTISING AND BUSINESS

FOR IMPORT-EXPORT AGENCY SERVICES; RETAIL STORE SERVICES FEATURING PAINTS, PIGMENTS, DYES AND RELATED PAINTING ACCESSORIES AND WORKING CLOTHES FOR PAINTING SALES AGENCY (U.S. CLS. 100, 101 AND 102).

CLASS 37—CONSTRUCTION AND REPAIR

FOR PAINT MANUFACTURING FACTORY CONSTRUCTION; PAINTING IN THE FIELD OF HOMES, BUILDINGS, AND FACTORIES; VARNISHING IN THE FIELD OF HOMES, BUILDINGS, AND FACTORIES; SIGNBOARD PAINTING; TRAFFIC SIGNAL APPARATUS PAINTING; HANGING WALLPAPER (U.S. CLS. 100, 103 AND 106).

SN 76-141,022. LATIS NETWORKS, INC., BOULDER, CO. FILED 10-3-2000.

LATIS**CLASS 38—COMMUNICATION**

FOR TELECOMMUNICATIONS SERVICES, NAMELY, PROVIDING MULTIPLE-USER ACCESS TO A GLOBAL COMPUTER NETWORK (U.S. CLS. 100, 101 AND 104).

CLASS 42—SCIENTIFIC, COMPUTER AND LEGAL SERVICES

FOR APPLICATION SERVICE PROVIDER FEATURING NON-DOWNLOADABLE SOFTWARE FOR MONITORING NETWORKS, RESOURCE ALLOCATION AND SYSTEM INVENTORIES FOR OTHERS (U.S. CLS. 100 AND 101).

SN 76-144,765. INNER CITY IMPACT, INC., WEST PALM BEACH, FL. FILED 10-10-2000.

URBAN YOUTH IMPACT

NO CLAIM IS MADE TO THE EXCLUSIVE RIGHT TO USE "URBAN YOUTH", APART FROM THE MARK AS SHOWN.

CLASS 41—EDUCATION AND ENTERTAINMENT

FOR EDUCATIONAL SERVICES, NAMELY, TUTORING IN READING, MATH, WRITING, ANGER MANAGEMENT, CULTURAL ARTS, TEEN ABSTINENCE, JOB PREPARATION, JOB TRAINING, AND COMPUTER USAGE (U.S. CLS. 100, 101 AND 107).

CLASS 42—SCIENTIFIC, COMPUTER AND LEGAL SERVICES

FOR PROVIDING FOOD, CLOTHING AND SUPPLIES TO NEEDY CHILDREN (U.S. CLS. 100 AND 101).

SN 76-145,214. SPHERION PACIFIC ENTERPRISES LLC, FT. LAUDERDALE, FL. FILED 10-12-2000.



enthusian

THE FOCUS POINTS AROUND THE "I" ARE LINED FOR THE COLORS PURPLE, RED AND YELLOW.

CLASS 35—ADVERTISING AND BUSINESS

FOR EMPLOYMENT SERVICES, NAMELY, EMPLOYEE OUTSOURCING SOLUTIONS; PERMANENT AND TEMPORARY PLACEMENT OF PERSONNEL; EMPLOYMENT COUNSELING AND RECRUITING, NAMELY, OFFERING CONSULTING AND STAFFING AND WORK FORCE MANAGEMENT EXPERTISE TO COMPANIES TO AID IN THE ACQUISITION, DEVELOPMENT AND RETENTION OF EMPLOYEES; CONSULTING SERVICES FOR THE RECRUITMENT, RETENTION AND MANAGEMENT OF HUMAN CAPITAL; RECRUITING, INTERVIEWING AND HIRING OF EMPLOYEES ALL VIA A GLOBAL COMPUTER NETWORK; PROVIDING ONLINE COMPUTER DATABASES OF JOB APPLICANTS, JOB AVAILABILITY, EMPLOYEES, APPLICANT AND EMPLOYEE SKILLS AND ABILITIES, AND EMPLOYEE PERFORMANCE BENCHMARKS (U.S. CLS. 100, 101 AND 102).

FIRST USE 9-8-2000; IN COMMERCE 9-8-2000.

CLASS 42—SCIENTIFIC, COMPUTER AND LEGAL SERVICES

FOR TESTING TO DETERMINE EMPLOYMENT SKILLS (U.S. CLS. 100 AND 101).

FIRST USE 9-8-2000; IN COMMERCE 9-8-2000.

SN 76-146,462. XACTWARE, INC., OREM, UT. FILED 10-13-2000.

**CLASS 9—ELECTRICAL AND SCIENTIFIC APPARATUS**

FOR COMPUTER SOFTWARE FOR DOCUMENT MANAGEMENT OF INSURANCE POLICIES, INVENTORY AND WARRANTY DOCUMENTS; COMPUTER SOFTWARE FOR CREATING FLOOR PLANS; COMPUTER SOFTWARE FOR PROVIDING EMAIL ALERTS FOR RECALL NOTICES (U.S. CLS. 21, 23, 26, 36 AND 38).

CLASS 35—ADVERTISING AND BUSINESS

FOR RETAIL ON LINE SERVICES IN THE FIELD OF HOME APPLIANCES; DOCUMENT MANAGEMENT OF INSURANCE POLICIES, INVENTORY AND WARRANTY DOCUMENTS (U.S. CLS. 100, 101 AND 102).

SN 76-148,654. MUSHROOM BIOMEDICAL SYSTEMS HOLDING AG, 8002 ZURICH, SWITZERLAND, FILED 10-17-2000.

OPTISCOPE**CLASS 10—MEDICAL APPARATUS**

FOR SURGICAL AND MEDICAL APPARATUS AND INSTRUMENTS, NAMELY LARYNGOSCOPES (U.S. CLS. 26, 39 AND 44).

CLASS 42—SCIENTIFIC, COMPUTER AND LEGAL SERVICES

FOR MEDICAL RESEARCH, MEDICAL SERVICES, HEALTH CARE; INFORMATION TECHNOLOGY AND COMPUTER SERVICES, NAMELY, COMPUTER PROGRAMMING FOR OTHERS, MAINTENANCE AND UPDATING OF COMPUTER SOFTWARE; COMPUTER SOFTWARE DESIGN FOR OTHERS; RECOVERY OF COMPUTER DATA; INFORMATION SERVICES PROVIDED ONLINE AND BY WAY OF A MOBILE TELECOMMUNICATION DEVICE FROM A COMPUTER DATABASE OR FROM A GLOBAL COMPUTER NETWORK IN THE FIELDS OF MEDICAL AND HEALTHCARE (U.S. CLS. 100 AND 101).

SN 76-149,100. SPITZ, URSULA, 82345 FELDAFING, FED REP GERMANY, FILED 10-18-2000.

GRIPMAN

PRIORITY CLAIMED UNDER SEC. 44(D) ON FED REP GERMANY APPLICATION NO. 30030491.9/2, FILED 4-19-2000, REG. NO. 30030491, DATED 6-19-2000, EXPIRES 4-30-2010.

CLASS 3—COSMETICS AND CLEANING PREPARATIONS

FOR BLEACHING PREPARATIONS AND OTHER SUBSTANCES FOR LAUNDRY USE, NAMELY, LAUNDRY BLEACH AND LAUNDRY DETERGENT; ALL PURPOSE CLEANING PREPARATIONS; FLOOR POLISH; FURNITURE POLISH; SCOURING POWDERS AND LIQUIDS; PRODUCTS FOR BEAUTY AND BODY CARE, NAMELY, SKIN SOAP, BODY SOAP, PERFUME, TOILET WATER, PERSONAL DEODORANTS; ESSENTIAL OILS FOR PERSONAL USE; HAIR LOTIONS, HAIR SHAMPOO; NON-MEDICATED HAIR CARE PREPARATIONS; COSMETICS, NAMELY, EYE-SHADOW, MAKE-UP FOUNDATION, MAKE-UP CREAMS, MAKE-UP POWDERS, NAIL POLISH REMOVER; CREAMS FOR THE SKIN; LOTIONS FOR COSMETIC PURPOSES, NAMELY, SKIN MOISTURIZING LOTIONS, SUN TANNING LOTION, AFTER SUN LOTION; SHAVING CREAM, FOAM AND GEL; AFTER SHAVE LOTION; DENTIFRICES; BATH OIL; BATH CRYSTALS; BATH GELS; LIPSTICKS; COTTON BUDS FOR COSMETIC PURPOSES; NAIL POLISH; SHOE POLISH, MAKE-UP (U.S. CLS. 1, 4, 6, 50, 51 AND 52).

CLASS 9—ELECTRICAL AND SCIENTIFIC APPARATUS

FOR SCIENTIFIC, NAUTICAL, SURVEYING, PHOTOGRAPHIC, CINEMATOGRAPHIC, OPTICAL, WEIGHING, MEASURING, SIGNALING, CHECKING, LIFE-SAVING AND TEACHING APPARATUS AND INSTRUMENTS, NAMELY, PHOTOGRAPHIC CAMERAS, VIDEO CAMERAS, MOTION PICTURE CAMERAS, OPTICAL DISCS AND FILTERS, AUDIO AND VIDEO TAPE PLAYERS, VIDEO DISK PLAYERS AND COMPACT DISC PLAYERS; BLANK FILMS; APPARATUS FOR RECORDING, TRANSMISSION AND REPRODUCTION OF SOUND AND IMAGES, NAMELY, AUDIO AND VIDEO CASSETTE RECORDERS; BLANK AUDIO AND VIDEO CASSETTES, BLANK MAGNETIC DATA CARRIERS, BLANK MAGNETIC COMPUTER TAPES, BLANK MAGNETIC COMPUTER DISKS, BLANK COMPUTER DISKS AND RECORDING DISKS, BLANK ELECTRONIC DATA CARRIERS; PRE-RECORDED FILMS, AUDIO AND VIDEO CASSETTES, AND RECORDING TAPES AND DISKS ALL FEATURING PRE-RECORDED MUSIC, MOTION PICTURES, BOOKS IN SPOKEN FORM, HISTORICAL TOUR DISCUSSIONS, INSTRUCTION ON HOME IMPROVEMENTS, AND HUNTING AND BIRD CALLS; COMPUTER SOFTWARE AND COMPUTER PROGRAMS ALL FOR USE IN DATABASE MANAGEMENT, FOR USE AS SPREADSHEETS, FOR WORD PROCESSING, FOR PROCESSING

PICTURES FROM DIGITAL CAMERAS, FOR COMPILATION AND ELECTRONIC TRANSMISSION OF AUDIO AND VIDEO CONTENT, NAMELY, FINANCIAL AND INVESTMENT INFORMATION, FOR MONITORING AND CONTROLLING TEXT COMPOSITION, AND FOR COMPOSING AND EDITING MUSIC AND AUDIO AND VIDEO CONTENT; MULTIMEDIA SOFTWARE RECORDED ON CD-ROM FEATURING PRE-RECORDED MUSIC, MOTION PICTURES AND INTERACTIVE MAPS; ELECTRONIC COMPUTER MEMORIES AND SIMILAR MEMORY MEDIA, NAMELY, PCMCIA CARDS AND ENCODED SMART CARDS FOR PERSONAL COMPUTERS AND LAPTOP COMPUTERS CONTAINING USER-SPECIFIC INFORMATION AND PROGRAMMING USED FOR STORING, ACCESSING AND TRACKING COMMERCIAL TRANSACTIONS, HEALTH, MEDICAL, BANKING AND FINANCIAL INFORMATION; MAGNETIC CODED CARD READERS; MAGNETIC CODED CARDS; CASH REGISTERS, CALCULATORS; MEMORY CARDS, COMPUTERS, MINIATURE COMPUTERS, DATA PROCESSORS; VIDEO GAMES COMPRISED OF COMPUTER HARDWARE AND COMPUTER GAME SOFTWARE, ALL SOLD AS A UNIT; ELECTRIC APPARATUS AND INSTRUMENTS, NAMELY, ELECTRIC APPARATUS TRANSISTORS; AUTOMATIC VENDING MACHINES; COIN-OPERATED VENDING MACHINES; ELECTRICAL CIRCUITS FOR USE IN AMUSEMENT GAME MACHINES FOR REPRODUCING MUSIC, SPEECH AND SPECIAL EFFECTS, EYE GLASSES, SUN GLASSES, PROTECTIVE GLASSES, FRAMES FOR EYE GLASSES, LENSES FOR EYE GLASSES, CASES FOR EYE GLASSES, PROTECTIVE HELMETS, HELMET VISORS, PROTECTIVE FACE-SHIELDS FOR PROTECTIVE HELMETS, SAFETY GOGGLES, PROTECTIVE GLOVES FOR INDUSTRIAL USE, LIFE JACKETS; DIVING SUITS; FLIPPERS FOR USE IN SCUBA DIVING; BICYCLE SPEEDOMETERS; PROTECTIVE HEADGEAR FOR BOXING AND HORSEBACK RIDING; HELMETS FOR INLINE-SKATING, SKATEBOARDING, ROLLER SKATING, HOCKEY, FOOTBALL, BASEBALL AND CYCLING (U.S. CLS. 21, 23, 26, 36 AND 38).

CLASS 12—VEHICLES

FOR MOTORCYCLES; PARTS FOR MOTORCYCLES, NAMELY, WHEELS, TIRES, FRAMES, MOTORS, BRAKES, GEARS, CHAINS, PEDALS, HANDLEBARS, HUBS, SEATS, SADDLEBAGS, MIRRORS, WIND-SCREENS, HORNS AND LUGGAGE RACKS FOR MOTORCYCLES; BICYCLES; BICYCLES WITH MOTOR; PARTS AND ACCESSORIES FOR BICYCLES, NAMELY, BICYCLE FRAMES, BICYCLE BRAKES, FREEWHEEL GEAR RIMS, BICYCLE DERAILLEUR GEARS, BICYCLE BEARINGS, BICYCLE CHAINS, BICYCLE PEDALS, BICYCLE HANDLEBARS, BICYCLE HUBS, BICYCLE SEATS, BICYCLE TUBES, BICYCLE TIRES, SADDLE-BAGS FOR BICYCLES, BAGS FOR BICYCLES TO BE ATTACHED AT THE HANDLEBARS, BICYCLE TRAILERS, DRESS GUARDS, LUGGAGE CARRIERS ADAPTED FOR BICYCLES, SHOPPING BAGS ADAPTED FOR BICYCLES, BELLS FOR BICYCLES, BICYCLE AIR PUMPS; ROOF RACKS FOR BICYCLES; PRAMS, NAMELY, BABY CARRIAGES; CANOE PADDLES, AND OARS (U.S. CLS. 19, 21, 23, 31, 35 AND 44).

CLASS 14—JEWELRY

FOR PRECIOUS METALS AND THEIR ALLOYS AND GOODS OF PRECIOUS METALS OR COATED THEREWITH, NAMELY, BRACELETS, NECKLACES, EARRINGS, RINGS, ASHTRAYS, JEWELRY BOXES, CANDLESTICKS, CANDLE HOLDERS, CIGARETTE LIGHTERS, MONEY CLIPS, TIE-PINS; JEWELRY, COSTUME JEWELRY; PRECIOUS GEMSTONES; HOROLOGICAL AND CHRONOMETRIC INSTRUMENTS, NAMELY, CLOCKS, ALARM CLOCKS, RADIO ALARM CLOCKS, WATCHES, POCKET WATCHES; WATCH-STRAPS (U.S. CLS. 2, 27, 28 AND 50).

CLASS 16—PAPER GOODS AND PRINTED MATTER

FOR TYPING PAPER, LETTER PAPER, WRAPPING PAPER, DRAWING PAPER, CARDBOARD AND GOODS MADE FROM CARDBOARD, HYGIENIC PAPER, KITCHEN TISSUES, BATHROOM TISSUES, PAPER TOWELS, FACIAL TISSUES, NAPKINS, TISSUES FOR COSMETIC AND CARING PURPOSES; CHILDREN'S BOOKS, RECIPE BOOKS, TRAVEL BOOKS, SONG BOOKS, COLORING BOOKS, ADDRESS BOOKS, APPOINTMENT BOOKS, BUSINESS RECORD BOOKS, NOTE BOOKS, ACCOUNT BOOKS, ACCOUNTING FORMS, BUSINESS FORMS, BLANK FORMS, PRINTED FORMS, NOTEPADS; NEWSPAPERS FOR GENERAL CIRCULATION, MEDICAL AND LEGAL JOURNALS, GENERAL FEATURE MAGAZINES; BROCHURES AND PAMPHLETS ABOUT SPORTS, TRAVEL, HOBBIES, HISTORY, COMPUTERS, SCIENCE AND SCIENCE FICTION; MAGAZINES ABOUT SPORTS, TRAVEL, HOBBIES, HISTORY, COMPUTERS, SCIENCE AND SCIENCE FICTION; CALENDARS, MAPS; CLOTH FOR BOOKBINDING, BOOKBINDING TAPE, BOOKBINDINGS, BOOKBINDING WIRE; MOUNTED AND UNMOUNTED PHOTOGRAPHS; GREETING CARDS; STATIONERY; CHALK, PENS, MARKERS, PENCILS AND CRAYONS, WRITING AND DRAWING INSTRUMENTS; ADHESIVES FOR STATIONERY OR HOUSEHOLD PURPOSES; ARTISTS' MATERIALS, NAMELY, PAINT BRUSHES, CANVAS AND PAINTING SETS; TYPEWRITERS, STAPLERS, STAPLE REMOVERS, PAPER HOLE PUNCHES, FILE FOLDERS, BINDERS; PRINTED INSTRUCTIONAL, EDUCATIONAL AND TEACHING MATERIALS IN THE FIELDS OF SCIENCE, HISTORY, MUSIC, TRAVEL, MOTION PICTURE AND COMPUTER INSTRUCTION; PLASTIC MATERIALS FOR PACKAGING, NAMELY, BUBBLE PACKS, PLASTIC POUCHES, PLASTIC BAGS AND PLASTIC FILMS; TRASH BAGS, GENERAL PURPOSE PLASTIC BAGS, MERCHANDISE BAGS, PAPER BAGS; SIGNS AND BANNERS FOR DISPLAY WINDOWS MADE OF PAPER, PAPER PRINTED SIGNS; PLAYING CARDS; BABY DIAPERS MADE OF PAPER OR CELLULOSE, DISPOSABLE BABY DIAPERS; COLOR PRINTS (U.S. CLS. 2, 5, 22, 23, 29, 37, 38 AND 50).

CLASS 18—LEATHER GOODS

FOR LEATHER AND IMITATIONS OF LEATHER, NAMELY, LUGGAGE, HIP MOUNTED CARRYALL BAGS; ANIMAL SKINS AND HIDES; TRUNKS, BRIEFCASES AND SMALL SUITCASES; BAGS FOR CARRYING CLOTHING, ALL-PURPOSE SPORTS BAGS, ALL-PURPOSE SPORTS BAGS FOR TRACK AND FIELD, FOOTBALL, BASKETBALL, BASEBALL AND SWIMMING, HANDBAGS, SCHOOL BAGS, BOOK BAGS, CARRY-ON BAGS, BACKPACKS, FANNY PACKS; TRAVELING BAGS; TRAVELING MANICURE SET CASES SOLD EMPTY; PURSES, POCKET WALLETS, KEY CASES, BAGS FOR CARRYING BELTS; UMBRELLAS, PARASOLS AND WALKING STICKS; WHIPS, HARNESS STRAPS AND SADDLERY (U.S. CLS. 1, 2, 3, 22 AND 41).

CLASS 25—CLOTHING

FOR CLOTHING, NAMELY, LONG TROUSERS, JEANS, SLACKS, SHORT TROUSERS, SHORTS, BOXER SHORTS, 3/4 LENGTH TROUSERS, SLACKS WITH STRAP UNDER FOOT, CULOTTES, BLOUSES, DRESSES, SWEATERS, SHIRTS, SHORT-SLEEVED SHIRTS, T-SHIRTS, LONG-SLEEVED SHIRTS, SOCKS; FOOTWEAR, HEADWEAR; OUTERWEAR FOR GENTLEMEN, LADIES AND CHILDREN, NAMELY, WAISTCOATS, JACKETS, DENIM JACKETS, COATS, TUNICS, BLAZERS, LOUNGING JACKETS, BOMBER JACKETS, OVERALLS, DUNGAREES; BABIES CLOTHING, NAMELY, SHIRTS, PANTS, UNDER SHIRTS, UNDER PANTS, ONE-PIECE SLEEPERS, DRESSES; UNDERWEAR, LONG UNDERPANTS, SHORT UNDERPANTS, LONG-SLEEVED UNDERSHIRTS, SHORT-SLEEVED UNDERSHIRTS; UNDERGARMENTS; CORSETS, BUS-TIERS; DRESSING GOWNS; HOSIERY; BELTS, BELTS WITH COMPARTMENTS FOR CARRYING MONEY AND OTHER SMALL ITEMS, SUSPENDERS, SCARVES, SHAWLS, GLOVES, TIES, HEADBANDS, BASEBALL CAPS; BATHING FASHION FOR GENTLEMEN AND LADIES, NAMELY, BATHING SUITS, SWIMSUITS AND

BATHING TRUNKS; CLOTHING FOR HIKING, TREKKING, OUTDOOR SPORTS AND CLIMBING, NAMELY, COATS, JACKETS, VESTS, PULLOVERS, SHIRTS, PANTS, SHORTS, SOCKS; LEISURE AND CITY SHOES FOR GENTLEMEN AND LADIES, CHILDREN'S SHOES; ATHLETIC FOOTWEAR; ATHLETIC SHOES FOR HIKING, TREKKING, OUTDOOR SPORTS AND CLIMBING; CLOTHING, FOOTWEAR AND HEADWEAR FOR SOCCER, BASKETBALL, HANDBALL AND VOLLEYBALL, NAMELY, SHIRTS, SHORTS, WARM-UP JACKETS, WARM-UP PANTS, SPORTS SHOES; CLOTHING FOR JOGGING, FITNESS TRAINING AND GYMNASTICS, NAMELY, JOGGING SUITS, SWEATSHIRTS, SWEAT-PANTS, SWEATSHORTS, GYM SHORTS, SWEAT BANDS, HEAD BANDS, BODY SUITS, LEOTARDS, LEGGINGS, LEG WARMERS; CLOTHING, FOOTWEAR AND HEADWEAR FOR TENNIS, SQUASH AND BADMINTON, NAMELY, SHIRTS, SHORTS, SKIRTS, DRESSES, SHOES, HATS, VISORS; CLOTHING, FOOTWEAR AND HEADWEAR FOR INLINE-SKATING, SKATEBOARDING, ROLLER SKATING, HOCKEY, FOOTBALL, BASEBALL AND BOXING, NAMELY, JERSEYS, SHIRTS, PANTS, SHORTS; CLOTHING, FOOTWEAR AND HEADWEAR FOR CYCLING, HORSEBACK RIDING, AND GOLFING, NAMELY, PANTS, SHIRTS, JACKETS, HATS, BOOTS; CLOTHING, FOOTWEAR AND HEADWEAR FOR WATER SPORTS INCLUDING SURFING, SAILING, ROWING, CANOEING AND DIVING, NAMELY, BATHING SUITS, BATHING TRUNKS, WET SUITS, SHIRTS, SHORTS; CLOTHING, FOOTWEAR AND HEADWEAR FOR SKIING, CROSS-COUNTRY SKIING, SNOWBOARDING, ICE-SKATING AND ICE HOCKEY, NAMELY, JACKETS, PANTS, BOOTS, SNOW BOOTS, SNOWBOARD BOOTS, AFTER SKI BOOTS, SKI BOOTS, SKI GLOVES, SKI PANTS, SKI BIBS, HATS, WOOLEN HATS, CAPS, SWEAT BANDS, HEAD BANDS; SKI BOOT BAGS (U.S. CLS. 22 AND 39).

CLASS 28—TOYS AND SPORTING GOODS

FOR GAMES AND PLAYTHINGS, NAMELY, COIN-OPERATED AND HAND HELD UNITS FOR PLAYING ELECTRONIC AND VIDEO GAMES; BOARD GAMES; SPORTING AND GYMNASTIC ARTICLES FOR TREKKING, CLIMBING, SOCCER, BASKETBALL, HANDBALL, VOLLEYBALL, TENNIS, SQUASH, BADMINTON, HOCKEY, FOOTBALL, BASEBALL, CYCLING, HORSEBACK RIDING, GOLFING, SURFING, SAILING, ROWING, CANOEING, DIVING, MOUNTAIN SKIING, CROSS-COUNTRY SKIING, SNOWBOARDING, ICE-SKATING, ICE-HOCKEY, FITNESS TRAINING, INLINE-SKATING, ROLLER SKATING AND SKATEBOARDING, NAMELY, SOCCER BALLS, BASKETBALLS, HAND BALLS, VOLLEYBALLS, TENNIS BALLS, TENNIS RACQUETS, SQUASH BALLS, FOOTBALLS, BASEBALLS, BADMINTON RACQUETS; MOUNTAIN CLIMBING EQUIPMENT, NAMELY, CLIMBING ROPES, NUTS, AND CARABINERS; BASKETBALL HOOPS AND NETS, BATS, BASEBALL GLOVES, SURFBOARDS, SNOWBOARDS, SKATEBOARDS, SKIS, SKI BOOTS, SURF FINS, SNORKELS, SKI POLES, SPORT GOGGLES FOR USE IN SKIING, HOCKEY GLOVES, HOCKEY STICKS, PUCKS, SPORTS BALLS, BIRDIES, RACQUETS, GOLF CLUBS, GOLF BALLS, GOLF TEES, INLINE SKATES, ROLLER SKATES, ICE-SKATES; SCUBA EQUIPMENT, NAMELY, FINS, GOGGLES, MASKS AND FLIPPERS; PORTABLE SKI CARRIERS; PROTECTIVE PADDING FOR PLAYING ICE-HOCKEY; PROTECTIVE WRIST AND JOINT SUPPORTS, GLOVES FOR SKATEBOARDING, ROLLER SKATING, ICE-SKATING; ATHLETIC PROTECTIVE PADS, NAMELY, ELBOW AND KNEE PADS, WRIST AND ANKLE SUPPORTS, SHOULDER PADS, CHEST PADS, RIB PADS, HIP PADS, THIGH PADS, SHIN GUARDS AND PROTECTIVE GLOVES; SPECIAL BAGS IN ORDER TO STORE AND TRANSPORT SPORTING EQUIPMENT, NAMELY, BAGS FOR SKIS AND SKI POLES, SNOWBOARDS, SKATEBOARDS, ROLLER SKATES, ICE SKATES AND INLINE-SKATES (U.S. CLS. 22, 23, 38 AND 50).

SN 76-150,092. STYLEHOUSE LLC, ST. DAVIDS, PA. FILED 10-19-2000.

MAKE YOURS THE ONE THEY REMEMBER

CLASS 35—ADVERTISING AND BUSINESS

FOR RETAIL STORE SERVICES FEATURING HOME FURNISHINGS, ITEMS FOR DECORATING THE HOME, AND PARTY SUPPLIES (U.S. CLS. 100, 101 AND 102).

CLASS 41—EDUCATION AND ENTERTAINMENT

FOR PARTY AND SPECIAL EVENT PLANNING (U.S. CLS. 100, 101 AND 107).

SN 76-150,107. FLORIA, CAMERON, KOLOA, KAWAU, HI. FILED 10-17-2000.

THE CONTINENTALS

OWNER OF U.S. REG. NO. 1,829,260.

CLASS 9—ELECTRICAL AND SCIENTIFIC APPARATUS

FOR PRERECORDED AUDIO CASSETTES, PHONOGRAPH RECORDS, COMPACT DISCS AND VIDEOTAPES FEATURING SONGS AND MUSIC (U.S. CLS. 21, 23, 26, 36 AND 38).

FIRST USE 0-0-1963; IN COMMERCE 0-0-1963.

CLASS 41—EDUCATION AND ENTERTAINMENT

FOR ENTERTAINMENT SERVICES IN THE NATURE OF LIVE PERFORMANCES BY A CHRISTIAN MINISTRY GROUP (U.S. CLS. 100, 101 AND 107).

FIRST USE 0-0-1963; IN COMMERCE 0-0-1963.

SN 76-150,898. LIGHTHOUSE COMMUNICATIONS, INC., DES MOINES, IA. FILED 10-23-2000.

HIPERSERVE

CLASS 39—TRANSPORTATION AND STORAGE

FOR PROVIDING OFF-SITE STORAGE, BACK-UP AND RETRIEVAL OF ELECTRONIC DATA (U.S. CLS. 100 AND 105).

FIRST USE 6-0-1999; IN COMMERCE 6-0-1999.

CLASS 42—SCIENTIFIC, COMPUTER AND LEGAL SERVICES

FOR HOSTING, PROVISION AND MAINTENANCE OF WEB SITES AND DATABASES OF OTHERS ON A COMPUTER SERVER FOR A GLOBAL COMPUTER NETWORK AND INTEGRATION OF COMPUTER SYSTEMS AND NETWORKS (U.S. CLS. 100 AND 101).

FIRST USE 6-0-1999; IN COMMERCE 6-0-1999.

SN 76-151,396. N.V. BEKAERT S.A., B-8550 ZWEVEGEM, BELGIUM, FILED 10-23-2000.

SN 76-154,027. STORAGENETWORKS, INC., WALTHAM, MA. FILED 10-24-2000.

ZEBRANIT

OWNER OF BENELUX REG. NO. 0663515, DATED 2-28-2000, EXPIRES 2-28-2010.

CLASS 6—METAL GOODS

FOR WOVEN FABRICS MADE OF METAL FIBERS; KNITTED METAL FABRICS; KNITTED METAL FABRICS FOR BURNERS; KNITTED METAL FABRICS FOR GAS BURNERS; FABRICS MADE OF METAL FIBERS FOR DOMESTIC AND INDUSTRIAL GAS BURNERS (U.S. CLS. 2, 12, 13, 14, 23, 25 AND 50).

CLASS 11—ENVIRONMENTAL CONTROL APPARATUS

FOR BURNERS, NAMELY, NATURAL GAS BURNERS, PROPANE BURNERS, BUTANE BURNERS; KNITTED METAL FIBER BURNERS, NAMELY, NATURAL GAS BURNERS, PROPANE BURNERS, BUTANE BURNERS; DOMESTIC AND INDUSTRIAL GAS BURNERS; GAS BURNERS MADE OF METAL FIBERS; GAS BURNER PARTS, NAMELY, BURNER SURFACES USED FOR BURNING NATURAL GAS, PROPANE GAS, BUTANE GAS (U.S. CLS. 13, 21, 23, 31 AND 34).

SN 76-152,347. DUDES BY JOSH, L.L.C., MINNEAPOLIS, MN. FILED 10-24-2000.

DUDES BY JOSH

CLASS 16—PAPER GOODS AND PRINTED MATTER

FOR COMIC STRIPS AND BOOKS; POSTERS; WRITING PAPER; ENVELOPES; STATIONERY; MAGAZINES FEATURING CARTOON CHARACTERS; PAPER AND PLASTIC PLACEMATS; AND PAPER BIBS (U.S. CLS. 2, 5, 22, 23, 29, 37, 38 AND 50).

CLASS 24—FABRICS

FOR TEXTILE PLACEMATS, BED SHEETS, BLANKETS, PILLOW CASES, BATH TOWELS, AND FABRICS FOR THE MANUFACTURING OF CLOTHING AND HOUSEHOLD ARTICLES (U.S. CLS. 42 AND 50).

CLASS 25—CLOTHING

FOR CLOTH BIBS, HATS, NIGHTGOWNS, NIGHTSHIRTS, PAJAMAS, T-SHIRTS, SHORTS, SWEATSHIRTS, AND UNDERWEAR (U.S. CLS. 22 AND 39).

CLASS 42—SCIENTIFIC, COMPUTER AND LEGAL SERVICES

FOR COMPUTER SERVICES, NAMELY, PROVIDING ON-LINE COMIC STRIPS, BOOKS AND MAGAZINES FEATURING ANIMATED AND NON-ANIMATED CARTOON CHARACTERS (U.S. CLS. 100 AND 101).

STORMANAGE

CLASS 9—ELECTRICAL AND SCIENTIFIC APPARATUS

FOR COMPUTER SOFTWARE FOR USE IN DATA MANAGEMENT AND STORAGE, IN THE FIELDS OF OFF-SITE AND REMOTE DATA STORAGE (U.S. CLS. 21, 23, 26, 36 AND 38).

CLASS 35—ADVERTISING AND BUSINESS

FOR DATA STORAGE MANAGEMENT SERVICES, NAMELY, DATA STORAGE CAPACITY PLANNING AND DEVELOPMENT, AND MANAGEMENT AND MONITORING OF DATA (U.S. CLS. 100, 101 AND 102).

SN 76-155,043. IRIDIAN TECHNOLOGIES, INC., MARLTON, NJ. FILED 10-27-2000.

AUTHENTICATION SOLUTIONS FOR A NEW ECONOMY

NO CLAIM IS MADE TO THE EXCLUSIVE RIGHT TO USE "AUTHENTICATION SOLUTIONS", APART FROM THE MARK AS SHOWN.

CLASS 9—ELECTRICAL AND SCIENTIFIC APPARATUS

FOR BIOMETRIC IDENTIFICATION EQUIPMENT, NAMELY, OPTICAL INPUT AND OUTPUT DEVICES FOR THE VERIFICATION OF THE IDENTITY OF PEOPLE OR ANIMALS, AND FOR THE IDENTIFICATION OF PEOPLE OR ANIMALS; COMPUTER SOFTWARE FOR THE VERIFICATION OF THE IDENTITY OF PEOPLE OR ANIMALS AND FOR THE IDENTIFICATION OF PEOPLE OR ANIMALS (U.S. CLS. 21, 23, 26, 36 AND 38).

CLASS 42—SCIENTIFIC, COMPUTER AND LEGAL SERVICES

FOR BIOMETRIC IDENTIFICATION SERVICES, NAMELY, THE VERIFICATION OR IDENTIFICATION OF THE IDENTITY PEOPLE AND ANIMALS (U.S. CLS. 100 AND 101).

SN 76-158,228. MAKTOOB.COM, INC., TORTOLA, BR. VIRGIN ISLANDS, FILED 11-1-2000.

SN 76-158,229. MAKTOOB.COM, INC., TORTOLA, BR. VIRGIN ISLANDS, FILED 11-1-2000.

MAKTOOB

CLASS 35—ADVERTISING AND BUSINESS

FOR INTERNET ONLINE COMPUTER SERVICES PROVIDED BY MEANS OF A GLOBAL COMPUTER NETWORK, NAMELY, PROVIDING AND DISTRIBUTING ADVERTISING INFORMATION REGARDING THE WEB SITES, GOODS AND SERVICES OF OTHERS; ONLINE RETAIL AND MAIL ORDER SERVICES IN THE FIELD OF GENERAL CONSUMER MERCHANDISE, NAMELY BOOKS; DIRECTORY SERVICES TO HELP LOCATE PEOPLE, PLACES, ORGANIZATIONS, PHONE NUMBERS, HOME PAGES, AND ELECTRONIC MAIL ADDRESSES (U.S. CLS. 100, 101 AND 102).

FIRST USE 10-0-1998; IN COMMERCE 10-0-1998.

CLASS 38—COMMUNICATION

FOR INTERNET ONLINE ELECTRONIC MAIL SERVICES PROVIDED BY MEANS OF A GLOBAL COMPUTER NETWORK; TELECOMMUNICATIONS GATEWAY ACCESS SERVICES PROVIDING LINKS TO INFORMATION DATABASES AVAILABLE ON OR THROUGH THE INTERNET; INTERNET ONLINE TELECOMMUNICATIONS SERVICES PROVIDED BY MEANS OF THE INTERNET, NAMELY, PROVIDING TELEPHONE AND VOICE COMMUNICATIONS, ELECTRONIC TRANSMISSION OF DATA, RECORDED MUSIC, IMAGES, AND DOCUMENTS VIA COMPUTER TERMINALS AND NETWORKS; PROVIDING ON-LINE CHAT ROOMS FOR TRANSMISSION OF MESSAGES AMONG COMPUTER USERS CONCERNING TOPICS OF GENERAL INTEREST; BROADCASTING SERVICES, NAMELY, AUDIO BROADCASTING, AND RADIO BROADCASTING; PROVIDING A TELECOMMUNICATIONS LINK TO A DOWNLOAD TARGET SITE FOR COMPUTER FILES BELONGING TO OTHERS; VOICE MAIL SERVICES PROVIDED OVER THE INTERNET; PROVIDING TELECOMMUNICATIONS GATEWAY ACCESS LINKS TO DATABASES CONTAINING NEWS, WEATHER, SPORTS, CURRENT EVENTS, TELEVISION PROGRAM LISTINGS, GENERAL INFORMATION AND REFERENCE MATERIALS; ELECTRONIC TRANSMISSION OF GREETING CARDS VIA THE INTERNET (U.S. CLS. 100, 101 AND 104).

FIRST USE 10-0-1998; IN COMMERCE 10-0-1998.

CLASS 42—SCIENTIFIC, COMPUTER AND LEGAL SERVICES

FOR ONLINE SERVICES PROVIDED BY MEANS OF THE INTERNET, NAMELY, PROVIDING SEARCH ENGINES FOR OBTAINING DATA ON A GLOBAL COMPUTER NETWORK; PROVIDING A SEARCH ENGINES FOR COMPUTER USERS TO LOCATE AND INTERACT ON LINE WITH OTHER COMPUTER USERS HAVING SIMILAR INTEREST, HOBBIES AND AFFINITIES; HOSTING THE WEB SITES OF OTHERS ON A COMPUTER SERVER FOR THE INTERNET FEATURING ARTISTIC ENDEAVORS OF OTHERS IN THE FIELD OF POETRY, PROSE, GRAPHIC ART AND PHOTOGRAPHY; COMPUTER SERVICES, NAMELY, CREATING AND MAINTAINING WEB SITES FOR OTHERS FEATURING WRITING AND ARTISTIC ENDEAVOR, COMPUTER-USER WALLPAPERS, AND SCREEN-SAVERS, NEWS, SPORTS, WEATHER, POLITICS, ENTERTAINMENT, PLACES OF ENTERTAINMENT AND RESORT, SCIENTIFIC ISSUES, GENERAL PUBLIC ISSUES AND OPINION SURVEY RESULTS RESPECTING GENERAL ISSUES OF PUBLIC INTEREST, AND INFORMATION OF GENERAL INTEREST (U.S. CLS. 100 AND 101).

FIRST USE 10-0-1998; IN COMMERCE 10-0-1998.



THE ARABIC LANGUAGE WORD "MAKTOOB" MAY BE TRANSLATED INTO ENGLISH AS "WRITTEN".

CLASS 35—ADVERTISING AND BUSINESS

FOR INTERNET ONLINE COMPUTER SERVICES PROVIDED BY MEANS OF A GLOBAL COMPUTER NETWORK, NAMELY, PROVIDING AND DISTRIBUTING ADVERTISING INFORMATION REGARDING THE WEB SITES, GOODS AND SERVICES OF OTHERS; ONLINE RETAIL AND MAIL ORDER SERVICES IN THE FIELD OF GENERAL CONSUMER MERCHANDISE, NAMELY BOOKS; DIRECTORY SERVICES TO HELP LOCATE PEOPLE, PLACES, ORGANIZATIONS, PHONE NUMBERS, HOME PAGES, AND ELECTRONIC MAIL ADDRESSES (U.S. CLS. 100, 101 AND 102).

FIRST USE 10-0-1998; IN COMMERCE 10-0-1998.

CLASS 38—COMMUNICATION

FOR INTERNET ONLINE ELECTRONIC MAIL SERVICES PROVIDED BY MEANS OF A GLOBAL COMPUTER NETWORK; TELECOMMUNICATIONS GATEWAY ACCESS SERVICES PROVIDING LINKS TO INFORMATION DATABASES AVAILABLE ON OR THROUGH THE INTERNET; INTERNET ONLINE TELECOMMUNICATIONS SERVICES PROVIDED BY MEANS OF THE INTERNET, NAMELY, PROVIDING TELEPHONE AND VOICE COMMUNICATIONS, ELECTRONIC TRANSMISSION OF DATA, RECORDED MUSIC, IMAGES, AND DOCUMENTS VIA COMPUTER TERMINALS AND NETWORKS; PROVIDING ON-LINE CHAT ROOMS FOR TRANSMISSION OF MESSAGES AMONG COMPUTER USERS CONCERNING TOPICS OF GENERAL INTEREST; BROADCASTING SERVICES, NAMELY, AUDIO BROADCASTING, AND RADIO BROADCASTING; PROVIDING A TELECOMMUNICATIONS LINK TO A DOWNLOAD TARGET SITE FOR COMPUTER FILES BELONGING TO OTHERS; VOICE MAIL SERVICES PROVIDED OVER THE INTERNET; PROVIDING TELECOMMUNICATIONS GATEWAY ACCESS LINKS TO DATABASES CONTAINING NEWS, WEATHER, SPORTS, CURRENT EVENTS, TELEVISION PROGRAM LISTINGS, GENERAL INFORMATION AND REFERENCE MATERIALS; ELECTRONIC TRANSMISSION OF GREETING CARDS VIA THE INTERNET (U.S. CLS. 100, 101 AND 104).

FIRST USE 10-0-1998; IN COMMERCE 10-0-1998.

CLASS 42—SCIENTIFIC, COMPUTER AND LEGAL SERVICES

FOR ONLINE SERVICES PROVIDED BY MEANS OF THE INTERNET, NAMELY, PROVIDING SEARCH ENGINES FOR OBTAINING DATA ON A GLOBAL COMPUTER NETWORK; PROVIDING A SEARCH ENGINES FOR COMPUTER USERS TO LOCATE AND INTERACT ON LINE WITH OTHER COMPUTER USERS HAVING SIMILAR INTEREST, HOBBIES AND AFFINITIES; HOSTING THE WEB SITES OF OTHERS ON A COMPUTER SERVER FOR THE INTERNET FEATURING ARTISTIC ENDEAVORS OF OTHERS IN THE FIELD OF POETRY, PROSE, GRAPHIC ART AND PHOTOGRAPHY; COMPUTER SERVICES, NAMELY, CREATING AND MAINTAINING WEB SITES FOR OTHERS FEATURING WRITING AND ARTISTIC ENDEAVOR, COMPUTER-USER WALLPAPERS, AND SCREEN-SAVERS, NEWS, SPORTS, WEATHER, POLITICS, ENTERTAINMENT, PLACES OF ENTERTAINMENT AND RESORT, SCIENTIFIC ISSUES, GENERAL PUBLIC ISSUES AND OPINION SURVEY RESULTS RESPECTING GENERAL ISSUES OF PUBLIC INTEREST, AND INFORMATION OF GENERAL INTEREST (U.S. CLS. 100 AND 101).

FIRST USE 10-0-1998; IN COMMERCE 10-0-1998.

SN 76-158,722. OCEAN DESIGN, INC., ORMOND BEACH, FL. FILED 11-6-2000.

OCTOPUS**CLASS 37—CONSTRUCTION AND REPAIR**

FOR SUBSEA INTERCONNECT AND NETWORK SERVICES, NAMELY, INSTALLATION OF TELECOMMUNICATION NETWORKS FOR UNDERWATER MARKETS, NAMELY, OCEANOGRAPHIC, OIL AND GAS, TELECOMMUNICATIONS, MILITARY AND HIGH POWER (U.S. CLS. 100, 103 AND 106).

CLASS 42—SCIENTIFIC, COMPUTER AND LEGAL SERVICES

FOR OIL AND GAS EXPLORATION FOR UNDERWATER MARKETS, NAMELY, OCEANOGRAPHIC, OIL AND GAS, TELECOMMUNICATIONS, MILITARY AND HIGH POWER (U.S. CLS. 100 AND 101).

SN 76-158,836. AMITEE COSMETICS, INC., COSTA MESA, CA. FILED 11-2-2000.

FAT BOY CONCEPTS**CLASS 3—COSMETICS AND CLEANING PREPARATIONS**

FOR NON-MEDICATED HAIR CARE PREPARATIONS AND HAIR STYLING PREPARATIONS; SKIN, HAND, FOOT AND BODY CARE PREPARATIONS, NAMELY, SERUMS, MASKS, CREAMS, OILS, POWDERS, SPRAYS, MISTS, SKIN MOISTURIZERS AND LOTIONS, BATH AND SHOWER GELS AND NON-MEDICATED SALTS, BUBBLE BATH, EYE CREAM, SUN SCREEN, SUN BLOCK, SUNTAN LOTIONS, AND ESSENTIAL OILS FOR PERSONAL USE (U.S. CLS. 1, 4, 6, 50, 51 AND 52).

CLASS 35—ADVERTISING AND BUSINESS

FOR WHOLESALE DISTRIBUTORSHIPS FEATURING HAIR AND SKIN CARE PRODUCTS (U.S. CLS. 100, 101 AND 102).

SN 76-159,934. INDRAWEB, INC., CONCORD, MA. FILED 11-3-2000.

CYCSEARCH**CLASS 40—MATERIAL TREATMENT**

FOR DEVELOPMENT OF CONTENT IN THE NATURE OF DOCUMENT DATA CONVERSION FROM ONE MEDIA FORM TO ANOTHER MEDIA FOR DISSEMINATION BY PUBLISHERS OF REFERENCE BOOKS OVER THE INTERNET (U.S. CLS. 100, 103 AND 106).

CLASS 41—EDUCATION AND ENTERTAINMENT

FOR DEVELOPMENT OF CONTENT IN THE NATURE OF ELECTRONIC PUBLISHER SERVICES, NAMELY, PUBLICATION OF TEXT WORKS FEATURING ORGANIZED LISTS OF REFERENCES TO THE WORKS OF OTHERS (U.S. CLS. 100, 101 AND 107).

SN 76-159,935. INDRAWEB, INC., CONCORD, MA. FILED 11-3-2000.

SURFABLE BOOKS

NO CLAIM IS MADE TO THE EXCLUSIVE RIGHT TO USE "BOOKS", APART FROM THE MARK AS SHOWN.

CLASS 40—MATERIAL TREATMENT

FOR DEVELOPMENT OF CONTENT IN THE NATURE OF DOCUMENT DATA CONVERSION FROM ONE MEDIA FORM TO ANOTHER MEDIA FOR DISSEMINATION BY PUBLISHERS OF REFERENCE BOOKS OVER THE INTERNET (U.S. CLS. 100, 103 AND 106).

CLASS 41—EDUCATION AND ENTERTAINMENT

FOR DEVELOPMENT OF CONTENT IN THE NATURE OF ELECTRONIC PUBLISHER SERVICES, NAMELY, PUBLICATION OF TEXT WORKS FEATURING ORGANIZED LISTS OF REFERENCES TO THE WORKS OF OTHERS (U.S. CLS. 100, 101 AND 107).

SN 76-161,209. INTERVISION, INC., MINATO-KU, TOKYO, JAPAN, FILED 11-6-2000.

ROBO.DEX**CLASS 41—EDUCATION AND ENTERTAINMENT**

FOR PRODUCTION AND DISTRIBUTION OF TELEVISION PROGRAMS, VIDEO CASSETTES AND CONTENT FOR APPEARING ON WEBSITES FEATURING THE SUBJECTS OF ROBOTS, ROBOTIC TECHNOLOGIES AND RELATED DISCIPLINES INVOLVING ROBOTS; PUBLICATION OF BROCHURES ON THE SUBJECT OF ROBOTS, ROBOTIC TECHNOLOGIES AND RELATED DISCIPLINES INVOLVING ROBOTS; ORGANIZING AND CONDUCTING EXHIBITIONS FEATURING ROBOTICS OR OTHERWISE RELATED TO ROBOTS; LIVE MUSICAL AND/OR DRAMATIC PERFORMANCES RELATING TO ROBOTS; AND PRODUCTION AND DISTRIBUTION OF MOVIES RELATING TO ROBOTS (U.S. CLS. 100, 101 AND 107).

CLASS 42—SCIENTIFIC, COMPUTER AND LEGAL SERVICES

FOR PROVIDING A WEB SITE FEATURING THE SUBJECT OF ROBOTS, ROBOTIC TECHNOLOGIES AND RELATED DISCIPLINES INVOLVING ROBOTS (U.S. CLS. 100 AND 101).

SN 76-163,734. RIVERCAP, S.A. LA PUEBLA - ALAVA, SPAIN, FILED 11-13-2000.



NO CLAIM IS MADE TO THE EXCLUSIVE RIGHT TO USE "S.A.", APART FROM THE MARK AS SHOWN.

THE MARK CONSISTS, IN PART, OF A STYLIZED DEPICTION OF THE LETTER "R".

CLASS 6—METAL GOODS

FOR METALLIC CAPSULES FOR BOTTLE SEALING (U.S. CLS. 2, 12, 13, 14, 23, 25 AND 50).

CLASS 7—MACHINERY

FOR MACHINES FOR MANUFACTURING FABRICATED CAPSULES AND MACHINES FOR PLACING THE CAPSULES IN THE BOTTLE (U.S. CLS. 13, 19, 21, 23, 31, 34 AND 35).

CLASS 20—FURNITURE AND ARTICLES NOT OTHERWISE CLASSIFIED

FOR NON-METALLIC CAPSULES FOR BOTTLE SEALING (U.S. CLS. 2, 13, 22, 25, 32 AND 50).

SN 76-163,831. BELL FLAVORS & FRAGRANCES, INC., NORTHBROOK, IL. FILED 11-13-2000.

HALARE FRESH**CLASS 1—CHEMICALS**

FOR CHEMICALS FOR USE IN THE MANUFACTURE OF FLAVORS AND FRAGRANCES; AROMA CHEMICALS, NAMELY, ESTERS, ACIDS, ALDEHYDES, AND NATURAL ESSENTIAL OILS FOR USE IN THE FOOD AND PERSONAL CARE INDUSTRIES; FRAGRANCES FOR USE IN MANUFACTURING TOILETRIES AND COSMETICS; EMULSIFIERS FOR USE IN MANUFACTURING FOODS; SYNTHETIC RESINS FOR USE IN MANUFACTURING COSMETICS; AND ARTIFICIAL SWEETENERS (U.S. CLS. 1, 5, 6, 10, 26 AND 46).

CLASS 3—COSMETICS AND CLEANING PREPARATIONS

FOR ESSENTIAL OILS FOR FLAVORING FOOD AND BEVERAGES; ESSENTIAL OILS FOR USE IN MANUFACTURING MEDICINES AND PHARMACEUTICAL PREPARATIONS; ESSENTIAL OILS FOR USE IN MANUFACTURING PERFUMES, SCENTS, COSMETICS, DETERGENTS, CLEANING PREPARATIONS AND PERSONAL CARE PRODUCTS; SCENTS, PERFUMES; COLOGNES; AND INCENSE (U.S. CLS. 1, 4, 6, 50, 51 AND 52).

CLASS 30—STAPLE FOODS

FOR FOOD AND BEVERAGE FLAVORING ADDITIVES FOR NON-NUTRITIONAL PURPOSES; EXTRACTS USED AS FLAVORING FOR FOOD AND BEVERAGES; FLAVORING SYRUP FOR FOOD AND BEVERAGES; SAUCES; SEASONINGS FOR FOOD AND BEVERAGES; AND FLAVORINGS FOR TOBACCO (U.S. CL. 46).

SN 76-164,489. SOS COMPUTER SYSTEMS, INC., OREM, UT. FILED 11-9-2000.

**CLASS 35—ADVERTISING AND BUSINESS**

FOR DATA PROCESSING SERVICES RENDERED TO CREDIT UNIONS (U.S. CLS. 100, 101 AND 102).

CLASS 42—SCIENTIFIC, COMPUTER AND LEGAL SERVICES

FOR COMPUTER SERVICES, NAMELY COMPUTER HARDWARE AND SOFTWARE DEVELOPMENT SERVICES RENDERED TO CREDIT UNIONS, AND TECHNICAL SUPPORT SERVICES RELATED THERETO VIA TELEPHONE, E-MAIL, INTERNET AND IN PERSON (U.S. CLS. 100 AND 101).

SN 76-165,648. TOMTEC IMAGING SYSTEMS GMBH, D-85716 UNTERSCHLEISSHEIM, FED REP GERMANY, FILED 11-15-2000.

3D SONO-SCAN

PRIORITY CLAIMED UNDER SEC. 44(D) ON FED REP GERMANY APPLICATION NO. 30039561.2/0, FILED 5-24-2000, REG. NO. 30039561, DATED 1-9-2001, EXPIRES 5-31-2010.

NO CLAIM IS MADE TO THE EXCLUSIVE RIGHT TO USE "3D", APART FROM THE MARK AS SHOWN.

CLASS 9—ELECTRICAL AND SCIENTIFIC APPARATUS

FOR COMPUTER SOFTWARE AND HARDWARE FOR USE IN ULTRASOUND IMAGING (U.S. CLS. 21, 23, 26, 36 AND 38).

CLASS 35—ADVERTISING AND BUSINESS

FOR LICENSING OF COMPUTER SOFTWARE; LICENSING OF DATA PROCESSING APPARATUS (U.S. CLS. 100, 101 AND 102).

CLASS 42—SCIENTIFIC, COMPUTER AND LEGAL SERVICES

FOR COMPUTER PROGRAMMING FOR OTHERS; RENTAL OF COMPUTERS, DATA PROCESSORS AND SOFTWARE; MEDICAL SERVICES; TECHNICAL CONSULTATION AND RESEARCH IN THE FIELD OF INDUSTRIAL PROPERTY RIGHTS (U.S. CLS. 100 AND 101).

SN 76-166,930. MYREPAIRSHOP, INC., HOUSTON, TX.
FILED 11-17-2000.



CLASS 37—CONSTRUCTION AND REPAIR

FOR PROVIDING INDEPENDENT AUTOMOTIVE SERVICE PROFESSIONALS AND CAR OWNERS WITH INFORMATION AND DATABASES FEATURING TUNE-UP AND LUBRICATION SPECIFICATIONS, PREVENTIVE MAINTENANCE SCHEDULES AND TECHNICAL AUTOMOTIVE INFORMATION BY MEANS OF A GLOBAL COMPUTER NETWORK (U.S. CLS. 100, 103 AND 106).

CLASS 42—SCIENTIFIC, COMPUTER AND LEGAL SERVICES

FOR PROVIDING HAZARDOUS MATERIALS INFORMATION AND MATERIAL SAFETY DATA SHEET INFORMATION BY MEANS OF A GLOBAL COMPUTER NETWORK (U.S. CLS. 100 AND 101).

SN 76-169,096. CARLCRAFT KNIT SALES, INC., MOON-ACHIE, NJ. FILED 11-21-2000.

ATTITUDES

CLASS 20—FURNITURE AND ARTICLES NOT OTHERWISE CLASSIFIED

FOR CHILDREN'S PILLOWS (U.S. CLS. 2, 13, 22, 25, 32 AND 50).

CLASS 24—FABRICS

FOR CHILDREN'S TEXTILE WALL HANGINGS, BLANKETS, CRIB BUMPERS AND COMFORTERS (U.S. CLS. 42 AND 50).

CLASS 25—CLOTHING

FOR CHILDREN'S APPAREL, NAMELY, HATS AND SHIRTS (U.S. CLS. 22 AND 39).

SN 76-171,290. MERISTAR H&R OPERATING COMPANY, L.P., WASHINGTON, DC. FILED 11-27-2000.

VACATIONS OF A LIFETIME FOR A LIFETIME

CLASS 36—INSURANCE AND FINANCIAL

FOR REAL ESTATE TIMESHARING AND VACATION REAL ESTATE TIMESHARING SERVICES (U.S. CLS. 100, 101 AND 102).

CLASS 42—SCIENTIFIC, COMPUTER AND LEGAL SERVICES

FOR HOTEL AND RESORT HOTEL SERVICES (U.S. CLS. 100 AND 101).

SN 76-171,735. INVESTMENT CHALLENGE INC., TORONTO, ONTARIO, CANADA, FILED 11-28-2000.

CREATING BETTER INVESTORS

NO CLAIM IS MADE TO THE EXCLUSIVE RIGHT TO USE "INVESTORS", APART FROM THE MARK AS SHOWN.

CLASS 16—PAPER GOODS AND PRINTED MATTER

FOR PRINTED MATERIALS, NAMELY PRINTED COURSE MATERIALS IN THE FORM OF GUIDES IN THE FIELD OF STOCKS AND SECURITIES (U.S. CLS. 2, 5, 22, 23, 29, 37, 38 AND 50).

CLASS 35—ADVERTISING AND BUSINESS

FOR DISSEMINATION OF ADVERTISING FOR OTHERS VIA A GLOBAL COMPUTER NETWORK; PLACEMENT OF ADVERTISING FOR OTHERS ON WEBSITES (U.S. CLS. 100, 101 AND 102).

CLASS 41—EDUCATION AND ENTERTAINMENT

FOR EDUCATION SERVICES, NAMELY, PROVIDING COURSES OF INSTRUCTION AND WORKSHOPS ALL IN THE FIELDS OF SECURITIES AND STOCKS (U.S. CLS. 100, 101 AND 107).

CLASS 42—SCIENTIFIC, COMPUTER AND LEGAL SERVICES

FOR COMPUTER SERVICES, NAMELY, HOSTING AND MAINTAINING WEBSITES FOR OTHERS (U.S. CLS. 100 AND 101).

SN 76-172,782. TRICOM USA, INC., JERSEY CITY, NJ.
FILED 11-27-2000.

NO CLAIM IS MADE TO THE EXCLUSIVE RIGHT TO USE "FLORIDA", APART FROM THE MARK AS SHOWN.

THE STIPPLING AND LINING ARE USED TO INDICATE SHADING AND COLOR VARIATIONS, BUT COLOR IS NOT CLAIMED IN THE MARK.

CLASS 9—ELECTRICAL AND SCIENTIFIC APPARATUS

FOR PREPAID MAGNETICALLY ENCODED TELEPHONE CALLING CARDS (U.S. CLS. 21, 23, 26, 36 AND 38).

FIRST USE 7-14-1999; IN COMMERCE 7-14-1999.

CLASS 16—PAPER GOODS AND PRINTED MATTER

FOR TELEPHONE CALLING CARDS, NOT MAGNETICALLY ENCODED (U.S. CLS. 2, 5, 22, 23, 29, 37, 38 AND 50).

FIRST USE 7-14-1999; IN COMMERCE 7-14-1999.

CLASS 38—COMMUNICATION

FOR LONG DISTANCE TELEPHONE SERVICES (U.S. CLS. 100, 101 AND 104).

FIRST USE 7-14-1999; IN COMMERCE 7-14-1999.

SN 76-172,798. TRICOM USA, INC., JERSEY CITY, NJ. FILED 11-27-2000.



NO CLAIM IS MADE TO THE EXCLUSIVE RIGHT TO USE "ASIA", APART FROM THE MARK AS SHOWN.

THE LINING AND STIPLING ARE USED TO INDICATE SHADING AND COLOR VARIATIONS, BUT COLOR IS NOT CLAIMED IN THE MARK.

CLASS 9—ELECTRICAL AND SCIENTIFIC APPARATUS

FOR PREPAID MAGNETICALLY ENCODED TELEPHONE CALLING CARDS (U.S. CLS. 21, 23, 26, 36 AND 38).

FIRST USE 11-5-1999; IN COMMERCE 11-5-1999.

CLASS 16—PAPER GOODS AND PRINTED MATTER

FOR TELEPHONE CALLING CARDS, NOT MAGNETICALLY ENCODED (U.S. CLS. 2, 5, 22, 23, 29, 37, 38 AND 50).

FIRST USE 11-5-1999; IN COMMERCE 11-5-1999.

CLASS 38—COMMUNICATION

FOR LONG DISTANCE TELEPHONE SERVICES (U.S. CLS. 100, 101 AND 104).

FIRST USE 11-5-1999; IN COMMERCE 11-5-1999.

SN 76-173,817. ARTICULEARN, INC., AUSTIN, TX. FILED 11-30-2000.



CLASS 41—EDUCATION AND ENTERTAINMENT

FOR EDUCATION SERVICES, NAMELY, PROVIDING COURSES OF INSTRUCTION AT THE PRIMARY, SECONDARY, COLLEGE, PROFESSIONAL AND HOME-SCHOOLING LEVELS FOR OTHERS; DISTRIBUTING COURSE MATERIALS IN CONNECTION THEREWITH; DEVELOPMENT, PRODUCTION, AND DISSEMINATION OF EDUCATIONAL MATERIALS IN THE FIELDS OF PRIMARY, SECONDARY, COLLEGE, PROFESSIONAL AND HOME-SCHOOLING COURSEWORK LEVELS FOR OTHERS; A VIRTUAL CAMPUS FOR E-LEARNING, NAMELY PROVIDING EDUCATIONAL INFORMATION AND COURSEWORK BY MEANS OF A GLOBAL COMPUTER NETWORK; AUDIO AND VIDEO RECORDING AND PRODUCTION; ARRANGING, PRODUCING AND CONDUCTING EDUCATIONAL CONFERENCES AND EVENTS; PROVIDING AN ON-LINE ELECTRONIC DATABASE ON GLOBAL COMPUTER NETWORKS IN THE FIELD OF EDUCATION (U.S. CLS. 100, 101 AND 107).

CLASS 42—SCIENTIFIC, COMPUTER AND LEGAL SERVICES

FOR DESIGNING AND HOSTING WEB PAGES FOR OTHERS ON GLOBAL COMPUTER NETWORKS; CONSULTING IN THE FIELD OF INFORMATION TECHNOLOGY AND EDUCATION; COMPUTER CONSULTING SERVICES, NAMELY, CONSULTING IN THE FIELD OF INFORMATION TECHNOLOGY AND EDUCATION; PROVIDING ON-LINE PUBLICATIONS IN THE NATURE OF ARTICLES IN THE FIELD OF EDUCATION (U.S. CLS. 100 AND 101).

SN 76-173,818. ARTICULEARN, INC., AUSTIN, TX. FILED 11-30-2000.

IT'S YOUR CONTENT

CLASS 41—EDUCATION AND ENTERTAINMENT

FOR EDUCATION SERVICES, NAMELY, PROVIDING COURSES OF INSTRUCTION AT THE PRIMARY, SECONDARY, COLLEGE, PROFESSIONAL AND HOME-SCHOOLING LEVELS FOR OTHERS; DISTRIBUTING COURSE MATERIALS IN CONNECTION THEREWITH; DEVELOPMENT, PRODUCTION, AND DISSEMINATION OF EDUCATIONAL MATERIALS IN THE FIELDS OF PRIMARY, SECONDARY, COLLEGE, PROFESSIONAL AND HOME-SCHOOLING COURSEWORK LEVELS FOR OTHERS; A VIRTUAL CAMPUS FOR E-LEARNING, NAMELY PROVIDING EDUCATIONAL INFORMATION AND COURSEWORK BY MEANS OF A GLOBAL COMPUTER NETWORK; AUDIO AND VIDEO RECORDING AND PRODUCTION; ARRANGING, PRODUCING AND CONDUCTING EDUCATIONAL CONFERENCES AND EVENTS; PROVIDING AN ON-LINE ELECTRONIC DATABASE ON GLOBAL COMPUTER NETWORKS IN THE FIELD OF EDUCATION (U.S. CLS. 100, 101 AND 107).

CLASS 42—SCIENTIFIC, COMPUTER AND LEGAL SERVICES

FOR DESIGNING AND HOSTING WEB PAGES FOR OTHERS ON GLOBAL COMPUTER NETWORKS; CONSULTING IN THE FIELD OF INFORMATION TECHNOLOGY AND EDUCATION; COMPUTER CONSULTING SERVICES, NAMELY, CONSULTING IN THE FIELD OF INFORMATION TECHNOLOGY AND EDUCATION; PROVIDING ON-LINE PUBLICATIONS IN THE NATURE OF ARTICLES IN THE FIELD OF EDUCATION (U.S. CLS. 100 AND 101).

SN 76-173,819. ARTICULEARN, INC., AUSTIN, TX. FILED 11-30-2000.

It's
your
content

CLASS 41—EDUCATION AND ENTERTAINMENT

FOR EDUCATION SERVICES, NAMELY, PROVIDING COURSES OF INSTRUCTION AT THE PRIMARY, SECONDARY, COLLEGE, PROFESSIONAL AND HOME-SCHOOLING LEVELS FOR OTHERS; DISTRIBUTING COURSE MATERIALS IN CONNECTION THEREWITH; DEVELOPMENT, PRODUCTION, AND DISSEMINATION OF EDUCATIONAL MATERIALS IN THE FIELDS OF PRIMARY, SECONDARY, COLLEGE, PROFESSIONAL AND HOME-SCHOOLING COURSEWORK LEVELS FOR OTHERS; A VIRTUAL CAMPUS FOR E-LEARNING, NAMELY PROVIDING EDUCATIONAL INFORMATION AND COURSEWORK BY MEANS OF A GLOBAL COMPUTER NETWORK; AUDIO AND VIDEO RECORDING AND PRODUCTION; ARRANGING, PRODUCING AND CONDUCTING EDUCATIONAL CONFERENCES AND EVENTS; PROVIDING AN ON-LINE ELECTRONIC DATABASE ON GLOBAL COMPUTER NETWORKS IN THE FIELD OF EDUCATION (U.S. CLS. 100, 101 AND 107).

CLASS 42—SCIENTIFIC, COMPUTER AND LEGAL SERVICES

FOR DESIGNING AND HOSTING WEB PAGES FOR OTHERS ON GLOBAL COMPUTER NETWORKS; CONSULTING IN THE FIELD OF INFORMATION TECHNOLOGY AND EDUCATION; COMPUTER CONSULTING SERVICES, NAMELY, CONSULTING IN THE FIELD OF INFORMATION TECHNOLOGY AND EDUCATION; PROVIDING ON-LINE PUBLICATIONS IN THE NATURE OF ARTICLES IN THE FIELD OF EDUCATION (U.S. CLS. 100 AND 101).

SN 76-174,387. METRO CONNECTIONS, INC., MINNEAPOLIS, MN. FILED 12-1-2000.

METROCONNECTIONS**CLASS 39—TRANSPORTATION AND STORAGE**

FOR TOUR OPERATOR SERVICES (U.S. CLS. 100 AND 105).
FIRST USE 5-0-1986; IN COMMERCE 5-0-1986.

CLASS 41—EDUCATION AND ENTERTAINMENT

FOR EVENT PLANNING SERVICES FOR BUSINESSES (U.S. CLS. 100, 101 AND 107).
FIRST USE 5-0-1986; IN COMMERCE 5-0-1986.

SN 76-174,391. IDMICRO, INC., TACOMA, WA. FILED 12-1-2000.

VERTICAL ADVANTAGE**CLASS 9—ELECTRICAL AND SCIENTIFIC APPARATUS**

FOR ELECTRONIC SYSTEMS FOR DETERMINING AND STORING VERTICAL SKI INFORMATION FOR INDIVIDUALS FOR LOCAL DISPLAY AND FOR DISPLAY VIA THE INTERNET COMPRISING COMPUTERS, RF TRANSPONDERS, RF INTERROGATORS INCLUDING MOUNTING AND SUPPORT EQUIPMENT, RF NETWORKING COMPONENTS, NAMELY, ANTENNAS, COAXIAL CABLES AND MODEMS, VIDEO DISPLAYS, SOFTWARE FOR STORING AND UPDATING VERTICAL SKI INFORMATION AND PROVIDING REWARDS TO MEMBERS AND PARTS AND COMPONENTS THEREFOR (U.S. CLS. 21, 23, 26, 36 AND 38).

CLASS 35—ADVERTISING AND BUSINESS

FOR DATA PROCESSING SERVICES, NAMELY, DATA COLLECTION AND PROCESSING OF CUMULATIVE SKI INFORMATION FOR LOCAL DISPLAY AND FOR DISPLAY VIA THE INTERNET (U.S. CLS. 100, 101 AND 102).

CLASS 39—TRANSPORTATION AND STORAGE

FOR ELECTRONIC DATA STORAGE OF CUMULATIVE SKI INFORMATION FOR LOCAL DISPLAY AND FOR DISPLAY VIA THE INTERNET (U.S. CLS. 100 AND 105).

SN 76-174,777. SECRETEXPRESS.COM, LLC, TARZANA, CA. FILED 11-29-2000.

SecretExpress.com

NO CLAIM IS MADE TO THE EXCLUSIVE RIGHT TO USE ".COM", APART FROM THE MARK AS SHOWN.

CLASS 28—TOYS AND SPORTING GOODS

FOR STUFFED TOY ANIMALS (U.S. CLS. 22, 23, 38 AND 50).
FIRST USE 10-31-2000; IN COMMERCE 10-31-2000.

CLASS 38—COMMUNICATION

FOR ELECTRONIC MESSAGE SERVICES, NAMELY, PROVIDING INTERNET COMMUNICATIONS BETWEEN SELECT INDIVIDUALS (U.S. CLS. 100, 101 AND 104).
FIRST USE 10-31-2000; IN COMMERCE 10-31-2000.

SN 76-175,938. REACTION MANAGEMENT, INC., GLENDALE, AZ. FILED 12-5-2000.



CLASS 35—ADVERTISING AND BUSINESS

FOR BUSINESS MARKETING CONSULTING SERVICES (U.S. CLS. 100, 101 AND 102).
FIRST USE 10-30-1995; IN COMMERCE 10-30-1995.

SN 76-174,954. CREATIVE SCIENCE SYSTEMS, INC., CAMPBELL, CA. FILED 11-28-2000.

CLASS 41—EDUCATION AND ENTERTAINMENT

FOR PARTY AND SPECIAL EVENTS PLANNING (U.S. CLS. 100, 101 AND 107).
FIRST USE 10-30-1995; IN COMMERCE 10-30-1995.

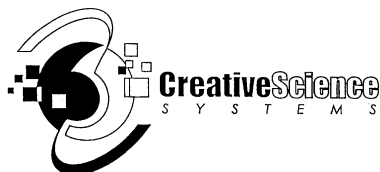

SN 76-178,395. SUGGESTIONATOR.COM, INC., BOCA RATON, FL. FILED 12-8-2000.

SUGGO

CLASS 35—ADVERTISING AND BUSINESS

FOR OPINION POLLING AND INFORMATION GATHERING FOR BUSINESS AND ADVERTISING VIA THE INTERNET (U.S. CLS. 100, 101 AND 102).
FIRST USE 11-22-2000; IN COMMERCE 11-22-2000.

NO CLAIM IS MADE TO THE EXCLUSIVE RIGHT TO USE "SYSTEMS", APART FROM THE MARK AS SHOWN.
THE MARK CONSISTS OF THE WORDING "CREATIVE SCIENCE SYSTEMS" AND A DESIGN COMPRISING SQUARES, RECTANGLES AND CURVED LINES.

CLASS 42—SCIENTIFIC, COMPUTER AND LEGAL SERVICES

FOR OPINION POLLING AND INFORMATION GATHERING FOR POLITICAL, SPECIAL INTEREST, OR INDIVIDUAL PURPOSES VIA THE INTERNET (U.S. CLS. 100 AND 101).
FIRST USE 11-22-2000; IN COMMERCE 11-22-2000.

CLASS 41—EDUCATION AND ENTERTAINMENT

FOR TRAINING IN THE USE AND OPERATION OF PROPRIETARY ENTERPRISE SOFTWARE INFRASTRUCTURE TECHNOLOGY (U.S. CLS. 100, 101 AND 107).

SN 76-178,397. SUGGESTIONATOR.COM, INC., BOCA RATON, FL. FILED 12-8-2000.

CLASS 42—SCIENTIFIC, COMPUTER AND LEGAL SERVICES

FOR DESIGN AND DEVELOPMENT OF COMPUTER SOFTWARE FOR OTHERS; DESIGN, DEVELOPMENT AND DEPLOYMENT OF DISTRIBUTED ENTERPRISE COMPUTER SYSTEMS BASED ON PROPRIETARY MIDDLEWARE AND ENTERPRISE SOFTWARE INFRASTRUCTURE TECHNOLOGY; CONSULTATION FOR OTHERS IN THE FIELD OF ENTERPRISE COMPUTER SYSTEMS ARCHITECTURE, DEVELOPMENT AND INTEGRATION (U.S. CLS. 100 AND 101).

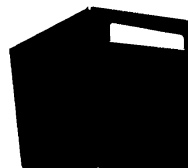

THE MARK CONSISTS OF A STYLIZED SUGGESTION BOX WITH A SLOT AT THE TOP OF THE FRONT PANEL.

CLASS 35—ADVERTISING AND BUSINESS

FOR OPINION POLLING AND INFORMATION GATHERING FOR BUSINESS AND ADVERTISING VIA THE INTERNET (U.S. CLS. 100, 101 AND 102).
FIRST USE 11-22-2000; IN COMMERCE 11-22-2000.

CLASS 42—SCIENTIFIC, COMPUTER AND LEGAL SERVICES

FOR OPINION POLLING AND INFORMATION GATHERING FOR POLITICAL, SPECIAL INTEREST, OR INDIVIDUAL PURPOSES VIA THE INTERNET (U.S. CLS. 100 AND 101).
FIRST USE 11-22-2000; IN COMMERCE 11-22-2000.

SN 76-179,028. VISIONSITE CORPORATION, PORTLAND, OR. FILED 12-11-2000.

**CLASS 35—ADVERTISING AND BUSINESS**

FOR PROMOTING THE GOODS AND SERVICES OF OTHERS BY PREPARING A DIRECTORY AND PREPARING AND PLACING ADVERTISEMENTS THROUGH A GLOBAL COMPUTER NETWORK (U.S. CLS. 100, 101 AND 102).
FIRST USE 12-10-1999; IN COMMERCE 12-10-1999.

CLASS 42—SCIENTIFIC, COMPUTER AND LEGAL SERVICES

FOR HOSTING THE WEB SITES OF OTHERS ON A COMPUTER SERVER FOR A GLOBAL COMPUTER NETWORK; WEB SITE DESIGN FOR OTHERS; COMPUTER CONSULTATION SERVICES FOR GLOBAL COMPUTER NETWORKS (U.S. CLS. 100 AND 101).
FIRST USE 12-10-1999; IN COMMERCE 12-10-1999.

SN 76-179,230. DESIGNPAC INC., NORTH LAKE, IL. FILED 12-12-2000.

CIDER HOUSE**CLASS 4—LUBRICANTS AND FUELS**

FOR CANDLES (U.S. CLS. 1, 6 AND 15).

CLASS 16—PAPER GOODS AND PRINTED MATTER

FOR STATIONERY; ART PRINTS; ART PICTURES; SEASONAL DECORATIONS MADE OF PAPER (U.S. CLS. 2, 5, 22, 23, 29, 37, 38 AND 50).

CLASS 20—FURNITURE AND ARTICLES NOT OTHERWISE CLASSIFIED

FOR BABY FURNITURE MADE OF WOOD; WOOD FURNITURE; DECORATIVE FURNITURE MIRRORS; FIGURINES MADE OF BONE, IVORY, PLASTER, PLASTIC, POLYRESIN AND WOOD; SEASONAL ORNAMENTS, NOT INCLUDING TREE ORNAMENTS, MADE OF BONE, IVORY, PLASTER, PLASTIC, WAX AND WOOD; SEASONAL DECORATIONS MADE BONE, IVORY, PLASTER, PLASTIC, POLYRESIN AND WOOD (U.S. CLS. 2, 13, 22, 25, 32 AND 50).

CLASS 21—HOUSEWARES AND GLASS

FOR CANDLE HOLDERS NOT OF PRECIOUS METAL; CENTERPIECES NOT OF PRECIOUS METAL; TABLETOP ACCESSORIES NAMELY PLATES, SERVING PLATES, CUPS AND SAUCERS, GLASS BEVERAGE WARE AND GLASS BOWLS; PLATES NOT OF PRECIOUS METAL; BAR WARE NOT OF PRECIOUS METAL; FIGURINES MADE OF CHINA, CRYSTAL, EARTHENWARE, GLASS, PORCELAIN, TERRA COTTA OR NOT OF PRECIOUS METAL; VASES; SEASONAL ORNAMENTS, NOT INCLUDING TREE ORNAMENTS, MADE OF CHINA, CRYSTAL, GLASS, PORCELAIN, TERRA COTTA OR NOT OF PRECIOUS METAL; SEASONAL DECORATIONS MADE OF CHINA, CRYSTAL, EARTHENWARE, GLASS, PORCELAIN, AND TERRA COTTA (U.S. CLS. 2, 13, 23, 29, 30, 33, 40 AND 50).

CLASS 24—FABRICS

FOR BABY TOWELS; BABY QUILTS; BUMPER PADS FOR CRIBS AND CRADLES; AND WASH CLOTHS (U.S. CLS. 42 AND 50).

CLASS 27—FLOOR COVERINGS

FOR RUGS (U.S. CLS. 19, 20, 37, 42 AND 50).

CLASS 28—TOYS AND SPORTING GOODS

FOR CHRISTMAS TREE ORNAMENTS AND STUFFED TOY ANIMALS (U.S. CLS. 22, 23, 38 AND 50).

SN 76-181,379. SYMPLASTICS, INC., ST. PETERS, MO. FILED 12-11-2000.

SYMPLASTICS**CLASS 12—VEHICLES**

FOR POLYMER FORMED MUD FLAPS FOR VEHICLE APPLICATION (U.S. CLS. 19, 21, 23, 31, 35 AND 44).
FIRST USE 0-0-1990; IN COMMERCE 0-0-1990.

CLASS 17—RUBBER GOODS

FOR PLASTIC SHEETS AND RODS, FOR VEHICLE APPLICATION (U.S. CLS. 1, 5, 12, 13, 35 AND 50).
FIRST USE 0-0-1990; IN COMMERCE 0-0-1990.

SN 76-181,468. NDC SYSTEMS, LP, VINELAND, NJ. FILED 12-15-2000.

NDC SYSTEMS

NO CLAIM IS MADE TO THE EXCLUSIVE RIGHT TO USE "SYSTEMS", APART FROM THE MARK AS SHOWN.

CLASS 39—TRANSPORTATION AND STORAGE

SN 76-182,543. ITT MANUFACTURING ENTERPRISES, INC., WILMINGTON, DE. FILED 12-18-2000.

FOR WAREHOUSING SERVICES (U.S. CLS. 100 AND 105).
FIRST USE 11-1-2000; IN COMMERCE 11-1-2000.

CLASS 40—MATERIAL TREATMENT

FOR ASSEMBLY OF PRODUCTS FOR OTHERS; CONTRACT MANUFACTURING; CUSTOM MANUFACTURE OF COMPUTER EQUIPMENT (U.S. CLS. 100, 103 AND 106).
FIRST USE 11-1-2000; IN COMMERCE 11-1-2000.

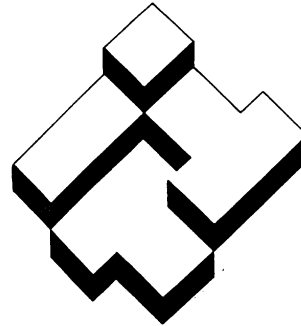

CLASS 9—ELECTRICAL AND SCIENTIFIC APPARATUS

FOR FLOW CONTROL SYSTEMS PRODUCTS, NAMELY, BOILER CONTROLS, LIQUID LEVEL CONTROLS, FLOW SWITCHES (U.S. CLS. 21, 23, 26, 36 AND 38).
FIRST USE 9-0-1998; IN COMMERCE 9-0-1998.

CLASS 11—ENVIRONMENTAL CONTROL APPARATUS

FOR STEAM AND HYDRONIC SYSTEMS PRODUCTS, NAMELY, TRAPS, REGULATORS, VENTS, VALVES, STRAINERS, PUMPS (U.S. CLS. 13, 21, 23, 31 AND 34).
FIRST USE 9-0-1998; IN COMMERCE 9-0-1998.

SN 76-181,617. JUICE BEAUTY, INC., MILL VALLEY, CA. FILED 12-15-2000.

JUICE

CLASS 3—COSMETICS AND CLEANING PREPARATIONS

FOR SKIN AND BODY CARE PRODUCTS, NAMELY CLEANSERS, TONERS, SCRUBS, LOTIONS, CREAMS, BATH GELS, BODYLOTIONS, BODY SPRAYS, BAR SOAPS; COSMETICS, AROMATIC OILS (U.S. CLS. 1, 4, 6, 50, 51 AND 52).

CLASS 4—LUBRICANTS AND FUELS

FOR CANDLES (U.S. CLS. 1, 6 AND 15).

CLASS 9—ELECTRICAL AND SCIENTIFIC APPARATUS

FOR COMPACT DISCS FEATURING MUSIC (U.S. CLS. 21, 23, 26, 36 AND 38).

CLASS 16—PAPER GOODS AND PRINTED MATTER

FOR PRINTED INSTRUCTIONAL MATERIALS IN THE FIELD OF HEALTH, BEAUTY, AND WELL-BEING (U.S. CLS. 2, 5, 22, 23, 29, 37, 38 AND 50).

CLASS 30—STAPLE FOODS

FOR TEA BAGS AND DRIED TEA LEAVES SOLD IN BULK (U.S. CL. 46).

SN 76-182,864. CNF TRANSPORTATION INC., PALO ALTO, CA. FILED 12-13-2000.

VECTOR SCM

NO CLAIM IS MADE TO THE EXCLUSIVE RIGHT TO USE "SCM", APART FROM THE MARK AS SHOWN.

CLASS 9—ELECTRICAL AND SCIENTIFIC APPARATUS

FOR INFORMATION MANAGEMENT SYSTEMS, NAMELY, COMPUTER SOFTWARE FOR SHIPMENT PROCESSING, PREPARING SHIPPING DOCUMENTS AND INVOICES, AND TRACKING DOCUMENTS, PACKAGES AND FREIGHT OVER COMPUTER NETWORKS, INTRANETS, AND THE INTERNET (U.S. CLS. 21, 23, 26, 36 AND 38).

CLASS 35—ADVERTISING AND BUSINESS

FOR SUPPLY CHAIN, LOGISTICS, AND REVERSE LOGISTICS SERVICES, NAMELY, COMPUTERIZED TRACKING OF DOCUMENTS, PACKAGES, > RAW MATERIALS, AND OTHER FREIGHT FOR OTHERS; WAREHOUSING SERVICES, NAMELY, KITTING, SUB-ASSEMBLY, RETURNS PROCESSING, AND LABELING OF DOCUMENTS, PACKAGES, RAW MATERIALS, AND OTHER FREIGHT FOR OTHERS; INFORMATION MANAGEMENT SERVICES, NAMELY, SHIPMENT PROCESSING, PREPARING SHIPPING DOCUMENTS AND INVOICES, TRACKING DOCUMENTS, PACKAGES, AND FREIGHT, OVER COMPUTER NETWORKS, INTRANETS, AND THE INTERNET; BUSINESS MANAGEMENT SERVICES, NAMELY MANAGING LOGISTICS, REVERSE LOGISTICS, SUPPLY CHAIN SERVICES, SUPPLY CHAIN VISIBILITY AND SYNCHRONIZATION, SUPPLY AND DEMAND FORECASTING AND PRODUCT DISTRIBUTION PROCESSES FOR OTHERS; AND BUSINESS CONSULTING SERVICES RELATING TO PRODUCT DISTRIBUTION, OPERATIONS MANAGEMENT SERVICES, LOGISTICS, REVERSE LOGISTICS, SUPPLY CHAIN, AND PRODUCTION SYSTEMS AND DISTRIBUTION SOLUTIONS (U.S. CLS. 100, 101 AND 102).

CLASS 36—INSURANCE AND FINANCIAL

FOR CUSTOMS BROKERAGE SERVICES FOR OTHERS (U.S. CLS. 100, 101 AND 102).

CLASS 39—TRANSPORTATION AND STORAGE

FOR SUPPLY CHAIN, LOGISTICS, AND REVERSE LOGISTICS SERVICES, NAMELY, PICK-UP, STORAGE, TRANSPORTATION, AND DELIVERY OF DOCUMENTS, PACKAGES, RAW MATERIALS, AND OTHER FREIGHT FOR OTHERS BY AIR, RAIL, SHIP OR TRUCK; WAREHOUSING SERVICES, NAMELY, STORAGE, DISTRIBUTION, PICK-UP, AND PACKING FOR SHIPMENT OF DOCUMENTS, PACKAGES, RAW MATERIALS, AND OTHER FREIGHT FOR OTHERS; FREIGHT FORWARDING SERVICES; AND TRANSPORTATION OF THE GOODS OF OTHERS BY AIR, RAIL, SHIP OR TRUCK (U.S. CLS. 100 AND 105).

SN 76-188,560. SNITCH, LLC, ST. MATTHEWS, KY. BY CHANGE OF NAME CRIME ZINE, INC., LOUISVILLE, KY. FILED 12-29-2000.

SNITCH

CLASS 16—PAPER GOODS AND PRINTED MATTER

FOR PRINTED GOODS, NAMELY, MAGAZINES IN THE FIELD OF CRIME AND CRIME RELATED ISSUES (U.S. CLS. 2, 5, 22, 23, 29, 37, 38 AND 50).

CLASS 42—SCIENTIFIC, COMPUTER AND LEGAL SERVICES

FOR PROVIDING A WEBSITE IN THE FIELD OF CRIME AND CRIME RELATED ISSUES (U.S. CLS. 100 AND 101).

SN 76-191,821. SMITH, GENE A., DBA SMITTIE'S SOFT PRETZELS AND MORE, DOVER, PA. FILED 1-9-2001.

EPEX

CLASS 30—STAPLE FOODS

FOR SOFT PRETZELS (U.S. CL. 46).

CLASS 35—ADVERTISING AND BUSINESS

FOR RETAIL OUTLETS FOR SOFT PRETZELS CONSUMED ON OR OFF THE PREMISES; WHOLESALE DISTRIBUTORSHIP OF SOFT PRETZELS TO OTHERS (U.S. CLS. 100, 101 AND 102).

SN 76-192,571. COMMUNITY ANTI-DRUG COALITIONS OF AMERICA, ALEXANDRIA, VA. FILED 1-11-2001.



SEC. 2(F) AS TO "COMMUNITY ANTI-DRUG COALITIONS OF AMERICA".

CLASS 16—PAPER GOODS AND PRINTED MATTER

FOR PRINTED NEWSLETTERS, MAGAZINES, JOURNALS, BROCHURES, AND FLYERS IN THE FIELD OF SUBSTANCE ABUSE RESEARCH, PREVENTION, AND TREATMENT (U.S. CLS. 2, 5, 22, 23, 29, 37, 38 AND 50). FIRST USE 6-0-1992; IN COMMERCE 6-0-1992.

CLASS 36—INSURANCE AND FINANCIAL

FOR CHARITABLE FUNDRAISING (U.S. CLS. 100, 101 AND 102). FIRST USE 6-0-1992; IN COMMERCE 6-0-1992.

CLASS 41—EDUCATION AND ENTERTAINMENT

FOR EDUCATIONAL SERVICES, NAMELY, CONDUCTING CLASSES, SEMINARS, WORKSHOPS, AND CONFERENCES IN THE FIELD OF SUBSTANCE ABUSE RESEARCH, PREVENTION, AND TREATMENT (U.S. CLS. 100, 101 AND 107). FIRST USE 6-0-1992; IN COMMERCE 6-0-1992.

CLASS 42—SCIENTIFIC, COMPUTER AND LEGAL SERVICES

FOR PROMOTING PUBLIC AWARENESS OF THE NEED FOR CREATING AND STRENGTHENING COMMUNITY COALITIONS TO PREVENT, REDUCE, AND TREAT SUBSTANCE ABUSE AND VIOLENCE; PROVIDING INFORMATION IN THE FIELD OF SUBSTANCE ABUSE PREVENTION AND TREATMENT; AND COMPUTER SERVICES, NAMELY, PROVIDING ON-LINE NEWSLETTERS, MAGAZINES AND JOURNALS IN THE FIELD OF SUBSTANCE ABUSE RESEARCH, PREVENTION AND TREATMENT (U.S. CLS. 100 AND 101). FIRST USE 6-0-1992; IN COMMERCE 6-0-1992.

SN 76-193,911. HUDSON, TOM, VANCOUVER, WA. FILED 1-11-2001.

SN 76-196,612. WESTMINSTER COLLEGE, SALT LAKE CITY, UT. FILED 1-19-2001.

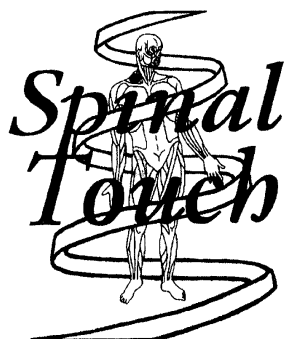

NO CLAIM IS MADE TO THE EXCLUSIVE RIGHT TO USE "SPINAL TOUCH", APART FROM THE MARK AS SHOWN.

THE LINING IS A FEATURE OF THE MARK AND DOES NOT INDICATE COLOR.

THE MARK CONSISTS, IN PART, OF A STYLIZED DEPICTION OF A HUMAN FORM WITH A RIBBON DESIGN ENCIRCLING THE HUMAN FORM.

CLASS 41—EDUCATION AND ENTERTAINMENT

FOR EDUCATIONAL SERVICES, NAMELY, CONDUCTING CLASSES, SEMINARS AND WORKSHOPS IN THE FIELD OF THERAPEUTIC MASSAGE AND CORRECTIVE BODY WORK (U.S. CLS. 100, 101 AND 107).
FIRST USE 1-15-1994; IN COMMERCE 1-15-1994.

CLASS 42—SCIENTIFIC, COMPUTER AND LEGAL SERVICES

FOR HEALTH CARE SERVICES, NAMELY, THE PERFORMANCE OF SPINAL TOUCH THERAPY FOR THE THERAPEUTIC CORRECTION OF SPINAL DEVIATION AND THE RESOLUTION OF CORRESPONDING ASSOCIATED PHYSICAL COMPLAINTS (U.S. CLS. 100 AND 101).
FIRST USE 7-21-1991; IN COMMERCE 2-7-1992.

SN 76-195,005. BRIGGS & STRATTON CORPORATION, MILWAUKEE, WI. FILED 1-17-2001.



CLASS 7—MACHINERY

FOR ELECTRIC MOTORS FOR MACHINES, CONTROLLERS AND STRUCTURAL PARTS THEREFOR (U.S. CLS. 13, 19, 21, 23, 31, 34 AND 35).

CLASS 12—VEHICLES

FOR ELECTRIC MOTORS FOR LAND VEHICLES, CONTROLLERS AND STRUCTURAL PARTS THEREFOR (U.S. CLS. 19, 21, 23, 31, 35 AND 44).



NO CLAIM IS MADE TO THE EXCLUSIVE RIGHT TO USE "COLLEGE", APART FROM THE MARK AS SHOWN.

CLASS 16—PAPER GOODS AND PRINTED MATTER

FOR PRINTED MATTER, NAMELY, POSTERS, STICKERS, DECALS, PROGRAMS FOR COLLEGIATE ATHLETIC COMPETITIONS AND CULTURAL ACTIVITIES, POSTCARDS, STATIONERY, AND SCHOOL SUPPLIES, NAMELY, FOLDERS, NOTEBOOKS, RING BINDERS, PENCILS, PENS, AND COMPOSITION BOOKS (U.S. CLS. 2, 5, 22, 23, 29, 37, 38 AND 50).
FIRST USE 6-1-1996; IN COMMERCE 6-1-1996.

CLASS 25—CLOTHING

FOR WEARING APPAREL NAMELY, T-SHIRTS, SHIRTS, SHORTS, PANTS, JACKETS, SWEATSHIRTS, HATS, CAPS, SWEATERS AND FOOTWEAR (U.S. CLS. 22 AND 39).
FIRST USE 6-1-1996; IN COMMERCE 6-1-1996.

CLASS 41—EDUCATION AND ENTERTAINMENT

FOR EDUCATIONAL AND ENTERTAINMENT SERVICES NAMELY, CONDUCTING EDUCATIONAL ACTIVITIES SUCH AS COURSES, SEMINARS, TRAINING PROGRAMS AND CONFERENCES AT THE POST-SECONDARY, UNDERGRADUATE AND GRADUATE LEVEL AND CONDUCTING AND SPONSORING COLLEGIATE ATHLETIC COMPETITIONS AND CULTURAL ACTIVITIES (U.S. CLS. 100, 101 AND 107).
FIRST USE 6-1-1996; IN COMMERCE 6-1-1996.

SN 76-197,550. EMCOR GROUP, INC., NORWALK, CT. FILED 1-19-2001.

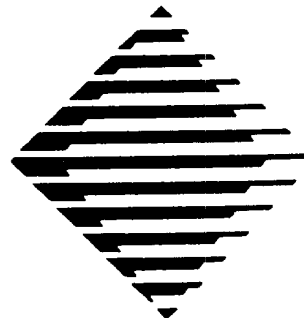

CLASS 35—ADVERTISING AND BUSINESS

FOR FACILITIES MANAGEMENT SERVICES (U.S. CLS. 100, 101 AND 102).
FIRST USE 1-19-2001; IN COMMERCE 1-29-2001.

CLASS 37—CONSTRUCTION AND REPAIR

FOR MANAGING, CONTRACTING AND PROVIDING ELECTRICAL AND MECHANICAL CONSTRUCTION SERVICES; MAINTENANCE SERVICES TO PRIVATE, PUBLIC AND COMMERCIAL BUILDINGS (U.S. CLS. 100, 103 AND 106).

FIRST USE 1-19-2001; IN COMMERCE 1-29-2001.

SN 76-199,931. SOPRIS WEST EDUCATIONAL SERVICES INC., LONGMONT, CO. FILED 1-25-2001.

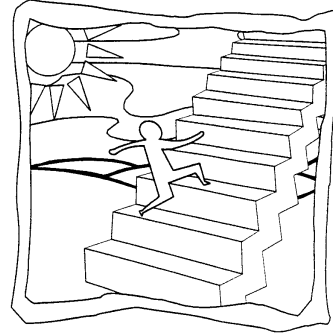

SN 76-198,384. FREQUENCY MARKETING, INC., MILFORD, OH. FILED 1-23-2001.

COLLOQUY

OWNER OF U.S. REG. NOS. 1,662,963 AND 2,205,390.

CLASS 35—ADVERTISING AND BUSINESS

FOR BUSINESS MARKETING AND CONSULTING SERVICES; BUSINESS CONSULTATION SERVICES; AND BUSINESS RESEARCH SERVICES (U.S. CLS. 100, 101 AND 102).

CLASS 16—PAPER GOODS AND PRINTED MATTER

FOR BOOKS ON LITERACY TRAINING AND WRITING INSTRUCTION; PRINTED TRAINING MANUALS IN THE FIELD OF LITERACY TRAINING AND WRITING INSTRUCTION (U.S. CLS. 2, 5, 22, 23, 29, 37, 38 AND 50).

FIRST USE 8-0-1999; IN COMMERCE 8-0-1999.

CLASS 41—EDUCATION AND ENTERTAINMENT

FOR EDUCATIONAL SERVICES, NAMELY CONDUCTING SEMINARS, LECTURES AND CLASSES IN THE FIELD OF BUSINESS MARKETING AND BUSINESS RESEARCH (U.S. CLS. 100, 101 AND 107).

CLASS 41—EDUCATION AND ENTERTAINMENT

FOR EDUCATIONAL SEMINARS, NAMELY TEACHER TRAINING IN THE FIELD OF WRITING INSTRUCTION (U.S. CLS. 100, 101 AND 107).

FIRST USE 8-0-1999; IN COMMERCE 8-0-1999.

SN 76-199,272. SMITH, CHARLIE, CENTRAL, HONG KONG, FILED 1-26-2001.

SN 76-200,812. LOGISYNC CORPORATION, WESTLAKE, OH. FILED 1-26-2001.

CHARLIE SMITH VINEYARD

NO CLAIM IS MADE TO THE EXCLUSIVE RIGHT TO USE "VINEYARD", APART FROM THE MARK AS SHOWN.

CLASS 31—NATURAL AGRICULTURAL PRODUCTS

FOR FRESH GRAPES (U.S. CLS. 1 AND 46).

CLASS 33—WINES AND SPIRITS

FOR WINES (U.S. CLS. 47 AND 49).

LOGISYNC

CLASS 9—ELECTRICAL AND SCIENTIFIC APPARATUS

FOR COMPUTER SOFTWARE AND COMPUTER NETWORKING HARDWARE FOR NETWORKING EMBEDDED CONTROLLERS (U.S. CLS. 21, 23, 26, 36 AND 38).

FIRST USE 7-0-1996; IN COMMERCE 7-0-1996.

CLASS 42—SCIENTIFIC, COMPUTER AND LEGAL SERVICES

FOR DESIGN FOR OTHERS IN THE FIELD OF CONTROL SYSTEM COMPUTER HARDWARE AND COMPUTER SOFTWARE (U.S. CLS. 100 AND 101).

FIRST USE 2-0-1996; IN COMMERCE 2-0-1996.

SN 76-202,260. MIRBEAU HOLDINGS LLC, SKANEATELES, NY. FILED 1-30-2001.

SN 76-206,043. BIOMET, INC., WARSAW, IN. FILED 2-2-2001.



CLASS 24—FABRICS

FOR COMFORTERS, DUVETS, BED SHEETS, AND TOWELS (U.S. CLS. 42 AND 50).
FIRST USE 6-1-2000; IN COMMERCE 6-1-2000.

CLASS 25—CLOTHING

FOR MEN'S AND WOMEN'S BATHROBES, SWEATERS, POLO SHIRTS, HATS, SWEAT SUITS, JACKETS, WIND RESISTANT JACKETS, PULLOVERS, AND COATS (U.S. CLS. 22 AND 39).
FIRST USE 6-1-2000; IN COMMERCE 6-1-2000.

SN 76-203,569. CENTRAL OHIO ENERGY, INC., MANSFIELD, OH. FILED 2-2-2001.

EASY TRIP

CLASS 35—ADVERTISING AND BUSINESS

FOR CONVENIENCE STORE SERVICES RENDERED AT GASOLINE STATIONS AND TRUCK STOPS (U.S. CLS. 100, 101 AND 102).

CLASS 42—SCIENTIFIC, COMPUTER AND LEGAL SERVICES

FOR RESTAURANT SERVICES LOCATED AT GASOLINE STATIONS AND TRUCK STOPS (U.S. CLS. 100 AND 101).

SN 76-205,569. RCN TELECOM SERVICES, INC., PRINCETON, NJ. FILED 2-1-2001.

RCN STADIUM

OWNER OF U.S. REG. NOS. 2,360,973, 2,389,379 AND 2,403,440.
NO CLAIM IS MADE TO THE EXCLUSIVE RIGHT TO USE "STADIUM", APART FROM THE MARK AS SHOWN.

CLASS 35—ADVERTISING AND BUSINESS

FOR PROVIDING FACILITIES FOR BUSINESS MEETINGS AND CONFERENCES (U.S. CLS. 100, 101 AND 102).

CLASS 42—SCIENTIFIC, COMPUTER AND LEGAL SERVICES

FOR STADIUM SERVICES, NAMELY, PROVIDING FACILITIES FOR SPORTS, CONCERTS, THEATRICAL PERFORMANCES, CONVENTIONS AND EXHIBITIONS; RESTAURANT, SNACK BAR, AND BAR SERVICES; PROVIDING BANQUET AND SOCIAL FUNCTION FACILITIES FOR SPECIAL OCCASIONS (U.S. CLS. 100 AND 101).

MACROBOND

CLASS 1—CHEMICALS

FOR CHEMICAL COATING FOR USE IN THE MANUFACTURE OF ORTHOPEDIC DEVICES (U.S. CLS. 1, 5, 6, 10, 26 AND 46).

CLASS 10—MEDICAL APPARATUS

FOR SURFACE COATING USED AS AN INTEGRAL COMPONENT OF ORTHOPEDIC DEVICES (U.S. CLS. 26, 39 AND 44).

SN 76-206,044. UNVEIL TECHNOLOGIES, INC., WALTHAM, MA. FILED 2-7-2001.

WE JUST KNOW WHERE TO LOOK

CLASS 9—ELECTRICAL AND SCIENTIFIC APPARATUS

FOR COMPUTER SEARCH ENGINE SOFTWARE USING ADVANCED NATURAL LANGUAGE PROCESSING ALGORITHMS TO GLEAN CONCEPTS FROM TEXT AND ENABLE CONCEPT-BASED SEARCHING (U.S. CLS. 21, 23, 26, 36 AND 38).

CLASS 42—SCIENTIFIC, COMPUTER AND LEGAL SERVICES

FOR SERVICES, NAMELY, DEVELOPING AND PROGRAMMING CUSTOMIZED COMPUTER SOFTWARE FOR NATURAL LANGUAGE PROCESSING FOR OTHERS; AND SERVICES, NAMELY, PROVIDING SEARCH ENGINES FOR OTHERS WHICH ENABLE CONCEPT-BASED SEARCHES FOR AND RETRIEVALS OF INFORMATION ON THE INTERNET AND OTHER COMPUTER NETWORKS (U.S. CLS. 100 AND 101).

SN 76-210,574. ROCKY MOUNTAIN HARDWARE INC., HAILEY, ID. FILED 2-14-2001.

ROCKY MOUNTAIN HARDWARE

OWNER OF U.S. REG. NO. 2,287,343.
NO CLAIM IS MADE TO THE EXCLUSIVE RIGHT TO USE "HARDWARE", APART FROM THE MARK AS SHOWN.
SEC. 2(F).

CLASS 6—METAL GOODS

FOR METAL ARCHITECTURAL AND FURNITURE HARDWARE, NAMELY, DOOR HANDLES, LEVERS AND KNOBS; ESCUTCHEONS, CLOTHES HOOKS, CABINET PULLS, DOOR KNOCKERS, STOPS AND BOLTS; LOCK AND DEADBOLT SETS (U.S. CLS. 2, 12, 13, 14, 23, 25 AND 50).
FIRST USE 1-1-2000; IN COMMERCE 1-1-2000.

CLASS 21—HOUSEWARES AND GLASS

FOR TOWEL BARS, TOWEL RINGS, AND TOILET PAPER HOLDER (U.S. CLS. 2, 13, 23, 29, 30, 33, 40 AND 50).

FIRST USE 1-1-2000; IN COMMERCE 1-1-2000.

SN 76-211,053. ROCHESTER RESOURCE ALLIANCE, INC., ROCHESTER, NY. FILED 2-15-2001.

ROCHESTERWORKS!**CLASS 35—ADVERTISING AND BUSINESS**

FOR JOB PLACEMENT; PERSONNEL PLACEMENT AND RECRUITMENT (U.S. CLS. 100, 101 AND 102).

FIRST USE 4-4-2001; IN COMMERCE 4-4-2001.

CLASS 41—EDUCATION AND ENTERTAINMENT

FOR JOB TRAINING SERVICES FOR EMPLOYERS NAMELY DEVELOPING AND PRESENTING CUSTOMIZED TRAINING PROGRAMS FOR EMPLOYERS; JOB TRAINING SERVICES FOR INDIVIDUALS INCLUDING ON THE JOB TRAINING, OCCUPATIONAL SKILL TRAINING, TRAINING FOR UPGRADING SKILLS, ADULT EDUCATION, SKILL ASSESSMENT AND TESTING AND LITERACY TRAINING (U.S. CLS. 100, 101 AND 107).

FIRST USE 4-4-2001; IN COMMERCE 4-4-2001.

SN 76-211,456. KOLPEK, DOUGLAS B., DBA SIDELINE SOFTWARE, ANKENY, IA. FILED 2-16-2001.

SIDELINE SOFTWARE**CLASS 9—ELECTRICAL AND SCIENTIFIC APPARATUS**

FOR COMPUTER SOFTWARE FOR CONDUCTING AND MANAGING SPORTS TOURNAMENT POOLS (U.S. CLS. 21, 23, 26, 36 AND 38).

FIRST USE 3-10-1994; IN COMMERCE 3-10-1994.

CLASS 42—SCIENTIFIC, COMPUTER AND LEGAL SERVICES

FOR COMPUTER CONSULTING SERVICES FOR OTHERS (U.S. CLS. 100 AND 101).

FIRST USE 1-15-1994; IN COMMERCE 1-15-1994.

SN 76-212,013. MOVITEX, 59290 WASQUEHAL, FRANCE, FILED 2-20-2001.

CELAIA

OWNER OF ERPN CMNTY TM OFC REG. NO. 846.527, DATED 11-12-1999, EXPIRES 11-12-2009.

CLASS 16—PAPER GOODS AND PRINTED MATTER

FOR PAPER GOODS AND PRINTED MATTER, NAMELY, MAIL ORDER CATALOGS (U.S. CLS. 2, 5, 22, 23, 29, 37, 38 AND 50).

CLASS 25—CLOTHING

FOR CLOTHING, NAMELY, BOOTS, SHOES, SLIPPERS; HATS (U.S. CLS. 22 AND 39).

SN 76-216,760. MANAGEDSTORAGE INTERNATIONAL, INC., WESTMINSTER, CO. FILED 2-27-2001.

GRIDZONE**CLASS 9—ELECTRICAL AND SCIENTIFIC APPARATUS**

FOR COMPUTER SOFTWARE FOR USE IN DATABASE SECURITY MANAGEMENT (U.S. CLS. 21, 23, 26, 36 AND 38).

CLASS 39—TRANSPORTATION AND STORAGE

FOR SECURE ELECTRONIC DATA STORAGE SERVICES (U.S. CLS. 100 AND 105).

SN 76-216,768. TRANSPORT GRAPHICS, INC., MERRILLVILLE, IN. FILED 2-27-2001.

A TOTAL GRAPHIC INNOVATOR

NO CLAIM IS MADE TO THE EXCLUSIVE RIGHT TO USE "TOTAL GRAPHIC", APART FROM THE MARK AS SHOWN.

CLASS 40—MATERIAL TREATMENT

FOR CUSTOM MANUFACTURE OF SIGNAGE SYSTEMS AND DISPLAYS; ELECTRONIC IMAGING OF SIGNS, BANNERS, PHOTOGRAPHS, AND ARTWORK (U.S. CLS. 100, 103 AND 106).

CLASS 42—SCIENTIFIC, COMPUTER AND LEGAL SERVICES

FOR DESIGN FOR OTHERS IN THE FIELD OF SIGNAGE SYSTEMS AND DISPLAYS (U.S. CLS. 100 AND 101).

SN 76-216,906. TANAGRAPHICS, INC., NEW YORK, NY. FILED 2-27-2001.

TANA IA**CLASS 40—MATERIAL TREATMENT**

FOR ELECTRONIC IMAGING, SCANNING, DIGITIZING, ALTERATION AND RETOUCHING OF ARTWORK, PAINTINGS, PHOTOGRAPHS, TEXT AND GRAPHICS, BOOK BINDING SERVICES; DIGITAL IMAGING SERVICES FOR ARCHIVAL PURPOSES; DOCUMENT DATA TRANSFER AND PHYSICAL CONVERSION FROM ONE MEDIA TO ANOTHER (U.S. CLS. 100, 103 AND 106).

CLASS 42—SCIENTIFIC, COMPUTER AND LEGAL SERVICES

FOR CONSULTING SERVICES IN THE FIELD OF PRINTING, ELECTRONIC DIGITAL IMAGING AND DESKTOP FILE CREATION; PRINTING; GRAPHIC ART DESIGN FEATURING DESIGNING AND CREATING ARTWORK AND PRODUCT PACKAGING FOR BUSINESSES, INDIVIDUALS AND ORGANIZATIONS FOR ADVERTISING AND PROMOTIONAL PIECES, CATALOGS, BOOKS, ANNUAL REPORTS AND FINANCIAL STATEMENTS; DISTANCE PRINTING, NAMELY, PRINTING FOR OTHERS VIA A GLOBAL COMPUTER NETWORK; COMPUTER SERVICES, NAMELY, DESIGNING AND IMPLEMENTING WEB SITES FOR OTHERS; DESKTOP PUBLISHING FOR OTHERS; COMPUTER SERVICES, NAMELY, PROVIDING TEXT AND GRAPHIC PUBLICATIONS OF OTHERS VIA A GLOBAL COMMUNICATIONS NETWORK (U.S. CLS. 100 AND 101).

SN 76-217,761. NATIONAL ACADEMY OF RECORDING ARTS & SCIENCES, INC., SANTA MONICA, CA. FILED 3-1-2001.

INTERNATIONAL ACADEMY OF RECORDING ARTS & SCIENCES

OWNER OF U.S. REG. NOS. 1,139,523 AND 1,147,379.

CLASS 41—EDUCATION AND ENTERTAINMENT

FOR ENTERTAINMENT SERVICES, NAMELY, PROVIDING RECOGNITION AND INCENTIVES BY THE WAY OF AWARDS TO DEMONSTRATE EXCELLENCE IN THE FIELD OF RECORDING ARTS AND SCIENCES (U.S. CLS. 100, 101 AND 107).

CLASS 42—SCIENTIFIC, COMPUTER AND LEGAL SERVICES

FOR ASSOCIATION SERVICES, NAMELY, PROMOTING THE INTERESTS, PROGRESS AND ACHIEVEMENT OF RECORDING ARTISTS (U.S. CLS. 100 AND 101).

SN 76-219,488. FERNCO, INC., DAVISON, MI. FILED 3-2-2001.

FERNCO

OWNER OF U.S. REG. NO. 1,173,086.

CLASS 6—METAL GOODS

FOR METAL CLAMPS FOR USE IN PLUMBING, SEWER AND VENTING APPLICATIONS AND METAL FLANGES FOR SECURING TOILETS (U.S. CLS. 2, 12, 13, 14, 23, 25 AND 50).
FIRST USE 3-1-1979; IN COMMERCE 3-1-1979.

CLASS 11—ENVIRONMENTAL CONTROL APPARATUS

FOR SEWER SADDLES AND FLEXIBLE DRAIN AND TRAP CONNECTORS (U.S. CLS. 13, 21, 23, 31 AND 34).
FIRST USE 3-1-1979; IN COMMERCE 3-1-1979.

CLASS 17—RUBBER GOODS

FOR COMPRESSION JOINT SEALANTS; NON-METAL PIPE COUPLINGS, EXPANSION JOINTS, PIPE CAPS, PIPE PLUGS AND ECCENTRIC COUPLINGS (U.S. CLS. 1, 5, 12, 13, 35 AND 50).
FIRST USE 3-1-1979; IN COMMERCE 3-1-1979.

SN 76-220,585. VALLEY RACE PARK INC., HARLINGEN, TX. FILED 3-6-2001.



NO CLAIM IS MADE TO THE EXCLUSIVE RIGHT TO USE "RACE PARK", APART FROM THE MARK AS SHOWN.

CLASS 36—INSURANCE AND FINANCIAL

FOR BETTING SERVICES (U.S. CLS. 100, 101 AND 102).
FIRST USE 3-0-2000; IN COMMERCE 3-0-2000.

CLASS 41—EDUCATION AND ENTERTAINMENT

FOR ENTERTAINMENT, NAMELY, CONDUCTING DOG RACES (U.S. CLS. 100, 101 AND 107).
FIRST USE 3-0-2000; IN COMMERCE 3-0-2000.

SN 76-221,063. TEMENOS HOLDINGS NV, WILLEMSTAD, CURACAO, NETHERLD ANTILLES, BY ASSIGNMENT JBASE SOFTWARE, INC., FRAMINGHAM, MA. FILED 3-7-2001.

JBASE

CLASS 9—ELECTRICAL AND SCIENTIFIC APPARATUS

FOR COMPUTER SOFTWARE FOR USE IN INTEGRATING DATA INTO DATABASE APPLICATIONS USED IN THE FIELD OF CLIENT/SERVER APPLICATION ENVIRONMENTS; COMPUTER SOFTWARE FOR DATABASE MANAGEMENT; COMPUTER SOFTWARE FOR USE IN CREATING WEB APPLICATIONS; COMPUTER SOFTWARE DEVELOPMENT TOOLS FOR CREATING CLIENT/SERVER APPLICATIONS (U.S. CLS. 21, 23, 26, 36 AND 38).
FIRST USE 10-28-1991; IN COMMERCE 4-6-1993.

CLASS 41—EDUCATION AND ENTERTAINMENT

FOR EDUCATIONAL SERVICES, NAMELY, TRAINING IN THE USE AND OPERATION OF COMPUTER SOFTWARE (U.S. CLS. 100, 101 AND 107).
FIRST USE 10-28-1991; IN COMMERCE 4-6-1993.

CLASS 42—SCIENTIFIC, COMPUTER AND LEGAL SERVICES

FOR COMPUTER SOFTWARE CONSULTATION SERVICES FOR OTHERS (U.S. CLS. 100 AND 101).
FIRST USE 10-28-1991; IN COMMERCE 4-6-1993.

SN 76-221,836. SCIMAGIX, INC., REDWOOD SHORES, CA.
FILED 3-8-2001.

SIMS

CLASS 9—ELECTRICAL AND SCIENTIFIC APPARATUS

FOR COMPUTER SOFTWARE, NAMELY ENTERPRISE SOFTWARE FOR SEARCHING, VIEWING AND STORING OF IMAGES FOR SCIENTIFIC APPLICATIONS (U.S. CLS. 21, 23, 26, 36 AND 38).

CLASS 42—SCIENTIFIC, COMPUTER AND LEGAL SERVICES

FOR PROVIDING ONLINE DATABASES OF IMAGES IN THE FIELD OF BIOLOGY AND CONSULTING SERVICES FOR OTHERS IN THE FIELD OF CUSTOMIZATION AND DESIGN OF COMPUTER SOFTWARE (U.S. CLS. 100 AND 101).

SN 76-222,826. INCUBIC, LLC, MOUNTAIN VIEW, CA.
FILED 3-8-2001.

INCUBIC

CLASS 35—ADVERTISING AND BUSINESS

FOR BUSINESS MANAGEMENT SERVICES FOR OTHERS, NAMELY CONSULTATION IN THE FIELDS OF BUSINESS DEVELOPMENT, BUSINESS MANAGEMENT, AND BUSINESS TRANSACTIONS (U.S. CLS. 100, 101 AND 102).

CLASS 36—INSURANCE AND FINANCIAL

FOR VENTURE CAPITAL SERVICES, NAMELY INVESTMENT OF VENTURE CAPITAL, MANAGEMENT OF VENTURE CAPITAL FUNDS, AND VENTURE CAPITAL INVESTMENT CONSULTATION; FINANCIAL ANALYSIS AND CONSULTATION (U.S. CLS. 100, 101 AND 102).

CLASS 42—SCIENTIFIC, COMPUTER AND LEGAL SERVICES

FOR TECHNICAL CONSULTATION AND RESEARCH IN THE FIELDS OF COMMUNICATIONS, NETWORKING, OPTICS, COMPUTERS, MEDICAL DEVICES AND BIOTECHNOLOGY (U.S. CLS. 100 AND 101).

SN 76-231,403. OPTIMUM LOGISTICS LTD., HAMILTON
HM CX, BERMUDA, FILED 3-23-2001.

TRANSDOC

CLASS 9—ELECTRICAL AND SCIENTIFIC APPARATUS

FOR COMPUTER OPERATING SOFTWARE FOR USE IN OFFERING ELECTRONIC ORIGINATION, GENERATION AND SECURE TRANSMISSION OF SHIPPING DOCUMENTS (U.S. CLS. 21, 23, 26, 36 AND 38).

CLASS 42—SCIENTIFIC, COMPUTER AND LEGAL SERVICES

FOR PROVIDING TEMPORARY USE OF NON-DOWNLOADABLE OPERATING SOFTWARE FOR USE IN OFFERING ELECTRONIC ORIGINATION, GENERATION AND SECURE TRANSMISSION OF SHIPPING DOCUMENTS (U.S. CLS. 100 AND 101).

SN 76-231,404. OPTIMUM LOGISTICS LTD., HAMILTON
HM CX, BERMUDA, FILED 3-23-2001.

TRANSTALK

CLASS 9—ELECTRICAL AND SCIENTIFIC APPARATUS

FOR COMPUTER OPERATING SOFTWARE FOR USE IN INTEGRATED LOGISTICS SERVICES, TO AID IN CREATING AND MANAGING SHIPMENTS THROUGH ALL PHASES OF THE SUPPLY CHAIN (U.S. CLS. 21, 23, 26, 36 AND 38).

CLASS 42—SCIENTIFIC, COMPUTER AND LEGAL SERVICES

FOR PROVIDING TEMPORARY USE OF NON-DOWNLOADABLE OPERATING SOFTWARE FOR USE IN INTEGRATED LOGISTICS SERVICES, TO AID IN CREATING AND MANAGING SHIPMENTS THROUGH ALL PHASES OF THE SUPPLY CHAIN (U.S. CLS. 100 AND 101).

SN 76-231,406. OPTIMUM LOGISTICS LTD., HAMILTON
HM CX, BERMUDA, FILED 3-23-2001.

TRANSSURVEYOR

CLASS 9—ELECTRICAL AND SCIENTIFIC APPARATUS

FOR COMPUTER OPERATING SOFTWARE FOR USE IN INTEGRATED LOGISTICS SERVICES, TO AID IN CREATING AND MANAGING SHIPMENTS THROUGH ALL PHASES OF THE SUPPLY CHAIN (U.S. CLS. 21, 23, 26, 36 AND 38).

CLASS 42—SCIENTIFIC, COMPUTER AND LEGAL SERVICES

FOR PROVIDING TEMPORARY USE OF NON-DOWNLOADABLE OPERATING SOFTWARE FOR USE IN INTEGRATED LOGISTICS SERVICES, TO AID IN CREATING AND MANAGING SHIPMENTS THROUGH ALL PHASES OF THE SUPPLY CHAIN (U.S. CLS. 100 AND 101).

SN 76-231,407. OPTIMUM LOGISTICS LTD., HAMILTON HM CX, BERMUDA, FILED 3-23-2001.

TRANSSUB

CLASS 9—ELECTRICAL AND SCIENTIFIC APPARATUS

FOR COMPUTER OPERATING SOFTWARE FOR USE IN PERMITTING CARRIERS TO SUBLET CARGOES TO OTHER CARRIERS USING AN EXCHANGE (U.S. CLS. 21, 23, 26, 36 AND 38).

CLASS 42—SCIENTIFIC, COMPUTER AND LEGAL SERVICES

FOR PROVIDING TEMPORARY USE OF NON-DOWNLOADABLE OPERATING SOFTWARE FOR USE IN PERMITTING CARRIERS TO SUBLET CARGOES TO OTHER CARRIERS USING AN EXCHANGE (U.S. CLS. 100 AND 101).

SN 76-231,408. OPTIMUM LOGISTICS LTD., HAMILTON HM CX, BERMUDA, FILED 3-23-2001.

TRANSSWAP

CLASS 9—ELECTRICAL AND SCIENTIFIC APPARATUS

FOR COMPUTER OPERATING SOFTWARE FOR USE IN PERMITTING SHIPPERS TO SWAP CARGOES WITH OTHER SHIPPERS (U.S. CLS. 21, 23, 26, 36 AND 38).

CLASS 42—SCIENTIFIC, COMPUTER AND LEGAL SERVICES

FOR PROVIDING TEMPORARY USE OF NON-DOWNLOADABLE OPERATING SOFTWARE FOR USE IN PERMITTING SHIPPERS TO SWAP CARGOES WITH OTHER SHIPPERS (U.S. CLS. 100 AND 101).

SN 76-231,411. OPTIMUM LOGISTICS LTD., HAMILTON HM CX, BERMUDA, FILED 3-23-2001.

TRANSBANK

CLASS 9—ELECTRICAL AND SCIENTIFIC APPARATUS

FOR COMPUTER OPERATING SOFTWARE FOR INTEGRATING INTERNATIONAL FINANCIAL SETTLEMENT SERVICES, INCLUDING CASH MANAGEMENT, ELECTRONIC BILL PAYMENT, TRADE CREDIT SERVICES, FREIGHT BILL PAYMENTS, EXPORT LETTERS OF CREDIT AND CLAIMS PROCESSING SERVICES IN TRANSACTION INVOLVING PRODUCT AND LOGISTICS ACTIVITIES (U.S. CLS. 21, 23, 26, 36 AND 38).

CLASS 42—SCIENTIFIC, COMPUTER AND LEGAL SERVICES

FOR PROVIDING TEMPORARY USE OF NON-DOWNLOADABLE OPERATING SOFTWARE FOR INTEGRATING INTERNATIONAL FINANCIAL SETTLEMENT SERVICES, INCLUDING CASH MANAGEMENT, ELECTRONIC BILL PAYMENT, TRADE CREDIT SERVICES, FREIGHT BILL PAYMENTS, EXPORT LETTERS OF CREDIT AND CLAIMS PROCESSING SERVICES IN TRANSACTION INVOLVING PRODUCT AND LOGISTICS ACTIVITIES (U.S. CLS. 100 AND 101).

SN 76-238,534. GOPAC, WASHINGTON, DC. FILED 4-11-2001.

GOPAC

CLASS 36—INSURANCE AND FINANCIAL

FOR POLITICAL FUNDRAISING SERVICES (U.S. CLS. 100, 101 AND 102).
FIRST USE 0-0-1979; IN COMMERCE 0-0-1979.

CLASS 41—EDUCATION AND ENTERTAINMENT

FOR EDUCATIONAL SERVICES, NAMELY CONDUCTING SEMINARS, CLASSES, WORKSHOPS, AND COURSES OF INSTRUCTION IN THE FIELD OF POLITICS (U.S. CLS. 100, 101 AND 107).
FIRST USE 0-0-1979; IN COMMERCE 0-0-1979.

CLASS 42—SCIENTIFIC, COMPUTER AND LEGAL SERVICES

FOR POLITICAL ACTION COMMITTEE SERVICES, NAMELY PROMOTING THE INTERESTS AND VIEWS OF THE REPUBLICAN PARTY; AND PROVIDING INFORMATION IN THE FIELD OF POLITICS (U.S. CLS. 100 AND 101).
FIRST USE 0-0-1979; IN COMMERCE 0-0-1979.

SN 76-239,464. SIMULEARN, INC., WILTON, CT. FILED 4-11-2001.

SIMULEARN

CLASS 9—ELECTRICAL AND SCIENTIFIC APPARATUS

FOR EDUCATIONAL SOFTWARE FEATURING INSTRUCTIONS IN CORPORATE MANAGEMENT (U.S. CLS. 21, 23, 26, 36 AND 38).

CLASS 35—ADVERTISING AND BUSINESS

FOR BUSINESS CONSULTING SERVICES IN THE FIELD OF CORPORATE MANAGEMENT (U.S. CLS. 100, 101 AND 102).

CLASS 41—EDUCATION AND ENTERTAINMENT

FOR EDUCATIONAL SERVICES, NAMELY, CONDUCTING CLASSES, SEMINARS AND WORKSHOPS IN THE FIELD OF CORPORATE MANAGEMENT (U.S. CLS. 100, 101 AND 107).

SN 76-240,269. FIRST BIOTECH, LLC, BOSTON, MA. FILED 4-13-2001.

FIRST BIOTECH

NO CLAIM IS MADE TO THE EXCLUSIVE RIGHT TO USE "BIOTECH", APART FROM THE MARK AS SHOWN.

CLASS 5—PHARMACEUTICALS

FOR CLINICAL MEDICAL REAGENTS; DIAGNOSTIC PREPARATIONS AND REAGENTS FOR CLINICAL MEDICAL USE; MEDICAL DIAGNOSTIC REAGENTS (U.S. CLS. 6, 18, 44, 46, 51 AND 52).

CLASS 42—SCIENTIFIC, COMPUTER AND LEGAL SERVICES

FOR RESEARCH AND DEVELOPMENT OF PHARMACEUTICAL REAGENTS AND VACCINES (U.S. CLS. 100 AND 101).

SN 76-241,290. ARTFUL DECOR, INC., HUDSON, WI. FILED 4-16-2001.

ARTFUL DECOR

NO CLAIM IS MADE TO THE EXCLUSIVE RIGHT TO USE "DECOR", APART FROM THE MARK AS SHOWN.

CLASS 16—PAPER GOODS AND PRINTED MATTER

FOR ART, NAMELY, ETCHINGS, PICTURES, PRINTS, GRAPHIC REPRODUCTIONS, AND PRINTED REPRODUCTIONS (U.S. CLS. 2, 5, 22, 23, 29, 37, 38 AND 50).

CLASS 35—ADVERTISING AND BUSINESS

FOR RETAIL SERVICES BY DIRECT SOLICITATION BY SALES AGENTS; BUSINESS MANAGEMENT SUPERVISION; INDEPENDENT SALES REPRESENTATIVES; AND DISTRIBUTORSHIP ALL IN THE FIELD OF PAINTINGS, SCULPTURES, AND PHOTOGRAPHS (U.S. CLS. 100, 101 AND 102).

SN 76-243,420. INTEX RECREATION CORP., LONG BEACH, CA. FILED 4-18-2001.

THE WET SET

OWNER OF U.S. REG. NOS. 1,016,381, 1,041,715 AND 1,490,081.

CLASS 11—ENVIRONMENTAL CONTROL APPARATUS

FOR FILTERS, HEATERS, AND PUMPS SOLD IN COMBINATION FOR USE IN SWIMMING POOLS (U.S. CLS. 13, 21, 23, 31 AND 34).

FIRST USE 0-0-1997; IN COMMERCE 0-0-1997.

CLASS 19—NON-METALLIC BUILDING MATERIALS

FOR NON-METAL SWIMMING POOLS AND COVERS FITTED FOR SWIMMING POOLS (U.S. CLS. 1, 12, 33 AND 50).

FIRST USE 0-0-1997; IN COMMERCE 0-0-1997.

SN 76-243,421. INTEX RECREATION CORP., LONG BEACH, CA. FILED 4-18-2001.

INTEX

OWNER OF U.S. REG. NOS. 1,292,262, 1,594,101 AND OTHERS.

CLASS 11—ENVIRONMENTAL CONTROL APPARATUS

FOR FILTERS, HEATERS, AND PUMPS SOLD IN COMBINATION FOR USE IN SWIMMING POOLS (U.S. CLS. 13, 21, 23, 31 AND 34).

FIRST USE 0-0-1997; IN COMMERCE 0-0-1997.

CLASS 19—NON-METALLIC BUILDING MATERIALS

FOR NON-METAL SWIMMING POOLS AND COVERS FITTED FOR SWIMMING POOLS (U.S. CLS. 1, 12, 33 AND 50).

FIRST USE 0-0-1997; IN COMMERCE 0-0-1997.

SN 76-245,118. MADACY ENTERTAINMENT GROUP, INC., MONTREAL, QUEBEC, FILED 4-24-2001.

ROCK ON CHRISTIAN

NO CLAIM IS MADE TO THE EXCLUSIVE RIGHT TO USE "CHRISTIAN", APART FROM THE MARK AS SHOWN.

CLASS 9—ELECTRICAL AND SCIENTIFIC APPARATUS

FOR PRE-RECORDED AUDIO CASSETTES, PRE-RECORDED AUDIO COMPACT DISCS AND PRE-RECORDED PHONOGRAPHIC RECORDINGS, ALL FEATURING MUSIC FOR RELIGIOUS AND ENTERTAINMENT PURPOSES (U.S. CLS. 21, 23, 26, 36 AND 38).

CLASS 41—EDUCATION AND ENTERTAINMENT

FOR ENTERTAINMENT SERVICES, NAMELY, THE PRODUCTION OF PHONOGRAPHIC RECORDS, AUDIO TAPES, AND AUDIO COMPACT DISCS FOR RELIGIOUS AND ENTERTAINMENT PURPOSES (U.S. CLS. 100, 101 AND 107).

SN 76-247,457. ADAMS, DARREL T., HUNTINGTON BEACH, CA. FILED 4-30-2001.

SN 76-250,241. KERTEL COMMUNICATIONS, INC., KERMAN, CA. FILED 5-1-2001.

M.A.T.H.

CLASS 16—PAPER GOODS AND PRINTED MATTER

FOR POSTERS (U.S. CLS. 2, 5, 22, 23, 29, 37, 38 AND 50).

CLASS 25—CLOTHING

FOR CLOTHING, NAMELY, SHIRTS, PANTS, SHORTS, SHOES AND HATS (U.S. CLS. 22 AND 39).

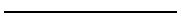

SN 76-249,906. R.I.T.E. SOLUTIONS, LLC, MIDDLETOWN, RI. FILED 5-2-2001.

RITE SOLUTIONS

CLASS 40—MATERIAL TREATMENT

FOR CUSTOM COMPUTER HARDWARE ASSEMBLY SERVICES (U.S. CLS. 100, 103 AND 106).
FIRST USE 12-15-1999; IN COMMERCE 12-15-1999.

CLASS 41—EDUCATION AND ENTERTAINMENT

FOR LOTTERY SERVICES, NAMELY, CONDUCTING AND ADMINISTERING LOTTERIES FOR OTHERS (U.S. CLS. 100, 101 AND 107).
FIRST USE 12-15-1999; IN COMMERCE 12-15-1999.

CLASS 42—SCIENTIFIC, COMPUTER AND LEGAL SERVICES

FOR COMPUTER SERVICES, NAMELY, COMPUTER SOFTWARE DEVELOPMENT FOR OTHERS, COMPUTER PROGRAMMING FOR OTHERS AND CONSULTATION THEREFOR, COMPUTER HARDWARE CONSULTATION SERVICES (U.S. CLS. 100 AND 101).
FIRST USE 12-15-1999; IN COMMERCE 12-15-1999.

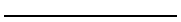

SN 76-250,201. IONICS, INCORPORATED, WATERTOWN, MA. FILED 5-2-2001.

REFRESH YOURSELF

CLASS 11—ENVIRONMENTAL CONTROL APPARATUS

FOR WATER SOFTENING UNITS, AND DRINKING WATER FILTRATION AND PURIFICATION UNITS (U.S. CLS. 13, 21, 23, 31 AND 34).

CLASS 32—LIGHT BEVERAGES

FOR BOTTLED WATER (U.S. CLS. 45, 46 AND 48).



NO CLAIM IS MADE TO THE EXCLUSIVE RIGHT TO USE "COMMUNICATIONS, INC.", APART FROM THE MARK AS SHOWN.

CLASS 37—CONSTRUCTION AND REPAIR

FOR TELEPHONE AND TELEPHONE SYSTEM INSTALLATION AND/OR REPAIR, ALARM AND ALARM SYSTEM INSTALLATION AND/OR REPAIR (U.S. CLS. 100, 103 AND 106).
FIRST USE 9-8-1998; IN COMMERCE 9-8-1998.

CLASS 38—COMMUNICATION

FOR TELEPHONE COMMUNICATION SERVICES, INTERNET ACCESS SERVICES AND TELEVISION TRANSMISSION SERVICES (U.S. CLS. 100, 101 AND 104).
FIRST USE 9-8-1998; IN COMMERCE 9-8-1998.

CLASS 42—SCIENTIFIC, COMPUTER AND LEGAL SERVICES

FOR ALARM MONITORING SERVICES (U.S. CLS. 100 AND 101).
FIRST USE 9-8-1998; IN COMMERCE 9-8-1998.

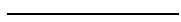

SN 76-253,149. GRATEFUL PALATE, INC., THE, OXNARD, CA. FILED 5-7-2001.



CLASS 16—PAPER GOODS AND PRINTED MATTER

FOR FABRIC GIFT BAGS FOR CARRYING BOTTLES OF WINE (U.S. CLS. 2, 5, 22, 23, 29, 37, 38 AND 50).
FIRST USE 8-1-1997; IN COMMERCE 1-1-1998.

CLASS 30—STAPLE FOODS

FOR COFFEE (U.S. CL. 46).
FIRST USE 8-1-1997; IN COMMERCE 1-1-1998.

CLASS 35—ADVERTISING AND BUSINESS

FOR ONLINE ORDERING SERVICES AND MAIL ORDER SERVICES FEATURING FOOD, WINE AND DRINKS; MAIL ORDER CLUB SERVICES FEATURING WINE (U.S. CLS. 100, 101 AND 102).

FIRST USE 8-1-1997; IN COMMERCE 1-1-1998.

SN 76-256,600. NATIONAL COMMERCE BANCORPORATION, MEMPHIS, TN. FILED 5-12-2001.



NO CLAIM IS MADE TO THE EXCLUSIVE RIGHT TO USE "NATIONAL" AND "FINANCIAL", APART FROM THE MARK AS SHOWN.

SN 76-256,165. COUNTRYWATCH.COM, INC., HOUSTON, TX. FILED 5-14-2001.

COUNTRYWATCH

OWNER OF U.S. REG. NO. 2,446,953.

CLASS 35—ADVERTISING AND BUSINESS

FOR PROMOTING BANKING SERVICES OF OTHERS AND THE SALE OF GOODS AND THE SERVICES OF OTHERS THROUGH THE ADMINISTRATION OF INCENTIVE AWARDS PROGRAMS; WHOLESALE DISTRIBUTORSHIPS FEATURING BANKING EQUIPMENT AND FIXTURES, AND BROCHURES AND POSTERS REGARDING BANKING; PROMOTING THE SALE OF THE GOODS AND SERVICES OF OTHER BANKS THROUGH THE DISTRIBUTION OF PRINTED MATERIALS, ON-LINE ADVERTISEMENTS AND THE ADMINISTRATION OF INCENTIVE AWARD PROGRAMS; AND BUSINESS MANAGEMENT CONSULTATION SERVICES IN THE FIELD OF DATA PROCESSING (U.S. CLS. 100, 101 AND 102).

CLASS 16—PAPER GOODS AND PRINTED MATTER

FOR REFERENCE BOOKS CONTAINING INTERNATIONAL POLITICAL, ECONOMIC, COMMERCIAL, AND BUSINESS DATA AND INFORMATION (U.S. CLS. 2, 5, 22, 23, 29, 37, 38 AND 50).

FIRST USE 1-2-2000; IN COMMERCE 1-10-2000.

CLASS 36—INSURANCE AND FINANCIAL

FOR FINANCIAL SERVICES, NAMELY, BANKING AND CREDIT CARD SERVICES, FINANCIAL SECURITIES CLEARINGHOUSE SERVICES AND SECURITIES BROKERAGE SERVICES, FINANCIAL PLANNING AND MANAGEMENT SERVICES, RETIREMENT AND ESTATE PLANNING SERVICES, RISK MANAGEMENT SERVICES, INVESTMENT AND TRUST MANAGEMENT SERVICES, INVESTMENT ADVISORY SERVICES, MUTUAL FUND INVESTMENT SERVICES, PROVIDING EQUITY AND GROWTH CAPITAL FOR OTHERS, CAPITAL INVESTMENT CONSULTATION, AND INSURANCE UNDERWRITING SERVICES IN THE FIELDS OF PROPERTY AND CASUALTY, WHOLE AND TERM LIFE, AND ANNUITIES; INSURANCE UNDERWRITING SERVICES IN THE FIELDS OF PROPERTY AND CASUALTY, WHOLE AND TERM LIFE, AND ANNUITIES; MORTGAGE BANKING; MORTGAGE LENDING; SECURITIES BROKERAGE; INVESTMENT BANKING; MUTUAL FUND INVESTMENT; UNDERWRITING AND ASSET MANAGEMENT SERVICES; CONSULTATION SERVICES IN THE FIELD OF FINANCIAL SERVICES AND ASSET MANAGEMENT (U.S. CLS. 100, 101 AND 102).

CLASS 35—ADVERTISING AND BUSINESS

FOR PROVIDING COMMERCIAL INFORMATION IN THE FIELD OF INTERNATIONAL BUSINESS, POLITICS, AND ECONOMICS VIA A GLOBAL COMPUTER NETWORK (U.S. CLS. 100, 101 AND 102).

FIRST USE 1-2-2000; IN COMMERCE 1-10-2000.

SN 76-256,399. AF2 ENTERPRISES LLC, CHICAGO, IL. FILED 5-14-2001.

LINCOLN LIGHTNING

NO CLAIM IS MADE TO THE EXCLUSIVE RIGHT TO USE "LINCOLN", APART FROM THE MARK AS SHOWN.

SN 76-257,617. MUSCLE ZONE USA, INC., WATERFORD, MI. FILED 5-10-2001.

MUSCLE ZONE

NO CLAIM IS MADE TO THE EXCLUSIVE RIGHT TO USE "MUSCLE", APART FROM THE MARK AS SHOWN.

CLASS 16—PAPER GOODS AND PRINTED MATTER

FOR GENERAL MERCHANDISE CATALOGS, BUMPER STICKERS, APPLIQUES IN THE FORM OF DECALS, SPORTS TRADING CARDS, POSTERS, CALENDARS, PAPER STICKERS, PRINTED EVENT ADMISSION TICKETS, AND PAPER PENNANTS (U.S. CLS. 2, 5, 22, 23, 29, 37, 38 AND 50).

FIRST USE 1-1-1999; IN COMMERCE 1-1-1999.

CLASS 25—CLOTHING

FOR MEN'S, WOMEN'S AND CHILDREN'S CLOTHING, NAMELY, PLAYER UNIFORMS, NAMELY, JERSEY TOPS AND PANTS; CHEERLEADER UNIFORMS; REPLICAS UNIFORM SHIRTS, COACHES' CAPS, WOOL HATS, PAINTERS' CAPS, BASEBALL CAPS, VISORS, HEADBANDS, BELTS, T-SHIRTS, TANK TOPS, GOLF SHIRTS, SWEATERS, SWEATSHIRTS, LEATHER JACKETS, NECKTIES, COATS, SHORTS, SWEATPANTS, PANTS AND UNDERWEAR (U.S. CLS. 22 AND 39).

FIRST USE 1-1-1999; IN COMMERCE 1-1-1999.

CLASS 5—PHARMACEUTICALS

FOR SPORTS NUTRITION SUPPLEMENTS (U.S. CLS. 6, 18, 44, 46, 51 AND 52).

CLASS 25—CLOTHING

FOR EXERCISE CLOTHING, NAMELY PANTS, SHIRTS, SHORTS AND LEOTARDS (U.S. CLS. 22 AND 39).

SN 76-257,805. SIPCO SURFACE PROTECTION INC., HOUSTON, TX. FILED 5-17-2001.

SIPCO

CLASS 37—CONSTRUCTION AND REPAIR

FOR PAINTING IN THE FIELD OF INDUSTRIAL AND MARINE STRUCTURES AND VESSELS FEATURING SURFACE PREPARATION, A CORROSION ABATEMENT PROGRAM AND ENVIRONMENTAL CONTAINMENT RELATING THERETO (U.S. CLS. 100, 103 AND 106).

FIRST USE 7-16-1982; IN COMMERCE 7-16-1982.

CLASS 40—MATERIAL TREATMENT

FOR APPLICATION OF PROTECTIVE SURFACE COATINGS TO AND FIREPROOFING OF INDUSTRIAL AND MARINE STRUCTURES AND VESSELS FEATURING SURFACE PREPARATION, A CORROSION ABATEMENT PROGRAM AND ENVIRONMENTAL CONTAINMENT RELATING THERETO (U.S. CLS. 100, 103 AND 106).

FIRST USE 7-16-1982; IN COMMERCE 7-16-1982.

SN 76-258,582. TIBURON CHARTERS LLC, TIBURON, CA. FILED 5-16-2001.

SPLASH PATROL

CLASS 16—PAPER GOODS AND PRINTED MATTER

FOR POSTERS, PLAYING CARDS, SCORE CARDS, WRAPPING PAPER AND PAPER TAGS, CALENDARS AND PAPER COASTERS, SOUVENIR BOOKS RELATED TO BASEBALL GAMES IN SAN FRANCISCO (U.S. CLS. 2, 5, 22, 23, 29, 37, 38 AND 50).

CLASS 21—HOUSEWARES AND GLASS

FOR TUMBLERS, SHOT GLASSES, COCKTAIL GLASSES, COASTERS AND MUGS MADE OF GLASS, PLASTIC, POTTERY OR PORCELAIN (U.S. CLS. 2, 13, 23, 29, 30, 33, 40 AND 50).

CLASS 25—CLOTHING

FOR SHIRTS, SWEATSHIRTS, TANK TOPS, SHORTS, SLACKS, JEANS, BATHING SUITS, JACKETS, SOCKS, UNDERWEAR, CAPS, SUN VISORS, HATS, SCARVES AND RAINCOATS (U.S. CLS. 22 AND 39).

CLASS 28—TOYS AND SPORTING GOODS

FOR BASEBALLS, FOOTBALLS, SOCCER BALLS, VOLLEYBALLS, HOCKEY PUCKS, FLYING DISCS, TOY STADIUM TRUMPETS, PLUSH TOYS, COLLECTIBLE TOY FIGURES, BOARD GAMES (U.S. CLS. 22, 23, 38 AND 50).

CLASS 39—TRANSPORTATION AND STORAGE

FOR PROVIDING SHIPBOARD CRUISES WITH PARTIES, BOAT CHARTERING; TRANSPORT BY FERRY; TRAVEL AGENCY SERVICES, NAMELY, MAKING RESERVATIONS AND BOOKINGS FOR TRANSPORTATION AND CRUISES (U.S. CLS. 100 AND 105).

CLASS 42—SCIENTIFIC, COMPUTER AND LEGAL SERVICES

FOR RESTAURANT AND BAR SERVICES OFFERED ON SHIPS (U.S. CLS. 100 AND 101).

SN 76-266,860. GRANUM, INC., SEATTLE, WA. FILED 6-5-2001.

TRI-ECHS

CLASS 5—PHARMACEUTICALS

FOR DIETARY SUPPLEMENTS, NAMELY HERBAL TEAS (U.S. CLS. 6, 18, 44, 46, 51 AND 52).

FIRST USE 7-1-1999; IN COMMERCE 7-1-1999.

CLASS 30—STAPLE FOODS

FOR HERBAL TEAS (U.S. CL. 46).

FIRST USE 7-1-1999; IN COMMERCE 7-1-1999.

SN 76-266,907. MERCER TOOL CORP., DEER PARK, NY. FILED 6-5-2001.

MERCER, A GLOBAL ABRASIVE COMPANY

NO CLAIM IS MADE TO THE EXCLUSIVE RIGHT TO USE "ABRASIVE COMPANY", APART FROM THE MARK AS SHOWN.

CLASS 3—COSMETICS AND CLEANING PREPARATIONS

FOR ABRASIVES, NAMELY, SANDPAPER AND SANDING SHEETS (U.S. CLS. 1, 4, 6, 50, 51 AND 52).

CLASS 7—MACHINERY

FOR MACHINE PARTS, NAMELY, SANDING BELTS, SANDING DISCS, AND SANDING ROLLS (U.S. CLS. 13, 19, 21, 23, 31, 34 AND 35).

CLASS 8—HAND TOOLS

FOR HAND TOOLS, NAMELY, FILES (U.S. CLS. 23, 28 AND 44).

CLASS 9—ELECTRICAL AND SCIENTIFIC APPARATUS

FOR BREATHING APPARATUS, NAMELY, DUST MASKS, SAFETY APPAREL, NAMELY, WORK GLOVES (U.S. CLS. 21, 23, 26, 36 AND 38).

SN 76-267,345. PFIZER INC., NEW YORK, NY. FILED 6-5-2001.

THE PARENT EQUATION

NO CLAIM IS MADE TO THE EXCLUSIVE RIGHT TO USE "PARENT", APART FROM THE MARK AS SHOWN.

CLASS 16—PAPER GOODS AND PRINTED MATTER

FOR PRINTED MATERIALS, NAMELY INFORMATIONAL BOOKLETS, BROCHURES, PAMPHLETS AND NEWSLETTERS FEATURING INFORMATION ON PARENTING (U.S. CLS. 2, 5, 22, 23, 29, 37, 38 AND 50).

CLASS 42—SCIENTIFIC, COMPUTER AND LEGAL SERVICES

FOR MEDICAL INFORMATION SERVICES, NAMELY PROVIDING INFORMATION ON THE TOPICS OF CHILD DEVELOPMENT AND PARENTING (U.S. CLS. 100 AND 101).

SN 76-269,796. EWERT, TERRY, DORCHESTER, WI. FILED 6-11-2001.

WHYACHI**CLASS 16—PAPER GOODS AND PRINTED MATTER**

FOR PRINTED MATERIAL, NAMELY, BUMPER STICKERS, CALENDARS, DECALS, DESK PADS, HEAT TRANSFERS, LUNCH BAGS, NON-ELECTRIC ERASERS, PAPER CONTAINERS, PAPER NAME BADGES, PAPER PENNANTS, PAPER TABLECLOTHS, PAPER WEIGHTS, PAPER PARTY NAPKINS, PENCILS, PENCIL HOLDERS, PENS, PHOTOGRAPHS, PLASTIC DECALS FOR USE AS TEMPORARY TATTOOS, PLAYING CARDS, POSTCARDS, POSTERS, PRINTED AWARDS, PRINTED PAPER SIGNS, STATIONERY, STATIONERY FOLDERS, STICKERS, STICKER ALBUMS, TRADING CARDS AND TRADING CARD ALBUMS (U.S. CLS. 2, 5, 22, 23, 29, 37, 38 AND 50).

CLASS 25—CLOTHING

FOR CLOTHING, NAMELY, APRONS, BANDANAS, BATHING SUITS, BEACH WEAR, BELTS, BERMUDA SHORTS, BLOUSES, CAPS, COATS, DRESSES, GLOVES, GOLF SHIRTS, GYM SUITS, HATS, HEADBANDS, HEAD WEAR, JACKETS, JERSEYS, JOGGING SUITS, JUMP SUITS, KNIT SHIRTS, KNITTED HATS, LEATHER JACKETS, MITTENS, NECKWEAR, OVERALLS, PAJAMAS, PANTS, PARKAS, POLO SHIRTS, PONCHOS, PULLOVERS, RAINCOATS, RAINWEAR, ROBES, SCARFS, SHIRTS, SHOES, SHORTS, SOCKS, SWEAT PANTS, SWEATERS, SWEATSHIRTS, T-SHIRTS, TANK TOPS, TIES, UNDERWEAR, V-NECK SWEATERS, VESTS, VISORS, AND WRISTBANDS (U.S. CLS. 22 AND 39).

CLASS 28—TOYS AND SPORTING GOODS

FOR TOY ROBOTS AND TOY ROBOT ACTION FIGURES AND ACCESSORIES (U.S. CLS. 22, 23, 38 AND 50).

SN 76-269,908. MERCURY INTERACTIVE CORPORATION, SUNNYVALE, CA. FILED 6-11-2001.

TOPAZ DIAGNOSTICS

NO CLAIM IS MADE TO THE EXCLUSIVE RIGHT TO USE "DIAGNOSTICS", APART FROM THE MARK AS SHOWN.

CLASS 9—ELECTRICAL AND SCIENTIFIC APPARATUS

FOR COMPUTER SOFTWARE FOR MONITORING, TESTING AND REPORTING THE PERFORMANCE AND ACCESSIBILITY OF MULTI-USER COMPUTER SYSTEMS AND NETWORK CONNECTIONS THERETO; INSTRUCTIONAL MANUALS SOLD AS A UNIT (U.S. CLS. 21, 23, 26, 36 AND 38).

CLASS 42—SCIENTIFIC, COMPUTER AND LEGAL SERVICES

FOR COMPUTER SERVICES FOR MONITORING, TESTING AND REPORTING THE PERFORMANCE AND ACCESSIBILITY OF MULTI-USER COMPUTER SYSTEMS AND NETWORK CONNECTIONS THERETO (U.S. CLS. 100 AND 101).

SN 76-270,706. LAW SCHOOL ADMISSION COUNCIL, INC., NEWTOWN, PA. FILED 6-14-2001.

LSAC**CLASS 41—EDUCATION AND ENTERTAINMENT**

FOR EDUCATIONAL SERVICES; NAMELY, CONDUCTING EDUCATIONAL CONFERENCES, WORKSHOPS AND SEMINARS RELATING TO LAW SCHOOL ADMISSION AND LEGAL EDUCATION (U.S. CLS. 100, 101 AND 107).

FIRST USE 5-31-1972; IN COMMERCE 5-31-1972.

CLASS 42—SCIENTIFIC, COMPUTER AND LEGAL SERVICES

FOR STANDARDIZED TESTING AND APPLICATION PROCESSING SERVICES FOR LAW SCHOOLS AND LAW SCHOOL APPLICANTS (U.S. CLS. 100 AND 101).

FIRST USE 5-31-1972; IN COMMERCE 5-31-1972.

SN 76-272,327. INTERNAL ENGINE PARTS, INC., MERIDIAN, MS. FILED 6-15-2001.

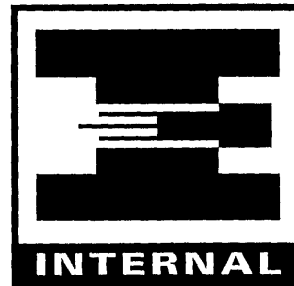

NO CLAIM IS MADE TO THE EXCLUSIVE RIGHT TO USE "INTERNAL", APART FROM THE MARK AS SHOWN. THE MARK CONSISTS, IN PART, OF THE WORD "INTERNAL" AND A STYLIZED PRESENTATION OF THE LETTERS "I" AND "E" WITHIN A SQUARE.

CLASS 7—MACHINERY

FOR REPAIR KITS, SOLD AS A UNIT, FOR LAND VEHICLE INTERNAL COMBUSTION ENGINES, COMPRISING PISTONS, RINGS, BEARINGS, CAMSHAFTS, GASKETS, FASTENERS AND VALVE TRAIN PARTS (U.S. CLS. 13, 19, 21, 23, 31, 34 AND 35).

CLASS 35—ADVERTISING AND BUSINESS

FOR WHOLESALE AND RETAIL STORE SERVICES IN THE FIELD OF ENGINE PARTS (U.S. CLS. 100, 101 AND 102).

SN 76-273,061. SL GREEN REALTY CORP., NEW YORK, NY.
FILED 6-18-2001.

**DEFINING A NEW CLASS OF
NEW YORK OFFICE SPACE**

NO CLAIM IS MADE TO THE EXCLUSIVE RIGHT TO USE "NEW YORK OFFICE SPACE", APART FROM THE MARK AS SHOWN.

CLASS 36—INSURANCE AND FINANCIAL

FOR COMMERCIAL REAL ESTATE MANAGEMENT, LEASING, BROKERAGE, INVESTMENT AND FINANCIAL EVALUATION (U.S. CLS. 100, 101 AND 102).
FIRST USE 9-0-2000; IN COMMERCE 9-0-2000.

CLASS 37—CONSTRUCTION AND REPAIR

FOR COMMERCIAL REAL ESTATE DEVELOPMENT, AND COMMERCIAL BUILDING CONSTRUCTION (U.S. CLS. 100, 103 AND 106).
FIRST USE 9-0-2000; IN COMMERCE 9-0-2000.

SN 76-275,285. ASLAN ENTERTAINMENT, INC., BRENTWOOD, TN. FILED 6-21-2001.

GNOO ZOO**CLASS 9—ELECTRICAL AND SCIENTIFIC APPARATUS**

FOR PRERECORDED COMPACT DISCS, AUDIO-CASSETTES, PHONOGRAPH RECORDS, AND VIDEOTAPES FEATURING INSTRUMENTAL AND VOCALIZED MUSIC AND SPOKEN WORD FOR THE EDUCATION AND ENTERTAINMENT OF CHILDREN, AND CD-ROMS FEATURING SOFTWARE PROGRAMS AND INTERACTIVE MULTIMEDIA SOFTWARE PROGRAMS FOR THE ENTERTAINMENT AND EDUCATION OF CHILDREN (U.S. CLS. 21, 23, 26, 36 AND 38).

CLASS 16—PAPER GOODS AND PRINTED MATTER

FOR PAPER AND CUT-OUT FIGURES; GIFT WRAPPING PAPER; PAPER PARTY GOODS, NAMELY BAGS, NAPKINS, DECORATIONS AND HATS; POSTERS; PUBLICATIONS, NAMELY MAGAZINES AND BOOKS FOR CHILDREN'S EDUCATION AND ENTERTAINMENT; CARTOONS, NAMELY NEWSPAPER CARTOONS; PENS AND PENCILS; CALENDARS; PAINTING SETS FOR CHILDREN; BOOK MARKS; DECALS, STICKERS AND BUMPER STICKERS; AND RUBBER STAMPS (U.S. CLS. 2, 5, 22, 23, 29, 37, 38 AND 50).

CLASS 25—CLOTHING

FOR CLOTHING, NAMELY SWEATERS, JACKETS, FOOTWEAR, PAJAMAS, NIGHTSHIRTS, MITTENS, GLOVES, GALOSHES, UNDERWEAR, UNDERSHIRTS, CLOTH DIAPERS, SWEAT PANTS AND SWEAT SHIRTS, LEOTARDS, TIGHTS, JEANS, SHORTS, GYM SHORTS, T-SHIRTS, POLO SHIRTS, TANK TOPS, VESTS, BLAZERS, JUMPSUITS, PLAYSUITS, DRESSES, HEADWEAR, HATS, CAPS, HEADBANDS, SLEEPWEAR, RAINWEAR, COATS, AND HALLOWEEN COSTUMES (U.S. CLS. 22 AND 39).

CLASS 28—TOYS AND SPORTING GOODS

FOR TOYS, GAMES AND PLAYTHINGS, NAMELY BENDABLE PLAY FIGURES AND TOY ACTION FIGURES; BALLS, NAMELY SPORTS BALLS; TOY WATCHES; TOY BANKS; BATHTUB TOYS; AUDIO AND VISUAL TOYS, NAMELY TALKING DOLLS, TOY THREE-DIMENSIONAL VIEWERS AND REELS; BOARD GAMES; JIGSAW PUZZLES; PUPPETS; MUSICAL TOYS; TOY BUILDING BLOCKS; MOBILES FOR CHILDREN (U.S. CLS. 22, 23, 38 AND 50).

CLASS 41—EDUCATION AND ENTERTAINMENT

FOR ENTERTAINMENT SERVICES, NAMELY AN ANIMATED TELEVISION SERIES AND LIVE PERFORMANCES FEATURING COSTUMED CHARACTERS FOR THE EDUCATION AND ENTERTAINMENT OF CHILDREN; AND COMPUTER ON-LINE SERVICES OFFERED VIA THE INTERNET FEATURING GAMES, CONTESTS AND ENTERTAINMENT (U.S. CLS. 100, 101 AND 107).

SN 76-275,373. LOUDOUN COUNTY CHAMBER OF COMMERCE, LEESBURG, VA. FILED 6-22-2001.



NO CLAIM IS MADE TO THE EXCLUSIVE RIGHT TO USE "LOUDOUN COUNTY" OR "CHAMBER OF COMMERCE", APART FROM THE MARK AS SHOWN.

CLASS 16—PAPER GOODS AND PRINTED MATTER

FOR PERIODICAL PUBLICATIONS IN THE FIELD OF BUSINESS CONSULTATION AND PROMOTIONAL SERVICES (U.S. CLS. 2, 5, 22, 23, 29, 37, 38 AND 50).
FIRST USE 1-19-2000; IN COMMERCE 2-2-2000.

CLASS 35—ADVERTISING AND BUSINESS

FOR BUSINESS CONSULTATION AND CHAMBER OF COMMERCE SERVICES, NAMELY, PROMOTING BUSINESS AND TOURISM IN LOUDOUN COUNTY, VIRGINIA (U.S. CLS. 100, 101 AND 102).
FIRST USE 1-19-2000; IN COMMERCE 2-2-2000.

SN 76-275,648. MASTER WHOLESAL, INC., SEATTLE, WA.
FILED 6-21-2001.



OWNER OF U.S. REG. NO. 2,240,731.
NO CLAIM IS MADE TO THE EXCLUSIVE RIGHT TO USE "WHOLESALE INC.", "SEATTLE WA." AND "QUALITY & SERVICE", APART FROM THE MARK AS SHOWN. THE MARK INCLUDES THE LETTERS "M", "W" AND "I" IN STYLIZED FORM.

CLASS 7—MACHINERY

FOR POWER OPERATED TOOLS AND PARTS FOR POWER OPERATED TOOLS, NAMELY, BUFFERS, TILE SAWS, SLAB SAWS, GRINDERS, BUFF AND POLISHING PADS, FOAM PADS, STRIPS, CHIPS, PINS, ROUTER BITS AND CORE BITS; AND SAW BLADES, NAMELY, CONTINUOUS BLADES, DIAMOND BLADES, TURBO BLADES, SEGMENTED BLADES, GRANITE BLADES, EDGERS, PROFILE WHEELS AND GRINDING WHEELS (U.S. CLS. 13, 19, 21, 23, 31, 34 AND 35).
FIRST USE 7-0-1995; IN COMMERCE 7-0-1995.

CLASS 8—HAND TOOLS

FOR HAND-HELD TOOLS, NAMELY, SAWS, MALLET, HAMMERS, TROWELS, TRACERS, POINTERS, NIPPERS, BRICK JOINTERS, CHISELS, ROLLING SEALERS, WEDGES, SHIMS, SPACERS, NIPS, SCRAPERS, SCORERS, POPPERS, GROUT FLOATS, SUCTION CUPS, SLAB LIFTERS AND PULLERS AND RAZOR BLADES (U.S. CLS. 23, 28 AND 44).
FIRST USE 7-0-1995; IN COMMERCE 7-0-1995.

CLASS 9—ELECTRICAL AND SCIENTIFIC APPARATUS

FOR SAFETY AND PROTECTIVE EQUIPMENT FOR CONSTRUCTION AND INDUSTRIAL USE, NAMELY, PROTECTIVE APRONS, PROTECTIVE GLOVES, EAR PLUGS, EAR MUFFS, KNEE PADS, SAFETY GOGGLES AND DUST MASKS; AND CORDS, STRAPS AND ELECTRICAL POWER EXTENSION CORDS (U.S. CLS. 21, 23, 26, 36 AND 38).
FIRST USE 7-0-1995; IN COMMERCE 7-0-1995.

CLASS 35—ADVERTISING AND BUSINESS

FOR RETAIL STORE SERVICES SPECIALIZING IN TILE AND STONE WORKING TOOLS AND SUPPLIES; AND RETAIL STORE SERVICES PROVIDED OVER THE GLOBAL COMPUTER NETWORK FEATURING TILE AND STONE WORKING TOOLS AND SUPPLIES (U.S. CLS. 100, 101 AND 102).
FIRST USE 7-0-1995; IN COMMERCE 7-0-1995.

SN 76-277,148. OPTIMUM LOGISTICS LTD., HAMILTON
HM CX, BERMUDA, FILED 6-27-2001.

TRANSBULKMARINE

CLASS 9—ELECTRICAL AND SCIENTIFIC APPARATUS

FOR COMPUTER OPERATING SOFTWARE FOR USE IN INTEGRATED LOGISTICS SERVICES, TO AID IN CREATING AND MANAGING SHIPMENTS OF BULK MATERIALS THROUGH ALL PHASES OF THE BULK MATERIALS SUPPLY CHAIN (U.S. CLS. 21, 23, 26, 36 AND 38).

CLASS 42—SCIENTIFIC, COMPUTER AND LEGAL SERVICES

FOR PROVIDING TEMPORARY USE OF NON-DOWNLOADABLE OPERATING SOFTWARE FOR USE IN INTEGRATED LOGISTICS SERVICES, TO AID IN CREATING AND MANAGING SHIPMENTS OF BULK MATERIALS THROUGH ALL PHASES OF THE BULK MATERIALS SUPPLY CHAIN (U.S. CLS. 100 AND 101).

SN 76-277,149. OPTIMUM LOGISTICS LTD., HAMILTON
HM CX, BERMUDA, FILED 6-27-2001.

TRANSOPTIMIZATION

CLASS 9—ELECTRICAL AND SCIENTIFIC APPARATUS

FOR COMPUTER OPERATING SOFTWARE FOR USE IN INTEGRATED LOGISTICS SERVICES, TO AID IN CREATING, MANAGING AND OPTIMIZING SHIPMENTS OF BULK MATERIALS THROUGH ALL PHASES OF THE BULK MATERIALS SUPPLY CHAIN (U.S. CLS. 21, 23, 26, 36 AND 38).

CLASS 42—SCIENTIFIC, COMPUTER AND LEGAL SERVICES

FOR PROVIDING TEMPORARY USE OF NON-DOWNLOADABLE OPERATING SOFTWARE FOR USE IN INTEGRATED LOGISTICS SERVICES, TO AID IN CREATING, MANAGING, AND OPTIMIZING SHIPMENTS OF BULK MATERIALS THROUGH ALL PHASES OF THE BULK MATERIALS SUPPLY CHAIN (U.S. CLS. 100 AND 101).

SN 76-277,442. TRUEPOINTS, INC., CHICAGO, IL. FILED 6-25-2001.

PROMOBOX

CLASS 9—ELECTRICAL AND SCIENTIFIC APPARATUS

FOR COMPUTER SOFTWARE FOR PROMOTING THE GOODS AND SERVICES OF OTHERS, NAMELY FOR DESIGNING INCENTIVE PROGRAMS VIA THE INTERNET; COMPUTER SOFTWARE FOR TRANSMITTING AND ANALYZING CUSTOMER RESPONSES TO SATISFACTION SURVEYS AND QUERIES VIA THE INTERNET; COMPUTER E-COMMERCE SOFTWARE TO ALLOW USERS TO PERFORM ELECTRONIC BUSINESS TRANSACTIONS VIA A GLOBAL COMPUTER NETWORK, NAMELY PROCESSING ON-LINE RETAIL ORDERS; COMPUTER E-MAIL SOFTWARE FOR SENDING MESSAGES VIA A GLOBAL COMPUTER NETWORK; COMPUTER SOFTWARE FOR CREATING AND MANAGING RICH MEDIA ON-LINE ADVERTISEMENTS, PROMOTIONS, AND SERVING ADVERTISEMENTS; AND COMPUTER SOFTWARE FOR MONITORING AND TRACKING THE PROGRESS AND BUSINESS RESULTS OF PROMOTIONS AND ADVERTISEMENTS, DATAMINING, SWEEPSTAKES AND GIVE-AWAYS (U.S. CLS. 21, 23, 26, 36 AND 38).

CLASS 35—ADVERTISING AND BUSINESS

FOR PROMOTING THE GOODS AND SERVICES OF OTHERS BY MEANS OF A GLOBAL COMMUNICATIONS NETWORK BY DISSEMINATION OF ON-LINE ADVERTISING AND PROMOTIONS, AND BY AWARDING PURCHASE POINTS THAT MAY BE REDEEMED FOR THE GOODS AND SERVICES OF OTHERS (U.S. CLS. 100, 101 AND 102).

SN 76-277,550. OPTIMUM LOGISTICS LTD., HAMILTON, HM CX, BERMUDA, FILED 6-27-2001.

TRANSTANKCONTAINER

CLASS 9—ELECTRICAL AND SCIENTIFIC APPARATUS

FOR COMPUTER OPERATING SOFTWARE FOR USE IN INTEGRATED LOGISTICS SERVICES, TO AID IN CREATING AND MANAGING SHIPMENTS OF FULL CONTAINER LOADS OF MATERIALS THROUGH ALL PHASES OF THE MATERIALS SUPPLY CHAIN (U.S. CLS. 21, 23, 26, 36 AND 38).

CLASS 42—SCIENTIFIC, COMPUTER AND LEGAL SERVICES

FOR PROVIDING TEMPORARY USE OF NON-DOWNLOADABLE OPERATING SOFTWARE FOR USE IN INTEGRATED LOGISTICS SERVICES, TO AID IN CREATING AND MANAGING SHIPMENTS OF FULL CONTAINER LOADS OF MATERIALS THROUGH ALL PHASES OF THE MATERIALS SUPPLY CHAIN (U.S. CLS. 100 AND 101).

SN 76-280,541. IDIOMAX LLC, WILMINGTON, DE. FILED 7-5-2001.

IDIOMAX

CLASS 9—ELECTRICAL AND SCIENTIFIC APPARATUS

FOR COMPUTER SOFTWARE FOR LANGUAGE TRANSLATION THAT MAY BE DOWNLOADED FROM A GLOBAL COMPUTER NETWORK (U.S. CLS. 21, 23, 26, 36 AND 38).

FIRST USE 11-6-2000; IN COMMERCE 11-6-2000.

CLASS 42—SCIENTIFIC, COMPUTER AND LEGAL SERVICES

FOR LANGUAGE TRANSLATION, NAMELY PROVIDING TRANSLATION SERVICE VIA A GLOBAL COMPUTER NETWORK (U.S. CLS. 100 AND 101).

FIRST USE 11-6-2000; IN COMMERCE 11-6-2000.

SN 76-282,446. HEALTHSTOP, INC., THE, DBA THE HEALTH STOP, INC., BERKLEY, MI. FILED 7-9-2001.

KARMIC KITCHEN

NO CLAIM IS MADE TO THE EXCLUSIVE RIGHT TO USE "KITCHEN", APART FROM THE MARK AS SHOWN.

CLASS 39—TRANSPORTATION AND STORAGE

FOR FOOD SHIPPING AND DELIVERY (U.S. CLS. 100 AND 105).

FIRST USE 6-20-2001; IN COMMERCE 6-20-2001.

CLASS 40—MATERIAL TREATMENT

FOR FOOD PROCESSING, NAMELY, COOKING AND MIXING (U.S. CLS. 100, 103 AND 106).

FIRST USE 6-20-2001; IN COMMERCE 6-20-2001.

CLASS 42—SCIENTIFIC, COMPUTER AND LEGAL SERVICES

FOR FOOD NUTRITION CONSULTATION AND FOOD RECIPE DESIGN FOR OTHERS (U.S. CLS. 100 AND 101).

FIRST USE 6-20-2001; IN COMMERCE 6-20-2001.

SN 76-289,779. INTERACTIVE DEVELOPMENT CORPORATION, SILVER SPRING, MD. FILED 7-25-2001.

CMSWATCH

CLASS 16—PAPER GOODS AND PRINTED MATTER

FOR NEWSLETTERS FEATURING INFORMATION ON CONTENT MANAGEMENT SYSTEMS (U.S. CLS. 2, 5, 22, 23, 29, 37, 38 AND 50).

CLASS 42—SCIENTIFIC, COMPUTER AND LEGAL SERVICES

FOR PROVIDING A WEB SITE FEATURING INFORMATION, NEWS, OPINIONS, AND ANALYSES OF WEB CONTENT MANAGEMENT AND RELATED TECHNOLOGIES (U.S. CLS. 100 AND 101).

SN 76-290,415. LIDL STIFTUNG & CO. KG, 74172 NECK-ARSULM, FED REP GERMANY, FILED 7-25-2001.

MEADOW FRESH

OWNER OF FED REP GERMANY REG. NO. 39644204, DATED 11-7-1996, EXPIRES 10-31-2006.

NO CLAIM IS MADE TO THE EXCLUSIVE RIGHT TO USE "FRESH", APART FROM THE MARK AS SHOWN.

CLASS 29—MEATS AND PROCESSED FOODS

FOR SALAD PREPARATIONS CONSISTING ESSENTIALLY OF MEAT, FISH, POULTRY AND/OR GAME WITH THE ADDITION OF ESPECIALLY FRUITS, VEGETABLES, POTATOES, FARINACEOUS PASTES AND/OR RICE (U.S. CL. 46).

CLASS 30—STAPLE FOODS

FOR SALAD PREPARATIONS ESSENTIALLY CONSISTING OF FARINACEOUS PASTES AND/OR RICE WITH THE ADDITION OF MEAT, FISH, POULTRY AND/OR GAME, FRUITS, VEGETABLES, POTATOES (U.S. CL. 46).

SN 76-291,918. VASTERA, INC., DULLES, VA. FILED 7-31-2001.

GIVE US THE BALL

CLASS 35—ADVERTISING AND BUSINESS

FOR BUSINESS MANAGEMENT AND CONSULTING SERVICES RELATED TO IMPORT/EXPORT LOGISTICS AND COMPLIANCE (U.S. CLS. 100, 101 AND 102).

CLASS 42—SCIENTIFIC, COMPUTER AND LEGAL SERVICES

FOR COMPUTER CONSULTATION AND MAINTENANCE SERVICES IN THE FIELD OF COMPUTER SOFTWARE FOR IMPORT/EXPORT LOGISTICS AND COMPLIANCE (U.S. CLS. 100 AND 101).

SN 76-304,135. SAUNDERS, ZINA, NEW YORK, NY. FILED 8-23-2001.

SN 76-292,219. CONAGRA FOODS, INC., OMAHA, NE. FILED 7-31-2001.

SQUARE ROOTS**CLASS 29—MEATS AND PROCESSED FOODS**

FOR FROZEN PREPARED MEALS CONSISTING PRIMARILY OF VEGETABLES (U.S. CL. 46).

CLASS 30—STAPLE FOODS

FOR FROZEN PREPARED MEALS CONSISTING PRIMARILY OF PASTA OR RICE (U.S. CL. 46).

SN 76-292,818. HYGLO AB, 12675 STOCKHOLM, SWEDEN, FILED 7-31-2001.

GLOSOLUTION**CLASS 9—ELECTRICAL AND SCIENTIFIC APPARATUS**

FOR COMPUTER HARDWARE AND COMPUTER SOFTWARE TO ENABLE ACCESS TO THE INTERNET FOR INTERNAL AND EXTERNAL TELECOMMUNICATIONS AND COMPUTER COMMUNICATIONS; COMPUTER SERVERS (U.S. CLS. 21, 23, 26, 36 AND 38).

CLASS 38—COMMUNICATION

FOR TRANSMISSION FOR OTHERS OF DATA, INFORMATION, MESSAGES AND IMAGES VIA TELECOMMUNICATION NETWORKS AND DATA COMMUNICATION NETWORKS (U.S. CLS. 100, 101 AND 104).

SN 76-300,349. FIT PRO, INC., DENVER, CO. FILED 8-16-2001.

NO WORKOUT

NO CLAIM IS MADE TO THE EXCLUSIVE RIGHT TO USE "WORKOUT", APART FROM THE MARK AS SHOWN.

CLASS 41—EDUCATION AND ENTERTAINMENT

FOR PROVIDING FACILITIES FOR PHYSICAL FITNESS WORKOUTS (U.S. CLS. 100, 101 AND 107).

CLASS 42—SCIENTIFIC, COMPUTER AND LEGAL SERVICES

FOR HEALTH SALON AND PROVIDING COUNSELING IN THE FIELD OF WEIGHT REDUCTION AND GENERAL HEALTH INFORMATION (U.S. CLS. 100 AND 101).

FEARIES**CLASS 16—PAPER GOODS AND PRINTED MATTER**

FOR PRINTED MATTER AND PAPER GOODS, NAMELY, BOOKS AND MAGAZINES FEATURING CHARACTERS FROM ANIMATED FEATURES, COMIC BOOKS, COLORING BOOKS, CHILDREN'S ACTIVITY BOOKS, STATIONERY, TRADING CARDS, CRAYONS, DECALS, POSTERS, CALENDARS, GIFT WRAPPING PAPER, PAPER PARTY FAVORS (U.S. CLS. 2, 5, 22, 23, 29, 37, 38 AND 50).

CLASS 28—TOYS AND SPORTING GOODS

FOR TOYS, NAMELY, ACTION FIGURES AND ACCESSORIES THEREFOR, DOLLS AND ACCESSORIES THEREFOR, PLUSH TOYS, BALLOONS, BATHTUB TOYS, CARD GAMES, BOARD GAMES, COSTUME MASKS, TOY COOKWARE, TOY BANKS, AND CHRISTMAS TREE ORNAMENTS (U.S. CLS. 22, 23, 38 AND 50).

SN 76-304,153. ROCKY MOUNTAIN HARLEY-DAVIDSON MOTOR COMPANY, LITTLETON, CO. FILED 8-23-2001.

THE FUTURE IS NOT WHAT IT USED TO BE**CLASS 35—ADVERTISING AND BUSINESS**

FOR RETAIL STORE SERVICES FEATURING MOTORCYCLES, MOTORCYCLE PARTS AND ACCESSORIES; RETAIL STORE SERVICES FEATURING APPAREL, NAMELY HATS, CAPS, SHIRTS, T-SHIRTS, JACKETS, PANTS, CHAPS, RAIN GEAR, GLOVES, FOOTWEAR, BOOTS, SHOES AND BANDANAS (U.S. CLS. 100, 101 AND 102).

CLASS 37—CONSTRUCTION AND REPAIR

FOR MOTORCYCLE REPAIR (U.S. CLS. 100, 103 AND 106).

SN 76-304,968. CIGNA INTELLECTUAL PROPERTY, INC., WILMINGTON, DE. FILED 8-27-2001.

CIGNA DISABILITY MANAGEMENT SOLUTIONS

OWNER OF U.S. REG. NOS. 1,270,223, 2,417,351 AND OTHERS.

NO CLAIM IS MADE TO THE EXCLUSIVE RIGHT TO USE "DISABILITY MANAGEMENT SOLUTIONS", APART FROM THE MARK AS SHOWN.

CLASS 36—INSURANCE AND FINANCIAL

FOR DISABILITY INSURANCE UNDERWRITING SERVICES; DISABILITY INSURANCE CLAIMS ADMINISTRATION AND PROCESSING (U.S. CLS. 100, 101 AND 102).

CLASS 42—SCIENTIFIC, COMPUTER AND LEGAL SERVICES

FOR MANAGED HEALTH CARE SERVICES (U.S. CLS. 100 AND 101).

SN 76-307,816. AMERICAN HOSPITAL ASSOCIATION, CHICAGO, IL. FILED 8-31-2001.



CLASS 16—PAPER GOODS AND PRINTED MATTER

FOR MAGAZINES CONCERNING USE OF TECHNOLOGY IN MEDICAL FACILITIES (U.S. CLS. 2, 5, 22, 23, 29, 37, 38 AND 50).

CLASS 35—ADVERTISING AND BUSINESS

FOR CONDUCTING SURVEYS CONCERNING TECHNOLOGY USED IN MEDICAL FACILITIES (U.S. CLS. 100, 101 AND 102).

SN 76-308,254. SCOTT'S SPLASH LAGOON, INC., ERIE, PA. FILED 9-4-2001.

SPLASH LAGOON

CLASS 41—EDUCATION AND ENTERTAINMENT

FOR ENTERTAINMENT IN THE NATURE OF A WATER PARK AND AMUSEMENT CENTER (U.S. CLS. 100, 101 AND 107).

CLASS 42—SCIENTIFIC, COMPUTER AND LEGAL SERVICES

FOR PROVIDING FOODS AND BEVERAGES FOR CONSUMPTION ON OR OFF THE PREMISES (U.S. CLS. 100 AND 101).

SN 76-308,756. B.A.S.S. (IP), LLC, BRISTOL, CT. FILED 9-4-2001.

CLEAN WATER CRITTERS

CLASS 16—PAPER GOODS AND PRINTED MATTER

FOR PRINTED PUBLICATIONS, NAMELY, MAGAZINES FEATURING ENVIRONMENTAL PROTECTION TOPICS FOR CHILDREN; GREETING CARDS, CALENDARS, STICKERS (U.S. CLS. 2, 5, 22, 23, 29, 37, 38 AND 50).

CLASS 25—CLOTHING

FOR CHILDRENS CLOTHING, NAMELY, T-SHIRTS AND CAPS (U.S. CLS. 22 AND 39).

CLASS 28—TOYS AND SPORTING GOODS

FOR STUFFED TOYS (U.S. CLS. 22, 23, 38 AND 50).

CLASS 41—EDUCATION AND ENTERTAINMENT

FOR EDUCATIONAL SERVICES, NAMELY, CONDUCTING SEMINARS AND PROGRAMS FOR CHILDREN ON ENVIRONMENTAL AND CONSERVATION MEASURES (U.S. CLS. 100, 101 AND 107).

SN 76-308,778. AMERICAN STOCK EXCHANGE, LLC, NEW YORK, NY. FILED 9-4-2001.

OPPORTUNITY MADE FRESH DAILY

CLASS 16—PAPER GOODS AND PRINTED MATTER

FOR PERIODICALS, NAMELY, MAGAZINES, NEWS REPORTS AND PAMPHLETS ISSUED ON A REGULAR AS WELL AS IRREGULAR BASIS, AND PRINTED STUDIES IN PAMPHLET FORM, ISSUED IRREGULARLY, RELATING TO SECURITIES AND THE MARKETING OF SECURITIES (U.S. CLS. 2, 5, 22, 23, 29, 37, 38 AND 50).

CLASS 36—INSURANCE AND FINANCIAL

FOR SECURITIES EXCHANGE SERVICES, NAMELY, PROVIDING A MARKET FOR SECURITIES, PROVIDING INFORMATION ABOUT SECURITIES AND CORPORATIONS ISSUING SECURITIES, COMPILING AND DISSEMINATING PRICE LEVEL AND VOLUME INDICES (U.S. CLS. 100, 101 AND 102).

SN 76-309,087. INTRANEXUS, LLC, VIRGINIA BEACH, VA. FILED 9-5-2001.

INTRANEXUS

CLASS 37—CONSTRUCTION AND REPAIR

FOR INSTALLATION, CUSTOMIZATION, MAINTENANCE AND REPAIR OF COMPUTER HARDWARE FOR HEALTH CARE ORGANIZATIONS (U.S. CLS. 100, 103 AND 106).
FIRST USE 3-0-2000; IN COMMERCE 3-0-2000.

CLASS 42—SCIENTIFIC, COMPUTER AND LEGAL SERVICES

FOR INSTALLATION, CUSTOMIZATION, MAINTENANCE AND REPAIR OF COMPUTER SOFTWARE; COMPUTER CONSULTATION SERVICES FOR HEALTH CARE ORGANIZATIONS; AND CONSULTING SERVICES FOR HEALTH CARE ORGANIZATIONS (U.S. CLS. 100 AND 101).
FIRST USE 3-0-2000; IN COMMERCE 3-0-2000.

SN 76-309,146. CONCORDIA HOMES, INC., CANYON LAKE, CA. FILED 9-5-2001.

SN 78-000,917. SOJOURN, LLC, WESTPORT, CT. BY ASSIGNMENT LEIRUM CORPORATION, SAN FRANCISCO, CA. FILED 3-24-2000.

CONCORDIA

CLASS 36—INSURANCE AND FINANCIAL

FOR REAL ESTATE INVESTMENT (U.S. CLS. 100, 101 AND 102).
FIRST USE 1-0-1977; IN COMMERCE 1-0-1977.

CLASS 37—CONSTRUCTION AND REPAIR

FOR REAL ESTATE DEVELOPMENT; REAL ESTATE SITE SELECTION; CONSTRUCTION SERVICES, NAMELY, PLANNING, LAYING OUT AND CONSTRUCTION OF RESIDENTIAL AND COMMERCIAL BUILDINGS (U.S. CLS. 100, 103 AND 106).
FIRST USE 1-0-1977; IN COMMERCE 1-0-1977.



CLASS 9—ELECTRICAL AND SCIENTIFIC APPARATUS

FOR PRE-RECORDED COMPACT DISCS, DVDS, AUDIO CASSETTES, AND VIDEO TAPES FEATURING LIVE MUSIC AND THEATRE PRODUCTIONS (U.S. CLS. 21, 23, 26, 36 AND 38).

CLASS 35—ADVERTISING AND BUSINESS

FOR ON-LINE RETAIL STORE SERVICES, NAMELY, PRE-RECORDED DISCS, DVDS, AUDIO CASSETTES, VIDEO TAPES, PRINTED MATTER, CLOTHING, JEWELRY, AND GLASS BEVERAGEWARE VIA THE GLOBAL COMPUTER NETWORK (U.S. CLS. 100, 101 AND 102).

SN 76-310,866. L&P PROPERTY MANAGEMENT COMPANY, SOUTH GATE, CA. FILED 9-10-2001.

ANATOM

CLASS 6—METAL GOODS

FOR SPRINGS AND SPRING ASSEMBLIES USED IN SEATING FURNITURE, MATTRESSES AND BOX SPRINGS (U.S. CLS. 2, 12, 13, 14, 23, 25 AND 50).

CLASS 20—FURNITURE AND ARTICLES NOT OTHERWISE CLASSIFIED

FOR SEATING FURNITURE, MATTRESSES AND BOX SPRINGS (U.S. CLS. 2, 13, 22, 25, 32 AND 50).

SN 78-002,468. SHAWNEE STATE UNIVERSITY, PORTSMOUTH, OH. FILED 4-4-2000.

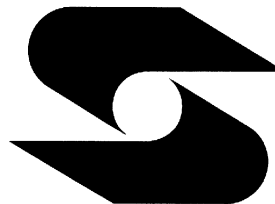

SN 76-313,304. INPHACT, INC., NASHVILLE, TN. FILED 9-11-2001.

PACSESSORIES

CLASS 35—ADVERTISING AND BUSINESS

FOR MANAGEMENT AND BILLING OF RADIOLOGICAL SERVICES, RADIOLOGICAL DATABASE MANAGEMENT (U.S. CLS. 100, 101 AND 102).

CLASS 39—TRANSPORTATION AND STORAGE

FOR ELECTRONIC STORAGE OF RADIOLOGICAL IMAGES (U.S. CLS. 100 AND 105).

CLASS 42—SCIENTIFIC, COMPUTER AND LEGAL SERVICES

FOR X-RAY SERVICES (U.S. CLS. 100 AND 101).

THE MARK CONSISTS OF A STYLIZED LETTER "S".

CLASS 35—ADVERTISING AND BUSINESS

FOR CAREER PLACEMENT (U.S. CLS. 100, 101 AND 102).
FIRST USE 12-31-1986; IN COMMERCE 12-31-1986.

CLASS 41—EDUCATION AND ENTERTAINMENT

FOR EDUCATION SERVICES IN THE NATURE OF COURSES AT THE UNIVERSITY LEVEL; ARRANGING AND CONDUCTING ATHLETIC COMPETITIONS; ARRANGING AND CONDUCTING EDUCATIONAL CONFERENCES (U.S. CLS. 100, 101 AND 107).
FIRST USE 12-31-1986; IN COMMERCE 12-31-1986.

SN 78-002,901. GLOBAL ECOMEX LTD, AUCKLAND, NEW ZEALAND, FILED 4-6-2000.

SN 78-007,282. RING AND PINION SERVICE, INC., EVERETT, WA. FILED 5-8-2000.

ECOMEX

PRIORITY CLAIMED UNDER SEC. 44(D) ON NEW ZEALAND APPLICATION NO. 600268, FILED 10-6-1999, REG. NO. 600268, DATED 10-6-1999, EXPIRES 10-6-2009.

CLASS 35—ADVERTISING AND BUSINESS

FOR ELECTRONIC COMMERCE SERVICES, NAMELY, PROVIDING A WEBSITE FEATURING AUCTION, SALE, AND PURCHASE SERVICES (U.S. CLS. 100, 101 AND 102).

CLASS 36—INSURANCE AND FINANCIAL

FOR ELECTRONIC COMMERCE SERVICES, NAMELY, PROVIDING A WEBSITE FEATURING STOCK AND COMMODITY EXCHANGE SERVICES (U.S. CLS. 100, 101 AND 102).

CLASS 42—SCIENTIFIC, COMPUTER AND LEGAL SERVICES

FOR COMPUTER SERVICES, NAMELY, HOSTING THE WEBSITES OF OTHERS ON A COMPUTER SERVER FOR A GLOBAL COMPUTER NETWORK (U.S. CLS. 100 AND 101).

SN 78-004,952. HEATLEY, JOSEPH, GRANDVIEW, NY. FILED 4-20-2000.

ON THE ROAD AGAIN

CLASS 9—ELECTRICAL AND SCIENTIFIC APPARATUS

FOR PRERECORDED VIDEOTAPES AND DVDS FEATURING CARS AND MOTORCYCLES (U.S. CLS. 21, 23, 26, 36 AND 38).

CLASS 16—PAPER GOODS AND PRINTED MATTER

FOR SERIES OF BOOKS, PAMPHLETS AND MAGAZINES IN THE FIELD OF CARS AND MOTORCYCLES (U.S. CLS. 2, 5, 22, 23, 29, 37, 38 AND 50).

CLASS 25—CLOTHING

FOR CLOTHING, NAMELY, SHIRTS (U.S. CLS. 22 AND 39).

CLASS 41—EDUCATION AND ENTERTAINMENT

FOR ENTERTAINMENT, NAMELY A CONTINUING ADVENTURE/HOW TO/ANTIQUE SHOW DISTRIBUTED OVER TELEVISION AND THE GLOBAL COMPUTER NETWORK (U.S. CLS. 100, 101 AND 107).

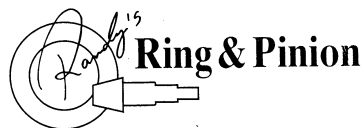

NO CLAIM IS MADE TO THE EXCLUSIVE RIGHT TO USE "RING & PINION" AND THE DESIGN OF THE RING AND PINION, APART FROM THE MARK AS SHOWN.

CLASS 35—ADVERTISING AND BUSINESS

FOR RETAIL STORE SERVICES FEATURING AXLE AND DIFFERENTIAL COMPONENTS TO INCLUDE PINION NUTS, PINION NUT WASHERS, PINION YOKE, PINION FLANGE, DUST SHIELDS, PINION SEALS, SLINGERS, FRONT PINION BEARINGS, FRONT PINION RACES, CRUSH SLEEVES, AXLE HOUSINGS, WHEEL BEARINGS, OUTER AXLE SEALS, AXLES, AXLES STUDS, BACKING PLATE NUTS, BACKING PLATE BOLT, SIDE GEAR THRUST WASHERS, SIDE GEARS, PINION GEARS, PINION GEAR THRUST WASHERS, C-CLIPS, CROSS PIN SHAFTS, CARRIER SHIMS, CARRIER BEARING RACES, CARRIER BEARING CAPS, CARRIER BEARING CAP BOLTS, CARRIER BEARINGS, RING GEAR BOLTS, COVER BOLTS, COVERS, FILL PLUGS, OPEN CARRIER CASES, CROSS PIN BOLTS, RING GEARS, PINION GEARS, RING AND PINION SETS, PINION DEPTH SHIMS, REAR PINION BEARINGS, REAR PINION RACES, BAFFLES, PRE LOAD PLATES, DRIVEN CLUTCHES, DRIVE CLUTCHES, CLUTCH GUIDES, CARRIER CASES, LIMITED SLIP CARRIER CASES, LOCKING DIFFERENTIALS, LIMITED SLIP DIFFERENTIALS, SOLID PINION SPACERS, THIRD MEMBER CASES, SPOOLS, MINI-SPOOLS, COVER GASKETS, ANTILOCK BRAKE SYSTEM EXCITER TONE RINGS, AXLE BEARING RETAINERS, STUB AXLES, SILICONE GASKET SEALANT, PILOT BEARINGS, PINION SUPPORTS, GEAR OILS (U.S. CLS. 100, 101 AND 102).

FIRST USE 1-16-1997; IN COMMERCE 1-16-1997.

CLASS 37—CONSTRUCTION AND REPAIR

FOR INSTALLATION OF AXLE AND DIFFERENTIAL COMPONENTS FOR LAND VEHICLES (U.S. CLS. 100, 103 AND 106).

FIRST USE 1-16-1997; IN COMMERCE 1-16-1997.

SN 78-010,593. BATES, BRUCE M., FREDERICK, MD. FILED 5-31-2000.

NO CLAIM IS MADE TO THE EXCLUSIVE RIGHT TO USE "BIDJET.COM", APART FROM THE MARK AS SHOWN.

CLASS 35—ADVERTISING AND BUSINESS

FOR ONLINE AIRCRAFT AUCTION SERVICES (U.S. CLS. 100, 101 AND 102).

FIRST USE 3-1-1999; IN COMMERCE 4-1-1999.

CLASS 36—INSURANCE AND FINANCIAL

FOR AIRCRAFT BROKERAGE AND FINANCING SERVICES (U.S. CLS. 100, 101 AND 102).
FIRST USE 3-1-1999; IN COMMERCE 4-1-1999.

SN 78-012,618. SISTER PARISH DESIGN, INC., LARCHMONT, NY. FILED 6-14-2000.

SISTER PARISH

THE NAME "SISTER PARISH" DOES NOT IDENTIFY A LIVING INDIVIDUAL.

SN 78-011,245. QUEBECOR WORLD INC., MONTREAL, CANADA, FILED 6-5-2000.

QUE-NET MEDIA

OWNER OF U.S. REG. NO. 2,189,626.
NO CLAIM IS MADE TO THE EXCLUSIVE RIGHT TO USE "MEDIA", APART FROM THE MARK AS SHOWN.

CLASS 35—ADVERTISING AND BUSINESS

FOR RETAIL STORE SERVICES AND ONLINE RETAIL STORE SERVICES FEATURING CUSTOM MADE AUTOMATED PUBLISHING COMPUTER HARDWARE AND SOFTWARE THAT MUST BE SPECIAL ORDERED; COPYRIGHT MANAGEMENT CONSULTATION (U.S. CLS. 100, 101 AND 102).

CLASS 37—CONSTRUCTION AND REPAIR

FOR INSTALLATION AND MAINTENANCE OF COMPUTER HARDWARE SYSTEMS USED IN THE PUBLISHING INDUSTRY; CONSTRUCTION OF STAGE SETS (U.S. CLS. 100, 103 AND 106).

CLASS 38—COMMUNICATION

FOR ELECTRONIC TRANSMISSION OF DATA AND IMAGES VIA ELECTRONIC COMMUNICATION NETWORK (U.S. CLS. 100, 101 AND 104).

CLASS 40—MATERIAL TREATMENT

FOR ELECTRONIC IMAGING, SCANNING, DIGITIZING, ALTERATION AND/OR RETOUCHING OF artwork, IMAGES, EDITORIAL MATERIALS, TEXT, PHOTOGRAPHS, VIDEOS AND GRAPHIC DESIGNS USED IN BOOKS, MAGAZINES, PERIODICALS, NEWSPAPERS, CD-ROMS, MULTIMEDIA CDS (U.S. CLS. 100, 103 AND 106).

CLASS 41—EDUCATION AND ENTERTAINMENT

FOR PUBLICATION OF BOOKS, MAGAZINES, PERIODICALS, NEWSPAPERS, IN PRINT AND ON CDS; AERIAL AND PORTRAIT PHOTOGRAPHY (U.S. CLS. 100, 101 AND 107).

CLASS 42—SCIENTIFIC, COMPUTER AND LEGAL SERVICES

FOR INSTALLATION AND MAINTENANCE OF COMPUTER SOFTWARE USED IN THE PUBLISHING INDUSTRY; DESKTOP PUBLISHING FOR OTHERS; PRINTING SERVICES, NAMELY, TECHNICAL WRITING FOR OTHERS, TYPESETTING AND WRITTEN TEXT EDITING; PHOTOGRAPHIC COMPOSITION FOR OTHERS; CUSTOM DESIGN FOR OTHERS IN THE FIELD OF COMPUTER SOFTWARE AND HARDWARE USED IN THE PUBLISHING INDUSTRY; PROVIDING A WEBSITE ON GLOBAL COMPUTER NETWORKS FEATURING INFORMATION IN THE FIELD OF DESKTOP PUBLISHING AND PRINTING SERVICES; DESIGN FOR OTHERS IN THE FIELD OF STAGE SETS (U.S. CLS. 100 AND 101).

CLASS 20—FURNITURE AND ARTICLES NOT OTHERWISE CLASSIFIED

FOR FURNITURE, NAMELY, LIVING ROOM, BEDROOM AND DINING ROOM FURNITURE; FURNITURE PARTS, NAMELY, CHAIR LEGS, TABLE LEAVES, AND ARM RESTS; HOME FURNISHING ACCESSORIES, NAMELY, PILLOWS AND SHELVES (U.S. CLS. 2, 13, 22, 25, 32 AND 50).

CLASS 24—FABRICS

FOR UPHOLSTERY FABRIC AND CURTAIN FABRIC (U.S. CLS. 42 AND 50).

CLASS 40—MATERIAL TREATMENT

FOR CUSTOM MANUFACTURE OF FURNITURE (U.S. CLS. 100, 103 AND 106).

SN 78-014,306. DUSA PHARMACEUTICALS, INC., WILMINGTON, MA. FILED 6-26-2000.

DUSA

OWNER OF U.S. REG. NO. 1,882,782.

CLASS 5—PHARMACEUTICALS

FOR PHOTODYNAMIC AND PHOTODETECTION PHARMACEUTICAL PREPARATIONS FOR THE TREATMENT OF DERMATOLOGICAL CONDITIONS (U.S. CLS. 6, 18, 44, 46, 51 AND 52).
FIRST USE 5-27-1993; IN COMMERCE 5-27-1993.

CLASS 10—MEDICAL APPARATUS

FOR PHOTOTHERAPEUTIC AND PHOTODIAGNOSTIC APPARATUS FOR MEDICAL PURPOSES FOR USE IN CONJUNCTION WITH PHARMACEUTICAL PRODUCTS AND PREPARATIONS (U.S. CLS. 26, 39 AND 44).
FIRST USE 5-27-1993; IN COMMERCE 5-27-1993.

SN 78-014,379. FREEMEN, IRIS C., MINNEAPOLIS, MN. FILED 6-26-2000.

ALZWELL**CLASS 9—ELECTRICAL AND SCIENTIFIC APPARATUS**

FOR DOWNLOADABLE ELECTRONIC PUBLICATIONS IN THE NATURE OF NEWSLETTERS, INFORMATIONAL BROCHURES, INFORMATIONAL PAMPHLETS AND BOOKS FEATURING INFORMATION ABOUT HEALTH, FITNESS AND WELLNESS PROGRAMS (U.S. CLS. 21, 23, 26, 36 AND 38).

CLASS 16—PAPER GOODS AND PRINTED MATTER

FOR PRINTED NEWSLETTERS AND INFORMATIONAL BROCHURES, INFORMATIONAL PAMPHLETS AND BOOKS FEATURING INFORMATION ABOUT HEALTH, FITNESS AND WELLNESS PROGRAMS (U.S. CLS. 2, 5, 22, 23, 29, 37, 38 AND 50).

CLASS 42—SCIENTIFIC, COMPUTER AND LEGAL SERVICES

FOR COMPUTER SERVICES, NAMELY, PROVIDING ON-LINE NEWSLETTERS, INFORMATIONAL BROCHURES, INFORMATIONAL PAMPHLETS AND BOOKS FEATURING INFORMATION ABOUT HEALTH, FITNESS AND WELLNESS PROGRAMS (U.S. CLS. 100 AND 101).

SN 78-015,333. PRODUCTOS ALIMENTICIOS BOCADELI, S.A. DE C.V., SOYAPANGO, EL SALVADOR, FILED 7-3-2000.

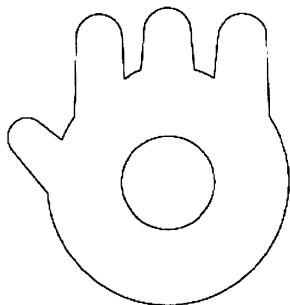

CLASS 29—MEATS AND PROCESSED FOODS

FOR MEAT, FISH POULTRY AND GAME, MEAT EXTRACTS; PRESERVED, DRIED AND COOKED FRUITS AND VEGETABLES; JELLIES, JAMS, FRUIT SAUCES; EGGS, MILK, AND MILK PRODUCTS; EDIBLE OILS AND FATS (U.S. CL. 46).

CLASS 30—STAPLE FOODS

FOR COFFEE, TEA, COCOA, SUGAR, RICE, TAPIOCA, SAGO, ARTIFICIAL COFFEE; FLOUR AND PREPARATIONS MADE FROM CEREALS, BREAD, PASTRY AND CONFECTIONERY, HONEY, TREACLE; YEAST, BAKING-POWDER; SALT, MUSTARD; VINEGAR, SPICES; ICE (U.S. CL. 46).

SN 78-015,336. PRODUCTOS ALIMENTICIOS BOCADELI, S.A. DE C.V., SOYAPANGO, EL SALVADOR, FILED 7-3-2000.

BONGOS

CLASS 29—MEATS AND PROCESSED FOODS

FOR MEAT, FISH, POULTRY AND GAME; MEAT EXTRACTS; PRESERVED, DRIED AND COOKED FRUITS AND VEGETABLES; JELLIES, JAMS, FRUIT SAUCES; EGGS, MILK, AND MILK PRODUCTS; EDIBLE OILS AND FATS (U.S. CL. 46).

CLASS 30—STAPLE FOODS

FOR TEA, COCOA, SUGAR, RICE, TAPIOCA, SAGO, FLOUR AND PREPARATIONS MADE FROM CEREALS, BREAD, PASTRY AND CONFECTIONERY, HONEY, TREACLE; YEAST, BAKING-POWDER; SALT, MUSTARD; VINEGAR, SPICES; ICE (U.S. CL. 46).

SN 78-016,081. SUCCESSFUL MONEY MANAGEMENT SEMINARS, INC., TUALATIN, OR. FILED 7-10-2000.

XTRANET

CLASS 16—PAPER GOODS AND PRINTED MATTER

FOR PRINTED MATERIAL NAMELY A SERIES OF BOOKS, WORKBOOKS, PRINTED FORMS, STATIONERY, PRINTED PAPER SIGNS, PRINTED INSTRUCTIONAL, EDUCATIONAL, AND TEACHING MATERIALS, ALL IN THE FIELD OF PERSONAL FINANCIAL PLANNING (U.S. CLS. 2, 5, 22, 23, 29, 37, 38 AND 50).

FIRST USE 11-30-1999; IN COMMERCE 1-13-2000.

CLASS 41—EDUCATION AND ENTERTAINMENT

FOR EDUCATIONAL SERVICES, NAMELY CONDUCTING WORKSHOPS AND SEMINARS IN THE FIELD OF PERSONAL FINANCIAL PLANNING TO INDIVIDUALS (U.S. CLS. 100, 101 AND 107).

FIRST USE 11-30-1999; IN COMMERCE 1-13-2000.

SN 78-017,192. GE CAPITAL MORTGAGE CORPORATION, RALEIGH, NC. FILED 7-18-2000.

HOMEBUYER PRIVILEGES

NO CLAIM IS MADE TO THE EXCLUSIVE RIGHT TO USE "HOMEBUYER", APART FROM THE MARK AS SHOWN.

CLASS 35—ADVERTISING AND BUSINESS

FOR PROMOTING THE GOODS AND SERVICES OF OTHERS BY ARRANGING FOR SPONSORS TO AFFILIATE THEIR GOODS AND SERVICES WITH HOME MORTGAGE SERVICES; COMPUTERIZED ON-LINE ORDERING SERVICES IN THE FIELD OF HOME IMPROVEMENTS, HOME FURNISHINGS, HOME EQUIPMENT AND APPLIANCES, OFFERED ANCILLARY TO RESIDENTIAL PROPERTY PURCHASES (U.S. CLS. 100, 101 AND 102).

CLASS 36—INSURANCE AND FINANCIAL

FOR ORGANIZING PREFERRED PROVIDER PROGRAMS IN THE FIELD OF HOME IMPROVEMENTS, HOME FURNISHINGS, HOME EQUIPMENT AND APPLIANCES, WHICH ARE OFFERED ANCILLARY TO RESIDENTIAL PROPERTY PURCHASES; ADMINISTRATION OF PREFERRED PROVIDER PROGRAMS IN THE FIELD OF HOME IMPROVEMENTS, HOME FURNISHINGS, HOME EQUIPMENT AND APPLIANCES, WHICH ARE OFFERED ANCILLARY TO RESIDENTIAL PROPERTY PURCHASES (U.S. CLS. 100, 101 AND 102).

SN 78-017,218. INTERNATIONAL DATA GROUP, INC.,
FRAMINGHAM, MA. FILED 7-18-2000.

CLUB DARWIN

NO CLAIM IS MADE TO THE EXCLUSIVE RIGHT TO
USE "CLUB", APART FROM THE MARK AS SHOWN.

CLASS 6—METAL GOODS

FOR METAL KEY CHAINS (U.S. CLS. 2, 12, 13, 14, 23,
25 AND 50).

CLASS 20—FURNITURE AND ARTICLES NOT OTHERWISE CLASSIFIED

FOR NON-METAL KEY CHAINS (U.S. CLS. 2, 13, 22,
25, 32 AND 50).

CLASS 21—HOUSEWARES AND GLASS

FOR MUGS AND CUPS (U.S. CLS. 2, 13, 23, 29, 30, 33,
40 AND 50).

CLASS 25—CLOTHING

FOR CLOTHING NAMELY, T-SHIRTS, KNIT SHIRTS,
DENIM SHIRTS, GOLF SHIRTS, POLO SHIRTS, SWEAT-
SHIRTS, SPORT SHIRTS, SWEATERS AND JACKETS;
HEADGEAR NAMELY, CAPS, HATS AND VISORS;
SHORTS; BOLO TIES; BANDANNAS (U.S. CLS. 22 AND
39).

CLASS 42—SCIENTIFIC, COMPUTER AND LEGAL SERVICES

FOR RESTAURANT, BAR, NIGHTCLUB AND RES-
TAURANT TAKE OUT SERVICES (U.S. CLS. 100 AND
101).

SN 78-017,221. INTERNATIONAL DATA GROUP, INC.,
FRAMINGHAM, MA. FILED 7-18-2000.

DARWIN CAFE

NO CLAIM IS MADE TO THE EXCLUSIVE RIGHT TO
USE "CAFE", APART FROM THE MARK AS SHOWN.

CLASS 6—METAL GOODS

FOR METAL KEY CHAINS (U.S. CLS. 2, 12, 13, 14, 23,
25 AND 50).

CLASS 20—FURNITURE AND ARTICLES NOT OTHERWISE CLASSIFIED

FOR NON-METAL KEY CHAINS (U.S. CLS. 2, 13, 22,
25, 32 AND 50).

CLASS 21—HOUSEWARES AND GLASS

FOR MUGS AND CUPS (U.S. CLS. 2, 13, 23, 29, 30, 33,
40 AND 50).

CLASS 25—CLOTHING

FOR CLOTHING, NAMELY, T-SHIRTS, KNIT SHIRTS,
DENIM SHIRTS, GOLF SHIRTS, POLO SHIRTS, SWEAT-
SHIRTS, SPORT SHIRTS, SWEATERS AND JACKETS;
HEADGEAR NAMELY, CAPS, HATS AND VISORS;
SHORTS; BOLO TIES; BANDANAS (U.S. CLS. 22 AND
39).

CLASS 42—SCIENTIFIC, COMPUTER AND LEGAL SERVICES

FOR RESTAURANT, BAR, NIGHTCLUB AND RES-
TAURANT TAKE OUT SERVICES (U.S. CLS. 100 AND
101).

SN 78-017,263. LAWYERS FOR THE CREATIVE ARTS,
CHICAGO, IL. FILED 7-18-2000.

LAWYERS FOR THE CREATIVE ARTS

SEC. 2(F).

CLASS 35—ADVERTISING AND BUSINESS

FOR LEGAL REFERRAL SERVICES FOR ARTISTS
AND ART ORGANIZATIONS (U.S. CLS. 100, 101 AND
102).

FIRST USE 9-11-1972; IN COMMERCE 9-11-1972.

CLASS 41—EDUCATION AND ENTERTAIN- MENT

FOR WORKSHOPS AND SEMINARS IN THE FIELD
OF LEGAL SERVICES FOR ARTISTS AND ART ORGA-
NIZATIONS (U.S. CLS. 100, 101 AND 107).

FIRST USE 9-11-1972; IN COMMERCE 9-11-1972.

SN 78-017,403. IT'S A GRIND, INC., LONG BEACH, CA.
FILED 7-19-2000.

IT'S A GRIND

NO CLAIM IS MADE TO THE EXCLUSIVE RIGHT TO
USE "COFFEE HOUSE", APART FROM THE MARK AS
SHOWN.

CLASS 30—STAPLE FOODS

FOR COFFEE; COFFEE BEANS; COFFEE-BASED BEV-
ERAGES CONTAINING MILK; COFFEE-BASED BEV-
ERAGES CONTAINING FLAVORED SYRUP; HERB
TEA; ICED TEA; TEA; TEA-BASED BEVERAGES WITH
FRUIT FLAVORING (U.S. CL. 46).

FIRST USE 7-1-1995; IN COMMERCE 7-1-1995.

CLASS 42—SCIENTIFIC, COMPUTER AND LEGAL SERVICES

FOR RESTAURANT SERVICES (U.S. CLS. 100 AND
101).

FIRST USE 7-1-1995; IN COMMERCE 7-1-1995.

SN 78-017,472. KIDVID, INC., ALPHARETTA, GA. FILED 7-19-2000.

BILINGUAL BABY

OWNER OF U.S. REG. NO. 2,383,567.
SEC. 2(F).

CLASS 16—PAPER GOODS AND PRINTED MATTER

FOR CALENDARS, BABY AND CHILDREN'S BOOKS, SHEET MUSIC, PHOTO AND SCRAPBOOK ALBUMS, STATIONERY, GIFT WRAPPING PAPER, ARTS AND CRAFTS PAINT KITS, MARKERS, CRAYONS, PENS, PENCILS, STICKERS, RUBBER STAMPS, STAMP PADS, CRAFT PAPER, PENCIL BOXES, AND PRINTED TEACHING MATERIALS FOR TEACHING INFANTS AND CHILDREN FOREIGN LANGUAGE SKILLS (U.S. CLS. 2, 5, 22, 23, 29, 37, 38 AND 50).

CLASS 28—TOYS AND SPORTING GOODS

FOR GAMES, PLAYTHINGS AND EDUCATIONAL TOYS ALL FOR INFANTS AND CHILDREN, NAMELY BABY RATTLES, RIDE-ON TOYS, ACTION TOYS, SANDBOX TOYS, PLUSH TOYS, SQUEEZE TOYS, WIND-UP TOYS, MUSICAL TOYS, CRIB TOYS, BATH TOYS, TOY MOBILES, BABY MULTIPLE ACTIVITY TOYS, BOARD GAMES, CARD GAMES, STUFFED ANIMALS, FINGER PAINTS, WATER WING SWIM AIDS FOR RECREATIONAL USE, KICK BOARD FLOTATION DEVICES FOR RECREATIONAL USE, INFLATABLE INNER TUBES FOR AQUATIC RECREATIONAL USE, AND CUBE, MANIPULATIVE AND JIGSAW PUZZLES (U.S. CLS. 22, 23, 38 AND 50).

SN 78-017,820. SONGWRITERS IN THE ROUND, PRIMM SPRINGS, TN. FILED 7-21-2000.



HIT SONGWRITER PERFORMANCES

NO CLAIM IS MADE TO THE EXCLUSIVE RIGHT TO USE "SONGWRITERS IN THE ROUND" AND "HIT SONGWRITER PERFORMANCES", APART FROM THE MARK AS SHOWN.

CLASS 9—ELECTRICAL AND SCIENTIFIC APPARATUS

FOR PRERECORDED VIDEO CASSETTES, PRERECORDED VIDEO TAPES, VIDEO DISCS, AUDIO CASSETTES, AUDIO DIGITAL TAPES AND AUDIO DISCS ALL FEATURING PROFESSIONAL SONGWRITER MUSICAL PERFORMANCES, INSTRUCTIONAL COURSES ON PROFESSIONAL SONG WRITING, AND PERSONAL INTERVIEWS WITH PROFESSIONAL SONGWRITERS, RECORDING ARTIST, RECORDING PRODUCERS AND INDUSTRY EXECUTIVES (U.S. CLS. 21, 23, 26, 36 AND 38).

FIRST USE 10-2-1994; IN COMMERCE 10-2-1994.

CLASS 21—HOUSEWARES AND GLASS

FOR (BASED ON 1(B) INTEND -TO-USE) CUPS, MUGS AND COFFEE CUPS (U.S. CLS. 2, 13, 23, 29, 30, 33, 40 AND 50).

CLASS 25—CLOTHING

FOR (BASED ON 1(B) INTEND-TO-USE) CLOTHING, NAMELY, BASEBALL CAPS, SHIRTS, GOLF SHIRTS, JACKETS, SWEATSHIRTS AND T-SHIRTS (U.S. CLS. 22 AND 39).

CLASS 41—EDUCATION AND ENTERTAINMENT

FOR ENTERTAINMENT, NAMELY, PRODUCTION OF TELEVISION SHOWS; ENTERTAINMENT, NAMELY, LIVE MUSICAL CONCERTS; AND COMPUTER SERVICES, NAMELY, PROVIDING ON-LINE INFORMATION AND EDUCATIONAL INFORMATION IN THE FIELD OF SONGWRITING (U.S. CLS. 100, 101 AND 107).
FIRST USE 10-2-1994; IN COMMERCE 10-2-1994.

SN 78-018,407. GLASGOW, JINAN, RALEIGH, NC. FILED 7-26-2000.

SPORE

CLASS 35—ADVERTISING AND BUSINESS

FOR BUSINESS MANAGEMENT CONSULTING AND INCUBATOR SERVICES, NAMELY THE DEVELOPMENT AND EXECUTION OF BUSINESS PLANS, MARKETING AND COMMUNICATION PLANS, STRATEGIES AND DISTRIBUTION PLANS, AND STRATEGIES AND BUSINESS CONSULTATION IN THE FIELD OF BRAND POSITIONING, STAFFING, BUSINESS AND MARKET RESEARCH, COMPETITIVE ANALYSIS, AND PUBLIC RELATIONS (U.S. CLS. 100, 101 AND 102).

CLASS 42—SCIENTIFIC, COMPUTER AND LEGAL SERVICES

FOR INTELLECTUAL PROPERTY CONSULTING SERVICES (U.S. CLS. 100 AND 101).

SN 78-019,060. TRANSCOMPUTING INTERNATIONAL CORPORATION, DBA SEEUTHERE.COM, MOUNTAIN VIEW, CA. FILED 7-31-2000.

SEEUTHERE

CLASS 9—ELECTRICAL AND SCIENTIFIC APPARATUS

FOR COMPUTER SOFTWARE FOR USE IN INTERPERSONAL PRODUCTIVITY APPLICATIONS, NAMELY, PERSONAL AND GROUP ORGANIZERS AND EVENT COORDINATION SOFTWARE (U.S. CLS. 21, 23, 26, 36 AND 38).
FIRST USE 4-1-1999; IN COMMERCE 9-1-1999.

CLASS 35—ADVERTISING AND BUSINESS

FOR ONLINE RETAIL STORE SERVICES FEATURING TICKETS FOR EVENTS; PROVIDING ADVERTISING FOR OTHERS VIA AN ONLINE ELECTRONIC COMMUNICATIONS NETWORK (U.S. CLS. 100, 101 AND 102).
FIRST USE 4-1-1999; IN COMMERCE 9-1-1999.

CLASS 42—SCIENTIFIC, COMPUTER AND LEGAL SERVICES

FOR PROVIDING USE OF ON-LINE COMPUTER SOFTWARE FOR USE IN INTERPERSONAL PRODUCTIVITY APPLICATIONS, NAMELY, PERSONAL AND GROUP ORGANIZERS AND EVENT COORDINATION SOFTWARE (U.S. CLS. 100 AND 101).

FIRST USE 4-1-1999; IN COMMERCE 9-1-1999.

SN 78-019,647. TOXLAB.COM, INC., TOPANGA, CA. FILED 8-3-2000.

TOXMANAGER

SN 78-019,120. REDSCHLAG, OLIVER, HANNOVER, FED REP GERMANY, FILED 8-1-2000.

BIOGLIDE

OWNER OF FED REP GERMANY REG. NO. 39945400, DATED 11-1-1999, EXPIRES 7-31-2009.

CLASS 3—COSMETICS AND CLEANING PREPARATIONS

FOR MASSAGE ARTICLES, NAMELY MASSAGE FACILITATING LUBRICANTS (U.S. CLS. 1, 4, 6, 50, 51 AND 52).

FIRST USE 1-9-1996; IN COMMERCE 6-17-1999.

CLASS 5—PHARMACEUTICALS

FOR PHARMACEUTICAL PREPARATIONS, NAMELY CONTRACEPTIVE AGENTS, SPERMICIDAL GELS, LIQUID OR CREAMS, SEXUAL LUBRICANTS, AND ELECTROMEDICAL ASSISTANTS IN THE NATURE OF CREAMS, GELS AND LOTIONS (U.S. CLS. 6, 18, 44, 46, 51 AND 52).

FIRST USE 1-9-1996; IN COMMERCE 6-17-1999.

CLASS 10—MEDICAL APPARATUS

FOR HYGIENIC RUBBER ARTICLES, NAMELY, CONDOMS AND VIBRATORS FROM RUBBER AND RUBBERLIKE MATERIALS (U.S. CLS. 26, 39 AND 44).

FIRST USE 1-9-1996; IN COMMERCE 6-17-1999.

SN 78-019,612. TRAVELWAYS, INC., WAYZATA, MN. FILED 8-3-2000.

TRAVEL BEYOND

OWNER OF U.S. REG. NO. 1,764,929.
NO CLAIM IS MADE TO THE EXCLUSIVE RIGHT TO USE "TRAVEL", APART FROM THE MARK AS SHOWN.

CLASS 39—TRANSPORTATION AND STORAGE

FOR TRAVEL AGENCY SERVICES, NAMELY, MAKING RESERVATIONS AND BOOKINGS FOR TRANSPORTATION; TRAVEL BOOKING AGENCIES; TRAVEL GUIDE SERVICES; TRAVEL INFORMATION SERVICES; ARRANGING TRAVEL TOURS (U.S. CLS. 100 AND 105).

FIRST USE 0-0-1992; IN COMMERCE 0-0-1992.

CLASS 42—SCIENTIFIC, COMPUTER AND LEGAL SERVICES

FOR TRAVEL AGENCY SERVICES, NAMELY, MAKING RESERVATIONS AND BOOKING FOR TEMPORARY LODGING (U.S. CLS. 100 AND 101).

FIRST USE 0-0-1992; IN COMMERCE 0-0-1992.

CLASS 38—COMMUNICATION

FOR COMMUNICATION SERVICES, NAMELY, PROVIDING ELECTRONIC TRANSMISSION OF MESSAGES, COMPUTER FILES, AND DATA RELATED TO SCIENTIFIC TOXICOLOGY EXPERIMENTS, STUDIES, OR PROTOCOLS (U.S. CLS. 100, 101 AND 104).

CLASS 39—TRANSPORTATION AND STORAGE

FOR ELECTRONIC STORAGE OF DATA CONCERNING SCIENTIFIC TOXICOLOGY EXPERIMENTS, STUDIES, OR PROTOCOLS (U.S. CLS. 100 AND 105).

CLASS 42—SCIENTIFIC, COMPUTER AND LEGAL SERVICES

FOR PROVIDING TEMPORARY USE OF ONLINE NON-DOWNLOADABLE WEB-ENABLED SOFTWARE FOR PROVIDING INFORMATION ON SCIENTIFIC TOXICOLOGY EXPERIMENTS, STUDIES, OR PROTOCOLS AND TOOLS FOR ANALYSIS OF SUCH INFORMATION (U.S. CLS. 100 AND 101).

SN 78-019,916. ROSEN HOTELS AND RESORTS, INC., ORLANDO, FL. FILED 8-7-2000.

ORLANDOHOTELS4LESS.COM**CLASS 39—TRANSPORTATION AND STORAGE**

FOR PROVIDING TOURIST INFORMATION VIA THE GLOBAL COMPUTER NETWORK (U.S. CLS. 100 AND 105).

FIRST USE 8-0-2000; IN COMMERCE 8-0-2000.

CLASS 42—SCIENTIFIC, COMPUTER AND LEGAL SERVICES

FOR MAKING HOTEL RESERVATIONS FOR OTHERS VIA THE GLOBAL COMPUTER NETWORK (U.S. CLS. 100 AND 101).

FIRST USE 8-0-2000; IN COMMERCE 8-0-2000.

SN 78-020,698. ZIRE, INC., NEW YORK, NY. FILED 8-11-2000.



CLASS 25—CLOTHING

FOR CLOTHING APPAREL, NAMELY, PANTS, PULL-OVERS, TOPS, JACKETS, T-SHIRTS, HEADWEAR, HOODS AND BASEBALL HATS (U.S. CLS. 22 AND 39).

CLASS 35—ADVERTISING AND BUSINESS

FOR RETAIL STORES FEATURING CLOTHING APPAREL, NAMELY, PANTS, PULLOVERS, TOPS, JACKETS, T-SHIRTS, HEADWEAR, HOODS AND BASEBALL HATS; MAIL ORDER CATALOG SERVICES FEATURING CLOTHING APPAREL, NAMELY, PANTS, PULL-OVERS, TOPS, JACKETS, T-SHIRTS, HEADWEAR, HOODS AND BASEBALL HATS (U.S. CLS. 100, 101 AND 102).

SN 78-021,567. RETAILDNA, LLC, STAMFORD, CT. FILED 8-17-2000.

BORDER DEAL

NO CLAIM IS MADE TO THE EXCLUSIVE RIGHT TO USE "BORDER", APART FROM THE MARK AS SHOWN.

CLASS 9—ELECTRICAL AND SCIENTIFIC APPARATUS

FOR COMPUTER HARDWARE AND COMPUTER SOFTWARE FOR UPDATING POINT-OF-SALE DATA, FOR REMOTE ORDERING, AND FOR PROVIDING INCENTIVES TO CONSUMERS AND EMPLOYEES, IMPROVING SERVICE TO CONSUMERS, AND INCREASING SALES OF PRODUCT BY ENCOURAGING CONSUMERS TO PURCHASE ADDITIONAL ITEMS, USED IN CONNECTION WITH ACTUAL RETAIL TRANSACTIONS, ON-LINE RETAIL TRANSACTIONS, CASH REGISTER AND VENDING MACHINE SYSTEMS AT RETAIL STORES, FAST FOOD OUTLETS AND CONVENIENCE FOOD OUTLETS; COMPUTER OPERATING PROGRAMS FOR POINT-OF-SALE TERMINALS; AND REMOTE ORDERING SYSTEMS COMPRISING CASH REGISTERS, ELECTRONIC SCANNERS, COMPUTER TERMINALS, MODEMS, AND VOICE RECOGNITION ANALYZERS (U.S. CLS. 21, 23, 26, 36 AND 38).

CLASS 35—ADVERTISING AND BUSINESS

FOR LICENSING OF COMPUTER SOFTWARE AND HARDWARE, DISSEMINATION OF ADVERTISING FOR OTHERS VIA DIRECT MAIL AND ON-LINE VIA THE GLOBAL COMPUTER NETWORK; CUSTOMER RELATIONS SERVICES, NAMELY, CUSTOMER RETENTION AND LOYALTY PROGRAMS IN THE RETAIL INDUSTRY; AND PROVIDING ON-LINE INFORMATION TO OTHERS ABOUT POINT-OF-SALE AND CUSTOMER RETENTION PROGRAM DATA, ALL VIA GLOBAL, WIDE AREA AND LOCAL AREA COMPUTER NETWORKS (U.S. CLS. 100, 101 AND 102).

CLASS 38—COMMUNICATION

FOR ELECTRONIC TRANSMISSION OF POINT-OF-SALE AND CUSTOMER RETENTION PROGRAM DATA VIA A GLOBAL COMPUTER NETWORK; AND ELECTRONIC TRANSMISSION OF POINT-OF-SALE AND CUSTOMER RETENTION PROGRAM DATA VIA LOCAL COMPUTER NETWORK (U.S. CLS. 100, 101 AND 104).

CLASS 42—SCIENTIFIC, COMPUTER AND LEGAL SERVICES

FOR COMPUTER SERVICES, NAMELY, COMPUTER CONSULTING, DATABASE DEVELOPMENT, DESIGN AND DEVELOPMENT OF SOFTWARE APPLICATIONS FOR OTHERS, CREATING WEB SITES FOR OTHERS AND LICENSING OF INTELLECTUAL PROPERTY (U.S. CLS. 100 AND 101).

SN 78-022,167. BITTIME.COM, MIAMI, FL. FILED 8-21-2000.



THE MARK CONSISTS OF THE STYLIZED LETTER "T" IS RED (PANTONE 137 CV); THE INNER OUTLINE OF THE "T" IS BLACK; THE OUTER OUTLINE OF THE "T" IS BLUE (PANTONE 307 CV); THE INNER TWO CIRCLES ARE BLUE (PANTONE 307 CV 50%); THE THIRD CIRCLE IS BLUE (PANTONE 307 CV); AND THE OUTER CIRCLE IS BLUE (PANTONE 307 CV) WITH A GREEN (PANTONE 377 CV) BORDER.

CLASS 35—ADVERTISING AND BUSINESS

FOR PROMOTING THE GOODS AND SERVICES OF OTHERS IN AN ONLINE INCENTIVE MARKETING SOLUTIONS PROGRAM (U.S. CLS. 100, 101 AND 102).
FIRST USE 1-1-2000; IN COMMERCE 1-1-2000.

CLASS 36—INSURANCE AND FINANCIAL

FOR PROCESSING ONLINE ELECTRONIC DEBIT AND CREDIT TRANSACTIONS, VIA AN ONLINE ELECTRONIC COMMUNICATIONS NETWORK (U.S. CLS. 100, 101 AND 102).
FIRST USE 1-1-2000; IN COMMERCE 1-1-2000.

SN 78-023,474. FUSCIENT, LLC, HARTFORD, CT. FILED 8-29-2000.

SN 78-027,165. CSD, LLC, LOS ANGELES, CA. FILED 9-22-2000.

FUSCIENT

CLASS 9—ELECTRICAL AND SCIENTIFIC APPARATUS

FOR COMPUTER HARDWARE; COMPUTER SOFTWARE FOR CREATING DISTRIBUTED COMPUTING ENVIRONMENTS; ELECTRONIC COMMERCE SYSTEMS, INFORMATION MANAGEMENT SYSTEMS, AND COMMUNICATIONS NETWORKS FOR CUSTOMER RELATIONSHIP MANAGEMENT, SALES FORCE AUTOMATION, AND ENTERPRISE DATABASES (U.S. CLS. 21, 23, 26, 36 AND 38).

FIRST USE 8-25-1999; IN COMMERCE 1-1-2000.

CLASS 35—ADVERTISING AND BUSINESS

FOR BUSINESS CONSULTATION SERVICES IN THE FIELD OF ELECTRONIC COMMERCE; BUSINESS PROCESS RE-ENGINEERING SERVICES (U.S. CLS. 100, 101 AND 102).

FIRST USE 8-25-1999; IN COMMERCE 8-30-1999.

CLASS 42—SCIENTIFIC, COMPUTER AND LEGAL SERVICES

FOR CONSULTING SERVICES IN THE FIELDS OF INFORMATION TECHNOLOGY, COMPUTER SOFTWARE DEVELOPMENT AND COMPUTER NETWORKING (U.S. CLS. 100 AND 101).

FIRST USE 8-25-1999; IN COMMERCE 8-30-1999.

SN 78-026,898. WIDEVINE TECHNOLOGIES, INC., BELLEVUE, WA. BY ASSIGNMENT INTERNET DIRECT MEDIA, INC., BELLEVUE, WA. FILED 9-20-2000.

WIDEVINE

CLASS 9—ELECTRICAL AND SCIENTIFIC APPARATUS

FOR WEB SEARCH ENGINE SOFTWARE FOR MEDIA CONTENT INFRINGEMENTS; ENCRYPTION SOFTWARE FOR PROVIDING SECURED WEB DISTRIBUTION OF MEDIA CONTENT AND INFORMATION FOR MEDIA CONTENT PROVIDERS RETAILERS AND OTHER BUSINESSES (U.S. CLS. 21, 23, 26, 36 AND 38).

FIRST USE 12-24-2000; IN COMMERCE 12-24-2000.

CLASS 42—SCIENTIFIC, COMPUTER AND LEGAL SERVICES

FOR SOFTWARE INSTALLATION, DESIGN AND MAINTENANCE FOR SOFTWARE IN THE FIELDS OF ENCRYPTION OF MEDIA CONTENT, COMPUTER SEARCH ENGINE SOFTWARE FOR WEB MEDIA CONTENT INFRINGEMENTS AND EFFICIENT WEB DISTRIBUTION OF INFORMATION, ALL FOR MEDIA CONTENT PROVIDERS, RETAILERS AND OTHER BUSINESSES (U.S. CLS. 100 AND 101).

FIRST USE 9-0-2000; IN COMMERCE 9-0-2000.

WAKING BORN

CLASS 35—ADVERTISING AND BUSINESS

FOR OFFERING ONLINE RETAIL SERVICES FEATURING PRE-RECORDED MUSIC ON CD ROM, DVD, AND OTHER PHYSICAL AND ELECTRONIC SYSTEMS BY MEANS OF DOWNLOADABLE SOFTWARE ON THE INTERNET (U.S. CLS. 100, 101 AND 102).

CLASS 41—EDUCATION AND ENTERTAINMENT

FOR MUSIC COMPOSITION FOR OTHER; ENTERTAINMENTS IN THE NATURE OF LIVE PERFORMANCES BY A MUSICAL BAND, RECORD AND/OR VIDEOTAPE PRODUCTION SERVICES (U.S. CLS. 100, 101 AND 107).

SN 78-029,767. BAYER CORPORATION, ELKHART, IN. FILED 10-9-2000.

HOME HEALTH

CLASS 5—PHARMACEUTICALS

FOR INSECTICIDES AND INSECT BAITS FOR DOMESTIC AND OTHER STRUCTURAL AND PROFESSIONAL USE (U.S. CLS. 6, 18, 44, 46, 51 AND 52).

CLASS 9—ELECTRICAL AND SCIENTIFIC APPARATUS

FOR ELECTRONIC VIDEO AND COMPUTER MONITORS FOR INSECT BAIT CONTAINERS (U.S. CLS. 21, 23, 26, 36 AND 38).

CLASS 21—HOUSEWARES AND GLASS

FOR NON-METAL CONTAINERS FOR USE AS INSECT BAIT HOLDERS (U.S. CLS. 2, 13, 23, 29, 30, 33, 40 AND 50).

CLASS 36—INSURANCE AND FINANCIAL

FOR PROVIDING EXTENDED WARRANTY CONTRACTS AGAINST DAMAGES ON HOUSES AND OTHER STRUCTURES (U.S. CLS. 100, 101 AND 102).

SN 78-033,559. AT&T CORP., NEW YORK, NY. FILED 11-2-2000.

VENTARIS

CLASS 35—ADVERTISING AND BUSINESS

FOR ADVERTISING SERVICES, NAMELY, PROVIDING A SEARCHABLE DATABASE FEATURING THE GOODS AND SERVICES OF OTHERS IN THE FIELD OF FINANCE, INSURANCE, BANKING, REAL ESTATE AND VEHICLES (U.S. CLS. 100, 101 AND 102).

CLASS 36—INSURANCE AND FINANCIAL

FOR BILL PAYMENT SERVICES, INCLUDING PAYMENT PROCESSING, BY MEANS OF A GLOBAL COMPUTER NETWORK, BY MAIL, COURIER, TELEPHONE AND FACSIMILE; PROVIDING INFORMATION IN CONNECTION WITH MORTGAGES AND RELATED FINANCIAL SERVICES; PROVIDING INFORMATION FROM MORTGAGE PROVIDERS TO CUSTOMERS BY MEANS OF A GLOBAL COMPUTER NETWORK, BY MAIL, COURIER, TELEPHONE AND FACSIMILE; PROVIDING AN ON-LINE COMPUTERIZED DATABASE IN THE FIELDS OF FINANCE, BANKING, REAL ESTATE AND AUTOMOBILE FINANCING; MONETARY EXCHANGE; CREDIT CARD SERVICES; DEBIT CARD SERVICES; CHARGE CARD SERVICES; CREDIT CARD SERVICES BY MEANS OF ELECTRONIC COMMUNICATION NETWORK; FACTORING AGENCIES; CREDIT CARD SERVICING OF CONSUMER RECEIVABLES ASSOCIATED THEREWITH; COMMERCIAL LENDING SERVICES; SERVICING LOANS AND EXTENSION OF CREDIT; REAL ESTATE LENDING SERVICES; MORTGAGE LENDING AND MORTGAGE SERVICING; INVESTMENT ADVISORY AND FINANCIAL ADVISORY SERVICES; VENTURE CAPITAL INVESTMENTS; MAKING EQUITY AND DEBT INVESTMENTS IN CORPORATIONS OR PARTNERSHIPS; ISSUANCE AND REDEMPTION OF TRAVELER'S CHECKS; PROVIDING FINANCIAL INFORMATION AND OTHER INFORMATION RELEVANT TO FINANCIAL MARKETS BY ELECTRONIC MEANS; FOREIGN CURRENCY EXCHANGE AND FINANCIAL TRADING SERVICES FOR OTHERS BY ELECTRONIC MEANS (U.S. CLS. 100, 101 AND 102).

CLASS 39—TRANSPORTATION AND STORAGE

FOR PROVIDING AN ON-LINE COMPUTERIZED DATABASE IN THE FILED OF AUTOMOBILE LEASING (U.S. CLS. 100 AND 105).

SN 78-034,142. CODIGITAL LIMITED, HENLEY ON THAMES OXFORDSHIRE, UNITED KINGDOM, FILED 11-7-2000.

DREAMZONE

PRIORITY CLAIMED UNDER SEC. 44(D) ON UNITED KINGDOM APPLICATION NO. 2250438, FILED 10-28-2000, REG. NO. 2250438, DATED 10-28-2000, EXPIRES 10-28-2010.

PRIORITY CLAIMED UNDER SEC. 44(D) ON UNITED KINGDOM APPLICATION NO. 2250438, FILED 10-28-2000, REG. NO. 2250438, DATED 10-28-2000, EXPIRES 10-28-2010.

PRIORITY CLAIMED UNDER SEC. 44(D) ON UNITED KINGDOM APPLICATION NO. 2250438, FILED 10-28-2000, REG. NO. 2250438, DATED 10-28-2000, EXPIRES 10-28-2010.

PRIORITY CLAIMED UNDER SEC. 44(D) ON UNITED KINGDOM APPLICATION NO. 2250438, FILED 10-28-2000, REG. NO. 2250438, DATED 10-28-2000, EXPIRES 10-28-2010.

CLASS 35—ADVERTISING AND BUSINESS

FOR PROVIDING ADVERTISING FOR OTHERS VIA ONLINE ELECTRONIC COMMUNICATIONS NETWORK AND PROMOTING THE GOODS AND SERVICES OF OTHERS THROUGH PROMOTIONAL CONTESTS (U.S. CLS. 100, 101 AND 102).

CLASS 38—COMMUNICATION

FOR PROVIDING ONLINE ELECTRONIC BULLETIN BOARDS, FORUMS AND CHAT ROOMS FOR TRANSMISSION OF MESSAGES AMONG COMPUTER USERS CONCERNING TOPICS OF GENERAL INTEREST (U.S. CLS. 100, 101 AND 104).

CLASS 41—EDUCATION AND ENTERTAINMENT

FOR PROVIDING ONLINE INTERACTIVE GAMES AND PRESENTATIONS FOR EDUCATIONAL AND ENTERTAINMENT PURPOSES (U.S. CLS. 100, 101 AND 107).

CLASS 42—SCIENTIFIC, COMPUTER AND LEGAL SERVICES

FOR COMPUTER SERVICES, NAMELY, HOSTING THE WEB SITES OF OTHERS ON A COMPUTER SERVER FOR A GLOBAL COMPUTER NETWORK; CREATING AND MAINTAINING WEBSITES FOR OTHERS; PROVIDING NEWS AND INFORMATION ABOUT TOPICS OF GENERAL INTEREST THROUGH A GLOBAL COMPUTER NETWORK (U.S. CLS. 100 AND 101).

SN 78-034,143. CODIGITAL LIMITED, HENLEY ON THAMES, UNITED KINGDOM, FILED 11-7-2000.

GENEZONE

PRIORITY CLAIMED UNDER SEC. 44(D) ON UNITED KINGDOM APPLICATION NO. 2250437, FILED 10-28-2000, REG. NO. 2250437, DATED 10-28-2000, EXPIRES 10-28-2010.

PRIORITY CLAIMED UNDER SEC. 44(D) ON UNITED KINGDOM APPLICATION NO. 2250437, FILED 10-28-2000, REG. NO. 2250437, DATED 10-28-2000, EXPIRES 10-28-2010.

PRIORITY CLAIMED UNDER SEC. 44(D) ON UNITED KINGDOM APPLICATION NO. 2250437, FILED 10-28-2000, REG. NO. 2250437, DATED 10-28-2000, EXPIRES 10-28-2010.

PRIORITY CLAIMED UNDER SEC. 44(D) ON UNITED KINGDOM APPLICATION NO. 2250437, FILED 10-28-2000, REG. NO. 2250437, DATED 10-28-2000, EXPIRES 10-28-2010.

CLASS 35—ADVERTISING AND BUSINESS

FOR PROVIDING ADVERTISING FOR OTHERS VIA ONLINE ELECTRONIC COMMUNICATIONS NETWORK AND PROMOTING THE GOODS AND SERVICES OF OTHERS THROUGH PROMOTIONAL CONTESTS (U.S. CLS. 100, 101 AND 102).

CLASS 38—COMMUNICATION

FOR PROVIDING ONLINE ELECTRONIC BULLETIN BOARDS, FORUMS AND CHAT ROOMS FOR TRANSMISSION OF MESSAGES AMONG COMPUTER USERS CONCERNING TOPICS OF GENERAL INTEREST (U.S. CLS. 100, 101 AND 104).

CLASS 41—EDUCATION AND ENTERTAINMENT

FOR PROVIDING ONLINE INTERACTIVE GAMES AND PRESENTATIONS FOR EDUCATIONAL AND ENTERTAINMENT PURPOSES (U.S. CLS. 100, 101 AND 107).

CLASS 42—SCIENTIFIC, COMPUTER AND LEGAL SERVICES

FOR COMPUTER SERVICES, NAMELY, HOSTING THE WEB SITES OF OTHERS ON A COMPUTER SERVER FOR A GLOBAL COMPUTER NETWORK; CREATING AND MAINTAINING WEBSITES FOR OTHERS; PROVIDING NEWS AND INFORMATION ABOUT TOPICS OF GENERAL INTEREST THROUGH A GLOBAL COMPUTER NETWORK (U.S. CLS. 100 AND 101).

SN 78-036,822. FELLOWSHIP OF FAITH MINISTRY, INC., ORLANDO, FL. FILED 11-28-2000.

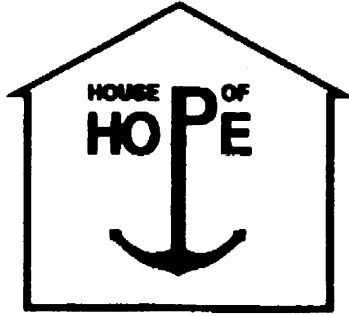

NO CLAIM IS MADE TO THE EXCLUSIVE RIGHT TO USE OF THE WORD "HOUSE", APART FROM THE MARK AS SHOWN.

CLASS 41—EDUCATION AND ENTERTAINMENT

FOR EDUCATIONAL SERVICES, NAMELY PROVIDING TO PARENTS AND TEENAGERS FAITH-BASED COURSES OF INSTRUCTION, ON-GOING SCHOOLING, AND GUIDANCE ON PARENTING AND LIFE SKILLS AND DISSEMINATING COURSE MATERIAL IN CONNECTION THEREWITH (U.S. CLS. 100, 101 AND 107). FIRST USE 9-1-1985; IN COMMERCE 9-1-1985.

CLASS 42—SCIENTIFIC, COMPUTER AND LEGAL SERVICES

FOR FAITH-BASED RESIDENTIAL CARE FACILITIES, NAMELY, PROVIDING TROUBLED TEENAGERS AND THEIR PARENTS WITH COUNSELING, INFORMATION ON LIVING SKILLS, AND PROVIDING GUIDANCE AND COUNSELING TO FOSTER AND ADDRESS THEIR EMOTIONAL, SPIRITUAL, SOCIAL, EDUCATIONAL, MENTAL AND PHYSICAL GROWTH (U.S. CLS. 100 AND 101). FIRST USE 9-1-1985; IN COMMERCE 9-1-1985.

SN 78-038,343. LAVA TRADING INC., NEW YORK, NY. FILED 12-8-2000.

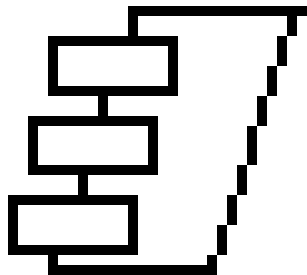

CLASS 9—ELECTRICAL AND SCIENTIFIC APPARATUS

FOR COMPUTER SOFTWARE TO ACCESS AND EXECUTE ELECTRONIC TRANSACTIONS ON THE FINANCIAL SECURITIES MARKETS VIA THE INTERNET (U.S. CLS. 21, 23, 26, 36 AND 38). FIRST USE 5-5-1999; IN COMMERCE 11-6-2000.

CLASS 36—INSURANCE AND FINANCIAL

FOR ELECTRONIC SECURITIES TRADING SERVICES (U.S. CLS. 100, 101 AND 102). FIRST USE 5-5-1999; IN COMMERCE 11-6-1200.

SN 78-039,457. YAKIRA L.L.C., SOUTH RIVER, NJ. FILED 12-15-2000.

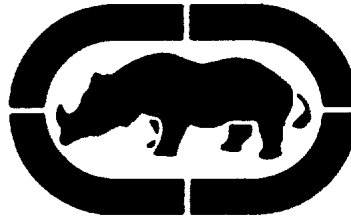

OWNER OF U.S. REG. NOS. 2,262,748, 2,262,749 AND 2,420,404.

CLASS 3—COSMETICS AND CLEANING PREPARATIONS

FOR FRAGRANCES AND TOILETRIES, NAMELY, PERFUME, BATH GEL, BATH OIL, BATH POWDER AND BATH SALTS, SOAPS, BODY DEODORANTS, ESSENTIAL OILS; COSMETICS, NAMELY, CREAMS, LOTIONS, GELS AND POWDER FOR THE FACE BODY AND HANDS, SUN CARE PREPARATIONS, MAKE-UP PREPARATIONS; SHAMPOOS, GELS, SPRAYS, MOUSSES AND BALMS FOR HAIR STYLING AND HAIR CARE AND HAIR CARE PREPARATIONS (U.S. CLS. 1, 4, 6, 50, 51 AND 52).

CLASS 9—ELECTRICAL AND SCIENTIFIC APPARATUS

FOR EYEWEAR, NAMELY, EYEGLASSES, EYEGLASS CASES, SUNGLASSES, AND RELATED PARTS AND ACCESSORIES (U.S. CLS. 21, 23, 26, 36 AND 38).

CLASS 14—JEWELRY

FOR TIMEPIECES, NAMELY, WATCHES, POCKET WATCHES AND WATCH STRAPS, CLOCKS, WALL CLOCKS; PARTS AND ACCESSORIES FOR WATCHES; JEWELRY, PRECIOUS AND SEMI-PRECIOUS GEMSTONES, CUSTOM JEWELRY, MONEY CLIPS OF PRECIOUS METAL, CANDLE HOLDERS AND CANDLESTICKS OF PRECIOUS METAL, CIGARETTE CASES OF PRECIOUS METAL, AND BELT BUCKLES OF PRECIOUS METAL (U.S. CLS. 2, 27, 28 AND 50).

CLASS 18—LEATHER GOODS

FOR BAGS, NAMELY, ALL PURPOSE ATHLETIC BAGS, BACKPACKS, BEACH BAGS, BOOK BAGS, SCHOOL BAGS, DIAPER BAGS, DUFFEL BAGS, GYM BAGS, SHOPPING BAGS, OVERNIGHT BAGS, SCHOOL BAGS, SHOULDER BAGS, PURSES, TOTE BAGS, TRAVEL BAGS, AND GARMENT BAGS FOR TRAVEL, MADE OF LEATHER OR NON-LEATHER MATERIALS; SMALL LEATHER GOODS, NAMELY, WALLETS, WALLETS WITH ARM BANDS, WALLETS WITH STRAPS (U.S. CLS. 1, 2, 3, 22 AND 41).

SN 78-039,695. CHINA MIST TEA COMPANY, SCOTTSDALE, AZ. FILED 12-18-2000.

CHINA MIST RELIEF FROM GLOBAL WARMING

OWNER OF U.S. REG. NOS. 1,386,975, 1,896,388 AND 1,915,113.
NO CLAIM IS MADE TO THE EXCLUSIVE RIGHT TO USE "CHINA", APART FROM THE MARK AS SHOWN.

CLASS 30—STAPLE FOODS

FOR TEA (U.S. CL. 46).

CLASS 35—ADVERTISING AND BUSINESS

FOR RETAIL OUTLETS FEATURING TEA; MAIL ORDER CATALOG SERVICES FEATURING TEA; WHOLESALE STORES FEATURING TEA; WHOLESALE DISTRIBUTORSHIPS FEATURING TEA; ON-LINE RETAIL STORE SERVICES FEATURING TEA (U.S. CLS. 100, 101 AND 102).

SN 78-040,086. MASTERCARD INTERNATIONAL INCORPORATED, PURCHASE, NY. FILED 12-20-2000.

MASTERCARD GETAWAYS SWEEPSTAKES

OWNER OF U.S. REG. NOS. 1,275,853, 2,317,875 AND OTHERS.

NO CLAIM IS MADE TO THE EXCLUSIVE RIGHT TO USE "GETAWAYS SWEEPSTAKES", APART FROM THE MARK AS SHOWN.

CLASS 35—ADVERTISING AND BUSINESS

FOR PROMOTING THE SALE OF THE GOODS AND SERVICE OF OTHERS THROUGH PROMOTIONAL CONTESTS (U.S. CLS. 100, 101 AND 102).

FIRST USE 1-28-2001; IN COMMERCE 1-28-2001.

CLASS 41—EDUCATION AND ENTERTAINMENT

FOR ENTERTAINING SERVICES IN THE NATURE OF CONDUCTING A SWEEPSTAKES GAME (U.S. CLS. 100, 101 AND 107).

FIRST USE 1-28-2001; IN COMMERCE 1-28-2001.

SN 78-042,325. U.S. DATA PORT, INC., SAN JOSE, CA. FILED 1-9-2001.



NO CLAIM IS MADE TO THE EXCLUSIVE RIGHT TO USE "US", APART FROM THE MARK AS SHOWN.

CLASS 36—INSURANCE AND FINANCIAL

FOR LEASING AND MANAGEMENT OF COMMERCIAL REAL ESTATE FACILITIES HAVING ADVANCED BROADBAND INTERNET CONNECTIVITY AND ENERGY AND CHILLED WATER PRODUCTION CAPABILITY, FOR USE BY TELECOMMUNICATIONS COMPANIES, INTERNET SERVICE PROVIDERS, INTERNET CONTENT PROVIDERS, APPLICATION SERVICE PROVIDERS, WEB-HOSTING AND CO-LOCATION COMPANIES AND CORPORATE DATA CENTERS (U.S. CLS. 100, 101 AND 102).

CLASS 37—CONSTRUCTION AND REPAIR

FOR DEVELOPMENT OF COMMERCIAL REAL ESTATE FACILITIES HAVING ADVANCED BROADBAND INTERNET CONNECTIVITY AND ENERGY AND CHILLED WATER PRODUCTION CAPABILITY, FOR USE BY TELECOMMUNICATIONS COMPANIES, INTERNET SERVICE PROVIDERS, INTERNET CONTENT PROVIDERS, APPLICATION SERVICE PROVIDERS, WEB-HOSTING AND CO-LOCATION COMPANIES AND CORPORATE DATA CENTERS (U.S. CLS. 100, 103 AND 106).

SN 78-043,928. W.R. GRACE & CO.-CONN., NEW YORK, NY. FILED 1-19-2001.

STRUX

CLASS 19—NON-METALLIC BUILDING MATERIALS

FOR NON-METALLIC BUILDING MATERIALS, NAMELY, POLYMERIC FIBERS FOR REINFORCING CONCRETE, MORTAR, OR MASONRY (U.S. CLS. 1, 12, 33 AND 50).

CLASS 22—CORDAGE AND FIBERS

FOR POLYMERIC FIBERS FOR USE IN THE FURTHER MANUFACTURE OF REINFORCED CONCRETE, MORTAR, AND MASONRY (U.S. CLS. 1, 2, 7, 19, 22, 42 AND 50).

SN 78-049,283. SOMA, LLC, HONOLULU, HI. FILED 2-20-2001.

CHIP & COOKIE

CLASS 16—PAPER GOODS AND PRINTED MATTER

FOR PAPER GOODS, NAMELY, CHILDREN'S BOOKS, PICTURE BOOKS, COMIC BOOKS, COLORING BOOKS, TRADING CARDS AND PLAYING CARDS (U.S. CLS. 2, 5, 22, 23, 29, 37, 38 AND 50).

CLASS 25—CLOTHING

FOR CLOTHING, NAMELY, CHILDREN'S COATS, SWEATSHIRTS, SWEATPANTS, T-SHIRTS, PANTS, SHOES, HATS, GLOVES, MITTENS, UNDERGARMENTS, DRESSES, SKIRTS, PULLOVERS, SWEATERS, VESTS, JEANS, SHORTS, OVERALLS, PAJAMAS, BATHING SUITS, SOCKS, BATH ROBES AND BELTS (U.S. CLS. 22 AND 39).

CLASS 28—TOYS AND SPORTING GOODS

FOR TOYS, NAMELY, STUFFED DOLLS, ACTION FIGURES, BOARD GAMES, PLAY HOUSES, PLAY SETS, PUZZLES, AND TOY OVENS (U.S. CLS. 22, 23, 38 AND 50).

CLASS 41—EDUCATION AND ENTERTAINMENT

FOR ENTERTAINMENT IN THE NATURE OF CHILDREN'S TELEVISION PROGRAMMING, CHILDREN'S SONGS AND MUSIC, CHILDREN'S FILMS AND CHILDREN'S ONGOING RADIO PROGRAMS (U.S. CLS. 100, 101 AND 107).

SN 78-049,369. NASIGN CO., LTD., SEOUL, REPUBLIC OF KOREA, FILED 2-20-2001.

NASIGN**CLASS 18—LEATHER GOODS**

FOR ALL PURPOSE SPORTS BAGS, BACKPACKS, BELT BAGS, BILL FOLDS, CHANGE PURSES, CLUTCH BAGS, COSMETIC BAGS SOLD EMPTY, CREDIT CARD HOLDERS, DUFFLE BAGS, KEY CASES, HANDBAGS, LUGGAGE, PURSES, SCHOOL BAGS, SHOULDER BAGS, TOTE BAGS, TRAVEL BAGS, AND WALLETS, ALL MADE IN WHOLE OR IN SIGNIFICANT PART OF LEATHER; LEATHER SOLD IN BULK (U.S. CLS. 1, 2, 3, 22 AND 41).

CLASS 25—CLOTHING

FOR MEN'S, WOMEN'S, AND CHILDREN'S APPAREL, NAMELY, JACKETS, PANTS, SHORTS, SHIRTS, HATS, GLOVES, UNDERWEAR, BELTS, T-SHIRTS, AND VESTS, ALL MADE IN WHOLE OR IN SIGNIFICANT PART OF LEATHER (U.S. CLS. 22 AND 39).

CLASS 40—MATERIAL TREATMENT

FOR TANNING, FINISHING, COLORING, AND TREATMENT OF LEATHER (U.S. CLS. 100, 103 AND 106).

SN 78-051,975. TRANSITIONS FOR HEALTH, INC., PORTLAND, OR. FILED 3-8-2001.

WGF**CLASS 3—COSMETICS AND CLEANING PREPARATIONS**

FOR COSMETICS (U.S. CLS. 1, 4, 6, 50, 51 AND 52).

CLASS 5—PHARMACEUTICALS

FOR DIETARY SUPPLEMENTS FOR USE IN CONNECTION WITH MENSTRUATION AND MENOPAUSE (U.S. CLS. 6, 18, 44, 46, 51 AND 52).

SN 78-053,939. MCDOWELL, CLARENCE, LOS ANGELES, CA. FILED 3-19-2001.

DJ'S ON THE RUN

NO CLAIM IS MADE TO THE EXCLUSIVE RIGHT TO USE "DJ'S", APART FROM THE MARK AS SHOWN.

CLASS 9—ELECTRICAL AND SCIENTIFIC APPARATUS

FOR CLOTHING, NAMELY MEN'S AND WOMEN'S SHIRTS (U.S. CLS. 21, 23, 26, 36 AND 38).

CLASS 35—ADVERTISING AND BUSINESS

FOR DIRECT MARKETING ADVERTISING FOR OTHERS, NAMELY PROMOTING WORLDWIDE DJ EVENTS AND RECORD PROMOTION BY PLACING ADVERTISEMENTS IN THE PRINT, FILM, AUDIO AND THE GLOBAL COMMUNICATIONS NETWORK MEDIA (U.S. CLS. 100, 101 AND 102).

SN 78-054,955. FUNCTIONAL DEVICES, INC., RUSSIAVILLE, IN. FILED 3-26-2001.

RED-E**CLASS 6—METAL GOODS**

FOR METAL BOXES FOR ENCLOSING SUB-PANELS, TRANSFORMERS, POWER SUPPLIES, ELECTRICAL, ELECTRO-MECHANICAL, MECHANICAL, PNEUMATIC, AND OTHER ASSOCIATED CONTROLS EQUIPMENT (U.S. CLS. 2, 12, 13, 14, 23, 25 AND 50).

CLASS 9—ELECTRICAL AND SCIENTIFIC APPARATUS

FOR ELECTRICAL TRANSFORMERS AND POWER SUPPLIES (U.S. CLS. 21, 23, 26, 36 AND 38).

SN 78-055,484. CONAIR CORPORATION, STAMFORD, CT. FILED 3-28-2001.

WARING COUNTRY

OWNER OF U.S. REG. NOS. 605,403, 605,699 AND 1,146,039.

CLASS 7—MACHINERY

FOR ELECTRIC AND BATTERY OPERATED KITCHEN APPLIANCES, NAMELY FOOD PROCESSORS, CHOPPERS, BLENDERS, MIXERS, JUICERS AND DRINK MIXERS. (U.S. CLS. 13, 19, 21, 23, 31, 34 AND 35).

CLASS 11—ENVIRONMENTAL CONTROL APPARATUS

FOR ELECTRIC KITCHEN APPLIANCES, NAMELY TOASTERS AND COFFEE MAKERS (U.S. CLS. 13, 21, 23, 31 AND 34).

SN 78-055,757. IPCAPITAL GROUP, INC., WILLISTON, VT.
FILED 3-29-2001.

INTELLECTUAL PROPERTY IS CAPITAL

NO CLAIM IS MADE TO THE EXCLUSIVE RIGHT TO USE "INTELLECTUAL PROPERTY", APART FROM THE MARK AS SHOWN.

CLASS 36—INSURANCE AND FINANCIAL

FOR FINANCIAL VALUATION OF INTELLECTUAL PROPERTY ASSETS IN CONNECTION WITH EFFORTS TO RAISE VALUATION AND CAPITAL (U.S. CLS. 100, 101 AND 102).

FIRST USE 3-1-2001; IN COMMERCE 3-1-2001.

CLASS 42—SCIENTIFIC, COMPUTER AND LEGAL SERVICES

FOR INTELLECTUAL PROPERTY CONSULTATION, NAMELY, CONSULTING FOR OTHERS ON HOW TO DEVELOP AND LEVERAGE INTELLECTUAL PROPERTY ASSETS; CONSULTING FOR OTHERS IN THE FIELD OF IDENTIFYING VIABLE INVENTIONS; PRODUCT DEVELOPMENT SERVICES, NAMELY, INVENTION DEVELOPMENT; INTELLECTUAL PROPERTY CONSULTATION, NAMELY, ADVISING CLIENTS ON ENGINEERING INTELLECTUAL PROPERTY AROUND COMPETITIVE INTELLECTUAL PROPERTY TO AVOID VIOLATING THE INTELLECTUAL PROPERTY RIGHTS OF COMPETITORS (U.S. CLS. 100 AND 101).

FIRST USE 3-1-2001; IN COMMERCE 3-1-2001.

SN 78-058,702. FROGGYTALES LLC, DENVER, CO. FILED 4-16-2001.

FROGGYTALES

CLASS 9—ELECTRICAL AND SCIENTIFIC APPARATUS

FOR DOWNLOADABLE ELECTRONIC PUBLICATIONS IN THE NATURE OF STORIES IN THE FIELD OF FICTION FOR CHILDREN; ELECTRONIC PUBLICATIONS, NAMELY, BOOKS FEATURING CHILDREN'S STORIES RECORDED ON COMPACT DISKS (U.S. CLS. 21, 23, 26, 36 AND 38).

CLASS 16—PAPER GOODS AND PRINTED MATTER

FOR PUBLISHING HOUSE MARK FOR COLLECTIONS OF STORIES FOR CHILDREN (U.S. CLS. 2, 5, 22, 23, 29, 37, 38 AND 50).

SN 78-058,896. CLYMAN, JEFFREY M., LONG ISLAND CITY, NY. FILED 4-17-2001.

SKYBOSS

CLASS 9—ELECTRICAL AND SCIENTIFIC APPARATUS

FOR VIDEO GAME CARTRIDGES; COMPUTER GAME SOFTWARE; COMPUTER GAME TAPES; COMPUTER GAME PROGRAMS (U.S. CLS. 21, 23, 26, 36 AND 38).

CLASS 16—PAPER GOODS AND PRINTED MATTER

FOR ADDRESS BOOKS, PHOTOGRAPH ALBUMS, CHILDREN'S BOOKS, COLORING BOOKS, NOTEBOOKS, PICTURE BOOKS, WRITING PADS, POSTERS AND SCRAP BOOKS (U.S. CLS. 2, 5, 22, 23, 29, 37, 38 AND 50).

CLASS 18—LEATHER GOODS

FOR BACKPACKS, BOOK BAGS, ALL PURPOSE SPORT BAGS, TRAVEL BAGS, BEACH BAGS (U.S. CLS. 1, 2, 3, 22 AND 41).

CLASS 25—CLOTHING

FOR SHIRTS, PANTS, SHORTS, JEANS, SKIRTS, SWEATERS, SWEATSHIRTS, DRESSES, UNDERWEAR, SLEEPWEAR, JACKETS, COATS, BELTS, TIES, HOSIERY, SOCKS, GLOVES, SCARVES, LINGERIE, HATS, BATHING SUITS, AND FOOTWEAR (U.S. CLS. 22 AND 39).

CLASS 28—TOYS AND SPORTING GOODS

FOR ACTION FIGURES AND ACCESSORIES THEREFOR; TOYS, NAMELY, TOY VEHICLES, TOY MODEL CARS, TOY AIRPLANES AND BOARD GAMES (U.S. CLS. 22, 23, 38 AND 50).

SN 78-059,543. RECKITT BENCKISER INC., WAYNE, NJ.
FILED 4-20-2001.

LEMON BREEZE

NO CLAIM IS MADE TO THE EXCLUSIVE RIGHT TO USE "LEMON", APART FROM THE MARK AS SHOWN.

CLASS 3—COSMETICS AND CLEANING PREPARATIONS

FOR ALL PURPOSE CLEANING PREPARATIONS; GENERAL PURPOSE CLEANING, POLISHING AND SCOURING PREPARATIONS; DETERGENT SOAP, DEODORANT SOAP, SKIN SOAP AND DISH DETERGENT, DISHWASHING DETERGENT, LAUNDRY DETERGENT (U.S. CLS. 1, 4, 6, 50, 51 AND 52).

CLASS 5—PHARMACEUTICALS

FOR PERFUMING PREPARATIONS FOR THE AIR, AIR FRESHENING PREPARATIONS AND AIR PURIFIERS, NAMELY, AIR DEODORIZERS, AIR DEODORANT, AIR FRESHENERS; ALL PURPOSE DISINFECTING AND SANITIZING PREPARATIONS; AIR, CAR HOUSEHOLD AND ROOM DEODORANTS AND DEODORIZERS; GENERAL PURPOSE GERMICIDES, ANTISEPTICS; ANTIBACTERIAL PREPARATIONS, NAMELY, ALCOHOL SKIN SANITIZER GELS, HANDWASHES, PHARMACEUTICALS, AND SKIN SOAPS (U.S. CLS. 6, 18, 44, 46, 51 AND 52).

SN 78-059,891. HEWLETT-PACKARD COMPANY, PALO ALTO, CA. FILED 4-23-2001.

HP DISCOVER

OWNER OF U.S. REG. NOS. 614,803, 2,474,422 AND OTHERS.

CLASS 9—ELECTRICAL AND SCIENTIFIC APPARATUS

FOR COMPUTER HARDWARE, NAMELY, COMPUTER PRINTERS, SCANNERS, COPIERS, DIGITAL CAMERAS, FACSIMILE MACHINES, CD-ROM WRITERS, COMPUTER DISK DRIVES, PERSONAL COMPUTERS, HANDHELD PERSONAL COMPUTERS (U.S. CLS. 21, 23, 26, 36 AND 38).

CLASS 40—MATERIAL TREATMENT

FOR COMPUTER SERVICES PROVIDED VIA THE INTERNET, NAMELY, DIGITAL PHOTO SHARING, NAMELY, ELECTRONIC IMAGING, SCANNING, DIGITIZING, ALTERATION AND RETOUCHING OF PHOTOGRAPHIC IMAGES AND DIGITAL PHOTOGRAPHIC PRINTING (U.S. CLS. 100, 103 AND 106).

SN 78-061,508. DONALD L. BENNETT, D.D.S., P.C., CHICAGO, IL. FILED 5-2-2001.

LAKE DENTAL CARE

NO CLAIM IS MADE TO THE EXCLUSIVE RIGHT TO USE "DENTAL CARE", APART FROM THE MARK AS SHOWN.

CLASS 40—MATERIAL TREATMENT

FOR CUSTOM MANUFACTURE OF DENTAL PROSTHETICS AND IMPLANTS THROUGH THE CUTTING, SHAPING, PHYSICAL FITTING, AND OTHER TRANSFORMATION OF MATERIALS FOR USE OR IMPLANT WITHIN HUMANS (U.S. CLS. 100, 103 AND 106).

FIRST USE 9-25-2000; IN COMMERCE 9-25-2000.

CLASS 42—SCIENTIFIC, COMPUTER AND LEGAL SERVICES

FOR PROVISION OF DENTAL CARE TO HUMANS (U.S. CLS. 100 AND 101).

FIRST USE 9-25-2000; IN COMMERCE 9-25-2000.

SN 78-063,431. STILA COSMETICS, INC., LOS ANGELES, CA. FILED 5-14-2001.

FASHION FOR YOUR FACE**CLASS 3—COSMETICS AND CLEANING PREPARATIONS**

FOR COSMETICS, PERFUMERY AND TOILETRIES, NAMELY, FACIAL CLEANSERS, FACIAL MOISTURIZERS, FACE CREAMS, FACE LOTIONS, FACE GELS, EYE CREAMS, EYE GELS, EYE MAKEUP REMOVER, FACIAL MAKEUP REMOVER, CLEANSING LOTIONS, CLEANSING CREAMS, CLEANSING GELS, NON-MEDICATED ANTI-WRINKLE CREAMS, LOTIONS AND GELS, NON-MEDICATED SKIN REPAIR CREAMS, LOTIONS AND GELS, NON-MEDICATED SKIN BLEMISH PREPARATIONS, FACIAL TONER, FACIAL SOAPS, HAND CREAM, BODY CREAM, BODY LOTION, BODY GEL, BODY OIL, BODY POWDER, BODY TONERS, BODY CLEANSERS, NON-MEDICATED BATH SALTS, BATH POWDER, BATH OIL, BATH GRAINS, BATH GELS, BODY SPRAYS, BODY WASHES, SKIN BALANCING LOTIONS, CREAMS AND GELS, FACIAL SKIN OIL CONTROLLERS, SKIN FIRING PREPARATIONS, EYE LOTIONS, EYE GELS, NON-MEDICATED SKIN RENEWAL CREAM, FACIAL EXFOLIATING PREPARATIONS, FACE MASQUES, SKIN REFRESHERS, FACE AND BODY EXFOLIATING PREPARATIONS, BODY MASQUES, FACE AND BODY SUNSCREENS, FACE AND BODY SELF-TANNING PREPARATIONS, FACIAL AND BODY OIL SPRAYS, LIP SUNSCREEN PREPARATIONS, SUN TAN LOTIONS, AFTER-SUN SOOTHING AND MOISTURIZING PREPARATIONS, SELF-TANNING PREPARATIONS, PERSONAL SOAPS, HAIR SHAMPOO, HAIR CONDITIONER, HAIR SPRAY, HAIR MOUSSE, HAIR GEL, HAIR HUMECTANT, HAIR REVITALIZING TREATMENT, HAIR SUNSCREEN, HAIR MAKEUP, HAIR THICKENERS, HAIR MASCARA, SHAVING FOAMS, CREAMS, LOTIONS AND GELS, AND ANTIPERSPIRANT/DEODORANT (U.S. CLS. 1, 4, 6, 50, 51 AND 52).

CLASS 42—SCIENTIFIC, COMPUTER AND LEGAL SERVICES

FOR PROVIDING INFORMATION REGARDING THE SELECTION AND USE OF PERSONAL CARE PRODUCTS, COSMETICS, PERFUMERY, TOILETRIES, BATH AND BODY PRODUCTS, SKIN CARE PRODUCTS, HAIR CARE PRODUCTS, BEAUTY TREATMENTS, COLOR ANALYSIS, LIFESTYLE AND PERSONAL APPEARANCE; BEAUTY CONSULTATION SERVICES IN THE FIELD OF SELECTION AND USE OF PERSONAL CARE PRODUCTS, COSMETICS, PERFUMERY, TOILETRIES, BATH AND BODY PRODUCTS, SKIN CARE PRODUCTS, HAIR CARE PRODUCTS, BEAUTY TREATMENTS, COLOR ANALYSIS, LIFESTYLE AND PERSONAL APPEARANCE (U.S. CLS. 100 AND 101).

SN 78-063,578. SANDSTORM SYSTEMS, LLC, HILLSDALE, NJ. FILED 5-15-2001.



NO CLAIM IS MADE TO THE EXCLUSIVE RIGHT TO USE "SYSTEMS", APART FROM THE MARK AS SHOWN.

CLASS 9—ELECTRICAL AND SCIENTIFIC APPARATUS

FOR COMPUTER VIDEO GAME SOFTWARE (U.S. CLS. 21, 23, 26, 36 AND 38).

CLASS 42—SCIENTIFIC, COMPUTER AND LEGAL SERVICES

FOR TECHNICAL CONSULTATION IN THE FIELD OF COMPUTER SOFTWARE DEVELOPMENT, SYSTEMS DEVELOPMENT, SYSTEM ARCHITECTURE, PRODUCT DEVELOPMENT AND PROJECT MANAGEMENT (U.S. CLS. 100 AND 101).

SN 78-066,280. SCULLY, TIM, SAN FRANCISCO, CA. AND DA SILVA, NICHOLAS, SAN FRANCISCO, CA. AND FUAD, TURONNY, SAN FRANCISCO, CA. FILED 5-30-2001.

CLASS 9—ELECTRICAL AND SCIENTIFIC APPARATUS

FOR COMPUTER SOFTWARE FOR TEACHING HISTORY; MOTION PICTURE FILM FEATURING ANIMATIONS AND MOTION PICTURE FILMS IN THE GENRE OF HISTORY FOR ONLINE BROADCAST (U.S. CLS. 21, 23, 26, 36 AND 38).

FIRST USE 9-1-2000; IN COMMERCE 1-23-2001.

CLASS 41—EDUCATION AND ENTERTAINMENT

FOR PROVIDING INFORMATION IN THE FIELD OF EDUCATION AND ENTERTAINMENT RELATING SPECIFICALLY TO HISTORY VIA AN ELECTRONIC GLOBAL COMPUTER NETWORK; PROVIDING INFORMATION ABOUT HISTORY VIA AN ELECTRONIC GLOBAL COMPUTER NETWORK IN THE NATURE OF LIVE-ACTION AND ANIMATED PROGRAMS (U.S. CLS. 100, 101 AND 107).

FIRST USE 9-1-2000; IN COMMERCE 1-23-2001.

SN 78-067,862. BANK OF AMERICA CORPORATION, CHARLOTTE, NC. FILED 6-7-2001.

SEACARD

CLASS 9—ELECTRICAL AND SCIENTIFIC APPARATUS

FOR MAGNETICALLY AND ELECTRONICALLY CODED STORED VALUE CARDS (U.S. CLS. 21, 23, 26, 36 AND 38).

CLASS 36—INSURANCE AND FINANCIAL

FOR BANKING AND RELATED FINANCIAL SERVICES; BANKING SERVICES, NAMELY, PROVIDING STORED VALUE CARD SERVICES (U.S. CLS. 100, 101 AND 102).

SN 78-069,051. PROCTER & GAMBLE COMPANY, THE, CINCINNATI, OH. FILED 6-14-2001.

PAMPERS CLEAN 'N PLAY!

OWNER OF U.S. REG. NOS. 745,513, 2,448,467 AND OTHERS.

CLASS 3—COSMETICS AND CLEANING PREPARATIONS

FOR CLEANING PREPARATIONS FOR HARD SURFACES, SKIN CLEANSERS, DISPOSABLE WIPES IMPREGNATED WITH CLEANING PREPARATIONS FOR CLEANING HARD SURFACES, DISPOSABLE WIPES IMPREGNATED WITH CLEANING PREPARATIONS FOR SKIN CLEANSING (U.S. CLS. 1, 4, 6, 50, 51 AND 52).

CLASS 5—PHARMACEUTICALS

FOR DISINFECTANT CLEANING PREPARATIONS FOR HARD SURFACES, DISINFECTING SKIN CLEANSERS, DISPOSABLE WIPES IMPREGNATED WITH DISINFECTING CLEANING PREPARATION FOR HARD SURFACES, DISPOSABLE WIPES IMPREGNATED WITH DISINFECTING CLEANING PREPARATIONS FOR SKIN CLEANSING (U.S. CLS. 6, 18, 44, 46, 51 AND 52).

CLASS 16—PAPER GOODS AND PRINTED MATTER

FOR PAPER PRODUCTS, NAMELY, PAPER TOWELS, PAPER NAPKINS, DISPOSABLE WIPES NOT IMPREGNATED WITH CHEMICALS OR COMPOUNDS, DISPOSABLE, PROTECTIVE SURFACE COVERINGS FOR HARD SURFACES, DISPOSABLE CLEANING PADS, DISPOSABLE CLEANING MITTS (U.S. CLS. 2, 5, 22, 23, 29, 37, 38 AND 50).

CLASS 21—HOUSEWARES AND GLASS

FOR ARTICLES AND DEVICES FOR CLEANING AND DISINFECTING PURPOSES, NAMELY MOPS, BRUSHES, SPONGES AND BROOMS (U.S. CLS. 2, 13, 23, 29, 30, 33, 40 AND 50).

SN 78-070,146. N. DEAN MEYER AND ASSOCIATES INC., RIDGEFIELD, CT. FILED 6-20-2001.

BUDGET BY DELIVERABLES

NO CLAIM IS MADE TO THE EXCLUSIVE RIGHT TO USE "BUDGET", APART FROM THE MARK AS SHOWN.

CLASS 9—ELECTRICAL AND SCIENTIFIC APPARATUS

FOR COMPUTER SOFTWARE RECORDED ON A DISKETTE CONTAINING A SPREADSHEET AND A DETAILED MANUAL THAT GUIDES AN ORGANIZATION STEP-BY-STEP THROUGH DEVELOPMENT OF BUDGETS THAT ARE BASED ON PLANNED PROJECTS AND SERVICES RATHER THAN ON COST FACTORS (U.S. CLS. 21, 23, 26, 36 AND 38).

FIRST USE 6-2-1999; IN COMMERCE 7-30-1999.

CLASS 35—ADVERTISING AND BUSINESS

FOR BUSINESS CONSULTATION SERVICES, NAMELY, BUSINESS CONSULTATION IN THE FIELD OF BUDGET PREPARATION AND ACTIVITY-BASED COSTING (U.S. CLS. 100, 101 AND 102).

FIRST USE 6-2-1999; IN COMMERCE 7-30-1999.

SN 78-070,791. MODERNISTA!, LTD., BOSTON, MA. FILED 6-25-2001.

SN 78-071,467. W.W. GRAINGER, INC., LAKE FOREST, IL. FILED 6-28-2001.

LIKE NOTHING ELSE

CLASS 12—VEHICLES

FOR AUTOMOBILE ROOF RACKS FOR LUGGAGE AND SPORTING EQUIPMENT; BICYCLE RACKS FOR VEHICLES; MOUNTING RACKS FOR VEHICLES USED TO MOUNT SPORTING EQUIPMENT AND SPARE TIRES; TIRE CARRIERS; TIRE REPAIR KITS COMPRISED OF PATCHES AND RUBBER; LAND VEHICLE PARTS, NAMELY, WHEELS, SEATS, SEAT COVERS, DOOR HANDLE COVERS AND BEZELS, RUNNING BOARDS, ROCKER PANEL PROTECTORS, SKID PLATE COVERS, BRUSH GUARDS, CARGO AREA LINERS AND BED LINERS (U.S. CLS. 19, 21, 23, 31, 35 AND 44).

CLASS 25—CLOTHING

FOR SHIRTS, TEE SHIRTS, SWEATSHIRTS, JACKETS, VESTS, PANTS, SHORTS, OVERALLS, HATS AND VISORS (U.S. CLS. 22 AND 39).

CLASS 35—ADVERTISING AND BUSINESS

FOR ADVERTISING SERVICES, NAMELY, PREPARING AND PLACING ADVERTISEMENTS FOR OTHERS, DISSEMINATION OF ADVERTISING MATTER, AND DIRECT MARKETING ADVERTISING FOR OTHERS IN THE FIELD OF MOTOR VEHICLES (U.S. CLS. 100, 101 AND 102).

SN 78-071,278. MILLER, JOSEPH B. III, SAN RAMON, CA. FILED 6-27-2001.

PERILUX

CLASS 9—ELECTRICAL AND SCIENTIFIC APPARATUS

FOR COMPUTER SOFTWARE TO ASSESS THE INDIVIDUAL LEARNING STYLES AND COGNITIVE STRENGTHS OF AN ADULT LEARNER THAT THEN USES THAT ASSESSMENT TO CREATE A PERSONALIZED LEARNING PATH THAT IS APPLIED TO EDUCATIONAL CONTENT ON ANY SUBJECT AREA (U.S. CLS. 21, 23, 26, 36 AND 38).

CLASS 42—SCIENTIFIC, COMPUTER AND LEGAL SERVICES

FOR CUSTOM DESIGN AND DEVELOPMENT OF COMPUTER SOFTWARE FOR OTHERS THAT ASSESS INDIVIDUAL LEARNING STYLES AND COGNITIVE STRENGTHS OF AN ADULT LEARNER AND USES THAT INFORMATION TO CREATE A PERSONALIZED LEARNING CURRICULUM THAT IS APPLIED TO EDUCATIONAL CONTENT ON ANY SUBJECT AREA (U.S. CLS. 100 AND 101).

TRIDENT

CLASS 21—HOUSEWARES AND GLASS

FOR BATH ACCESSORIES, NAMELY, LIQUID SOAP DISPENSERS, METAL BOTTLE OPENERS, METAL SOAP DISHES, METAL FACIAL TISSUE HOLDERS, METAL TOILET PAPER HOLDERS, METAL TOWEL BARS, METAL TOWEL RINGS, METAL TOWEL SHELVES, METAL PAPER TOWEL HOLDERS AND METAL TOILET SEAT COVER DISPENSERS (U.S. CLS. 2, 13, 23, 29, 30, 33, 40 AND 50).

CLASS 22—CORDAGE AND FIBERS

FOR METAL RETRACTABLE CLOTHESLINES (U.S. CLS. 1, 2, 7, 19, 22, 42 AND 50).

CLASS 34—SMOKERS' ARTICLES

FOR NON-PRECIOUS METAL ASH TRAYS (U.S. CLS. 2, 8, 9 AND 17).

SN 78-072,234. GRADY, HENRY W, AKA EXECUTRIX OF THE ESTATE OF BONNIE CASHIN, AN ESTATE OF NEW YORK, NEW YORK, NY. FILED 7-3-2001.

BONNIE CASHIN

THE NAME "BONNIE CASHIN" DOES NOT IDENTIFY A LIVING INDIVIDUAL.

CLASS 18—LEATHER GOODS

FOR HANDBAGS, WEEKEND BAGS, WALLETS, COIN PURSES, AND UMBRELLAS (U.S. CLS. 1, 2, 3, 22 AND 41).

CLASS 25—CLOTHING

FOR LADIES CLOTHING, NAMELY COATS, JACKETS, KNITWEAR CONSISTING OF JERSEY TOPS, SWEATERS, SKIRTS AND DRESSES OF CASHMERE, WOOL AND/OR MOHAIR, TOPS, SKIRTS, DRESSES, PANTS, ROBES, SWEATERS, HATS, AND GLOVES (U.S. CLS. 22 AND 39).

SN 78-072,629. OPSERVER, INC., BOSTON, MA. FILED 7-6-2001.

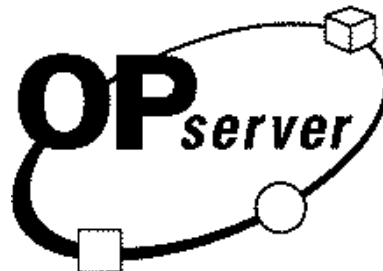

OWNER OF U.S. REG. NO. 2,412,426.
NO CLAIM IS MADE TO THE EXCLUSIVE RIGHT TO USE "SERVER", APART FROM THE MARK AS SHOWN.

CLASS 9—ELECTRICAL AND SCIENTIFIC APPARATUS

SN 78-078,011. DANNI ASHE, INC., MARINA DEL RAY, CA. FILED 8-7-2001.

FOR COMPUTER SOFTWARE FOR FORMATTING DOCUMENTS AND ELECTRONICALLY ROUTING THEM TO HIGH-VOLUME PRINTERS OR TO OTHER OUTPUT DESTINATIONS SUCH AS CD-ROMS, ELECTRONIC MAIL, SITES ON AN INTERNAL COMPUTER INFORMATION NETWORK AND INTERNET SITES; COMPUTER SOFTWARE FOR MANAGING AND REPORTING INFORMATION ABOUT THE STATUS AND HISTORY OF THE DOCUMENT FORMATTING, ROUTING AND OUTPUT PROCESS; COMPUTER SOFTWARE FOR THE ARCHIVAL STORAGE OF DOCUMENTS; COMPUTER SOFTWARE FOR PROOFING THE LAYOUT OF PRINTED MATERIALS; USER MANUALS PACKAGED AS A UNIT WITH THE FOREGOING GOODS (U.S. CLS. 21, 23, 26, 36 AND 38).
FIRST USE 10-0-2000; IN COMMERCE 10-0-2000.



THE MARK CONSISTS OF A STYLIZED REPRESENTATION OF THE LETTERS DA .

CLASS 42—SCIENTIFIC, COMPUTER AND LEGAL SERVICES

FOR CONSULTING SERVICES IN THE FIELD OF COMPUTERS, HIGH-VOLUME PRINTERS AND COMPUTERIZED DOCUMENT MANAGEMENT; GRAPHIC DESIGN SERVICES; TECHNICAL CONSULTATION IN THE FIELD OF COMPUTER EQUIPMENT; PROVIDING INFORMATION ABOUT COMPUTERS, HIGH-VOLUME PRINTERS AND COMPUTERIZED DOCUMENT MANAGEMENT BY MEANS OF AN INTERNET WEB SITE (U.S. CLS. 100 AND 101).
FIRST USE 10-0-2000; IN COMMERCE 10-0-2000.

CLASS 38—COMMUNICATION

FOR PROVIDING ONLINE CHAT ROOMS ON THE TOPIC OF ADULT ENTERTAINMENT; PROVIDING ACCESS TO AN ONLINE COMPUTER BULLETIN BOARD DEALING WITH ADULT ENTERTAINMENT; PROVIDING ONLINE ELECTRONIC BULLETIN BOARDS FOR TRANSMISSION OF MESSAGES AMONG COMPUTER USERS CONCERNING ADULT ENTERTAINMENT; PROVIDING ONLINE FACILITIES FOR REAL TIME INTERACTION WITH OTHER COMPUTER USERS CONCERNING ADULT ENTERTAINMENT (U.S. CLS. 100, 101 AND 104).

SN 78-077,681. MICHIGAN VIRTUAL UNIVERSITY, LANSING, MI. FILED 8-6-2001.

BLUESKYWAY

CLASS 41—EDUCATION AND ENTERTAINMENT

FOR ENTERTAINMENT SERVICES IN THE NATURE OF PROVIDING A WEBSITE ON THE GLOBAL COMPUTER NETWORKS FEATURING INFORMATION IN THE FIELD OF ADULT ENTERTAINMENT; PROVIDING AN ONLINE WEBSITE OF INFORMATION COMPRISING ADULT MATERIAL AND VIEWING THEREOF, AND OTHER ADULT ENTERTAINMENT RELATED NEWS, FACTS, TRIVIA AND HUMOR (U.S. CLS. 100, 101 AND 107).

CLASS 41—EDUCATION AND ENTERTAINMENT

FOR EDUCATIONAL SERVICES, NAMELY, PROVIDING COURSES OF INSTRUCTION AT THE PRIMARY, SECONDARY AND UNIVERSITY LEVELS AND DISTRIBUTING COURSE MATERIAL IN CONNECTION THEREWITH; DISTANCE LEARNING SERVICES, NAMELY, PROVIDING LIVE AND PRE-RECORDED INTERACTIVE, MULTIMEDIA HIGH SCHOOL AND COLLEGE LEVEL EDUCATION AND TRAINING PROGRAMS IN THE FIELD OF A VARIETY OF SUBJECTS VIA THE WORLD WIDE WEB AND OTHER COMMUNICATION NETWORKS AND CONDUCTING DISTANCE LEARNING WORKSHOPS, SEMINARS, AND CONFERENCES FOR OTHERS IN THE FIELD OF HIGH SCHOOL LEVEL COURSE WORK AND COLLEGE LEVEL COURSE WORK VIA COMMUNICATION NETWORKS (U.S. CLS. 100, 101 AND 107).

CLASS 42—SCIENTIFIC, COMPUTER AND LEGAL SERVICES

FOR COMPUTER SERVICES, NAMELY PROVIDING ON-LINE MAGAZINE AND COLUMNS IN THE FIELD OF ADULT ENTERTAINMENT (U.S. CLS. 100 AND 101).

SN 78-078,020. CH. DAHLINGER GMBH & CO. KG, 77933 LAHR, FED REP GERMANY, FILED 8-7-2001.



Ch. Dahlinger

CLASS 42—SCIENTIFIC, COMPUTER AND LEGAL SERVICES

FOR PROVIDING CAREER GUIDANCE INFORMATION VIA THE WORLD WIDE WEB AND OTHER COMMUNICATIONS NETWORKS (U.S. CLS. 100 AND 101).

THE NAME[S], PORTRAIT[S], AND/OR SIGNATURE[S] SHOWN IN THE MARK DOES NOT IDENTIFY A PARTICULAR LIVING INDIVIDUAL.

CLASS 16—PAPER GOODS AND PRINTED MATTER

FOR PAPER SHOPPING BAGS (U.S. CLS. 2, 5, 22, 23, 29, 37, 38 AND 50).
FIRST USE 6-28-1972; IN COMMERCE 6-28-1972.

CLASS 18—LEATHER GOODS

FOR DRAWSTRING POUCHES FOR JEWELRY (U.S. CLS. 1, 2, 3, 22 AND 41).
FIRST USE 6-28-1972; IN COMMERCE 6-28-1972.

CLASS 20—FURNITURE AND ARTICLES NOT OTHERWISE CLASSIFIED

FOR MERCHANDISE STORAGE RACKS AND DISPLAY RACKS FOR RETAIL APPLICATIONS; JEWELRY BOXES AND GIFT BOXES NOT OF METAL; POINT OF PURCHASE JEWELRY DISPLAYS (U.S. CLS. 2, 13, 22, 25, 32 AND 50).
FIRST USE 6-28-1972; IN COMMERCE 6-28-1972.

SN 78-078,047. HOMESAFE, LP, SAN JOSE, CA. FILED 8-7-2001.

QUAKESAFE

CLASS 9—ELECTRICAL AND SCIENTIFIC APPARATUS

FOR COMPUTER HARDWARE AND SOFTWARE FOR USE IN DATABASE MANAGEMENT AND FOR USE IN ESTIMATING, IN THE FIELD OF EARTHQUAKE MITIGATION AND RESPONSE (U.S. CLS. 21, 23, 26, 36 AND 38).

CLASS 42—SCIENTIFIC, COMPUTER AND LEGAL SERVICES

FOR ENGINEERING SERVICES IN THE FIELD OF EARTHQUAKE MITIGATION AND RESPONSE (U.S. CLS. 100 AND 101).

SN 78-079,329. PROCTER & GAMBLE COMPANY, THE, CINCINNATI, OH. FILED 8-15-2001.



THE MARK CONSISTS OF AN ABSTRACT DESIGN OF A PERSON. THE LETTER E EXISTS AS THE FIGURE'S TORSO AND LEG.

CLASS 5—PHARMACEUTICALS

FOR NUTRACEUTICAL FOODS AND BEVERAGES FOR USE AS DIETARY SUPPLEMENTS (U.S. CLS. 6, 18, 44, 46, 51 AND 52).

CLASS 32—LIGHT BEVERAGES

FOR SOFT DRINKS AND FRUIT JUICE DRINKS CONTAINING WATER (U.S. CLS. 45, 46 AND 48).

SN 78-079,986. FLUOROWARE, INC., CHASKE, MN. FILED 8-18-2001.

SILICON DELIVERY

CLASS 20—FURNITURE AND ARTICLES NOT OTHERWISE CLASSIFIED

FOR CARRIERS AND CONTAINERS, MADE PRIMARILY OF PLASTIC, USED IN THE MANUFACTURE, STORAGE, PROCESSING AND TRANSPORTATION OF SEMICONDUCTOR WAFERS AND ELECTRONIC COMPONENTS (U.S. CLS. 2, 13, 22, 25, 32 AND 50).

CLASS 42—SCIENTIFIC, COMPUTER AND LEGAL SERVICES

FOR TECHNICAL CONSULTATION IN THE FIELDS OF TRANSPORTATION, PROCESSING, STORAGE, AND PACKAGING OF SEMICONDUCTOR WAFERS AND ELECTRONIC COMPONENTS; TECHNICAL CONSULTATION IN THE FIELDS OF THE USE, CLEANING, AND RECYCLING OF CARRIERS AND CONTAINERS FOR SEMICONDUCTOR WAFERS AND ELECTRONIC COMPONENTS (U.S. CLS. 100 AND 101).

SN 78-079,987. FLUOROWARE, INC., CHASKA, MN. FILED 8-18-2001.

WAFERSTREAM

CLASS 20—FURNITURE AND ARTICLES NOT OTHERWISE CLASSIFIED

FOR CARRIERS AND CONTAINERS, MADE PRIMARILY OF PLASTIC, USED IN THE MANUFACTURE, STORAGE, PROCESSING AND TRANSPORTATION OF SEMICONDUCTOR WAFERS AND ELECTRONIC COMPONENTS (U.S. CLS. 2, 13, 22, 25, 32 AND 50).

CLASS 42—SCIENTIFIC, COMPUTER AND LEGAL SERVICES

FOR TECHNICAL CONSULTATION IN THE FIELDS OF TRANSPORTATION, PROCESSING, STORAGE, AND PACKAGING OF SEMICONDUCTOR WAFERS AND ELECTRONIC COMPONENTS; TECHNICAL CONSULTATION IN THE FIELDS OF THE USE, CLEANING, AND RECYCLING OF CARRIERS AND CONTAINERS FOR SEMICONDUCTOR WAFERS AND ELECTRONIC COMPONENTS (U.S. CLS. 100 AND 101).

SN 78-079,988. FLUOROWARE, INC., CHASKA, MN. FILED 8-18-2001.

SN 78-083,925. HELENA CHEMICAL COMPANY, MEMPHIS, TN. FILED 9-14-2001.

DEVICECARE

CLASS 20—FURNITURE AND ARTICLES NOT OTHERWISE CLASSIFIED

FOR CARRIERS AND CONTAINERS, MADE PRIMARILY OF PLASTIC, USED IN THE MANUFACTURE, STORAGE, PROCESSING AND TRANSPORTATION OF SEMICONDUCTOR WAFERS AND ELECTRONIC COMPONENTS (U.S. CLS. 2, 13, 22, 25, 32 AND 50).

CLASS 42—SCIENTIFIC, COMPUTER AND LEGAL SERVICES

FOR TECHNICAL CONSULTATION IN THE FIELDS OF TRANSPORTATION, PROCESSING, STORAGE, AND PACKAGING OF SEMICONDUCTOR WAFERS AND ELECTRONIC COMPONENTS; TECHNICAL CONSULTATION IN THE FIELDS OF THE USE, CLEANING, AND RECYCLING OF CARRIERS AND CONTAINERS FOR SEMICONDUCTOR WAFERS AND ELECTRONIC COMPONENTS (U.S. CLS. 100 AND 101).

SN 78-082,680. EWM KAUAI LLC, LAS VEGAS, NV. FILED 5-2001.

OCEAN BAY PLANTATION

CLASS 37—CONSTRUCTION AND REPAIR

FOR REAL ESTATE DEVELOPMENT SERVICES (U.S. CLS. 100, 103 AND 106).

CLASS 41—EDUCATION AND ENTERTAINMENT

FOR PROVIDING GOLFING FACILITIES (U.S. CLS. 100, 101 AND 107).

SN 78-083,854. AIRCELL, INC., LOUISVILLE, CO. FILED 9-13-2001.

GUARDIAN 1000

CLASS 9—ELECTRICAL AND SCIENTIFIC APPARATUS

FOR CELLULAR COMMUNICATION SYSTEMS, NAMELY, COMPUTERS, FILE SERVERS, CELLULAR PHONES, TRANSMITTERS, RECEIVERS AND MODEMS FOR THE TRANSMISSION OF VOICE, VIDEO AND DATA BETWEEN AIRCRAFT AND THE GROUND (U.S. CLS. 21, 23, 26, 36 AND 38).

FIRST USE 7-24-2001; IN COMMERCE 7-24-2001.

CLASS 38—COMMUNICATION

FOR CELLULAR COMMUNICATION SERVICES, NAMELY, CELLULAR COMMUNICATION SERVICES FOR THE TRANSMISSION OF VOICE, VIDEO AND DATA BETWEEN AIRCRAFT AND THE GROUND (U.S. CLS. 100, 101 AND 104).

FIRST USE 7-24-2001; IN COMMERCE 7-24-2001.

PEOPLE...PRODUCTS...KNOWLEDGE...

CLASS 1—CHEMICALS

FOR FERTILIZERS AND FERTILIZER ADDITIVES FOR AGRICULTURAL DOMESTIC AND COMMERCIAL USE; CHEMICAL PRODUCTS USED IN AGRICULTURE, NAMELY, SOIL CONDITIONER AND PREPARATION AGENT; SPRAY ADJUVANTS FOR USE WITH AGRICULTURAL PESTICIDES (U.S. CLS. 1, 5, 6, 10, 26 AND 46).

FIRST USE 3-6-2000; IN COMMERCE 3-6-2000.

CLASS 35—ADVERTISING AND BUSINESS

FOR WHOLESALE DISTRIBUTORSHIP SERVICES FOR AGRICULTURAL PRODUCTS AND CHEMICALS, NAMELY, SPRAY ADJUVANTS, SEEDS, SEED TREATMENTS, SOIL CONDITIONING, FERTILIZERS, PESTICIDES AND HERBICIDES; RETAIL DISTRIBUTORSHIP SERVICES FOR AGRICULTURAL PRODUCTS AND CHEMICALS, NAMELY, SPRAY ADJUVANTS, SEEDS, SEED TREATMENTS, SOIL CONDITIONING, FERTILIZERS, PESTICIDES AND HERBICIDES; RETAIL STORES FEATURING AGRICULTURAL PRODUCTS AND CHEMICALS, NAMELY, SPRAY ADJUVANTS, SEEDS, SEED TREATMENTS, SOIL CONDITIONING, FERTILIZERS, PESTICIDES AND HERBICIDES; AGRICULTURAL BUSINESS CONSULTING, NAMELY, PROVIDING INFORMATION ON PRODUCTION, MARKETING AND SALE OF AGRICULTURAL PRODUCTS (U.S. CLS. 100, 101 AND 102).

FIRST USE 10-0-1992; IN COMMERCE 10-0-1992.

SN 78-084,748. GEORGIA PUBLIC TELECOMMUNICATIONS COMMISSION, ATLANTA, GA. FILED 9-20-2001.

SMARTISTIC

CLASS 9—ELECTRICAL AND SCIENTIFIC APPARATUS

FOR EDUCATIONAL COMPUTER PROGRAMS AND VIDEO AND AUDIO RECORDINGS CONTAINING MULTIMEDIA COURSES AND CURRICULA FOR USE IN ART INSTRUCTION IN SCHOOLS FROM K THROUGH 12 LEVELS (U.S. CLS. 21, 23, 26, 36 AND 38).

CLASS 16—PAPER GOODS AND PRINTED MATTER

FOR PRINTED EDUCATIONAL MATERIALS CONTAINING COURSES AND CURRICULA FOR USE IN ART INSTRUCTION IN SCHOOLS FROM K THROUGH 12 LEVELS (U.S. CLS. 2, 5, 22, 23, 29, 37, 38 AND 50).

CLASS 41—EDUCATION AND ENTERTAINMENT

FOR EDUCATION AND ENTERTAINMENT SERVICES, NAMELY, PROVIDING COURSES AND CURRICULA FOR USE IN ART INSTRUCTION IN SCHOOLS FOR THE K THROUGH 12 LEVELS THROUGH TELEVISION PROGRAMS AND VIA A GLOBAL COMPUTER NETWORK (U.S. CLS. 100, 101 AND 107).

SECTION 2.— INTERNATIONAL CLASSIFICATION

The short titles associated below with the international class numbers are terms designed merely for quick identification and are not an official part of the international classification. The full names of international classes are given in section 6.1 of the trademark rules of practice.

The designation "U.S. Cl." appearing in this section refers to the U.S. class in effect prior to Sep. 1, 1973 rather than the international class which applies to applications filed on or after that date. For adoption of international classification see notice in the OFFICIAL GAZETTE of Jun. 26, 1973 (911 O.G. TM 210).

Application in one class

CLASS 1—CHEMICALS

SN 75-113,821. DIAGNOCURE INC., SAINTE-FOY, QUEBEC, CANADA, FILED 6-4-1996.

ImmunoCyt

FOR BIOCHEMICAL, NAMELY, MONOCLONAL ANTIBODIES FOR IN VITRO SCIENTIFIC OR CLINICAL LABORATORY USE (U.S. CLS. 1, 5, 6, 10, 26 AND 46).

SN 75-193,839. AIR REFRIGERANTS, L.L.C., METAIRIE, LA. FILED 11-1-1996.

FREE ZONE RB-276

OWNER OF U.S. REG. NO. 2,283,583.
FOR REFRIGERANTS, INCLUDING REFRIGERANTS FOR USE WITH AUTOMOTIVE AIR-CONDITIONING SYSTEMS (U.S. CLS. 1, 5, 6, 10, 26 AND 46).

SN 75-664,314. LANGE, JAMES R, SCOTTSDALE, AZ. FILED 3-19-1999.



NO CLAIM IS MADE TO THE EXCLUSIVE RIGHT TO USE "SOIL", APART FROM THE MARK AS SHOWN.

FOR SOIL STABILIZERS FOR USE IN ROAD, PATHWAY AND PARKING LOT CONSTRUCTION, AND SLOPE PROTECTION; CHEMICALS AND CHEMICAL COMPOUNDS, NAMELY POLYVINYL ACETATE POLYMER USED FOR SOIL STABILIZATION (U.S. CLS. 1, 5, 6, 10, 26 AND 46).

FIRST USE 7-2-1998; IN COMMERCE 7-2-1998.

CLASS 1—(Continued).

SN 76-016,289. UTAH STATE UNIVERSITY, NORTH LOGAN, UT. FILED 4-3-2000.

IMMUNODNA

FOR REAGENTS FOR DETECTION OF BACTERIA, VIRUSES, TOXINS, DRUGS, AND HORMONES IN ENVIRONMENTAL, FOOD, AND BIOMEDICAL SAMPLES FOR USE IN INDUSTRY, SCIENCE, AGRICULTURE, HORTICULTURE, AND FORESTRY; KITS COMPRISED OF REAGENTS FOR DETECTION OF BACTERIA, VIRUSES, TOXINS, DRUGS, AND HORMONES IN ENVIRONMENTAL, FOOD, AND BIOMEDICAL SAMPLES FOR USE IN INDUSTRY, SCIENCE, AGRICULTURE, HORTICULTURE, AND FORESTRY (U.S. CLS. 1, 5, 6, 10, 26 AND 46).

SN 76-077,235. JMG ENTERPRISES, INC., SEWARD, PA. FILED 6-23-2000.

ULTRA BOND 2000

NO CLAIM IS MADE TO THE EXCLUSIVE RIGHT TO USE "BOND", APART FROM THE MARK AS SHOWN.

FOR SYNTHETIC WATER EMULSIFIED PETROLEUM RESINS AND BINDING AGENTS USED FOR DUST SUPPRESSING AND SOIL STABILIZATION (U.S. CLS. 1, 5, 6, 10, 26 AND 46).

FIRST USE 1-6-2000; IN COMMERCE 1-6-2000.

SN 76-105,420. ERICH NUSSLE OHG, D-72202 NAGOLD, FED REP GERMANY, FILED 8-8-2000.

VACUCOAT

PRIORITY CLAIMED UNDER SEC. 44(D) ON FED REP GERMANY APPLICATION NO. 300093357/01, FILED 2-10-2000, REG. NO. 30009335, DATED 6-28-2000, EXPIRES 2-28-2010.

FOR INDUSTRIAL CHEMICALS; NAMELY, CHEMICALS FOR PROTECTION AGAINST DIFFUSION, FOR QUENCHING AND SURFACE PROTECTION DURING HEAT TREATMENT OF METALS, ESPECIALLY TAMPERING, QUENCHING AND PRESERVATIVE AGENTS (U.S. CLS. 1, 5, 6, 10, 26 AND 46).

CLASS 1—(Continued).

SN 76-122,672. SCOTT-GROSS CO., INC., LEXINGTON, KY. FILED 9-5-2000.

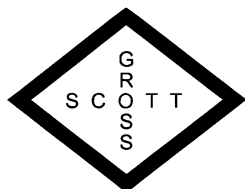

FOR INDUSTRIAL GASES AND CRYOGENIC LIQUIDS FOR USE IN WELDING, CUTTING METALS AND MANUFACTURING PROCESSES IN MANUFACTURING PLANTS AND CRYOGENIC LIQUIDS FOR USE IN HOSPITALS AND PHYSICIAN'S OFFICES (U.S. CLS. 1, 5, 6, 10, 26 AND 46).
FIRST USE 3-1-1992; IN COMMERCE 1-23-1995.

SN 76-127,178. NUTRATECH, INC., FAIRFIELD, NJ. FILED 9-12-2000.

CALDROITIN

FOR CHEMICAL RAW MATERIALS FOR THE MANUFACTURE OF HEALTH AND NUTRITIONAL SUPPLEMENTS (U.S. CLS. 1, 5, 6, 10, 26 AND 46).
FIRST USE 9-15-1999; IN COMMERCE 9-15-1999.

SN 76-127,179. NUTRATECH, INC., FAIRFIELD, NJ. FILED 9-12-2000.

IPRIGEN

FOR CHEMICAL RAW MATERIALS FOR THE MANUFACTURE OF HEALTH AND NUTRITIONAL SUPPLEMENTS (U.S. CLS. 1, 5, 6, 10, 26 AND 46).

SN 76-142,422. IOGEN CORPORATION, OTTAWA, ONTARIO, CANADA, FILED 10-10-2000.

FIBRILASE

PRIORITY CLAIMED UNDER SEC. 44(D) ON CANADA APPLICATION NO. 1066279, FILED 7-6-2000.
FOR ENZYMES FOR USE IN THE TEXTILE INDUSTRY (U.S. CLS. 1, 5, 6, 10, 26 AND 46).
FIRST USE 6-30-2000; IN COMMERCE 6-30-2000.

CLASS 1—(Continued).

SN 76-158,332. CAL INDIA FOODS INTERNATIONAL, DBA SPECIALTY ENZYMES AND BIOCHEMICALS CO., CHINO, CA. FILED 11-2-2000.

SEBCARE

FOR ENZYME PREPARATIONS USED IN THE MANUFACTURE OF PERSONAL CARE PRODUCTS, SHAMPOOS, SOAPS, AND EXFOLIANTS (U.S. CLS. 1, 5, 6, 10, 26 AND 46).

SN 76-206,287. DAP PRODUCTS INC., BALTIMORE, MD. FILED 2-7-2001.

7000

FOR ADHESIVES, NAMELY, CONSTRUCTION ADHESIVES FOR USE IN HOME AND BUILDING CONSTRUCTION, RENOVATION, MAINTENANCE AND REPAIR; ADHESIVES FOR APPLYING SUBFLOOR PLYWOOD; DECK ADHESIVES FOR APPLYING FLOOR TILES TO DECKS (U.S. CLS. 1, 5, 6, 10, 26 AND 46).

SN 76-214,609. UNIMIN CORPORATION, NEW CANAAN, CT. FILED 2-23-2001.

ROYALE

FOR CLAY FOR GENERAL INDUSTRIAL USE (U.S. CLS. 1, 5, 6, 10, 26 AND 46).
FIRST USE 8-0-1998; IN COMMERCE 8-0-1998.

SN 76-219,149. BPSI HOLDINGS, INC., WILMINGTON, DE. FILED 3-2-2001.

ACRYL-EZE

FOR EDIBLE POWDER POLYMER-CONTAINING COMPOSITIONS FOR USE IN THE MANUFACTURE OF FILM COATINGS FOR USE IN ENCAPSULATING PHARMACEUTICALS, FOOD, CONFECTIONARY AND NUTRITIONAL SUPPLEMENT PRODUCTS (U.S. CLS. 1, 5, 6, 10, 26 AND 46).

SN 76-221,347. WILBUR-ELLIS COMPANY, SAN FRANCISCO, CA. FILED 3-7-2001.

MORA-LEAF P&K

OWNER OF U.S. REG. NO. 1,618,271.
NO CLAIM IS MADE TO THE EXCLUSIVE RIGHT TO USE "P" AND "K", APART FROM THE MARK AS SHOWN.
FOR AGRICULTURAL FERTILIZER (U.S. CLS. 1, 5, 6, 10, 26 AND 46).
FIRST USE 3-26-1998; IN COMMERCE 3-26-1998.

CLASS 1—(Continued).

SN 76-240,244. WESTVACO CORPORATION, NEW YORK, NY. FILED 4-16-2001.

ARMOREZ

FOR CORROSION ADDITIVE FOR INKS AND PAINTS (U.S. CLS. 1, 5, 6, 10, 26 AND 46).
FIRST USE 7-15-1999; IN COMMERCE 7-15-1999.

SN 76-259,603. ZYGAM, INC., VISTA, CA. FILED 5-18-2001.

YEASTRACT

FOR LABORATORY RESEARCH TEST KITS COMPRISED PRIMARILY OF DIAGNOSTIC AND REDUCING REAGENTS, TEST TUBES AND GLASS BEADS, FOR REMOVING PROTEINS FROM YEAST CELLS (U.S. CLS. 1, 5, 6, 10, 26 AND 46).
FIRST USE 1-15-2001; IN COMMERCE 4-3-2001.

SN 76-299,364. TOR MINERALS INTERNATIONAL, INC., CORPUS CHRISTI, TX. FILED 8-13-2001.

ALUPREM

FOR ALUMINA CHEMICALS FOR USE IN THE MANUFACTURE OF FLAME RETARDANT PLASTIC AND RUBBER MATERIALS (U.S. CLS. 1, 5, 6, 10, 26 AND 46).

SN 76-307,341. IMPROCROP U.S.A., INC., NICHOLASVILLE, KY. FILED 8-30-2001.

STUBBLE-AID

FOR COMPOSITION FOR PROMOTING RAPID DEGRADATION OF CROP RESIDUE (U.S. CLS. 1, 5, 6, 10, 26 AND 46).
FIRST USE 1-6-1998; IN COMMERCE 1-6-1998.

SN 76-314,190. FRANKLIN INTERNATIONAL, INC., COLUMBUS, OH. FILED 9-19-2001.

HIPURFORMER

FOR POLYURETHANE ADHESIVES (U.S. CLS. 1, 5, 6, 10, 26 AND 46).
FIRST USE 9-14-2001; IN COMMERCE 9-14-2001.

CLASS 1—(Continued).

SN 76-314,333. IMERYS PIGMENTS, INC., ROSWELL, GA. FILED 9-19-2001.

WHITE FORREST

FOR CHEMICAL PREPARATIONS, NAMELY CALCIUM CARBONATES FOR USE AS FILLERS, EXTENDERS, PIGMENTS OR COATINGS IN THE PAPER, PLASTICS AND PAINT INDUSTRIES; KAOLIN FOR USE IN THE PAPER INDUSTRY FOR FILLING AND COATING PAPER AND PAPER BOARD (U.S. CLS. 1, 5, 6, 10, 26 AND 46).

SN 78-037,127. HESTER, MICHELE L., WALDRON, MO. FILED 11-30-2000.

FIBER
etch

OWNER OF U.S. REG. NOS. 1,864,463 AND 2,202,716.
FOR ARTIST MATERIALS ASSISTING THE DECORATION OF FABRIC; NAMELY, CHEMICALS FOR DISSOLVING CELLULOSE FIBERS AND PRINTED INSTRUCTIONAL MATERIALS SOLD THEREWITH (U.S. CLS. 1, 5, 6, 10, 26 AND 46).
FIRST USE 1-10-1994; IN COMMERCE 1-10-1994.

SN 78-040,447. AGRICULTURAL ORGANICS, INC., HOUSTON, TX. FILED 12-22-2000.



NO CLAIM IS MADE TO THE EXCLUSIVE RIGHT TO USE "AGRICULTURAL ORGANIC POULTRY LITTER", "NON BURNING-SLOW RELEASE-ODOR CONTROLLED" AND "REBUILDS THE SOIL", APART FROM THE MARK AS SHOWN.

THE MARK CONSISTS OF THE WORDING "AG-ORG P/L" PLACED ABOVE THE WORDING "AGRICULTURAL ORGANIC POULTRY LITTER". BENEATH THAT APPEARS NUMEROUS VARIETIES OF VEGETABLES AND THEN THE WORDS "NON BURNING-SLOW RELEASE-ODOR CONTROLLED". A FIVE-POINT STAR APPEARS BEHIND ALL OF THE ABOVE. A BANNER STATING "REBUILDS THE SOIL" APPEARS BETWEEN THE BOTTOM TWO POINTS OF THE STAR.

FOR FERTILIZERS FOR AGRICULTURAL AND DOMESTIC USE (U.S. CLS. 1, 5, 6, 10, 26 AND 46).

CLASS 1—(Continued).

SN 78-052,521. SKC AQUISITION, GETTYSBURG, PA. FILED 3-12-2001.

SPECTRA-LOK

FOR GLUE FOR INDUSTRIAL PURPOSES, NAMELY, GLUE FOR THE PAPERBOARD INDUSTRY (U.S. CLS. 1, 5, 6, 10, 26 AND 46).

SN 78-058,623. KAY CHEMICAL COMPANY, GREENSBORO, NC. FILED 4-16-2001.

SAHARA

FOR INDOOR AND OUTDOOR GRANULAR ABSORBENT CELLULOSIC COMPOSITION FOR ABSORBING SPILLS (U.S. CLS. 1, 5, 6, 10, 26 AND 46).
FIRST USE 4-2-2001; IN COMMERCE 4-2-2001.

SN 78-059,508. JH BIOTECH, INC., VENTURA, CA. FILED 4-20-2001.

SUPERZYME

FOR PLANT GROWTH REGULATOR FOR USE IN AGRICULTURE AND HORTICULTURE (U.S. CLS. 1, 5, 6, 10, 26 AND 46).
FIRST USE 3-29-2001; IN COMMERCE 3-29-2001.

SN 78-074,865. ARCH CHEMICALS, INC., NORWALK, CT. FILED 7-20-2001.

CLEAN SHOCK

NO CLAIM IS MADE TO THE EXCLUSIVE RIGHT TO USE "SHOCK", APART FROM THE MARK AS SHOWN.
FOR CHEMICALS USED TO SANITIZE AND TO TREAT DRINKING, WASTE, SWIMMING POOL, SPA AND HOT TUB WATER (U.S. CLS. 1, 5, 6, 10, 26 AND 46).

SN 78-074,867. ARCH CHEMICALS, INC, NORWALK, CT. FILED 7-20-2001.

RAPID SHOCK

NO CLAIM IS MADE TO THE EXCLUSIVE RIGHT TO USE "SHOCK", APART FROM THE MARK AS SHOWN.
FOR CHEMICALS USED TO SANITIZE AND TO TREAT DRINKING, WASTE, SWIMMING POOL, SPA AND HOT TUB WATER (U.S. CLS. 1, 5, 6, 10, 26 AND 46).

CLASS 1—(Continued).

SN 78-074,869. ARCH CHEMICALS, INC., NORWALK, CT. FILED 7-20-2001.

INTENSIVE SHOCK

NO CLAIM IS MADE TO THE EXCLUSIVE RIGHT TO USE "SHOCK", APART FROM THE MARK AS SHOWN.
FOR CHEMICALS USED TO SANITIZE AND TREAT DRINKING, WASTE, SWIMMING POOL, SPA AND HOT TUB WATER (U.S. CLS. 1, 5, 6, 10, 26 AND 46).

SN 78-079,132. HELENA CHEMICAL COMPANY, MEMPHIS, TN. FILED 8-14-2001.

TRAFIX

FOR MICRONUTRIENT FERTILIZERS FOR USE IN AGRICULTURAL AND SPECIALTY CROPS (U.S. CLS. 1, 5, 6, 10, 26 AND 46).

SN 78-080,488. ARCH CHEMICALS, INC., NORWALK, CT. FILED 8-22-2001.

FAST CHLOR

NO CLAIM IS MADE TO THE EXCLUSIVE RIGHT TO USE "FAST", APART FROM THE MARK AS SHOWN.
FOR CHEMICALS USED TO SANITIZE AND TO TREAT WATER, SWIMMING POOLS, SPAS AND HOT TUBS (U.S. CLS. 1, 5, 6, 10, 26 AND 46).

SN 78-084,646. J.M. HUBER CORPORATION, EDISON, NJ. FILED 9-20-2001.

ZEOCAL

FOR CALCIUM SILICATE FOR USE AS A FILLER IN INDUSTRIAL APPLICATIONS (U.S. CLS. 1, 5, 6, 10, 26 AND 46).

CLASS 2—PAINTS

SN 75-595,849. STEVENSON, MICHAEL J., CLARKDALE, AZ. FILED 11-25-1998.

WATERCOLORS

FOR PERMANENT POLYMER OF COLOR PIGMENTS SUSPENDED IN A SOLVENT-BASED LIQUID FOR APPLYING COATINGS, GRAPHICS, LABELS OR IDENTIFICATION INFORMATION BY SPRAY ONTO POLYETHYLENE PRODUCTS (U.S. CLS. 6, 11 AND 16).
FIRST USE 7-1-1998; IN COMMERCE 7-1-1998.

CLASS 2—(Continued).

SN 75-660,581. E. ALKO, INC., DBA LASER IMAGING INTERNATIONAL, CANOGA PARK, CA. FILED 3-15-1999.



NO CLAIM IS MADE TO THE EXCLUSIVE RIGHT TO USE "LASER IMAGING INTERNATIONAL", APART FROM THE MARK AS SHOWN.

FOR REMANUFACTURED TONER CARTRIDGES FOR LASER PRINTERS, COPIERS, INK JET PRINTERS AND FACSIMILE MACHINES, COPIER DRUMS CARTRIDGES (U.S. CLS. 6, 11 AND 16).

FIRST USE 1-11-1999; IN COMMERCE 1-11-1999.

SN 75-738,505. NANOPHASE TECHNOLOGIES CORPORATION, BURR RIDGE, IL. FILED 6-28-1999.

NANOSHIELD

FOR NANOCRYSTALLINE MATERIAL IN THE NATURE OF A COATING TO PROVIDING ELECTRICAL CONDUCTIVITY, ABRASION RESISTANCE, ULTRAVIOLET PROTECTION AND CORROSION RESISTANCE (U.S. CLS. 6, 11 AND 16).

SN 75-808,101. MASTERCHEM INDUSTRIES, INC., IMPERIAL, MO. FILED 9-24-1999.



FOR INTERIOR AND EXTERIOR PAINTS, VARNISHES AND WATERPROOFING SEALER COATINGS FOR SURFACES (U.S. CLS. 6, 11 AND 16).

CLASS 2—(Continued).

SN 76-097,299. ENVIRONMENTAL PROTECTIVE COATINGS, INC., LEXINGTON, KY. BY CHANGE OF NAME ENVIRONMENTAL COATING SYSTEMS, CORPORATION, LEXINGTON, KY. FILED 7-26-2000.

STEEL OVERCOAT SYSTEMS

OWNER OF U.S. REG. NO. 2,170,588.
NO CLAIM IS MADE TO THE EXCLUSIVE RIGHT TO USE "SYSTEMS", APART FROM THE MARK AS SHOWN.
SEC. 2(F).

FOR SEALER COATINGS, PRIMERS AND ANTI-CORROSION PAINT TYPE COATING FOR METALS, CONCRETE AND OTHER HARD SURFACES (U.S. CLS. 6, 11 AND 16).

FIRST USE 3-5-1995; IN COMMERCE 3-5-1995.

SN 76-138,913. BEHR PROCESS CORPORATION, SANTA ANA, CA. FILED 10-2-2000.



NO CLAIM IS MADE TO THE EXCLUSIVE RIGHT TO USE "DECORATIVE FINISHES", APART FROM THE MARK AS SHOWN.

FOR INTERIOR PAINT, GLAZE AND VARNISH (U.S. CLS. 6, 11 AND 16).

SN 76-245,373. DELFIELD COMPANY, THE, MOUNT PLEASANT, MI. FILED 3-30-2001.

DELRITE

FOR PROTECTIVE SCRATCH RESISTANT AND INSULTING COATINGS, NAMELY ACRYONITRILE BUTADIENE STYRENE FOR USE ON FOOD SERVICE EQUIPMENT, REFRIGERATORS, STORAGE DRAWS AND CABINETS (U.S. CLS. 6, 11 AND 16).

FIRST USE 0-0-1972; IN COMMERCE 0-0-1972.

SN 76-304,231. LIU, KUI FANG, ARCADIA, CA. FILED 8-24-2001.

P&O

FOR INTERIOR AND EXTERIOR PAINTS (U.S. CLS. 6, 11 AND 16).

FIRST USE 7-1-2001; IN COMMERCE 7-1-2001.

CLASS 2—(Continued).

SN 76-313,277. KONICA BUSINESS TECHNOLOGIES, INC., WINDSOR, CT. FILED 9-17-2001.

SIMITRI

FOR TONER (U.S. CLS. 6, 11 AND 16).

CLASS 3—COSMETICS AND CLEANING PREPARATIONS

SN 75-565,142. BONAKEMI USA, INCORPORATED, AURORA, CO. FILED 10-6-1998.



OWNER OF U.S. REG. NOS. 1,785,096 AND 2,011,513. FOR CLEANING PREPARATIONS, NAMELY FLOOR CLEANER (U.S. CLS. 1, 4, 6, 50, 51 AND 52). FIRST USE 9-17-1998; IN COMMERCE 9-17-1999.

SN 75-721,739. MILANO COSMETICS S.R.L, 20149 MILAN, ITALY, FILED 6-4-1999.

KIKO

OWNER OF ITALY REG. NO. 809072, DATED 3-24-2000, EXPIRES 4-12-2009.

OWNER OF ERPN CMNTY TM OFC REG. NO. 809072, DATED 11-5-1997, EXPIRES 4-12-2009.

FOR PERFUMES, TOILET SOAPS, COSMETICS, NAMELY DEODORANTS FOR PERSONAL USE; CREAMS, LOTIONS AND OILS FOR THE FACE AND THE BODY; SKIN CLEANSING MILKS, SKIN CREAMS AND BODY OILS; MAKE-UP CREAMS; BEAUTY MASKS; MAKE-UP REMOVERS; EYE SHADOWS; LIPSTICKS; MASCARA; ROUGE; CRAYONS FOR THE EYES AND THE LIPS; POWDERS, CREAMS, OILS AND LOTIONS FOR SUNTANNING AND AFTER SUN EXPOSURE; PRE-AND AFTER SHAVE LOTIONS; TALCUM POWDERS, BATH SALTS, BATH FOAM, BATH OIL; AFTER-BATH CREAMS AND LOTIONS; HAIR SHAMPOO; DEPILATORY PREPARATIONS; ENAMELS, NAIL POLISHES; HAIR LOTIONS (U.S. CLS. 1, 4, 6, 50, 51 AND 52).

SN 75-744,708. BRIGHT INTERNATIONAL CORP, COOLIDGE, AZ. FILED 7-7-1999.

BLOND BRILLIANCE

FOR HAIR CARE PRODUCTS - NAMELY, HAIR TINTING, DYING, BLEACHING AND COLOR PREPARATIONS (U.S. CLS. 1, 4, 6, 50, 51 AND 52).

FIRST USE 1-0-1997; IN COMMERCE 1-0-1997.

CLASS 3—(Continued).

SN 75-767,717. BATE, DAVID J., DBA ENVIRO SUPPLY, LLC, MONROE, CT. AND LE FEBURE, BRUCE A., DBA ENVIRO SUPPLY, LLC, MONROE, CT. FILED 8-3-1999.

NU-WALL

FOR CHEMICAL CLEANERS FOR REMOVING SUBSTANCES FROM STONE AND TILE SURFACES (U.S. CLS. 1, 4, 6, 50, 51 AND 52).

SN 75-876,145. CLEAN CONTROL CORPORATION, WARNER ROBINS, GA. FILED 12-21-1999.

NATURAL ALTERNATIVE

FOR ALL PURPOSE CLEANING PREPARATIONS (U.S. CLS. 1, 4, 6, 50, 51 AND 52).

SN 75-886,232. KEY BRANDS INTERNATIONAL, LTD., IRWINDALE, CA. FILED 1-3-2000.

VITAL PLUS

FOR HAIR CARE PRODUCTS, NAMELY SHAMPOOS, CONDITIONERS AND STYLING GELS (U.S. CLS. 1, 4, 6, 50, 51 AND 52).

FIRST USE 8-31-1999; IN COMMERCE 8-31-1999.

SN 75-897,361. I.P. & C. S.R.L. ITALIAN PERFUMS & COSMETICS, 80134 NAPOLI, ITALY, FILED 1-14-2000.



THE STIPPLING SHOWN IN THE DRAWING DOES NOT INDICATE COLOR, BUT RATHER IS A DESIGN ELEMENT. THE ENGLISH TRANSLATION OF THE ITALIAN PHRASE "ACQUA CLASSICA" IS "CLASSICAL WATERS" AND THE ENGLISH TRANSLATION OF THE ITALIAN NAME "NAPOLI" IS "NAPLES".

FOR PERFUMES (U.S. CLS. 1, 4, 6, 50, 51 AND 52).

CLASS 3—(Continued).

SN 75-917,400. WELLA AG, FED REP GERMANY, FILED 2-14-2000.

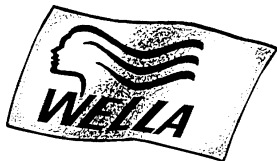

OWNER OF FED REP GERMANY REG. NO. 39948669, DATED 8-12-1999, EXPIRES 8-12-2009.

THE STIPPLING SHOWN IN THE DRAWING IS FOR SHADING PURPOSES ONLY; THE LINING IS A FEATURE OF THE MARK NOT INTENDED TO INDICATE COLOR.

FOR HAIR CARE PREPARATIONS, NAMELY, SHAMPOO, CONDITIONER, RESTRUCTURIZER, CONDITIONERS FOR THE SCALP, HAIR COLORS, DYES AND BLEACHES, HAIR WAVING PREPARATIONS, AND HAIR STYLING PREPARATIONS IN THE FORM OF SPRAYS, SPRAY GELS, GELS, MOUSSES, CREAMS, LOTIONS, POMADES AND WAXES (U.S. CLS. 1, 4, 6, 50, 51 AND 52).

SN 75-917,401. WELLA AG, FED REP GERMANY, FILED 2-14-2000.

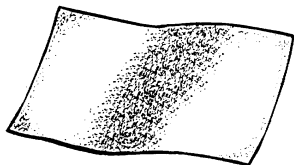

PRIORITY CLAIMED UNDER SEC. 44(D) ON FED REP GERMANY APPLICATION NO. 39948670, FILED 8-12-1999.

THE STIPPLING SHOWN IN THE DRAWING IS FOR SHADING PURPOSES ONLY.

FOR HAIR CARE PREPARATIONS, NAMELY, SHAMPOO, CONDITIONER, RESTRUCTURIZER, CONDITIONERS FOR THE SCALP, HAIR COLORS, DYES AND BLEACHES, HAIR WAVING PREPARATIONS, AND HAIR STYLING PREPARATIONS IN THE FORM OF SPRAYS, SPRAY GELS, GELS, MOUSSES, CREAMS, LOTIONS, POMADES AND WAXES (U.S. CLS. 1, 4, 6, 50, 51 AND 52).

SN 75-979,801. LIPPMANN, DEBORAH, NEW YORK, NY, FILED 6-25-1999.

LIPPMANN COLLECTION

NO CLAIM IS MADE TO THE EXCLUSIVE RIGHT TO USE "COLLECTION", APART FROM THE MARK AS SHOWN.

SEC. 2(F).

FOR NAIL PRODUCTS, NAMELY NAIL LACQUER, CUTICLE OIL, NAIL ENAMEL, NAIL POLISH, NAIL POLISH REMOVER, NAIL POLISH TOP COAT, NAIL POLISH QUICK DRY TOP COAT, NAIL STRENGTHENERS, CUTICLE CREAM, CUTICLE REMOVING PREPARATIONS, NAIL RIDGE FILLERS, HAND AND FOOT CREAMS, HAND AND FOOT EXFOLIANTS, BEAUTY MASKS FOR HAND AND FOOT (U.S. CLS. 1, 4, 6, 50, 51 AND 52).

FIRST USE 9-7-1999; IN COMMERCE 9-7-1999.

CLASS 3—(Continued).

SN 75-981,251. PRL USA HOLDINGS, INC., WILMINGTON, DE. FILED 7-18-2000.

RALPH

OWNER OF U.S. REG. NOS. 1,671,467, 2,363,328 AND OTHERS.

THE NAME SHOWN IN THE MARK IDENTIFIES A LIVING INDIVIDUAL WHOSE CONSENT IS OF RECORD.

FOR EAU DE TOILETTE, SKIN AND BODY LOTIONS (U.S. CLS. 1, 4, 6, 50, 51 AND 52).

FIRST USE 9-15-2000; IN COMMERCE 9-15-2000.

SN 76-037,929. KELEMATA S.P.A., 10121 TORINO, ITALY, FILED 5-1-2000.

BED & BREAKFAST

OWNER OF ITALY REG. NO. 805200, DATED 8-6-1999, EXPIRES 8-6-2009.

FOR COSMETICS (U.S. CLS. 1, 4, 6, 50, 51 AND 52).

SN 76-055,142. MIMOR DISTRIBUTOR, INC., E. RUTHERFORD, NJ. FILED 5-24-2000.

LUKS FAVIOLA CARRET

THE MARK DOES NOT IDENTIFY A LIVING INDIVIDUAL WHOSE CONSENT IS OF RECORD.

FOR HAIR CARE PREPARATIONS (U.S. CLS. 1, 4, 6, 50, 51 AND 52).

SN 76-074,890. MARY KAY INC., DALLAS, TX. FILED 6-21-2000.

SATIN LIPS

NO CLAIM IS MADE TO THE EXCLUSIVE RIGHT TO USE "LIPS", APART FROM THE MARK AS SHOWN.

FOR LIP CARE KIT, CONTAINING LIP CARE PRODUCTS, NAMELY, LIP MASKS, LIP PACKS, LIP COMPRESSES, AND NON-MEDICATED LIP BALMS (U.S. CLS. 1, 4, 6, 50, 51 AND 52).

FIRST USE 11-0-1998; IN COMMERCE 11-0-1998.

SN 76-082,953. KAUFMAN, CONSTANCE C., NEW YORK, NY. FILED 7-5-2000.

.CON

FOR NAIL POLISH AND MAKEUP (U.S. CLS. 1, 4, 6, 50, 51 AND 52).

CLASS 3—(Continued).

SN 76-097,402. JOHN ABATE INTERNATIONAL, INC., SCOTTSDALE, AZ. FILED 7-27-2000.

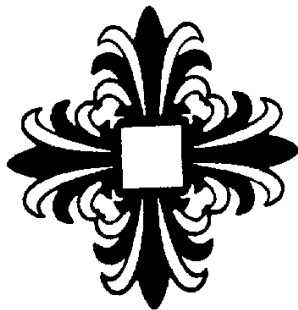

FOR COSMETICS, NAMELY SUNTANNING PREPARATIONS, MOISTURIZER, BODY LOTION (U.S. CLS. 1, 4, 6, 50, 51 AND 52).
FIRST USE 2-15-2000; IN COMMERCE 2-15-2000.

SN 76-107,611. ESTEE LAUDER INC., NEW YORK, NY. FILED 8-11-2000.

BIKINI MAKEUP

NO CLAIM IS MADE TO THE EXCLUSIVE RIGHT TO USE "MAKEUP", APART FROM THE MARK AS SHOWN.
FOR COSMETICS, NAMELY, FOUNDATION MAKEUP FOR THE FACE AND BODY; TOILETRIES/SKIN CARE PREPARATIONS, NAMELY, LOTIONS, GELS, AND CREAMS FOR THE FACE AND BODY, BRONZING STICKS, SELF TANNING LOTIONS, CREAMS, GELS, AND SPRAYS FOR THE FACE AND BODY (U.S. CLS. 1, 4, 6, 50, 51 AND 52).

SN 76-119,368. L'OREAL, 75008 PARIS, FRANCE, FILED 8-30-2000.

GLOSS BOOST

PRIORITY CLAIMED UNDER SEC. 44(D) ON FRANCE APPLICATION NO. 00/3,036,525, FILED 6-23-2000, REG. NO. 003036525, DATED 6-23-2000, EXPIRES 6-23-2010.

NO CLAIM IS MADE TO THE EXCLUSIVE RIGHT TO USE "GLOSS", APART FROM THE MARK AS SHOWN.

FOR SHAMPOOS, GELS, SPRAYS, MOUSSES AND BALMS FOR HAIR STYLING AND HAIR CARE; HAIR LACQUERS; HAIR COLORING AND HAIR DECOLORANT PREPARATIONS; PERMANENT WAVING AND CURLING PREPARATIONS; ESSENTIAL OILS FOR PERSONAL USE (U.S. CLS. 1, 4, 6, 50, 51 AND 52).

CLASS 3—(Continued).

SN 76-119,369. L'OREAL, 75008 PARIS, FRANCE, FILED 8-30-2000.

FIX BOOST

PRIORITY CLAIMED UNDER SEC. 44(D) ON FRANCE APPLICATION NO. 00/3,036,526, FILED 6-23-2000, REG. NO. 003036526, DATED 6-23-2000, EXPIRES 6-23-2010.

FOR SHAMPOOS, GELS, SPRAYS, MOUSSES AND BALMS FOR HAIR STYLING AND HAIR CARE; HAIR LACQUERS; HAIR COLORING AND HAIR DECOLORANT PREPARATIONS; PERMANENT WAVING AND CURLING PREPARATIONS; ESSENTIAL OILS FOR PERSONAL USE (U.S. CLS. 1, 4, 6, 50, 51 AND 52).

SN 76-130,406. HINTEREGGER, KARINA, A-5020 SALZBURG, AUSTRIA, FILED 9-18-2000.



OWNER OF AUSTRIA REG. NO. 167339, DATED 12-4-1996, EXPIRES 12-4-2006.

FOR COSMETICS, NAMELY, LIP STICK, LIP GLOSS, EYE SHADOW, EYE LASH MASCARA, EYE BROW MASCARA, EYE LINER, LIP PENCIL, EYE PENCIL, EYE BROW PENCIL, ROUGE, MAKE-UP, FACE POWDER, NAIL POLISH, FACE CREAM, BODY CREAM, GLITTER GEL, GLITTER POWDER, SHOWER GEL, BATH OIL, SUN CREAM, BODY POWDER, SELF-TANNING CREAM, COLOR SPRAY, GLITTER SPRAY, SUN PROTECTION SPRAY, SELF-TANNING SPRAY, GLITTER SPRAY, KAJAL, BODY OIL, LIP BALM, EYE CARE, BODY SPRAY, FRAGRANCES, PERFUME, EAU DE TOILETTE, AND BODY AND FACE PAINT PENCIL; HAIR COLORING PRODUCTS, NAMELY, SEMI-PERMANENT AND PERMANENT HAIR COLOR, COLORING SHAMPOO, BLEACHING CREAM, BLEACHING POWDER, HIGH LIGHTING GELS AND SOLUTIONS, AND HENNA POWDER; AND HAIR CARE PRODUCTS, NAMELY, SHAMPOO, HAIR GEL, HAIR SPRAY, HAIR CONDITIONER, HAIR RINSE, HAIR OIL, HAIR CREAM, HAIR WAX, COLOR WAX, HAIR MASCARA, CONDITIONER, HAIR TREATMENT, FINISH SPRAY, AND STYLING FOAM (U.S. CLS. 1, 4, 6, 50, 51 AND 52).

SN 76-133,166. GATEWAY PROCLEAN, INC., ST. CHARLES, MO. FILED 9-21-2000.

PRO-NET

FOR HOUSE MARK FOR A FULL LINE OF ALL PURPOSE CLEANERS, SANITIZERS, RINSE AGENTS, DEGREASERS NOT USED IN MANUFACTURING PROCESSES, AND DETERGENTS FOR INDUSTRIAL AND INSTITUTIONAL USE; GENERAL HOUSEKEEPING SUPPLIES FOR INDUSTRIAL AND INSTITUTIONAL USE, NAMELY TUB AND TILE CLEANERS, TOILET BOWL CLEANERS, ALL PURPOSE CLEANERS, BATHROOM CLEANERS, CARPET CLEANERS, DISHWASHING DETERGENTS, WINDOW CLEANERS, SILVERWARE PRESOAKS, LAUNDRY DETERGENTS, BLEACHING AGENTS, FABRIC SOFTENERS, SCOURERS, AND PRESPOTTERS (U.S. CLS. 1, 4, 6, 50, 51 AND 52).

CLASS 3—(Continued).

SN 76-141,546. DI GIULIO CHIROPRACTIC, INC., BURBANK, CA. FILED 10-6-2000.



NO CLAIM IS MADE TO THE EXCLUSIVE RIGHT TO USE "SKIN CARE", APART FROM THE MARK AS SHOWN.

THE MARK CONSISTS OF A CITY SQUARE WITH A BACKGROUND CONSISTING OF A CLASSIC HISTORICAL PALACE RESEMBLING A FORTRESS IN THE UPPER LEVEL AND A BELL TOWER STANDING HIGH ON THE LEFT HAND SIDE. THE WORD "SIENABELLA" IS SEEN IN THE FOREGROUND ALONG WITH AN ELEGANT LADY SEEN FROM THE BACK WHO CARRIES A BOUQUET OF FLOWERS ON HER RIGHT HAND, WHILE DROPPING PETALS OF FLOWERS WITH HER LEFT HAND THROUGHOUT THE PAVEMENT OF THE SQUARE.

THE ENGLISH TRANSLATION OF "SIENABELLA" IS "BEAUTIFUL SIENA".

FOR PERSONAL CARE PRODUCTS, NAMELY, SKIN LOTIONS, BODY LOTIONS, MOISTURIZING LOTIONS, HAND LOTIONS, FACE LOTIONS, HAIR SHAMPOOS, HAIR CONDITIONERS, FACIAL OILS, BODY OILS, MASSAGE OILS, HAIR AND SCALP OILS, FACIAL MASKS, TONERS AND MOISTURIZERS, SKIN CLEANSING PREPARATIONS, FACIAL CLEANSERS, FACIALS EXFOLIANTS, FACE CREAMS, FACIAL SCRUBS, FACE AND BODY MASKS, BODY CREAMS, HAND CREAMS, COLD CREAMS, NIGHT CREAMS, SUN-BLOCK LOTIONS, PERSONAL DEODORANTS, HAND AND BODY SOAPS, TOILET SOAPS, SHAVING CREAMS, SHAVING FOAMS, PRE-SHAVE LOTIONS, AFTER-SHAVE LOTIONS; PERFUMES, NAMELY, EAU DE PERFUME, TOILET WATER, COLOGNE; ESSENTIAL OILS FOR PERSONAL USE AND FOR USE AS INGREDIENTS IN THE MANUFACTURING OF COSMETIC PREPARATIONS (U.S. CLS. 1, 4, 6, 50, 51 AND 52).

CLASS 3—(Continued).

SN 76-147,700. PRECIOUS OFFERINGS MINERAL EXCHANGE, INC., RIFLE, CO. FILED 10-13-2000.



FOR NATURAL MINERAL AND MINERALIZED BATH AND BEAUTY PRODUCTS, NAMELY, BATH MINERALS, BUBBLES, GELS, CRYSTALS, OILS, POWDERS AND SALTS, HAIR CARE PREPARATIONS, HAIR AND SKIN CLEANSERS AND TEXTURIZERS, HAIR CLEANING PREPARATIONS, HAIR STYLING PREPARATIONS, SKIN LOTIONS, CREAMS, TONERS, SPRITZERS, SKIN ABRASIVE PREPARATIONS, FACIAL LOTIONS, BODY LOTIONS, SOAP, PERSONAL DEODORANT, BEAUTY AND BODY MASKS, EYE MASKS, FACIAL MASKS, BODY MASK CREAMS, FACE AND BODY WRAPS, MUD BATHS, ESSENTIAL OILS FOR PERSONAL USE, MASSAGE AND BODY OILS, AROMATHERAPY OILS, BODY AND FACIAL EMULSIONS, NAIL CARE PREPARATIONS, NAIL CREAMS (U.S. CLS. 1, 4, 6, 50, 51 AND 52).

SN 76-153,033. GUTHY-RENKER CORPORATION, PALM DESERT, CA. FILED 10-24-2000.

BRIGHT MAGIC

FOR SKIN AND BODY CARE PREPARATIONS NAMELY, SKIN CLEANSERS, SKIN MOISTURIZERS, SKIN LOTIONS, SKIN SOAPS, NON-MEDICATED HAIR CARE PREPARATIONS, NAIL CARE PREPARATIONS, COLOGNE, PERFUME, TOOTH WHITENING GEL, TOOTH WHITENING PASTE, COSMETICS NAMELY, LIP STICKS, LIP PENCILS, LIP GLOSS, FACE POWDERS, BLUSHERS, FACIAL MAKEUP, EYE MAKEUP, CONCEALERS, SKIN LIGHTENERS, FOUNDATION MAKEUP, SUNSCREEN PREPARATIONS, EYE SHADOWS, EYE LINERS, EYE PENCILS, EYEBROW PENCILS, AND MASCARA (U.S. CLS. 1, 4, 6, 50, 51 AND 52).

SN 76-161,576. STEARNS PACKAGING CORPORATION, MADISON, WI. FILED 11-8-2000.

VALLEY VIEW

FOR CLEANING PRODUCTS, NAMELY, WINDOW CLEANER, AMMONIA FOR CLEANING PURPOSES, DISH DETERGENT AND ALL PURPOSE HOUSEHOLD CLEANERS (U.S. CLS. 1, 4, 6, 50, 51 AND 52).
FIRST USE 4-0-1993; IN COMMERCE 4-0-1993.

CLASS 3—(Continued).

SN 76-163,810. STILA COSMETICS, INC., LOS ANGELES, CA. FILED 11-13-2000.

LASH BOOST

NO CLAIM IS MADE TO THE EXCLUSIVE RIGHT TO USE "LASH", APART FROM THE MARK AS SHOWN.
 FOR COSMETICS, NAMELY, EYE LASH ENHANCER, EYE LASH PRIMER AND EYE LASH UNDERCOAT (U.S. CLS. 1, 4, 6, 50, 51 AND 52).

SN 76-165,909. SUMMERS LABORATORIES, INC., COLLEGEVILLE, PA. FILED 11-9-2000.

CUTEMOL

FOR SKIN CARE PRODUCTS, NAMELY, EMOLLIENT CREAM FOR THE SKIN (U.S. CLS. 1, 4, 6, 50, 51 AND 52).
 FIRST USE 12-1-1972; IN COMMERCE 12-1-1972.

SN 76-167,903. ROUX LABORATORIES, INC., JACKSONVILLE, FL. FILED 11-20-2000.

**THE POWER TO CREATE
 HAIR SYNERGY**

FOR HAIR CARE PRODUCTS, NAMELY, HAIR RELAXERS, SHAMPOOS, CONDITIONERS AND HAIR STYLING PREPARATIONS (U.S. CLS. 1, 4, 6, 50, 51 AND 52).

SN 76-179,191. MITSUI COSMETICS CO., LTD., TOKYO, JAPAN, FILED 12-12-2000.

SATIN D'OR

OWNER OF U.S. REG. NO. 1,608,759.
 THE ENGLISH TRANSLATION OF "SATIN D'OR" IS "SATIN OF GOLD".
 FOR NON-MEDICATED COSMETICS, NAMELY, SKIN CREAMS, SKIN LOTIONS, FACE CREAMS, FACE LOTIONS, COLD CREAMS, FACIAL CLEANSERS, HAIR LOTIONS, SKIN EMOLLIENT OIL AND ESSENTIAL OILS FOR PERSONAL USE (U.S. CLS. 1, 4, 6, 50, 51 AND 52).

CLASS 3—(Continued).

SN 76-181,640. PARFUMS CARON, 75008 PARIS, FRANCE, FILED 12-15-2000.

**POUR UNE FEMME DE
 CARON**

PRIORITY CLAIMED UNDER SEC. 44(D) ON FRANCE APPLICATION NO. 003039954, FILED 6-30-2000, REG. NO. 003039954, DATED 6-30-2000, EXPIRES 6-30-2010.

OWNER OF U.S. REG. NOS. 164,476, 507,045 AND OTHERS.

NO CLAIM IS MADE TO THE EXCLUSIVE RIGHT TO USE "POUR UNE FEMME", APART FROM THE MARK AS SHOWN.

THE ENGLISH TRANSLATION OF THE WORD "POUR UNE FEMME DE CARON" IN THE MARK IS "FOR A WOMAN BY CARON".

FOR PERFUMERY PRODUCTS, NAMELY, PERFUME EXTRACTS, TOILET WATER, PERFUMED WATER, COLOGNE, ESSENTIAL OILS FOR PERSONAL USE, PREPARATIONS FOR SHOWER AND BATH, NAMELY, NON-MEDICATED BATH SOAP, COSMETICS, BATH GELS, BODY MILKS AND LOTIONS, POWDER FOR THE BODY AND FACE, DEODORANT FOR PERSONAL USE, TOILET SOAPS, SHAMPOOS FOR BODY AND HAIR (U.S. CLS. 1, 4, 6, 50, 51 AND 52).

SN 76-185,165. INTERNATIONAL PRODUCTS CORPORATION, BURLINGTON, NJ. FILED 12-21-2000.

LF2100

FOR LIQUID CLEANER USED IN MACHINE BASED WASHING SYSTEMS (U.S. CLS. 1, 4, 6, 50, 51 AND 52).
 FIRST USE 8-15-2000; IN COMMERCE 10-4-2000.

SN 76-196,462. SANOX L.L.C., HOUSTON, TX. FILED 1-19-2001.

CIPET

FOR MULTI-PURPOSE, RESIDUE FREE DETERGENT FOR CLEANING FOOD SERVICE EQUIPMENT (U.S. CLS. 1, 4, 6, 50, 51 AND 52).

SN 76-197,369. SILIPOS INC., NEW YORK, NY. FILED 1-22-2001.

GELIGNE

OWNER OF U.S. REG. NOS. 2,276,238 AND 2,312,022.
 FOR NON-MEDICATED GELATINOUS POLYMER IN VARIOUS SHAPES FOR THE TREATMENT AND MANAGEMENT OF SCARS AND BURNS, FOR MOISTURIZING SKIN CARE AND FOR COSMETIC COMPLEXION ENHANCEMENT (U.S. CLS. 1, 4, 6, 50, 51 AND 52).
 FIRST USE 10-1-1996; IN COMMERCE 10-1-1996.

CLASS 3—(Continued).

SN 76-199,145. GRAHAM WEBB INTERNATIONAL LIMITED PARTNERSHIP, CARLSBAD, CA. FILED 1-24-2001.

PRIVÉ FORMULE AUX HERBES

NO CLAIM IS MADE TO THE EXCLUSIVE RIGHT TO USE "FORMULE AUX HERBES", APART FROM THE MARK AS SHOWN.

THE ENGLISH TRANSLATION OF "PRIVE FORMULE AUX HERBES" IS "PRIVATE HERBAL FORMULA".

FOR HAIR CARE PRODUCTS, NAMELY SHAMPOOS, CONDITIONERS, MOISTURIZING LOTIONS, STYLING MOUSSE, STYLING WAXES, STYLING GELS, POMADES, THICKENING LOTIONS, SMOOTHING SERUMS, TEXTURIZING LOTIONS, SHINING LOTIONS, SMOOTHING LOTIONS, HAIR SPRAY, AND HAIR COLOR; BATH PRODUCTS, NAMELY, SOAPS, BATH GEL, BODY LOTION, AND BODY OIL; SKIN CARE PRODUCTS, NAMELY, SKIN CREAM, CLEANSING LOTIONS, TONERS; AND COSMETICS, NAMELY, EYE SHADOW, EYE PENCILS, MASCARA, FOUNDATION, FACE POWDER, BLUSH, LIP GLOSS, LIPSTICK, AND LIP PENCILS (U.S. CLS. 1, 4, 6, 50, 51 AND 52).

SN 76-204,088. L'OREAL, 75008 PARIS, FRANCE, FILED 2-2-2001.

CHEEK SHAPER

NO CLAIM IS MADE TO THE EXCLUSIVE RIGHT TO USE "CHEEK", APART FROM THE MARK AS SHOWN. FOR BLUSH (U.S. CLS. 1, 4, 6, 50, 51 AND 52).

SN 76-206,388. STILA COSMETICS, INC., LOS ANGELES, CA. FILED 2-7-2001.

LASH GLOSS

NO CLAIM IS MADE TO THE EXCLUSIVE RIGHT TO USE "LASH", APART FROM THE MARK AS SHOWN. FOR COSMETICS, NAMELY, EYELASH ENHANCER, EYELASH PRIMER, EYELASH UNDERCOAT AND MASCARA (U.S. CLS. 1, 4, 6, 50, 51 AND 52).

SN 76-206,389. STILA COSMETICS, INC., LOS ANGELES, CA. FILED 2-7-2001.

LASH POLISH

NO CLAIM IS MADE TO THE EXCLUSIVE RIGHT TO USE "LASH", APART FROM THE MARK AS SHOWN. FOR COSMETICS, NAMELY, EYELASH ENHANCER, EYELASH PRIMER, EYELASH UNDERCOAT AND MASCARA (U.S. CLS. 1, 4, 6, 50, 51 AND 52).

CLASS 3—(Continued).

SN 76-210,211. CHANEL, INC., NEW YORK, NY. FILED 2-14-2001.

TRIPLE COLOUR

NO CLAIM IS MADE TO THE EXCLUSIVE RIGHT TO USE "COLOR", APART FROM THE MARK AS SHOWN. FOR COSMETICS, NAMELY, LIPSTICK, BLUSH, AND EYE MAKEUP (U.S. CLS. 1, 4, 6, 50, 51 AND 52). FIRST USE 4-0-1998; IN COMMERCE 4-0-1998.

SN 76-250,454. HIMALAYAN INTERNATIONAL INSTITUTE OF YOGA SCIENCE AND PHILOSOPHY OF THE USA, HONESDALE, PA. FILED 5-3-2001.

VARCHO VEDA

THE ENGLISH TRANSLATION OF THE SANSKRIT WORDING IS "VIBRANT KNOWLEDGE". FOR SKIN SOAPS, HAIR SHAMPOOS, BODY LOTIONS, AND MASSAGE OILS (U.S. CLS. 1, 4, 6, 50, 51 AND 52).

SN 76-258,348. CLINIQUE LABORATORIES, INC., NEW YORK, NY. FILED 5-17-2001.

LONG PRETTY LASHES

NO CLAIM IS MADE TO THE EXCLUSIVE RIGHT TO USE "LASHES", APART FROM THE MARK AS SHOWN. FOR COSMETICS (U.S. CLS. 1, 4, 6, 50, 51 AND 52).

SN 76-260,489. CHESEBROUGH-POND'S INC., WILMINGTON, DE. FILED 5-21-2001.

HEALTHY HANDS

OWNER OF U.S. REG. NO. 1,860,619. NO CLAIM IS MADE TO THE EXCLUSIVE RIGHT TO USE "HANDS", APART FROM THE MARK AS SHOWN. FOR SKIN TREATMENT PRODUCTS, NAMELY, MOISTURIZING CREAMS AND LOTIONS (U.S. CLS. 1, 4, 6, 50, 51 AND 52).

SN 76-260,491. CHESEBROUGH-POND'S INC., WILMINGTON, DE. FILED 5-21-2001.

DRAMATIC RESULTS

OWNER OF U.S. REG. NOS. 1,187,294, 1,906,249 AND 2,025,859. FOR SKIN TREATMENT PRODUCTS, NAMELY, HAND CREAM, CREAM CLEANSER, PRE-MOISTENED COSMETIC TOWELETTS, FACE AND NECK MOISTURIZER AND ANTI-WRINKLE/ANTI-AGING CREAM (U.S. CLS. 1, 4, 6, 50, 51 AND 52).

CLASS 3—(Continued).

SN 76-268,397. BOURJOIS, 92200 NEUILLY SUR SEINE, FRANCE, FILED 6-6-2001.

VOLUME GLAMOUR

OWNER OF FRANCE REG. NO. 98/727701, DATED 4-10-1998, EXPIRES 4-10-2008.
OWNER OF U.S. REG. NO. 382,154.
FOR MASCARAS (U.S. CLS. 1, 4, 6, 50, 51 AND 52).

SN 76-272,213. HARD CANDY L.L.C., LOS ANGELES, CA. FILED 6-14-2001.

SAVE THE DAY

FOR COSMETICS, NAMELY, CONCEALERS, BLEMISH CREAMS AND BLEMISH STICKS (U.S. CLS. 1, 4, 6, 50, 51 AND 52).

SN 76-272,875. EPILADY 2000 L.L.C., HATZOR HAGLILIT, ISRAEL, FILED 6-18-2001.

LEGEND

FOR HAIR REMOVER (U.S. CLS. 1, 4, 6, 50, 51 AND 52).

SN 76-274,206. IRON OUT, INC., FORT WAYNE, IN. FILED 6-20-2001.

RUSTY

FOR GENERAL PURPOSE RUST AND STAIN REMOVING PREPARATIONS AND WOOD BLEACHING PREPARATIONS (U.S. CLS. 1, 4, 6, 50, 51 AND 52).
FIRST USE 7-0-2000; IN COMMERCE 7-0-2000.

SN 76-276,543. CHESEBROUGH-POND'S INC., WILMINGTON, DE. FILED 6-25-2001.

HEALTHY HAND ESSENTIALS

OWNER OF U.S. REG. NO. 1,860,619.
NO CLAIM IS MADE TO THE EXCLUSIVE RIGHT TO USE "HANDS", APART FROM THE MARK AS SHOWN.
FOR SKIN PRODUCTS, NAMELY, MOISTURIZING CREAMS AND LOTIONS (U.S. CLS. 1, 4, 6, 50, 51 AND 52).

CLASS 3—(Continued).

SN 76-289,373. AU COURANT LLC, STUDIO CITY, CA. FILED 7-24-2001.

AU COURANT

OWNER OF U.S. REG. NO. 1,894,761.
THE ENGLISH TRANSLATION OF "AU COURANT" IS "UP TO DATE".
FOR SKIN LOTIONS AND CLEANSERS, FOUNDATION MAKEUP, LIPSTICK, BLUSH AND EYE SHADOW (U.S. CLS. 1, 4, 6, 50, 51 AND 52).
FIRST USE 5-20-1992; IN COMMERCE 6-1-1993.

SN 76-299,911. HELENE CURTIS, INC., WILMINGTON, DE. FILED 8-13-2001.

COOL RUSH

FOR ANTIPERSPIRANT AND DEODORANT FOR PERSONAL USE (U.S. CLS. 1, 4, 6, 50, 51 AND 52).

SN 76-306,298. H.C.T.V., INC., MONTGOMERYVILLE, PA. FILED 8-29-2001.

TONI'S SEA SECRET

FOR EXFOLIATING AND MOISTURIZING SALT AND OIL COMPOSITION FOR BODY PARTS OTHER THAN THE FACE (U.S. CLS. 1, 4, 6, 50, 51 AND 52).

SN 76-307,757. ATELIER ESTHETIQUE, INC., NEW YORK, NY. FILED 8-30-2001.



FOR SKIN CARE PRODUCTS, NAMELY, CLEANSERS, LOTIONS, MOISTURIZERS, TONERS, SUN BLOCK CREAMS AND LOTIONS, NON-MEDICATED SKIN SERUMS, SKIN FADING CREAMS, AND EXFOLIATING GELS, CREAMS AND LOTIONS (U.S. CLS. 1, 4, 6, 50, 51 AND 52).
FIRST USE 8-14-2001; IN COMMERCE 8-14-2001.

CLASS 3—(Continued).

SN 76-307,779. JUDITH JACKSON, INC., GREENWICH, CT. FILED 8-31-2001.

THE GARDEN OF WELL- BEING

FOR FACIAL AND BODY MOISTURIZER, HAND AND BODY LOTION, BATH GEL, AND SOAP FOR THE BODY AND FACE (U.S. CLS. 1, 4, 6, 50, 51 AND 52).

SN 76-308,001. BONNE BELL, INC., LAKEWOOD, OH. FILED 8-31-2001.

LIPTRICITY

FOR LIP COSMETICS, NAMELY LIPSTICK AND LIP GLOSS (U.S. CLS. 1, 4, 6, 50, 51 AND 52).

SN 76-310,286. JOHN FRIEDA PROFESSIONAL HAIR CARE, INC., WILTON, CT. FILED 9-7-2001.

KELP HELP

FOR HAIR CONDITIONING MASQUE (U.S. CLS. 1, 4, 6, 50, 51 AND 52).

SN 76-310,287. JOHN FRIEDA PROFESSIONAL HAIR CARE, INC., WILTON, CT. FILED 9-7-2001.

LIFE PRESERVER

FOR HAIR OIL (U.S. CLS. 1, 4, 6, 50, 51 AND 52).

SN 76-310,328. GO-2, CO., SALT LAKE CITY, UT. FILED 9-7-2001.

PUMP STIK

FOR LIP BALM DISPENSER (U.S. CLS. 1, 4, 6, 50, 51 AND 52).

CLASS 3—(Continued).

SN 78-004,848. JOY'S PRIDE, LLC, POULSBO, WA. FILED 4-19-2000.



FOR COSMETICS, NAMELY FACIAL CLEANSERS, SKIN CREAMS, FACIAL CREAMS, NIGHT CREAMS, VANISHING CREAMS, COLD CREAMS, HAND CREAMS; LOTIONS, NAMELY SKIN MOISTURIZERS, SKIN TONERS, HAIR STYLING LOTIONS; HAIR SHAMPOO AND CONDITIONER; BEAUTY MASKS; COSMETIC REVOLVING PREPARATIONS; PERSONAL ANTIPERSPIRANTS; PERSONAL DEODORANT; MASSAGE OILS; BATH PREPARATIONS, NAMELY NON-MEDICATED SALTS, GELS, CRYSTALS, FOAM, OILS AND POWDER; AND ALL PURPOSE CLEANERS (U.S. CLS. 1, 4, 6, 50, 51 AND 52).

FIRST USE 6-30-1978; IN COMMERCE 1-1-1980.

SN 78-043,075. PRINZING, KRISTEN DIANE, ENCINITAS, CA. FILED 1-13-2001.

LOTION LADY

NO CLAIM IS MADE TO THE EXCLUSIVE RIGHT TO USE "LOTION", APART FROM THE MARK AS SHOWN.

FOR HAND AND BODY LOTION; SCENTED BODY OILS; SKIN CREAM; HAND MADE SKIN SOAPS; SKIN CARE PRODUCTS (U.S. CLS. 1, 4, 6, 50, 51 AND 52).

SN 78-056,152. SURFACE BEAUTY, LLC, HOLMDEL, NJ. FILED 4-1-2001.

HINT TINTED MOISTURIZER

NO CLAIM IS MADE TO THE EXCLUSIVE RIGHT TO USE "TINTED MOISTURIZER", APART FROM THE MARK AS SHOWN.

FOR COSMETICS NAMELY SKIN LOTIONS AND SKIN CREAMS AND MAKEUP AND CONCEALERS (U.S. CLS. 1, 4, 6, 50, 51 AND 52).

SN 78-056,255. ZOTOS INTERNATIONAL, INC., DARIEN, CT. FILED 4-2-2001.

MANAGE IT!

FOR HAIR CONDITIONER (U.S. CLS. 1, 4, 6, 50, 51 AND 52).

CLASS 3—(Continued).

SN 78-056,782. GILLETTE COMPANY, THE, BOSTON, MA.
FILED 4-4-2001.

MELON SPLASH

NO CLAIM IS MADE TO THE EXCLUSIVE RIGHT TO USE "MELON", APART FROM THE MARK AS SHOWN.
FOR SHAVING CREAM, GEL AND LOTION (U.S. CLS. 1, 4, 6, 50, 51 AND 52).

SN 78-057,160. BATH & BODY WORKS, INC., REYNOLDS-
BURG, OH. FILED 4-6-2001.

WISH UPON A STAR

FOR HAIR MASCARA, LIP PAINT, COLOGNE, NAIL POLISH, HAND, FACE AND BODY SOAP, HAIR SPRAY, GLITTER BODY SPLASH, SHOWER GEL, GLITTER BODY LOTION, HAIR GEL, BODY GLITTER, LIP SHINE, LIP GLOSS, LIP TINT, BODY PAINT AND ROOM FRAGRANCE GELS (U.S. CLS. 1, 4, 6, 50, 51 AND 52).

SN 78-058,066. HERBANCOWBOY.COM, INC., SAEGERTOWN, PA. FILED 4-12-2001.

HEALTHY MAN - HEALTHY ENVIRONMENT

FOR COSMETICS, NAMELY, SHAVING CREAM, SKIN MOISTURIZERS, DEODORANT SOAPS, ANTI-WRINKLE CREAM, FACE CREAM, NON MEDICATED LIP BALM, PERSONAL DEODORANTS, AND MAKEUP (U.S. CLS. 1, 4, 6, 50, 51 AND 52).

SN 78-060,261. AT LAST NATURALS, INC., VALHALLA, NY.
FILED 4-25-2001.

LUCKY TIGER BEAN CREAM

OWNER OF U.S. REG. NOS. 321,154 AND 419,775.
NO CLAIM IS MADE TO THE EXCLUSIVE RIGHT TO USE "BEAN CREAM", APART FROM THE MARK AS SHOWN.

FOR SHAVING CREAM, SHAVING GEL, SKIN CONDITIONERS AND SHAVING LOTION (U.S. CLS. 1, 4, 6, 50, 51 AND 52).

CLASS 3—(Continued).

SN 78-060,813. BEN'S BEAUTY SUPPLY, HOUSTON, TX.
FILED 4-27-2001.



NO CLAIM IS MADE TO THE EXCLUSIVE RIGHT TO USE "NATURAL" AND "SHEEN", APART FROM THE MARK AS SHOWN.

FOR HAIR AND SKIN PRODUCTS, NAMELY SHAMPOO, CONDITIONER, STYLING GELS, HAIR POMADES, HAIR TREATMENT PRODUCTS, NAMELY, LEAVE-IN CONDITIONER, BRAID SPRAY, HAIR OIL; SKIN CREAMS (U.S. CLS. 1, 4, 6, 50, 51 AND 52).

SN 78-064,721. RUSK, INCORPORATED, STAMFORD, CT.
FILED 5-21-2001.

RUSK BLONDES

NO CLAIM IS MADE TO THE EXCLUSIVE RIGHT TO USE "BLONDES", APART FROM THE MARK AS SHOWN.

FOR HAIR CARE LIQUIDS, NAMELY, SHAMPOO, CONDITIONERS FOR COLOR TREATED HAIR, AND STYLING PRODUCTS, NAMELY, HAIR GEL, HAIR MOUSSE, AND HAIR SPRAY (U.S. CLS. 1, 4, 6, 50, 51 AND 52).

SN 78-068,680. CHAPMAN, MARYANN BARONE, LONDON, UNITED KINGDOM, FILED 6-12-2001.

SMART BLONDE

FOR SHAMPOOS AND CONDITIONERS; SHAMPOOS AND CONDITIONERS FOR COLOR TREATED HAIR; SHAMPOOS AND CONDITIONERS FOR BLONDE OR BLEACHED HAIR; HAIR LOTIONS, CREAMS, MOUSSES AND SPRAYS FOR TINTING, DYEING OR BLEACHING HAIR; HAIR COLOR; HAIR BLEACHING PREPARATIONS (U.S. CLS. 1, 4, 6, 50, 51 AND 52).

CLASS 3—(Continued).

SN 78-070,219. DAVIDSON, DANIEL L., NEW YORK, NY. FILED 6-20-2001.

GENOME COSMETIQUE

NO CLAIM IS MADE TO THE EXCLUSIVE RIGHT TO USE "COSMETIQUE", APART FROM THE MARK AS SHOWN.

THE ENGLISH TRANSLATION OF THE WORD "COSMETIQUE" IN THE MARK IS "COSMETIC".

FOR SKIN CLEANERS AND IN THE FORM OF LOTION, MILK, CREAM AND JELLY; FACIAL MASK; LOTION, CREAM, MILK, JELLY, OIL AND SPRAY USED FOR THE BODY, HANDS AND FEET; SKIN FRESHENERS; DAY CREAM AND NIGHT CREAM; MOISTURE LOTION, MILK, CREAM, JELLY AND OIL; PREPARATIONS FOR THE EYES AND THE THROAT IN OIL, JELLY, MILK, CREAM AND LOTION FORM; LIQUID MAKE-UP AND MAKEUP IN THE FORM OF STICKS, CREAM AND MILK; FACE POWDER; LIQUID AND CAKE EYE-LINERS; HAIR RINSE, HAIR SPRAYS; BATH OIL, FOAM BATH; DUSTING POWDER; BUBBLE BATH AND RELAXING BUBBLE BATH; LIPSTICK; EYE SHADOW; NAIL POLISH; ROUGE; MILK, CREAM, LOTION, JELLY AND OIL FOR THE LEGS AND ARMS; MASCARA AND EYEBROW PENCILS (U.S. CLS. 1, 4, 6, 50, 51 AND 52).

SN 78-084,668. PROSTRONG, INC., OAKVILLE, CT. FILED 9-20-2001.

PROADVANCED

FOR NAIL CARE PREPARATIONS, NAMELY NAIL POLISH, NAIL ENAMEL, NAIL HARDENER, NAIL STRENGTHENER, NAIL BUILDER, NAIL TREATMENTS, NAIL SEALER, NAIL POLISH BASE COAT AND TOP COAT, NAIL CLEANSER, NAIL POLISH REMOVER, NAIL CONDITIONER, NAIL CREAM, NAIL MOISTURIZER, CUTICLE CONDITIONER, CUTICLE CREAM, AND CUTICLE MOISTURIZER; HAND CARE PREPARATIONS, NAMELY HAND CREAM AND MOISTURIZER (U.S. CLS. 1, 4, 6, 50, 51 AND 52).

SN 78-084,673. PROSTRONG, INC., OAKVILLE, CT. FILED 9-20-2001.

PROFORCE

FOR NAIL CARE PREPARATIONS, NAMELY NAIL POLISH, NAIL ENAMEL, NAIL HARDENER, NAIL STRENGTHENER, NAIL BUILDER, NAIL TREATMENTS, NAIL SEALER, NAIL POLISH BASE COAT AND TOP COAT, NAIL CLEANSER, NAIL POLISH REMOVER, NAIL CONDITIONER, NAIL CREAM, NAIL MOISTURIZER, CUTICLE CONDITIONER, CUTICLE CREAM, AND CUTICLE MOISTURIZER; HAND CARE PREPARATIONS, NAMELY HAND CREAM AND MOISTURIZER (U.S. CLS. 1, 4, 6, 50, 51 AND 52).

CLASS 3—(Continued).

SN 78-084,675. PROSTRONG, INC., OAKVILLE, CT. FILED 9-20-2001.

DOUBLE SHIELD

FOR NAIL CARE PREPARATIONS, NAMELY NAIL POLISH, NAIL ENAMEL, NAIL HARDENER, NAIL STRENGTHENER, NAIL BUILDER, NAIL TREATMENTS, NAIL SEALER, NAIL POLISH BASE COAT AND TOP COAT, NAIL CLEANSER, NAIL POLISH REMOVER, NAIL CONDITIONER, NAIL CREAM, NAIL MOISTURIZER, CUTICLE CONDITIONER, CUTICLE CREAM, AND CUTICLE MOISTURIZER; HAND CARE PREPARATIONS, NAMELY HAND CREAM AND MOISTURIZER (U.S. CLS. 1, 4, 6, 50, 51 AND 52).

SN 78-084,681. PROSTRONG, INC., OAKVILLE, CT. FILED 9-20-2001.

PROMIRROR

FOR NAIL CARE PREPARATIONS, NAMELY NAIL POLISH, NAIL ENAMEL, NAIL HARDENER, NAIL STRENGTHENER, NAIL BUILDER, NAIL TREATMENTS, NAIL SEALER, NAIL POLISH BASE COAT AND TOP COAT, NAIL CLEANSER, NAIL POLISH REMOVER, NAIL CONDITIONER, NAIL CREAM, NAIL MOISTURIZER, CUTICLE CONDITIONER, CUTICLE CREAM, AND CUTICLE MOISTURIZER; HAND CARE PREPARATIONS, NAMELY HAND CREAM AND MOISTURIZER (U.S. CLS. 1, 4, 6, 50, 51 AND 52).

SN 78-084,753. PROCTER & GAMBLE COMPANY, THE, CINCINNATI, OH. FILED 9-20-2001.

SECRET RENEW

OWNER OF U.S. REG. NOS. 645,874 AND 1,351,236. FOR PERSONAL DEODORANTS AND ANTI-PERSPIRANTS (U.S. CLS. 1, 4, 6, 50, 51 AND 52).

CLASS 4—LUBRICANTS AND FUELS

SN 76-035,396. EXXON MOBIL CORPORATION, IRVING, TX. FILED 4-26-2000.

UNIFLO

FOR MOTOR OILS (U.S. CLS. 1, 6 AND 15). FIRST USE 6-21-1996; IN COMMERCE 6-21-1996.

CLASS 4—(Continued).

SN 76-071,341. EXXON MOBIL CORPORATION, IRVING, TX. FILED 6-15-2000.

EXXON CLEAR LITE

OWNER OF U.S. REG. NOS. 902,044, 1,471,065 AND OTHERS.

NO CLAIM IS MADE TO THE EXCLUSIVE RIGHT TO USE "CLEAR", APART FROM THE MARK AS SHOWN.

FOR SYNTHETIC FUEL FOR USE IN PORTABLE STOVES, HEATERS AND LANTERNS (U.S. CLS. 1, 6 AND 15).

SN 76-076,831. QUAKER CHEMICAL CORPORATION, WILMINGTON, DE. FILED 6-23-2000.

QUAKERAL

OWNER OF U.S. REG. NOS. 525,029, 776,481 AND OTHERS.

FOR LUBRICANTS FOR USE IN THE HOT ROLLING OF ALUMINUM SHEET AND PLATE COVERING A VARIETY OF APPLICATIONS, INCLUDING BUT NOT LIMITED TO, THE CONSTRUCTION, TRANSPORTATION, AEROSPACE, PRINTING, FOOD AND BEVERAGE INDUSTRIES (U.S. CLS. 1, 6 AND 15).

FIRST USE 2-28-2000; IN COMMERCE 2-28-2000.

SN 76-162,641. ENCHANTMENT INTERNATIONAL, INC., NEW YORK, NY. FILED 11-10-2000.

CARAPAN

"CARAPAN" IS A NATIVE AMERICAN WORD MEANING "A BEAUTIFUL PLACE OF TRANQUILITY WHERE ONE COMES TO RESTORE ONE'S SPIRIT".

FOR CANDLES (U.S. CLS. 1, 6 AND 15).

FIRST USE 4-0-1998; IN COMMERCE 4-0-1998.

SN 76-199,230. NCH CORPORATION, IRVING, TX. FILED 1-25-2001.



NO CLAIM IS MADE TO THE EXCLUSIVE RIGHT TO USE "SYSTEMS" AND "ESTABLISHED 1979", APART FROM THE MARK AS SHOWN.

FOR GEAR OIL, COMPRESSOR OIL, HYDRAULIC OIL, SPINDLE OIL, ENGINE OIL, TRANSMISSION OIL, TRANSAXLE OIL, LUBRICATING OIL FOR INDUSTRIAL USE, GENERAL PURPOSE LUBRICANTS, LUBRICANT GREASES FOR INDUSTRIAL USE, MOLY LUBRICANT GREASES FOR INDUSTRIAL USE, NON-CHEMICAL FUEL OIL ADDITIVES, NON-CHEMICAL HYDRAULIC FLUID IMPROVER, AND NON-CHEMICAL FUEL IMPROVER (U.S. CLS. 1, 6 AND 15).

CLASS 4—(Continued).

SN 76-200,820. NAN SHAN INTERNATIONAL CO., LTD., TAIPEI, TAIWAN, FILED 1-26-2001.



NO CLAIM IS MADE TO THE EXCLUSIVE RIGHT TO USE "YARD LIGHT", APART FROM THE MARK AS SHOWN.

FOR CANDLES AND COLORED FIRE TORCHES (U.S. CLS. 1, 6 AND 15).

SN 76-249,729. LA CORPORATION TRIBOSPEC/TRIBOSPEC CORPORATION, QUEBEC, CANADA, FILED 5-2-2001.

TRIBOSPEC

OWNER OF CANADA REG. NO. TMA505,295, DATED 12-9-1998, EXPIRES 12-9-2013.

FOR OIL FOR USE IN MANUFACTURING OF PLASTICS, NAMELY, TREATMENT OIL FOR USE AS A LUBRICANT AND DUST SUPPRESSOR IN PLASTIC (U.S. CLS. 1, 6 AND 15).

SN 76-304,074. CANDLE CORPORATION OF AMERICA, DES PLAINES, IL. FILED 8-24-2001.

PEANUT BUTTER COOKIE

FOR CANDLES (U.S. CLS. 1, 6 AND 15).

SN 78-049,426. RUG DOCTOR, L.P., PLANO, TX. FILED 2-21-2001.

CINDY'S CANDLES

NO CLAIM IS MADE TO THE EXCLUSIVE RIGHT TO USE "CANDLES", APART FROM THE MARK AS SHOWN. THE NAME "CINDY" IN THE MARK DOES NOT IDENTIFY ANY PARTICULAR LIVING INDIVIDUAL.

FOR CANDLES AND WICKS FOR CANDLES (U.S. CLS. 1, 6 AND 15).

CLASS 4—(Continued).

SN 78-053,500. MCWHERTER PETROLEUM, LTD., DELAWARE, OH. FILED 3-16-2001.



THE LINING SHOWN IN THE DRAWING IS A FEATURE OF THE MARK AND IS NOT INTENDED TO INDICATE COLOR.

FOR SOY OIL BLENDED WITH DIESEL FUEL FOR ENGINE CONSUMPTION (U.S. CLS. 1, 6 AND 15).

SN 78-059,465. HUDDLESTON, BRUCE C., KAILUA, HI. FILED 4-20-2001.

TC-11

FOR BULK ALL PURPOSE LUBRICANT (U.S. CLS. 1, 6 AND 15).
FIRST USE 3-15-2001; IN COMMERCE 3-29-2001.

SN 78-084,998. BANANA REPUBLIC (APPAREL) INC., SAN BRUNO, CA. FILED 9-21-2001.

BR

FOR CANDLES (U.S. CLS. 1, 6 AND 15).

CLASS 5—PHARMACEUTICALS

SN 75-534,600. A. NELSON & CO LIMITED, LONDON SW19 5LP, UNITED KINGDOM, FILED 8-11-1998.

CLIKPAK

PRIORITY CLAIMED UNDER SEC. 44(D) ON ERPN CMNTY TM OFC APPLICATION NO. 770024, FILED 3-6-1998, REG. NO. 770024, DATED 9-15-1999, EXPIRES 9-15-2009.
FOR FULL LINE OF HOMEOPATHIC PREPARATIONS (U.S. CLS. 6, 18, 44, 46, 51 AND 52).

CLASS 5—(Continued).

SN 75-651,848. KONSTANTINE SARRIS, KIRKLAND, QUEBEC, CANADA, FILED 3-2-1999.

DECA PLEX STACK

NO CLAIM IS MADE TO THE EXCLUSIVE RIGHT TO USE "STACK", APART FROM THE MARK AS SHOWN.
FOR VITAMINS, DIETARY SUPPLEMENTS AND HERBAL SUPPLEMENTS (U.S. CLS. 6, 18, 44, 46, 51 AND 52).

SN 75-674,704. TOKUYAMA CORPORATION, TOKUYAMA, YAMAGUCHI, JAPAN, FILED 4-5-1999.

TOUGHWELL

PRIORITY CLAIMED UNDER SEC. 44(D) ON JAPAN APPLICATION NO. 10-103009, FILED 12-3-1998, REG. NO. 4328133, DATED 10-22-1999, EXPIRES 10-22-2009.

FOR DENTAL PREPARATIONS, NAMELY FILLINGS FOR TEETH, DENTAL COMPOSITE RESINS, DENTAL CEMENTS, ADHESIVES FOR DENTURES, AND ARTIFICIAL TOOTH MATERIALS, NAMELY RESINS FOR MAKING ARTIFICIAL TEETH (U.S. CLS. 6, 18, 44, 46, 51 AND 52).

SN 75-766,983. MINOPHAGEN PHARMACEUTICAL CO., TOKYO 160-0004, JAPAN, FILED 8-3-1999.

GLYCYRON

PRIORITY CLAIMED UNDER SEC. 44(D) ON JAPAN APPLICATION NO. 11-21226, FILED 3-10-1999, REG. NO. 4382412, DATED 5-12-2000, EXPIRES 5-12-2010.

FOR PHARMACEUTICAL PREPARATIONS FOR THE TREATMENT OF ECZEMA, DERMATITIS, URTICARIA, AND FOR THE TREATMENT OF ABNORMAL LIVER FUNCTION RESULTING FROM CHRONIC LIVER DISEASE (U.S. CLS. 6, 18, 44, 46, 51 AND 52).

SN 75-767,071. MINOPHAGEN PHARMACEUTICAL CO., TOKYO 160-0004, JAPAN, FILED 8-3-1999.

MINOPHAGEN

PRIORITY CLAIMED UNDER SEC. 44(D) ON JAPAN APPLICATION NO. 11-21227, FILED 3-10-1999, REG. NO. 4361311, DATED 2-10-2000, EXPIRES 2-10-2010.

FOR PHARMACEUTICAL PREPARATIONS FOR THE TREATMENT OF ECZEMA, DERMATITIS, URTICARIA, AND FOR THE TREATMENT OF ABNORMAL LIVER FUNCTION RESULTING FROM CHRONIC LIVER DISEASE (U.S. CLS. 6, 18, 44, 46, 51 AND 52).

CLASS 5—(Continued).

SN 75-780,742. TEIJIN KABUSHIKI KAISHA, TA TEIJIN LIMITED, CHUO-KU, OSAKA, JAPAN, FILED 8-20-1999.

PATTEL

FOR MEDICINE FOR TREATMENT OF STOMATITIS (U.S. CLS. 6, 18, 44, 46, 51 AND 52).

SN 75-782,024. ULTIMATE NUTRITION, INC., PLAINVILLE, CT. FILED 8-23-1999.

AMINO GOLD

NO CLAIM IS MADE TO THE EXCLUSIVE RIGHT TO USE "AMINO". APART FROM THE MARK AS SHOWN. FOR NUTRITIONAL PRODUCTS, NAMELY DIETARY SUPPLEMENTS (U.S. CLS. 6, 18, 44, 46, 51 AND 52). FIRST USE 1-0-1987; IN COMMERCE 1-0-1987.

SN 75-791,261. KOS PHARMACEUTICALS, INC., MIAMI, FL. FILED 9-2-1999.

ONCE-AT-NIGHT

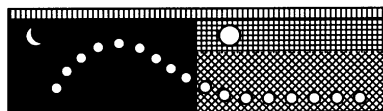

NO CLAIM IS MADE TO THE EXCLUSIVE RIGHT TO USE "ONCE-AT-NIGHT", APART FROM THE MARK AS SHOWN.

THE LINING SHOWN IN THE DRAWING IS A FEATURE OF THE MARK. THE MARK IS LINED FOR THE COLORS ORANGE, YELLOW AND RED.

FOR PHYSICIAN-PRESCRIBED PHARMACEUTICAL PREPARATION FOR THE TREATMENT OF DYSLIPIDEMIA (U.S. CLS. 6, 18, 44, 46, 51 AND 52).

SN 75-848,265. LONGEVITY PLUS, PAYSON, AZ. FILED 11-15-1999.

IMMUNI-T

FOR NUTRACEUTICALS FOR USE AS A DIETARY SUPPLEMENT (U.S. CLS. 6, 18, 44, 46, 51 AND 52). FIRST USE 10-25-1999; IN COMMERCE 10-25-1999.

CLASS 5—(Continued).

SN 75-872,045. MERCK KGAA, D-54293 DARMSTADT, FED REP GERMANY, FILED 12-14-1999.

DEMEXOR

PRIORITY CLAIMED UNDER SEC. 44(D) ON FED REP GERMANY APPLICATION NO. 39940084, FILED 7-9-1999, REG. NO. 39940084, DATED 8-4-1999, EXPIRES 7-31-2009.

FOR PHARMACEUTICAL PREPARATIONS FOR THE TREATMENT OF CANCEROUS DISEASES (U.S. CLS. 6, 18, 44, 46, 51 AND 52).

SN 75-872,282. MERCK KGAA, D-64293 DARMSTADT, FED REP GERMANY, FILED 12-14-1999.

BECITAL

PRIORITY CLAIMED UNDER SEC. 44(D) ON FED REP GERMANY APPLICATION NO. 39940082605, FILED 7-9-1999, REG. NO. 39940082, DATED 8-4-1999, EXPIRES 7-31-2009.

FOR PHARMACEUTICAL PREPARATIONS FOR THE TREATMENT OF CANCEROUS DISEASES (U.S. CLS. 6, 18, 44, 46, 51 AND 52).

SN 75-900,716. UNIQUELIFE, INC., SANTA CLARA, CA. BY ASSIGNMENT UNIQUE LIFE, INC., SANTA CLARA, CA. FILED 1-20-2000.

GLUCOREG

FOR DIETARY SUPPLEMENTS (U.S. CLS. 6, 18, 44, 46, 51 AND 52).

SN 75-924,823. AYURVEDA TRADITIONALS, L.L.C., ALPINE, UT. FILED 2-22-2000.

VETARELAX

FOR DIETARY SUPPLEMENTS FOR HUMAN CONSUMPTION (U.S. CLS. 6, 18, 44, 46, 51 AND 52). FIRST USE 2-12-2000; IN COMMERCE 2-12-2000.

SN 76-009,409. SWISS SERUM AND VACCINE INSTITUTE BERNE, BERNE, SWITZERLAND, FILED 3-24-2000.

NASALFLU

PRIORITY CLAIMED UNDER SEC. 44(D) ON SWITZERLAND APPLICATION NO. 00865/2000, FILED 1-28-2000, REG. NO. 469483, DATED 1-28-2000, EXPIRES 1-28-2010.

FOR NASAL VACCINE AGAINST INFLUENZA (U.S. CLS. 6, 18, 44, 46, 51 AND 52).

CLASS 5—(Continued).

SN 76-011,229. GRAY, DOUGLAS MERVYN, TOOWOOMBA, QUEENSLAND, 4350, AUSTRALIA, AND HOLLOWAY, DAVID WILLIAM, TOOWOOMBA, QUEENSLAND, 4350, AUSTRALIA, FILED 3-27-2000.

CLASS 5—(Continued).

SN 76-031,358. CUBIST PHARMACEUTICALS, INC., CAMBRIDGE, MA. FILED 4-21-2000.

TERMOUT

PRIORITY CLAIMED UNDER SEC. 44(D) ON AUSTRALIA APPLICATION NO. 808693, FILED 9-28-1999, REG. NO. 808693, DATED 9-28-1999, EXPIRES 9-28-2009.

FOR BIOCIDAL PREPARATIONS FOR CONTROL AND EXTERMINATION OF INSECTS, PESTS AND LARVAE, PESTICIDES, INSECTICIDES AND TERMITICIDES, ALL FOR AGRICULTURAL, DOMESTIC AND HORTICULTURAL USE; INSECT REPELLENTS; AND PEST REPELLENTS (U.S. CLS. 6, 18, 44, 46, 51 AND 52).

■ ■ **CIDECIN**_{I.V.}
■ ■ (daptomycin for injection)

SN 76-016,318. IRON-TEK NUTRITION, INC., SYOSSET, NY. FILED 4-3-2000.

PROSNACK

FOR MEAL REPLACEMENT AND NUTRITIONAL SUPPLEMENTS (U.S. CLS. 6, 18, 44, 46, 51 AND 52).

OWNER OF U.S. REG. NO. 2,457,962.

NO CLAIM IS MADE TO THE EXCLUSIVE RIGHT TO USE "I.V." AND "DAPTOMYCIN FOR INJECTION", APART FROM THE MARK AS SHOWN.

FOR ANTIBACTERIALS, ANTIBIOTICS, ANTIMICROBIALS, ANTIFUNGALS, ANTIVIRALS, AND ANTIPARASITE PREPARATIONS (U.S. CLS. 6, 18, 44, 46, 51 AND 52).

SN 76-024,658. ROMANO, EMILIO ALEJANDRO, 1176 CAPITAL FEDERAL, ARGENTINA, FILED 4-13-2000.

RESACA

THE ENGLISH TRANSLATION OF "RESACA" IS "HANG-OVER".

FOR MEDICAL PRODUCTS FOR HUMAN USE, NAMELY, ANTIMIGRAINE, ANALGESICS, ASPIRINS, ANTACID, ANTIFLATULANTS, LIVER PROTECTORS, ANTIFUNGALS, ANTISPASMODICS, CYTO PROTECTIVE AGENTS, ANTIDIARRHOETICS, PHYSIOLOGICAL SLEEPING REGULATORS, OPHTHALMOLOGICAL DROPS, ANALGESIC SLEEPING AID, PAIN RELIEVER AID, ANTIFEBRILES (U.S. CLS. 6, 18, 44, 46, 51 AND 52).

SN 76-052,941. PACIFIC DIRECT INTERNATIONAL CO., FERN PARK, FL. FILED 5-22-2000.

SUPER JIGING

SN 76-029,770. LABORATOIRES CARILENE, 78362 MONTESSON, FRANCE, FILED 4-19-2000.

MICROSHIELD

FOR MEDICATED DENTAL GEL FOR RELIEF OF PAINFUL IRRITATION (U.S. CLS. 6, 18, 44, 46, 51 AND 52).

NO CLAIM IS MADE TO THE EXCLUSIVE RIGHT TO USE "SUPER", APART FROM THE MARK AS SHOWN.

FOR NUTRITIONAL DRINK MIX FOR USE AS A MEAL REPLACEMENT; FOOD SUPPLEMENTS; HERB TEAS FOR MEDICINAL PURPOSES; HERBAL SUPPLEMENTS (U.S. CLS. 6, 18, 44, 46, 51 AND 52).

CLASS 5—(Continued).

SN 76-057,382. NEBRASKA CULTURES, INC., LINCOLN, NE. FILED 5-26-2000.

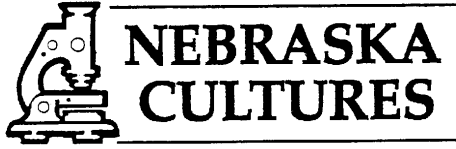

NO CLAIM IS MADE TO THE EXCLUSIVE RIGHT TO USE "NEBRASKA CULTURES", APART FROM THE MARK AS SHOWN.

FOR FOOD, NUTRITION, HEALTH AND DIETARY SUPPLEMENTS IN THE FORM OF POWDERS, LIQUIDS, CAPSULES AND TABLETS, NAMELY PROBIOTICS, DAIRY AND LACTOBACILLUS ACIDOPHILUS, LACTOBACILLUS BREVIS, LACTOBACILLUS BULGARICUS, LACTOBACILLUS CASEI, LACTOBACILLUS CASEI SSP: RHAMNOSUS, LACTOBACILLUS HELVETICUS, LACTOBACILLUS LACTIS, LACTOBACILLUS PLANTARUM, LACTOBACILLUS SALIVARIUS, LACTOBACILLUS SPOROGENES, LACTOBACILLUS BIFIDUM, BIFIDOBACTERIUM BREVE, BIFIDOBACTERIUM INFANTIS, BIFIDOBACTERIUM LONGUM, STREPTOCOCCUS FAECIUM, STREPTOCOCCUS LACTIS, STREPTOCOCCUS THERMOPHILIS, PEDICOCOCUS CERESVIAE CULTURES, VITAMINS, ENZYMES, AMINO ACIDS, CO-FACTORS, AND COMBINATION, COMPOSITIONS AND FORMULATIONS THEREOF (U.S. CLS. 6, 18, 44, 46, 51 AND 52).

FIRST USE 0-0-1989; IN COMMERCE 0-0-1989.

SN 76-074,484. WEIDER NUTRITION INTERNATIONAL, INC., SALT LAKE CITY, UT. FILED 6-21-2000.

DELICIOUS ENERGY

FOR DIETARY FOOD SUPPLEMENTS (U.S. CLS. 6, 18, 44, 46, 51 AND 52).

SN 76-098,945. SMITHKLINE BEECHAM CORPORATION, PHILADELPHIA, PA. FILED 7-28-2000.

TUMS COOL-RELIEF

OWNER OF U.S. REG. NOS. 268,593, 2,240,778 AND OTHERS.

FOR ANTACIDS AND CALCIUM SUPPLEMENTS (U.S. CLS. 6, 18, 44, 46, 51 AND 52).

SN 76-117,603. MENTHOLATUM COMPANY, THE, ORCHARD PARK, NY. FILED 8-28-2000.

DERM URE

FOR COSMETICS, NAMELY, MEDICATED SKIN CREAM (U.S. CLS. 6, 18, 44, 46, 51 AND 52).

CLASS 5—(Continued).

SN 76-118,345. COVENTRY GROUP LTD., CINCINNATI, OH. FILED 8-29-2000.

VITAHEART

FOR NUTRITIONAL SUPPLEMENT (U.S. CLS. 6, 18, 44, 46, 51 AND 52).

SN 76-124,184. I.P. INTERNATIONAL, INC., SEVEN MILE BEACH, CAYMAN ISLANDS, FILED 9-7-2000.

MEMORX

FOR VITAMINS AND NUTRITIONAL SUPPLEMENTS (U.S. CLS. 6, 18, 44, 46, 51 AND 52).

SN 76-135,378. SYNERGY COMPANY OF UTAH, THE, MOAB, UT. FILED 9-27-2000.

SYNERGIZED

FOR NUTRITIONAL SUPPLEMENTS (U.S. CLS. 6, 18, 44, 46, 51 AND 52).

SN 76-136,187. BORNER GMBH, 12347 BERLIN, FED REP GERMANY, FILED 9-27-2000.

SANHELIOS CIRCU CAPS

OWNER OF U.S. REG. NOS. 619,806 AND 1,430,820. NO CLAIM IS MADE TO THE EXCLUSIVE RIGHT TO USE "CAPS", APART FROM THE MARK AS SHOWN. FOR DIETARY SUPPLEMENTS (U.S. CLS. 6, 18, 44, 46, 51 AND 52). FIRST USE 0-0-1981; IN COMMERCE 0-0-1981.

SN 76-148,272. TARGETED GENETICS CORPORATION, SEATTLE, WA. FILED 10-17-2000.

CELLEXSYS

FOR GENE THERAPY AND CELL THERAPY PHARMACEUTICAL PREPARATION FOR THE TREATMENT OR PREVENTION OF CANCER, RESPIRATORY DISEASES, ARTHRITIS, METABOLIC DISEASES, COAGULATION DEFICIENCIES AND INFECTIOUS DISEASES (U.S. CLS. 6, 18, 44, 46, 51 AND 52).

CLASS 5—(Continued).

SN 76-150,955. WHOLE FOODS MARKET IP, INC., AUSTIN, TX. FILED 10-20-2000.



NO CLAIM IS MADE TO THE EXCLUSIVE RIGHT TO USE "KIDS", APART FROM THE MARK AS SHOWN.

FOR NON-PRESCRIPTION DIETARY SUPPLEMENTS (U.S. CLS. 6, 18, 44, 46, 51 AND 52).

SN 76-161,545. ASTRAZENECA AB, SWEDEN, FILED 11-8-2000.

OMVELIN

PRIORITY CLAIMED UNDER SEC. 44(D) ON UNITED KINGDOM APPLICATION NO. 2250339, FILED 10-27-2000.

FOR PHARMACEUTICAL PREPARATIONS AND SUBSTANCES FOR USE IN THE TREATMENT OF DISEASES AND DISORDERS OF THE CENTRAL NERVOUS SYSTEM, THE PERIPHERAL NERVOUS SYSTEM, THE URINARY SYSTEM AND THE CARDIOVASCULAR SYSTEM; PHARMACEUTICAL PREPARATIONS AND SUBSTANCES FOR PAIN CONTROL AND ANAESTHESIA (U.S. CLS. 6, 18, 44, 46, 51 AND 52).

SN 76-161,546. ASTRAZENECA AB, SWEDEN, FILED 11-8-2000.

SEMFANE

PRIORITY CLAIMED UNDER SEC. 44(D) ON UNITED KINGDOM APPLICATION NO. 2350340, FILED 10-27-2000.

FOR PHARMACEUTICAL PREPARATIONS AND SUBSTANCES FOR USE IN THE TREATMENT OF DISEASES AND DISORDERS OF THE CENTRAL NERVOUS SYSTEM, THE PERIPHERAL NERVOUS SYSTEM, THE URINARY SYSTEM AND THE CARDIOVASCULAR SYSTEM; PHARMACEUTICAL PREPARATIONS AND SUBSTANCES FOR PAIN CONTROL AND ANAESTHESIA (U.S. CLS. 6, 18, 44, 46, 51 AND 52).

SN 76-164,316. LEINER HEALTH SERVICES CORP., CARSON, CA. FILED 11-8-2000.

METABORITE

FOR VITAMINS AND DIETARY FOOD SUPPLEMENTS (U.S. CLS. 6, 18, 44, 46, 51 AND 52).

CLASS 5—(Continued).

SN 76-165,912. SUMMERS LABORATORIES, INC., COLLEGEVILLE, PA. FILED 11-9-2000.

ACCU-SOOTHE

FOR MEDICATED SKIN CARE PRODUCTS, NAMELY, MEDICATED SUNSCREEN LIP BALM (U.S. CLS. 6, 18, 44, 46, 51 AND 52).

FIRST USE 8-1-2000; IN COMMERCE 8-1-2000.

SN 76-165,914. SUMMERS LABORATORIES, INC., COLLEGEVILLE, PA. FILED 11-9-2000.

TRIPLE PASTE

FOR MEDICATED DIAPER RASH OINTMENT (U.S. CLS. 6, 18, 44, 46, 51 AND 52).

FIRST USE 1-1-1965; IN COMMERCE 1-1-1965.

SN 76-165,915. SUMMERS LABORATORIES, INC., COLLEGEVILLE, PA. FILED 11-9-2000.

SEBASORB

FOR MEDICATED ACNE TREATMENT LOTION (U.S. CLS. 6, 18, 44, 46, 51 AND 52).

FIRST USE 1-1-1959; IN COMMERCE 1-1-1959.

SN 76-170,870. TOMEN AGRO, INC., SAN FRANCISCO, CA. FILED 11-22-2000.

ENDORSE

FOR PESTICIDES, HERBICIDES, AND FUNGICIDES—ALL FOR USE IN AGRICULTURE, HORTICULTURE AND SILVICULTURE (U.S. CLS. 6, 18, 44, 46, 51 AND 52).

SN 76-175,610. CARGILL, INCORPORATED, WAYZATA, MN. FILED 12-5-2000.

OPTIFINISH

FOR MEDICATED ANIMAL FEEDLOT NUTRITIONAL SUPPLEMENTS (U.S. CLS. 6, 18, 44, 46, 51 AND 52).

CLASS 5—(Continued).

SN 76-185,078. AVENTIS CROPSCIENCE SA, LYON, FRANCE, FILED 12-20-2000.

COSSACK

FOR HERBICIDE AND INSECTICIDE FOR AGRICULTURAL USE (U.S. CLS. 6, 18, 44, 46, 51 AND 52).

CLASS 5—(Continued).

SN 76-212,415. ATLEY PHARMACEUTICALS, INC., ASHLAND, VA. FILED 2-20-2001.

POXYCET

FOR PHARMACEUTICAL PREPARATIONS FOR THE TREATMENT OF PAIN (U.S. CLS. 6, 18, 44, 46, 51 AND 52).

SN 76-206,682. OMS INVESTMENTS, INC., WILMINGTON, DE. FILED 2-8-2001.

FUNGUS-B-GON

OWNER OF U.S. REG. NOS. 433,172, 2,236,054 AND OTHERS.
FOR FUNGICIDES AND INSECTICIDES FOR DOMESTIC USE (U.S. CLS. 6, 18, 44, 46, 51 AND 52).

SN 76-214,628. IVC INDUSTRIES, INC., FREEHOLD, NJ. FILED 2-22-2001.

ESTROSUPPORT

FOR VITAMINS AND FOOD SUPPLEMENTS (U.S. CLS. 6, 18, 44, 46, 51 AND 52).

SN 76-209,831. GLOBAL ACCESS, INC., BLOOMINGTON, MN. FILED 2-13-2001.

SN 76-236,410. COLIC-EASE INC., WILTON MANORS, FL. FILED 4-6-2001.

COLIC-EASE

FOR HERBAL DIETARY SUPPLEMENT FOR BABIES (U.S. CLS. 6, 18, 44, 46, 51 AND 52).
FIRST USE 9-10-1998; IN COMMERCE 1-12-1999.



FOR INGESTIBLE GEL-BASED VETERINARY PREPARATIONS FOR INHIBITING AND REPLACING MICROORGANISMS IN THE TREATMENT OF DOGS AND CATS (U.S. CLS. 6, 18, 44, 46, 51 AND 52).

SN 76-239,911. FOCUS/MRL, INC., HERNDON, VA. FILED 4-11-2001.

HERPESELECT

FOR DIAGNOSTIC KITS COMPRISED OF DIAGNOSTIC REAGENTS AND ASSAYS FOR CLINICAL AND MEDICAL USE FOR THE TYPE-SPECIFIC DETECTION OF HERPES SIMPLEX VIRUS TYPE 1 AND TYPE 2 (U.S. CLS. 6, 18, 44, 46, 51 AND 52).

SN 76-211,377. ASTRAZENECA UK LIMITED, LONDON W1Y 6LN, UNITED KINGDOM, FILED 2-14-2001.

SEQUAZE

OWNER OF UNITED KINGDOM REG. NO. 1508311, DATED 7-27-1992, EXPIRES 7-27-2009.

FOR PHARMACEUTICAL PREPARATIONS FOR THE PREVENTION AND TREATMENT OF RESPIRATORY, ALLERGIC, ANTI-INFLAMMATORY AND MUSCULAR-SKELETAL DISEASES AND/OR DISORDERS (U.S. CLS. 6, 18, 44, 46, 51 AND 52).

SN 76-243,326. AVENTIS CROPSCIENCE SA, LYON, FRANCE, FILED 4-19-2001.

FALCON

FOR PREPARATION FOR DESTROYING VERMIN; AGRICULTURAL HERBICIDE (U.S. CLS. 6, 18, 44, 46, 51 AND 52).

CLASS 5—(Continued).

SN 76-244,730. NORMED, INC., SEATTLE, WA. FILED 4-18-2001.

ELECTROTAB

FOR PHARMACEUTICAL ELECTROLYTE REPLACEMENT PREPARATION (U.S. CLS. 6, 18, 44, 46, 51 AND 52).

FIRST USE 6-17-1997; IN COMMERCE 7-15-1997.

SN 76-245,491. GREEN PHARMACEUTICALS, INC., WILSONVILLE, OR. FILED 4-23-2001.

THE SNORING SPECIALISTS

NO CLAIM IS MADE TO THE EXCLUSIVE RIGHT TO USE "SNORING", APART FROM THE MARK AS SHOWN.

FOR DIETARY SUPPLEMENTS AND HOMEOPATHIC PREPARATIONS FOR THE TREATMENT OF SNORING (U.S. CLS. 6, 18, 44, 46, 51 AND 52).

SN 76-250,412. GLANBIA INGREDIENTS, INC., MONROE, WI. FILED 5-1-2001.

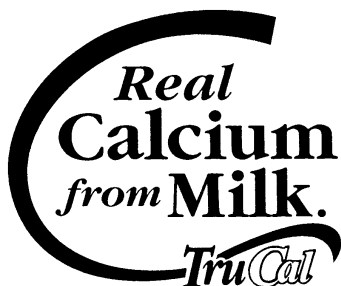

NO CLAIM IS MADE TO THE EXCLUSIVE RIGHT TO USE "REAL CALCIUM FROM MILK", APART FROM THE MARK AS SHOWN.

FOR FOOD SUPPLEMENTS AND DIETARY SUPPLEMENTS FOR CALCIUM FORTIFICATION (U.S. CLS. 6, 18, 44, 46, 51 AND 52).

SN 76-252,525. AMUROL CONFECTIONS COMPANY, YORKVILLE, IL. FILED 5-4-2001.

DIET RESCUE GUM

NO CLAIM IS MADE TO THE EXCLUSIVE RIGHT TO USE "GUM", APART FROM THE MARK AS SHOWN.

FOR DIETARY SUPPLEMENTS (U.S. CLS. 6, 18, 44, 46, 51 AND 52).

CLASS 5—(Continued).

SN 76-257,696. ACURE MEDS, INC., SANTA CLARA, CA. FILED 5-15-2001.

XEROVIR

FOR NUTRICEUTICAL PREPARATIONS FOR THE TREATMENT OR PREVENTION OF INFECTIOUS DISEASES; DIETARY SUPPLEMENTS; PHARMACEUTICAL PREPARATIONS FOR THE TREATMENT OR PREVENTION OF INFECTIOUS DISEASES (U.S. CLS. 6, 18, 44, 46, 51 AND 52).

SN 76-257,697. ACURE MEDS, INC., SANTA CLARA, CA. FILED 5-15-2001.

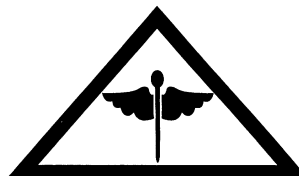

NO CLAIM IS MADE TO THE EXCLUSIVE RIGHT TO USE "CADUCEUS" SYMBOL APART FROM THE MARK AS SHOWN., APART FROM THE MARK AS SHOWN.

THE MARK CONSISTS, IN PART, OF A STYLIZED DEPICTION A CADUCEUS WITH WINGS LOCATED INSIDE A TRIANGLE. COLOR IS NOT CLAIMED AS PART OF THE MARK.

FOR NUTRICEUTICAL PREPARATIONS FOR THE TREATMENT OR PREVENTION OF INFECTIOUS DISEASES; DIETARY SUPPLEMENTS; PHARMACEUTICAL PREPARATIONS FOR THE TREATMENT OR PREVENTION OF INFECTIOUS DISEASES (U.S. CLS. 6, 18, 44, 46, 51 AND 52).

SN 76-258,625. ENZYMATIC THERAPY, INC., GREEN BAY, WI. FILED 5-18-2001.

IMMUNOSHIELD

FOR DIETARY AND NUTRITIONAL SUPPLEMENTS (U.S. CLS. 6, 18, 44, 46, 51 AND 52).

SN 76-259,132. WESTERN FAMILY FOODS, INC., TIGARD, OR. FILED 5-16-2001.

WESTERN FAMILY EYE CARE

NO CLAIM IS MADE TO THE EXCLUSIVE RIGHT TO USE "EYE CARE", APART FROM THE MARK AS SHOWN.

FOR EYE RINSING SOLUTIONS AND RELATED EYE CLEANING AND RINSING PRODUCTS, NAMELY, LUBRICANT EYE DROPS (U.S. CLS. 6, 18, 44, 46, 51 AND 52).

CLASS 5—(Continued).

SN 76-262,776. REMINGTON HEALTH PRODUCTS, LLC, FORT WORTH, TX. FILED 5-25-2001.

DRINK YOUR MINERALS

NO CLAIM IS MADE TO THE EXCLUSIVE RIGHT TO USE "MINERALS", APART FROM THE MARK AS SHOWN. FOR VITAMINS, DIETARY SUPPLEMENTS, NUTRITIONAL SUPPLEMENTS, AND MINERAL SUPPLEMENTS (U.S. CLS. 6, 18, 44, 46, 51 AND 52).

SN 76-266,425. MANNATECH, INC., COPPELL, TX. FILED 6-4-2001.

NETWORKING SUGARS

NO CLAIM IS MADE TO THE EXCLUSIVE RIGHT TO USE "SUGARS", APART FROM THE MARK AS SHOWN. FOR DIETARY AND NUTRITIONAL SUPPLEMENTS (U.S. CLS. 6, 18, 44, 46, 51 AND 52).

SN 76-268,741. STANDARD PROCESS INC., PALMYRA, WI. FILED 6-8-2001.

SP CLEANSE

OWNER OF U.S. REG. NOS. 1,770,843, 2,443,219 AND OTHERS. NO CLAIM IS MADE TO THE EXCLUSIVE RIGHT TO USE "CLEANSE", APART FROM THE MARK AS SHOWN. FOR DIETARY SUPPLEMENTS (U.S. CLS. 6, 18, 44, 46, 51 AND 52).

SN 76-269,065. PFIZER INC., NEW YORK, NY. FILED 6-7-2001.



OWNER OF U.S. REG. NO. 2,455,588. FOR PHARMACEUTICAL PRODUCTS AND PREPARATIONS, NAMELY, AN ANTI-FUNGAL MEDICATION (U.S. CLS. 6, 18, 44, 46, 51 AND 52).

CLASS 5—(Continued).

SN 76-290,059. AMERICAN HOME PRODUCTS CORPORATION, MADISON, NJ. FILED 7-24-2001.

EARTH SWEET

NO CLAIM IS MADE TO THE EXCLUSIVE RIGHT TO USE "SWEET", APART FROM THE MARK AS SHOWN. FOR DIETARY AND NUTRITIONAL SUPPLEMENTS (U.S. CLS. 6, 18, 44, 46, 51 AND 52).

SN 76-301,775. PHARMACHEM LABORATORIES, INC., KEARNY, NJ. FILED 8-20-2001.

ZERO NET STARCH CALORIES

FOR LINE OF DIETARY SUPPLEMENTS CONTAINING PHASEOLAMIN (U.S. CLS. 6, 18, 44, 46, 51 AND 52).

SN 76-306,668. SHOFU, INC., HIGASHIYAMA-KU, KYOTO 605, JAPAN, FILED 8-30-2001.

B E A U T I F I L

FOR LIGHT-CURED FLUORIDE RELEASING DENTAL RESTORATION MATERIAL (U.S. CLS. 6, 18, 44, 46, 51 AND 52). FIRST USE 7-30-2001; IN COMMERCE 7-30-2001.

CLASS 5—(Continued).

SN 76-307,918. YAMANOUCHI PHARMACEUTICAL CO., LTD., TOKYO, JAPAN, AND YAMANOUCHI PHARMA TECHNOLOGIES, INC., PALO ALTO, CA. FILED 8-30-2001.



FOR PHARMACEUTICAL PREPARATIONS THAT DISSOLVE IN THE MOUTH FOR THE TREATMENT OF DISEASE OR HEALTH-RELATED CONDITIONS INVOLVING BLOOD AND BLOOD-FORMING ORGANS, THE CARDIAC CIRCULATORY SYSTEM, THE PERIPHERAL VASCULAR SYSTEM, THE ENDOCRINE SYSTEM, THE GENITOURINARY SYSTEM, THE IMMUNE SYSTEM, INFECTIOUS AND PARASITIC CONDITIONS, THE LOWER DIGESTIVE SYSTEM, MENTAL DISORDERS, METABOLIC DISORDERS, MULTI-SYSTEM AND ILL-DEFINED CONDITIONS, MUSKOSKELETAL SYSTEMS, AND CONNECTIVE TISSUE, NEOPLASMS, THE NERVOUS SYSTEM, NUTRITIONAL DISORDERS, PREGNANCY, THE RESPIRATORY SYSTEM; SENSORY ORGAN CONDITIONS, SKIN AND SUBCUTANEOUS CONDITIONS, AND THE UPPER DIGESTIVE SYSTEM; AND NUTRITIONAL SUPPLEMENTS (U.S. CLS. 6, 18, 44, 46, 51 AND 52).

SN 76-307,976. AVAX INTERNATIONAL IP HOLDINGS, INC., WILMINGTON, DE. FILED 8-31-2001.

B-VAX

FOR BREAST CANCER VACCINE (U.S. CLS. 6, 18, 44, 46, 51 AND 52).

SN 76-308,463. STALLION EXPORTS, LLC, FORT WRIGHT, KY. FILED 9-4-2001.

GIN STIM

FOR DIETARY SUPPLEMENTS (U.S. CLS. 6, 18, 44, 46, 51 AND 52).

CLASS 5—(Continued).

SN 76-309,451. DAWE'S, L.L.C., ARLINGTON HEIGHTS, IL. FILED 9-6-2001.

TAKE-OFF

FOR DIETARY SUPPLEMENTS DESIGNED FOR USE IN DAIRY CATTLE DIETS (U.S. CLS. 6, 18, 44, 46, 51 AND 52).
FIRST USE 6-27-2001; IN COMMERCE 6-27-2001.

SN 76-310,280. NATURAL SUPPLEMENT ASSOCIATION, INCORPORATED, DBA EXPERIMENTAL AND APPLIED SCIENCES, INC., GOLDEN, CO. FILED 9-7-2001.

PIRANHA

FOR DIETARY AND NUTRITIONAL SUPPLEMENTS (U.S. CLS. 6, 18, 44, 46, 51 AND 52).
FIRST USE 7-23-2001; IN COMMERCE 7-23-2001.

SN 76-310,426. PANGENE CORPORATION, FREMONT, CA. FILED 9-10-2001.

MIRCAMYL

FOR PHARMACEUTICAL PREPARATIONS FOR USE IN THE TREATMENT OF CANCER (U.S. CLS. 6, 18, 44, 46, 51 AND 52).

SN 76-312,349. SRZ PROPERTIES, INC., MEQUON, WI. FILED 9-17-2001.

MAXLEV

FOR PHARMACEUTICAL PREPARATION TO TREAT GASTROINTESTINAL DISORDERS (U.S. CLS. 6, 18, 44, 46, 51 AND 52).

SN 76-312,375. SRZ PROPERTIES, INC., MEQUON, WI. FILED 9-17-2001.

DURALEV

FOR PHARMACEUTICAL PREPARATION TO TREAT GASTROINTESTINAL DISORDERS (U.S. CLS. 6, 18, 44, 46, 51 AND 52).

CLASS 5—(Continued).

SN 76-314,311. SUMITOMO CHEMICAL CO., LTD., CHUOKU, OSAKA, JAPAN, FILED 9-19-2001.



FOR INSECTICIDES (U.S. CLS. 6, 18, 44, 46, 51 AND 52).
FIRST USE 4-1-1999; IN COMMERCE 4-1-1999.

SN 76-314,342. ELLA, INC., ADRIAN, MI. FILED 9-19-2001.

ENTELEV

FOR FOOD SUPPLEMENTS (U.S. CLS. 6, 18, 44, 46, 51 AND 52).

SN 76-314,460. BIO CENTER, INC., LOS ANGELES, CA. FILED 9-20-2001.

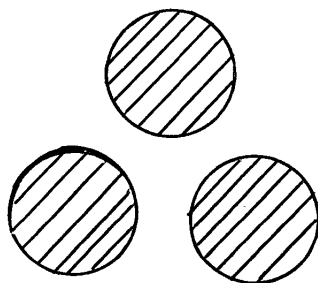

THE STRIPES IN EACH CIRCLE DENOTES THE COLOR GOLD.
FOR HERBAL AND NON-HERBAL DIETARY SUPPLEMENTS (U.S. CLS. 6, 18, 44, 46, 51 AND 52).

SN 76-314,598. RICHARD, A. DEER, CARMEL, IN. FILED 9-19-2001.

CITRUS-X

FOR DIETARY SUPPLEMENT (U.S. CLS. 6, 18, 44, 46, 51 AND 52).

CLASS 5—(Continued).

SN 76-314,736. ARCHER-DANIELS-MIDLAND COMPANY, DECATUR, IL. FILED 9-20-2001.

ENERTIA

FOR DIETARY SUPPLEMENT FOR LIVESTOCK (U.S. CLS. 6, 18, 44, 46, 51 AND 52).

SN 76-315,395. BUTT, KEDRIC, HYANNIS, MA. FILED 9-21-2001.

EURO PREMIUM

FOR NUTRITIONAL SUPPLEMENTS (U.S. CLS. 6, 18, 44, 46, 51 AND 52).

SN 78-022,337. NUTRICIA INTERNATIONAL B.V., ZOETERMEER, NETHERLANDS, FILED 8-22-2000.

RESPIFOR

FOR PHARMACEUTICAL PREPARATIONS FOR THE TREATMENT OF RESPIRATORY, PULMONARY AND/OR EATING DISORDERS OR DISEASES; DIETETIC SUBSTANCES FOR MEDICAL USE, NAMELY DIETARY SUPPLEMENTS, FOOD FOR MEDICALLY RESTRICTED DIETS, NUTRITIONAL SUPPLEMENTS, AND VITAMINS (U.S. CLS. 6, 18, 44, 46, 51 AND 52).

SN 78-025,634. SMITHKLINE BEECHAM CORPORATION, PHILADELPHIA, PA. FILED 9-13-2000.

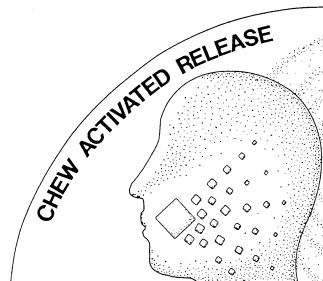

NO CLAIM IS MADE TO THE EXCLUSIVE RIGHT TO USE "CHEW ACTIVATED RELEASE", APART FROM THE MARK AS SHOWN.

THE STIPPLING IN THE DRAWING IS FOR SHADING PURPOSES ONLY AND DOES NOT REPRESENT COLOR.

FOR PHARMACEUTICAL PREPARATIONS, NAMELY SMOKING CESSATION PREPARATIONS (U.S. CLS. 6, 18, 44, 46, 51 AND 52).

CLASS 5—(Continued).

SN 78-025,636. SMITHKLINE BEECHAM CORPORATION, PHILADELPHIA, PA. FILED 9-13-2000.

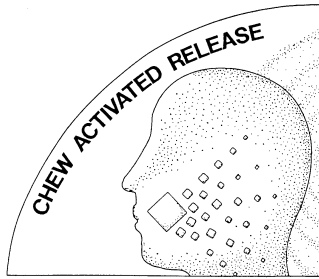

NO CLAIM IS MADE TO THE EXCLUSIVE RIGHT TO USE "CHEW ACTIVATED RELEASE", APART FROM THE MARK AS SHOWN.

THE MARK CONSISTS OF THE STYLIZED WORDS "CHEW ACTIVATED RELEASE" AND THE SIDE PROFILE OF A HEAD WITH A PIECE OF GUM IN THE MOUTH AND SEVERAL RAYS OF SMALLER PARTICLES BRANCHING OUT TO THE RIGHT OF THE GUM; ALL OF THE FOREGOING DESIGN ELEMENTS APPEAR WITHIN A QUARTER CIRCLE DESIGN; THE BACKGROUND OF THE QUARTER CIRCLE IS DARK BLUE FADING TO LIGHT BLUE FROM LEFT TO RIGHT, THE HEAD DESIGN IS BLUE, THE GUM IS YELLOW AND THE PARTICLES ARE WHITE/GRAY; AND COLOR IS CLAIMED AS A FEATURE OF THE MARK; THE STIPPLING IN THE DRAWING IS FOR SHADING PURPOSES.

FOR PHARMACEUTICAL PREPARATIONS, NAMELY SMOKING CESSATION PREPARATIONS (U.S. CLS. 6, 18, 44, 46, 51 AND 52).

SN 78-025,637. SMITHKLINE BEECHAM CORPORATION, PHILADELPHIA, PA. FILED 9-13-2000.

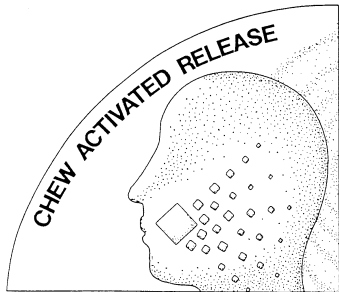

NO CLAIM IS MADE TO THE EXCLUSIVE RIGHT TO USE "CHEW ACTIVATED RELEASE", APART FROM THE MARK AS SHOWN.

THE MARK CONSISTS OF THE STYLIZED WORDS "CHEW ACTIVATED RELEASE" AND THE SIDE PROFILE OF A HEAD WITH A PIECE OF GUM IN THE MOUTH AND

CLASS 5—(Continued).

SEVERAL RAYS OF SMALLER PARTICLES BRANCHING OUT TO THE RIGHT OF THE GUM; ALL OF THE FOREGOING DESIGN ELEMENTS APPEAR WITHIN A QUARTER CIRCLE DESIGN; THE BACKGROUND OF THE QUARTER CIRCLE IS DARK GREEN FADING TO LIGHT GREEN FROM LEFT TO RIGHT, THE HEAD DESIGN IS GREEN, THE GUM IS YELLOW AND THE PARTICLES ARE WHITE/GRAY; AND COLOR IS CLAIMED AS A FEATURE OF THE MARK; THE STIPPLING IN THE DRAWING IS FOR SHADING PURPOSES.

FOR PHARMACEUTICAL PREPARATIONS, NAMELY SMOKING CESSATION PREPARATIONS (U.S. CLS. 6, 18, 44, 46, 51 AND 52).

SN 78-031,249. PHARMACIA CORPORATION, SKOKIE, IL. FILED 10-18-2000.

KUDET

FOR PHARMACEUTICAL PREPARATIONS, NAMELY PREPARATIONS FOR THE TREATMENT OF INFECTIOUS DISEASES, ONCOLOGICAL PREPARATIONS, ANALGESICS, PREPARATIONS FOR THE TREATMENT AND SYMPTOMS OF DIABETES, PREPARATIONS FOR THE TREATMENT OF OPHTHALMOLOGICAL CONDITIONS AND DISEASES, PREPARATIONS FOR THE TREATMENT OF CENTRAL NERVOUS SYSTEMS DISEASES AND DISORDERS, PREPARATIONS FOR THE TREATMENT OF PARKINSON'S DISEASE, GYNECOLOGICAL PREPARATIONS, ANTI-INFLAMMATORY PHARMACEUTICAL PREPARATIONS, PREPARATIONS FOR THE TREATMENT OF CARDIOVASCULAR DISEASES AND CONDITIONS, HORMONAL PREPARATIONS AND PREPARATIONS FOR THE TREATMENT OF MIGRAINES (U.S. CLS. 6, 18, 44, 46, 51 AND 52).

SN 78-034,312. DANIEL ROGERS LABORATORIES, INC., RIDGEWOOD, NJ. FILED 11-8-2000.

THERMAL CARB

NO CLAIM IS MADE TO THE EXCLUSIVE RIGHT TO USE "CARB", APART FROM THE MARK AS SHOWN. FOR DIETARY SUPPLEMENT (U.S. CLS. 6, 18, 44, 46, 51 AND 52).

SN 78-035,784. BRISTOL-MYERS SQUIBB COMPANY, NEW YORK, NY. FILED 11-17-2000.

KOBLAX

FOR PHARMACEUTICAL PREPARATIONS FOR THE TREATMENT OF CARDIOVASCULAR DISEASES, CENTRAL NERVOUS SYSTEM DISEASES AND DISORDERS, STROKE, CANCER, INFLAMMATION AND INFLAMMATORY DISEASES, RESPIRATORY AND INFECTIOUS DISEASES, AUTO-IMMUNE DISEASES (U.S. CLS. 6, 18, 44, 46, 51 AND 52).

CLASS 5—(Continued).

SN 78-035,785. BRISTOL-MYERS SQUIBB COMPANY, NEW YORK, NY. FILED 11-17-2000.

BROSPEC

FOR PHARMACEUTICAL PREPARATIONS FOR THE TREATMENT OF CARDIOVASCULAR DISEASES, CENTRAL NERVOUS SYSTEM DISEASES AND DISORDERS, STROKE, CANCER, INFLAMMATION AND INFLAMMATORY DISEASES, RESPIRATORY AND INFECTIOUS DISEASES, AUTO-IMMUNE DISEASES (U.S. CLS. 6, 18, 44, 46, 51 AND 52).

SN 78-035,786. BRISTOL-MYERS SQUIBB COMPANY, NEW YORK, NY. FILED 11-17-2000.

BROSPEK

FOR PHARMACEUTICAL PREPARATIONS FOR THE TREATMENT OF CARDIOVASCULAR DISEASES, CENTRAL NERVOUS SYSTEM DISEASES AND DISORDERS, STROKE, CANCER, INFLAMMATION AND INFLAMMATORY DISEASES, RESPIRATORY AND INFECTIOUS DISEASES, AUTO-IMMUNE DISEASES (U.S. CLS. 6, 18, 44, 46, 51 AND 52).

SN 78-036,180. NATURE'S ONE, INC., WESTERVILLE, OH. FILED 11-21-2000.

BABY'S ONLY ORGANIC

NO CLAIM IS MADE TO THE EXCLUSIVE RIGHT TO USE "BABY'S" AND "ORGANIC", APART FROM THE MARK AS SHOWN.
 FOR ORGANIC BABY FOOD (U.S. CLS. 6, 18, 44, 46, 51 AND 52).
 FIRST USE 10-31-2000; IN COMMERCE 10-31-2000.

SN 78-041,660. RFI BLENDING LLC, BLAUVELT, NY. FILED 1-4-2001.

OXYPHYTE

FOR DIETARY AND NUTRITIONAL SUPPLEMENTS; AND FOOD SUPPLEMENTS, EXCLUDING ACNE MEDICATIONS AND MEDICATED SKIN CARE PREPARATIONS (U.S. CLS. 6, 18, 44, 46, 51 AND 52).

SN 78-045,932. ALUWE, LLC, MINNETONKA, MN. FILED 1-31-2001.

ALUWE

FOR NUTRITIONAL SUPPLEMENTS (U.S. CLS. 6, 18, 44, 46, 51 AND 52).

CLASS 5—(Continued).

SN 78-050,552. BIOTECH CORPORATION, GLASTONBURY, CT. FILED 2-27-2001.

MEGA HAIR

FOR NUTRITIONAL PRODUCTS, NAMELY, NUTRITIONAL SUPPLEMENTS FOR HAIR HEALTH, HAIR GROWTH OR RE-GROWTH, HAIR LOSS, FOLLICLE HEALTH OR THE LIKE, IN TABLET, CAPSULE, LIQUID, TOPICAL, CHEWABLE OR OTHER SOLID DOSE FORM (U.S. CLS. 6, 18, 44, 46, 51 AND 52).

SN 78-051,129. PHARMACIA CORPORATION, PEAPACK, NJ. FILED 3-2-2001.

XTRON

FOR PHARMACEUTICAL PREPARATIONS, NAMELY PREPARATIONS FOR THE TREATMENT OF INFECTIOUS DISEASES, ONCOLOGICAL PREPARATIONS, ANALGESICS, PREPARATIONS FOR THE TREATMENT AND SYMPTOMS OF DIABETES, PREPARATIONS FOR THE TREATMENT OF OPHTHALMOLOGICAL CONDITIONS AND DISEASES, PREPARATIONS FOR THE TREATMENT OF CENTRAL NERVOUS SYSTEMS DISEASES AND DISORDERS, PREPARATIONS FOR THE TREATMENT OF PARKINSON'S DISEASE, GYNECOLOGICAL PREPARATIONS, ANTI-INFLAMMATORY PHARMACEUTICAL PREPARATIONS, PREPARATIONS FOR THE TREATMENT OF CARDIOVASCULAR DISEASES AND CONDITIONS, HORMONAL PREPARATIONS AND PREPARATIONS FOR THE TREATMENT OF MIGRAINES (U.S. CLS. 6, 18, 44, 46, 51 AND 52).

SN 78-051,174. DELANO COMPANY, INC, GROVER BEACH, CA. FILED 3-2-2001.

PLATFORM MULTI-NUTRIENT FORMULA

NO CLAIM IS MADE TO THE EXCLUSIVE RIGHT TO USE "MULTI-NUTRIENT FORMULA", APART FROM THE MARK AS SHOWN.
 FOR MULTI-NUTRIENT FORMULA CONTAINING OVER 100 COMPONENTS (U.S. CLS. 6, 18, 44, 46, 51 AND 52).

CLASS 5—(Continued).

SN 78-052,045. DAHL, CINTHIA, DBA DAHLHOUSE PRODUCTIONS, STUDIO CITY, CA. FILED 3-8-2001.



FOR PAIN-RELIEVING LOTIONS, CREAMS, GELS AND SPRAYS (U.S. CLS. 6, 18, 44, 46, 51 AND 52). FIRST USE 3-2-2001; IN COMMERCE 3-3-2001.

SN 78-052,084. SALANI, LARRY, PARK RIDGE, IL. AND GENTILE, MICHAEL JR., CHICAGO, IL. FILED 3-8-2001.

EVERGREEN NATURALS

NO CLAIM IS MADE TO THE EXCLUSIVE RIGHT TO USE "NATURALS", APART FROM THE MARK AS SHOWN. FOR DIETARY FOOD SUPPLEMENTS (U.S. CLS. 6, 18, 44, 46, 51 AND 52).

SN 78-054,997. FARNAM COMPANIES, INC., PHOENIX, AZ. FILED 3-26-2001.

STABLE SHIELD

NO CLAIM IS MADE TO THE EXCLUSIVE RIGHT TO USE "STABLE", APART FROM THE MARK AS SHOWN. FOR INSECT REPELLENT, NAMELY, A FLY CONTROL FORMULA THAT KILLS AND REPELS FLIES AND OTHER INSECTS IN AND AROUND STRUCTURES SUCH AS HOUSES, BARNES AND STABLES (U.S. CLS. 6, 18, 44, 46, 51 AND 52).

CLASS 5—(Continued).

SN 78-056,656. PHARMACIA CORPORATION, PEAPACK, NJ. FILED 4-4-2001.

DEZINA

FOR PHARMACEUTICAL PREPARATIONS, NAMELY, PREPARATIONS FOR THE TREATMENT OF INFECTIOUS DISEASES, DYSMENORRHEA, DISORDERS OF THE CENTRAL NERVOUS SYSTEM, CARDIOVASCULAR CONDITIONS, UROLOGICAL DISORDERS, OPHTHALMOLOGICAL CONDITIONS, AND DISORDERS AND CONDITIONS ASSOCIATED WITH THE FIELDS OF ONCOLOGY AND ENDOCRINOLOGY, PREPARATIONS FOR THE TREATMENT OF PARKINSON'S DISEASE, GYNECOLOGICAL PREPARATIONS, ANTI-INFLAMMATORY PREPARATIONS, HORMONAL PREPARATIONS, PREPARATIONS FOR THE TREATMENT OF MIGRAINES; PHARMACEUTICALS IN THE NATURE OF ANTIBODICS (U.S. CLS. 6, 18, 44, 46, 51 AND 52).

SN 78-056,658. PHARMACIA CORPORATION, PEAPACK, NJ. FILED 4-4-2001.

KAPTUR

FOR PHARMACEUTICAL PREPARATIONS, NAMELY, PREPARATIONS FOR THE TREATMENT OF INFECTIOUS DISEASES, DYSMENORRHEA, DISORDERS OF THE CENTRAL NERVOUS SYSTEM, CARDIOVASCULAR CONDITIONS, UROLOGICAL DISORDERS, OPHTHALMOLOGICAL CONDITIONS, AND DISORDERS AND CONDITIONS ASSOCIATED WITH THE FIELDS OF ONCOLOGY AND ENDOCRINOLOGY, PREPARATIONS FOR THE TREATMENT OF PARKINSON'S DISEASE, GYNECOLOGICAL PREPARATIONS, ANTI-INFLAMMATORY PREPARATIONS, HORMONAL PREPARATIONS, PREPARATIONS FOR THE TREATMENT OF MIGRAINES; PHARMACEUTICALS IN THE NATURE OF ANTIBODICS (U.S. CLS. 6, 18, 44, 46, 51 AND 52).

SN 78-061,988. SARAMAR, L.L.C., CHICAGO, IL. FILED 5-4-2001.

POWDER PEARLS

FOR AIR FRESHENERS AND ROOM DEODORIZERS (U.S. CLS. 6, 18, 44, 46, 51 AND 52).

SN 78-062,311. NATURE'S WAY PRODUCTS, INC., SPRINGVILLE, UT. FILED 5-7-2001.

MYCO HEART

NO CLAIM IS MADE TO THE EXCLUSIVE RIGHT TO USE "HEART", APART FROM THE MARK AS SHOWN. FOR VITAMINS, MINERALS AND DIETARY SUPPLEMENTS (U.S. CLS. 6, 18, 44, 46, 51 AND 52).

CLASS 5—(Continued).

SN 78-065,336. D-STRESS MARKETING GROUP, INC., BOCA RATON, FL. FILED 5-23-2001.

CRAVESPRAY

FOR ALL-NATURAL SUB-LINGUAL HOMEOPATHIC SPRAY PREPARATIONS FOR STRESS RELIEF (U.S. CLS. 6, 18, 44, 46, 51 AND 52).

CLASS 5—(Continued).

SN 78-072,387. BAUSCH & LOMB PHARMACEUTICALS, INC., TAMPA, FL. FILED 7-5-2001.

OCUVITE PRESERVISION

OWNER OF U.S. REG. NOS. 1,556,520, 1,615,288 AND 2,346,324.
FOR VITAMIN AND MINERAL SUPPLEMENTS (U.S. CLS. 6, 18, 44, 46, 51 AND 52).

SN 78-066,510. GREEN, LONNY, GLEN ALLEN, VA. FILED 5-31-2001.

BLADDER-SOOTHE

FOR NON-PRESCRIPTION NUTRITIONAL SUPPLEMENT FOR THE SUPPORT OF BLADDER HEALTH (U.S. CLS. 6, 18, 44, 46, 51 AND 52).
FIRST USE 7-10-2001; IN COMMERCE 7-12-2001.

SN 78-076,083. AMERICAN HOME PRODUCTS CORPORATION, MADISON, NJ. FILED 7-27-2001.

PREMGESTIN

FOR PHARMACEUTICAL PREPARATIONS FOR USE IN HORMONAL REPLACEMENT THERAPY (U.S. CLS. 6, 18, 44, 46, 51 AND 52).

SN 78-070,710. RONALD I. GROSS LTD, DBA MEDZONE CORPORATION, PARADISE VALLEY, AZ. FILED 6-23-2001.

BLOCKZONE

FOR TOPICAL ANTIBIOTIC CREAM (U.S. CLS. 6, 18, 44, 46, 51 AND 52).

SN 78-082,047. MUHAMMED, MAJEED, PISCATAWAY, NJ. FILED 8-31-2001.

VANABEAN

FOR NUTRITIONAL SUPPLEMENT CONSISTING OF BEANS ENRICHED WITH VANADIUM (U.S. CLS. 6, 18, 44, 46, 51 AND 52).

SN 78-070,802. MAHARISHI AYUR-VED PRODUCTS INTERNATIONAL, INC., COLORADO SPRINGS, CO. FILED 6-25-2001.

PROTECTION PLUS

NO CLAIM IS MADE TO THE EXCLUSIVE RIGHT TO USE "PROTECTION", APART FROM THE MARK AS SHOWN.

FOR HERBAL NUTRITIONAL SUPPLEMENTS (U.S. CLS. 6, 18, 44, 46, 51 AND 52).

SN 78-082,486. LABORATOIRES SUISSES, S.A., PANAMA CITY, PANAMA, FILED 9-4-2001.

A POUND A PINT DRINK AND SHRINK

FOR DIETARY SUPPLEMENTS AND MEAL REPLACEMENT DRINKS (U.S. CLS. 6, 18, 44, 46, 51 AND 52).

SN 78-072,382. BAUSCH & LOMB PHARMACEUTICALS, INC., TAMPA, FL. FILED 7-5-2001.

PRESERVISION

FOR VITAMIN AND MINERAL SUPPLEMENTS (U.S. CLS. 6, 18, 44, 46, 51 AND 52).

SN 78-084,187. SYSTEMS GO INTERNATIONAL CORPORATION, TAMPA, FL. FILED 9-17-2001.

GO

OWNER OF U.S. REG. NO. 1,559,517.
FOR NUTRITIONAL HIGH PROTEIN, LOW FAT BEVERAGES FORMULATED FOR USE BEFORE AND AFTER EXERCISE AND AS MEAL REPLACEMENTS (U.S. CLS. 6, 18, 44, 46, 51 AND 52).
FIRST USE 6-1-2001; IN COMMERCE 6-1-2001.

CLASS 6—METAL GOODS

SN 75-664,235. BALL CHAIN MANUFACTURING CO., INC., MOUNT VERNON, NY. FILED 3-19-1999.

BCM

FOR METAL BEADED TYPE CHAIN, HOLLOW METAL SHAPES FOR FURTHER ASSEMBLY, METAL WIRE FORMS, NAMELY, JUMP RINGS, HOOKS, AND WIRE PRODUCTS SHAPED INTO SPECIAL FORMS, NAMELY, SNAP HOOKS, CURTAIN HOOKS AND END RINGS FOR BEADED TYPE CHAIN; METAL CONTACT PINS; FORMED METAL STAMPINGS FOR BEADED TYPE CHAIN CONNECTORS; AND METAL KEY RINGS (U.S. CLS. 2, 12, 13, 14, 23, 25 AND 50).

SN 75-904,489. WHIRLWIND STEEL BUILDINGS, INC., HOUSTON, TX. FILED 1-28-2000.

LOW RIB

NO CLAIM IS MADE TO THE EXCLUSIVE RIGHT TO USE "RIB", APART FROM THE MARK AS SHOWN.

FOR STEEL ROOFING AND SIDING PANELS FOR INSTALLATION ON COMMERCIAL AND INDUSTRIAL STEEL BUILDINGS (U.S. CLS. 2, 12, 13, 14, 23, 25 AND 50).

SN 76-023,710. BENERI S.P.A., 23868 VALMADRERA, LECO, ITALY, FILED 4-12-2000.

BENERI

PRIORITY CLAIMED UNDER SEC. 44(D) ON ERP CMNTY TM OFC APPLICATION NO. 1523422, FILED 2-23-2000, REG. NO. 1523422, DATED 5-7-2001, EXPIRES 5-7-2011.

FOR METAL SPRING WASHERS, METAL RETAINING RINGS, METAL SCREWS AND BOLTS, NAILS, METAL WASHERS AND METAL SPACING WASHERS AND OTHER SMALL METAL ITEMS, NAMELY, METAL SPRING PINS (U.S. CLS. 2, 12, 13, 14, 23, 25 AND 50). FIRST USE 0-0-1958; IN COMMERCE 0-0-1987.

SN 76-027,158. JUN KAUNG INDUSTRIES CO., LTD., TAICHUNG, TAIWAN, FILED 4-17-2000.

JUN KAUNG

"JUN KAUNG" DOES NOT IDENTIFY A LIVING INDIVIDUAL.

FOR METAL STRAPPING OR TIE DOWNS, METAL HOOKS (U.S. CLS. 2, 12, 13, 14, 23, 25 AND 50). FIRST USE 6-1-1992; IN COMMERCE 1-1-1998.

CLASS 6—(Continued).

SN 76-057,056. MILBANK MANUFACTURING COMPANY, KANSAS CITY, MO. FILED 5-25-2000.

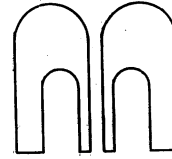

THE MARK CONSISTS OF THE LETTER "M" IN STYLIZED FORM.

FOR METAL BOXES, NAMELY, EMPTY METAL ELECTRICAL ENCLOSURES FOR HOUSING TELEPHONE LINE JUNCTIONS, CABLE TELEVISION JUNCTIONS, ELECTRICAL JUNCTIONS, POWER OUTLETS, TRANSFORMERS, GENERAL DUTY ELECTRICAL SWITCHES, SAFETY SWITCHES, TEST SWITCHES, CONDUIT HUBS, WIREWAY GUTTERS, ELECTRICAL DISCONNECT DEVICES, CONTROL PANELS, INSTRUMENTATION PANELS, CURRENT TRANSFORMERS, DISTRIBUTION UNIT SUBSTATIONS, CIRCUIT BREAKERS, RESIDENTIAL AND COMMERCIAL ELECTRIC METERS AND ELECTRICAL WIRING (U.S. CLS. 2, 12, 13, 14, 23, 25 AND 50).

SN 76-063,263. GENERAL MOTORS CORPORATION, DETROIT, MI. FILED 6-5-2000.

CHEVROLET

OWNER OF U.S. REG. NOS. 1,471,518, 2,348,249 AND OTHERS.

FOR METAL MONEY CLIPS, METAL KNOBS, NON-MECHANICAL METAL STREET SIGNS, NON-MECHANICAL METAL PARKING SIGNS, NON-MECHANICAL TIN SIGNS, METAL KEY RINGS, METAL LICENSE PLATES (U.S. CLS. 2, 12, 13, 14, 23, 25 AND 50). FIRST USE 9-0-1995; IN COMMERCE 9-0-1995.

SN 76-063,276. GENERAL MOTORS CORPORATION, DETROIT, MI. FILED 6-5-2000.



OWNER OF U.S. REG. NOS. 1,471,518, 2,348,249 AND OTHERS.

FOR METAL MONEY CLIPS, METAL KNOBS, NON-MECHANICAL METAL STREET SIGNS, NON-MECHANICAL METAL PARKING SIGNS, NON-MECHANICAL TIN SIGNS, METAL KEY RINGS, METAL LICENSE PLATES (U.S. CLS. 2, 12, 13, 14, 23, 25 AND 50). FIRST USE 10-0-1996; IN COMMERCE 10-0-1996.

CLASS 6—(Continued).

SN 76-088,675. GUTTER TOPPER, LTD., AMELIA, OH. FILED 7-13-2000.

THE ONLY SOLUTION TO GUTTER POLLUTION

OWNER OF U.S. REG. NO. 2,349,295.
FOR METAL RAIN GUTTER SHIELDS (U.S. CLS. 2, 12, 13, 14, 23, 25 AND 50).
FIRST USE 12-2-1999; IN COMMERCE 12-2-1999.

SN 76-139,989. HABERSHAM METAL PRODUCTS COMPANY, CORNELIA, GA. FILED 10-2-2000.

HABERSHAM

FOR METAL DOOR FRAMES, METAL DOORS, METAL SECURITY DOORS, METAL SECURITY DOOR FRAMES, METAL ANCHORS FOR SECURING DOOR FRAMES TO WALLS, METAL WINDOW FRAMES, METAL SECURITY WINDOWS, METAL SECURITY WINDOW FRAMES, METAL ANCHORS FOR SECURING WINDOW FRAMES TO WALLS, DOOR FRAME AND DOOR COVER PLATES FOR LOCK SETS, METAL HINGES, METAL VENTILATING LOUVERS, METAL WINDOW PANE GLAZING STOPS, METAL DOOR ASTRAGELS, METAL WALL PANELS, METAL SHELVING, METAL DRAWERS, METAL DOOR PASS-THROUGHS, METAL DETENTION DOORS, METAL DETENTION WINDOWS, METAL TOOL RESISTANT DOOR AND WINDOW BARS, AND MASKING GUARD TO FIT OVER INLETTED HINGE AREA IN DOOR FRAME TO PREVENT INTRUSION OF GROUTING MATERIALS (U.S. CLS. 2, 12, 13, 14, 23, 25 AND 50).
FIRST USE 1-1-1958; IN COMMERCE 1-1-1958.

SN 76-230,031. ROLL-N-GO, INC., PRIOR LAKE, MN. FILED 3-23-2001.

ROLL-N-GO

FOR METAL WATERCRAFT RAMPS (U.S. CLS. 2, 12, 13, 14, 23, 25 AND 50).
FIRST USE 5-4-2001; IN COMMERCE 5-17-2001.

SN 76-236,654. ENGLERT, INC., PERTH AMBOY, NY. FILED 4-9-2001.

ENGLERT T-SEAM

OWNER OF U.S. REG. NOS. 1,274,780, 1,832,596 AND 1,833,649.
NO CLAIM IS MADE TO THE EXCLUSIVE RIGHT TO USE "T-SEAM", APART FROM THE MARK AS SHOWN. SEC. 2(F).
FOR BUILDING PRODUCTS, NAMELY, METAL ROOFING PANELS AND FASTENERS AND ACCESSORIES THEREFOR (U.S. CLS. 2, 12, 13, 14, 23, 25 AND 50).

CLASS 6—(Continued).

SN 76-272,180. WYNN RESORTS, LLC, LAS VEGAS, NV. FILED 6-15-2001.

LE REVE

THE ENGLISH TRANSLATION OF "LE REVE" IS "THE DREAM".
FOR METAL KEY CHAINS, METAL BANKS, METAL BOXES AND METAL JEWELRY BOXES, METAL MONEY CLIPS, SCULPTURE OF METAL (U.S. CLS. 2, 12, 13, 14, 23, 25 AND 50).

SN 76-278,235. UTD INCORPORATED, MANASSAS, VA. FILED 6-28-2001.

SAFETYLINK

FOR COUPLINGS MADE PRIMARILY OF METAL THAT AUTOMATICALLY RELEASE WHEN IMPACTED, FOR UTILITY POLE GUY WIRES (U.S. CLS. 2, 12, 13, 14, 23, 25 AND 50).

SN 76-279,032. CONTINUOUS COATING CORP., ORANGE, CA. FILED 7-2-2001.

CCCORP.

FOR CORNERBEADS AND DRYWALL TRIM MADE PRIMARILY OF METAL FOR DRYWALL CONSTRUCTION (U.S. CLS. 2, 12, 13, 14, 23, 25 AND 50).
FIRST USE 0-0-1984; IN COMMERCE 0-0-1984.

SN 76-292,583. SINOX COMPANY LTD., TAIPEI, TAIWAN, FILED 7-31-2001.

WINDOW DIAL

FOR METAL LOCKS, METAL PADLOCKS (U.S. CLS. 2, 12, 13, 14, 23, 25 AND 50).

SN 76-294,415. FOX RACING, INC., MORGAN HILL, CA. FILED 8-3-2001.



THE NAME "RICKY CARMICHAEL" IDENTIFIES A LIVING INDIVIDUAL WHOSE CONSENT IS OF RECORD.
FOR METAL KEY RINGS (U.S. CLS. 2, 12, 13, 14, 23, 25 AND 50).

CLASS 6—(Continued).

SN 76-313,325. NOVA MACHINE PRODUCTS CORPORATION, MIDDLEBURG HEIGHTS, OH. FILED 9-12-2001.



FOR THREADED NUTS, METAL BOLTS, METAL SCREWS AND STEEL BARS AND REGULAR STEEL BARS (U.S. CLS. 2, 12, 13, 14, 23, 25 AND 50).
FIRST USE 2-1-1986; IN COMMERCE 2-1-1986.

SN 78-025,060. SPRINT METAL - SOCIETE DE PRODUCTION INTERNATIONALE DE TREFILES, PUTEAUX, FRANCE, FILED 9-8-2000.

EXHAUST

OWNER OF FRANCE REG. NO. 003017912, DATED 3-29-2000, EXPIRES 3-29-2010.

FOR STAINLESS STEEL IN THE FORM OF WIRES USED IN THE MANUFACTURE OF METAL WELDING WIRES (U.S. CLS. 2, 12, 13, 14, 23, 25 AND 50).

SN 78-039,258. ROAD SYSTEMS, INC., BIG SPRING, TX. FILED 12-14-2000.

SKT

FOR METAL GUARDRAIL TERMINALS (U.S. CLS. 2, 12, 13, 14, 23, 25 AND 50).
FIRST USE 1-12-1998; IN COMMERCE 1-12-1998.

CLASS 7—MACHINERY

SN 75-423,498. CHROMA CORPORATION, MCHENRY, IL. FILED 1-26-1998.

CHROMA-SPERSE

OWNER OF U.S. REG. NOS. 1,613,449 AND 2,214,898.
FOR COLORANT DISPERSING MACHINES AND TINT BASES FOR USE THEREWITH SOLD TOGETHER AS A UNIT TO ORIGINAL EQUIPMENT MANUFACTURERS (OEMS) AND MANUFACTURERS OF OEMS IN THE PLASTICS INDUSTRY FOR USE IN THE MANUFACTURE OF COLORANT AND ADDITIVE CONCENTRATES USED IN THE MANUFACTURE OF THERMOPLASTICS (U.S. CLS. 13, 19, 21, 23, 31, 34 AND 35).

CLASS 7—(Continued).

SN 75-456,986. MIKRON HOLDING AG, CH-2502 BIEL, SWITZERLAND, FILED 3-25-1998.

FLEXCELL

OWNER OF SWITZERLAND REG. NO. 419237, DATED 9-29-1995, EXPIRES 9-29-2015.

FOR AUTOMATIC ASSEMBLY MACHINES, NAMELY, LINEAR AND ROTARY SYNCHRONOUS AND NON-SYNCHRONOUS ASSEMBLY CELLS; TRANSFER MACHINES, NAMELY, MACHINES FOR THE AUTOMATIC ASSEMBLING AND PROCESSING OF PRODUCTION PARTS; INDUSTRIAL ROBOTS; INDUSTRIAL TRANSPORT AND FEEDING MACHINES, NAMELY, VIBRATORY FEEDERS AND FLEXIBLE PARTS FEEDERS (U.S. CLS. 13, 19, 21, 23, 31, 34 AND 35).

SN 75-622,625. SEVA GARCIA, MATILDE, 03009 ALICANTE, SPAIN, FILED 1-19-1999.

MASETO

OWNER OF SPAIN REG. NO. 593283, DATED 11-29-1973, RENEWED AS REG. NO. 593283, DATED 7-10-1999, EXPIRES 7-10-2009.

FOR MACHINES AND MACHINE TOOLS FOR TREATING SEED, FRUIT AND NUTS, NAMELY, CLEANERS, PEELERS, HULLERS, SEPARATORS AND SIZERS, CLASSIFIERS, DRIERS AND ROASTERS, DESTONERS, BRUSHES, CONVEYOR BELTS, ELEVATORS, COOLERS SCALDERS, VIBRATORS, PNEUMATIC SEPARATORS, SLICING, CUBING AND STICK MAKING MACHINES; MACHINES FOR MAKING FLOUR; ELECTRIC MOTORS AND ENGINES FOR MACHINES; MACHINE PARTS, NAMELY, MACHINE COUPLING AND TRANSMISSIONS; AGRICULTURAL MACHINES, NAMELY, COMBINES, TILLERS AND BAILERS; INCUBATORS FOR EGGS; MACHINERY FOR WOOD, NAMELY, POWER-OPERATED WOOD SAWS (U.S. CLS. 13, 19, 21, 23, 31, 34 AND 35).

SN 75-771,460. ROBERT BOSCH GMBH, D-70839 GERLINGEN, FED REP GERMANY, FILED 8-9-1999.

CLIC

OWNER OF U.S. REG. NOS. 1,781,108 AND 1,785,225.
FOR POWER TOOLS, NAMELY, ANGLE GRINDERS, HANDSAWS, JIGSAWS, RECIPROCATING SAWS, ROUTERS AND CORNER DETAIL SANDERS; POWER TOOL COMPONENTS, NAMELY, GRINDING WHEELS, SAW BLADES AND SANDPAPER BELTS (U.S. CLS. 13, 19, 21, 23, 31, 34 AND 35).
FIRST USE 12-0-1989; IN COMMERCE 12-0-1989.

CLASS 7—(Continued).

SN 75-815,870. PATTERSON PUMP COMPANY, TOCCOA, GA. FILED 10-5-1999.

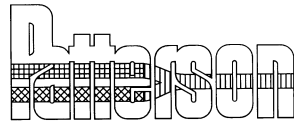

OWNER OF U.S. REG. NOS. 2,442,160, 2,442,162 AND 2,442,163.

THE DRAWING IS LINED FOR THE COLORS YELLOW, ORANGE, AND RED.

THE MARK CONSISTS OF A TUNING FORK DESIGN WITHIN THE WORD "PATTERSON".

FOR PROCESS CONTROL EQUIPMENT, NAMELY, SIZE REDUCTION, MILLING, DRYING, REACTING, AND BLENDING MACHINES; AND GREASE KETTLES (U.S. CLS. 13, 19, 21, 23, 31, 34 AND 35).

FIRST USE 2-1-1986; IN COMMERCE 2-1-1986.

SN 75-885,435. AMERICAN TOOL COMPANIES, INC., HOFFMAN ESTATES, IL. FILED 1-7-2000.



OWNER OF U.S. REG. NO. 2,378,149.
 FOR POWER TOOL ACCESSORIES, NAMELY, QUICK CHANGE CHUCK FOR USE WITH STEP DRILLS, HOLE ENLARGING BITS, AUGER BITS, DRILL BITS, FLAT BITS, WOOD-BORING BITS, INSTALLER BITS, MASONRY DRILL BITS, BRAD POINT DRILL BITS, FORSTNER BITS, SCREW EXTRACTORS, SCREWDRIVER BITS, NUTSETTERS, SOCKET ADAPTORS AND PLUG CUTTERS (U.S. CLS. 13, 19, 21, 23, 31, 34 AND 35).
 FIRST USE 3-1-1999; IN COMMERCE 3-1-1999.

CLASS 7—(Continued).

SN 75-885,673. CMF OMAT S.R.L., PIACENZA (PC), ITALY, FILED 1-3-2000.

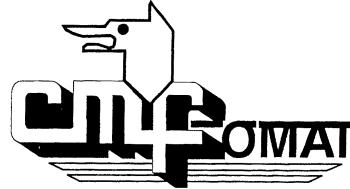

THE MARK CONSISTS OF IN PART OF A STYLIZED DEPICTION OF A DOG.

FOR PRINTING MACHINES AND THEIR CONSTITUENT PARTS, NAMELY CLICHE-HOLDER CYLINDERS AND INKING ROLLERS; PRINTING MACHINES AND REPLACEMENT PARTS THEREFOR; FLEXOGRAPHIC MACHINES AND THEIR CONSTITUENT PARTS, NAMELY CLICHE-HOLDER CYLINDERS AND INKING ROLLERS; FLEXOGRAPHIC MACHINES AND REPLACEMENT PARTS THEREFOR; PRINTING MACHINE PARTS, NAMELY PRINTING AND INKING ROLLERS (U.S. CLS. 13, 19, 21, 23, 31, 34 AND 35).

FIRST USE 3-14-1989; IN COMMERCE 0-0-1995.

SN 75-912,844. STARR HYDRAULICS, INC., WARREN, MI. FILED 2-7-2000.



NO CLAIM IS MADE TO THE EXCLUSIVE RIGHT TO USE "HYDRAULICS", APART FROM THE MARK AS SHOWN.

FOR RECONDITIONED HYDRAULIC COMPONENTS FOR USE IN MACHINES, NAMELY, POSITIVE DISPLACEMENT PUMPS, HYDRAULIC MOTORS NOT FOR VEHICLES, VALVES, VARIABLE SPEED HYDRAULIC TRANSMISSIONS, AND REPLACEMENT PARTS THEREFOR (U.S. CLS. 13, 19, 21, 23, 31, 34 AND 35).
 FIRST USE 10-15-1999; IN COMMERCE 10-15-1999.

SN 75-914,403. BALDWIN GRAPHIC SYSTEMS, INC., SHELTON, CT. FILED 2-9-2000.

ROTOPAC

FOR AUTOMATIC BLANKET CLEANER CLEANING CARTRIDGES, NAMELY, PRE-MOISTENED CLEANING CARTRIDGES USED IN THE PRINTING INDUSTRY (U.S. CLS. 13, 19, 21, 23, 31, 34 AND 35).

CLASS 7—(Continued).

SN 75-914,404. BALDWIN GRAPHIC SYSTEMS, INC., SHELTON, CT. FILED 2-9-2000.

RAPIDPAC

FOR AUTOMATIC BLANKET CLEANER CLEANING CARTRIDGES, NAMELY, PRE-MOISTENED CLEANING CARTRIDGES USED IN THE PRINTING INDUSTRY (U.S. CLS. 13, 19, 21, 23, 31, 34 AND 35).

SN 75-921,355. M.C.P., STD, L.P., DBA PRO CIRCUIT, NORCO, CA. FILED 2-16-2000.

T-4

FOR HIGH PERFORMANCE MOTORCYCLE PARTS; NAMELY, EXHAUST SYSTEMS COMPRISED OF MUFFLERS, EXHAUST PIPES, SILENCERS AND SPARK ARRESTERS (U.S. CLS. 13, 19, 21, 23, 31, 34 AND 35).
FIRST USE 1-4-2000; IN COMMERCE 1-4-2000.

SN 76-051,552. UNILOY MILACRON INC., MANCHESTER, MI. FILED 5-18-2000.

VERSAPET

FOR PLASTICS BLOW MOLDING MACHINES (U.S. CLS. 13, 19, 21, 23, 31, 34 AND 35).

SN 76-056,737. BMH MARINE AB, GUNNARSTORP, SE-267 25 BJUV, SWEDEN, FILED 5-25-2000.

NORDSTROMS

OWNER OF U.S. REG. NO. 1,135,509. SEC. 2(F).
FOR MECHANICAL AND PNEUMATIC CONVEYORS FOR BULK GOODS, PNEUMATIC TUBES, EDGE-ON AND BOX CONVEYORS, SORTING MACHINES, LOADING AND UNLOADING MACHINES (U.S. CLS. 13, 19, 21, 23, 31, 34 AND 35).
FIRST USE 0-0-1950; IN COMMERCE 0-0-1965.

CLASS 7—(Continued).

SN 76-059,646. JUN SHIAU MACHINERY COMPANY, TAI-CHUNG HSIEN, TAIWAN, CHINA, FILED 5-30-2000.



FOR POWER-OPERATED WOODWORKING MACHINES, NAMELY GRINDERS, PLANERS, MACHINES FOR WOOD PROCESSING, WOODWORKING LATHES, AND MACHINES FOR SEALING THE EDGES OF PROCESSED WOOD (U.S. CLS. 13, 19, 21, 23, 31, 34 AND 35).

FIRST USE 1-0-1980; IN COMMERCE 1-0-1981.

SN 76-079,163. SALTON, INC., MT. PROSPECT, IL. FILED 6-28-2000.

GEORGE FOREMAN

THE NAME "GEORGE FOREMAN" IDENTIFIES A LIVING INDIVIDUAL WHOSE CONSENT IS OF RECORD.

FOR ELECTRIC FOOD PREPARATION APPLIANCES, NAMELY, BLENDERS, MIXERS, FOOD PROCESSORS, JUICERS AND JUICE EXTRACTORS (U.S. CLS. 13, 19, 21, 23, 31, 34 AND 35).

SN 76-082,214. BURBULLA, HORST, DBA TECHNOCRANE, 53113 BONN, FED REP GERMANY, FILED 7-3-2000.

TECHNODOLLY

FOR AUTOMATIC CAMERA CRANE EQUIPMENT, NAMELY, TELESCOPING CAMERA CRANES WITH REMOTE CONTROLLED CAMERA MOUNT (U.S. CLS. 13, 19, 21, 23, 31, 34 AND 35).

SN 76-089,131. HALM INDUSTRIES CO., INC., GLEN HEAD, NY. FILED 7-14-2000.

JET

FOR COMMERCIAL OFFSET DOCUMENT PRINTING PRESSES (U.S. CLS. 13, 19, 21, 23, 31, 34 AND 35).
FIRST USE 11-13-1958; IN COMMERCE 11-13-1958.

CLASS 7—(Continued).

SN 76-092,371. JUN SHIAU MACHINERY COMPANY, FENG-YUAN CITY, TAICHUNG HSIEN, TAIWAN, FILED 7-19-2000.

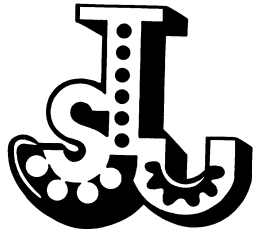

FOR POWER-OPERATED WOODWORKING MACHINES, NAMELY, GRINDERS, PLANERS, MACHINES FOR WOOD PROCESSING, WOODWORKING LATHES, AND MACHINES FOR SEALING THE EDGES OF PROCESSED WOOD (U.S. CLS. 13, 19, 21, 23, 31, 34 AND 35).

FIRST USE 1-0-1980; IN COMMERCE 1-0-1981.

SN 76-118,831. SOLENT & PRATT (ENGINEERING) LIMITED, ROYTON, OLDHAM, UNITED KINGDOM, FILED 1-6-2000.

TOSV

FOR VALVES FOR INDUSTRIAL MACHINES (U.S. CLS. 13, 19, 21, 23, 31, 34 AND 35).

SN 76-144,970. GRAF & CIE AG, 8640 RAPPERSWIL, SWITZERLAND, FILED 10-11-2000.

resist-O-top

PRIORITY CLAIMED UNDER SEC. 44(D) ON SWITZERLAND APPLICATION NO. 10327/2000, FILED 8-30-2000, REG. NO. 481258, DATED 8-30-2000, EXPIRES 8-30-2010.
FOR CARDFLATS FOR CARDING MACHINES FOR COTTON CARDS (U.S. CLS. 13, 19, 21, 23, 31, 34 AND 35).

CLASS 7—(Continued).

SN 76-154,402. BOBST, S.A., CH-1001 LAUSANNE, SWITZERLAND, FILED 10-26-2000.

SPRINTERA

PRIORITY CLAIMED UNDER SEC. 44(D) ON SWITZERLAND APPLICATION NO. 05454/2000, FILED 5-5-2000, REG. NO. 477648, DATED 5-5-2000, EXPIRES 5-5-2010.

FOR MACHINES FOR THE CONVERTING OF PAPER, CARDBOARD AND CORRUGATED CARDBOARD INTO BOX BLANKS FOR THE PACKAGING INDUSTRY (U.S. CLS. 13, 19, 21, 23, 31, 34 AND 35).

SN 76-158,393. DS TECHNOLOGIE WERKZEUGMASCHINENBAU GMBH, D41236 MONCHENGLADBACH, FED REP GERMANY, FILED 11-2-2000.

DS TECHNOLOGIE

PRIORITY CLAIMED UNDER SEC. 44(D) ON FED REP GERMANY APPLICATION NO. 30034028.1/0, FILED 5-4-2000, REG. NO. 30034028, DATED 5-4-2000, EXPIRES 5-4-2010.
NO CLAIM IS MADE TO THE EXCLUSIVE RIGHT TO USE "TECHNOLOGIE", APART FROM THE MARK AS SHOWN.

FOR POWER OPERATED MACHINE TOOLS, NAMELY, DRILLS, VERTICAL AND HORIZONTAL LATHES AND DEEP BORE DRILLS; VERTICAL AND HORIZONTAL MILLING MACHINES; MULTIPLE PURPOSE POWER OPERATED MACHINES, WHICH CAN DRILL, BORE, MILL OR GRIND; POWER OPERATED TOOLS, NAMELY, GRINDERS; ALL OF THE FOREGOING BEING EITHER COMPUTER CONTROLLED OR NOT COMPUTER CONTROLLED (U.S. CLS. 13, 19, 21, 23, 31, 34 AND 35).

SN 76-159,694. ROWEND INDUSTRIES, INC., LIBERTY CENTER, OH. FILED 11-6-2000.

ULTRA LUBE

NO CLAIM IS MADE TO THE EXCLUSIVE RIGHT TO USE "LUBE", APART FROM THE MARK AS SHOWN.
FOR MACHINE PARTS, NAMELY, BEARINGS AND BUSHINGS (U.S. CLS. 13, 19, 21, 23, 31, 34 AND 35).
FIRST USE 1-0-1994; IN COMMERCE 1-0-1994.

SN 76-170,515. CHROMALLOY GAS TURBINE CORPORATION, SAN ANTONIO, TX. FILED 11-24-2000.

CG T DER

FOR REPAIRED COMPONENTS FOR GAS TURBINE ENGINES, NAMELY, BLADES, VANES, DUCTS, SEALS, CASES AND FRAMES (U.S. CLS. 13, 19, 21, 23, 31, 34 AND 35).
FIRST USE 7-11-1999; IN COMMERCE 7-11-1999.

CLASS 7—(Continued).

SN 76-184,798. DELAWARE CAPITAL FORMATION, INC., WILMINGTON, DE. FILED 12-21-2000.



OWNER OF U.S. REG. NO. 556,864.
NO CLAIM IS MADE TO THE EXCLUSIVE RIGHT TO USE "TECHNOLOGY", APART FROM THE MARK AS SHOWN.

THE MARK CONSISTS OF THE WORD "ROTARY" CONTAINED IN AN OVAL WHEREIN UNDERNEATH AND TO THE RIGHT ARE THE WORDS "INBAY TECHNOLOGY" BEING BORDERED ON THE RIGHT MARGIN BY AN ELLIPTICAL CRESCENT.

FOR AUTOMOTIVE VEHICLE SERVICE LIFTS FEATURING LCD SCREEN DISPLAYS OF PICKUP POINTS FOR VEHICLES (U.S. CLS. 13, 19, 21, 23, 31, 34 AND 35).
FIRST USE 10-30-2000; IN COMMERCE 10-30-2000.

SN 76-194,558. RIVAL COMPANY, THE, KANSAS CITY, MO. FILED 1-16-2001.

ARCTIC ICE

NO CLAIM IS MADE TO THE EXCLUSIVE RIGHT TO USE "ICE", APART FROM THE MARK AS SHOWN.

FOR ELECTRIC ICE SHAVING MACHINES (U.S. CLS. 13, 19, 21, 23, 31, 34 AND 35).

SN 76-201,729. N/S CORPORATION, INGLEWOOD, CA. FILED 1-29-2001.

CHALLENGER

FOR VEHICLE WASHING MACHINES (U.S. CLS. 13, 19, 21, 23, 31, 34 AND 35).

SN 76-208,743. SECO TOOLS AB, 82 FAGERSTA, SWEDEN, FILED 2-12-2001.

EASYSHRINK

PRIORITY CLAIMED UNDER SEC. 44(D) ON SWEDEN APPLICATION NO. 00-09428, FILED 12-15-2000, REG. NO. 346126, DATED 5-11-2001, EXPIRES 12-15-2020.

FOR POWER OPERATED MILLING TOOLS, NAMELY, MILLING CUTTERS AND MILLING CUTTER INSERTS (U.S. CLS. 13, 19, 21, 23, 31, 34 AND 35).

CLASS 7—(Continued).

SN 76-212,077. SAMSUNG ELECTRONICS CO., LTD., KYUNGKI-DO, REPUBLIC OF KOREA, FILED 2-20-2001.

QUIET JET

NO CLAIM IS MADE TO THE EXCLUSIVE RIGHT TO USE "QUIET", APART FROM THE MARK AS SHOWN.
FOR ELECTRIC VACUUM CLEANERS (U.S. CLS. 13, 19, 21, 23, 31, 34 AND 35).

SN 76-212,143. NORDSON CORPORATION, WESTLAKE, OH. FILED 2-20-2001.

SURE CLEAN

NO CLAIM IS MADE TO THE EXCLUSIVE RIGHT TO USE "CLEAN", APART FROM THE MARK AS SHOWN.

FOR POWDER COATING SPRAY BOOTHS (U.S. CLS. 13, 19, 21, 23, 31, 34 AND 35).

SN 76-215,383. WILDCAT MANUFACTURING CO., INC., FREEMAN, SD. FILED 2-26-2001.

WEMCOM

FOR MACHINES, NAMELY, SCREENERS, GRINDERS, SOLID WASTE SORTERS, BAG RIPPERS, MATERIAL RECOVERY MACHINES, TROMMELS, COMPOSTING MACHINES, SNOW BLOWERS, AND ROAD PATCHING AND ROAD FIXING MACHINES AND REPLACEMENT AND STRUCTURAL PARTS FOR ALL OF THE AFORESAID GOODS (U.S. CLS. 13, 19, 21, 23, 31, 34 AND 35).

SN 76-228,378. MIBRO GROUP, L.C., THE, BUFFALO, NY. FILED 3-21-2001.

DRIWALL PRO

PRIORITY CLAIMED UNDER SEC. 44(D) ON CANADA APPLICATION NO. 1,081,915, FILED 11-8-2000.

NO CLAIM IS MADE TO THE EXCLUSIVE RIGHT TO USE "DRYWALL", APART FROM THE MARK AS SHOWN.

FOR POWER DRILL ACCESSORIES FOR DRIVING SCREWS (U.S. CLS. 13, 19, 21, 23, 31, 34 AND 35).

SN 76-257,704. HITEC CO., LTD., KANAGAWA, JAPAN, FILED 5-15-2001.

MACHWEL

FOR SAUSAGE PRODUCING MACHINES, NAMELY, SAUSAGE MEAT STUFFING MACHINES, SAUSAGE LINKING MACHINES, AND SAUSAGE SUSPENDING MACHINES (U.S. CLS. 13, 19, 21, 23, 31, 34 AND 35).

CLASS 7—(Continued).

SN 76-275,222. ROLCON, INC., CINCINNATI, OH. FILED 6-25-2001.

FRAMESAVER

FOR MACHINE PARTS, NAMELY, CONVEYOR ROLLERS (U.S. CLS. 13, 19, 21, 23, 31, 34 AND 35).
FIRST USE 6-13-2001; IN COMMERCE 6-13-2001.

CLASS 7—(Continued).

SN 78-016,754. BAKER HUGHES INCORPORATED, HOUSTON, TX. FILED 7-14-2000.

CENTRIWASH

FOR SEPARATION AND FILTRATION MACHINES, NAMELY, CENTRIFUGES AND PARTS THEREFOR (U.S. CLS. 13, 19, 21, 23, 31, 34 AND 35).

SN 76-277,992. SIMONDS INDUSTRIES, INC., FITCHBURG, MA. FILED 6-28-2001.

TURBO TOOTH

NO CLAIM IS MADE TO THE EXCLUSIVE RIGHT TO USE "TOOTH", APART FROM THE MARK AS SHOWN.
FOR BAND SAW BLADES (U.S. CLS. 13, 19, 21, 23, 31, 34 AND 35).

SN 78-016,758. BAKER HUGHES INCORPORATED, HOUSTON, TX. FILED 7-14-2000.

TURBOPOWER

FOR SEPARATION AND FILTRATION MACHINES, NAMELY, CENTRIFUGES AND PARTS THEREFOR (U.S. CLS. 13, 19, 21, 23, 31, 34 AND 35).

SN 76-290,572. VAN DORN DEMAG CORPORATION, STRONGSVILLE, OH. FILED 7-27-2001.

Int)Efect

"THE MARK CONSISTS OF "INT ELECT", INTERSECTED WITH A STYLIZED "V" OR CHECK BETWEEN LETTERS "T" AND "E".
FOR PLASTIC INJECTION MOLDING MACHINES (U.S. CLS. 13, 19, 21, 23, 31, 34 AND 35).

SN 78-016,759. BAKER HUGHES INCORPORATED, HOUSTON, TX. FILED 7-14-2000.

ULTRADRY

FOR SEPARATION AND FILTRATION MACHINES, NAMELY, CENTRIFUGES AND PARTS THEREFOR (U.S. CLS. 13, 19, 21, 23, 31, 34 AND 35).

SN 76-305,363. THOMAS INDUSTRIES, INC., LOUISVILLE, KY. FILED 8-27-2001.

TRIGON

FOR MACHINE PARTS, NAMELY PISTON SEALS FOR USE IN COMPRESSORS (U.S. CLS. 13, 19, 21, 23, 31, 34 AND 35).

SN 78-074,069. FERROTEC (USA) CORPORATION, NASHUA, NH. FILED 7-16-2001.

FERRODRIVE

FOR MACHINE, NAMELY, A VACUUM FEED-THROUGH MACHINE WITH INTEGRATED COAXIAL MOTOR AND OTHER MOTION CONTROL SYSTEMS FOR GENERATING CONTROLLED ROTARY MOTION OUTSIDE OF A SEALED ENVIRONMENT AND TRANSMITTING THAT MOTION INTO A SEALED ENVIRONMENT (U.S. CLS. 13, 19, 21, 23, 31, 34 AND 35).

SN 78-016,753. BAKER HUGHES INCORPORATED, HOUSTON, TX. FILED 7-14-2000.

CENTRITHIK

FOR SEPARATION AND FILTRATION MACHINES, NAMELY, CENTRIFUGES AND PARTS THEREFOR (U.S. CLS. 13, 19, 21, 23, 31, 34 AND 35).

SN 78-080,157. O/K INTERNATIONAL CORP., MARLBOROUGH, MA. FILED 8-20-2001.

OK SUPERSEALER

NO CLAIM IS MADE TO THE EXCLUSIVE RIGHT TO USE "SUPERSEALER", APART FROM THE MARK AS SHOWN.
FOR PACKAGING MACHINES (U.S. CLS. 13, 19, 21, 23, 31, 34 AND 35).

CLASS 7—(Continued).

SN 78-084,594. CHAMPION INDUSTRIES, INC., WINSTON-SALEM, NC. FILED 9-19-2001.

VALU-CLEAN

FOR DISHWASHING AND GLASS WASHING MACHINES AND PARTS AND COMPONENTS FOR DISHWASHING AND GLASS WASHING MACHINES (U.S. CLS. 13, 19, 21, 23, 31, 34 AND 35).

CLASS 8—HAND TOOLS

SN 76-041,400. U.S. NORDIC IMPORT & EXPORT COMPANY, PARKTON, MD. FILED 5-3-2000.

WIPER CLEAR

NO CLAIM IS MADE TO THE EXCLUSIVE RIGHT TO USE "WIPER", APART FROM THE MARK AS SHOWN.

FOR HAND-HELD TOOL FOR CLEANING BLADES OF WINDSHIELD WIPERS AND SQUEEGEES, ALSO CONTAINING AN EXTRACTABLE NEEDLE FOR CLEANING THE FLUID HOLE OF WINDSHIELD WASHING NOZZLE (U.S. CLS. 23, 28 AND 44).
FIRST USE 5-1-2000; IN COMMERCE 5-1-2000.

SN 76-083,591. BIRD BRAIN, INC., YPSILANTI, MI. FILED 7-6-2000.

BUSY BEE

FOR HAND OPERATED GARDEN TOOLS, NAMELY, TROWELS, BULB PLANTERS, FORKS, RAKES AND WEED PULLERS (U.S. CLS. 23, 28 AND 44).

SN 76-102,330. HOSTAR, INC., NORCROSS, GA. FILED 8-3-2000.

HOSTAR

FOR HAND TOOLS, NAMELY TAPE FOLDERS FOR MASKING OBJECTS TO BE PAINTED (U.S. CLS. 23, 28 AND 44).

SN 76-238,283. WYOMING KNIFE CORPORATION, FT. COLLINS, CO. FILED 4-9-2001.

WYOMING KNIFE

NO CLAIM IS MADE TO THE EXCLUSIVE RIGHT TO USE "KNIFE", APART FROM THE MARK AS SHOWN.
SEC. 2(F).
FOR HUNTING KNIVES (U.S. CLS. 23, 28 AND 44).
FIRST USE 2-13-1972; IN COMMERCE 2-13-1972.

CLASS 8—(Continued).

SN 76-288,394. NUSSLE SPECIAL TOOLS, LLC, ORLANDO, FL. FILED 7-23-2001.



NO CLAIM IS MADE TO THE EXCLUSIVE RIGHT TO USE "SPECIAL TOOLS", APART FROM THE MARK AS SHOWN.

FOR TOOLS, NAMELY, SPECIAL HAND OPERATED METAL FABRICATED STANDS USED TO HOLD AUTO BODY PARTS FOR PAINTING AND FINISHING (U.S. CLS. 23, 28 AND 44).

SN 76-310,359. QVC, INC., WEST CHESTER, PA. FILED 9-7-2001.

GLENDEN

FOR FLATWARE, NAMELY KNIVES, FORKS AND SPOONS (U.S. CLS. 23, 28 AND 44).

SN 78-037,778. BALDENBACH VON BROECHEN, HANS PETER, ROT AM SEE, FED REP GERMANY, FILED 12-5-2000.

**THE MAGIC KNIFE**

NO CLAIM IS MADE TO THE EXCLUSIVE RIGHT TO USE "THE MAGIC KNIFE", APART FROM THE MARK AS SHOWN.

THE MARK CONSISTS IN PART OF A REPRESENTATION OF A SHIELD.

FOR KITCHEN KNIFE WITH PARALLEL ADJUSTABLE CUTTING GUIDE FOR PERFECT SLICES (U.S. CLS. 23, 28 AND 44).

FIRST USE 0-0-1997; IN COMMERCE 10-27-2000.

SN 78-038,680. FURITECHNICS PTY LTD., WEST END, AUSTRALIA, FILED 12-11-2000.

FOR PROFESSIONAL COOKING KNIVES, NAMELY, CHEF KNIVES, PARING KNIVES AND KITCHEN KNIVES AND RELATED ACCESSORIES (U.S. CLS. 23, 28 AND 44).

FIRST USE 2-28-1998; IN COMMERCE 1-31-1999.

CLASS 8—(Continued).

SN 78-057,187. PICKARD, MICHAEL JOSEPH, PALOS VERDES ESTATES, CA. FILED 4-6-2001.

"THE GRAZOR"

FOR SMALL, DISPOSABLE, COMB ATTACHMENT TO ALL DISPOSABLE RAZORS FOR EVEN AND CONVENIENT TRIMMING OF BEARDS, GOTIES, MUSTACHES, AND ANY OTHER APPLICABLE BODY HAIR (U.S. CLS. 23, 28 AND 44).

SN 78-080,008. SHEAR DYNAMICS, INC., RED OAK, TX. FILED 8-19-2001.

KAMI

FOR RAZOR FOR CUTTING HUMAN HAIR; SCISSORS, CLIPPERS [ELECTRIC OR NON], HAIR TRIMMERS [ELECTRIC OR NON], RAZOR BLADES ALL USED FOR CUTTING HUMAN HAIR (U.S. CLS. 23, 28 AND 44).

FIRST USE 5-1-1999; IN COMMERCE 6-17-1999.

SN 78-083,162. MATSUSHITA ELECTRIC WORKS, LTD., OSAKA, JAPAN, FILED 9-7-2001.

LINEAR

FOR ELECTRIC SHAVER (U.S. CLS. 23, 28 AND 44).

CLASS 9—ELECTRICAL AND SCIENTIFIC APPARATUS

SN 74-500,385. BLACKHAWK, NASHVILLE, TN. FILED 2-2-1994.



FOR PRE-RECORDED COMPACT DISCS, PHONOGRAPH RECORDS, VIDEO AND AUDIO CASSETTE TAPES FEATURING MUSIC (U.S. CLS. 21 AND 36).

FIRST USE 8-20-1992; IN COMMERCE 3-19-1993.

CLASS 9—(Continued).

SN 75-154,150. INTERNATIONAL DATA GROUP, INC., FRAMINGHAM, MA. FILED 8-20-1996.

FOR DUMMIES

OWNER OF U.S. REG. NOS. 1,759,840, 1,852,364 AND OTHERS.

FOR PRERECORDED CD-ROMS IN THE FIELD OF MUSIC (U.S. CLS. 21, 23, 26, 36 AND 38).

FIRST USE 10-31-1996; IN COMMERCE 10-31-1996.

SN 75-210,383. MENARD, INC., EAU CLAIRE, WI. FILED S.R. 12-9-1996; AM. P.R. 12-8-2001.

DESIGN IT

SEC. 2(F).

FOR SELF-SERVICE COMPUTERIZED APPARATUS CONTAINING PLANNING AND ESTIMATING INFORMATION ON SMALL STRUCTURES, NAMELY, HOUSES, GARAGES, SHEDS AND BARNs AND ALSO CONTAINING RENDERING AND MATERIALS ESTIMATING INFORMATION (U.S. CLS. 21, 23, 26, 36 AND 38).

FIRST USE 12-17-1993; IN COMMERCE 4-21-1994.

SN 75-297,539. ALPHABLOX CORPORATION, MOUNTAIN VIEW, CA. FILED 5-23-1997.

BLOX

OWNER OF U.S. REG. NO. 2,476,877.

FOR COMPUTER SOFTWARE CONSISTING OF PRODUCTION TOOLS USED TO CREATE ONE OR MORE APPLICATION PROGRAMS FOR COMPUTERS BUT NOT FOR USE IN ENGINEERING AND DESIGN OF SYSTEMS INVOLVING DYNAMIC MOTION, OPERATING OPTICAL MARK READERS AND HOSPITAL LABORATORY RECORD KEEPING, PROVIDING ANIMATION FOR DRAWING ILLUSTRATIONS, CHARACTER BASED, CAD, ANIMATION, GRAPHICS AND DESIGN MODELING APPLICATIONS, AND FOR CREATING SOUNDTRACKS FROM A DATABASE OF SOUND LIBRARIES (U.S. CLS. 21, 23, 26, 36 AND 38).

SN 75-382,388. AONIX, SAN DIEGO, CA. FILED 10-31-1997.

RAVEN RT

NO CLAIM IS MADE TO THE EXCLUSIVE RIGHT TO USE "RT", APART FROM THE MARK AS SHOWN.

FOR COMPUTER OPERATING SOFTWARE FOR USE IN EMBEDDED SYSTEMS DEVELOPED FOR REAL-TIME AND SAFETY-CRITICAL MARKETS (U.S. CLS. 21, 23, 26, 36 AND 38).

CLASS 9—(Continued).

SN 75-382,389. AONIX, SAN DIEGO, CA. FILED 10-31-1997.

RAVEN

FOR COMPUTER OPERATING SOFTWARE FOR USE IN EMBEDDED SYSTEMS DEVELOPED FOR REAL-TIME AND SAFETY-CRITICAL MARKETS (U.S. CLS. 21, 23, 26, 36 AND 38).

SN 75-392,079. GAMMERLER GMBH, 82538 GERETSRIED-GELTING, FED REP GERMANY, FILED 11-18-1997.

GAMMERLER

PRIORITY CLAIMED UNDER SEC. 44(D) ON ERPN CMNTY TM OFC APPLICATION NO. 000550517, FILED 5-23-1997, REG. NO. 000550517, DATED 5-3-1999, EXPIRES 5-3-2009.

SEC. 2(F).
FOR ELECTRICAL INSTRUMENTS AND ALSO THEIR PARTS NAMELY ELECTRIC CONTROLS, ELECTRICAL REGULATORS, OPTICAL INSTRUMENTS AND ALSO THEIR PARTS NAMELY, OPTICAL SENSORS, OPTICAL DETECTORS, OPTICAL VIEWING SYSTEMS COMPRISING OPTICAL SCANNERS, OPTICAL FILTERS, OPTICAL LENS SIGHTS AND OPTICAL MIRRORS, OPTICAL INSPECTION APPARATUS FOR INDUSTRIAL USE, WEIGHT MEASURING INSTRUMENTS, NAMELY SCALES, MEASURING INSTRUMENTS AND ALSO THEIR PARTS, NAMELY POWER MEASURING INSTRUMENTS, NAMELY POWER QUALITY ANALYZERS, AMMETERS, VOLTMETERS AND POWER METERS, SPEED MEASURING INSTRUMENTS, NAMELY SPEEDOMETERS, ELECTRICAL, OPTICAL, ACOUSTICAL AND INFRARED SIGNALING INSTRUMENTS FOR THE TRANSMISSION OF DATA AND WARNING SIGNALS, ACCESS MONITORS, QUALITY MONITORS, POSITION SENSORS, PROXIMITY SENSORS AND SEQUENCE CONTROLLERS FOR USE IN CONTROLLING AUTOMATED HANDLING SYSTEMS FOR PRINTED PRODUCTS, DATA PROCESSORS AND COMPUTERS; COMPUTER PROGRAMS STORED ON DATA CARRIERS, NAMELY COMPUTER PROGRAMS FOR THE CONTROL OF AUTOMATED HANDLING SYSTEMS, HANDLING SYSTEMS FOR PRINTED PRODUCTS, COMPUTER SOFTWARE FOR THE OPERATION OF MACHINERY, COMPUTER PROGRAMS FOR THE CONTROL, REGULATION AND MONITORING OF PRODUCTION PROCESSES, NAMELY THE AUTOMATED HANDLING SYSTEMS FOR PRINTED PRODUCTS INCORPORATED INTO PRODUCTION PROCESSES, COMPUTER PROGRAMS FOR AUDITS, FOR ACCOUNTING, FOR INVOICING AND FOR BOOKKEEPING PURPOSES, FREQUENCY INVERTERS FOR CHANGING ALTERNATING CURRENT INTO

CLASS 9—(Continued).

DIRECT CURRENT AND FOR CHANGING THE FREQUENCY OF ALTERNATING CURRENTS, IONIZATION APPARATUS, NAMELY IONIZERS FOR APPLYING AND ELECTRIC CHARGE TO MATERIALS SUCH AS PAPER FOR USE IN CONNECTION WITH AUTOMATED HANDLING SYSTEMS FOR PRINTED PRODUCTS, LIGHT BARRIERS, NAMELY LIGHT CURTAINS, REFLEX LIGHT BARRIERS, V-LIGHT BARRIERS AND AUTO-COLLIMATION LIGHT BARRIERS, ELECTRIC EMERGENCY STOP SWITCHES, SWITCHBOARDS, CONTROL CABINETS CONTAINING COMPUTER HARDWARE AND SOFTWARE FOR CONTROLLING MACHINERY, NAMELY AUTOMATED HANDLING SYSTEMS FOR PRINTED PRODUCTS, PRODUCTION PLANT, PRODUCTION LINES, AUTOMATED HANDLING EQUIPMENT AND AUTOMATIC HANDLING SYSTEMS, COUNTERS, IN PARTICULAR LASER COUNTERS AND ALSO THEIR PARTS, NAMELY LASER DIODES, GAS LASERS, SOLID-STATE LASERS AND RUBY LASERS (U.S. CLS. 21, 23, 26, 36 AND 38).

FIRST USE 0-0-1978; IN COMMERCE 0-0-1989.

SN 75-408,850. SATIT SA, 33610 CESTAS, FRANCE, FILED 12-22-1997.

COM
one

FOR TELECOMMUNICATIONS EQUIPMENT, NAMELY, MODEMS FOR THE TRANSMISSION OF VOICE, DATA AND IMAGE INFORMATION IN DIGITAL AND ANALOG FORM (U.S. CLS. 21, 23, 26, 36 AND 38).

FIRST USE 12-1-1986; IN COMMERCE 12-1-1986.

SN 75-431,807. REGENTS OF THE UNIVERSITY OF CALIFORNIA, THE, OAKLAND, CA. FILED 2-10-1998.

**THESAURUS LINGVAE
GRAECAE**

NO CLAIM IS MADE TO THE EXCLUSIVE RIGHT TO USE "LINGVAE GRAECAE", APART FROM THE MARK AS SHOWN.

FOR MAGNETIC COMPUTER TAPE AND MULTIMEDIA SOFTWARE RECORDED ON CD-ROM CONTAINING A DIGITIZED COLLECTION OF ANCIENT GREEK LITERATURE (U.S. CLS. 21, 23, 26, 36 AND 38).

FIRST USE 9-6-1974; IN COMMERCE 9-6-1974.

CLASS 9—(Continued).

SN 75-451,749. DUBOIS, CRAIG R., AUSTIN, TX. FILED 3-17-1998.

POWERGLIDER

FOR COMPUTER ACCESSORIES, NAMELY WRIST, FOREARM AND ELBOW SUPPORTING KEYBOARD APPARATUS (U.S. CLS. 21, 23, 26, 36 AND 38).
FIRST USE 1-9-1996; IN COMMERCE 1-9-1996.

SN 75-456,897. INTERMEC TECHNOLOGIES CORPORATION, EVERETT, WA. FILED 3-26-1998.

UBI

OWNER OF U.S. REG. NO. 1,798,536.
FOR AUTOMATED DATA COLLECTION DEVICES, NAMELY, PRINTERS, BAR CODE AND/OR ONE AND TWO DIMENSIONAL SYMBOLOGY READERS, MAGNETIC CARD READERS, DATA COLLECTION TERMINALS; BAR CODE SCANNERS AND IMAGERS; RF (RADIO FREQUENCY) ID (IDENTIFICATION) TAGS AND READER INTERROGATORS, RF(RADIO FREQUENCY) WIRELESS AND WIRED NETWORKING MODULES AND PARTS THEREFOR (U.S. CLS. 21, 23, 26, 36 AND 38).

SN 75-498,371. NTA ELECTRONIC SALES GUIDES, INC., LONGWOOD, FL. FILED 6-8-1998.

ESG - ELECTRONIC SALES GUIDE

NO CLAIM IS MADE TO THE EXCLUSIVE RIGHT TO USE "ELECTRONIC SALES GUIDE", APART FROM THE MARK AS SHOWN.

FOR COMPUTER SOFTWARE FOR GRAPHIC PRESENTATION OF SALES MATERIALS ON A COMPUTER SCREEN (U.S. CLS. 21, 23, 26, 36 AND 38).
FIRST USE 11-22-1991; IN COMMERCE 11-22-1991.

SN 75-505,596. NETVENDOR SYSTEMS, INC., ATLANTA, GA. FILED 6-19-1998.

NETVENDOR

SEC. 2(F).
FOR COMPUTER SOFTWARE WHICH ALLOWS BUSINESSES TO STREAMLINE COMMUNICATIONS WITH THEIR CUSTOMERS, NAMELY BY ENABLING DISTRIBUTORS AND MANUFACTURERS TO CONDUCT BUSINESS-TO-BUSINESS TRANSACTIONS VIA THE GLOBAL COMPUTER NETWORK (U.S. CLS. 21, 23, 26 AND 38).
FIRST USE 2-1-1996; IN COMMERCE 2-1-1996.

CLASS 9—(Continued).

SN 75-512,392. PAYNET COMMUNICATIONS, INC., BRYAN, TX. FILED 7-2-1998.

PAYNET

FOR COMPUTER HARDWARE ADAPTED TO GIVE USERS ACCESS TO E-MAIL AND THE GLOBAL COMPUTER COMMUNICATIONS NETWORK AND TO PROVIDE THE ABILITY TO PERFORM WORD PROCESSING, GRAPHICS, SPREAD SHEETS, AND FINANCIAL FUNCTIONS (U.S. CLS. 21, 23, 26, 36 AND 38).
FIRST USE 4-15-1997; IN COMMERCE 4-15-1997.

SN 75-520,802. INFORMATION PRESENTATION TECHNOLOGIES, INC., SAN LUIS OBISPO, CA. FILED 7-17-1998.

COLORTOUCH

FOR PRINTING PROCESS COMPONENTS, NAMELY, COMPUTER SERVER-BASED COLOR MANAGEMENT SOFTWARE FOR USE IN THE DESIGN, PRINTING, AND PREPRESS GRAPHICS WORKFLOW, NAMELY, SOFTWARE FOR USE IN CONVERTING COLOR BETWEEN DIFFERENT COLOR SPACES AND GAMUTS WHILE MAINTAINING COLOR FIDELITY, CORRECTING COLOR IN VECTOR GRAPHICS AND BITMAP GRAPHICS, AND OPTIMIZING CONTRAST AND BALANCE BETWEEN COLORS ACROSS PRINTING DEVICES (U.S. CLS. 21, 23, 26, 36 AND 38).
FIRST USE 9-1-1997; IN COMMERCE 9-1-1997.

SN 75-566,128. MICROSTRATEGY INCORPORATED, VIENNA, VA. FILED 10-6-1998.

DSS SUBSCRIBER

FOR COMPUTER PROGRAMS FOR USE IN PUBLISHING AND CREATING CUSTOMIZED FORMS IN A WIDE VARIETY OF FIELDS (U.S. CLS. 21, 23, 26, 36 AND 38).

SN 75-595,064. DCARD, INC., MILPITAS, CA. FILED 11-23-1998.

DCARD

FOR MICROCOMPUTERS, MICRO-CONTROLLERS; COMPUTER HARDWARE AND SOFTWARE FOR THE TRANSMISSION AND RECEIPT OF FACSIMILES, FOR THE DEVELOPMENT, MAINTENANCE, AND USE OF LOCAL AND WIDE AREA COMPUTER WIRE AND WIRELESS NETWORKS, FOR THE DEVELOPMENT, MAINTENANCE, AND USE OF INTERACTIVE AUDIO-VIDEO COMPUTER CONFERENCE SYSTEMS, AND FOR THE DEVELOPMENT, MAINTENANCE AND USE OF BROADCAST VIDEO, AUDIO, AND DIGITAL DATA SIGNALS; COMPUTER OPERATING SYSTEM SOFTWARE, COMPUTER OPERATING PROGRAMS, COMPUTER FIRMWARE FOR USE IN NETWORK DATA TRANSMISSION, CONTROLLING SYSTEM OPERATION OF DATA-HANDLING SYSTEMS AND FOR EXECUTING DIGITAL INSTRUCTIONS; COMPUTER HARDWARE; COMPUTER PERIPHERALS; INTEGRATED CIRCUITS; INTEGRATED CIRCUIT CHIPS; SEMICON-

CLASS 9—(Continued).

DUCTOR PROCESSORS; SEMICONDUCTOR PROCESSOR CHIPS; MICROPROCESSORS; PRINTED CIRCUIT BOARDS; ELECTRONIC CIRCUIT BOARDS; AUDIO CIRCUIT BOARDS; AUDIO-VIDEO CIRCUIT BOARDS; VIDEO GRAPHIC ACCELERATORS; MULTIMEDIA ACCELERATORS; VIDEO PROCESSORS; FAX/MODEMS; COMPUTER SYSTEM COMPRISING COMPUTER HARDWARE, COMPUTER SOFTWARE TO FUNCTION AS DEVICE DRIVERS, MANAGE COMMUNICATION INTERFACE, AND DATA TRANSMISSION BETWEEN DIFFERENT DATA STORAGE DEVICE AND PROCESSORS, FIRMWARE EXTENSIONS, COMPUTER UTILITY SOFTWARE AND APPLICATION SOFTWARE FOR DATABASE MANAGEMENT, INFORMATION PRESENTATION, AND USER INTERFACE MANAGEMENT, FOR CONNECTING PERSONAL COMPUTERS AND NETWORKS; TELECOMMUNICATIONS APPARATUS AND GLOBAL COMPUTER NETWORK APPLICATIONS; AUDIO AND VIDEO GRAPHICS EMBODIED IN MEMORY CARDS FOR REAL TIME INFORMATION AND IMAGE TRANSFER, TRANSMISSION, RECEPTION, PROCESSING, AND DIGITIZING (U.S. CLS. 21, 23, 26, 36 AND 38).

SN 75-597,206. AMB IT HOLDING B.V., 2105 MB HEEMSTEDDE, NETHERLANDS, FILED 11-30-1998.

TranX

FOR ELECTRONIC TRANSMITTERS, RECEIVERS, TIMERS AND COMPUTER CHIPS FOR USE IN REGISTRATION, IDENTIFICATION AND TIMING OF PARTICIPANTS IN AUTOMOBILE RACES, BICYCLE RACES, HORSE RACES AND OTHER TYPES OF RACING EVENTS; COMPUTER HARDWARE AND SOFTWARE FOR REGISTRATION, IDENTIFICATION AND TIMING OF PARTICIPANTS IN RACING EVENTS AND PROCESSING DATA TO PROVIDE PERFORMANCE INFORMATION (U.S. CLS. 21, 23, 26, 36 AND 38).

SN 75-619,171. NIQ, INC., ANN ARBOR, MI. FILED 1-15-1999.

EZIO

FOR COMPUTER HARDWARE FOR INTERACTIVELY CONTROLLING COMPUTER EXTERNAL DEVICES (U.S. CLS. 21, 23, 26, 36 AND 38).
FIRST USE 1-5-1998; IN COMMERCE 1-5-1998.

CLASS 9—(Continued).

SN 75-636,954. INFORMIX SOFTWARE, INC., MENLO PARK, CA. FILED 2-9-1999.

I.MASTER

FOR COMPUTER PROGRAMS, NAMELY, DATABASE DEVELOPMENT TOOLS THAT PROVIDE SOLUTIONS FOR ELECTRONIC COMMERCE OVER A GLOBAL COMPUTER INFORMATION AND COMMUNICATIONS NETWORK; AND OVER A CORPORATE COMPUTER INFORMATION AND COMMUNICATIONS NETWORK FOR GENERAL USE (U.S. CLS. 21, 23, 26, 36 AND 38).

SN 75-637,374. CHIPS AND BITS SOFTWARE, INC., TARZANA, CA. FILED 10-30-1999.



FOR COMPUTER SOFTWARE FOR PROVIDING A CUSTOMIZED INTERFACE THAT ACCEPTS AND STORES DAILY FEEDS OF RAW DATA, THEN EXTRACTS AND COMBINES THE INFORMATION FOR REPORTS AND PAYMENTS WHICH OFFERS A COMPREHENSIVE PACKAGE OF ON-LINE AND PRINTED REPORTS, FOR THE USE AND AID IN PARI MUTUEL RACE TRACK BUSINESS OPERATIONS INCLUDING THE VARIOUS DEPARTMENTS AND LEVELS OF TRACK MANAGEMENT, SUCH AS MUTUELS, ACCOUNTING, MARKETING AND OPERATIONS (U.S. CLS. 21, 23, 26, 36 AND 38).

FIRST USE 4-27-1995; IN COMMERCE 5-3-1995.

SN 75-654,674. LEARNINGBYTE INTERNATIONAL, INC., MINNEAPOLIS, MN. FILED 3-5-1999.

CLASS OF ONE

FOR PRE-RECORDED CD-ROMS FEATURING CUSTOMIZABLE SOFTWARE THAT ENABLES EMPLOYERS IN THE FIELDS OF AIRLINES, SHIPPING, ASSOCIATIONS, AUTOMOTIVE, EDUCATION, FINANCIAL, GOVERNMENT, HEALTH CARE, INDUSTRIAL EQUIPMENT AND MANUFACTURING, E-COMMERCE, RETAIL AND FOOD SERVICE, TECHNOLOGY, TELECOMMUNICATIONS, TRAINING, HUMAN RESOURCES, MEDIA, AND TRAVEL TO TRAIN EMPLOYEES IN A WIDE VARIETY OF JOB PERFORMANCES COMPETENCIES (U.S. CLS. 21, 23, 26, 36 AND 38).

FIRST USE 2-0-1997; IN COMMERCE 2-0-1997.

CLASS 9—(Continued).

SN 75-661,300. DCARD, INC., MILPITAS, CA. FILED 3-16-1999.



THE MARK CONSISTS OF THE STYLIZED LETTER "D" WITHIN A CIRCLE.

FOR MICROCOMPUTERS, MICRO-CONTROLLERS; COMPUTER HARDWARE AND SOFTWARE FOR THE TRANSMISSION AND RECEIPT OF FACSIMILES, FOR THE DEVELOPMENT, MAINTENANCE, AND USE OF LOCAL AND WIDE AREA COMPUTER WIRE AND WIRELESS NETWORKS, FOR THE DEVELOPMENT, MAINTENANCE, AND USE OF INTERACTIVE AUDIO-VIDEO COMPUTER CONFERENCE SYSTEMS, AND FOR THE DEVELOPMENT, MAINTENANCE AND USE OF BROADCAST VIDEO, AUDIO, AND DIGITAL DATA SIGNALS; COMPUTER OPERATING SYSTEM SOFTWARE, COMPUTER OPERATING PROGRAMS, COMPUTER FIRMWARE FOR USE IN NETWORK DATA TRANSMISSION, CONTROLLING SYSTEM OPERATION OF DATA-HANDLING SYSTEMS AND FOR EXECUTING DIGITAL INSTRUCTIONS; COMPUTER HARDWARE; COMPUTER PERIPHERALS; INTEGRATED CIRCUITS; INTEGRATED CIRCUIT CHIPS; SEMICONDUCTOR PROCESSORS; SEMICONDUCTOR PROCESSOR CHIPS; MICROPROCESSORS; PRINTED CIRCUIT BOARDS; ELECTRONIC CIRCUIT BOARDS; AUDIO CIRCUIT BOARDS; AUDIO-VIDEO CIRCUIT BOARDS; VIDEO GRAPHIC ACCELERATORS; MULTIMEDIA ACCELERATORS; VIDEO PROCESSORS; FAX/MODEMS; COMPUTER SYSTEM COMPRISING COMPUTER HARDWARE, COMPUTER SOFTWARE TO FUNCTION AS DEVICE DRIVERS, MANAGE COMMUNICATION INTERFACE, AND DATA TRANSMISSION BETWEEN DIFFERENT DATA STORAGE DEVICE AND PROCESSORS, FIRMWARE EXTENSIONS, COMPUTER UTILITY SOFTWARE AND APPLICATION SOFTWARE FOR DATABASE MANAGEMENT, INFORMATION PRESENTATION, AND USER INTERFACE MANAGEMENT, FOR CONNECTING PERSONAL COMPUTERS AND NETWORKS; TELECOMMUNICATIONS APPARATUS AND GLOBAL COMPUTER NETWORK APPLICATIONS; AUDIO AND VIDEO GRAPHICS EMBODIED IN MEMORY CARDS FOR REAL TIME INFORMATION AND IMAGE TRANSFER, TRANSMISSION, RECEPTION, PROCESSING, AND DIGITIZING (U.S. CLS. 21, 23, 26, 36 AND 38).

CLASS 9—(Continued).

SN 75-674,472. FOR-A COMPANY LIMITED, TOKYO, JAPAN, FILED 4-5-1999.



NO CLAIM IS MADE TO THE EXCLUSIVE RIGHT TO USE "HD", APART FROM THE MARK AS SHOWN.

FOR COMPUTERIZED AND OTHER ELECTRONIC AUDIO/VIDEO APPARATUS; NAMELY TIME BASE CORRECTORS, VIDEO TYPEWRITERS, CHARACTER GENERATORS, VIDEO EFFECTS PROCESSORS, TIME CODE GENERATORS AND READERS, TELEVISION SIGNAL ENCODERS AND DECODERS, VIDEO SWITCHERS/SWITCHES, AUDIO MIXERS, VIDEO EDIT CONTROLLERS, SIGNAL TRANSCODERS, VIDEO TIMERS, VIDEO MICRO SCALERS, CROSSLINE GENERATORS, VIDEO POINTERS, AND VIDEO MEASURING GAUGES (U.S. CLS. 21, 23, 26, 36 AND 38).

SN 75-687,561. ARISTOCRAT LEISURE INDUSTRIES PTY LTD, NEW SOUTH WALES, AUSTRALIA, FILED 4-21-1999.

BUZZARD BUCKS

OWNER OF AUSTRALIA REG. NO. 783865, DATED 1-25-1999, EXPIRES 1-25-2009.

NO CLAIM IS MADE TO THE EXCLUSIVE RIGHT TO USE "BUCKS", APART FROM THE MARK AS SHOWN.

FOR MACHINES FOR PLAYING GAMES OF CHANCE (U.S. CLS. 21, 23, 26, 36 AND 38).

SN 75-722,038. FUTURESOURCE/BRIDGE L.L.C., LOMBARD, IL. FILED 6-4-1999.

PROFESSIONAL

FOR COMPUTER SOFTWARE THAT ALLOWS A STOCK TRADER TO RECEIVE REAL TIME DATA ABOUT FINANCIAL MARKETS FROM OTHER REAL TIME DATA STREAMS, NAMELY, MAJOR U.S. AND FOREIGN COMMODITY AND STOCK EXCHANGES (U.S. CLS. 21, 23, 26, 36 AND 38).

CLASS 9—(Continued).

SN 75-724,717. AT&T CORP., NEW YORK, NY. FILED 6-9-1999.

LIGHTWIRE

FOR FIBER OPTIC CABLE; FIBER OPTIC NODES AND SWITCHES TO TRANSMIT, RECEIVE AND DISTRIBUTE VOICE, DATA, VIDEO AND FACSIMILE COMMUNICATIONS; FIBER OPTIC SIGNAL AMPLIFIERS; FIBER OPTIC SWITCHES WHICH CONVERT ANALOG CO-AXIAL SIGNALS TO DIGITAL FIBER OPTICAL SIGNALS AND WHICH ALSO CONVERT FIBER OPTICAL SIGNALS TO ANALOG CO-AXIAL SIGNALS (U.S. CLS. 21, 23, 26, 36 AND 38).

SN 75-733,816. ADVANCED PRODUCTION SYSTEMS, INC., LOUISVILLE, KY. FILED 6-18-1999.

SORT IT!

FOR MATERIAL HANDLING AND MANAGEMENT CONTROL SYSTEMS, NAMELY SOFTWARE AND ELECTRONIC DETECTION UNITS USED FOR HANDLING OF MATERIALS AND TRACKING OF DATA ASSOCIATED THEREWITH (U.S. CLS. 21, 23, 26, 36 AND 38).

SN 75-748,567. DATACOM TECHNOLOGIES, INC., CHICAGO, WA. FILED 7-8-1999.

DATACOM

OWNER OF U.S. REG. NO. 1,506,942.
FOR ELECTRONIC AND OPTICAL TESTING EQUIPMENT FOR USE IN INSTALLING, TESTING, MAINTAINING, MANAGING, CERTIFYING AND VERIFICATION TESTING OF CONDUCTIVE AND FIBER OPTIC CABLE NETWORKS FOR COMPUTERS, PERIPHERY AN OFFSITE CONNECTIONS (U.S. CLS. 21, 23, 26, 36 AND 38).
FIRST USE 11-0-1997; IN COMMERCE 2-0-1998.

SN 75-751,971. YAMAGIWA LONGSALT INTERNATIONAL CORPORATION, CHIYODA-KU, TOKYO, JAPAN, FILED 7-13-1999.

MR. PRIVACY

FOR COMPUTER SOFTWARE, NAMELY, CONFIDENTIALITY PROTECTION SOFTWARE FOR DOCUMENTS (U.S. CLS. 21, 23, 26, 36 AND 38).

CLASS 9—(Continued).

SN 75-766,738. DATAPLAY, INC., BOULDER, CO. BY CHANGE OF NAME SPINVISION, INC., BOULDER, CO. FILED 8-2-1999.

CONTENTKEY

FOR COMPUTER SOFTWARE FEATURING DECRYPTION CODES THAT ALLOWS USERS TO ACCESS SECURED DATA FROM STORAGE MEDIA (U.S. CLS. 21, 23, 26, 36 AND 38).

SN 75-768,907. VERTIGO MULTIMEDIA, INC., MONTREAL, QUEBEC, CANADA, BY ASSIGNMENT VERTIGO COMPUTER SOLUTIONS, INC., MONTREAL, QUEBEC, CANADA, FILED 8-5-1999.

PRODUCER ON AIR

FOR COMPUTER SOFTWARE FOR GRAPHICS APPLICATIONS (U.S. CLS. 21, 23, 26, 36 AND 38).

SN 75-779,912. EMERY, EDMUND H., EUGENE, OR. AND EMERY, LYNDIA L., EUGENE, OR. FILED 8-20-1999.

*CARE SYSTEMS
Manager*

NO CLAIM IS MADE TO THE EXCLUSIVE RIGHT TO USE "MANAGER", APART FROM THE MARK AS SHOWN.
FOR HEALTH PROFESSIONAL COMPUTER SOFTWARE FOR CLIENT/PATIENT CARE TRACKING AND BILLING (U.S. CLS. 21, 23, 26, 36 AND 38).

SN 75-787,680. ZYMARK CORPORATION, HOPKINTON, MA. FILED 8-30-1999.

Zymark

OWNER OF U.S. REG. NOS. 1,223,170, 1,234,421 AND 1,249,359.

FOR LABORATORY EQUIPMENT, NAMELY, ROBOT MANIPULATORS, LABORATORY CONSUMABLE DISPENSERS, LABORATORY SAMPLE CONDITIONERS, NAMELY, INCUBATORS, STIRRERS, MIXERS, DISPENSERS, AND ASPIRATORS; AND LABORATORY MEASUREMENT DEVICES FOR MEASURING CHARACTERISTICS INCLUDING ABSORBENCY, WEIGHT AND VOLUME OF PHARMACEUTICAL SAMPLES (U.S. CLS. 21, 23, 26, 36 AND 38).
FIRST USE 1-0-1998; IN COMMERCE 1-0-1998.

CLASS 9—(Continued).

SN 75-791,790. E-SIM LTD., JERUSALEM 91450, ISRAEL, FILED 9-2-1999.

LIVEMANUALS

FOR COMPUTER SOFTWARE FOR USE IN THE DESIGN, DEVELOPMENT, PROTOTYPING, PROMOTION AND PROVIDING INFORMATION FOR A WIDE VARIETY OF PRODUCTS AND SYSTEMS; COMPUTER SOFTWARE FOR USE IN CREATING PRODUCTS AND SYSTEMS; COMPUTER SOFTWARE FOR USE IN CREATING PRODUCT AND PROTOTYPE DEMONSTRATION APPLICATIONS; COMPUTER SOFTWARE FOR USE IN DEVELOPING INTERACTIVE CONTENT FOR LOCAL AREA NETWORKS, WEB SITES, AND GLOBAL COMPUTER NETWORKS; COMPUTER SOFTWARE FOR CREATING ELECTRONIC USER MANUALS; COMPUTER SOFTWARE ALLOWING TO PERFORM NATURAL LANGUAGE QUERIES; USER MANUAL SUPPLIED AS A UNIT WITH THE FOREGOING (U.S. CLS. 21, 23, 26, 36 AND 38).

SN 75-791,792. E-SIM LTD., JERUSALEM 91450, ISRAEL, FILED 9-2-1999.

LIVEPRODUCTS

FOR COMPUTER SOFTWARE FOR USE IN THE DESIGN, DEVELOPMENT, PROTOTYPING, PROMOTION AND PROVIDING INFORMATION FOR A WIDE VARIETY OF PRODUCTS AND SYSTEMS; COMPUTER SOFTWARE FOR USE IN CREATING PRODUCTS AND SYSTEMS; COMPUTER SOFTWARE FOR USE IN CREATING PRODUCT AND PROTOTYPE DEMONSTRATION APPLICATIONS; COMPUTER SOFTWARE FOR USE IN DEVELOPING INTERACTIVE CONTENT FOR LOCAL AREA NETWORKS, WEB SITES, AND GLOBAL COMPUTER NETWORKS; COMPUTER SOFTWARE FOR CREATING ELECTRONIC USER MANUALS; COMPUTER SOFTWARE ALLOWING TO PERFORM NATURAL LANGUAGE QUERIES; USER MANUAL SUPPLIED AS A UNIT WITH THE FOREGOING (U.S. CLS. 21, 23, 26, 36 AND 38).

SN 75-803,654. KREUTER MANUFACTURING CO., INC., NEW PARIS, IN. BY ASSIGNMENT RELIABLE COMPUTER SYSTEMS LTD., VICTORIA, B.C., CANADA, FILED 9-20-1999.



THE MARK CONSISTS OF THE WORD "MULTINET" AND A DESIGN IN THE SHAPE OF THE LETTER "M".

FOR ELECTRONIC DIGITAL CONTROLLERS FOR USE IN CONTROLLING BUILDING TEMPERATURES (U.S. CLS. 21, 23, 26, 36 AND 38).

FIRST USE 10-15-1994; IN COMMERCE 10-15-1994.

CLASS 9—(Continued).

SN 75-806,019. CASTLEWOOD SYSTEMS, INC., PLEASANTON, CA. FILED 9-22-1999.

E.CASTLE

FOR COMPUTER DISC DRIVES (U.S. CLS. 21, 23, 26, 36 AND 38).

SN 75-810,958. A.N.N. SYSTEMS ASA, OSLO, NORWAY, FILED 9-29-1999.

A.N.N.

FOR COMPUTER SOFTWARE FOR AUTOMATION OF TELEVISION, RADIO AND INTERNET NEWSROOMS, NEWS PRODUCTION, DELIVERY AND BROADCASTING, NAMELY, SOFTWARE FOR SYNCHRONIZING SCRIPTS, TELEPROMPTERS, GRAPHICS, VIDEO AND NEWS BROADCAST RUNDOWNS (U.S. CLS. 21, 23, 26, 36 AND 38).

SN 75-813,941. SUNBURST PRODUCTS, INC., DBA THE FREESTYLE GROUP, CAMARILLO, CA. FILED 10-5-1999.

FREESTYLE

FOR SUNGLASSES (U.S. CLS. 21, 23, 26, 36 AND 38). FIRST USE 8-25-1999; IN COMMERCE 8-25-1999.

SN 75-814,859. SYSTEK INFORMATION TECHNOLOGY LIMITED, WANCHAI, HONG KONG, FILED 10-5-1999.

EZCONNECT

FOR COMPUTER SOFTWARE FOR INTERNET CUSTOMER CARE AND INTERNET CUSTOMER SERVICE, NAMELY, SOFTWARE THAT ALLOWS MULTIPLE USERS TO COMMUNICATE USING TEXT CHAT, VOICE CHAT, DOCUMENT AND APPLICATION SHARING AND WHITEBOARDING (U.S. CLS. 21, 23, 26, 36 AND 38).

SN 75-820,327. PURCELLA, MONTY, LAKEWOOD, CO. AND PURCELLA, DEBBIE, LAKEWOOD, CO. FILED 11-1-1999.

TRAFFIC GRAPHICS

SEC. 2(F).
FOR COMPUTER SOFTWARE FOR DESIGNING DRAWINGS FOR USE IN THE TRAFFIC SAFETY INDUSTRY (U.S. CLS. 21, 23, 26, 36 AND 38).

FIRST USE 6-1-1995; IN COMMERCE 12-20-1995.

CLASS 9—(Continued).

SN 75-825,675. SHELL OIL COMPANY, HOUSTON, TX. FILED 10-18-1999.

MMS TASKMASTER

NO CLAIM IS MADE TO THE EXCLUSIVE RIGHT TO USE "MMS", APART FROM THE MARK AS SHOWN. FOR COMPUTER SOFTWARE THAT ALLOWS FOR SCHEDULING AND TRACKING OF OPERATIONS AND ENGINEERING TASKS IN THE MANUFACTURING INDUSTRY (U.S. CLS. 21, 23, 26, 36 AND 38).

CLASS 9—(Continued).

SN 75-851,170. WELDON TECHNOLOGIES, INC., COLUMBUS, OH. FILED 11-17-1999.

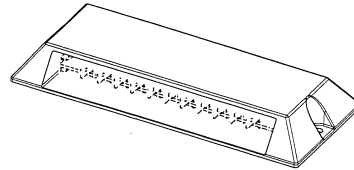

SN 75-826,510. STMICROELECTRONICS, INC., CARROLLTON, TX. FILED 10-18-1999.

PERFECTPRINT

FOR INTEGRATED CIRCUITS, ELECTRONIC CIRCUITRY AND ELECTRONIC ASSEMBLIES USED FOR FINGERPRINT INFORMATION EXTRACTION AND FINGERPRINT INFORMATION PROCESSING; AND FINGERPRINT AND IMAGE PROCESSING SOFTWARE (U.S. CLS. 21, 23, 26, 36 AND 38).

THE MARK CONSISTS OF THE CONFIGURATION OF A RECTANGULAR CONTAINER HAVING INWARDLY SLOPING SIDES WITH A PORT ON ONE SIDE FROM WHICH A SERIES OF ELECTRICAL CONNECTORS ARE VISIBLE. THE CONFIGURATION OF THE ELECTRICAL CONNECTORS, AS REPRESENTED BY DASHED LINES, IS NOT CLAIMED AS A FEATURE OF THE MARK. THE MARK IS YELLOW EXCEPT FOR THE ELECTRICAL CONNECTORS VISIBLE WITHIN THE PORT.

SEC. 2(F).
FOR ELECTRONIC CONTROLLER FOR SEQUENCING SCHOOL BUS LIGHTS AND STOP ARM (U.S. CLS. 21, 23, 26, 36 AND 38).
FIRST USE 6-0-1988; IN COMMERCE 6-0-1988.

SN 75-826,667. RAILROAD CONTROLS, L.L.C., FORT WORTH, TX. FILED 10-19-1999.

RAILROAD CONTROLS LIMITED

NO CLAIM IS MADE TO THE EXCLUSIVE RIGHT TO USE "LIMITED", APART FROM THE MARK AS SHOWN. SEC. 2(F).
FOR ELECTRONIC RAILROAD SAFETY SIGNALS, NAMELY ACTIVE WARNING SYSTEMS FOR RAILROAD GRADE CROSSINGS FOR WARNING AND COMMUNICATING TO VEHICULAR TRAFFIC AND PEDESTRIANS THE PRESENCE OF ONCOMING TRAINS COMPRISING OF AUDIBLE SIGNALS, VISUAL SIGNALS, TRAIN CREW NOTIFICATION SIGNALS, AND VITAL DETECTION UNITS WITH DIGITAL INPUT AND OUTPUT DISPLAYS (U.S. CLS. 21, 23, 26, 36 AND 38).
FIRST USE 6-0-1994; IN COMMERCE 6-0-1994.

SN 75-854,239. COMDIAL CORPORATION, CHARLOTTESVILLE, VA. FILED 11-19-1999.

FXS

FOR COMPUTER SOFTWARE AND COMPUTER HARDWARE FOR CONTROLLING MULTI-LINE TELEPHONE SYSTEMS (U.S. CLS. 21, 23, 26, 36 AND 38).

CLASS 9—(Continued).

SN 75-858,777. PICARD TECHNOLOGIES INC., MONTREAL, QUEBEC, CANADA, FILED 11-29-1999.



NO CLAIM IS MADE TO THE EXCLUSIVE RIGHT TO USE "REGULATORY INFORMATION MANAGEMENT SYSTEM", APART FROM THE MARK AS SHOWN.

FOR SOFTWARE FOR QUALITY ASSURANCE AND CONTROL, NAMELY DOCUMENT MANAGEMENT, DOCUMENT HISTORY TRACKING AND DOCUMENT CHANGE CONTROL, FOR TRACKING DOCUMENTS, EQUIPMENT AND PROCESSES IN PRODUCTION FACILITIES RELATED TO AVIATION, PHARMACEUTICAL, FOOD, AND MANUFACTURING; SOFTWARE WHICH CONTROLS, MONITORS AND TRACKS AUTOMATED PRODUCTION OF AVIATION, PHARMACEUTICAL, AND FOOD PRODUCTS; SOFTWARE FOR USE IN PROJECT MANAGEMENT FOR AVIATION, PHARMACEUTICAL, FOOD AND MANUFACTURING AND PROCESS FACILITIES, NAMELY SOFTWARE FOR STORING, ORGANIZING AND REPORTING ON INFORMATION RELATED TO PHYSICAL ORGANIZATION OF SAID FACILITIES, PRODUCTION RECORDS, PRODUCTION EQUIPMENT CALIBRATION, REPAIR AND MAINTENANCE RECORDS, AND MONITORING AND PROJECTING COSTS OF PRODUCTION; SOFTWARE FOR TRAINING INDIVIDUALS TO USE THE ABOVE SOFTWARE, AND FOR REPORTING PROGRESS OF TRAINING OF SUCH INDIVIDUALS; SOFTWARE FOR MACHINE VISION SYSTEMS, TO CONTROL MEASUREMENT AND INSPECTION FOR QUALITY CONTROL PURPOSES ON AN ASSEMBLY LINE IN PRODUCTION FACILITIES; SOFTWARE FOR SORTING COSMETICS BY COLOUR AND FOR ASSEMBLY VERIFICATION (U.S. CLS. 21, 23, 26, 36 AND 38).

CLASS 9—(Continued).

SN 75-858,779. PICARD TECHNOLOGIES INC., MONTREAL, QUEBEC, CANADA, FILED 11-29-1999.

PICARD TECHNOLOGIES INC.

NO CLAIM IS MADE TO THE EXCLUSIVE RIGHT TO USE "TECHNOLOGIES INC.", APART FROM THE MARK AS SHOWN.

FOR SOFTWARE FOR QUALITY ASSURANCE AND CONTROL, NAMELY DOCUMENT MANAGEMENT, DOCUMENT HISTORY TRACKING AND DOCUMENT CHANGE CONTROL, FOR TRACKING DOCUMENTS, EQUIPMENT AND PROCESSES IN PRODUCTION FACILITIES RELATED TO AVIATION, PHARMACEUTICAL, FOOD, AND MANUFACTURING; SOFTWARE WHICH CONTROLS, MONITORS AND TRACKS AUTOMATED PRODUCTION OF AVIATION, PHARMACEUTICAL, AND FOOD PRODUCTS; SOFTWARE FOR USE IN PROJECT MANAGEMENT FOR AVIATION, PHARMACEUTICAL, FOOD AND MANUFACTURING AND PROCESS FACILITIES, NAMELY SOFTWARE FOR STORING, ORGANIZING AND REPORTING ON INFORMATION RELATED TO PHYSICAL ORGANIZATION OF SAID FACILITIES, PRODUCTION RECORDS, PRODUCTION EQUIPMENT CALIBRATION, REPAIR AND MAINTENANCE RECORDS, AND MONITORING AND PROJECTING COSTS OF PRODUCTION; SOFTWARE FOR TRAINING INDIVIDUALS TO USE THE ABOVE SOFTWARE, AND FOR REPORTING PROGRESS OF TRAINING OF SUCH INDIVIDUALS; SOFTWARE FOR MACHINE VISION SYSTEMS, TO CONTROL MEASUREMENT AND INSPECTION FOR QUALITY CONTROL PURPOSES ON AN ASSEMBLY LINE IN PRODUCTION FACILITIES; SOFTWARE FOR SORTING COSMETICS BY COLOUR AND FOR ASSEMBLY VERIFICATION (U.S. CLS. 21, 23, 26, 36 AND 38).

SN 75-862,031. TALLY DISPLAY CORPORATION, SO. NYACK, NY. FILED 12-1-1999.

VNMP

FOR COMPUTER HARDWARE AND COMPUTER SOFTWARE USED TO SUPPORT COMMUNICATION PROTOCOLS USED IN NETWORKING APPLICATIONS (U.S. CLS. 21, 23, 26, 36 AND 38).

SN 75-865,451. DYNADOX, INC., CLEMSON, SC. FILED 12-20-1999.

DYNADOX

FOR COMPUTER SOFTWARE FOR CREATING AND FORMATTING DOCUMENTS (U.S. CLS. 21, 23, 26, 36 AND 38).

FIRST USE 10-1-1996; IN COMMERCE 10-1-1996.

CLASS 9—(Continued).

SN 75-868,855. ARISTOCRAT LEISURE INDUSTRIES PTY LTD, NEW SOUTH WALES, AUSTRALIA, FILED 12-10-1999.

GREEN LIZARD

PRIORITY CLAIMED UNDER SEC. 44(D) ON AUSTRALIA APPLICATION NO. 808029, FILED 9-23-1999, REG. NO. 808029, DATED 9-23-1999, EXPIRES 9-23-2009.

FOR MACHINES FOR PLAYING GAMES OF CHANCE (U.S. CLS. 21, 23, 26, 36 AND 38).

CLASS 9—(Continued).

SN 75-880,475. WHIPPLE, DAVID RAY, OWASSO, OK. FILED 1-5-2000.

ALWAYSBACKUP

FOR COMPUTER SOFTWARE FOR BACKING-UP FILES AND DATA IN COMPUTER SYSTEMS (U.S. CLS. 21, 23, 26, 36 AND 38).

SN 75-873,284. COMPOZE SOFTWARE, INC., WEST CHESTER, PA. FILED 12-16-1999.

COMPOZE SOFTWARE

NO CLAIM IS MADE TO THE EXCLUSIVE RIGHT TO USE "SOFTWARE", APART FROM THE MARK AS SHOWN.

FOR COMPUTER SOFTWARE DEVELOPMENT TOOLS, NAMELY, JAVA-BASED COMPONENTS FOR THE DEVELOPMENT OF ENTERPRISE APPLICATIONS AND E-COMMERCE WEB SITES (U.S. CLS. 21, 23, 26, 36 AND 38).

SN 75-874,580. I-SITE, INC., PHILADELPHIA, PA. FILED 12-14-1999.

AARDMARK

FOR PERSONALIZED BOOKMARKING TOOLS, NAMELY TOOLS FOR BOOKMARKING SITES ON THE GLOBAL COMPUTER NETWORK AND STORING FAVORITE WEB ADDRESSES, AND SEARCH UTILITIES, BOTH OF WHICH ARE FOR USE IN CONNECTION WITH GLOBAL COMPUTER INFORMATION NETWORKS (U.S. CLS. 21, 23, 26, 36 AND 38).

SN 75-876,212. ALLOT COMMUNICATIONS, LTD., HOD HASHARON 45800, ISRAEL, FILED 12-16-1999.

NETPOLICY

FOR COMPUTER HARDWARE FOR MONITORING AND MANAGING NETWORK RESOURCES, COMPUTER SOFTWARE FOR MONITORING AND MANAGING NETWORK RESOURCES, COMPUTER SOFTWARE FOR CREATING AND EDITING QUALITY OF SERVICE RULES IN A DATA NETWORK; COMPUTER HARDWARE FOR IMPLEMENTING QUALITY OF SERVICE RULES IN A COMPUTER NETWORK (U.S. CLS. 21, 23, 26, 36 AND 38).

FIRST USE 9-1-1999; IN COMMERCE 9-1-1999.

SN 75-880,614. CALL HENRY, INC., COCOA, FL. FILED 12-27-1999.

Capella ★★☆☆
Software.com

NO CLAIM IS MADE TO THE EXCLUSIVE RIGHT TO USE "SOFTWARE.COM", APART FROM THE MARK AS SHOWN.

FOR COMPUTER SOFTWARE IN THE FIELD OF BUSINESS PROCESSES FOR USE IN SYSTEM CONFIGURATION SUPPORT, NAMELY FOR CUSTOMER SERVICE SUPPORT IN THE NATURE OF ENTERPRISE-WIDE RESOURCE PLANNING; FOR ORDER CONTROL IN THE NATURE OF TRACKING SALES ORDERS; FOR WORK PLANNING AND ESTIMATING; FOR ENGINEERING SUPPORT IN THE NATURE OF MAINTENANCE PROGRAM DEVELOPMENT AND RELIABILITY/MAINTAINABILITY ANALYSIS; FOR WORK SCHEDULING; FOR WORK CENTER OPERATIONS IN THE NATURE OF TRACKING WORK ASSIGNMENTS, REVIEWING SCHEDULES, AND RECORDING ACTUAL WORK EXPENDITURES; FOR VEHICLE OPERATIONS AND MANAGEMENT IN THE NATURE OF SCHEDULING AND TRACKING VEHICLE OPERATIONS AND MAINTENANCE; FOR MANAGING CONTRACTS AND SUBCONTRACTS, PURCHASING, ASSETS AND MATERIALS; FOR MATERIAL MANAGEMENT IN THE NATURE OF CATALOG MAINTENANCE AND INVENTORY STATUSING; FOR WAREHOUSE OPERATIONS IN THE NATURE OF RECEIVING, STORING, TRACKING, AND ISSUING MATERIALS; FOR PROJECT PLANNING AND MANAGEMENT, FOR HUMAN RESOURCES MANAGEMENT IN THE NATURE OF MAINTAINING AN EMPLOYEE'S PERSONAL DATA RELATED TO STATUS, WORK SCHEDULE, ORGANIZATIONAL ASSIGNMENT, AND PAYROLL; FOR QUALITY CONTROL IN THE NATURE OF PERFORMING WORK AND SCHEDULE REVIEW AND WORK APPROVALS, AND REPORTING PROBLEMS AND INITIATING CORRECTIVE ACTION; SAFETY ASSURANCE IN THE NATURE OF ASSESSING HAZARDOUS RISK, MONITORING HAZARDOUS RISK PROCEDURES, AND APPROVING WORK; FOR ENVIRONMENTAL MANAGEMENT IN THE NATURE OF THE MONITORING, MANAGEMENT, AND TRACKING OF HAZARDOUS AND/OR POTENTIALLY HAZARDOUS MATERIALS; FOR TIMEKEEPING/ATTENDANCE TRACKING; FOR JOB COST ACCOUNTING; FOR FINANCIAL CONTROL IN THE NATURE OF ESTABLISHING AND MANAGING BUDGETS; FOR MEASURING EMPLOYEE PERFORMANCE; FOR MANAGEMENT VISIBILITY IN THE NATURE OF CONDUCTING WORK AND MATERIAL APPROVALS AS WELL AS WORK STATUS REVIEWS (U.S. CLS. 21, 23, 26, 36 AND 38).

CLASS 9—(Continued).

SN 75-897,543. KAPPLER SAFETY GROUP, INC., GUNTERS-VILLE, AL. FILED 1-15-2000.

NEXGEN

FOR DISPOSABLE PROTECTIVE CLOTHING, NAMELY, COVERALLS, LAB COATS, FROCKS, JACKETS, SHIRTS, APRONS, HOODS AND ACCESSORIES, NAMELY, BOOTIES, SHOES AND SLEEVE COVERS (U.S. CLS. 21, 23, 26, 36 AND 38).

FIRST USE 2-1-1999; IN COMMERCE 2-1-1999.

SN 75-910,105. GEOVECTOR CORPORATION, SAN FRANCISCO, CA. FILED 1-26-2000.

BOOKMARK THE WORLD

FOR COMPUTER SOFTWARE FOR USE IN MOBILE TELEPHONES, HAND-HELD PERSONAL COMPUTERS AND LAPTOP COMPUTERS WHICH DETERMINES GEOGRAPHIC POSITION AND RECORDS POSITION AND SPECIFIC LANDMARKS AND RECALLS INFORMATION FOR USE AT A LATER TIME (U.S. CLS. 21, 23, 26, 36 AND 38).

FIRST USE 3-0-2000; IN COMMERCE 6-0-2000.

SN 75-916,761. CLICKSOFTWARE TECHNOLOGIES LTD., TEL AVIV, ISRAEL, FILED 2-11-2000.

CLICKANALYZE

FOR COMPUTER SOFTWARE FOR MEASURING AND TRACKING BUSINESS PERFORMANCE; COMPUTER SOFTWARE FOR ENTERPRISE RESOURCE PLANNING (U.S. CLS. 21, 23, 26, 36 AND 38).

SN 75-918,346. EKTRON, INC., AMHERST, NH. FILED 2-9-2000.

EKTRON

FOR COMPUTER SOFTWARE PROGRAMS FOR CREATING, EDITING, MANAGING AND PUBLISHING CONTENT DISPLAYED ON WEB SITES, FOR USE ON LOCAL NETWORKS AND ON A GLOBALLY CONNECTED NETWORK OF WEBSITES, INCLUDING THE INTERNET (U.S. CLS. 21, 23, 26, 36 AND 38).

FIRST USE 2-0-1999; IN COMMERCE 3-0-1999.

CLASS 9—(Continued).

SN 75-925,885. LIBERTY DIRECT INC., NEW YORK, NY. FILED 2-23-2000.



NO CLAIM IS MADE TO THE EXCLUSIVE RIGHT TO USE "TOKYO" AND "COMPANY", APART FROM THE MARK AS SHOWN.

FOR COMPUTER SOFTWARE FOR EXECUTING AND OPERATING AUTOMATED SECURITIES BROKERAGE TRANSACTIONS, EXECUTING SECURITIES TRADES, AND PROVIDING AND COLLECTING INFORMATION AND RESEARCH IN THE FIELD OF SECURITIES, FINANCE, FINANCIAL INSTRUMENT TRANSACTIONS AND FINANCE RELATED TECHNOLOGY (U.S. CLS. 21, 23, 26, 36 AND 38).

SN 75-929,384. NEOPOST S.A., 92220 BAGNEUX, FRANCE, FILED 2-28-2000.



PRIORITY CLAIMED UNDER SEC. 44(D) ON FRANCE APPLICATION NO. 99/814632, FILED 9-28-1999, REG. NO. 99814632, DATED 9-28-1999, EXPIRES 9-28-2009.

FOR ELECTRONIC AND DATA PROCESSING APPARATUS FOR THE MANAGEMENT OF MAIL, NAMELY FOR FOLDING LETTERS AND INSERTING LETTERS INTO ENVELOPES, AND FOR PROGRAMMING AND CONTROLLING THE PROCESS OF FOLDING LETTERS AND INSERTING THEM INTO ENVELOPES, COMPRISING UNITS FOR FEEDING ENVELOPES AND PAPER, AND FOR RETRIEVING ENVELOPES AND PAPER, A MONITOR, A CENTRAL UNIT FOR PROCESSING, FOLDING AND INSERTING, AND A MOBILE BASE INCORPORATING STORAGE SPACE FOR PAPER AND ENVELOPES (U.S. CLS. 21, 23, 26, 36 AND 38).

SN 75-935,391. AGERE SYSTEMS INC., ALLENTOWN, PA. BY ASSIGNMENT LUCENT TECHNOLOGIES INC., MURRAY HILL, NJ. FILED 2-17-2000.

STARPRO

FOR INTEGRATED CIRCUITS (U.S. CLS. 21, 23, 26, 36 AND 38).

CLASS 9—(Continued).

SN 75-955,983. KELLEY, RICHARD, D. SHREVEPORT, LA. AND BEARD, SHERRILL, L. SHREVEPORT, LA. FILED 3-10-2000.

PINNACLEQUEST

FOR PRE-RECORDED VIDEO TAPES FEATURING PERSONAL IMPROVEMENT, MOTIVATION, INSPIRATION, SELF-HELP, FITNESS AND HEALTH, PERSONAL DEVELOPMENT AND ACHIEVEMENT INSTRUCTION; PRE-RECORDED AUDIO TAPES FEATURING PERSONAL IMPROVEMENT, MOTIVATION, INSPIRATION, SELF-HELP, FITNESS AND HEALTH, PERSONAL DEVELOPMENT AND ACHIEVEMENT INSTRUCTION (U.S. CLS. 21, 23, 26, 36 AND 38).

SN 75-980,896. CIDRA CORPORATION, WALLINGFORD, CT. FILED 4-10-2000.

CIDRA

THE ENGLISH TRANSLATION OF THE WORD "CIDRA" IN THE MARK IS "CIDER".

FOR PHOTONIC COMPONENTS, MODULES AND SUBSYSTEMS FOR WAVELENGTH SIGNAL ROUTING, MONITORING AND CONDITIONING, NAMELY, LASERS, LIGHT WAVEGUIDES, LIGHT FILTERS AND MODULATORS, ELECTRO-OPTICAL WAVEGUIDES, FIBEROPTIC LIGHT SWITCHES AND FIBEROPTIC LIGHT AMPLIFIERS; PHOTONIC COMPONENTS AND SUBSYSTEMS FOR WAVELENGTH MANAGEMENT AND CONTROL IN WAVELENGTH DIVISION MULTIPLEXED (WDM) AND DENSE WAVELENGTH DIVISION MULTIPLEXED (DWDM) OPTICAL NETWORKS, NAMELY, MODULES, ELECTRONIC CIRCUITS AND COMPUTER SOFTWARE FOR THE PURPOSE OF WAVELENGTH MANAGEMENT AND CONTROL; DYNAMIC WAVELENGTH CHANNEL SWITCHES AND ROUTERS; DIFFRACTION GRATINGS; BRAGG GRATINGS; GRATING-BASED MODULES FOR WAVELENGTH REFERENCING; GRATING-BASED SENSOR NETWORKS; GRATING-BASED SENSORS; FIBER OPTIC SENSORS; DEVICES FOR MONITORING OPTICAL WAVELENGTHS; DEVICES FOR MONITORING OPTICAL SIGNALS; FIBER OPTIC SOURCES; OPTICAL SOURCES; DEMULTIPLEXERS; OPTICAL CONNECTORS; OPTICAL COUPLERS; OPTICAL SWITCHES; OPTICAL TRANSMITTERS; OPTICAL RECEIVERS; OPTICAL FILTERS; COMPUTER PROGRAMS, SOFTWARE AND FIRMWARE FOR OPTICAL NETWORK DIAGNOSTICS; COMPUTER PROGRAMS, SOFTWARE AND FIRMWARE FOR USE IN SIGNAL ROUTING, CONTROL, MONITORING AND CONDITIONING; AND COMPUTER PROGRAMS, SOFTWARE AND FIRMWARE FOR USE IN WAVELENGTH MANAGEMENT AND CONTROL (U.S. CLS. 21, 23, 26, 36 AND 38).

FIRST USE 8-25-1997; IN COMMERCE 8-25-1997.

SN 76-000,031. QUANTUM ADVANCED TECHNOLOGIES, INC., WASHINGTON, DC. FILED 3-14-2000.

QAT

FOR COMPUTER HARDWARE; AND EQUIPMENT FOR PROVIDING SECURE TRANSMISSION OF AUDIO, VIDEO AND DATA, NAMELY, DIGITAL AND ANALOG RECEIVERS, DIGITAL AND ANALOG TRANSMITTERS, TELEPHONE TRANSMITTERS, VIDEO TRANSMITTERS, MODULATORS, DEMODULATORS AND MODEMS (U.S. CLS. 21, 23, 26, 36 AND 38).

CLASS 9—(Continued).

SN 76-012,240. DOBOX, INC., DRAPER, UT. FILED 3-29-2000.

DOBOX

FOR COMPUTER SOFTWARE PLATFORMS FOR HOME NETWORK AND APPLICATIONS FOR HOME INTERACTION PROTECTION SYSTEMS, HOME VIRUS FILTERS, HOME FIREWALL SYSTEMS, HOME MEDIA AND VIDEO SYSTEMS, HOME DATA AND INFORMATION SYSTEMS (U.S. CLS. 21, 23, 26, 36 AND 38).

SN 76-012,944. MAIA ENTERTAINMENT, INC., SAN RAMON, CA. FILED 3-29-2000.

REALTIME DRAMA

FOR COMPUTER AND VIDEO GAME SOFTWARE; VIDEO GAME CARTRIDGES; COMPUTER SOFTWARE FOR OPERATING A ROLE PLAYING, INTERACTIVE GAME; COMPUTER SOFTWARE IN THE FIELD OF VIRTUAL REALITY MODELING; COMPUTER SOFTWARE, DOWNLOADABLE VIA A GLOBAL COMMUNICATIONS NETWORK, FOR OPERATING A ROLE PLAYING, INTERACTIVE GAME; COMPUTER SOFTWARE, EXECUTED REMOTELY OVER A COMPUTER NETWORK, FOR OPERATING A ROLE PLAYING, INTERACTIVE GAME; VIDEO GAME MACHINES; VIRTUAL REALITY GAME SOFTWARE; MOTION PICTURE FILMS; DVD'S, PRERECORDED VIDEOTAPES, LASER DISCS, CD-ROMS, VIDEO CLIPS AND ANIMATED CLIPS, ALL CONTAINING MOTION PICTURES, MOVIES, TELEVISION SERIES, DOCUMENTARIES, NEWS, COMEDY PERFORMANCES, TALK SHOWS, ANIMATIONS, GAMES, VIDEO AND SOUND RECORDINGS, LIVE EVENTS, PARADES, SPORTING EVENTS, THEATRICAL EVENTS, PUBLIC PERFORMANCES AND MUSICAL CONCERTS (U.S. CLS. 21, 23, 26, 36 AND 38).

SN 76-015,778. HIGH SPEED NET SOLUTIONS, INC., RALEIGH, NC. BY ASSIGNMENT SUMMUS, LTD., RALEIGH, NC. FILED 4-3-2000.

MAXXAD

FOR DOWNLOADABLE COMPUTER SOFTWARE FOR USE IN COMPRESSING AND MANIPULATING DIGITAL VIDEOS AND IMAGES FOR DISTRIBUTION OVER THE INTERNET AND GLOBAL COMPUTER NETWORKS; DOWNLOADABLE COMPUTER SOFTWARE FOR USE IN INCORPORATING DIGITAL VIDEOS AND IMAGES INTO MULTIMEDIA PACKAGES (U.S. CLS. 21, 23, 26, 36 AND 38).

SN 76-026,066. QUALCOMM INCORPORATED, SAN DIEGO, CA. FILED 4-13-2000.

QCHAT

FOR TWO-WAY OR GROUP COMMUNICATIONS DEVICE, NAMELY, TELEPHONES, WIRELESS TELEPHONES, PERSONAL DIGITAL ASSISTANTS (PDAS), COMPUTERS, AND MANUALS PROVIDED THEREWITH (U.S. CLS. 21, 23, 26, 36 AND 38).

CLASS 9—(Continued).

SN 76-027,885. LINEO CANADA CORP., LINDEN, UT. BY CHANGE OF NAME RT- CONTROL INC., TORONTO, ONTARIO, CANADA, FILED 4-17-2000.



NO CLAIM IS MADE TO THE EXCLUSIVE RIGHT TO USE "SIMM", APART FROM THE MARK AS SHOWN.

FOR EMBEDDED MICROCONTROLLER SINGLE IN-LINE MEMORY MODULE, NAMELY, A CIRCUIT BOARD THAT HOLDS RANDOM ACCESS MEMORY CHIPS (U.S. CLS. 21, 23, 26, 36 AND 38).

SN 76-029,333. HEURIS LOGIC, INCORPORATED, ST. LOUIS, MO. FILED 4-19-2000.

HEURIS

FOR COMPUTER SOFTWARE, NAMELY, COMPRESSION TOOLS FOR THE MULTI-MEDIA INDUSTRY (U.S. CLS. 21, 23, 26, 36 AND 38).

FIRST USE 8-0-1993; IN COMMERCE 8-0-1993.

SN 76-029,335. HEURIS LOGIC, INCORPORATED, ST. LOUIS, MO. FILED 4-19-2000.

MPEG POWER PROFESSIONAL

NO CLAIM IS MADE TO THE EXCLUSIVE RIGHT TO USE "MPEG" AND "PROFESSIONAL", APART FROM THE MARK AS SHOWN.

FOR COMPUTER SOFTWARE, NAMELY, COMPRESSION TOOLS FOR THE MULTI-MEDIA INDUSTRY (U.S. CLS. 21, 23, 26, 36 AND 38).

FIRST USE 11-0-1996; IN COMMERCE 11-0-1996.

SN 76-035,021. VISUAL EDGE TECHNOLOGY, INC., SAN JOSE, CA. FILED 4-26-2000.

REPRO:FX

FOR PRINTER CONTROLLERS WHICH PROVIDE CONNECTIVITY BETWEEN AND AMONG USERS, PRINTERS, NETWORKS AND COMPANIES, AND PRINTER CONTROLLER SOFTWARE (U.S. CLS. 21, 23, 26, 36 AND 38).

FIRST USE 3-1-1998; IN COMMERCE 7-20-1998.

CLASS 9—(Continued).

SN 76-035,369. TILLOTSON CORPORATION, AKA BEST MANUFACTURING COMPANY, BOSTON, MA. FILED 4-26-2000.

REAL FEEL

FOR PROTECTIVE WORK GLOVES FOR INDUSTRIAL USE (U.S. CLS. 21, 23, 26, 36 AND 38).

SN 76-039,055. BIRDLAND PRODUCTIONS, INC., BOERNE, TX. FILED 5-2-2000.



NO CLAIM IS MADE TO THE EXCLUSIVE RIGHT TO USE "PRODUCTIONS", APART FROM THE MARK AS SHOWN.

FOR RECORDINGS; NAMELY, RECORDINGS OF MUSICAL SOUND AND MUSICAL VIDEO (U.S. CLS. 21, 23, 26, 36 AND 38).

SN 76-040,446. MACEDON MEDIATURE INC., NEW YORK, NY. FILED 5-5-2000.

WORKTRAC

FOR COMPUTER SOFTWARE FOR MANAGING AND FACILITATING THE SECURE EXCHANGE AND COMMUNICATION OF INFORMATION, DATA AND GRAPHICS OVER INTERNAL COMPUTER NETWORKS, EXTERNAL COMPUTER NETWORKS, GLOBAL COMPUTER NETWORKS AND ELECTRONIC DATABASES; COMMUNICATIONS SOFTWARE FOR CONNECTING COMPUTER NETWORK USERS, AND/OR GLOBAL COMPUTER NETWORKS; COMPUTER SOFTWARE FOR WIRELESS CONNECTIONS TO INTERNAL COMPUTER NETWORKS, EXTERNAL COMPUTER NETWORKS, GLOBAL COMPUTER NETWORKS AND ELECTRONIC DATA BASES; COMPUTER SOFTWARE FOR USE IN RECORDING, STORING, RETRIEVING, MONITORING, AGGREGATING, DISPLAYING, TRACKING, MANAGING, TRANSMITTING AND DISSEMINATING A WIDE RANGE OF BUSINESS DATA, TEXT AND GRAPHICS RELATING TO BUSINESS MANAGEMENT, LOGISTICS AND OPERATION, SUPPLIERS, CUSTOMERS, MATERIAL, PRODUCTION, HUMAN RESOURCES, ASSETS MANAGEMENT, ACCOUNTING, FINANCING, WORKFLOW, BILLING, SALES, ORDER PROCESSING, INVENTORY AND DISTRIBUTION; COMPUTER SOFTWARE FOR COMMUNICATING WITH COMPUTERS, COMPUTER SOFTWARE, DATABASES, COMMUNICATION SERVICES AND ELECTRONIC COMMUNICATION NETWORKS; COMPUTER SOFTWARE FOR ACCESSING COMPUTERS, COMPUTER SOFTWARE, DATABASES, COMMUNICATION SERVICES, AND ELECTRONIC COMMUNICATIONS NETWORKS; COMPUTER SOFTWARE FOR CONDUCTING, MANAGING AND SECURING FINANCIAL OR COMMERCIAL TRANSACTIONS OVER COMPUTER NETWORKS, GLOBAL COMPUTER NETWORKS AND ELECTRONIC DATABASES (U.S. CLS. 21, 23, 26, 36 AND 38).

CLASS 9—(Continued).

SN 76-041,068. VLC, INC., BOZEMAN, MT. FILED 5-4-2000.

MAYAN WHEEL OF GOLD

FOR GAMING MACHINES WITH OR WITHOUT VIDEO OUTPUT AND SOFTWARE OPERATED VIDEO GAMES SOLD AS A COMPONENT PART THEREFOR (U.S. CLS. 21, 23, 26, 36 AND 38).

FIRST USE 2-21-2001; IN COMMERCE 2-21-2001.

SN 76-041,730. EMOTION, INC., VIENNA, VA. FILED 5-8-2000.

eMotion

FOR COMPUTER SOFTWARE FOR THE MANAGEMENT OF DIGITAL MEDIA SYSTEMS, NAMELY, CAPTURING, REVIEWING, ANNOTATING, DISPLAYING, MANAGING, STORING, DISTRIBUTING AND TRANSMITTING STORED MULTIMEDIA CONTENT (U.S. CLS. 21, 23, 26, 36 AND 38).

FIRST USE 11-0-1999; IN COMMERCE 11-0-1999.

SN 76-043,934. L.S. STARRETT COMPANY, THE, ATHOL, MA. FILED 5-8-2000.

ALTISSIMO

FOR HEIGHT GAUGES (U.S. CLS. 21, 23, 26, 36 AND 38).

FIRST USE 9-0-2000; IN COMMERCE 3-15-2001.

SN 76-044,932. CREATIVE PLANET, INC., LOS ANGELES, CA. FILED 5-9-2000.

CREATIVE PLANET

OWNER OF U.S. REG. NO. 2,420,411.
FOR COMPUTER SOFTWARE USED IN SCHEDULING AND BUDGETING THE PRODUCTION OF CREATIVE CONTENT AND MANUALS PACKAGED AS A UNIT (U.S. CLS. 21, 23, 26, 36 AND 38).

SN 76-046,623. AEROTECH, INC., PITTSBURGH, PA. FILED 5-11-2000.

FIBERALIGN

FOR APPARATUS FOR OPTIC FIBER TO FIBER, OPTIC FIBER TO WAVEGUIDE, OPTIC FIBER TO LASER DIODE ALIGNMENT (U.S. CLS. 21, 23, 26, 36 AND 38).

CLASS 9—(Continued).

SN 76-047,647. HOLLAND ELECTRONICS, LLC, VENTURA, CA. FILED 5-12-2000.

SUPERLOK

FOR ELECTRICAL COAXIAL CABLE CONNECTORS, NAMELY COMPRESSION AND CRIMP-ON ELECTRICAL COAXIAL CABLE CONNECTORS (U.S. CLS. 21, 23, 26, 36 AND 38).

SN 76-050,233. ESOFT, INC., BROOMFIELD, CO. FILED 5-17-2000.

ESOFT

FOR COMPUTER CONNECTIVITY SOFTWARE USED TO ESTABLISH AND MANAGE CONNECTIONS BETWEEN A COMPUTER AND COMPUTER NETWORKS AND GLOBAL COMPUTER NETWORKS (U.S. CLS. 21, 23, 26, 36 AND 38).

FIRST USE 12-31-1986; IN COMMERCE 12-31-1986.

SN 76-052,221. METROHM LTD., 9100 HERISAU, SWITZERLAND, FILED 5-19-2000.

SURFACTRODE

FOR SENSORS FOR PH-MEASURING FOR USE IN CHEMICAL LABORATORIES (U.S. CLS. 21, 23, 26, 36 AND 38).

FIRST USE 1-1-1998; IN COMMERCE 1-1-1998.

SN 76-054,169. META SOLUTIONS, INC., WARREN, NJ. FILED 5-23-2000.

PROTRACK

FOR COMPUTER SOFTWARE FOR USE IN CLINICAL INFORMATION MANAGEMENT, NAMELY, FOR USE IN DATABASE MANAGEMENT OF PROTOCOLS FOR PHARMACEUTICAL INDUSTRY CLINICAL TRIALS (U.S. CLS. 21, 23, 26, 36 AND 38).

SN 76-054,172. INNOVATIVE HOME PRODUCTS, INC., BIRMINGHAM, MI. FILED 5-23-2000.

ACTIVE SERIES

NO CLAIM IS MADE TO THE EXCLUSIVE RIGHT TO USE "SERIES", APART FROM THE MARK AS SHOWN.

FOR BARRIER OPENING DEVICES; NAMELY; ELECTRICALLY OPERATED GARAGE DOOR OPENERS AND RADIO CONTROL SYSTEMS THEREFOR COMPRISED OF RF TRANSMITTERS, RF RECEIVERS AND ELECTRIC MOTOR DRIVEN LIFTING AND LOWERING MECHANISMS OPERATIVELY CONNECTED TO SUCH RF RECEIVERS (U.S. CLS. 21, 23, 26, 36 AND 38).

CLASS 9—(Continued).

SN 76-054,173. INNOVATIVE HOME PRODUCTS, INC., BIRMINGHAM, MI. FILED 5-23-2000.

FUNDAMENTAL SERIES

NO CLAIM IS MADE TO THE EXCLUSIVE RIGHT TO USE "SERIES", APART FROM THE MARK AS SHOWN.

FOR BARRIER OPENING DEVICES; NAMELY; ELECTRICALLY OPERATED GARAGE DOOR OPENERS AND RADIO CONTROL SYSTEMS THEREFOR COMPRISED OF RF TRANSMITTERS, RF RECEIVERS AND ELECTRIC MOTOR DRIVEN LIFTING AND LOWERING MECHANISMS OPERATIVELY CONNECTED TO SUCH RF RECEIVERS (U.S. CLS. 21, 23, 26, 36 AND 38).

SN 76-055,021. JBA CONSULTING, INC., GREENSBORO, NC. FILED 5-23-2000.

IINQUIRE

FOR COMPUTER SOFTWARE FOR DETERMINING THE STATUS OF ACCOUNTS PAYABLE, AND MANUALS, SOLD AS A UNIT (U.S. CLS. 21, 23, 26, 36 AND 38).

SN 76-055,792. SYNERPRO INC., MONTREAL, QUEBEC, CANADA, FILED 5-24-2000.

P2M

FOR MANAGEMENT AND PRODUCTIVITY SOFTWARE FOR ORGANIZING AND MANAGING PERSONAL AND BUSINESS INFORMATION, LAUNCHING SOFTWARE APPLICATIONS, SCHEDULING APPOINTMENTS, PROCESSING PERSONAL AND BUSINESS CALCULATIONS, TAKING FREEHAND NOTES, AND DRAFTING FREEHAND IMAGES; FINANCIAL MANAGEMENT COMPUTER SOFTWARE; REAL ESTATE MANAGEMENT SOFTWARE, NAMELY, SOFTWARE DESIGNED TO HELP RUN MANAGED PROPERTIES, IMPORT ACTUAL PROPERTY DATA AND LEASE TERMS, AND TO DETERMINE FUTURE PURCHASES AND RENTS; COMPUTER SOFTWARE FOR LEASE AND SUBLEASE ADMINISTRATION AND LEASE AND SUBLEASE MANAGEMENT (U.S. CLS. 21, 23, 26, 36 AND 38).

SN 76-055,892. TSRL, INC., ANN ARBOR, MI. FILED 5-24-2000.

MODERN BIOPHARMACEUTICS

NO CLAIM IS MADE TO THE EXCLUSIVE RIGHT TO USE "BIOPHARMACEUTICS", APART FROM THE MARK AS SHOWN.

FOR EDUCATIONAL SOFTWARE FEATURING INSTRUCTION IN BIOPHARMACEUTICS (U.S. CLS. 21, 23, 26, 36 AND 38).

FIRST USE 3-6-2000; IN COMMERCE 3-6-2000.

CLASS 9—(Continued).

SN 76-056,412. EXTENEX CORPORATION, SOQUEL, CA. FILED 5-22-2000.

EXTENEX

FOR COMPUTER SOFTWARE AND FIRMWARE USED FOR DOWNLOADING, STORING AND TRANSFERRING INFORMATION AND DATA IN THE FIELD OF ELECTRONIC DATA PROCESSING; COMPUTER SOFTWARE AND FIRMWARE TO ENHANCE THE AUDIO-VISUAL CAPABILITIES OF MULTIMEDIA APPLICATIONS, NAMELY, FOR THE INTEGRATION OF TEXT, AUDIO, GRAPHICS, STILL IMAGES AND MOVING PICTURES; PORTABLE COMPACT COMPUTERS; COMPUTER PERIPHERALS; ELECTRONIC PERSONAL ORGANIZERS; CELLULAR TELEPHONES; SOLID STATE MEMORY CARDS AND CARTRIDGES; SERIAL COMMUNICATION CABLES; VIDEO MONITORS; VIDEO PROJECTORS; COMMUNICATIONS SOFTWARE FOR CONNECTING INTERACTIVE MEDIA COMPUTERS AND COMPUTER PERIPHERALS; COMPUTER TELEPHONY SOFTWARE; AND INSTRUCTION MANUALS DISTRIBUTED WITH THE FOREGOING (U.S. CLS. 21, 23, 26, 36 AND 38).

SN 76-057,065. 3DO COMPANY, THE, REDWOOD CITY, CA. FILED 5-23-2000.

WDL

FOR COMPUTER SOFTWARE FOR OPERATING INTERACTIVE GAMES ON MULTIMEDIA DEVICES, VIDEO GAME MACHINES AND PERSONAL COMPUTERS; COMPUTER VIDEO GAMES PLAYED OVER A GLOBAL COMPUTER NETWORK, AND MANUALS SOLD AS A UNIT THEREWITH (U.S. CLS. 21, 23, 26, 36 AND 38).

SN 76-057,086. VBRICK SYSTEMS, INC., WALLINGFORD, CT. FILED 5-25-2000.

ETHERNETV

FOR COMPUTER HARDWARE AND COMPUTER SOFTWARE USED TO SEND AUDIO/VIDEO TELEVISION SIGNALS VIA COMPUTER NETWORKS (U.S. CLS. 21, 23, 26, 36 AND 38).

SN 76-057,268. CASE LOGIC, INC., LONGMONT, CO. FILED 5-18-2000.

CD TRAVELER

NO CLAIM IS MADE TO THE EXCLUSIVE RIGHT TO USE "CD", APART FROM THE MARK AS SHOWN.

FOR CARRYING CASES FOR PORTABLE MUSIC PLAYERS AND COMPACT DISCS (U.S. CLS. 21, 23, 26, 36 AND 38).

FIRST USE 10-0-1994; IN COMMERCE 10-0-1994.

CLASS 9—(Continued).

SN 76-057,992. CASIO KEISANKI KABUSHIKI KAISHA, DBA CASIO COMPUTER CO., LTD., SHIBUYA-KU, TOKYO, JAPAN, FILED 5-26-2000.

PVOS

FOR HANDHELD PERSONAL COMPUTERS, PERSONAL DIGITAL ASSISTANTS, COMPUTER HARDWARE; PERSONAL COMPUTERS AND PARTS THEREOF; COMPUTER PERIPHERALS; PRINTERS FOR COMPUTERS; SOFTWARE FOR A PERSONAL COMPUTER FOR USE IN ACHIEVING DATA EXCHANGE BETWEEN THE PERSONAL COMPUTER AND WRISTWATCH, A DIGITAL CAMERA OR OTHER ELECTRONIC APPARATUS AND INSTRUMENTS; ELECTRONIC CALCULATORS, ELECTRONIC PERSONAL ORGANIZERS, DIGITAL CAMERAS, PRINTERS FOR DIGITAL CAMERAS, LCD TELEVISION SETS, VEHICLE NAVIGATION SYSTEM CONSISTING OF COMPUTER SOFTWARE FEATURING A DATABASE OF MAP COORDINATES AND LOCATIONS, A GLOBAL POSITIONING SATELLITE RECEIVER, ELECTRICAL CABLE AND DOCUMENTATION ALL SOLD AS A UNIT, ELECTRONIC LABEL PRINTERS, CELLULAR TELEPHONES, RADIO PAGERS, RADIOS, COMPACT DISK PLAYERS, MP3 (MOTION PICTURE GROUP 3) PLAYERS COMPATIBLE WITH MP3 FORMAT IN THE NATURE OF DIGITAL AUDIO PLAYERS, AUDIO TAPE RECORDERS AND VIDEO TAPE RECORDERS (U.S. CLS. 21, 23, 26, 36 AND 38).

SN 76-057,994. CASIO KEISANKI KABUSHIKI KAISHA, DBA CASIO COMPUTER CO., LTD., SHIBUYA-KU, TOKYO, JAPAN, FILED 5-26-2000.

POINT IT

FOR HANDHELD PERSONAL COMPUTERS, PERSONAL DIGITAL ASSISTANTS, COMPUTER HARDWARE; PERSONAL COMPUTERS AND PARTS THEREOF; COMPUTER PERIPHERALS; PRINTERS FOR COMPUTERS; SOFTWARE FOR A PERSONAL COMPUTER FOR USE IN ACHIEVING DATA EXCHANGE BETWEEN THE PERSONAL COMPUTER AND A WRISTWATCH, A DIGITAL CAMERA OR OTHER ELECTRONIC APPARATUS AND INSTRUMENTS; ELECTRONIC CALCULATORS, ELECTRONIC PERSONAL ORGANIZERS, DIGITAL CAMERAS, PRINTERS FOR DIGITAL CAMERAS, LCD TELEVISION SETS, VEHICLE NAVIGATION SYSTEM CONSISTING OF COMPUTER SOFTWARE FEATURING A DATABASE OF MAP COORDINATES AND LOCATIONS, A GLOBAL POSITIONING SATELLITE RECEIVER, ELECTRICAL CABLE AND DOCUMENTATION ALL SOLD AS A UNIT, ELECTRONIC LABEL PRINTERS, CELLULAR TELEPHONES, RADIO PAGERS, RADIOS, COMPACT DISK PLAYERS, MP3 (MOTION PICTURE GROUP 3) PLAYERS COMPATIBLE WITH MP3 FORMAT IN THE NATURE OF DIGITAL AUDIO PLAYERS, AUDIO TAPE RECORDERS AND VIDEO TAPE RECORDERS (U.S. CLS. 21, 23, 26, 36 AND 38).

CLASS 9—(Continued).

SN 76-058,111. CLICKACTION, INC., PALO ALTO, CA. FILED 5-11-2000.

ICATCHERS

FOR COMPUTER SOFTWARE FOR THE DESIGN, HOSTING AND MAINTENANCE OF WEB PAGES AND WEB SITES FOR OTHERS; COMPUTER SOFTWARE FOR USE IN DESIGNING, HOSTING AND MAINTAINING ONLINE RETAIL ESTABLISHMENTS AND PROVIDING ONLINE RETAIL SERVICES; COMPUTER SOFTWARE FOR USE IN SENDING AND RECEIVING ELECTRONIC MAIL, PERFORMING CALENDARING AND SCHEDULING, AND ORGANIZING PERSONAL INFORMATION; PROJECT MANAGEMENT SOFTWARE, AND MANUALS SUPPLIED THEREWITH (U.S. CLS. 21, 23, 26, 36 AND 38).

SN 76-058,971. ENMED, INC., BURLINGTON, MA. FILED 5-30-2000.

ACCELIANT

FOR COMPUTER SOFTWARE, COMPUTER PROGRAMS, INTERNET-BASED COMPUTER SOFTWARE, WIRELESS APPLICATION SOFTWARE, WIRELESS APPLICATION PROGRAMS, AND INTERNET-BASED COMPUTER PROGRAMS TO MANAGE AND STREAMLINE THE COLLECTION, ORGANIZATION, ANALYSIS AND REPORTING OF DATA IN CONNECTION WITH PHARMACEUTICAL AND MEDICAL DEVICE APPROVAL PROCESSES (U.S. CLS. 21, 23, 26, 36 AND 38).

SN 76-060,605. INTERTECH DEVELOPMENT COMPANY, SKOKIE, IL. FILED 5-31-2000.

TECHSTAND

FOR PREFABRICATED APPARATUS, NAMELY A TEST STAND FOR TESTING LEAKS OR FLOW IN THE FIELD OF MANUFACTURING (U.S. CLS. 21, 23, 26, 36 AND 38).

SN 76-061,324. R/D TECH INC., QUEBEC, PROVINCE OF QUEBEC, CANADA, FILED 6-5-2000.

SPNR

FOR EDDY CURRENT PROBES FOR NON-DESTRUCTIVE TESTING OF PIPES AND TUBES (U.S. CLS. 21, 23, 26, 36 AND 38).

CLASS 9—(Continued).

SN 76-062,576. MULTI-TECH SYSTEMS, INC., MOUNDS VIEW, MN. FILED 6-1-2000.

**TECHNICALLY
EVERYTHING'S POSSIBLE**

FOR TELECOMMUNICATIONS EQUIPMENT, NAMELY, COMMUNICATIONS SERVERS, ISDN ADAPTER, MODEMS, ROUTERS, T-1 INTERFACE, AND FRAME RELAY ADAPTERS (U.S. CLS. 21, 23, 26, 36 AND 38).

SN 76-062,727. TELOPTICA, INC., RICHARDSON, TX. FILED 6-5-2000.

DESIGN IQ

NO CLAIM IS MADE TO THE EXCLUSIVE RIGHT TO USE "DESIGN", APART FROM THE MARK AS SHOWN.

FOR COMPUTER SOFTWARE FOR USE IN DESIGNING OPTICAL TELECOMMUNICATIONS NETWORKS AND DATA NETWORKS (U.S. CLS. 21, 23, 26, 36 AND 38).

SN 76-062,825. SUTHERLAND LUMBER & HOME CENTER, INC., TULSA, OK. FILED 6-5-2000.

MY PRICER

NO CLAIM IS MADE TO THE EXCLUSIVE RIGHT TO USE "PRICER", APART FROM THE MARK AS SHOWN.

FOR HAND HELD SCANNER FOR READING PRICES ON MERCHANDISE (U.S. CLS. 21, 23, 26, 36 AND 38).

SN 76-064,920. MAXAGER TECHNOLOGY, INC., SAN RAFAEL, CA. FILED 6-7-2000.

PRECISION BIDDING

NO CLAIM IS MADE TO THE EXCLUSIVE RIGHT TO USE "BIDDING", APART FROM THE MARK AS SHOWN.

FOR COMPUTER SOFTWARE FOR GATHERING AND REPORTING REAL-TIME FACTORY INFORMATION FOR COSTING AND PRODUCTION MANAGEMENT OF DISCRETE MANUFACTURING OPERATIONS (U.S. CLS. 21, 23, 26, 36 AND 38).

FIRST USE 2-29-2000; IN COMMERCE 3-1-2000.

CLASS 9—(Continued).

SN 76-065,165. SILICON GENETICS, REDWOOD CITY, CA. FILED 6-6-2000.

GENESPRING

FOR COMPUTER SOFTWARE FOR USE IN BIOTECHNOLOGICAL RESEARCH, NAMELY SOFTWARE USED TO MANIPULATE AND VISUALIZE GENE EXPRESSION DATA (U.S. CLS. 21, 23, 26, 36 AND 38).

FIRST USE 5-22-1998; IN COMMERCE 1-5-1999.

SN 76-065,405. INTERACTUAL TECHNOLOGIES, INC., SAN JOSE, CA. FILED 6-6-2000.

**CONNECTING THE
AUDIENCE**

FOR COMPUTER SOFTWARE FOR CUSTOMIZING AND EDITING AUDIO-VISUAL AND MULTIMEDIA ENTERTAINMENT AND PRESENTATIONS; COMPUTER SOFTWARE FOR MANAGING, CREATING AND PRESENTING ADVERTISING FROM COMPACT DISK, DVD (FORMERLY CALLED DIGITAL VERSATILE DISK AND DIGITAL VIDEO DISK) AND A GLOBAL COMPUTER NETWORK; AND COMPUTER SOFTWARE FOR CREATING VIDEO PRESENTATIONS; COMPUTER SOFTWARE FOR OPERATING COMPUTER KIOSKS; COMPUTER GAME SOFTWARE; AND COMPUTER SOFTWARE FOR CREATING AND PRESENTING ADVERTISING MATERIALS VIA COMPACT DISKS, DVDS, AND THE GLOBAL COMPUTER INFORMATION NETWORK (U.S. CLS. 21, 23, 26, 36 AND 38).

SN 76-065,445. LINEONLINE, FRESNO, CA. FILED 6-8-2000.

LINE ONLINE

NO CLAIM IS MADE TO THE EXCLUSIVE RIGHT TO USE "ONLINE", APART FROM THE MARK AS SHOWN.

FOR DOWNLOADABLE ONLINE MAGAZINES IN THE FIELD OF CULTURAL ARTS (U.S. CLS. 21, 23, 26, 36 AND 38).

FIRST USE 1-1-2000; IN COMMERCE 5-15-2000.

CLASS 9—(Continued).

SN 76-067,000. RIOPORT.COM, INC., SAN JOSE, CA. FILED 6-8-2000.



NO CLAIM IS MADE TO THE EXCLUSIVE RIGHT TO USE "DIGITAL AUDIO ACCESSORIES", APART FROM THE MARK AS SHOWN.

THE ENGLISH TRANSLATION OF "RIO" IS "RIVER". FOR ACCESSORIES FOR DIGITAL INTERNET APPLIANCES, NAMELY, MEMORY BACKPACKS, SWAP-PABLE COLOR COVERS, FM TUNER REMOTES, AND SPORT AND TRAVEL CASES (U.S. CLS. 21, 23, 26, 36 AND 38).

SN 76-067,440. FIBRE CHANNEL INDUSTRY ASSOCIATION, SAN FRANCISCO, CA. FILED 6-9-2000.

SANMARK

FOR COMPUTER NETWORK ATTACHED DATA STORAGE DEVICES AND COMPONENTS, NAMELY, SERVERS NETWORK ATTACHED DISK AND TAPE DRIVE SUBSYSTEMS, NAMELY, TAPE DRIVE LIBRARIES; COMPUTER HARDWARE AND SOFTWARE FOR INTERCONNECTING, MANAGING AND OPERATING STORAGE SYSTEMS, NAMELY, COMPUTER NETWORK ATTACHED DATA STORAGE DEVICES AND COMPONENTS, NAMELY, SERVERS, NETWORK ATTACHED DISK AND TAPE DRIVE SUBSYSTEMS, NAMELY, TAPE DRIVE LIBRARIES (U.S. CLS. 21, 23, 26, 36 AND 38).

SN 76-067,526. SHIN-ETSU HANDOTAI CO., LTD., CHIYODA-KU, TOKYO, JAPAN, FILED 6-9-2000.

IG-NANA

PRIORITY CLAIMED UNDER SEC. 44(D) ON JAPAN APPLICATION NO. 2000-039518, FILED 4-13-2000, REG. NO. 4466577, DATED 4-13-2001, EXPIRES 4-13-2011.

"NANA" IS A transliteration and means "SEVEN" (7) IN THE JAPANESE LANGUAGE.

FOR SEMICONDUCTOR SILICON WAFERS, SEMI-CONDUCTOR SILICON INGOTS (U.S. CLS. 21, 23, 26, 36 AND 38).

SN 76-069,063. JOUAN, INC., WINCHESTER, VA. FILED 6-12-2000.

PRECISION

FOR LABORATORY APPARATUS, NAMELY WATER BATHS, INCUBATORS, REFRIGERATORS, OVENS AND HOT PLATES (U.S. CLS. 21, 23, 26, 36 AND 38).

FIRST USE 5-11-1977; IN COMMERCE 5-11-1977.

CLASS 9—(Continued).

SN 76-069,067. AHMED, AFTABUDDIN PALASH, WASHINGTON, DC. AND YOUNAN, SAEED ADIL, WASHINGTON, DC. FILED 6-12-2000.

ADDICTIVE RECORDS

NO CLAIM IS MADE TO THE EXCLUSIVE RIGHT TO USE "RECORDS", APART FROM THE MARK AS SHOWN.

FOR SERIES OF MUSICAL SOUND RECORDINGS, PRE-RECORDED COMPACT DISCS, AUDIO CASSETTES, DIGITAL VIDEO DISCS, PHONOGRAPH RECORDS AND DIGITAL AUDIO FILES FEATURING MUSIC (U.S. CLS. 21, 23, 26, 36 AND 38).

FIRST USE 12-0-1998; IN COMMERCE 12-0-1998.

SN 76-069,352. GUANGZHOU BEAUTY CULTURE COMMUNICATION, LTD., GUANGZHOU 510500, CHINA, FILED 6-13-2000.

俏佳人

THE transliteration OF THE CHINESE CHARACTERS ON THE MARK IS "TIAO", "JIA" AND "REN". THE ENGLISH TRANSLATION IS "PRETTY" AND "BEAUTIFUL WOMAN".

FOR BLANK FLOPPY DISCS, BLANK OPTICAL DISCS, BLANK VIDEO TAPES AND BLANK MICRO-GROOVE DISCS FOR RECORDING SOUNDS AND IMAGES; VIDEO GAME CARTRIDGES; PRERECORDED VIDEO COMPACT DISCS FEATURING MOVIES, TV SERIALS, STORIES, MUSIC AND SONGS; TAPE RECORDERS; RADIOS; MICROPHONES; TELEVISIONS; VIDEO RECORDERS; VIDEO GAME PLAYERS CONNECTED WITH TV AND LASER DISC PLAYERS (U.S. CLS. 21, 23, 26, 36 AND 38).

FIRST USE 9-0-1994; IN COMMERCE 8-0-1999.

SN 76-069,957. RADWARE LTD., TEL-AVIV, ISRAEL, FILED 6-14-2000.

GET CERTAIN

FOR COMPUTER HARDWARE AND COMPUTER SOFTWARE FOR INTERNET TRAFFIC MANAGEMENT (U.S. CLS. 21, 23, 26, 36 AND 38).

CLASS 9—(Continued).

SN 76-070,383. KEWTECH CORPORATION, MEGURO-KU, TOKYO, JAPAN, FILED 6-14-2000.

KEWTECH

FOR AMMETERS, VOLTMETERS AND OHMMETERS (U.S. CLS. 21, 23, 26, 36 AND 38).

SN 76-071,661. SAGE SYSTEMS, INC., ALAMEDA, CA. FILED 6-16-2000.

**IF IT'S PLUGGED IN, IT'S
CONNECTED**

FOR COMPUTER PROGRAMS, NAMELY, SOFTWARE FOR THE ELECTRONIC CONTROL OF HOME AND BUILDING AUTOMATION ELECTRONIC APPARATUS, NAMELY, SOFTWARE FOR MONITORING COMPUTER BUSES, SOFTWARE FOR MONITORING MULTI-STATE AND ADDRESSABLE SWITCHES, SOFTWARE FOR MONITORING GATEWAY MODEMS, SOFTWARE FOR MONITORING SERIAL PROCESSORS, SOFTWARE FOR MONITORING RELAYS, SOFTWARE FOR MONITORING NETWORK ELECTRONIC STATUS, SOFTWARE FOR MONITORING SEQUENTIAL PROCESS AND PULSE COUNTERS, SOFTWARE FOR MONITORING INFRARED SENSORS AND RECEIVERS, SOFTWARE FOR MONITORING POWER USAGE, AND SOFTWARE FOR MONITORING HOME WIRING AND POWER LINE ELECTRONIC STATUS; SOFTWARE FOR USE IN HOME AND BUILDING AUTOMATION DATABASE MANAGEMENT; SOFTWARE FOR MONITORING DATA TRANSMISSION VIA A GLOBAL COMPUTER NETWORK, BY SATELLITE, RADIO TRANSMISSION, TELEVISION TRANSMISSION, AND BY ELECTRICAL POWER LINE, IN THE RESIDENTIAL COMMERCIAL BUILDING AUTOMATION FIELD, AND SOFTWARE FOR MONITORING DATA TRANSMISSION VIA A GLOBAL COMPUTER NETWORK, BY SATELLITE, RADIO TRANSMISSION, TELEVISION TRANSMISSION, AND BY ELECTRICAL POWER LINE, IN THE ELECTRICAL UTILITY MONITORING AND CONTROL INDUSTRIES; COMPUTER HARDWARE, NAMELY, COMPUTER BUSES AND COMPUTER BUS MONITORS; GATEWAY MODEMS FOR BROAD BAND AND NARROW BAND COMMUNICATIONS; NETWORK ELECTRONIC COMMUNICATIONS EQUIPMENT, NAMELY, MULTI-STATE SWITCHES, ADDRESSABLE SWITCHES, RELAYS, SEQUENTIAL PROCESS COUNTERS, PULSE COUNTERS, AND SIGNAL DETECTORS; COMPUTER ELECTRONIC STATUS EQUIPMENT, NAMELY, MULTI-STATE SWITCHES, ADDRESSABLE SWITCHES, SENSOR RELAYS, SEQUENTIAL PROCESS COUNTERS, PULSE COUNTERS, AND SIGNAL DETECTORS; INFRARED INTERFACE EQUIPMENT, NAMELY, INFRARED TRANSMITTERS, AND INFRARED RECEIVERS; SOFTWARE FOR BI-DIRECTIONAL DIGITAL TRANSFER OVER HOME WIRING AND A GLOBAL COMPUTER NETWORK FOR DETERMINING THE STATUS OF SWITCHES AND RELAYS IN THE FIELDS OF HOME AUTOMATION AND ELECTRICAL UTILITY MONITORING (U.S. CLS. 21, 23, 26, 36 AND 38).

CLASS 9—(Continued).

SN 76-073,072. FIDELITY TELEALARM, LLC, READING, PA. FILED 6-19-2000.

LOCATE 1

NO CLAIM IS MADE TO THE EXCLUSIVE RIGHT TO USE "LOCATE", APART FROM THE MARK AS SHOWN.
FOR EMERGENCY CALL UNIT USED TO LOCATE AND IDENTIFY PEOPLE WITHIN AN INFRASTRUCTURE (U.S. CLS. 21, 23, 26, 36 AND 38).
FIRST USE 3-0-1999; IN COMMERCE 3-0-1999.

SN 76-074,426. INTERFACE & CONTROL SYSTEMS, INC., COLUMBIA, MD. FILED 6-21-2000.



NO CLAIM IS MADE TO THE EXCLUSIVE RIGHT TO USE "OPEN CONTROL", APART FROM THE MARK AS SHOWN.

FOR COMPUTER SOFTWARE FOR USE IN REAL-TIME AUTONOMOUS SYSTEMS COMMAND AND CONTROL OF SPACECRAFT (U.S. CLS. 21, 23, 26, 36 AND 38).

SN 76-074,660. TELEOPTICA, INC., RICHARDSON, TX. FILED 6-21-2000.

ROUTE IQ

NO CLAIM IS MADE TO THE EXCLUSIVE RIGHT TO USE "ROUTE", APART FROM THE MARK AS SHOWN.

FOR COMPUTER SOFTWARE FOR USE IN ROUTING TRAFFIC THROUGH OPTICAL TELECOMMUNICATIONS NETWORKS AND DATA NETWORKS (U.S. CLS. 21, 23, 26, 36 AND 38).

SN 76-075,094. XELUS, INC, FAIRPORT, NY. FILED 6-22-2000.

XELUSPLAN

FOR COMPUTER SOFTWARE FOR PRIMARY SERVICE PARTS INVENTORY PLANNING, FORECASTING RETURNS, CALCULATING SCRAP YIELD, PLANNING UPGRADE PATHS FOR OLDER REVISIONS, SCHEDULING REPAIRS, TRACKING WORK IN PROCESS INVENTORIES, MODELING OF ALTERNATE SCENARIOS IN REAL TIME, AUTOMATICALLY PRESENTING ACTION ITEMS ACCORDING TO PRE-CONFIGURED BUSINESS RULES, AUTOMATICALLY RECOMMENDING PROBLEM RESOLUTION IN THE FIELDS OF AEROSPACE, UTILITIES, TELECOMMUNICATIONS, TRANSPORTATION AND COMPUTERS (U.S. CLS. 21, 23, 26, 36 AND 38).

CLASS 9—(Continued).

SN 76-075,097. XELUS, INC., FAIRPORT, NY. FILED 6-22-2000.

XELUSEXTEND

FOR COMPUTER SOFTWARE FOR STOCKING ANALYSIS, REPLENISHMENT AND DEPLOYMENT OF INVENTORY PARTS FOR AN EXTENDED LOGISTICS NETWORK, MATERIAL PLANNING, FORECASTING INVENTORY PARTS REQUIREMENTS, CREATING NEW PRODUCT INTRODUCTIONS, STOCKING, AND INTEGRATION WITH A SERVICE INVENTORY PLANNING SYSTEM IN THE FIELD OF PARTS IN THE AEROSPACE, UTILITIES, TELECOMMUNICATIONS, TRANSPORTATION AND COMPUTER FIELDS (U.S. CLS. 21, 23, 26, 36 AND 38).

SN 76-075,904. COPYRIGHT CLEARANCE CENTER, INC., DANVERS, MA. FILED 6-22-2000.

RIGHTSLINK

FOR COMPUTER PROGRAMS THAT MANAGE INFORMATION ABOUT RIGHTS AND COPYRIGHTED CONTENT, THAT MANAGE CUSTOMER ACCOUNTS, THAT CREATE AND BILL ORDERS, AND THAT DELIVER CONTENT TO CUSTOMERS IN MULTIPLE FORMATS, FOR USE IN THE LICENSING, RIGHTS MANAGEMENT, ASSIGNMENT AND BROKERAGE OF INTELLECTUAL PROPERTY (U.S. CLS. 21, 23, 26, 36 AND 38).

SN 76-075,917. COPYRIGHT CLEARANCE CENTER, INC., DANVERS, MA. FILED 6-22-2000.

BLUEMARK

FOR COMPUTER PROGRAMS THAT MANAGE INFORMATION ABOUT RIGHTS AND COPYRIGHTED CONTENT, THAT MANAGE CUSTOMER ACCOUNTS, THAT CREATE AND BILL ORDERS, AND THAT DELIVER CONTENT TO CUSTOMERS IN MULTIPLE FORMATS, FOR USE IN THE LICENSING, RIGHTS MANAGEMENT, ASSIGNMENT AND BROKERAGE OF INTELLECTUAL PROPERTY (U.S. CLS. 21, 23, 26, 36 AND 38).

SN 76-076,553. HOMESTORE.COM, INC., WESTLAKE VILLAGE, CA. BY ASSIGNMENT HOMEBID.COM, INC., SCOTTSDALE, AZ. FILED 6-23-2000.

HOMEBID.COM

FOR COMPUTER SOFTWARE FOR BUSINESS NEEDS ASSESSMENT, SOLUTION DEPLOYMENT, LISTING MANAGEMENT, OFFER MANAGEMENT, TRANSACTION MANAGEMENT, CLIENT MANAGEMENT, AUCTION MANAGEMENT, ESCROW MANAGEMENT, INFORMATION MANAGEMENT, PROJECT MANAGEMENT AND SERVICES MANAGEMENT, ALL FOR THE REAL ESTATE INDUSTRY, AND MANUALS SOLD THEREWITH (U.S. CLS. 21, 23, 26, 36 AND 38).

CLASS 9—(Continued).

SN 76-076,670. STARLIGHT RUNNER ENTERTAINMENT, INC., NEW YORK, NY. FILED 6-23-2000.

ACTION DRIVE SYSTEM

NO CLAIM IS MADE TO THE EXCLUSIVE RIGHT TO USE "DRIVE SYSTEM", APART FROM THE MARK AS SHOWN.

FOR COMPUTER SOFTWARE FOR THE DISTRIBUTION OF MEDIA CONTENT, NAMELY, PHOTOGRAPHS, DOCUMENTS, VIDEO AND AUDIO FILES, VIA THE INTERNET (U.S. CLS. 21, 23, 26, 36 AND 38).

SN 76-077,186. GASTEC CORPORATION, DBA GASTEC, AYASE-CITY, KANAGAWA, JAPAN, FILED 6-23-2000.

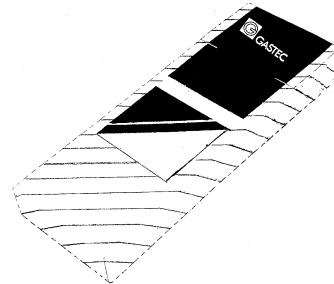

OWNER OF U.S. REG. NO. 999,959.

THE MARK CONSISTS OF THE TRADE DRESS FOR THE PACKAGING OF GAS DETECTOR TUBES, NAMELY, A WHITE CARDBOARD BOX THAT IS 2 INCHES WIDE, 5/8 INCHES DEEP AND 5 3/4 INCHES LONG, WHICH EXHIBITS NARROW STRIPES CROSSING THE WIDTH OF THE BOX AT AN ANGLE. THE TOP OF THE BOX IS SECURED BY PLACING THE TONGUE OF THE LID INTO A SLOT ON THE FRONT OF THE BOX. THE BOX EXHIBITS A DISTINCTIVE GREEN LABEL, WHICH PASSES OVER THE LID OF THE BOX AND COVERS MOST OF THE FRONT OF THE BOX. THE COLOR GREEN IS CLAIMED AS PART OF THE MARK.

SEC. 2(F).

FOR BREAKABLE TUBES FOR DETECTING TOXIC GAS (U.S. CLS. 21, 23, 26, 36 AND 38).

FIRST USE 1-1-1993; IN COMMERCE 1-1-1993.

SN 76-077,187. GASTEC CORPORATION, DBA GASTEC, AYASE-CITY, KANAGAWA 252-1103, JAPAN, FILED 6-23-2000.

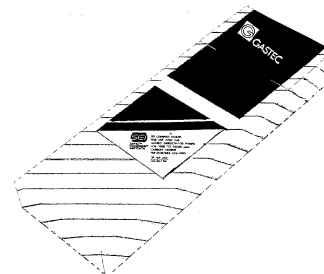

OWNER OF U.S. REG. NO. 999,959.

THE MARK CONSISTS OF THE TRADE DRESS FOR THE PACKAGING OF GAS DETECTOR TUBES, NAMELY, A WHITE CARDBOARD BOX THAT IS 2 INCHES WIDE, 5/8

CLASS 9—(Continued).

INCHES DEEP AND 5 3/4 INCHES LONG, WHICH EXHIBITS NARROW STRIPES CROSSING THE WIDTH OF THE BOX AT AN ANGLE. THE TOP OF THE BOX IS SECURED BY PLACING THE TONGUE OF THE LID INTO A SLOT ON THE FRONT OF THE BOX. THE BOX EXHIBITS A DISTINCTIVE GREEN LABEL, WHICH PASSES OVER THE LID OF THE BOX AND COVERS MOST OF THE FRONT OF THE BOX. THE COLOR GREEN IS CLAIMED AS PART OF THE MARK. PRINTED ON THE LABEL IS SAFETY EQUIPMENT INSTITUTE LANGUAGE.

SEC. 2(F).
FOR BREAKABLE TUBES FOR DETECTING TOXIC GAS (U.S. CLS. 21, 23, 26, 36 AND 38).
FIRST USE 1-1-1993; IN COMMERCE 1-1-1993.

SN 76-080,003. SILVERSTREAM SOFTWARE, INC., BILLERICA, MA. FILED 6-29-2000.

JPORTAL

FOR COMPUTER PROGRAMS FOR USE IN DESIGNING, DEVELOPING AND MAINTAINING WEBSITES (U.S. CLS. 21, 23, 26, 36 AND 38).

SN 76-080,343. WILLIAM OPTICS LTD. CO., TAIPEI, TAIWAN, FILED 6-29-2000.



NO CLAIM IS MADE TO THE EXCLUSIVE RIGHT TO USE "OPTICS", APART FROM THE MARK AS SHOWN.

FOR LENS, NAMELY, EYELASS LENS AND INTRAOCULAR LENS, PRISMS FOR SCIENTIFIC PURPOSES, MAGNIFIER, TELESCOPES, CONCAVE-CONVEX LENS, OPTICAL LENS, NIGHT ELECTRONIC TELESCOPES, EQUATORIAL TELESCOPES, EYEPIECES, NAMELY, EYEPIECES FOR TELESCOPES, ASTRONOMY TELESCOPES (U.S. CLS. 21, 23, 26, 36 AND 38).

FIRST USE 6-1-1998; IN COMMERCE 11-1-1998.

SN 76-083,385. OPINIONWARE.COM, WOODBURY, MN. FILED 7-5-2000.

ACTIVEOPINION

FOR COMPUTER SOFTWARE FOR GATHERING, ORGANIZING AND PROVIDING STATISTICAL INFORMATION OVER A GLOBAL COMPUTER NETWORK (U.S. CLS. 21, 23, 26, 36 AND 38).

FIRST USE 3-20-2000; IN COMMERCE 3-31-2000.

CLASS 9—(Continued).

SN 76-083,970. TECAN AG, CH8634 HOMBRECHTIKON, SWITZERLAND, FILED 7-6-2000.

TE-DOT

PRIORITY CLAIMED UNDER SEC. 44(D) ON SWITZERLAND APPLICATION NO. 04206/2000, FILED 4-7-2000, REG. NO. 476861, DATED 4-7-2000, EXPIRES 4-7-2010.

FOR ANALYTICAL DEVICES, NAMELY PIPETTERS AND DISPENSERS, MACHINES FOR LIQUID HANDLING; LABORATORY AUTOMATICS, NAMELY DEVICES FOR AUTOMATING THE STAINING OF BIOLOGICAL SPECIMENS, MICROPLATE PIPETTERS, MICROPLATE DISPENSERS AND MICROPLATE WASHERS; ANALYTICAL LABORATORY ROBOTS; AUTOMATIC PIPETTES; MICRO PUMPS, NAMELY METERING PUMPS AND VOLUMETRIC PUMPS; AND PIPETTES (U.S. CLS. 21, 23, 26, 36 AND 38).

SN 76-091,800. NETZER PRECISION MOTION SENSORS LTD., D.N. MISGAV, ISRAEL, FILED 7-17-2000.

ELECTRIC ENCODER

NO CLAIM IS MADE TO THE EXCLUSIVE RIGHT TO USE "ELECTRIC", APART FROM THE MARK AS SHOWN.

FOR SENSORS FOR MONITORING POSITION AND ANGLE FOR SERVOMOTORS (U.S. CLS. 21, 23, 26, 36 AND 38).

FIRST USE 2-0-1999; IN COMMERCE 2-0-1999.

SN 76-092,373. INSTITUTE FOR INFORMATION SCIENCES, INC., SAN FRANCISCO, CA. FILED 7-19-2000.

PRIVISEA

FOR ELECTRONIC ENCRYPTION UNITS, NAMELY MACHINES USED TO ENCRYPT DATA COMMUNICATIONS (U.S. CLS. 21, 23, 26, 36 AND 38).

SN 76-092,715. WESTELCOM COMMUNICATIONS, INC., WESTPORT, NY. FILED 7-21-2000.



THE WAVY LINE SHOWN IN THE DRAWING IS A FEATURE OF THE MARK AND IS NOT INTENDED TO INDICATE COLOR.

FOR COMPUTERS, COMMUNICATIONS SOFTWARE FOR CONNECTING COMPUTER NETWORK USERS (U.S. CLS. 21, 23, 26, 36 AND 38).

FIRST USE 12-1-1996; IN COMMERCE 12-1-1996.

CLASS 9—(Continued).

SN 76-092,727. INTERACTIVE DATA DEVELOPMENT, INC., DBA MARKETLIX SOLUTIONS, KNOXVILLE, TN. FILED 7-19-2000.

MARKETLIX.TEMPO

OWNER OF U.S. REG. NO. 2,405,014.
FOR COMPUTER SOFTWARE FOR USING AND MANAGING MULTIPLE LISTING SERVICE DATA IN THE FIELD OF REAL ESTATE (U.S. CLS. 21, 23, 26, 36 AND 38).

FIRST USE 6-21-2000; IN COMMERCE 6-21-2000.

SN 76-095,558. SEARS, ROEBUCK AND CO., HOFFMAN ESTATES, IL. FILED 7-24-2000.

SENS-A-CLEAN

FOR PROGRAMMABLE ELECTRONIC DEVICES USED ON GAS AND ELECTRIC OVENS AND RANGES FOR CONTROLLING THE SELF-CLEANING SETTINGS AND FEATURES ON AN OVEN (U.S. CLS. 21, 23, 26, 36 AND 38).

FIRST USE 5-0-2000; IN COMMERCE 5-0-2000.

SN 76-100,056. OBSCURA DIGITAL, L.L.C., WEST HOLLYWOOD, CA. FILED 7-31-2000.

OBSCURA DIGITAL

NO CLAIM IS MADE TO THE EXCLUSIVE RIGHT TO USE "DIGITAL", APART FROM THE MARK AS SHOWN.

FOR DIGITAL VIDEO CAPTURE CAMERA AND PROJECTION SYSTEM, COMPRISING A DIGITAL VIDEO CAPTURE CAMERA, A PROJECTOR AND COMPUTER SOFTWARE FOR USE IN THE CREATION, PROCESSING AND PROJECTION OF IMAGES (U.S. CLS. 21, 23, 26, 36 AND 38).

SN 76-100,080. OPTICAL SYSTEMS, LLC, NORTHPORT, NY. FILED 8-1-2000.

SEAGUIDE

FOR DEVICE FOR LOCATING HAZARDS AND OBSTACLES IN A MARINE ENVIRONMENT COMPRISED OF OPTICAL RECEIVERS, FLASH TUBES, LASERS, OPTICAL PRISMS, OPTICAL FILTERS, LIGHT DETECTORS, TIMERS, OPTICAL SCANNERS, ELECTRICAL SIGNAL PROCESSING CIRCUITRY, AND DEPTH AND RANGE INDICATORS (U.S. CLS. 21, 23, 26, 36 AND 38).

CLASS 9—(Continued).

SN 76-102,343. CAMBRIDGE AERO INSTRUMENTS, INC., WAITSFIELD, VT. FILED 8-3-2000.

Pocket
NAV

NO CLAIM IS MADE TO THE EXCLUSIVE RIGHT TO USE "POCKET" AND "NAV", APART FROM THE MARK AS SHOWN.

FOR AVIATION INSTRUMENTS, NAMELY, VARIOMETERS, NAVIGATION COMPUTERS, AND DATA STORAGE COMPACT FLASH MEMORY CARDS (U.S. CLS. 21, 23, 26, 36 AND 38).

SN 76-102,883. ORTHOPEDIC SYSTEMS, INC., UNION CITY, CA. FILED 8-3-2000.



OWNER OF U.S. REG. NO. 2,250,629.

FOR ANALYSIS SYSTEM, COMPRISED OF A MOTION FIELD GENERATOR AND SENSOR VEST, VIDEO CAMERAS, A WEIGHT SENSOR PLATFORM, AND COMPUTER SOFTWARE THAT CALCULATES THE GOLF SWING AND BALL FLIGHT DATA AND ALLOWS FOR THE RECALL OF DATA AND IMAGES IN THE FIELD OF GOLF INSTRUCTION AND ANALYSIS FOR GOLF EQUIPMENT (U.S. CLS. 21, 23, 26, 36 AND 38).

FIRST USE 12-5-1997; IN COMMERCE 12-5-1997.

SN 76-103,425. MEMORY COMPANY, THE, ATLANTA, GA. FILED 8-4-2000.

THE UNFAIR ADVANTAGE

FOR SERIES OF PRERECORDED EDUCATIONAL AUDIOTAPES FEATURING MEMORY TECHNIQUES (U.S. CLS. 21, 23, 26, 36 AND 38).

FIRST USE 5-0-1990; IN COMMERCE 5-0-1990.

CLASS 9—(Continued).

SN 76-104,275. DBC SMARTSOFTWARE INC., ONTARIO N2C 1L4, CANADA, FILED 8-7-2000.

AgriSMART

OWNER OF CANADA REG. NO. 444154, DATED 6-16-1995, EXPIRES 6-16-2010.

FOR SOFTWARE PROGRAMS MANAGING ACCOUNTS RECEIVABLE, ACCOUNTS PAYABLE, GENERAL LEDGER, INVENTORY, PRODUCTION, PRICING, ORDER ENTRY, ORDER INVOICING, SALES ANALYSIS, SALES COMMISSIONS, PURCHASING, AND SECURITY SYSTEMS FOR USE BY PRODUCERS, PROCESSORS AND MANUFACTURERS IN THE FEED, SEED, GRAIN, PREMIX, FLOUR, PET FOOD, EGG AND FERTILIZER INDUSTRIES (U.S. CLS. 21, 23, 26, 36 AND 38).

FIRST USE 1-0-1986; IN COMMERCE 8-0-1992.

SN 76-107,127. TURBINE ENTERTAINMENT SOFTWARE CORPORATION, WESTWOOD, MA. FILED 8-10-2000.



NO CLAIM IS MADE TO THE EXCLUSIVE RIGHT TO USE "ENTERTAINMENT SOFTWARE", APART FROM THE MARK AS SHOWN.

FOR COMPUTER GAME SOFTWARE; COMPUTER SOFTWARE FOR USE IN CREATING MULTIPLE-USER PERSISTENT VIRTUAL WORLDS (U.S. CLS. 21, 23, 26, 36 AND 38).

FIRST USE 5-0-1999; IN COMMERCE 5-0-1999.

SN 76-107,239. RUNCO INTERNATIONAL, HAYWARD, CA. FILED 8-9-2000.

VIVX

FOR VIDEO DISPLAY APPARATUS, NAMELY, VIDEO MONITORS, TELEVISION SETS AND VIDEO PROJECTORS (U.S. CLS. 21, 23, 26, 36 AND 38).

CLASS 9—(Continued).

SN 76-110,466. JAMES NEILL HOLDINGS LIMITED, SHEFFIELD S4 7QQ, ENGLAND, FILED 8-16-2000.



FOR MEASUREMENT INSTRUMENTS AND CALIBRATION DEVICES, NAMELY MICROMETERS; DEPTH GAUGES; CALIPERS; BORE GAUGES; DIAL INDICATORS; HEIGHT GAUGES; GAUGE BLOCKS; ENGINEERS LEVELS; SURFACE FINISH TESTERS; SCALE LUPES; MICROSCOPES; DUROMETERS; VEE-BLOCKS; MAGNETIC VEE-BLOCKS; ANGLE PLATES; ENGINEERS STRAIGHT EDGE, SQUARE, T-SQUARE, AND SLIDING T-SQUARE RULERS; CIRCUMFERENCE TAPE MEASURES; COMBINED MAGNETS AND MAGNIFYING LENSES; PROTRACTORS; COMBINATIONS SETS CONTAINING RULER, PROTRACTOR HEAD, SQUARE HEAD AND CENTER HEAD; SURFACE GAUGES; DIVIDERS; FEELER GAUGES AND STRIPS; ANGLE SETTING BLOCKS; PRECISION GRANITE BLOCKS (U.S. CLS. 21, 23, 26, 36 AND 38).

FIRST USE 0-0-1995; IN COMMERCE 0-0-1995.

SN 76-110,522. EPARK S.A., 75001 PARIS, FRANCE, FILED 8-16-2000.

MOBIPARK

PRIORITY CLAIMED UNDER SEC. 44(D) ON FRANCE APPLICATION NO. 003008122, FILED 2-17-2000, REG. NO. 003008122, DATED 2-17-2000, EXPIRES 2-17-2010.

FOR ELECTRONIC DEVICE WHICH UTILIZES A TELEPHONE, MOBILE OR LAND LINE, FOR ALLOCATING PARKING FEES TO ENTITIES, NAMELY, PUBLIC ENTITIES SUCH AS CITIES AND MUNICIPALITIES (U.S. CLS. 21, 23, 26, 36 AND 38).

SN 76-110,685. NUVIEW, INC., WALTHAM, MA. FILED 8-17-2000.

MYHRIS

FOR INDEXING SOFTWARE USED FOR INDEXING AND CROSS-REFERENCING OF INTERCONNECTED INFORMATION AND FOR THE RETRIEVAL OF INFORMATION FROM DATABASES IN THE FIELD OF HUMAN RESOURCES (U.S. CLS. 21, 23, 26, 36 AND 38).

FIRST USE 2-15-1999; IN COMMERCE 2-15-1999.

CLASS 9—(Continued).

SN 76-110,738. POCRASS, ALAN L., NEWBURY PARK, CA. FILED 8-15-2000.

XMULTIPLE

FOR ELECTRICAL, ELECTRONIC AND FIBEROPTICS CONNECTORS FOR DATA, TELEPHONE, CABLE, TELEVISION AND COMPUTERS, NAMELY, RJ CONNECTORS, COAXIAL CONNECTORS, COAXIAL AND FLAT-RIBBON INTERCONNECT SYSTEMS AND ETHERNET SWITCHES (U.S. CLS. 21, 23, 26, 36 AND 38).

FIRST USE 6-25-2000; IN COMMERCE 6-30-2000.

SN 76-112,607. IQ4HIRE, INC., CHICAGO, IL. FILED 8-18-2000.

IQ4HIRE

FOR DOWNLOADABLE COMPUTER SOFTWARE TO ALLOW USERS TO PERFORM ELECTRONIC BUSINESS TRANSACTIONS VIA THE INTERNET (U.S. CLS. 21, 23, 26, 36 AND 38).

FIRST USE 3-1-2000; IN COMMERCE 3-1-2000.

SN 76-113,339. NOVIGEN SCIENCES, INC., WASHINGTON, DC. FILED 8-18-2000.

**DEEM DIETARY EXPOSURE
EVALUATION MODEL**

NO CLAIM IS MADE TO THE EXCLUSIVE RIGHT TO USE "DIETARY EXPOSURE EVALUATION MODEL", APART FROM THE MARK AS SHOWN.

FOR COMPUTER SOFTWARE FOR USE IN FOOD ANALYSIS AND EVALUATION OF FOOD CONSUMPTION, AND USER MANUALS SOLD AS A UNIT THEREWITH (U.S. CLS. 21, 23, 26, 36 AND 38).

FIRST USE 12-31-1996; IN COMMERCE 3-22-1997.

SN 76-117,686. STORED ENERGY SYSTEMS, LONGMONT, CO. FILED 8-28-2000.

STORED ENERGY SYSTEMS

SEC. 2(F).

FOR INDUSTRIAL BATTERY CHARGERS (U.S. CLS. 21, 23, 26, 36 AND 38).

FIRST USE 0-0-1971; IN COMMERCE 0-0-1971.

CLASS 9—(Continued).

SN 76-117,858. OHIO MEDICAL INSTRUMENT COMPANY, INC., CINCINNATI, OH. FILED 8-28-2000.



OWNER OF U.S. REG. NOS. 1,500,409 AND 1,808,988.

NO CLAIM IS MADE TO THE EXCLUSIVE RIGHT TO USE "PRODUCT TECHNOLOGY", APART FROM THE MARK AS SHOWN.

FOR COMPUTER SOFTWARE FOR STORING, RETRIEVING AND DISPLAYING DATABASES CONCERNING MEDICAL AND SURGICAL EQUIPMENT AND DEVICES, NAMELY, MANUALS CONTAINING PRODUCT SPECIFICATIONS, INSTALLATION, OPERATION AND SERVICE MANUALS, AND COMPONENT PART AND PRICING MANUALS (U.S. CLS. 21, 23, 26, 36 AND 38).

FIRST USE 9-1-2000; IN COMMERCE 9-1-2000.

SN 76-118,107. FUJITSU LIMITED, KAWASAKI-SHI, KANAGAWA-KEN, JAPAN, FILED 8-25-2000.

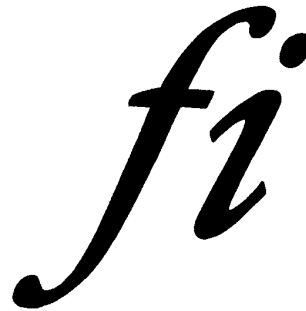

THE MARK CONSISTS OF THE STYLIZED LETTERS "F" AND "I".

FOR OPTICAL SCANNERS, PHOTOCOPYING MACHINES AND COMPUTER PRINTERS (U.S. CLS. 21, 23, 26, 36 AND 38).

SN 76-120,214. SIERRA DESIGN GROUP, RENO, NV. FILED 8-25-2000.

BLAST

FOR GAMING EQUIPMENT, NAMELY, SLOT MACHINES WITH OR WITHOUT A VIDEO OUTPUT, ELECTRO-MECHANICAL GAMING EQUIPMENT AND ELECTRONIC GAMING EQUIPMENT (U.S. CLS. 21, 23, 26, 36 AND 38).

FIRST USE 7-18-2000; IN COMMERCE 7-18-2000.

CLASS 9—(Continued).

SN 76-121,215. SCAPEWARE 3D, L.L.C. CHANHASSEN, MN. FILED 9-1-2000.



NO CLAIM IS MADE TO THE EXCLUSIVE RIGHT TO USE "FORECAST", APART FROM THE MARK AS SHOWN. FOR COMPUTER HARDWARE AND COMPUTER SOFTWARE FOR RENDERING WEATHER FORECASTS (U.S. CLS. 21, 23, 26, 36 AND 38).

SN 76-122,718. POLYTRONICS TECHNOLOGY CORP., HSINCHU, TAIWAN, FILED 9-1-2000.

POLYTRONICS TECHNOLOGY

NO CLAIM IS MADE TO THE EXCLUSIVE RIGHT TO USE "TECHNOLOGY", APART FROM THE MARK AS SHOWN. FOR VARIABLE RESISTORS, NAMELY, POLYMER POSITIVE COEFFICIENT RESISTORS (U.S. CLS. 21, 23, 26, 36 AND 38).

SN 76-122,734. HABER, DAVID, REDONDO BEACH, CA. FILED 9-6-2000.

ACES AND FACES

FOR GAMING EQUIPMENT, NAMELY, A GAMING MACHINE WITH VIDEO OUTPUT (U.S. CLS. 21, 23, 26, 36 AND 38).

SN 76-123,185. SCHAFER, MAX, LOS ANGELES, CA. FILED 9-5-2000.

YOUNG AUTHORS

NO CLAIM IS MADE TO THE EXCLUSIVE RIGHT TO USE "AUTHORS", APART FROM THE MARK AS SHOWN. FOR WRITING AND ILLUSTRATING SOFTWARE PROGRAM WHICH PROVIDES CHILDREN PAINTING TOOLS, REFERENCE TOOLS, AND WRITING TOOLS TO CREATE 25 KINDS OF COMPUTER BOOKS IN ENGLISH OR SPANISH (U.S. CLS. 21, 23, 26, 36 AND 38). FIRST USE 9-15-1992; IN COMMERCE 9-15-1992.

CLASS 9—(Continued).

SN 76-129,600. BUFFER, MICHAEL, LOS ANGELES, CA. FILED 9-13-2000.

READY TO RUMBLE

OWNER OF U.S. REG. NOS. 1,904,692, 2,416,799 AND OTHERS. FOR COMPUTER GAME SOFTWARE, CARTRIDGES, CASSETTES AND DISCS; INTERACTIVE MULTIMEDIA COMPUTER GAME PROGRAMS; AND PRERECORDED COMPACT DISCS, AUDIO AND VIDEOCASSETTES, AND AUDIO, VIDEO AND COMPUTER DISCS FEATURING MUSIC AND OTHER PRE-RECORDED SOUNDS (U.S. CLS. 21, 23, 26, 36 AND 38).

SN 76-132,309. MEDICALIS USA, INC., ATLANTA, GA. FILED 9-21-2000.

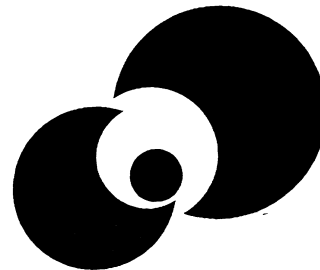

FOR COMPUTER SOFTWARE WHICH RETRIEVES AND ORGANIZES DATA FROM MULTIPLE SOURCES IN THE FIELD OF BUSINESS (U.S. CLS. 21, 23, 26, 36 AND 38).

SN 76-132,779. SOLID STATE MEASUREMENTS, INC., PITTSBURGH, PA. FILED 9-21-2000.

FASTGUARD

FOR ELECTRONIC APPARATUS FOR MEASURING THE ELECTRICAL PROPERTIES OF SEMICONDUCTOR WAFERS (U.S. CLS. 21, 23, 26, 36 AND 38).

SN 76-135,896. FAUNTLEROY, THOMAS, COURT WALL, NJ. FILED 9-26-2000.

CDISKERS

FOR HOLDERS FOR COMPACT DISCS (U.S. CLS. 21, 23, 26, 36 AND 38).

CLASS 9—(Continued).

SN 76-136,249. HONEYWELL INTERNATIONAL INC., MORRISTOWN, NJ. FILED 9-28-2000.

ENVIRACOM

FOR COMPUTER SOFTWARE AND HARDWARE FOR USE IN INTERCONNECTING HVAC EQUIPMENT, CONTROLLERS AND CONTROL PANELS FOR RESIDENTIAL AND COMMERCIAL MARKETS (U.S. CLS. 21, 23, 26, 36 AND 38).

SN 76-136,713. RADWARE LTD., TEL-AVIV, ISRAEL, FILED 9-27-2000.

CertainT

FOR COMPUTER HARDWARE AND COMPUTER SOFTWARE FOR OFF LOADING OF CPU INTENSIVE SECURE SOCKET LAYER (SSL) CALCULATIONS (U.S. CLS. 21, 23, 26, 36 AND 38).

SN 76-138,572. FITNESS QUEST INC., CANTON, OH. FILED 10-2-2000.

GOT IT!

FOR HANDHELD DIGITAL AUDIO RECORDERS (U.S. CLS. 21, 23, 26, 36 AND 38).

SN 76-139,188. MARKETSWITCH CORPORATION, STERLING, VA. FILED 10-3-2000.

**TRUE FOR OUTBOUND
MARKETING**

NO CLAIM IS MADE TO THE EXCLUSIVE RIGHT TO USE "OUTBOUND MARKETING", APART FROM THE MARK AS SHOWN.

FOR COMPUTER SOFTWARE THAT PLANS, ORGANIZES, AND MANAGES MARKETING CAMPAIGNS CONDUCTED VIA DIRECT MAIL, ELECTRONIC MAIL, OR TELEPHONE MARKETING (U.S. CLS. 21, 23, 26, 36 AND 38).

CLASS 9—(Continued).

SN 76-139,190. MARKETSWITCH CORPORATION, STERLING, VA. FILED 10-3-2000.

**TRUE FOR WEB
ADVERTISING**

NO CLAIM IS MADE TO THE EXCLUSIVE RIGHT TO USE "WEB ADVERTISING", APART FROM THE MARK AS SHOWN.

FOR COMPUTER SOFTWARE THAT IDENTIFIES SPECIFIC ADVERTISING FROM AN ADVERTISING POOL FOR PLACEMENT ON A GLOBAL COMPUTER INFORMATION NETWORK USING CUSTOMER BEHAVIOR INFORMATION, CUSTOMER AVERAGES, AND OTHER DATA SUPPLIED BY MODELING SOFTWARE (U.S. CLS. 21, 23, 26, 36 AND 38).

SN 76-142,549. E. O. LAB, INC., PITTSFORD, NY. FILED 10-6-2000.

SCRATCH BE GONE

FOR EYEGLASS REPAIR KITS COMPOSED OF POLISHING PENCILS AND EYEGLASS BUFFING CLOTHS (U.S. CLS. 21, 23, 26, 36 AND 38).

FIRST USE 9-1-2000; IN COMMERCE 9-1-2000.

SN 76-144,639. URCHOICE ELECTRONICS, INC., SAN JOSE, CA. FILED 10-11-2000.



FOR COMPUTER HARDWARE AND PERIPHERALS, NAMELY VIDEO GRAPHIC ADAPTER CARDS, SOUND CARDS, MP-3 PLAYERS, MEMORY CHIPS AND MEMORY MODULES (U.S. CLS. 21, 23, 26, 36 AND 38).

FIRST USE 11-1-1998; IN COMMERCE 11-1-1998.

SN 76-144,641. URCHOICE ELECTRONICS, INC., SAN JOSE, CA. FILED 10-11-2000.

PALITDAYTONA

FOR COMPUTER HARDWARE AND PERIPHERALS, NAMELY VIDEO GRAPHIC ADAPTER CARDS, SOUND CARDS, MP-3 PLAYERS, MEMORY MEMORY CHIPS AND EMORY MODULES (U.S. CLS. 21, 23, 26, 36 AND 38).

FIRST USE 9-1-2000; IN COMMERCE 9-1-2000.

CLASS 9—(Continued).

SN 76-149,185. HER INTERACTIVE, INC., BELLEVUE, WA.
FILED 10-18-2000.

FOR GIRLS WHO AREN'T AFRAID OF A MOUSE

FOR INTERACTIVE VIDEO GAMES OF VIRTUAL REALITY COMPRISING COMPUTER HARDWARE AND SOFTWARE (U.S. CLS. 21, 23, 26, 36 AND 38).
FIRST USE 9-15-1998; IN COMMERCE 9-15-1998.

SN 76-150,080. MEDIA SOLUTIONS (PVT.) LTD., COLOMBO 5, SRI LANKA, FILED 10-19-2000.



NO CLAIM IS MADE TO THE EXCLUSIVE RIGHT TO USE "BIZOA" AND ".COM", APART FROM THE MARK AS SHOWN.

FOR COMPUTER SOFTWARE FOR USE IN PROVIDING (1) PERSONAL INFORMATION MANAGER FUNCTIONALITY, NAMELY ELECTRONIC CALENDAR, SCHEDULING, AND BOOKMARKING CAPABILITIES, AND DATABASES FOR CREATING, STORING, AND UPDATING CONTACT INFORMATION, ELECTRONIC MAIL MESSAGES, FACSIMILE TRANSMISSIONS, EXPENSE AND ACCOUNTING INFORMATION, AND USER NOTES; AND (2) ELECTRONIC COMMUNICATIONS FUNCTIONALITY, NAMELY ALLOWING USERS TO COMMUNICATE USING ELECTRONIC MAIL COMMUNICATIONS, FACSIMILE TRANSMISSIONS, INSTANT ELECTRONIC MESSAGING, ELECTRONIC CONFERENCING, ELECTRONIC CHAT ROOM COMMUNICATIONS, THREADED MESSAGES, DOCUMENT SHARING AND AUDIO AND VIDEO SIGNAL STREAMING, ALL THROUGH A LOCAL OR GLOBAL COMPUTER OR TELECOMMUNICATIONS NETWORK USING BOTH LAND-LINE AND WIRELESS TELECOMMUNICATIONS TRANSMISSION METHODS (U.S. CLS. 21, 23, 26, 36 AND 38).
FIRST USE 9-1-2000; IN COMMERCE 9-1-2000.

SN 76-150,483. VSI ENTERPRISES, INC., NORCROSS, GA.
FILED 10-19-2000.

ONGOER

FOR COMPUTER HARDWARE, SOFTWARE AND CONTROL SYSTEM COMPRISED OF SOFTWARE, MULTISTACK KERNELS, AUDIO-VISUAL CONTROLS AND HARDWARE EQUIPMENT FOR ENHANCED REAL-TIME TELECONFERENCING AND VIDEOCONFERENCING AND SUPPORTING TECHNICAL DOCUMENTS (U.S. CLS. 21, 23, 26, 36 AND 38).
FIRST USE 8-29-2000; IN COMMERCE 8-29-2000.

CLASS 9—(Continued).

SN 76-152,326. MINDNHEALTH.COM, INC., TUCSON, AZ.
FILED 10-23-2000.

TERRAMED

FOR COMPUTER SOFTWARE FOR USE IN THE MANAGEMENT OF MEDICAL CARE PRACTICES, NAMELY, SOFTWARE FOR RECORD KEEPING OF PATIENT MEDICAL HISTORY, PERSONAL INFORMATION, BILLING, AND FOR ACCESSING MEDICATION AND DIAGNOSTIC DATABASES (U.S. CLS. 21, 23, 26, 36 AND 38).

SN 76-153,192. VERTICAL ALLIANCE, INC., PLYMOUTH MEETING, PA. FILED 10-24-2000.

VERTICAL TRACKER

FOR COMPUTER SOFTWARE FOR USE TO IDENTIFY, INFORM AND EXCHANGE INFORMATION WITH THIRD PARTIES IN THE FIELD OF E-COMMERCE (U.S. CLS. 21, 23, 26, 36 AND 38).
FIRST USE 9-0-1999; IN COMMERCE 9-0-1999.

SN 76-153,855. MOTIVE COMMUNICATIONS, INC., AUSTIN, TX. FILED 10-25-2000.

MOTIVE STUDIO

NO CLAIM IS MADE TO THE EXCLUSIVE RIGHT TO USE "STUDIO", APART FROM THE MARK AS SHOWN.
FOR COMPUTER SOFTWARE, NAMELY, SOFTWARE FOR DOWNLOADING, CREATING, CUSTOMIZING, AND PUBLISHING, CUSTOMER SERVICE AND TECHNICAL SUPPORT RELATED INFORMATION, AND SOFTWARE FOR CUSTOMIZING, DOWNLOADING, AND CREATING SOFTWARE FOR USE IN PROVIDING ONLINE CUSTOMER SERVICE AND TECHNICAL SUPPORT TO COMPUTER USERS (U.S. CLS. 21, 23, 26, 36 AND 38).
FIRST USE 7-0-1999; IN COMMERCE 7-0-1999.

SN 76-154,507. GABRIEL ELECTRONICS INCORPORATED, SCARBOROUGH, ME. FILED 10-26-2000.

GABRIEL ELECTRONICS

NO CLAIM IS MADE TO THE EXCLUSIVE RIGHT TO USE "ELECTRONICS", APART FROM THE MARK AS SHOWN.
FOR ANTENNAS; ANTENNA SUB-ASSEMBLY, NAMELY, ANTENNA MOUNTS AND MOUNTING EQUIPMENT FOR USE THEREWITH; AND ANCILLARY TRANSMISSION EQUIPMENT, NAMELY, ANTENNA WAVEGUIDE, ANTENNA CABLES AND CONNECTORS FOR USE THEREWITH (U.S. CLS. 21, 23, 26, 36 AND 38).
FIRST USE 0-0-1951; IN COMMERCE 0-0-1951.

CLASS 9—(Continued).

SN 76-155,044. IRIDIAN TECHNOLOGIES, INC., MARLTON, NJ. FILED 10-27-2000.



The logo for "privateid" features the word "private" in a lowercase, sans-serif font, followed by "id" in a bold, lowercase, sans-serif font. The "id" is enclosed within a circular graphic element that resembles a stylized eye or a lens.

NO CLAIM IS MADE TO THE EXCLUSIVE RIGHT TO USE "ID", APART FROM THE MARK AS SHOWN.

FOR BIOMETRIC IDENTIFICATION EQUIPMENT, NAMELY, OPTICAL INPUT AND OUTPUT DEVICES FOR THE VERIFICATION OF THE IDENTITY OF PEOPLE OR ANIMALS, AND FOR THE IDENTIFICATION OF PEOPLE OR ANIMALS; COMPUTER SOFTWARE FOR THE VERIFICATION OF THE IDENTITY OF PEOPLE OR ANIMALS AND FOR THE IDENTIFICATION OF PEOPLE OR ANIMALS (U.S. CLS. 21, 23, 26, 36 AND 38).

SN 76-155,155. MIXED SIGNALS TECHNOLOGIES, INC., CULVER CITY, CA. FILED 10-27-2000.

SPIKE

FOR COMPUTER HARDWARE, NAMELY, SERVERS FOR USE IN THE FIELD OF INTERACTIVE TELEVISION AND TELEVISION BROADCASTING; COMPUTER SOFTWARE FOR PROVIDING INTERACTIVE TELEVISION PROGRAMMING (U.S. CLS. 21, 23, 26, 36 AND 38).

SN 76-155,970. PHE, INC., HILLSBOROUGH, NC. FILED 10-24-2000.

ADAM & EVE PRODUCTIONS

OWNER OF U.S. REG. NOS. 1,020,448, 1,959,674 AND OTHERS.

NO CLAIM IS MADE TO THE EXCLUSIVE RIGHT TO USE "PRODUCTIONS", APART FROM THE MARK AS SHOWN.

FOR VIDEO RECORDINGS FEATURING ADULT ENTERTAINMENT (U.S. CLS. 21, 23, 26, 36 AND 38).
FIRST USE 5-0-1996; IN COMMERCE 5-0-1996.

CLASS 9—(Continued).

SN 76-157,408. SAMSUNG ELECTRONICS CO., LTD., SUWON-CITY, KYUNGKI-DO, REPUBLIC OF KOREA, FILED 11-2-2000.



The logo for "izzzi Pad" features a stylized lowercase "i" followed by "zzzi" in a bold, lowercase, sans-serif font. Below "zzzi" is the word "Pad" in a smaller, lowercase, sans-serif font. The "i" is enclosed within a circular graphic element that resembles a stylized eye or a lens.

NO CLAIM IS MADE TO THE EXCLUSIVE RIGHT TO USE "PAD", APART FROM THE MARK AS SHOWN.

FOR PORTABLE COMPUTERS, NOTEBOOK COMPUTERS (U.S. CLS. 21, 23, 26, 36 AND 38).

SN 76-160,194. STI LICENSING CORPORATION, MAYFIELD HEIGHTS, OH. FILED 11-6-2000.

AV-NBC SHROUD

NO CLAIM IS MADE TO THE EXCLUSIVE RIGHT TO USE "SHROUD", APART FROM THE MARK AS SHOWN.

FOR PROTECTIVE CLOTHING, NAMELY, A PROTECTIVE SHROUD COMPRISED OF A POLYMERIC CLOTHING MATERIAL FOR USE WITH A FACE MASK TO PROTECT THE USER OF THE FACE MASK AGAINST NUCLEAR, BIOLOGICAL AND/OR CHEMICAL (NBC) CONTAMINATION (U.S. CLS. 21, 23, 26, 36 AND 38).

FIRST USE 8-25-2000; IN COMMERCE 8-25-2000.

SN 76-160,408. TERADYNE, INC., BOSTON, MA. FILED 11-4-2000.

VHDM HSD

OWNER OF U.S. REG. NO. 2,423,664.
NO CLAIM IS MADE TO THE EXCLUSIVE RIGHT TO USE "HSD", APART FROM THE MARK AS SHOWN.

FOR ELECTRICAL CONNECTORS (U.S. CLS. 21, 23, 26, 36 AND 38).

CLASS 9—(Continued).

SN 76-160,821. GRAVITATE, INC., SOUTH SAN FRANCISCO, CA. FILED 11-7-2000.

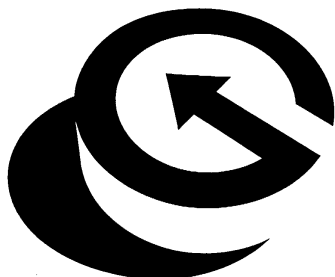

THE MARK CONSISTS, IN PART, OF THE LETTER "G" IN STYLIZED FORM.

FOR COMPUTER SOFTWARE PLATFORM COMPRISING A DATABASE, SOFTWARE FOR EFFICIENTLY MANAGING AND TRACKING THE LOCATION OF MOBILE OBJECTS, SOFTWARE FOR AUTOMATICALLY TRIGGERING ACTIONS UPON THE HAPPENING OF EVENTS, AND AN APPLICATION PROGRAMMING INTERFACE FOR ENABLING THIRD PARTIES TO UTILIZE SAID SOFTWARE PLATFORM TO DEVELOP SOFTWARE APPLICATIONS THAT UTILIZE THE GEOGRAPHIC POSITION OF A MOBILE DEVICE, FOR USE IN THE FIELD OF WIRELESS COMMUNICATION SERVICES; COMPUTER SOFTWARE APPLICATION THAT UTILIZE THE GEOGRAPHIC POSITION OF A MOBILE DEVICE FOR USE IN THE FIELD OF WIRELESS COMMUNICATIONS SERVICES (U.S. CLS. 21, 23, 26, 36 AND 38).

SN 76-162,405. EMERGISOFT HOLDING, INC., ARLINGTON, TX. FILED 11-13-2000.

EMERGISOFT

FOR COMPUTER SOFTWARE FOR USE TO MANAGE MEDICAL PATIENT DATA IN EMERGENCY DEPARTMENTS (U.S. CLS. 21, 23, 26, 36 AND 38).
FIRST USE 9-11-1988; IN COMMERCE 9-11-1988.

SN 76-170,509. WEB-SEARCH.COM, INC., YARMOUTH, ME. FILED 11-22-2000.

MRFILES

FOR COMPUTER SOFTWARE TO CREATE SEARCHABLE DATABASES OF WEB SITES AND BRANDS (U.S. CLS. 21, 23, 26, 36 AND 38).
FIRST USE 6-7-2000; IN COMMERCE 11-6-2000.

CLASS 9—(Continued).

SN 76-172,539. TERAGLOBAL COMMUNICATIONS CORP., SAN DIEGO, CA. FILED 11-29-2000.

TERAVIDEO

OWNER OF U.S. REG. NOS. 2,325,739 AND 2,402,640.
FOR COMPUTER HARDWARE AND SOFTWARE FOR MULTIMEDIA COMMUNICATIONS AND NETWORKS, NAMELY, COMPUTERS, MONITORS, PROJECTORS, KEYBOARDS, FINGERPRINT SCANNERS, CAMERAS, MICROPHONES, SWITCHES, TRANSMITTERS, SERVERS, TERMINALS, UTILITY CONCENTRATORS, POWER SUPPLIES, ENCODERS AND SOFTWARE THEREFOR; AND INSTRUCTION MANUALS SOLD THEREWITH (U.S. CLS. 21, 23, 26, 36 AND 38).

SN 76-172,663. TERAGLOBAL COMMUNICATIONS CORP., SAN DIEGO, CA. FILED 11-29-2000.

TERAAUDIO

OWNER OF U.S. REG. NOS. 2,325,739 AND 2,402,640.
FOR COMPUTER HARDWARE AND SOFTWARE FOR MULTIMEDIA COMMUNICATIONS AND NETWORKS, NAMELY, COMPUTERS, MONITORS, PROJECTORS, KEYBOARDS, FINGERPRINT SCANNERS, CAMERAS, MICROPHONES, SWITCHES, TRANSMITTERS, SERVERS, TERMINALS, UTILITY CONCENTRATORS, POWER SUPPLIES, ENCODERS AND SOFTWARE THEREFOR; AND INSTRUCTION MANUALS SOLD THEREWITH (U.S. CLS. 21, 23, 26, 36 AND 38).

SN 76-172,955. TANJIAN TECHNOLOGIES, INC., CAPITOLA, CA. BY MERGER WEBKAPTURE, INC., CAPITOLA, CA. FILED 11-29-2000.

TANJIAN TECHNOLOGIES

NO CLAIM IS MADE TO THE EXCLUSIVE RIGHT TO USE "TECHNOLOGIES", APART FROM THE MARK AS SHOWN.

FOR COMPUTER SOFTWARE FOR INCREASING EFFICIENCY, CAPACITY AND PERFORMANCE OF INTERNET COMMUNICATION, DATA TRANSMISSION AND DATA STORAGE APPLICATIONS (U.S. CLS. 21, 23, 26, 36 AND 38).

SN 76-173,051. BEST FRIENDS FOUNDATION, WASHINGTON, DC. FILED 11-30-2000.

BEST FRIENDS

OWNER OF U.S. REG. NOS. 1,884,771, 1,889,734 AND OTHERS.

FOR COMPUTER SOFTWARE FOR USE IN CONDUCTING AN EDUCATIONAL PROGRAM FOR ADOLESCENTS IN THE 5TH THROUGH 12TH GRADES, DESIGNED TO FOSTER SELF-RESPECT AND PROMOTE RESPONSIBLE BEHAVIOR (U.S. CLS. 21, 23, 26, 36 AND 38).

CLASS 9—(Continued).

SN 76-175,112. JOHNSON LEVEL & TOOL MFG. CO., INC., MEQUON, WI. FILED 12-4-2000.

PLUMB SCOPE

NO CLAIM IS MADE TO THE EXCLUSIVE RIGHT TO USE "PLUMB", APART FROM THE MARK AS SHOWN, FOR HAND TOOLS, NAMELY PLUMB LEVELS (U.S. CLS. 21, 23, 26, 36 AND 38).

SN 76-178,411. EXECUTIVE MARKETING, INC., NEWPORT BEACH, CA. FILED 12-8-2000.

CLICK-N-FRAME

FOR ELECTRICAL AND ELECTRONIC SWITCH AND DISPLAY PRODUCTS, NAMELY, ELECTRICAL DISPLAY PANELS FOR THE DISPLAY OF DIGITAL IMAGES (U.S. CLS. 21, 23, 26, 36 AND 38).

SN 76-180,068. EVEREST CONNECTIONS CORPORATION, O'FALLON, MO. FILED 12-13-2000.



FOR OPERATIONAL SUPPORT SOFTWARE; NAMELY, SOFTWARE TO PROVIDE CUSTOMER CARE AND BILLING USAGE RATE FOR TELEPHONE, CABLE AND INTERNET COMPANIES (U.S. CLS. 21, 23, 26, 36 AND 38).

SN 76-180,951. PROTO-POWER CORPORATION, GROTON, CT. FILED 12-14-2000.

MODELYTICS

FOR COMPUTER PROGRAM RECORDED ON A DISC FOR DESIGNING A POWER GENERATING STATION OR A CHEMICAL PROCESSING PLANT INCLUDING THE SELECTION OF APPROPRIATE COMPONENTS, PUMPS, VALVES, HEAT, EXCHANGE UNITS, AIR COOLERS, FANS, DUCTS AND PIPES THEREFOR (U.S. CLS. 21, 23, 26, 36 AND 38).

CLASS 9—(Continued).

SN 76-181,248. METROLOGIC INSTRUMENTS, INC., BLACKWOOD, NJ. FILED 12-15-2000.

VOYAGERCG

OWNER OF U.S. REG. NO. 2,356,251. FOR HAND-HELD LASER BAR CODE SYMBOL SCANNERS FOR SCANNING AND READING BAR CODE SYMBOLS (U.S. CLS. 21, 23, 26, 36 AND 38). FIRST USE 6-22-2000; IN COMMERCE 6-22-2000.

SN 76-181,869. TOP LAYER NETWORKS, INC., WESTBORO, MA. FILED 12-15-2000.

APPBALANCING

FOR COMPUTER HARDWARE, NAMELY, A SERVER FARM SWITCH FOR MONITORING AND ROUTING THE MOVEMENT OF TRAFFIC WITHIN A SWITCH BASED NETWORK, AND FOR LOAD BALANCING MULTIPLE APPLICATIONS; COMPUTER SOFTWARE, NAMELY, SOFTWARE RUNNING ON A SERVER FARM SWITCH FOR MONITORING AND ROUTING THE MOVEMENT OF TRAFFIC WITHIN A SWITCH BASED NETWORK, AND FOR LOAD BALANCING MULTIPLE APPLICATIONS (U.S. CLS. 21, 23, 26, 36 AND 38).

SN 76-186,046. COMPANIONS, INC., WESTERN SPRINGS, IL. FILED 12-22-2000.

AUNT MARY'S STORYBOOK PROJECT

NO CLAIM IS MADE TO THE EXCLUSIVE RIGHT TO USE "STORYBOOK PROJECT", APART FROM THE MARK AS SHOWN.

FOR AUDIO-VISUAL MATERIALS, NAMELY, PRE-RECORDED AUDIO TAPES, VIDEOTAPES AND CDS CONTAINING PRE-RECORDED AUDIO AND VIDEO MESSAGES TO FACILITATE COMMUNICATION BETWEEN PERSONS (U.S. CLS. 21, 23, 26, 36 AND 38).

FIRST USE 11-15-1999; IN COMMERCE 11-15-1999.

CLASS 9—(Continued).

SN 76-187,009. NETABACUS CORPORATION, SAN FRANCISCO, CA. FILED 12-27-2000.

RIVIO WORK FLOWS

FOR COMPUTER SOFTWARE AND DOWNLOADABLE COMPUTER SOFTWARE AND MANUALS SUPPLIED THEREWITH FOR USE IN THE ACQUISITION, TRACKING, AND PAYMENT OF GOODS AND SERVICES; TO ALLOW USERS TO CONDUCT ELECTRONIC BUSINESS TRANSACTIONS VIA COMPUTER NETWORKS, COMMUNICATIONS NETWORKS, AND THE INTERNET; ACCOUNTING; DATA MANAGEMENT AND DATABASE MANAGEMENT; DOCUMENT PROCESSING; ELECTRONIC MAIL; ELECTRONIC TRANSMISSION OF DATA; INVENTORY MANAGEMENT; ORGANIZER, CALENDARING, AND SCHEDULING; PAYROLL; PRESENTATION GRAPHICS SOFTWARE AND UTILITY SOFTWARE FOR USE THEREWITH; PROJECT MANAGEMENT AND PROJECT SCHEDULING; SPREADSHEETS; WORD PROCESSING; WORK-GROUP DATA SHARING AND COMMUNICATIONS; COMPUTER HARDWARE, COMPUTER PERIPHERALS, AND MANUALS SUPPLIED THEREWITH (U.S. CLS. 21, 23, 26, 36 AND 38).

SN 76-188,166. MOTTO CITIZENS, LLC, DENMARK, ME. FILED 12-24-2000.

(W)HOLE

FOR MUSICAL SOUND RECORDINGS AND EDUCATIONAL SOFTWARE, AUDIO TAPES, COMPACT DISCS FEATURING CONTEMPLATIVE, PHILOSOPHICAL AND MEDITATIVE STUDIES (U.S. CLS. 21, 23, 26, 36 AND 38).

FIRST USE 12-1-1999; IN COMMERCE 12-1-1999.

SN 76-193,132. RANGER ELECTRONIC COMMUNICATIONS, INC., SHULIN TAIPEI HSIEN, TAIWAN, FILED 1-16-2001.

CONNEX

FOR AMATEUR RADIOS, CITIZEN BAND RADIOS AND ACCESSORIES, NAMELY MICROPHONES, FREQUENCY COUNTERS AND ECHO BOARDS, FOR AMATEUR AND CITIZEN BAND RADIOS (U.S. CLS. 21, 23, 26, 36 AND 38).

FIRST USE 9-1-1985; IN COMMERCE 9-1-1985.

SN 76-199,695. GT MERCHANDISING & LICENSING CORP., NEW YORK, NY. FILED 1-25-2001.

WALK AWAY THE POUNDS

FOR PRERECORDED MAGNETIC DATA CARRIERS FEATURING EXERCISE INSTRUCTION AND ROUTINES (U.S. CLS. 21, 23, 26, 36 AND 38).

CLASS 9—(Continued).

SN 76-200,959. MANAGEMENT RESOURCES TECHNOLOGIES, LTD., WOODSTOCK, GA. FILED 1-26-2001.

ACTIVITY VALUE MANAGEMENT

NO CLAIM IS MADE TO THE EXCLUSIVE RIGHT TO USE "VALUE MANAGEMENT", APART FROM THE MARK AS SHOWN.

FOR COMPUTER SOFTWARE THAT DETERMINES COSTS OF INDIVIDUAL LINES OF BUSINESS WITHIN AN ORGANIZATION BY ASSIGNING COSTS INCURRED BY AN ORGANIZATION TO SEPARATE LINES OF BUSINESS WITHIN THE ORGANIZATION (U.S. CLS. 21, 23, 26, 36 AND 38).

SN 76-201,740. NIPPON DENKI KABUSHIKI KAISHA, DBA NEC CORPORATION, MINATO-KU, TOKYO, JAPAN, FILED 1-29-2001.

@STORAGE

FOR COMPUTERS, ELECTRONIC COMPUTERS, HARDWARE COMPUTER SERVERS, DISK STORAGE, HARD DISK DRIVES, BLANK MAGNETIC TAPES, DATA SWITCHING MACHINES, SWITCHES, ROUTERS, HUBS, COMPUTER SOFTWARE FOR STORAGE MANAGEMENT, COMPUTER SOFTWARE FOR NETWORK MANAGEMENT (U.S. CLS. 21, 23, 26, 36 AND 38).

SN 76-203,287. YAMAHA CORPORATION, HAMAMATSUSHI, SHIZUOKA, JAPAN, FILED 2-1-2001.

NATURAL BLACK

FOR APPARATUS AND INSTRUMENTS FOR PROCESSING, REPRODUCING, TRANSMITTING AND RECORDING SOUND OR IMAGES; NAMELY, VIDEO MONITORS, VIDEO PROJECTORS (U.S. CLS. 21, 23, 26, 36 AND 38).

SN 76-205,086. VTECH INDUSTRIES, L.L.C., WHEELING, IL. FILED 2-5-2001.

POWER ZONE

FOR CHILDREN'S SIMULATED COMPUTERS TO DEVELOP COMPUTER SKILLS AND PERSONAL DEVELOPMENT IN MATHEMATICS, LANGUAGE ARTS, ORGANIZATION AND FOREIGN LANGUAGES (U.S. CLS. 21, 23, 26, 36 AND 38).

FIRST USE 5-29-1998; IN COMMERCE 5-29-1998.

CLASS 9—(Continued).

SN 76-205,109. CARTOON NETWORK LP, LLLP, THE, ATLANTA, GA. FILED 2-5-2001.



FOR SERIES OF PRE-RECORDED VIDEO CASSETTES FEATURING CARTOONS; SERIES OF PRE-RECORDED AUDIO CASSETTES AND COMPACT DISKS FEATURING SOUNDTRACKS, MUSIC OF CARTOON THEME SONGS AND OTHER SOUND RECORDINGS; COMPUTER GAME SOFTWARE; VIDEO GAME CARTRIDGES; VIDEO GAME INTERACTIVE CONTROLS; NAMELY JOYSTICKS; SUNGLASSES, EYEGLASS CASES; COMPUTER PERIPHERAL MOUSE PADS AND DECORATIVE REFRIGERATOR MAGNETS FEATURING CARTOONS (U.S. CLS. 21, 23, 26, 36 AND 38).

SN 76-207,407. THADANI, MOHAN J., MISSISSAUGA, ONTARIO, CANADA, FILED 2-9-2001.

MICRO-TECH

FOR WEIGHING EQUIPMENT, NAMELY, SCALES AND BALANCES (U.S. CLS. 21, 23, 26, 36 AND 38).

SN 76-210,239. NEWSBOYS PARTNERS, FRANKLIN, TN. FILED 2-15-2001.

MUSIC CON DIOS

NO CLAIM IS MADE TO THE EXCLUSIVE RIGHT TO USE "MUSIC", APART FROM THE MARK AS SHOWN.

THE FOREIGN WORDING IN THE MARK TRANSLATES INTO ENGLISH AS "MUSIC OF GOD."

FOR PHONOGRAPH RECORDS, AUDIO CASSETTES, COMPACT DISCS AND DIGITAL AUDIO TAPES, ALL FEATURING MUSIC; AND PRE-RECORDED AUDIO VISUAL MATERIALS, NAMELY, PRE-RECORDED VIDEOTAPES, AUDIO CASSETTE TAPES, COMPACT DISCS, ALL INSPIRED BY FESTIVAL CON DIOS, A TRAVELING MUSIC FESTIVAL (U.S. CLS. 21, 23, 26, 36 AND 38).

SN 76-216,937. GENX INTERNATIONAL, INCORPORATED, MADISON, CT. FILED 2-22-2001.

CELLMATE

FOR LABORATORY EQUIPMENT FOR CLINICAL AND SCIENTIFIC PURPOSES, NAMELY, INCUBATOR USED FOR CELL CULTURE IN REPRODUCTIVE MEDICINE (U.S. CLS. 21, 23, 26, 36 AND 38).

FIRST USE 9-15-2000; IN COMMERCE 9-15-2000.

CLASS 9—(Continued).

SN 76-217,490. NITTO KOHKI KABUSHIKI KAISHA, DBA NITTO KOHKI CO., LTD., OOTA-KU, TOKYO, JAPAN, FILED 2-28-2001.

OWNER OF JAPAN REG. NO. 2283456, DATED 11-30-1990, EXPIRES 11-30-2010.

OWNER OF U.S. REG. NO. 1,636,708.

THE LINING IN THE DRAWING IS A FEATURE OF THE MARK AND IS NOT INTENDED TO INDICATE COLOR. FOR MEASURED DATA CONTROL EQUIPMENT - NAMELY, DATA PROCESSORS, PLOTTERS AND TRANSMITTERS (U.S. CLS. 21, 23, 26, 36 AND 38).

SN 76-217,550. STMICROELECTRONICS, INC., CARROLLTON, TX. FILED 2-28-2001.

KYRO III

NO CLAIM IS MADE TO THE EXCLUSIVE RIGHT TO USE "III", APART FROM THE MARK AS SHOWN.

FOR COMPUTER HARDWARE AND INTEGRATED CIRCUITS, NAMELY, GRAPHICS ACCELERATORS AND SYSTEMS (U.S. CLS. 21, 23, 26, 36 AND 38).

SN 76-219,567. VIDEK, INC., ROCHESTER, NY. FILED 3-5-2001.

INVIZICODE

FOR OPTICAL SCANNERS AND BARCODE VERIFIERS FOR HIGH SPEED OPTICAL CHARACTER RECOGNITION AND OPTICAL RECOGNITION OF BARCODES PRINTED IN INVISIBLE INK (U.S. CLS. 21, 23, 26, 36 AND 38).

SN 76-224,528. ORCHID SYSTEMS, INC., WELLESLEY, MA. FILED 3-12-2001.

VIRTUALSHAPER

FOR BLACK BOX COMPRISED OF COMPUTER HARDWARE AND COMMUNICATIONS SOFTWARE USED TO CONNECT, INTEGRATE, TRANSMIT AND TRANSFORM INFORMATION AND DATA FROM AND THROUGH A SECURE VIRTUAL PRIVATE NETWORK; AND USER'S MANUALS SOLD AS A UNIT THEREWITH (U.S. CLS. 21, 23, 26, 36 AND 38).

CLASS 9—(Continued).

SN 76-226,762. PARIS BUSINESS PRODUCTS, INC., BURLINGTON, NJ. FILED 3-16-2001.

DIGITAL EXCHANGE

NO CLAIM IS MADE TO THE EXCLUSIVE RIGHT TO USE "DIGITAL", APART FROM THE MARK AS SHOWN.

FOR MUSIC STORAGE HOLDERS USED FOR STORING CDS, DVDS, COMPACT FLASH CARDS, SMART MEDIA CARDS, AND OTHER SOLID STATE MEMORY DEVICES (U.S. CLS. 21, 23, 26, 36 AND 38).

SN 76-230,117. CALL CENTER SOLUTIONS, INC., DANBURY, CT. FILED 3-26-2001.

TELE-MESSENGER PLUS

FOR COMPUTER SOFTWARE, THAT CONDUCTS HIGH VOLUME, OUTBOUND, AUTOMATED TELEPHONE DIALING AND WHICH DELIVERS AUTOMATIC, PRE-RECORDED MESSAGES TO TELEPHONE CALL RECIPIENTS FOR USE IN THE FIELD OF TELEMARKETING LEAD GENERATION AND PURSUIT, PROVISION OF EMERGENCY NOTIFICATION TO PARTICIPANTS, AND PROVISION OF SCHOOL ABSENTEE NOTIFICATION TO PARTICIPANTS (U.S. CLS. 21, 23, 26, 36 AND 38).

FIRST USE 3-2-2001; IN COMMERCE 3-2-2001.

SN 76-233,636. MEASUREMENT SPECIALTIES, INC., FAIRFIELD, NJ. FILED 3-30-2001.

MIRAGE

FOR SCALES (U.S. CLS. 21, 23, 26, 36 AND 38).

SN 76-233,637. MEASUREMENT SPECIALTIES, INC., FAIRFIELD, NJ. FILED 3-30-2001.

CLEAR VIEW

FOR SCALES (U.S. CLS. 21, 23, 26, 36 AND 38).

SN 76-235,338. PUBEASY, INC., WHITE PLAINS, NY. FILED 3-28-2001.

PUBEASYPIN

FOR COMPUTER SOFTWARE FOR THE PUBLISHING INDUSTRY, NAMELY, SOFTWARE FOR PROCESSING AND TRACKING ON-LINE BOOK ORDERS AND INQUIRIES AND FOR COMPUTER DATABASE MANAGEMENT SOFTWARE AND FOR THE OPERATION OF NETWORK SERVERS (U.S. CLS. 21, 23, 26, 36 AND 38).

CLASS 9—(Continued).

SN 76-238,474. WIDEFORCE SYSTEMS, INC., SUPERIOR, CO. FILED 4-10-2001.

SPREAD THE WORK

FOR COMPUTER SOFTWARE FOR USE IN COLLECTING, PROCESSING, STORING, AND DISPLAYING DATA REGARDING WORKER RECRUITMENT AND ASSESSMENT, TRAINING CONTENT, WORKER EVALUATION, WORKER ACTIVITY, TASK ASSIGNMENTS, WORK PRODUCT, WORKER STATUS, QUALITY RECORDS, CAPACITY MANAGEMENT, AND OTHER RELEVANT FACTORS RELATED TO WORKERS AND TASKS, IN THE FIELD OF WORK FORCE MANAGEMENT AND WORK FLOW MANAGEMENT (U.S. CLS. 21, 23, 26, 36 AND 38).

SN 76-238,892. PRELUDE SYSTEMS, INC., DALLAS, TX. FILED 4-11-2001.



FOR COMPUTER SOFTWARE FOR CUSTOMER SERVICE, INVENTORY CONTROL, LOGISTICS, ACCOUNTING, AND SUPPLY CHAIN MANAGEMENT FOR A NETWORK AND GLOBAL COMPUTER NETWORK (U.S. CLS. 21, 23, 26, 36 AND 38).

SN 76-239,156. INTERLINK ELECTRONICS, INC., CAMARILLO, CA. FILED 4-11-2001.

NO LOOK REMOTE

NO CLAIM IS MADE TO THE EXCLUSIVE RIGHT TO USE "REMOTE", APART FROM THE MARK AS SHOWN.

FOR REMOTE CONTROL WITH A TOUCH PAD AND/OR WIRELESS KEYBOARD FOR CONSUMER ELECTRONIC DEVICES, NAMELY, TELEVISIONS, STEREOS, VIDEO CASSETTE RECORDERS (VCR), DIGITAL VIDEO DISC (DVD) PLAYERS, COMPACT DISC (CD) PLAYERS, AND PERSONAL VIDEO RECORDERS (PVR) (U.S. CLS. 21, 23, 26, 36 AND 38).

SN 76-239,179. SOFID AG, LIECHTENSTEIN, LIECHTENSTEIN, FILED 4-11-2001.

WOB

FOR BATTERY CELLS AND BATTERIES (U.S. CLS. 21, 23, 26, 36 AND 38).

CLASS 9—(Continued).

SN 76-240,068. QUANTITATIVE ANALYTICS, INC., CHICAGO, IL. FILED 4-13-2001.

FASTICK

FOR COMPUTER SOFTWARE USED TO RETRIEVE COMPRESSED TICK-BY-TICK TRADING DATA (U.S. CLS. 21, 23, 26, 36 AND 38).

FIRST USE 9-15-1999; IN COMMERCE 9-15-1999.

SN 76-243,926. CAPLIN, LEE, ENCINO, CA. FILED 4-6-2001.

JUMBO

FOR CD-ROMS CONTAINING ARTWORK FROM COMIC BOOK COVERS (U.S. CLS. 21, 23, 26, 36 AND 38).

FIRST USE 6-30-1999; IN COMMERCE 6-30-1999.

SN 76-244,378. EPSON AMERICA, INC., LONG BEACH, CA. FILED 4-20-2001.

**RESOLUTION
PERFORMANCE
MANAGEMENT**

NO CLAIM IS MADE TO THE EXCLUSIVE RIGHT TO USE "RESOLUTION PERFORMANCE", APART FROM THE MARK AS SHOWN.

FOR PRINTERS AND OPERATING COMPUTER SOFTWARE FOR PRINTERS (U.S. CLS. 21, 23, 26, 36 AND 38).

SN 76-244,942. HOMEDICS, INC., COMMERCE TOWNSHIP, MI. FILED 4-23-2001.

HOMEDICS

OWNER OF U.S. REG. NO. 1,695,935.
FOR TABLE TOP ELECTRONIC SOUND GENERATOR THAT EMITS SOUNDS REPLICATING OCEAN, RAIN, AND LIKE NOISES (U.S. CLS. 21, 23, 26, 36 AND 38).

FIRST USE 6-19-1997; IN COMMERCE 6-19-1997.

CLASS 9—(Continued).

SN 76-247,979. SURGIENT NETWORKS, INC., AUSTIN, TX. FILED 4-26-2001.

SURGIENT NETWORKS

NO CLAIM IS MADE TO THE EXCLUSIVE RIGHT TO USE "NETWORKS", APART FROM THE MARK AS SHOWN.

FOR NETWORKING SYSTEMS COMPRISING, COMPUTERS AND COMPUTER HARDWARE, NAMELY, ROUTERS AND SERVERS, FOR FACILITATING COMMUNICATION OF INFORMATION ACROSS TELECOMMUNICATIONS NETWORKS (U.S. CLS. 21, 23, 26, 36 AND 38).

SN 76-254,730. CREST AUDIO, INC., PARAMUS, NJ. FILED 5-10-2001.

RAPTURE

FOR AUDIO SIGNAL PROCESSORS (U.S. CLS. 21, 23, 26, 36 AND 38).

SN 76-263,512. AUDIO PRODUCTS INTERNATIONAL CORP., SCARBOROUGH, ONTARIO, CANADA, FILED 5-29-2001.

ENERGY

OWNER OF U.S. REG. NOS. 1,201,814 AND 1,807,139.
FOR LOUDSPEAKERS, SOUND AMPLIFIERS, RADIO AND STEREO RECEIVERS, TURNTABLES, AUDIO TAPE RECORDERS, AUDIO TAPE PLAYERS, STEREO TUNERS, GRAPHIC EQUALIZERS, ELECTRONIC NOISE REDUCTION UNITS, AND ELECTRONIC SIGNAL MODIFICATION UNITS FOR LOUD SPEAKERS (U.S. CLS. 21, 23, 26, 36 AND 38).

SN 76-265,229. D B INDUSTRIES, INC., RED WING, MN. FILED 5-31-2001.

EXOFIT

FOR FALL PROTECTION EQUIPMENT, NAMELY, SAFETY BELTS AND HARNESSSES, LANYARDS, ROPE GRABS AND SHOCK ABSORBERS, AND METAL BUCKLES FOR USE WITH SAFETY HARNESSSES (U.S. CLS. 21, 23, 26, 36 AND 38).

CLASS 9—(Continued).

SN 76-265,230. D B INDUSTRIES, INC., RED WING, MN.
FILED 5-31-2001.

HOT WORK

FOR FALL PROTECTION EQUIPMENT, NAMELY,
NON-ELECTRIC METAL CABLES AND METAL
BUCKLES, SELF-RETRACTING LIFELINES, AND
SAFETY HARNESSES AND LANYARDS (U.S. CLS. 21,
23, 26, 36 AND 38).

SN 76-265,446. SAMARA, RENEE, DBA CULTUREWORKS
INTERACTIVE, PHILADELPHIA, PA. FILED 6-1-2001.

YOGA ANYWHERE

NO CLAIM IS MADE TO THE EXCLUSIVE RIGHT TO
USE "YOGA", APART FROM THE MARK AS SHOWN.

FOR PRERECORDED AUDIO TAPES AND DISKS, CD-
ROMS, VIDEO TAPES AND DISKS, DVDS AND INTER-
ACTIVE COMPUTER SOFTWARE ON CD-ROMS, DISK-
ETTES, DVD'S AND DOWNLOADABLE FROM THE
INTERNET, IN THE FIELDS OF YOGA, PHYSICAL
FITNESS, STRESS MANAGEMENT AND RELAXATION
(U.S. CLS. 21, 23, 26, 36 AND 38).

SN 76-272,898. SIERRA POINT PARTNERS, LLC, PLEASANT
HILL, CA. FILED 6-14-2001.

**NOW... IT'S WATT YOU
KNOW!**

FOR ENERGY MEASURING SENSOR THAT WILL
MEASURE ELECTRICAL WATTAGE AND CALCULATE
ENERGY COSTS OF ITEMS TESTED (U.S. CLS. 21, 23,
26, 36 AND 38).

SN 76-274,378. CSG SYSTEMS, INC., ENGLEWOOD, CO.
FILED 6-19-2001.

CSG PROFITNOW!

OWNER OF U.S. REG. NOS. 2,274,736, 2,336,775 AND
OTHERS.

FOR CUSTOMER RELATIONSHIP MANAGEMENT
COMPUTER SOFTWARE PROGRAMS, NAMELY COM-
PUTER SOFTWARE PROGRAMS THAT ALLOW TELE-
COMMUNICATIONS, CABLE, VIDEO, TELEPHONY
AND DATA COMPANIES TO FACILITATE CUSTOMER
RETENTION AND PROFIT BY IMMEDIATELY IDENTI-
FYING CUSTOMERS WHO ARE LIKELY TO CHURN,
AND PREDICTING CUSTOMERS' PROPENSITY TO
CHURN, BASED ON BILLING DATA, SERVICE HIS-
TORY, CUSTOMER SERVICE CALLS, RATE PLAN,
USAGE DATA, AND PAYMENT PATTERNS (U.S. CLS.
21, 23, 26, 36 AND 38).

CLASS 9—(Continued).

SN 76-275,731. SCHACKNER, HARLAN E, WEST ORANGE,
NJ. FILED 6-25-2001.

IMMIGREAT

FOR COMPUTER SOFTWARE FOR IMMIGRATION
LAW PURPOSES (U.S. CLS. 21, 23, 26, 36 AND 38).

SN 76-277,895. FOX RACING, INC., MORGAN HILL, CA.
FILED 6-25-2001.



FOR MOTORCYCLE AND SAFETY HELMETS AND
PROTECTIVE CLOTHING FOR MOTORCYCLISTS AND
CYCLISTS; PRERECORDED AUDIO AND VIDEO
TAPES, DISCS AND CASSETTES FEATURING SPORTS
(U.S. CLS. 21, 23, 26, 36 AND 38).

SN 76-278,268. SYAGEN TECHNOLOGY, INC., TUSTIN, CA.
FILED 6-29-2001.

RADIANCE PRO

NO CLAIM IS MADE TO THE EXCLUSIVE RIGHT TO
USE "PRO", APART FROM THE MARK AS SHOWN.

FOR PHOTOIONIZATION MASS SPECTROMETERS
(U.S. CLS. 21, 23, 26, 36 AND 38).

SN 76-281,571. TORGO, INC., CHICAGO, IL. FILED 7-3-2001.

BARTENDER MAGIC

NO CLAIM IS MADE TO THE EXCLUSIVE RIGHT TO
USE "BARTENDER", APART FROM THE MARK AS
SHOWN.

FOR COMPUTER SOFTWARE, NAMELY SOFTWARE
ACTING AS A MIXING GUIDE FOR MIXED DRINKS
(U.S. CLS. 21, 23, 26, 36 AND 38).

FIRST USE 5-17-1999; IN COMMERCE 5-20-1999.

CLASS 9—(Continued).

SN 76-281,572. TORGO, INC., CHICAGO, IL. FILED 7-3-2001.

CALORIE MAGIC

NO CLAIM IS MADE TO THE EXCLUSIVE RIGHT TO USE "CALORIE", APART FROM THE MARK AS SHOWN. FOR COMPUTER SOFTWARE, NAMELY SOFTWARE FOR AIDING WITH DIET PREPARATION AND CALORIE COUNTING (U.S. CLS. 21, 23, 26, 36 AND 38). FIRST USE 5-17-1999; IN COMMERCE 5-21-1999.

SN 76-283,287. OPTICAL RESEARCH ASSOCIATES, PASADENA, CA. FILED 7-9-2001.

LAMBDA RAMP

FOR OPTICAL AND ELECTRO-OPTICAL COMMUNICATION HARDWARE, NAMELY, OPTICAL SWITCHES, ROUTERS, OPTICAL ADD/DROP MODULATORS AND DEMODULATORS, MULTIPLEXERS, OPTICAL GRATINGS, OPTICAL FIBER, FIBER OPTIC CONNECTORS, FIBER OPTIC PACKAGING, OPTICAL FILTERS, MEMS (MICRO ELECTROMECHANICAL MACHINES), MOEMS (MICRO OPTICAL ELECTRICAL MECHANICAL MACHINES), CHANNEL EQUALIZERS, CHANNEL MONITORS, DISPERSION COMPENSATORS, POLARIZATION DISPERSION COMPENSATORS, CHROMATIC COUPLING LENSES; CABLE TV COMMUNICATION DEVICES, NAMELY ROUTERS AND DISTRIBUTORS; HEADIN EQUIPMENT, NAMELY, AMPLIFIERS, MODULATORS, DEMODULATORS, MULTIPLEXERS, DEMULTIPLEXERS, AND SPLITTERS; TELECOMMUNICATIONS EQUIPMENT, NAMELY, TELEPHONE SWITCHES, COUPLERS, SPLITTERS, COMBINERS, AND ISOLATORS; AND PERSONAL COMPUTER COMMUNICATION DEVICES, NAMELY, MODEMS, ETHERNET, AND OPTICAL NETWORK INTERFACE CARDS (U.S. CLS. 21, 23, 26, 36 AND 38).

SN 76-283,520. KEYBOARD KADDY, INC., CHESAPEAKE, VA. FILED 7-11-2001.

KEYBOARD KADDY

NO CLAIM IS MADE TO THE EXCLUSIVE RIGHT TO USE "KEYBOARD", APART FROM THE MARK AS SHOWN. FOR COMPUTER KEYBOARD (U.S. CLS. 21, 23, 26, 36 AND 38). FIRST USE 3-6-1999; IN COMMERCE 3-6-1999.

SN 76-286,686. KOSAKA INTERACTIVE, INC., PALO ALTO, CA. FILED 7-19-2001.

KOSAKA INTERACTIVE

NO CLAIM IS MADE TO THE EXCLUSIVE RIGHT TO USE "INTERACTIVE", APART FROM THE MARK AS SHOWN. FOR ELECTRONIC GAME PROGRAMS, VIDEO GAME SOFTWARE, COMPUTER GAME SOFTWARE, VIDEO GAME CARTRIDGES (U.S. CLS. 21, 23, 26, 36 AND 38).

CLASS 9—(Continued).

SN 76-287,300. WAYNE-DALTON CORP., MT. HOPE, OH. FILED 7-18-2001.

IDRIVE

FOR ELECTRONIC OPENER FOR UPWARDLY ACTING SECTIONAL DOORS (U.S. CLS. 21, 23, 26, 36 AND 38).

SN 76-289,152. SILVER CREEK INDUSTRIES, INC., MANITOWOC, WI. FILED 7-23-2001.

DETECTEAR

FOR ELECTRONIC SOUND AMPLIFICATION SYSTEM COMPRISED OF A PARABOLIC REFLECTOR AND HEADPHONES (U.S. CLS. 21, 23, 26, 36 AND 38).

SN 76-289,242. PKWARE, INC., BROWN DEER, WI. FILED 7-20-2001.

PKZIP EXPLORER

OWNER OF U.S. REG. NOS. 1,577,583, 2,325,523 AND OTHERS.

FOR COMPUTER PROGRAMS AND SOFTWARE ADD-INS, TOGETHER WITH INSTRUCTIONAL MANUALS SOLD AS A UNIT, FOR COMPRESSION, DECOMPRESSION, LIBRARIAN AND ARCHIVING OF COMPUTER FILES (U.S. CLS. 21, 23, 26, 36 AND 38).

SN 76-289,252. PINNACLE SYSTEMS, INC., MOUNTAIN VIEW, CA. FILED 7-23-2001.

STUDIO ACTION

NO CLAIM IS MADE TO THE EXCLUSIVE RIGHT TO USE "STUDIO", APART FROM THE MARK AS SHOWN.

FOR COMPUTER SOFTWARE FOR TRANSFERRING AUDIO, VIDEO AND MULTIMEDIA CONTENT TO A COMPUTER; COMPUTER SOFTWARE FOR CONVERSION OF AUDIO, VIDEO AND MULTIMEDIA CONTENT TO DIGITAL FORM; COMPUTER HARDWARE; COMPUTER PERIPHERALS; COMPUTER CABLES; COMPUTER SOFTWARE FOR THE RECORDING, STORING, EDITING AND PLAYBACK OF AUDIO, VIDEO AND MULTIMEDIA CONTENT (U.S. CLS. 21, 23, 26, 36 AND 38).

FIRST USE 3-5-2001; IN COMMERCE 3-5-2001.

CLASS 9—(Continued).

SN 76-291,095. XPEED, INC., YONGIN-SI, KYUNGGI-DO, REPUBLIC OF KOREA, FILED 7-20-2001.



FOR MOTORCYCLE HELMETS, BICYCLE HELMETS, SNOWMOBILE HELMETS, AUTORACING HELMETS (U.S. CLS. 21, 23, 26, 36 AND 38).

SN 76-291,103. READ-RITE CORPORATION, FREMONT, CA. FILED 7-27-2001.



FOR THIN FILM MAGNETIC RECORDING HEADS, AND RELATED HEAD GIMBAL ASSEMBLIES, AND HEAD STACK ASSEMBLIES FOR USE IN DISC DRIVES (U.S. CLS. 21, 23, 26, 36 AND 38).
FIRST USE 4-15-1993; IN COMMERCE 4-15-1993.

SN 76-291,104. READ-RITE CORPORATION, FREMONT, CA. FILED 7-27-2001.

RR

FOR THIN FILM MAGNETIC RECORDING HEADS, AND RELATED HEAD GIMBAL ASSEMBLIES, AND HEAD STACK ASSEMBLIES FOR USE IN DISC DRIVES (U.S. CLS. 21, 23, 26, 36 AND 38).
FIRST USE 4-15-1993; IN COMMERCE 4-15-1993.

SN 76-291,120. OMNICORDER TECHNOLOGIES, INCORPORATED, STONY BROOK, NY. FILED 7-27-2001.

BIOSCANIR

FOR COMPUTER SOFTWARE AND HARDWARE FOR DISEASE DETECTION AND MANAGEMENT (U.S. CLS. 21, 23, 26, 36 AND 38).

CLASS 9—(Continued).

SN 76-291,464. SIERRA ON-LINE, INC., LOS ANGELES, CA. FILED 7-27-2001.

PHARAOH

FOR COMPUTER GAME SOFTWARE AND INSTRUCTION MANUALS SOLD THEREWITH (U.S. CLS. 21, 23, 26, 36 AND 38).
FIRST USE 10-29-1999; IN COMMERCE 10-29-1999.

SN 76-293,282. PAPP, DOROTHY HERMAN, STONINGTON, CT. FILED 8-2-2001.

**MUZAICS: AMUSING
MAGNETS**

NO CLAIM IS MADE TO THE EXCLUSIVE RIGHT TO USE "MAGNETS". APART FROM THE MARK AS SHOWN. FOR DECORATIVE MAGNETS (U.S. CLS. 21, 23, 26, 36 AND 38).

SN 76-294,302. FOX RACING, INC., MORGAN HILL, CA. FILED 8-3-2001.



THE NAME "RICKY CARMICHAEL" IDENTIFIES A LIVING INDIVIDUAL WHOSE CONSENT IS OF RECORD. FOR MOTORCYCLE AND SAFETY HELMETS AND PROTECTIVE CLOTHING FOR MOTORCYCLISTS AND CYCLISTS; PRERECORDED AUDIO AND VIDEO TAPES, DISCS AND CASSETTES FEATURING SPORTS (U.S. CLS. 21, 23, 26, 36 AND 38).

SN 76-294,500. THOMAS & BETTS INTERNATIONAL, INC., SPARKS, NV. FILED 2-3-2001.

STAR TECK

FOR ELECTRICAL CONNECTORS FOR ELECTRICAL CABLE AND CONDUIT (U.S. CLS. 21, 23, 26, 36 AND 38).
FIRST USE 1-10-1990; IN COMMERCE 1-10-1990.

CLASS 9—(Continued).

SN 76-295,110. MPSI SYSTEMS, INC., TULSA, OK. FILED 8-3-2001.



FOR COMPUTER SOFTWARE FOR INTERACTIVE MARKET ANALYSIS, NAMELY, RETAIL MODELING, GEOGRAPHIC ANALYSIS, MAP PRODUCTION, AND INTERACTIVE ANALYSIS OF BUSINESS PLANNING DATA AND RELATED INSTRUCTIONAL MATERIALS SOLD THEREWITH (U.S. CLS. 21, 23, 26, 36 AND 38).
FIRST USE 4-6-2000; IN COMMERCE 4-6-2000.

SN 76-296,825. SMITH, FAITH, SAN DIEGO, CA. FILED 8-9-2001.

UNBOUND

FOR SUNGLASSES, EYEGLASSES, AND SUNGLASS CASES (U.S. CLS. 21, 23, 26, 36 AND 38).

SN 76-296,898. NEPHROLOGY EDUCATIONAL SERVICES AND RESEARCH, INC., TARZANA, CA. FILED 8-10-2001.

RENALTOUCH

FOR EDUCATIONAL SOFTWARE FOR DIALYSIS PATIENTS (U.S. CLS. 21, 23, 26, 36 AND 38).

SN 76-297,647. COPLEY CONTROLS CORPORATION, WESTWOOD, MA. FILED 8-1-2001.

JUNUS

FOR AMPLIFIERS FOR BRUSH SERVOMOTORS (U.S. CLS. 21, 23, 26, 36 AND 38).

CLASS 9—(Continued).

SN 76-297,649. COPLEY CONTROLS CORPORATION, WESTWOOD, MA. FILED 8-1-2001.

XENUS

FOR AMPLIFIERS FOR BRUSHLESS SERVOMOTORS (U.S. CLS. 21, 23, 26, 36 AND 38).

SN 76-297,657. SHENG LIN INC., DBA L & L OPTICAL, MONTEREY PARK, CA. FILED 8-10-2001.

GIANNI PO

FOR OPTICAL FRAMES, CASE FOR OPTICAL FRAMES (U.S. CLS. 21, 23, 26, 36 AND 38).
FIRST USE 6-1-1999; IN COMMERCE 6-1-1999.

SN 76-298,831. METROBILITY OPTICAL SYSTEMS, INC., MERRIMACK, NH. FILED 8-3-2001.

METROBILITY OPTICAL SYSTEMS

NO CLAIM IS MADE TO THE EXCLUSIVE RIGHT TO USE "OPTICAL SYSTEMS", APART FROM THE MARK AS SHOWN.

FOR DATA COMMUNICATIONS EQUIPMENT COMPRISED OF COMPUTER HARDWARE AND SOFTWARE USED FOR DATA COMMUNICATION NETWORKS, TOGETHER WITH THE INSTRUCTIONAL MANUALS THEREFOR SOLD AS A UNIT (U.S. CLS. 21, 23, 26, 36 AND 38).

SN 76-300,100. ENTEGRITY SOLUTIONS CORPORATION, SAN JOSE, CA. FILED 8-16-2001.

ASSURETRANSACTION

FOR COMPUTER SOFTWARE AND MANUALS SOLD AS A UNIT FOR PROVIDING AND ENABLING FINANCIAL TRANSACTIONS AND RAPID INTEGRATION OF DIGITAL AND IDENTITY CERTIFICATES ISSUED BY CERTIFICATION AUTHORITIES AND ENTITIES INTO BUSINESS-TO-BUSINESS AND ELECTRONIC COMMERCE APPLICATIONS AND FOR ENABLING FINANCIAL INSTITUTIONS, BANKS AND CORPORATE ENTITIES AND CLIENTS RAPID AND COST EFFECTIVE INTEGRATION OF PUBLIC KEY INFRASTRUCTURES (PKI) WITH ELECTRONIC COMMERCE TRUST INFRASTRUCTURES CONNECTING WITH GLOBAL FINANCIAL INSTITUTIONS AND BANKS TO PROVIDE IDENTITY AND TRUST ENABLEMENT AND NON-REPUDIABLE RECEIPTING ON THE INTERNET AND GLOBAL COMMUNICATION AND COMPUTER NETWORKS FOR BUSINESS-TO-BUSINESS ELECTRONIC COMMERCE FOR COMMERCIAL TRANSACTIONS INCLUDING ENABLING GLOBAL TRADING PARTNERS AND ENTITIES AROUND THE WORLD TO CONCLUSIVELY IDENTIFY ONE ANOTHER OVER THE INTERNET AND GLOBAL COMMUNICATION AND COMPUTER NETWORKS THROUGH FINANCIAL INSTITUTIONS AND BANKS (U.S. CLS. 21, 23, 26, 36 AND 38).

CLASS 9—(Continued).

SN 76-301,027. NEXTEL COMMUNICATIONS INC., RESTON, VA. FILED 8-17-2001.

NBI

FOR HARDWARE AND SOFTWARE FOR USE IN COMMUNICATIONS NETWORKS, NAMELY, INTERNET PROTOCOL AND TELECOMMUNICATIONS NETWORK TRANSMITTERS, RECEIVERS, CONVERTERS, AND ROUTERS WHICH ALLOW THE USER TO SEND VOICE, DATA, PICTURES, MUSIC AND VIDEO OVER WIRELESS NETWORKS (U.S. CLS. 21, 23, 26, 36 AND 38).

SN 76-306,174. XYBERNAUT CORPORATION, FAIRFAX, VA. FILED 8-28-2001.



FOR VOICE ACTIVATED, HANDS FREE WEARABLE COMPUTERS (U.S. CLS. 21, 23, 26, 36 AND 38). FIRST USE 8-27-2001; IN COMMERCE 8-27-2001.

SN 76-307,617. HARRIS MARKETING, INC., INDIANAPOLIS, IN. FILED 8-24-2001.

MARIGOLD

FOR COMPUTER SOFTWARE FOR USE IN FILE AUDITING AND DATABASE MANAGEMENT (U.S. CLS. 21, 23, 26, 36 AND 38).

SN 76-308,748. MESHNETWORKS, INC., MAITLAND, FL. FILED 8-31-2001.

MESHPAK

FOR TRANSCEIVERS FOR PROVIDING WIRELESS COMMUNICATION FUNCTIONS (U.S. CLS. 21, 23, 26, 36 AND 38).

CLASS 9—(Continued).

SN 76-309,088. INTRANEXUS, LLC, VIRGINIA BEACH, VA. FILED 9-5-2001.

INTRANEXUS

FOR COMPUTER SOFTWARE FOR INFORMATION MANAGEMENT FOR THE HEALTH CARE INDUSTRY (U.S. CLS. 21, 23, 26, 36 AND 38).

SN 76-310,103. ROCKWELL SOFTWARE INC., WEST ALLIS, WI. FILED 9-7-2001.

FACTORYTALK

FOR COMPUTER SOFTWARE PLATFORM FOR USE IN INDUSTRIAL AUTOMATION, MANUFACTURING, AND BUILDING MAINTENANCE, COMPUTER SOFTWARE FOR USE IN THE DESIGN, OPERATION, AND MAINTENANCE OF INDUSTRIAL AUTOMATION PROCESSES; COMPUTER SOFTWARE FOR COLLECTING AND DISTRIBUTING DATA WITHIN COMPUTER NETWORKS, INCLUDING THE INTERNET, AND ENABLING DATA COMMUNICATION BETWEEN APPLICATION PROGRAMS (U.S. CLS. 21, 23, 26, 36 AND 38).

SN 76-310,117. SYSTEMS & SOFTWARE, INC., COLCHESTER, VT. FILED 9-7-2001.

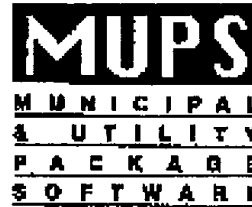

NO CLAIM IS MADE TO THE EXCLUSIVE RIGHT TO USE "MUNICIPAL & UTILITY PACKAGE SOFTWARE", APART FROM THE MARK AS SHOWN.

FOR COMPUTER SOFTWARE FOR USE IN CUSTOMER INFORMATION MANAGEMENT, CUSTOMER SERVICE, BILLING, WORK FLOW, ASSET MANAGEMENT, FINANCIAL MANAGEMENT, AND ACCOUNTING FOR MUNICIPAL AND INVESTOR OWNED UTILITIES (U.S. CLS. 21, 23, 26, 36 AND 38). FIRST USE 2-0-1993; IN COMMERCE 2-0-1993.

SN 76-311,065. HARMAN INTERNATIONAL INDUSTRIES INC., NORTHRIDGE, CA. FILED 9-7-2001.

SONOGLASS

FOR LOUDSPEAKERS (U.S. CLS. 21, 23, 26, 36 AND 38).

CLASS 9—(Continued).

SN 76-311,089. REDLAKE MASD, INC., SAN DIEGO, CA. FILED 9-12-2001.

MOTIONPRO

FOR HIGH FRAME RATE VIDEO CAMERAS; HIGH FRAME RATE DIGITAL VIDEO CAMERAS; HIGH SPEED MOTION DIGITAL VIDEO CAMERAS; AND APPLICATION SUPPORT SOFTWARE FOR THE ABOVE IDENTIFIED CAMERAS (U.S. CLS. 21, 23, 26, 36 AND 38).

SN 76-311,682. KABUSHIKI KAISHA HITACHI SEISAKUSHO, DBA HITACHI, LTD., CHIYODA-KU, TOKYO 101-8010, JAPAN, FILED 9-12-2001.

SUPERNATURALEYE

FOR SCANNING ELECTRON MICROSCOPES (U.S. CLS. 21, 23, 26, 36 AND 38).

SN 76-312,086. NTE ELECTRONICS, INC., BLOOMFIELD, NJ. FILED 9-10-2001.

NTE

FOR ELECTRICAL AND ELECTROMECHANICAL COMPONENTS, NAMELY, CAPACITORS, WIRE, RELAYS, SEMICONDUCTORS, RESISTORS, POTENTIOMETERS AND TRIMMERS (U.S. CLS. 21, 23, 26, 36 AND 38).

FIRST USE 1-23-1984; IN COMMERCE 1-23-1984.

SN 76-312,341. WAI HANG ELECTRONIC CO., LTD., NEW TERRITORIES, HONG KONG, FILED 9-14-2001.

Day Break

FOR RADIOS, RADIOS INCORPORATING WITH CLOCKS, CAR RADIOS, CASSETTE TAPE RECORDERS, CASSETTE TAPE PLAYERS, LOUDSPEAKERS, HEADSETS, COMPACT DISC PLAYERS (U.S. CLS. 21, 23, 26, 36 AND 38).

SN 76-312,351. OPTICAL GAGING PRODUCTS, INC., ROCHESTER, NY. FILED 9-17-2001.

SCAN-X

FOR COMPUTER SOFTWARE FOR ANALYZING DATA GENERATED BY LASER SCANNERS ON VIDEO METROLOGY SYSTEMS (U.S. CLS. 21, 23, 26, 36 AND 38).

CLASS 9—(Continued).

SN 76-312,369. ENFORA, INC., PLANO, TX. FILED 9-13-2001.

enfora

FOR WIRELESS TELECOMMUNICATION AND COMPUTER HARDWARE ENABLING USERS TO ACCESS OR REMOTELY CONNECT TO COMPUTERS, COMPUTER NETWORKS, SATELLITES, TELECOMMUNICATIONS EQUIPMENT, AND THE GLOBAL COMPUTER NETWORK (U.S. CLS. 21, 23, 26, 36 AND 38).

FIRST USE 3-22-2001; IN COMMERCE 3-22-2001.

SN 76-312,409. FILE METRICS, INC., SAN MARCOS, CA. FILED 9-17-2001.

SWAPNUT

FOR COMPUTER SOFTWARE FOR FILE SHARING BETWEEN ONLINE COMPUTER USERS (U.S. CLS. 21, 23, 26, 36 AND 38).

FIRST USE 9-1-2001; IN COMMERCE 9-1-2001.

SN 76-312,463. POWERQUEST CORPORATION, OREM, UT. FILED 9-11-2001.

RECOVERYMAGIC

FOR COMPUTER SOFTWARE WHICH CREATES PARTITIONS ON PCS WHICH ALLOW THE USER AUTOMATIC BACK-UPS OF THEIR HARD DRIVE (U.S. CLS. 21, 23, 26, 36 AND 38).

SN 76-312,899. MAGID GLOVE AND SAFETY MANUFACTURING CO., L.L.C., CHICAGO, IL. FILED 9-17-2001.

SUPERTIPS

FOR PROTECTIVE CLOTHING, NAMELY GLOVES FOR GARDENING AND OTHER WORK APPLICATIONS (U.S. CLS. 21, 23, 26, 36 AND 38).

FIRST USE 2-15-2001; IN COMMERCE 2-15-2001.

SN 76-312,916. ROAD TOOLS LLC, RYE, NM. FILED 9-17-2001.

COOLPAD

FOR COMPUTER STANDS SPECIFICALLY DESIGNED FOR HOLDING A COMPUTER (U.S. CLS. 21, 23, 26, 36 AND 38).

FIRST USE 7-16-1997; IN COMMERCE 7-16-1997.

CLASS 9—(Continued).

SN 76-312,946. J.S.C. SVETLANA, ST. PETERSBURG, RUSSIAN FEDERATIO, FILED 9-18-2001.

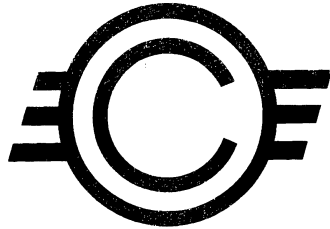

FOR ELECTRON TUBES (U.S. CLS. 21, 23, 26, 36 AND 38).
FIRST USE 0-0-1963; IN COMMERCE 0-0-1963.

SN 76-313,391. RONALD A. JOHNSON, EFFINGHAM, IL. FILED 9-17-2001.

SLIC

FOR ELECTRICAL SWITCHES THAT CAN BE OPERATED MANUALLY, AUTOMATICALLY OR BY REMOTE CONTROL (U.S. CLS. 21, 23, 26, 36 AND 38).

SN 78-000,481. JOURNEY FILMS, INC., ALEXANDRIA, VA. FILED 3-22-2000.

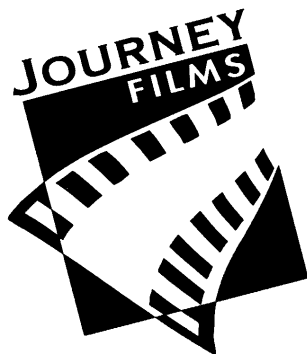

NO CLAIM IS MADE TO THE EXCLUSIVE RIGHT TO USE "FILMS", APART FROM THE MARK AS SHOWN.

FOR MOTION PICTURE FILMS, DOCUMENTARIES, DIGITAL VIDEO DISCS, AND PRERECORDED VIDEOTAPES AND FILM STRIPS FEATURING THE TOPICS OF RELIGION, HISTORY, PHILOSOPHY, ARCHITECTURE, ART, SOCIAL COMMENTARY, POLITICS, EDUCATION, AND ENTERTAINMENT FOR CHILDREN (U.S. CLS. 21, 23, 26, 36 AND 38).
FIRST USE 6-18-1996; IN COMMERCE 6-18-1996.

CLASS 9—(Continued).

SN 78-001,988. RENKIS, MARTIN, CHAPEL HILL, NC. FILED 3-31-2000.

SMARTVUE

FOR COMPUTER HARDWARE AND SOFTWARE USED IN MONITORING SECURITY IN HOMES AND COMMERCIAL BUILDINGS THAT MAY BE DOWNLOADED FROM A GLOBAL COMPUTER NETWORK (U.S. CLS. 21, 23, 26, 36 AND 38).
FIRST USE 12-2-1999; IN COMMERCE 2-1-2000.

SN 78-002,594. SUSSMAN, LESTER, BETHESDA, MD. FILED 4-4-2000.

PHONEDIRECT

FOR ELECTRONIC HARDWARE AND SOFTWARE FOR PROVIDING INTEGRATED TELEPHONY AND DATA COMMUNICATION OVER VOICE AND DATA GLOBAL INFORMATION NETWORKS, AND INSTRUCTION MANUALS SOLD THEREWITH (U.S. CLS. 21, 23, 26, 36 AND 38).

SN 78-004,524. ENTERTAINMENT SYSTEMS TECHNOLOGY, INC., HUNTINGTON BEACH, CA. FILED 4-17-2000.

FUNPAD NETWORK

NO CLAIM IS MADE TO THE EXCLUSIVE RIGHT TO USE "NETWORK", APART FROM THE MARK AS SHOWN.

FOR PROVIDING INTERACTIVE INFORMATION IN THE FIELD OF ENTERTAINMENT, NAMELY, INFORMATION ON MOVIES, TELEVISION, THEATER, SPORTS, HOROSCOPES, WEATHER, THE ARTS AND CULTURAL EVENTS OF INTEREST TO SPECIFIC GEOGRAPHIC LOCALES VIA LOCAL AND GLOBAL COMPUTER NETWORKS; PROVIDING ON-LINE VIDEO COMPUTER GAMES; MULTIMEDIA ENTERTAINMENT SOFTWARE PRODUCTION SERVICES (U.S. CLS. 21, 23, 26, 36 AND 38).

SN 78-010,619. NONIN MEDICAL, INC., PLYMOUTH, MN. FILED 5-31-2000.

NVISION

FOR COMPUTER PROGRAM FOR RETRIEVING, VIEWING AND EVALUATION OF PHYSIOLOGICAL DATA RECORDED BY OXIMETERS AND SENSORS SOLD TO LICENSED MEDICAL PRACTITIONERS ONLY (U.S. CLS. 21, 23, 26, 36 AND 38).

CLASS 9—(Continued).

SN 78-011,022. SOFT SWITCHING TECHNOLOGIES CORPORATION, MIDDLETON, WI. FILED 6-2-2000.

DYNAMIC SAG CORRECTOR

NO CLAIM IS MADE TO THE EXCLUSIVE RIGHT TO USE "SAG CORRECTOR", APART FROM THE MARK AS SHOWN.

FOR VOLTAGE PROTECTORS FOR USE IN MAINTAINING OPERATION OF SENSITIVE ELECTRICAL EQUIPMENT AND MANUFACTURING PROCESSES DURING UNEXPECTED VOLTAGE CHANGES AND MOMENTARY LOSSES OF ELECTRICAL POWER (U.S. CLS. 21, 23, 26, 36 AND 38).

FIRST USE 11-7-1998; IN COMMERCE 2-9-1999.

SN 78-011,683. MAGNIVISION, INC., PEMBROK PINES, FL. FILED 6-7-2000.

TECHNIVISION

FOR EYEGLASSES (U.S. CLS. 21, 23, 26, 36 AND 38).

SN 78-012,883. BUCHANAN, BEAU, BURBANK, CA. FILED 6-15-2000.

BANKGUARD

FOR PERSONAL IDENTIFICATION AND COORDINATION SYSTEM COMPRISING COMPUTER SOFTWARE AND PROPRIETARY DATA BASES FOR FACILITATING COMMERCIAL TRANSACTIONS WHICH INCLUDE ELECTRONIC PAYMENT (U.S. CLS. 21, 23, 26, 36 AND 38).

SN 78-015,112. UNGERBOECK SYSTEMS, INC., ST. CHARLES, MO. FILED 6-30-2000.

EBMS

FOR COMPUTER SOFTWARE FOR USE IN MARKETING, SCHEDULING, PLANNING AND OPERATION OF EVENTS AND MEETINGS, AND FOR USE IN ACCOUNTING FOR EVENTS AND MEETINGS (U.S. CLS. 21, 23, 26, 36 AND 38).

FIRST USE 12-15-1994; IN COMMERCE 1-15-1995.

CLASS 9—(Continued).

SN 78-015,128. MELITA INTELLECTUAL PROPERTY INC., WILMINGTON, DE. FILED 6-30-2000.

ESHARE CONNECTIONS

OWNER OF U.S. REG. NOS. 2,189,275, 2,258,534 AND OTHERS.

NO CLAIM IS MADE TO THE EXCLUSIVE RIGHT TO USE "CONNECTIONS", APART FROM THE MARK AS SHOWN.

FOR COMPUTER SOFTWARE FOR FACILITATING INTERACTIVE COMMUNICATION, NAMELY CHAT, ELECTRONIC MAIL, VOICE, INSTANT MESSAGES, TEXT TRANSFER, MULTIMEDIA TRANSFER, LIVE COLLABORATION, MOTION PICTURES AND SOUND OVER A GLOBAL COMPUTER INFORMATION NETWORK AND OTHER NETWORKS; AND FOR ORGANIZING, DIRECTING, AND CONTROLLING COMMUNICATION, INFORMATION, TASKS, AND INTERACTION BETWEEN REMOTE SITES AND BETWEEN REMOTE SITES AND A CENTRAL LOCATION IN THE FIELD OF CUSTOMER CONTACT MANAGEMENT (U.S. CLS. 21, 23, 26, 36 AND 38).

SN 78-016,549. YOTTAYOTTA, INC., EDMONTON, ALBERTA T6H 5S4, CANADA, FILED 7-13-2000.

YOTTASCOPE

FOR DATA STORAGE SYSTEMS, COMPRISED OF COMPUTER HARDWARE AND SOFTWARE FOR COMPUTER DATA STORAGE AND USER MANUALS SOLD TOGETHER AS A UNIT (U.S. CLS. 21, 23, 26, 36 AND 38).

SN 78-017,707. NEW WORLD MEDIA, INC., FAIR HAVEN, NY. FILED 7-20-2000.



NO CLAIM IS MADE TO THE EXCLUSIVE RIGHT TO USE "MEDIA", APART FROM THE MARK AS SHOWN.

THE STIPPLING IN THE DRAWING IS A FEATURE OF THE MARK AND DOES NOT INDICATE COLOR.

FOR COMPUTER SOFTWARE TO ENHANCE THE AUDIO-VISUAL CAPABILITIES OF MULTIMEDIA APPLICATIONS, NAMELY, FOR THE INTEGRATION OF TEXT, AUDIO, GRAPHICS, STILL IMAGES AND MOVING PICTURES (U.S. CLS. 21, 23, 26, 36 AND 38).

FIRST USE 10-22-1993; IN COMMERCE 10-22-1993.

CLASS 9—(Continued).

SN 78-019,385. YOTTAYOTTA, INC., EDMONTON, ALBERTA T6H 5S4, CANADA, FILED 8-2-2000.

YOTTAYOTTA

FOR DATA STORAGE SYSTEMS, COMPRISED OF COMPUTER HARDWARE AND SOFTWARE FOR COMPUTER DATA STORAGE AND USER MANUALS SOLD TOGETHER AS A UNIT (U.S. CLS. 21, 23, 26, 36 AND 38).

SN 78-020,075. OPCOM INC., SANCHUNG CITY, TAIWAN, FILED 8-8-2000.

TORPEDO BOY

OWNER OF U.S. REG. NOS. 2,360,312 AND 2,360,313. NO CLAIM IS MADE TO THE EXCLUSIVE RIGHT TO USE "TORPEDO", APART FROM THE MARK AS SHOWN. FOR LASER LEVELS (U.S. CLS. 21, 23, 26, 36 AND 38). FIRST USE 6-1-1999; IN COMMERCE 6-1-1999.

SN 78-020,664. SYBARI SOFTWARE, INC., E. NORTHPORT, NY. FILED 8-10-2000.

EVER VIGILANT PROTECTION

NO CLAIM IS MADE TO THE EXCLUSIVE RIGHT TO USE "PROTECTION", APART FROM THE MARK AS SHOWN.

FOR COMPUTER SOFTWARE, NAMELY, SOFTWARE FOR USE WITH NETWORK AND STANDALONE COMPUTERS FOR SECURITY, DATA BASE MANAGEMENT, CONTENT MANAGEMENT AND ANTI-VIRUS PROTECTION IN GROUPWARE SYSTEMS, MANUALS FOR COMPUTER SOFTWARE LICENSED WITH THE COMPUTER SOFTWARE AS A UNIT (U.S. CLS. 21, 23, 26, 36 AND 38).

FIRST USE 3-1-2000; IN COMMERCE 3-1-2000.

SN 78-020,695. TALONSOFT, INC., BALTIMORE, MD. FILED 8-11-2000.

HOTEL TYCOON

NO CLAIM IS MADE TO THE EXCLUSIVE RIGHT TO USE "HOTEL", APART FROM THE MARK AS SHOWN.

FOR COMPUTER SOFTWARE GAMES (U.S. CLS. 21, 23, 26, 36 AND 38).

CLASS 9—(Continued).

SN 78-020,701. TALONSOFT, INC., BALTIMORE, MD. FILED 8-11-2000.

BREWERY TYCOON

NO CLAIM IS MADE TO THE EXCLUSIVE RIGHT TO USE "BREWERY", APART FROM THE MARK AS SHOWN. FOR COMPUTER SOFTWARE GAMES (U.S. CLS. 21, 23, 26, 36 AND 38).

SN 78-022,002. LANE, PAUL, SLOUGH, UNITED KINGDOM, FILED 8-20-2000.

BUTTERFLY ISLAND

OWNER OF U.S. REG. NO. 2,243,364. FOR COMPACT DISCS, MINI-DISCS, PRE-RECORDED AUDIO CASSETTES, PRE-RECORDED VIDEO CASSETTES, AND MULTIMEDIA SOFTWARE RECORDED ON CD-ROM, ALL FEATURING MUSIC; DOWNLOADABLE MUSICAL SOUND RECORDINGS (U.S. CLS. 21, 23, 26, 36 AND 38).

SN 78-022,401. H. E. WILLIAMS, INC., CARTHAGE, MO. FILED 8-22-2000.

ACCELEROPTICS

FOR FIBER OPTICS (U.S. CLS. 21, 23, 26, 36 AND 38).

SN 78-022,874. COSMIC GADGETS, L.L.C., AUSTIN, TX. FILED 8-24-2000.



FOR ACCESSORIES FOR CELLULAR TELEPHONES, NAMELY, A CELLULAR TELEPHONE ANTENNA THAT FLASHES TO SIGNAL INCOMING CALLS (U.S. CLS. 21, 23, 26, 36 AND 38).

SN 78-022,948. INNOVATIVE CONTROLS SYSTEM, INC., NAZARETH, PA. FILED 8-25-2000.

TUNNEL MASTER

NO CLAIM IS MADE TO THE EXCLUSIVE RIGHT TO USE "TUNNEL", APART FROM THE MARK AS SHOWN.

FOR COMPUTER PROGRAMS FOR CONTROL AND MANAGEMENT OF CAR WASH AND OIL CHANGE OPERATIONS (U.S. CLS. 21, 23, 26, 36 AND 38).

CLASS 9—(Continued).

SN 78-023,097. LAMBDAFLEX OPTICAL TECHNOLOGIES CORPORATION, FREMONT, CA. FILED 8-25-2000.

EQUIROUTER

FOR FIBER OPTIC COMPONENTS, MODULES AND SUBSYSTEMS THAT PERFORM BOTH DYNAMIC SWITCHING/ROUTING AS WELL AS ATTENUATION OF OPTICAL SIGNALS IN TELECOMMUNICATION NETWORKS (U.S. CLS. 21, 23, 26, 36 AND 38).

SN 78-023,350. GENMATRIX.COM, OAKLAND, CA. FILED 8-28-2000.

GENMATRIX

FOR COMPUTER SOFTWARE FOR PREDICTIVE MODELING OF PROTEIN STRUCTURES FOR LIFE SCIENCE RESEARCH (U.S. CLS. 21, 23, 26, 36 AND 38).
FIRST USE 8-0-2000; IN COMMERCE 8-0-2000.

SN 78-024,434. FOX FAMILY PROPERTIES, INC., LOS ANGELES, CA. FILED 9-5-2000.

W.I.Z.A.R.D.S.

FOR BICYCLE HELMETS; EYEGASSES AND SUNGLASSES AND CASES THEREFOR; CD ROMS, CARTRIDGES AND TAPES CONTAINING SOFTWARE PROGRAMS FEATURING GAMES, GRAPHICS AND INTERACTIVE PROGRAMS, FOR THE ENTERTAINMENT AND EDUCATION OF CHILDREN; VIDEO GAME MACHINES AND PROGRAMS THEREFOR FOR USE WITH A COMPUTER OR TELEVISION; VIDEO AND COMPUTER GAME PROGRAMS, CARTRIDGES, CASSETTES, DISCS AND TAPES; CALCULATORS; ELECTRONIC DIARIES; ELECTRONIC PERSONAL ORGANIZERS; AUDIO AND VIDEO CASSETTE PLAYERS AND RECORDERS; AUDIO AND VIDEO COMPACT DISC PLAYERS; PRERECORDED AUDIO AND VIDEO TAPES, CASSETTES, COMPACT DISCS AND PHONOGRAPH RECORDS FEATURING MUSIC AND DIALOGUE IN THE NATURE OF CHILDREN'S STORIES, PLAYS, SONGS AND DRAMAS FOR THE EDUCATION AND ENTERTAINMENT OF CHILDREN; CAMERAS; RADIOS AND RADIOS INCORPORATING CLOCKS; AND TELEPHONES (U.S. CLS. 21, 23, 26, 36 AND 38).

SN 78-025,291. MACLEOD, EDWARD N., CHELMSFORD, MA. FILED 9-11-2000.

AIRDESK

FOR COMPUTER STANDS SPECIFICALLY DESIGNED FOR HOLDING A COMPUTER AND ACCESSORIES (U.S. CLS. 21, 23, 26, 36 AND 38).

CLASS 9—(Continued).

SN 78-025,791. TRUSTED SYSTEMS, INC., SEVERNA PARK, MD. FILED 9-13-2000.

TRUSTED SYSTEMS

NO CLAIM IS MADE TO THE EXCLUSIVE RIGHT TO USE "SYSTEMS", APART FROM THE MARK AS SHOWN.
FOR ARMORED STEEL SECURITY CONTAINERS WITH AN ELECTRONIC COMBINATION LOCK, PROVIDING PROTECTION FOR COMPUTER SYSTEMS, SERVERS, PERIPHERAL DEVICES, DATA COMMUNICATIONS EQUIPMENT AND ENCRYPTION DEVICES (U.S. CLS. 21, 23, 26, 36 AND 38).
FIRST USE 9-1-1988; IN COMMERCE 9-1-1988.

SN 78-025,990. SENSE TECHNOLOGIES, INC., TAMARAC, FL. FILED 9-15-2000.

BIOCLOCK

FOR COMPUTER SOFTWARE THAT UTILIZES BIOMETRIC IDENTIFICATION TECHNOLOGY, AND SERVES AS A GRAPHICAL USER INTERFACE (U.S. CLS. 21, 23, 26, 36 AND 38).
FIRST USE 7-30-1998; IN COMMERCE 7-30-1998.

SN 78-026,013. MEAD CORPORATION, THE, DAYTON, OH. FILED 9-15-2000.

CD STUDIO

OWNER OF U.S. REG. NO. 2,445,554.
NO CLAIM IS MADE TO THE EXCLUSIVE RIGHT TO USE "CD", APART FROM THE MARK AS SHOWN.
FOR STORAGE CONTAINERS FOR HOLDING COMPUTER DISKS AND COMPACT DISKS FOR HOME AND OFFICE USE (U.S. CLS. 21, 23, 26, 36 AND 38).
FIRST USE 1-6-2001; IN COMMERCE 1-6-2001.

SN 78-026,236. JOERG, WERNER B., SALT LAKE CITY, UT. FILED 9-16-2000.

SAFESPACE

FOR COMPUTER SECURITY SOFTWARE THAT ALLOWS THE CREATION OF SECURE ENVIRONMENTS FOR COLLABORATION AND COMMUNICATION OVER THE INTERNET (U.S. CLS. 21, 23, 26, 36 AND 38).

SN 78-026,919. GENERAL SOLUTIONS, LTD., HOUSTON, TX. FILED 9-20-2000.

DIGIOP

FOR DIGITAL VIDEO RECORDER (U.S. CLS. 21, 23, 26, 36 AND 38).
FIRST USE 8-1-2000; IN COMMERCE 8-15-2000.

CLASS 9—(Continued).

SN 78-028,740. RISSA SOLUTIONS OYJ, ESPOO, FINLAND, FILED 10-3-2000.

MZIPPER

FOR INFORMATION MANAGEMENT SOFTWARE FOR CUSTOMER SERVICE SYSTEMS FOR USE BY BUSINESS TO BUSINESS CUSTOMERS IN ORDER TO IMPLEMENT SALES AND CUSTOMER SERVICE PROGRAMS (U.S. CLS. 21, 23, 26, 36 AND 38).

FIRST USE 9-21-2000; IN COMMERCE 9-25-2000.

SN 78-029,606. STARLINK, INC., AUSTIN, TX. FILED 10-7-2000.

GEON

OWNER OF U.S. REG. NOS. 2,065,497 AND 2,103,132. FOR NAVIGATIONAL EQUIPMENT, NAMELY, RADIO NAVIGATION TRANSMITTERS, RECEIVERS, ANTENNAS, AND AMPLIFIERS (U.S. CLS. 21, 23, 26, 36 AND 38).

SN 78-029,612. STARLINK, INC., AUSTIN, TX. FILED 10-7-2000.

STARLINK GEON

OWNER OF U.S. REG. NOS. 2,065,497 AND 2,103,132. FOR NAVIGATIONAL EQUIPMENT, NAMELY, RADIO NAVIGATION TRANSMITTERS, RECEIVERS, ANTENNAS, AND AMPLIFIERS (U.S. CLS. 21, 23, 26, 36 AND 38).

SN 78-031,022. POCKET PEEPERS, LLC, METAMORA, MI. FILED 10-17-2000.

POCKET PEEPERS

NO CLAIM IS MADE TO THE EXCLUSIVE RIGHT TO USE "POCKET", APART FROM THE MARK AS SHOWN. FOR READING GLASSES (U.S. CLS. 21, 23, 26, 36 AND 38).

SN 78-031,309. ANAWATY, CASS ANTHONY, LAKE OSWEGO, OR. FILED 10-18-2000.

SUNBREAK MUSIC

NO CLAIM IS MADE TO THE EXCLUSIVE RIGHT TO USE "MUSIC", APART FROM THE MARK AS SHOWN. FOR COMPACT DISCS OF MUSIC (U.S. CLS. 21, 23, 26, 36 AND 38).

CLASS 9—(Continued).

SN 78-031,377. TECH4LEARNING, INC., SAN DIEGO, CA. FILED 10-19-2000.

IMAGEBLENDER

FOR COMPUTER SOFTWARE FOR DOWNLOADING AND EDITING OF GRAPHIC IMAGES FROM AN ON-LINE DATABASE OR STORED ON THE USER'S HARD DRIVE (U.S. CLS. 21, 23, 26, 36 AND 38).

SN 78-033,529. AT&T CORP., NEW YORK, NY. FILED 11-2-2000.

QUOVATION

FOR TELECOMMUNICATIONS PRODUCTS, NAMELY, TELEPHONES; TELEPHONE SYSTEMS, COMPRISED OF A HANDSET AND CONSOLE UNIT WITH CONSOLE FEATURES, NAMELY, STANDARD TELEPHONE FUNCTIONS, ONE-TOUCH DIALING, CALL PROGRESS MONITORING GROUP LISTENING, CLOCK/CALENDAR AND ALARM, ELECTRONIC DISPLAY, AND MODULES FOR FEATURES, NAMELY, AUTOMATIC DIALING, CALL RESTRICTION, STORED MESSAGE RECALL, AND CUSTOM CALLING; CORDLESS TELEPHONES; SPEAKERPHONES, ALSO KNOWN AS HAND FREE TELEPHONE APPARATUS; TELEPHONE DIALERS; TELEPHONE STATION MESSAGE DETAIL RECORDERS; MOBILE TELECOMMUNICATION EQUIPMENT COMPRISING A CONTROL TELEPHONE UNIT, TRANSCEIVER AND ANTENNA; MOBILE TELEPHONES AND COMPONENT PARTS THEREOF; BATTERY POWER PLANTS FOR USE IN PROVIDING AND MANAGING ENERGY SUPPLY REQUIREMENTS IN THE TELECOMMUNICATIONS INDUSTRY; TELEPHONES INCORPORATING CLOCK RADIOS; COMPUTERS; LIGHTWAVE DATA LINKS, NAMELY, TRANSMITTERS AND RECEIVERS; MODEMS; TELEPHONE INSTALLATION APPARATUS, NAMELY, PHONEMOUNTS, DUAL OUTLET ADAPTORS TELEPHONE OUTLETS, MODULAR JACKS, WIRE JUNCTIONS AND PLUG-IN CONVERTERS; INTERACTIVE TELEVISION UNITS FOR ACQUISITION OF INFORMATION FROM DATA BASES; TELECOMMUNICATIONS SWITCHES; FACSIMILE MACHINES; DOCUMENT SCANNER, NAMELY, FOCUSING LENSES, IMAGE DETECTORS, MEMORY UNITS, CIRCUIT BOARDS AND INTERFACE UNITS; COMPUTER PROGRAMS FOR MANAGING TELECOMMUNICATIONS NETWORKS; VOICE AND DATA TRANSMITTING, CARRYING AND RECEIVING EQUIPMENT, NAMELY, TELECOMMUNICATION CARRIERS, CENTRAL OFFICE AND REMOTE TERMINALS, CHANNEL BANKS, ELECTRONIC PLUG-INS AND PAIR-GAIN APPARATUS; NETWORK MULTIPLEXER; DATA COMMUNICATION MULTIPLEXERS AND CONCENTRATOR; VIDEOTEX TERMINALS; AND ELECTRIC EMERGENCY CALL UNITS; TELEPHONE ANSWERING MACHINES; VIDEOPHONES, PAGERS; FIBRE OPTIC CABLE; ELECTRIC CABLE AND WIRE MADE FROM COPPER; FIBER OPTIC CONNECTORS; INTEGRATED CIRCUITS; MICROPROCESSORS; MICROPROCESSOR BASED COMMUNICATORS, NAMELY, COMPUTERIZED WRITING STYLI AND TABLETS THAT ENABLE INDIVIDUALS TO COMMUNICATE OVER A WIRED OR WIRELESS TELECOMMUNICATIONS NETWORK; VIDEO TELECONFERENCING PRODUCTS, NAMELY, SWITCHES, MODEMS, SPEAKERS AND VIDEO DISPLAY TUBES; COMPUTER PROGRAMS FOR DEVELOPING OTHER COMPUTER PROGRAMS; NETWORKING SOFTWARE WHICH FACILITATES EXCHANGE OF DATA BETWEEN TWO OR MORE COMPUTERS WITHIN A LOCAL AREA NETWORK OR A WIDE AREA NETWORK; COMPUTER OPERATING SYSTEM SOFTWARE; DATABASE MANAGEMENT AND REMOTE COLLABORATION SOFTWARE, NAMELY, SOFTWARE WHICH PERMITS SHARING OF

CLASS 9—(Continued).

APPLICATIONS BETWEEN REMOTE USERS CONNECTED BY TELEPHONE; COMPUTER SOFTWARE, NAMELY PRINT DRIVERS, COMPUTER UTILITIES, CACHE OPTIMIZATION COMPUTER PROGRAMS, NAMELY, COMPUTER PROGRAMS WHICH EFFICIENTLY STORES AND RETRIEVES PROGRAMS AND DATA IN A HIGH SPEED MEMORY SYSTEM DESIGNED TO HOLD UPCOMING TO-BE-ACCESSED AND/OR RECENTLY-ACCESSED DATA; COMPUTER SOFTWARE USED FOR INVENTORY TRACKING, DIAGNOSTIC, ELECTRONIC MESSAGING, AND SIGNATURE VERIFICATION; PROCESS MANAGEMENT SOFTWARE WHICH ENABLES USERS TO DESIGN, MANAGE, ADMINISTER, AUTOMATE BUSINESS PROCESSES; COMPUTER PROGRAMS FOR CONVERTING IMAGES INTO DIGITAL FORM FOR STORAGE ON A DATABASE; MULTIMEDIA SOFTWARE, NAMELY, COMPUTER SOFTWARE FOR FACILITATING CONFERENCES AMONG PERSONS IN DIFFERENT LOCATIONS THROUGH THE USE OF CAMERAS AND HEADSETS TO TRANSFER VOICES AND VISUAL IMAGES OF PARTICIPANTS AND TO TRANSFER DATA AMONG THE PARTICIPANTS; MEMORY STORAGE UNITS NAMELY, BLANK COMPUTER HARD DISKS AND HARD DRIVES; POINT OF SALE COMPUTER TERMINALS; AUTOMATED TELLER MACHINES; COMMUNICATIONS AND NETWORKING SYSTEMS COMPRISED OF GATEWAYS, ADAPTER BOARDS, ROUTERS, HUBS, NETWORK AND GATEWAY SERVERS AND WIRELESS NETWORK ADAPTERS; SELF-SERVICE COMPUTER TERMINALS; COMPUTER KEYBOARDS; COMPUTER DISPLAY TERMINALS, NAMELY, COMPUTER MONITORS; COMPUTER PRINTERS; COMPUTER AUTOMATED CHANGE DISPENSING DEVICES; COMPUTER HARDWARE, NAMELY, CHECK PROCESSING EQUIPMENT FOR USE IN A FINANCIAL ENVIRONMENT, NAMELY, IMAGING, SORTING, BALANCING, READING, ENCODING AND ENDORSING; OPTICAL DOCUMENT SCANNERS; COMPUTER PERIPHERAL INTERFACE BOARDS; BAR CODE SCANNERS; SIGNATURE CAPTURE DEVICES; INTEGRATED CIRCUIT CHIPS; PERSONAL COMPUTERS; LAPTOP COMPUTERS (U.S. CLS. 21, 23, 26, 36 AND 38).

SN 78-034,136. BELLSOUTH INTELLECTUAL PROPERTY CORP., WILMINGTON, DE. FILED 11-7-2000.

SALES ALLY

NO CLAIM IS MADE TO THE EXCLUSIVE RIGHT TO USE "SALES", APART FROM THE MARK AS SHOWN.

FOR COMPUTER DATABASE MANAGEMENT SYSTEM CONSISTING OF SOFTWARE PROGRAMS DESIGNED TO AUTOMATE THE PROCEDURES FOR PLANNING AND TRACKING SALES CALLS BY ELECTRONICALLY PROVIDING SALES AND MARKETING RESEARCH, ANALYSIS AND DEMOGRAPHIC INFORMATION, EQUIPPED WITH A GRAPHICAL USER INTERFACE TO AUTOMATE BUILDING TABLES, REPORTS AND DOCUMENTS AND FOR CREATING CUSTOMIZED PROPOSALS, ALL IN THE FIELD OF CLASSIFIED DIRECTORY PUBLISHING (U.S. CLS. 21, 23, 26, 36 AND 38).

SN 78-037,529. AMZI! INC., LEBANON, OH. FILED 12-1-2000.

KNOWLEDGEWRIGHT

FOR COMPUTER SOFTWARE FOR USE IN CREATING OTHER SOFTWARE EXPERT SYSTEMS USING ARTIFICIAL INTELLIGENCE (U.S. CLS. 21, 23, 26, 36 AND 38).

FIRST USE 11-20-2000; IN COMMERCE 11-20-2000.

CLASS 9—(Continued).

SN 78-038,068. PRAGMATIQ, LLC, SEATTLE, WA. FILED 12-6-2000.

QROOT

FOR COMPUTER SOFTWARE FOR ORGANIZATION, BROWSING, AND MANAGEMENT OF DISTRIBUTED INTERNET DOCUMENT AND METADATA STORAGE (U.S. CLS. 21, 23, 26, 36 AND 38).

SN 78-039,857. APPLIED PREDICTIVE TECHNOLOGIES, INC., ARLINGTON, VA. FILED 12-19-2000.

EVOLVE

FOR COMPUTER SOFTWARE FOR USE BY MARKETERS THAT USES PREDICTIVE MODELING TO RECOMMEND MARKETING TACTICS FOR COMPANIES (U.S. CLS. 21, 23, 26, 36 AND 38).

FIRST USE 12-15-2000; IN COMMERCE 12-15-2000.

SN 78-040,494. MEYER SOUND LABORATORIES, INCORPORATED, OAKLAND, CA. FILED 12-22-2000.

MEYER 3D

OWNER OF U.S. REG. NOS. 1,251,578 AND 2,147,717.
NO CLAIM IS MADE TO THE EXCLUSIVE RIGHT TO USE "3D", APART FROM THE MARK AS SHOWN.
FOR LOUDSPEAKERS (U.S. CLS. 21, 23, 26, 36 AND 38).

SN 78-040,569. BOSON SOFTWARE, INC., TAMPA, FL. FILED 12-24-2000.

BOSONSOFTWARE

FOR COMPUTER SOFTWARE FOR USE AS A PRACTICE TEST, FOR COMPUTER TRAINING AND COMPUTER CERTIFICATION (U.S. CLS. 21, 23, 26, 36 AND 38).

CLASS 9—(Continued).

SN 78-041,376. BEBE STORES, INC., BRISBANE, CA. FILED 1-2-2001.

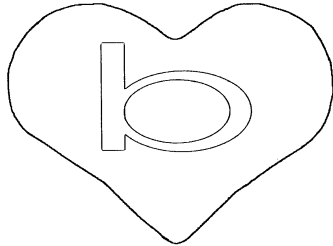

THE MARK CONSISTS OF THE LETTER "B" IN STY-
LIZED FORM APPEARING IN THE CENTER OF A STY-
LIZED HEART. THE MARK IS A HEART WITH THE
ENGRAVED LETTER "B" IN VARIOUS MATERIALS,
NAMELY METAL AND PLASTIC.

FOR SUNGLASSES, SUNGLASS CASES, FASHION
SUNGLASS FRAMES, CHAINS FOR USE ON SUN-
GLASSES AND SPECTACLES (U.S. CLS. 21, 23, 26, 36
AND 38).

FIRST USE 4-12-2000; IN COMMERCE 4-12-2000.

SN 78-042,994. INMAN INNOVATIONS, INC., ANNAPOLIS,
MD. FILED 1-12-2001.

wordpower

FOR COMPUTER HARDWARE AND SOFTWARE
THAT ARE USED BY DISABLED PERSONS TO CON-
VERT KEY STRIKES ON A KEYBOARD INTO SPOKEN
WORDS (U.S. CLS. 21, 23, 26, 36 AND 38).

FIRST USE 11-15-2000; IN COMMERCE 11-15-2000.

SN 78-044,405. LOFTIN, JEFF, SHREVEPORT, LA. FILED 1-
23-2001.

JCAMPUS

FOR SCHOOL DISTRICT ADMINISTRATIVE SYS-
TEMS SOFTWARE FOR CREATING, MANAGING, AR-
CHIVING STUDENT RECORDS STORED ON LOCAL
DISK DRIVES, AND COMMUNICATIONS, NAMELY, TO
ACCESS, VIEW AND TRANSMIT INFORMATION AND
DATA FROM AN ON-LINE DATABASE IN THE FIELD
OF EDUCATION (U.S. CLS. 21, 23, 26, 36 AND 38).

CLASS 9—(Continued).

SN 78-045,875. SOUTHERN DATACOMM, INC., LARGO, FL.
FILED 1-31-2001.

PBADMIN

FOR ADD-ON SOFTWARE IN THE NATURE OF A
SCREEN-BASED, DATABASE APPLICATION THAT
STORES APPROVED TRANSACTIONS AND AUTOMA-
TICALLY TRACKS COMPLIANCE DATA DURING
ELECTRONIC PAYMENT PROCESSING (U.S. CLS. 21,
23, 26, 36 AND 38).

FIRST USE 1-1-1994; IN COMMERCE 1-1-1994.

SN 78-046,063. HEARD, JOSHUA TAYLOR, NEWPORT
BEACH, CA. FILED 2-1-2001.

CALENDARPRO

FOR COMPUTER SOFTWARE FOR USE AS A PERSO-
NAL AND BUSINESS CALENDAR (U.S. CLS. 21, 23, 26,
36 AND 38).

FIRST USE 4-3-2000; IN COMMERCE 4-3-2000.

SN 78-047,381. ISOSENSE INC., CAVE CREEK, AZ. FILED 2-
8-2001.

ISOSENSE

FOR ELECTRIC OR ELECTRONIC SENSORS FOR
MEASURING AND DETECTING ELECTRIC CURRENT
IN ELECTRICAL CIRCUITS AND CIRCUIT COMPO-
NENTS (U.S. CLS. 21, 23, 26, 36 AND 38).

FIRST USE 1-8-1994; IN COMMERCE 12-0-1995.

SN 78-049,031. FBE ASSOCIATES, INC., BAY CITY, MI.
FILED 2-19-2001.



NO CLAIM IS MADE TO THE EXCLUSIVE RIGHT TO
USE "ASSOCIATES" AND THE UNIVERSAL PROHIBITION
SYMBOL, APART FROM THE MARK AS SHOWN.

FOR COMPUTER SOFTWARE FOR COMPUTER
AIDED ENGINEERING (U.S. CLS. 21, 23, 26, 36 AND 38).

CLASS 9—(Continued).

SN 78-049,705. EARTHQUAKE SOUND CORPORATION, MENLO PARK, CA. FILED 2-22-2001.

SUB ZERO

NO CLAIM IS MADE TO THE EXCLUSIVE RIGHT TO USE "SUB", APART FROM THE MARK AS SHOWN. FOR SPEAKERS, AUDIO AMPLIFIERS, SPEAKERS ENCLOSURES (U.S. CLS. 21, 23, 26, 36 AND 38). FIRST USE 7-10-1997; IN COMMERCE 7-10-1997.

SN 78-050,790. DESANA SYSTEMS, INC., MILPITAS, CA. FILED 3-1-2001.



DesanaSystems

NO CLAIM IS MADE TO THE EXCLUSIVE RIGHT TO USE "SYSTEMS", APART FROM THE MARK AS SHOWN.

FOR COMPUTER HARDWARE, NAMELY SWITCHES, AND COMPUTER SOFTWARE, NAMELY SWITCHING AND DATA TRANSFER PROGRAMS FOR FACILITATING APPLICATION DELIVERY OVER INFORMATION NETWORKS BY INTELLIGENTLY DETERMINING RESOURCE REQUIREMENTS, OPTIMIZING ACCESS TO BACK-END RESOURCES AND PRIORITIZING TRANSACTIONS (U.S. CLS. 21, 23, 26, 36 AND 38).

SN 78-052,043. SYBASE, INC., EMERYVILLE, CA. FILED 3-8-2001.

SYBMD

FOR COMPUTER SOFTWARE FOR DATABASE MANAGEMENT IN THE FIELD OF APPLICATIONS DEVELOPMENT AND USER MANUALS SOLD AS A UNIT THEREWITH (U.S. CLS. 21, 23, 26, 36 AND 38).

SN 78-054,354. NFOCUS.COM, DBA SWMG PRODUCTIONS, INC., PHOENIX, AZ. FILED 3-21-2001.

STUDENTTRAX

OWNER OF U.S. REG. NOS. 2,152,831, 2,363,275 AND OTHERS.

FOR COMPUTER-BASED SYSTEM COMPRISED OF DATABASE SOFTWARE AND HARDWARE, NAMELY, BAR CODE READERS FOR IDENTIFICATION CARDS, WHICH MAY INCLUDE A PHOTOGRAPH, FOR STORAGE AND RETRIEVAL OF DATA, DATA TRANSMISSION AND REPORT GENERATION REGARDING STUDENT TIME AND ATTENDANCE DATA AND COMPREHENSIVE STUDENT INFORMATION (U.S. CLS. 21, 23, 26, 36 AND 38). FIRST USE 3-1-2001; IN COMMERCE 3-1-2001.

CLASS 9—(Continued).

SN 78-054,442. MACROSYSTEM US INC., BOULDER, CO. FILED 3-22-2001.



OWNER OF U.S. REG. NO. 2,352,235. FOR VIDEO EDITORS AND VIDEO RECORDERS FOR EDITING AND CREATING VIDEO TAPES, FILMS AND MULTIMEDIA PRESENTATIONS (U.S. CLS. 21, 23, 26, 36 AND 38). FIRST USE 7-14-2000; IN COMMERCE 7-14-2000.

SN 78-055,738. WESTHILL PARTNERS, INC., NEW YORK, NY. FILED 3-29-2001.

WESTHILL SURVEY

OWNER OF U.S. REG. NO. 2,459,367. NO CLAIM IS MADE TO THE EXCLUSIVE RIGHT TO USE "SURVEY", APART FROM THE MARK AS SHOWN. FOR COMPUTER SOFTWARE FOR CONDUCTING SURVEYS AND POLLS VIA THE INTERNET, INTRANETS, AND EXTRANETS (U.S. CLS. 21, 23, 26, 36 AND 38).

SN 78-055,911. WINTERSTREAM MEDIA, INC., WALTHAM, MA. FILED 3-30-2001.

THINFEED

FOR COMPUTER PROGRAMS FOR ENHANCING THE EFFICIENCY OF TRANSMISSIONS FROM MULTIPLE CONTENT SOURCES OVER A GLOBAL COMPUTER NETWORK (U.S. CLS. 21, 23, 26, 36 AND 38).

SN 78-056,740. ENTERTAINMENT PARTNERS, BURBANK, CA. FILED 4-4-2001.

EP GLOBAL SCHEDULING

NO CLAIM IS MADE TO THE EXCLUSIVE RIGHT TO USE "GLOBAL SCHEDULING", APART FROM THE MARK AS SHOWN.

FOR COMPUTER SOFTWARE FOR CREATING A PRODUCTION SCHEDULE IN THE FILM AND TELEVISION INDUSTRY (U.S. CLS. 21, 23, 26, 36 AND 38).

CLASS 9—(Continued).

SN 78-057,191. TARGET VISION, INC., PITTSFORD, NY. FILED 4-6-2001.

TARGETVISION CONNECTS PEOPLE

OWNER OF U.S. REG. NOS. 2,388,503, 2,442,725 AND 2,444,591.

FOR CLOSED CIRCUIT COMPUTER VIDEO COMMUNICATION SYSTEMS COMPRISING SOFTWARE, PERSONAL COMPUTERS, AND VIDEO HEADEND AND DISPLAY HARDWARE USED FOR ORGANIZATIONAL COMMUNICATIONS WHERE MESSAGES ARE CREATED, SCHEDULED, DISTRIBUTED AND BROADCAST ON TELEVISION MONITORS, COMMUNICATIONS NETWORKS AND THE GLOBAL COMPUTER NETWORK SOLD AS A UNIT (U.S. CLS. 21, 23, 26, 36 AND 38).

SN 78-060,023. ESOURCE INTERNATIONAL, LLC, ACTON, MA. FILED 4-24-2001.

PICPACPLUS

FOR COMPUTER SOFTWARE FOR USE IN ORDER FULFILLMENT AND PACKAGE DISTRIBUTION (U.S. CLS. 21, 23, 26, 36 AND 38).

SN 78-062,745. ESSEN INSTRUMENTS, INC., ANN ARBOR, MI. FILED 5-9-2001.

PERIPETTE

FOR LABORATORY SUPPLIES, NAMELY, DISPOSABLE TUBE ASSEMBLY FOR STERILE FLUID TRANSFER (U.S. CLS. 21, 23, 26, 36 AND 38).

SN 78-064,663. NETMARCH TECHNOLOGIES CORPORATION, COPPELL, TX. FILED 5-21-2001.

CRSSMART

FOR COMPUTER SOFTWARE APPLICATIONS FOR PROVIDING GRAPHICAL USER INTERFACE WITH A CENTRAL COMPUTER RESERVATION SYSTEM (CRS) (U.S. CLS. 21, 23, 26, 36 AND 38).

SN 78-065,893. ENTERPRISE VAULT, INC., SALT LAKE CITY, UT. FILED 5-25-2001.

ENTERPRISE VAULT

FOR COMPUTER SOFTWARE IN THE FIELD OF ELECTRONIC DOCUMENT CREATION AND MANAGEMENT (U.S. CLS. 21, 23, 26, 36 AND 38).

CLASS 9—(Continued).

SN 78-067,557. TERMAN, PHILIP W., RIDGEWOOD, NJ. FILED 6-6-2001.

APPWATCHER

FOR COMPUTER SOFTWARE FOR USE IN IDENTIFYING AND CORRECTING FAILURES OF COMPUTER NETWORK APPLICATIONS, OPERATING SYSTEMS AND ASSOCIATED NETWORKS, AND SENDING SAID NOTIFICATION TO COMPUTER OPERATORS (U.S. CLS. 21, 23, 26, 36 AND 38).

SN 78-067,939. TRIMODUS, DALLAS, TX. FILED 6-7-2001.

VCONTROLLER

FOR COMPUTER SOFTWARE FOR USE IN LOGISTICS MANAGEMENT IN THE RAIL BULK SHIPPING INDUSTRY (U.S. CLS. 21, 23, 26, 36 AND 38).

SN 78-068,500. BLAZE NETWORK PRODUCTS, INC., DUBLIN, CA. FILED 6-11-2001.

AFTERBURNER-XGSX

FOR OPTICAL TRANSCEIVERS FOR COMPUTERS (U.S. CLS. 21, 23, 26, 36 AND 38).

SN 78-068,505. BLAZE NETWORK PRODUCTS, INC., DUBLIN, CA. FILED 6-11-2001.

AFTERBURNER-XGFC

FOR OPTICAL TRANSCEIVERS FOR COMPUTERS (U.S. CLS. 21, 23, 26, 36 AND 38).

SN 78-068,507. BLAZE NETWORK PRODUCTS, INC., DUBLIN, CA. FILED 6-11-2001.

AFTERBURNER-XGOF

FOR OPTICAL TRANSCEIVERS FOR COMPUTERS (U.S. CLS. 21, 23, 26, 36 AND 38).

SN 78-069,119. WHALEY, ROBERT E., CHAPEL HILL, NC. FILED 6-14-2001.

OPTVAL

FOR FINANCIAL SOFTWARE FOR THE VALUATION AND RISK MEASUREMENT OF DERIVATIVE SECURITIES (U.S. CLS. 21, 23, 26, 36 AND 38).

CLASS 9—(Continued).

SN 78-069,602. PURE CYCLE ENVIRONMENTAL LLC, NORTH HAVEN, CT. FILED 6-18-2001.

EDEN PURIFICATION SYSTEM

NO CLAIM IS MADE TO THE EXCLUSIVE RIGHT TO USE "PURIFICATION SYSTEM", APART FROM THE MARK AS SHOWN.

FOR ELECTRODIALYSIS FOR ELECTROLESS NICKEL RECYCLING AND REUSE (U.S. CLS. 21, 23, 26, 36 AND 38).

FIRST USE 8-24-1999; IN COMMERCE 9-8-1999.

SN 78-070,203. H&L PRODUCTS, INC., RANCHO CUCAMONGA, CA. FILED 6-20-2001.

FASHION CELLUTIONS

NO CLAIM IS MADE TO THE EXCLUSIVE RIGHT TO USE "FASHION", APART FROM THE MARK AS SHOWN.

FOR ACCESSORIES FOR CELLULAR PHONES AND PERSONAL DIGITAL ASSISTANTS, NAMELY, CASES MADE OF A FLEXIBLE MATERIAL (U.S. CLS. 21, 23, 26, 36 AND 38).

SN 78-070,615. ALTICAST, INC., AUSTIN, TX. FILED 6-22-2001.

INTERACT WITH THE FUTURE

FOR COMPUTER SOFTWARE FOR USE IN AUTHORIZING INTERACTIVE DATA SERVICE APPLICATIONS; FOR FETCHING, STORING, ENCODING, SCHEDULING, AND TRANSMITTING INTERACTIVE DATA AND APPLICATIONS OVER FIXED AND WIRELESS MEDIUM; FOR MANAGING RESOURCES UTILIZED FOR BROADCASTING DATA AND APPLICATIONS OVER FIXED AND WIRELESS MEDIUM; FOR COLLECTING AND MANAGING INTERACTIVE RESPONSES BROADCAST OVER FIXED AND WIRELESS MEDIUM; AND FOR ENABLING THE OPERATION OF FIXED AND WIRELESS TRANSCEIVERS USED TO FACILITATE INTERACTIVE OPERATIONS (U.S. CLS. 21, 23, 26, 36 AND 38).

SN 78-071,219. CONAIR CORPORATION, STAMFORD, CT. FILED 6-27-2001.

MINI WAVES

NO CLAIM IS MADE TO THE EXCLUSIVE RIGHT TO USE "WAVES", APART FROM THE MARK AS SHOWN.

FOR ELECTRIC HAIR CRIMPPING IRON WITH TWO MICRO CRIMPING PLATES USED TO TEXTURIZE HAIR (U.S. CLS. 21, 23, 26, 36 AND 38).

CLASS 9—(Continued).

SN 78-071,510. MEDTRONIC INC., MINNEAPOLIS, MN. FILED 6-28-2001.

MEDTRONIC CARELINK

OWNER OF U.S. REG. NOS. 989,169, 1,402,100 AND OTHERS.

FOR COMPUTER SOFTWARE PROVIDING INFORMATION TO MEDICAL PROFESSIONALS (U.S. CLS. 21, 23, 26, 36 AND 38).

SN 78-072,366. ARRIS, LLC, DBA SIGMA DESIGN, ALEXANDRIA, LA. FILED 7-5-2001.

EZMEETING

OWNER OF U.S. REG. NO. 2,435,965.

FOR COMPUTER SOFTWARE FOR INTERACTIVELY VIEWING AND EDITING COMPUTER GRAPHIC FILES, INCLUDING BOTH TWO DIMENSIONAL AND THREE DIMENSIONAL COMPUTER AIDED DESIGN DRAWINGS AND MODELS, VIA A GLOBAL COMPUTER NETWORK (U.S. CLS. 21, 23, 26, 36 AND 38).

SN 78-072,710. ON GUARD PLUS LLC, BOCA RATON, FL. FILED 7-6-2001.

VQVOICE

FOR INTERACTIVE VOICE VERIFICATION SYSTEMS COMPRISING COMPUTER HARDWARE AND OPERATING SYSTEMS SOFTWARE AND APPLICATIONS SOFTWARE FOR USE IN IDENTIFYING AND VERIFYING VOICES OF SYSTEM USERS, USED IN THE CRIMINAL JUSTICE FIELD; COMPUTER SOFTWARE DEVELOPMENT TOOLS, COMPUTER UTILITY PROGRAMS; AND INSTRUCTION MANUALS SOLD AS A UNIT THEREWITH (U.S. CLS. 21, 23, 26, 36 AND 38).

SN 78-073,238. MILLER, CHARLES W., RALEIGH, NC. FILED 7-10-2001.

GRANDMA

FOR SOFTWARE INTERFACE FOR COMPUTERS RUNNING MULTITASKING OPERATING SYSTEMS (U.S. CLS. 21, 23, 26, 36 AND 38).

SN 78-073,703. BALLY GAMING INTERNATIONAL, INC., LAS VEGAS, NV. FILED 7-12-2001.

HOT LINES

FOR GAMING DEVICES, NAMELY SLOT MACHINES, WITH OR WITHOUT VIDEO OUTPUT (U.S. CLS. 21, 23, 26, 36 AND 38).

CLASS 9—(Continued).

SN 78-074,741. BALANCO, TEM, SAN FRANCISCO, CA. FILED 7-19-2001.

CLIPKEE

FOR ADD-ON KEYBOARD DEVICE FOR HANDHELD COMPUTERS, PERSONAL DIGITAL ASSISTANTS, AND CELLULAR PHONES (U.S. CLS. 21, 23, 26, 36 AND 38).

SN 78-074,777. RIOSCAN, INC., BALTIMORE, MD. FILED 7-19-2001.



FOR COMPUTER SOFTWARE, NAMELY A FAMILY OF COMPUTER SOFTWARE PRODUCTS USED TO MANAGE BAR CODE DATA AND DATABASES (U.S. CLS. 21, 23, 26, 36 AND 38).
FIRST USE 9-15-2000; IN COMMERCE 1-15-2001.

SN 78-075,065. MUNRO, BARRY VIGILANTI, MARIETTA, GA. FILED 7-22-2001.

VIDGE

FOR SERIES OF MUSICAL SOUND RECORDINGS (U.S. CLS. 21, 23, 26, 36 AND 38).

SN 78-076,367. HALTER, JOHN ALAN, FRESNO, TX. FILED 7-30-2001.

LIFESIM

FOR COMPUTER SOFTWARE FOR PROVIDING COMPUTER SIMULATIONS OF LIVING SYSTEMS AS DEFINED BY MATHEMATICAL DESCRIPTIONS FOR BIOMEDICAL APPLICATIONS (U.S. CLS. 21, 23, 26, 36 AND 38).

CLASS 9—(Continued).

SN 78-076,378. BIOMICRO SYSTEMS, INC., SANDY, UT. FILED 7-30-2001.

THE NEXT STEP IN MICRO FLUID ANALYSIS

FOR MICROFLUIDIC COMPONENTS, NAMELY MICROFLUIDIC PUMPS, WELLS, CHANNELS, MIXERS, AND SEPARATORS, AND SYSTEMS COMPRISED OF THE ABOVE MICROFLUIDIC COMPONENTS FOR BIOLOGICAL AND CHEMICAL ANALYSIS (U.S. CLS. 21, 23, 26, 36 AND 38).

SN 78-076,750. AUTOMATION CENTRE, LC, TUCSON, AZ. FILED 7-31-2001.

TRACKEROFFICE

FOR COMPUTER SOFTWARE FOR AUTOMATING BUSINESS PROCESSES, NAMELY PROJECT MANAGEMENT, PERSONNEL MANAGEMENT, TIMEKEEPING, PURCHASING, EXPENSE REPORTING, SALES FORCE MANAGEMENT, CUSTOMER SERVICE, FINANCIAL REPORTING, JOB COSTING, RESOURCE LOADING, MARKETING, AND PREPARING SALES PROJECTIONS (U.S. CLS. 21, 23, 26, 36 AND 38).
FIRST USE 1-1-1999; IN COMMERCE 1-1-1999.

SN 78-077,172. YUASA BATTERY, INC., READING, PA. FILED 8-2-2001.



FOR BATTERY CHARGERS (U.S. CLS. 21, 23, 26, 36 AND 38).

SN 78-077,949. MCGUINNESS FUNERAL HOME, INC., WOODBURY, NJ. FILED 8-7-2001.

REMEMBERING LIFE EVERYDAY

FOR PRERECORDED VIDEO CASSETTES ABOUT THE LIFE OF THE DECEASED PRESENTED AS A TRIBUTE TO THE DECEASED (U.S. CLS. 21, 23, 26, 36 AND 38).
FIRST USE 2-16-2001; IN COMMERCE 2-16-2001.

CLASS 9—(Continued).

SN 78-078,789. URBAN, JEFF, E DBA URBAN RESEARCH, DBA URBAN RESEARCH, MINNEAPOLIS, MN. FILED 8-12-2001.

URSQL

FOR COMPUTER SOFTWARE FOR DATABASE ACCESS PURPOSES; COMPUTER SOFTWARE FOR DATABASE MANAGEMENT PURPOSES; COMPUTER SOFTWARE FOR DATABASE QUERY PURPOSES; COMPUTER SOFTWARE FOR SQL EDITING PURPOSES; COMPUTER SOFTWARE FOR DATA CONVERSION PURPOSES; COMPUTER SOFTWARE FOR DATA EXPORTING PURPOSES; COMPUTER SOFTWARE FOR DATA REPORTING PURPOSES; COMPUTER SOFTWARE FOR TEXT EDITING PURPOSES (U.S. CLS. 21, 23, 26, 36 AND 38).

FIRST USE 0-0-1996; IN COMMERCE 0-0-1996.

SN 78-079,165. PROGRESSIVE MICROTECHNOLOGY, INC., CINCINNATI, OH. FILED 8-14-2001.

PMI EVIDENCE TRACKER

NO CLAIM IS MADE TO THE EXCLUSIVE RIGHT TO USE "EVIDENCE TRACKER", APART FROM THE MARK AS SHOWN.

FOR COMPUTER SOFTWARE FOR MANAGING AND TRACKING EVIDENCE BY POLICE DEPARTMENTS AND COURT SYSTEMS (U.S. CLS. 21, 23, 26, 36 AND 38).

SN 78-079,413. INTEGRATED DECISION SYSTEMS, INC., LOS ANGELES, CA. FILED 8-15-2001.

GIM2

OWNER OF U.S. REG. NO. 2,158,351.
FOR COMPUTER SOFTWARE FOR USE IN PORTFOLIO ADMINISTRATION AND ACCOUNTING (U.S. CLS. 21, 23, 26, 36 AND 38).

SN 78-079,418. ALLEGIANCE CORPORATION, MCGAW PARK, IL. FILED 8-15-2001.

DURA-TRAC

FOR PROTECTIVE APPAREL, NAMELY, SHOE COVERS FOR INDUSTRIAL USE (U.S. CLS. 21, 23, 26, 36 AND 38).

CLASS 9—(Continued).

SN 78-079,493. WMS GAMING INC., WAUKEGAN, IL. FILED 8-16-2001.

HOT PROPERTIES

FOR CURRENCY AND CREDIT OPERATED SLOT MACHINES AND GAMING DEVICES, NAMELY, GAMING MACHINES FOR USE IN GAMING ESTABLISHMENTS (U.S. CLS. 21, 23, 26, 36 AND 38).

SN 78-079,740. WGBH EDUCATIONAL FOUNDATION, BOSTON, MA. FILED 8-17-2001.

**DISCOVERING AMERICA'S
HIDDEN TREASURES**

NO CLAIM IS MADE TO THE EXCLUSIVE RIGHT TO USE "AMERICA'S", APART FROM THE MARK AS SHOWN. FOR PRE-RECORDED VIDEO CASSETTES ON THE SUBJECT OF ANTIQUES AND ANTIQUE APPRAISAL (U.S. CLS. 21, 23, 26, 36 AND 38).

FIRST USE 2-1-1997; IN COMMERCE 2-1-1997.

SN 78-080,109. NATIONAL STUDY OF SCHOOL EVALUATION, SCHAUMBURG, IL. FILED 8-20-2001.

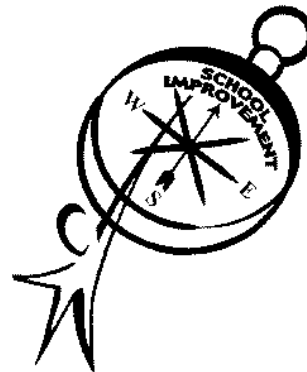

NO CLAIM IS MADE TO THE EXCLUSIVE RIGHT TO USE "SCHOOL IMPROVEMENT", APART FROM THE MARK AS SHOWN.

FOR SCHOOL IMPROVEMENT SOFTWARE TOOLS FOR KNOWLEDGE MANAGEMENT AND DATA-DRIVEN DECISION MAKING, NAMELY, A COMPREHENSIVE SET OF TOOLS TO COLLECT, MANAGE, QUERY, ANALYZE, GRAPH AND REPORT PERTINENT DATA AND INFORMATION FOR EACH PHASE OF A SCHOOL IMPROVEMENT PLANNING PROCESS (U.S. CLS. 21, 23, 26, 36 AND 38).

FIRST USE 12-8-2000; IN COMMERCE 12-8-2000.

CLASS 9—(Continued).

SN 78-083,015. SUSSMAN, LESTER, BETHESDA, MD. FILED 9-7-2001.

PCCI

FOR COMPUTER HARDWARE AND SOFTWARE FOR PERSONAL CONSUMER COMMUNICATIONS (PERSONAL CONSUMER COMMUNICATIONS INDUSTRY) (U.S. CLS. 21, 23, 26, 36 AND 38).

CLASS 9—(Continued).

SN 78-086,193. BALLY GAMING INTERNATIONAL, INC., LAS VEGAS, NV. FILED 9-28-2001.

MONEY BARS

FOR GAMING DEVICES, NAMELY SLOT MACHINES, WITH OR WITHOUT VIDEO OUTPUT (U.S. CLS. 21, 23, 26, 36 AND 38).

SN 78-083,746. AETHER SYSTEMS, INC., OWINGS MILLS, MD. FILED 9-13-2001.

AETHER AIRLEAD

FOR COMPUTER SOFTWARE FOR USE IN MONITORING, DISTRIBUTING, ACCOUNTING FOR, TRACKING AND MANAGING INQUIRIES FROM CUSTOMERS AND PROSPECTS (U.S. CLS. 21, 23, 26, 36 AND 38).

SN 78-086,195. BALLY GAMING INTERNATIONAL, INC., LAS VEGAS, NV. FILED 9-28-2001.

PEARLY GATES

FOR GAMING DEVICES, NAMELY SLOT MACHINES, WITH OR WITHOUT VIDEO OUTPUT (U.S. CLS. 21, 23, 26, 36 AND 38).

SN 78-084,167. TOWN & COUNTRY APPAREL CO., DBA OUTDOOR ADVENTURES PRODUCTS, HOPKINS, MN. FILED 9-17-2001.

TOWN & COUNTRY

FOR SUNGLASSES, EYEWEAR LENSES, EYEWEAR FRAMES (U.S. CLS. 21, 23, 26, 36 AND 38).

CLASS 10—MEDICAL APPARATUS

SN 74-531,368. X-LIDE KABUSHIKI KAISHA, TOSU-SHI, SAGA 841, JAPAN, FILED 5-31-1994.

KEY-Filter

OWNER OF JAPAN REG. NO. 3205199, DATED 9-21-1998, EXPIRES 9-21-2008.

OWNER OF JAPAN REG. NO. 3205199, DATED 9-30-1996, EXPIRES 9-30-2006.

FOR PARTS FOR MEDICAL X-RAY EQUIPMENT (U.S. CLS. 26, 39 AND 44).

SN 78-084,236. MCDATA CORPORATION, BROOMFIELD, CO. FILED 9-17-2001.

SANFLEX

FOR COMPUTER HARDWARE; COMPUTER SOFTWARE FOR USE IN MANAGING AND MAINTAINING COMPUTER NETWORKS AND DATA STORAGE SYSTEMS (U.S. CLS. 21, 23, 26, 36 AND 38).

SN 75-283,631. TELEMEDIC SYSTEMS, INC., REDMOND, WA. FILED 4-29-1997.

VITALLINK

FOR ELECTRONIC MEDICAL DIAGNOSTIC UNITS COMPRISING AT LEAST TWO OF PATIENT PULSE, RESPIRATION AND TEMPERATURE MONITORS, WITH VOICE AND DATA COMMUNICATIONS FOR USE IN TELEMEDICINE TO ALLOW MEDICAL CONSULTATION AND ADVICE BETWEEN PHYSICIANS OR MEDICAL ADVISORS AND THEIR PATIENTS LOCATED REMOTE FROM EACH OTHER (U.S. CLS. 26, 39 AND 44).

SN 78-086,189. BALLY GAMING INTERNATIONAL, INC., LAS VEGAS, NV. FILED 9-28-2001.

BONUS FRENZY

FOR GAMING DEVICES, NAMELY SLOT MACHINES, WITH OR WITHOUT VIDEO OUTPUT (U.S. CLS. 21, 23, 26, 36 AND 38).

CLASS 10—(Continued).

SN 75-339,514. BIODOME, 63500 ISSOIRE, FRANCE, FILED 6-24-1997.

BIODOME

PRIORITY CLAIMED UNDER SEC. 44(D) ON ERP N CMNTY TM OFC APPLICATION NO. 471060, FILED 2-7-1997, REG. NO. 000471060, DATED 7-14-1999, EXPIRES 2-7-2007.

FOR AEROSOL DISPENSERS FOR MEDICAL USE; SURGICAL CLIPS; NEEDLES FOR MEDICAL USE; SURGICAL CATHETERS; DROPPERS FOR ADMINISTERING MEDICATION, SOLD EMPTY; SPOONS FOR ADMINISTERING MEDICINE; WOUND DRAINAGE APPARATUS; DROPPER BOTTLES FOR ADMINISTERING MEDICATION, SOLD EMPTY; GIRDLES FOR MEDICAL USE; GLOVES FOR MASSAGES; HYPODERMIC SYRINGES; MEDICAL APPARATUS, NAMELY, INJECTORS FOR ADMINISTERING PHARMACEUTICALS SOLD EMPTY; LANCETS; CASES FITTED FOR MEDICAL INSTRUMENTS; PUMP-ACTION SPRAYERS FOR ADMINISTERING TOPICAL PHARMACEUTICALS SOLD EMPTY; CONTAINERS FOR APPLYING MEDICINES BY INFUSION AND INJECTION; SCALPELS; SYRINGES FOR MEDICAL USE; URETHRAL SYRINGES; UTERINE SYRINGES; AND VAGINAL SYRINGES (U.S. CLS. 26, 39 AND 44).

SN 75-609,601. ISOTRON, INC., ALPHARETTA, GA. FILED 12-21-1998.

ISOTRON

FOR MEDICAL DEVICE AND APPARATUS, NAMELY, BRACHYTHERAPY RADIATION SYSTEM FOR CANCER TREATMENT COMPRISED OF A RADIATION SOURCE, REMOTE AFTER LOADER, CATHETER AND COMPUTER SOFTWARE USED TO DIAGNOSE AND TREAT CANCER (U.S. CLS. 26, 39 AND 44).

SN 75-698,396. DISETRONIC LICENSING AG, 3401 BURG-DORF, SWITZERLAND, FILED 5-5-1999.



PRIORITY CLAIMED UNDER SEC. 44(D) ON SWITZERLAND APPLICATION NO. 09172/1998, FILED 11-6-1998, REG. NO. 462627, DATED 11-6-1998, EXPIRES 11-6-2008.

THE MARK ON THE DRAWING IS LINED FOR THE COLOR RED.

FOR MEDICAL AND VETERINARY INSTRUMENTS AND APPARATUSES, NAMELY, CATHETERS FOR THE SUBCUTANEOUS ADMINISTRATION OF DRUGS (U.S. CLS. 26, 39 AND 44).

FIRST USE 9-0-1995; IN COMMERCE 9-0-1995.

CLASS 10—(Continued).

SN 75-699,823. ISOTRON, INC., ALPHARETTA, GA. FILED 5-4-1999.

ISOTRON NEUTRON BRACHYTHERAPY

NO CLAIM IS MADE TO THE EXCLUSIVE RIGHT TO USE "NEUTRON BRACHYTHERAPY", APART FROM THE MARK AS SHOWN.

FOR MEDICAL DEVICE AND APPARATUS, NAMELY, BRACHYTHERAPY RADIATION SYSTEM FOR CANCER TREATMENT COMPRISED OF A RADIATION SOURCE, REMOTE AFTER LOADER, CATHETER AND COMPUTER SOFTWARE USED TO DIAGNOSE AND TREAT CANCER (U.S. CLS. 26, 39 AND 44).

SN 75-804,767. HORIZON MEDICAL PRODUCTS, INC., ATLANTA, GA. FILED 9-20-1999.

VORTEX

FOR IMPLANTABLE VENOUS ACCESS PORT (U.S. CLS. 26, 39 AND 44).
FIRST USE 5-24-1996; IN COMMERCE 5-24-1996.

SN 75-862,374. MEDASONICS, INC., NEWARK, CA. FILED 12-1-1999.

BLENDED BEAM

NO CLAIM IS MADE TO THE EXCLUSIVE RIGHT TO USE "BEAM", APART FROM THE MARK AS SHOWN.

FOR ULTRASOUND DOPPLERS FOR MEDICAL USE (U.S. CLS. 26, 39 AND 44).

SN 75-877,663. HELPING HAND COMPANY (LEDBURY) LIMITED, THE, HEREFORD, UNITED KINGDOM, FILED 12-22-1999.

SKYFRAME

PRIORITY CLAIMED UNDER SEC. 44(D) ON UNITED KINGDOM APPLICATION NO. 2201685, FILED 7-1-1999, REG. NO. 2201685, DATED 7-1-1999, EXPIRES 7-1-2009.

FOR HOIST AND OVERHEAD TRACKING APPARATUS FOR LIFTING, CARRYING AND MOVING INVALID PATIENTS (U.S. CLS. 26, 39 AND 44).

CLASS 10—(Continued).

SN 75-886,778. RECHERCHES ET TECHNIQUES DENTAIRE - R.T.D., SAINT-EGREVE, FRANCE, FILED 1-5-2000.

LIGHT-POST

PRIORITY CLAIMED UNDER SEC. 44(D) ON FRANCE APPLICATION NO. 99801178, FILED 7-5-1999, REG. NO. 99801178, DATED 12-17-1999, EXPIRES 7-4-2009.

FOR SURGICAL, MEDICAL, DENTAL AND VETERINARY INSTRUMENTS AND APPARATUS, NAMELY, ARTIFICIAL TEETH AND DENTAL TENON PIVOTS (U.S. CLS. 26, 39 AND 44).

SN 75-892,749. GIVEN IMAGING LTD., YOKNEAM ILITE 20692, ISRAEL, FILED 1-10-2000.

M2A

PRIORITY CLAIMED UNDER SEC. 44(D) ON ISRAEL APPLICATION NO. 132191, FILED 11-11-1999, REG. NO. 132191, DATED 11-11-1999, EXPIRES 11-11-2006.

FOR VIDEO CAPSULE FOR USE IN MEDICAL DIAGNOSIS, NAMELY, ELECTRONIC CAPSULE WHICH IS SWALLOWED, MOVES THROUGH THE DIGESTIVE TRACT AND IS EXCRETED FOR USE IN DIAGNOSING DISEASES OF THE GASTROINTESTINAL TRACT (U.S. CLS. 26, 39 AND 44).

SN 76-016,451. FEMCARE (CYPRUS) LIMITED, LIMASSOL, CYPRUS, FILED 4-3-2000.

FEMCARE UROLOGY

OWNER OF U.S. REG. NO. 1.856.674.

NO CLAIM IS MADE TO THE EXCLUSIVE RIGHT TO USE "UROLOGY", APART FROM THE MARK AS SHOWN.

FOR SURGICAL AND MEDICAL INSTRUMENTS AND APPARATUS, NAMELY, CLAMPS, CLIPS, APPLICATORS AND RELATED APPARATUS FOR USE IN MALE AND FEMALE STERILIZATION, CATHETERS AND CATHETERS INTRODUCERS, PARTS AND FITTINGS FOR CATHETERS, FEMORAL SPONGES, SPATULAS, SUPPORT SPONGES FOR STRESS INCONTINENCE, NEEDLES FOR BLADDER NECK SUSPENSION, SPATULAS FOR CELL SAMPLING; HORMONE REPLACEMENT APPARATUS; APPARATUS FOR SAMPLING OF CHRONIC VILLI-INFUSION CONTROLLERS (U.S. CLS. 26, 39 AND 44).

SN 76-017,583. TORNIER S.A., SAINT ISMIER, FRANCE, FILED 4-4-2000.

LATITUDE

FOR ELBOW PROSTHESES (U.S. CLS. 26, 39 AND 44).

CLASS 10—(Continued).

SN 76-039,589. GAYMAR INDUSTRIES, INC., ORCHARD PARK, NY. FILED 5-3-2000.

K-MOD

OWNER OF U.S. REG. NO. 687,635.

FOR MEDICAL EQUIPMENT, NAMELY, HEAT THERAPY PUMPS PROVIDING A MEDIUM TO A MATTRESS OR A COOLING PAD OR A HEATING PAD (U.S. CLS. 26, 39 AND 44).

FIRST USE 12-31-1994; IN COMMERCE 12-31-1994.

SN 76-045,127. DCS ENTERPRISES, INC., BIRMINGHAM, AL. FILED 5-10-2000.



NO CLAIM IS MADE TO THE EXCLUSIVE RIGHT TO USE "SYSTEM", APART FROM THE MARK AS SHOWN.

FOR ORTHOPEDIC LUMBAR SYSTEMS COMPRISED PRIMARILY OF ORTHOPEDIC SEATS, ORTHOPEDIC SEAT CUSHIONS, ORTHOPEDIC BACK SUPPORTS, ORTHOPEDIC BACK RESTS, ORTHOPEDIC LUMBAR SUPPORTS, ORTHOPEDIC PILLOWS, ORTHOPEDIC PADS, ORTHOPEDIC CUSHIONS, AND ORTHOPEDIC LUMBAR PILLOWS (U.S. CLS. 26, 39 AND 44).

SN 76-045,943. VITA MEDICAL LIMITED, LUCAS HEIGHTS, NEW SOUTH WALES 2234, AUSTRALIA, FILED 5-11-2000.

TECHNEGAS

FOR MEDICAL DIAGNOSTIC IMAGING EQUIPMENT, NAMELY NUCLEAR DIAGNOSTIC IMAGING EQUIPMENT, CRUCIBLES WHICH ARE COMPONENT PARTS OF NUCLEAR DIAGNOSTIC IMAGING EQUIPMENT AND FACE MASKS FOR MEDICAL USE (U.S. CLS. 26, 39 AND 44).

SN 76-067,930. SMITH & NEPHEW, INC., MEMPHIS, TN. FILED 6-12-2000.

VORTEX

FOR MEDICAL APPARATUS NAMELY, A CEMENT MIXER FOR USE IN ORTHOPEDIC APPLICATIONS (U.S. CLS. 26, 39 AND 44).

CLASS 10—(Continued).

SN 76-068,847. ADVANCED CARDIOVASCULAR SYSTEMS, INC., SANTA CLARA, CA. FILED 6-12-2000.

MULTI-LINK PENTA

OWNER OF U.S. REG. NO. 2,012,389.
FOR BALLOON CATHETERS (U.S. CLS. 26, 39 AND 44).

SN 76-078,749. ARTES MEDICAL USA, INC., SAN DIEGO, CA. FILED 6-27-2000.

CREATIVE MICROSPHERES

NO CLAIM IS MADE TO THE EXCLUSIVE RIGHT TO USE "MICROSPHERES", APART FROM THE MARK AS SHOWN.

FOR MEDICAL DEVICES, NAMELY, IMPLANTS OF NON-LIVING MATERIALS TO BE INSERTED INTO LIVING TISSUE; DEVICES USED FOR IMPLANTATION SURGERY AND FOR TISSUE RECONSTRUCTION OR AUGMENTATION, NAMELY, GASTROSCOPES, CATHETERS, SYRINGES, NEEDLES, AND RELATED DEVICES FOR EXAMINING AND PERFORMING SURGICAL OPERATIONS ON BODY PASSAGES (U.S. CLS. 26, 39 AND 44).

SN 76-088,276. ORATEC INTERVENTIONS, INC., MENLO PARK, CA. FILED 7-12-2000.

NEM

FOR MEDICAL APPARATUS, NAMELY, ELECTRICAL CIRCUITRY AND SOFTWARE TO ENHANCE PATIENT SAFETY SOLD AS COMPONENT FEATURES OF RADIO FREQUENCY ELECTROSURGICAL GENERATORS (U.S. CLS. 26, 39 AND 44).

FIRST USE 11-19-1999; IN COMMERCE 11-19-1999.

SN 76-112,071. ENDOVASCULAR TECHNOLOGIES, MENLO PARK, CA. FILED 8-17-2000.

LITESPEED

FOR MEDICAL DEVICES IN THE NATURE OF AN ENDOVASCULAR GRAFTING SYSTEM USED IN ENDOVASCULAR PROCEDURES, IN THE NATURE OF GRAFTS, CATHETERS, WIRES, STENTS AND SYNTHETIC VASCULAR GRAFTS (U.S. CLS. 26, 39 AND 44).

CLASS 10—(Continued).

SN 76-113,586. ROSCH AG MEDIZINTECHNIK, D-12349 BERLIN, FED REP GERMANY, FILED 8-16-2000.

ROEJEX

OWNER OF FED REP GERMANY REG. NO. 30000363, DATED 6-15-2000, EXPIRES 1-31-2010.

FOR MEDICAL DEVICES, NAMELY NEEDLESS INJECTIONS SYSTEM FOR DELIVERING MEDICATIONS, SOLD EMPTY, CONSISTING ESSENTIALLY OF NEEDLE-FREE INJECTORS, DISPOSABLE NEEDLE-FREE AMPULES, COOKING AND CARRYING CASES FOR NEEDLE-FREE INJECTORS, FLUID TRANSFER COUPLERS AND ACCESSORIES THEREFOR (U.S. CLS. 26, 39 AND 44).

SN 76-125,170. ORTHOPAEDIC BIOSYSTEMS LTD., INC., MEMPHIS, TN. FILED 9-8-2000.

ELITE

FOR SURGICAL INSTRUMENTS, NAMELY, ARTHROSCOPIC INSTRUMENTS FOR GRASPING TISSUE AND SUTURES, PIERCING, CUTTING, DRILLING AND STITCHING TISSUE, AND MANIPULATING SUTURES (U.S. CLS. 26, 39 AND 44).

FIRST USE 5-15-1999; IN COMMERCE 5-15-1999.

SN 76-125,172. ORTHOPAEDIC BIOSYSTEMS LTD., INC., MEMPHIS, TN. FILED 9-8-2000.

ELITE SHOULDER SYSTEM

NO CLAIM IS MADE TO THE EXCLUSIVE RIGHT TO USE "SHOULDER SYSTEM", APART FROM THE MARK AS SHOWN.

FOR SURGICAL INSTRUMENTS, NAMELY, ARTHROSCOPIC INSTRUMENTS FOR GRASPING TISSUE AND SUTURES, PIERCING, CUTTING, DRILLING AND STITCHING TISSUE, AND MANIPULATING SUTURES (U.S. CLS. 26, 39 AND 44).

FIRST USE 5-15-1999; IN COMMERCE 5-15-1999.

SN 76-128,866. CBITE, INC., CLIFTON, VA. FILED 9-18-2000.

CBITE

FOR MEDICAL APPARATUS, NAMELY, DENTAL ARTICULATORS AND PARTS AND FITTINGS FOR DENTAL ARTICULATORS (U.S. CLS. 26, 39 AND 44).

FIRST USE 2-20-2000; IN COMMERCE 2-26-2000.

CLASS 10—(Continued).

SN 76-133,212. INSTRUMED, INC., WOODINVILLE, WA. FILED 9-22-2000.

SMARTPUMP

FOR TOURNIQUET INFLATION SYSTEMS COMPRISED PRIMARILY OF INFLATION CONTROLLERS AND MONITORING EQUIPMENT (U.S. CLS. 26, 39 AND 44).

FIRST USE 2-0-1999; IN COMMERCE 2-0-1999.

CLASS 10—(Continued).

SN 76-153,001. ALDECOA, D EDUARDO ANITUA, 01005-VITORIA, SPAIN, FILED 10-24-2000.



FOR SURGICAL DENTAL IMPLANTS COMPRISING ARTIFICIAL MATERIAL; DENTAL CROWNS (U.S. CLS. 26, 39 AND 44).

SN 76-135,624. ELLMAN INTERNATIONAL, INC., HEWLETT, NY. FILED 9-27-2000.

EMPIRE

FOR NEEDLE ELECTRODES FOR USE IN ELECTRO-SURGERY (U.S. CLS. 26, 39 AND 44).

FIRST USE 10-11-1999; IN COMMERCE 10-11-1999.

SN 76-155,329. VAN RYN, MARY J., OVERLAND PARK, KS. FILED 10-27-2000.

TEAM SCRUBS

NO CLAIM IS MADE TO THE EXCLUSIVE RIGHT TO USE "SCRUBS", APART FROM THE MARK AS SHOWN.

FOR MEDICAL SCRUB APPAREL, NAMELY, SCRUB SUITS, SURGICAL CAPS, SURGICAL SHIRTS, SURGICAL JACKETS AND SURGICAL PANTS (U.S. CLS. 26, 39 AND 44).

SN 76-148,727. ORTHOTIC MOBILITY SYSTEMS, INC., KENSINGTON, MD. FILED 10-17-2000.

SURE FOOT

FOR WALKING CANES FOR MEDICAL PURPOSES (U.S. CLS. 26, 39 AND 44).

FIRST USE 8-23-2000; IN COMMERCE 8-23-2000.

SN 76-155,923. PHE, INC., HILLSBOROUGH, NC. FILED 10-24-2000.

HARD RIDER

FOR CONDOMS (U.S. CLS. 26, 39 AND 44). FIRST USE 5-0-1996; IN COMMERCE 5-0-1996.

SN 76-152,483. ARCELUS, ALMUDENA, BELMONT, MA. FILED 10-24-2000.

CARDIO AMIGO

NO CLAIM IS MADE TO THE EXCLUSIVE RIGHT TO USE "CARDIO", APART FROM THE MARK AS SHOWN. THE ENGLISH TRANSLATION OF "AMIGO" IS "FRIEND".

FOR PERSONAL CARDIAC MONITORS (U.S. CLS. 26, 39 AND 44).

SN 76-177,860. M.B.A., S.A., 54000 NANCY, FRANCE, FILED 12-8-2000.

MEMOGRAPH

OWNER OF FRANCE REG. NO. 94528349, DATED 7-6-1994, EXPIRES 7-6-2004.

FOR METALLIC SURGICAL STAPLES (U.S. CLS. 26, 39 AND 44).

CLASS 10—(Continued).

SN 76-187,123. HDC CORPORATION, SAN JOSE, CA. FILED 12-27-2000.

CHEMO-PORT

SEC. 2(F).
FOR PATIENT IMPLANTABLE FLUID DELIVERY APPARATUS AND STRUCTURAL PARTS THEREOF (U.S. CLS. 26, 39 AND 44).
FIRST USE 7-1-1985; IN COMMERCE 7-1-1985.

SN 76-223,986. PHONAK HOLDING AG, CH-8712 STAFA, SWITZERLAND, FILED 3-14-2001.

AURIS

PRIORITY CLAIMED UNDER SEC. 44(D) ON SWITZERLAND APPLICATION NO. 11254/2000, FILED 9-20-2000, REG. NO. 478936, DATED 9-20-2000, EXPIRES 9-20-2010.
FOR HEARING AIDS FOR THE DEAF AND PARTS THEREOF; WIRELESS TRANSMITTERS AND RECEIVERS FOR USE WITH HEARING AIDS FOR THE DEAF AND PARTS THEREOF (U.S. CLS. 26, 39 AND 44).

SN 76-225,371. SUNRISE MACHINE & TOOL, INC., DE-TROIT LAKES, MN. FILED 3-14-2001.

THRIFTY LIFT COMPANY

NO CLAIM IS MADE TO THE EXCLUSIVE RIGHT TO USE "LIFT COMPANY", APART FROM THE MARK AS SHOWN.
FOR LIFTS, NAMELY LIFTS FOR ASSISTING IN MOVING HANDICAPPED AND INCAPACITATED HUMANS AND SUPPLIES IN BOTH HOME AND VARIOUS HEALTH CARE SITUATIONS (U.S. CLS. 26, 39 AND 44).
FIRST USE 3-13-2001; IN COMMERCE 3-13-2001.

SN 76-237,678. CAPE HATTERAS MANAGEMENT, LIMITED, CORK, IRELAND, FILED 4-3-2001.

THE PERSONAL MASSEUSE

FOR MASSAGE MAT (U.S. CLS. 26, 39 AND 44).

CLASS 10—(Continued).

SN 76-242,327. OMRON CORPORATION, KYOTO, JAPAN, FILED 4-18-2001.

Fit Cuff 

NO CLAIM IS MADE TO THE EXCLUSIVE RIGHT TO USE "CUFF", APART FROM THE MARK AS SHOWN.
FOR SPHYGMOMANOMETERS, CUFFS FOR SPHYGMOMANOMETERS (U.S. CLS. 26, 39 AND 44).

SN 76-244,018. GREAT LAKES ORTHODONTICS, LTD., TONAWANDA, NY. FILED 4-20-2001.

ENDURE

FOR MATERIAL FOR FABRICATION OF ORTHODONTIC APPLIANCES, NAMELY, RETAINERS AND MOUTHGUARDS (U.S. CLS. 26, 39 AND 44).
FIRST USE 11-0-2000; IN COMMERCE 11-0-2000.

SN 76-250,081. PRESSURE PRODUCTS MEDICAL SUPPLIES INC., RANCHO PALOS VERDES, CA. FILED 5-2-2001.

SAFE SHEATH CSG

NO CLAIM IS MADE TO THE EXCLUSIVE RIGHT TO USE "SHEATH", APART FROM THE MARK AS SHOWN.
FOR CARDIAC CATHETER EQUIPMENT; NAMELY, A SPLITTABLE HEMOSTATIC VALVE AND INTRODUCER SHEATH COMBINATION (U.S. CLS. 26, 39 AND 44).

SN 76-262,879. UPC MEDICAL SUPPLIES, INC., DBA UNITED PACIFIC COMPANY, ALHAMBRA, CA. FILED 5-29-2001.



NO CLAIM IS MADE TO THE EXCLUSIVE RIGHT TO USE "BRAND", APART FROM THE MARK AS SHOWN.
FOR STERILIZED ACUPUNCTURE NEEDLES (U.S. CLS. 26, 39 AND 44).
FIRST USE 5-1-2000; IN COMMERCE 5-1-2000.

CLASS 10—(Continued).

SN 76-263,858. MIRACLE-EAR, INC., PLYMOUTH, MN. FILED 5-29-2001.

MIRACLE-EAR ATTIVO

OWNER OF U.S. REG. NOS. 638,121, 2,039,429 AND OTHERS.
FOR HEARING AIDS (U.S. CLS. 26, 39 AND 44).
FIRST USE 1-0-2001; IN COMMERCE 1-0-2001.

SN 76-307,306. CHANG, JE WON, REDONDO BEACH, CA. FILED 9-4-2001.

ORIENT BASE

FOR MEDICAL DEVICE NAMELY, AN ACCUPRES-SURE FOOT BOARD FOR USE IN FOOT REFLEX THERAPY (U.S. CLS. 26, 39 AND 44).
FIRST USE 12-15-2000; IN COMMERCE 3-1-2001.

SN 76-308,814. KARL STORZ IMAGING, INC., GOLETA, CA. FILED 9-4-2001.

A1

FOR VIDEO CAMERAS, NAMELY, ENDOSCOPIC VIDEO CAMERAS AND COMPONENTS THEREFOR (U.S. CLS. 26, 39 AND 44).

SN 76-308,815. KARL STORZ IMAGING, INC., GOLETA, CA. FILED 9-4-2001.

S3

FOR VIDEO CAMERAS, NAMELY, ENDOSCOPIC VIDEO CAMERAS AND COMPONENTS THEREFOR (U.S. CLS. 26, 39 AND 44).

SN 76-308,828. KARL STORZ IMAGING, INC., GOLETA, CA. FILED 9-4-2001.

A3

FOR VIDEO CAMERAS, NAMELY, ENDOSCOPIC VIDEO CAMERAS AND COMPONENTS THEREFOR (U.S. CLS. 26, 39 AND 44).

CLASS 10—(Continued).

SN 76-315,380. LASERSURGE, INC., DBA LSI SOLUTIONS, VICTOR, NY. FILED 9-20-2001.

TOP KNOT

FOR SURGICAL INSTRUMENTS FOR SUTURING FOR USE WITH TITANIUM SLEEVES AND TITANIUM SLEEVES FOR SECURING SUTURES (U.S. CLS. 26, 39 AND 44).

SN 78-006,733. R&D MEDICAL LTD., YOKNEAM, ISRAEL, FILED 5-4-2000.

PAINWATCH

FOR MEDICAL DEVICES FOR MEASURING ELECTRICAL SIGNALS ON ONE'S SKIN AND PROVIDING AN OBJECTIVE MEASUREMENT OF PAIN (U.S. CLS. 26, 39 AND 44).

SN 78-019,354. FOWLER, KAREN, MARIE, HAVERTOWN, PA. FILED 8-2-2000.

SHEET SAVERS

NO CLAIM IS MADE TO THE EXCLUSIVE RIGHT TO USE "SHEET", APART FROM THE MARK AS SHOWN.
FOR DISPOSABLE, ABSORBENT, WATERPROOF LINERS PLACED ON TOP OF BED SHEETS, SOFAS, WHEELCHAIRS AND OTHER SURFACES TO PROTECT FROM VARIOUS BODILY FLUIDS (U.S. CLS. 26, 39 AND 44).

SN 78-066,612. BPH LABS, INC., MENLO PARK, CA. FILED 5-31-2001.

ISR STENT

NO CLAIM IS MADE TO THE EXCLUSIVE RIGHT TO USE "STENT", APART FROM THE MARK AS SHOWN.
FOR MEDICAL STENTS PROVIDING IMMEDIATE SYMPTOMATIC RELIEF FOR PATIENT INDICATIONS (U.S. CLS. 26, 39 AND 44).

SN 78-071,448. MACHINE SOLUTIONS INC., FLAGSTAFF, AZ. FILED 6-28-2001.

WAVEPLEAT

FOR MACHINE EQUIPMENT USED TO FORM, PLEAT, AND FOLD ANGIOPLASTY AND/OR STENT DELIVERY BALLOONS ATTACHED TO A DELIVERY CATHETER (U.S. CLS. 26, 39 AND 44).

CLASS 10—(Continued).

SN 78-071,960. PELVICRESTRAINER, LTD., SUNNYVALE, CA. FILED 7-2-2001.

BACKPROJECT PELVICRESTRAINER

NO CLAIM IS MADE TO THE EXCLUSIVE RIGHT TO USE "PELVIC RESTRAINER", APART FROM THE MARK AS SHOWN.

FOR EXERCISE MACHINES FOR THERAPEUTIC PURPOSES (U.S. CLS. 26, 39 AND 44).

SN 78-078,479. DOCTORS RESEARCH GROUP, INC., WOLCOTT, CT. FILED 8-9-2001.

BITEBLOCK

FOR DEPTH GUIDE FOR DENTAL IMPLANTS (U.S. CLS. 26, 39 AND 44).

SN 78-079,131. KANE ENTERPRISES, INC., BRANDON, SD. FILED 8-14-2001.

EQUISLEEVE

FOR VETERINARY EQUIPMENT, NAMELY SHOULDER LENGTH GLOVES FOR USE IN PERFORMING LIVESTOCK EXAMINATIONS (U.S. CLS. 26, 39 AND 44).

FIRST USE 12-1-1998; IN COMMERCE 12-1-1998.

SN 78-079,396. ALLEGIANCE HEALTHCARE CORPORATION, MCGAW PARK, IL. FILED 8-15-2001.

SAFE-T-CENTESIS

FOR DRAINAGE CATHETER DEVICES (U.S. CLS. 26, 39 AND 44).

SN 78-082,598. ULTRASONIC SERVICES, INC., BELLAIRE, TX. FILED 9-5-2001.

MEDSONICS

FOR ULTRASONIC DENTAL SURGERY TOOLS AND PARTS AND ACCESSORIES THEREFOR, NAMELY, CASES, ULTRASONIC POWER GENERATION UNITS, ULTRASONIC POWER CONTROLLERS, FOOT SWITCHES, HANDPIECES, HANDPIECE DIAGNOSTIC LIGHTS, HANDPIECE TIP LIGHTS, MAGNETOSTRICTIVE ELEMENTS, VELOCITY TRANSDUCERS, SURGICAL BLADES, HANDPIECE TIPS AND HANDPIECE INSERTS (U.S. CLS. 26, 39 AND 44).

CLASS 11—ENVIRONMENTAL CONTROL APPARATUS

SN 75-778,095. MECO CORPORATION, GREENEVILLE, TN. FILED 8-18-1999.

AUSSIE GRILL COMPANY

NO CLAIM IS MADE TO THE EXCLUSIVE RIGHT TO USE "GRILL COMPANY", APART FROM THE MARK AS SHOWN.

FOR BARBECUE GRILLS (U.S. CLS. 13, 21, 23, 31 AND 34).

FIRST USE 2-1-2000; IN COMMERCE 8-1-2000.

SN 75-835,928. ALTERNATIVE DELIVERY SYSTEMS, INC., CARSON CITY, NV. FILED 10-29-1999.

ADS VOLATIZER

NO CLAIM IS MADE TO THE EXCLUSIVE RIGHT TO USE "VOLATIZER", APART FROM THE MARK AS SHOWN.

FOR ELECTRIC OR BATTERY OPERATED DEVICES FOR USE IN HEAT EXTRACTION OF OILS, HERBS AND BOTANICALS (U.S. CLS. 13, 21, 23, 31 AND 34).

SN 75-857,919. L'INDUSTRIELLE DU PONANT SA, 29220 LANDERNEAU, FRANCE, FILED 11-24-1999.

HUMISPACE

OWNER OF FRANCE REG. NO. 1535371, DATED 6-6-1989, EXPIRES 6-6-2009.

FOR AIR CONDITIONING HUMIDIFIERS (U.S. CLS. 13, 21, 23, 31 AND 34).

SN 76-002,306. GRIFOS Y VALVULAS S.A., CUNDINAMARCA, COLOMBIA, FILED 3-16-2000.



NO CLAIM IS MADE TO THE EXCLUSIVE RIGHT TO USE "GRIFOS Y VALVULAS", APART FROM THE MARK AS SHOWN.

THE ENGLISH TRANSLATION OF "GRIFOS Y VALVULAS" IS "FAUCETS AND VALVES".

FOR PLUMBING PRODUCTS, NAMELY WATER MIXING VALVES FOR SHOWERS, SINKS AND LAUNDRY SINKS, ENTRY AND EXIT VALVES FOR TOILETS AND VALVES FOR THE CONTROL AND PASSAGE OF WATER (U.S. CLS. 13, 21, 23, 31 AND 34).

FIRST USE 4-16-1991; IN COMMERCE 4-16-1991.

CLASS 11—(Continued).

SN 76-044,751. LA-MAN CORPORATION, PORT ORANGE, FL. FILED 5-9-2000.

LA-MAN-AIR
Breathing System

OWNER OF U.S. REG. NO. 1,287,666.
NO CLAIM IS MADE TO THE EXCLUSIVE RIGHT TO USE "BREATHING SYSTEM", APART FROM THE MARK AS SHOWN.
THE MARK CONSISTS, IN PART, OF A STYLIZED CLOUD.
FOR COMPRESSED AIR FILTERS FOR INDUSTRIAL USE (U.S. CLS. 13, 21, 23, 31 AND 34).
FIRST USE 3-15-2000; IN COMMERCE 3-15-2000.

SN 76-066,579. FRIEDRICH GROHE AG & CO.KG, D-58653 HEMER, FED REP GERMANY, FILED 5-30-2000.

ALL-IN-ONE

FOR PLUMBING FITTINGS AND FIXTURES, NAMELY, WATER VALVES, WATER MIXING VALVES, WATER MIXERS AND WATER FAUCETS; SHOWERS, SHOWER RAILS, SHOWERHEADS, HANDHELD SHOWER-HEADS, BATHTUB GRIPS; A FULL LINE OF PLUMBING FITTINGS, NAMELY, BIBBS, COCKS, TRAPS AND VALVES FOR WATER VALVES, WATER MIXING VALVES, WATER MIXERS, WATER FAUCETS AND SHOWERS AND PARTS THEREFOR FOR ALL OF THE AFORESAID GOODS (U.S. CLS. 13, 21, 23, 31 AND 34).

SN 76-094,296. TITAN INTERNATIONAL, INC., QUINCY, IL. FILED 7-21-2000.

LSW 38L

FOR TIRES (U.S. CLS. 13, 21, 23, 31 AND 34).
FIRST USE 1-1-1994; IN COMMERCE 1-1-1994.

SN 76-095,277. HOLMES GROUP, INC., THE, MILFORD, MA. FILED 7-24-2000.

HARMONY

FOR APPLIANCES FOR DOMESTIC USE, NAMELY, PORTABLE ELECTRIC HEATERS, HUMIDIFIERS AND WICK FILTERS, ELECTRIC FANS, AIR PURIFIERS AND AIR FILTERS; AND LAMPS (U.S. CLS. 13, 21, 23, 31 AND 34).
FIRST USE 9-29-2000; IN COMMERCE 9-29-2000.

CLASS 11—(Continued).

SN 76-099,946. MAR COR SERVICES, INC., HARLEYSVILLE, PA. FILED 7-31-2000.

SEMPER PURE

NO CLAIM IS MADE TO THE EXCLUSIVE RIGHT TO USE "PURE", APART FROM THE MARK AS SHOWN.
THE ENGLISH TRANSLATION OF "SEMPER" IS "ALWAYS".
FOR WATER PURIFICATION UNITS (U.S. CLS. 13, 21, 23, 31 AND 34).

SN 76-103,597. NYKO TECHNOLOGIES, INC., LOS ANGELES, CA. FILED 8-7-2000.

GOT LIGHT?

NO CLAIM IS MADE TO THE EXCLUSIVE RIGHT TO USE "LIGHT", APART FROM THE MARK AS SHOWN.
FOR LIGHT FOR CONNECTION TO AND USE WITH PORTABLE ELECTRONIC AND COMPUTING DEVICES (U.S. CLS. 13, 21, 23, 31 AND 34).

SN 76-105,742. MUNTERS CORPORATION, FORT MYERS, FL. FILED 8-9-2000.

TURBOFOG

FOR FOGGING UNITS CONSISTING OF NOZZLES, PUMPS, AND MIST ELIMINATORS IN WHICH WATER IS ATOMIZED INTO DROPLETS AND SUPPLIED TO THE MIST ELIMINATOR TO EVAPORATIVELY COOL AND/OR HUMIDIFY AN AIRSTREAM ENTERING A TURBINE (U.S. CLS. 13, 21, 23, 31 AND 34).

SN 76-109,601. HOLMES GROUP, INC., THE, MILFORD, MA. FILED 8-15-2000.

ASPEN BREEZE

FOR PORTABLE ELECTRICAL FANS FOR DOMESTIC AND COMMERCIAL USE (U.S. CLS. 13, 21, 23, 31 AND 34).

CLASS 11—(Continued).

SN 76-119,429. W.W. GRAINGER, INC., LAKE FOREST, IL. FILED 8-30-2000.



NO CLAIM IS MADE TO THE EXCLUSIVE RIGHT TO USE "DESIGNS", APART FROM THE MARK AS SHOWN.

FOR AIR CONDITIONING UNITS; ELECTRIC FANS, AND PARTS AND FITTINGS THEREFORE; PORTABLE ELECTRIC HEATERS; ELECTRIC HOT AIR HAND DRYERS; REFRIGERATORS; ALL FOR COMMERCIAL, INSTITUTIONAL, AND INDUSTRIAL USE (U.S. CLS. 13, 21, 23, 31 AND 34).

SN 76-137,952. ANGELO LIGHTING COMPANY, PHILADELPHIA, PA. BY ASSIGNMENT ENCON ELECTRIC, L.P., PHILADELPHIA, PA. FILED 9-29-2000.

ROMANZA

THE ENGLISH TRANSLATION OF "ROMANZA" IS "MELODIC ARIA".

FOR CEILING FANS (U.S. CLS. 13, 21, 23, 31 AND 34).

SN 76-148,480. CARLIN COMBUSTION TECHNOLOGY, INC., EAST LONGMEADOW, MA. FILED 10-17-2000.

EZ

FOR OIL BURNERS AND GAS BURNERS (U.S. CLS. 13, 21, 23, 31 AND 34).

FIRST USE 0-0-1987; IN COMMERCE 0-0-1987.

SN 76-168,961. EVO, INC., BEAVERTON, OR. FILED 11-20-2000.

ēvo

FOR BARBECUE GRILLS, OUTDOOR GAS COOKING GRILLS AND OVENS (U.S. CLS. 13, 21, 23, 31 AND 34).

FIRST USE 10-27-2000; IN COMMERCE 10-27-2000.

CLASS 11—(Continued).

SN 76-172,344. MUNTERS CORPORATION, AMESBURY, MA. FILED 11-28-2000.

GTR

FOR DESICCANT WHEELS FOR USE IN DEHUMIDIFICATION UNITS (U.S. CLS. 13, 21, 23, 31 AND 34).

FIRST USE 6-1-2000; IN COMMERCE 7-1-2000.

SN 76-178,831. SUNPENTOWN INTERNATIONAL INC., CITY OF INDUSTRY, CA. FILED 12-11-2000.

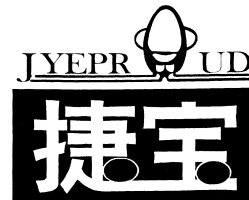

TRANSLATES TO "RAPID" AND "TREASURE" RESPECTIVELY.

FOR COOKING AND HOUSEHOLD APPLIANCES, NAMELY, ELECTRIC HOT POT COOKERS, GAS COOKERS, ELECTRIC RICE COOKERS, ELECTRIC SLOW COOKERS, ELECTRIC MULTI-COOKERS; BARBECUE GRILLS, BARBECUE GAS GRILLS, BARBECUE ELECTRIC GRILLS, GAS COOKING GRILLS, ELECTRIC COOKING GRILLS; ELECTRIC AIR POTS FOR HEATING WATER, ELECTRIC HOT WATER POTS; ELECTRIC HERBAL MEDICINE POTS, ELECTRIC KETTLES, ELECTRIC COFFEE MAKERS; COOKING OVENS FOR DOMESTIC AND COMMERCIAL USE, MICROWAVE OVENS FOR COOKING, ELECTRIC COOKING OVENS FOR DOMESTIC AND COMMERCIAL USE, PORTABLE ELECTRIC TOASTER OVENS FOR DOMESTIC AND COMMERCIAL USE, COOKING COUNTER-TOP OVENS FOR DOMESTIC AND COMMERCIAL USE, COOKING CONVECTION OVENS FOR DOMESTIC AND COMMERCIAL USE, COOKING FORCED AIR CIRCULATION OVENS FOR DOMESTIC AND COMMERCIAL USE, COOKING SUPER TURBO OVENS FOR DOMESTIC AND COMMERCIAL USE, COOKING INDUCTION OVENS FOR DOMESTIC AND COMMERCIAL USE, COOKING INDUCTION OVENS FOR DOMESTIC AND COMMERCIAL USE, COOKING INDUCTION OVENS FOR DOMESTIC AND COMMERCIAL USE; ELECTRIC TOASTERS; ELECTRIC INDUCTION COOKING RANGES, GAS INDUCTION COOK TOPS, HOT PLATES, ELECTRIC TEPPANYAKI GRILLS; ELECTRIC FANS, AIR BLOWERS IN THE NATURE OF ELECTRIC FANS, ELECTRIC AIR COOLERS IN THE NATURE OF AIR CONDITIONERS; EVAPORATIVE AIR COOLERS IN THE NATURE OF AIR CONDITIONERS; KEROSENE HEATERS, WATER HEATERS FOR COMMERCIAL AND RESIDENTIAL USE, PORTABLE ELECTRIC HEATERS, PORTABLE ELECTRIC SPACE HEATERS; AND STRUCTURAL AND REPLACEMENT PARTS AND COMPONENTS FOR ALL THE ABOVE (U.S. CLS. 13, 21, 23, 31 AND 34).

CLASS 11—(Continued).

SN 76-190,157. LITTLE GIANT PUMP COMPANY, OKLAHOMA CITY, OK. FILED 1-5-2001.

POWERSEWER

FOR WASTEWATER AND SEWAGE SYSTEMS, NAMELY, WASTEWATER AND SEWAGE PUMPS AND FILTERS FOR USE IN THE TREATMENT OF WASTEWATER AND SEWAGE, ALL SOLD AS A UNIT (U.S. CLS. 13, 21, 23, 31 AND 34).
FIRST USE 6-24-1998; IN COMMERCE 3-4-1999.

SN 76-193,195. YAZAKI CORPORATION, TOKYO, JAPAN, FILED 1-16-2001.

Aroace

FOR AIR CONDITIONING INSTALLATIONS USED FOR HEATING AND COOLING, AND PARTS THEREFORE (U.S. CLS. 13, 21, 23, 31 AND 34).
FIRST USE 12-1-1970; IN COMMERCE 12-1-1987.

SN 76-201,046. EASY HEAT, INC., NEW CARLISLE, IN. FILED 1-26-2001.

WARM TILES

OWNER OF U.S. REG. NO. 2,102,385. SEC. 2(F).
FOR ELECTRICAL HEATING CABLE FOR INSTALLATION IN FLOORING (U.S. CLS. 13, 21, 23, 31 AND 34).
FIRST USE 8-16-1995; IN COMMERCE 8-16-1995.

SN 76-204,613. NYKO TECHNOLOGIES, INC., LOS ANGELES, CA. FILED 2-2-2001.

SUPER WHITE WORM LIGHT

NO CLAIM IS MADE TO THE EXCLUSIVE RIGHT TO USE "SUPER WHITE" AND "LIGHT", APART FROM THE MARK AS SHOWN.
FOR LIGHT FOR CONNECTION TO AND USE WITH PORTABLE ELECTRONIC AND COMPUTING DEVICES (U.S. CLS. 13, 21, 23, 31 AND 34).
FIRST USE 1-10-2001; IN COMMERCE 1-10-2001.

CLASS 11—(Continued).

SN 76-204,800. EMPIRE PRODUCTS, INC., MONTCLAIR, CA. FILED 2-2-2001.

EASYISLE

OWNER OF U.S. REG. NOS. 2,260,357, 2,273,411 AND 2,273,412.
FOR BARBECUE GRILLS (U.S. CLS. 13, 21, 23, 31 AND 34).
FIRST USE 6-14-2000; IN COMMERCE 6-14-2000.

SN 76-210,386. CUNO INCORPORATED, MERIDEN, CT. FILED 2-15-2001.



NO CLAIM IS MADE TO THE EXCLUSIVE RIGHT TO USE "SYSTEM", APART FROM THE MARK AS SHOWN.
THE LINING IS A FEATURE OF THE MARK AND DOES NOT INDICATE COLOR.
THE MARK CONSISTS OF THE WORD "SYSTEM" ABOVE A RECTANGLE OF DESCENDING HORIZONTAL LINES THAT CONTAINS THE WORD "ONE".
FOR WATER FILTRATION SYSTEM, NAMELY WATER FILTERING UNITS FOR USE IN THE FOOD INDUSTRY, CONSISTING OF A UNIBODY MANIFOLD, FILTERS AND FILTER CANISTERS AS HOUSINGS (U.S. CLS. 13, 21, 23, 31 AND 34).
FIRST USE 2-0-1993; IN COMMERCE 2-0-1993.

SN 76-227,407. BRAMEC CORPORATION, NORTH SIOUX CITY, SD. FILED 3-20-2001.

DURA-PAN

FOR NON-METALLIC SECONDARY DRAIN PAN FOR AIR CONDITIONING AND HEATING UNITS (U.S. CLS. 13, 21, 23, 31 AND 34).

SN 76-255,967. DUCANE GAS GRILLS INC, COLUMBIA, SC. FILED 5-11-2001.



OWNER OF U.S. REG. NO. 1,220,753.
NO CLAIM IS MADE TO THE EXCLUSIVE RIGHT TO USE "STAINLESS", APART FROM THE MARK AS SHOWN.
FOR GAS GRILLS (U.S. CLS. 13, 21, 23, 31 AND 34).

CLASS 11—(Continued).

SN 76-264,587. FX LUMINAIRE, SAN DIEGO, CA. FILED 5-29-2001.

VERSABOX

FOR ELECTRIC LIGHT MOUNTING BOXES AND ELECTRIC LIGHT MOUNTING BRACKETS AND MOUNTING POSTS FOR USE THEREWITH (U.S. CLS. 13, 21, 23, 31 AND 34).
FIRST USE 10-31-2000; IN COMMERCE 10-31-2000.

SN 76-267,122. SVILAND, ELEN, JERSEY CITY, NJ. FILED 6-6-2001.

ODINKO

FOR LAMPS, LAMP SHADES, AND LAMP BODIES (U.S. CLS. 13, 21, 23, 31 AND 34).

SN 76-277,041. MELLINGER, MEL W., FORT LAUDERDALE, FL. FILED 6-27-2001.

ROYAL FLUSH

FOR TOILET SEATS AND TOILETS (U.S. CLS. 13, 21, 23, 31 AND 34).
FIRST USE 0-0-1983; IN COMMERCE 0-0-1984.

SN 76-280,672. SHANGHAI JIN KANG RONG LIGHTING ELECTRICAL EQUIPMENT CO., LTD., SHANGHAI, CHINA, FILED 7-6-2001.

JKRL

FOR LIGHTING APPARATUS, NAMELY, ELECTRIC LIGHT BULBS (U.S. CLS. 13, 21, 23, 31 AND 34).

SN 76-281,172. BRACKETT GREEN USA INC, HOUSTON, TX. FILED 7-6-2001.

CF 100

OWNER OF U.S. REG. NO. 2,381,740.
FOR WATER SCREENING INSTALLATIONS, NAMELY WATER FILTERING AND TREATMENT UNITS AND SEWAGE TREATMENT UNITS AND PARTS FOR ALL THE FOREGOING (U.S. CLS. 13, 21, 23, 31 AND 34).

CLASS 11—(Continued).

SN 76-281,710. BBQ HUT, INC., GLENDALE, AZ. FILED 7-10-2001.



NO CLAIM IS MADE TO THE EXCLUSIVE RIGHT TO USE "BBQ", APART FROM THE MARK AS SHOWN.
FOR BARBECUE GRILLS (U.S. CLS. 13, 21, 23, 31 AND 34).
FIRST USE 8-1-2000; IN COMMERCE 8-1-2000.

SN 76-283,824. HUNTER FAN COMPANY, MEMPHIS, TN. FILED 7-10-2001.

ZEPHAIR

OWNER OF U.S. REG. NO. 1,540,370.
FOR ELECTRIC TABLE FANS (U.S. CLS. 13, 21, 23, 31 AND 34).
FIRST USE 1-0-2001; IN COMMERCE 6-15-2001.

SN 78-056,921. LEE, ANTHONY J, HAZLETON, PA. FILED 4-5-2001.

CANAROUND

FOR REFRIGERATOR SHELF ORGANIZER (U.S. CLS. 13, 21, 23, 31 AND 34).
FIRST USE 8-15-1999; IN COMMERCE 6-7-2000.

SN 78-065,350. J.E. ADAMS INDUSTRIES, LTD., CEDAR RAPIDS, IA. FILED 5-23-2001.

AQUA BREEZE

FOR EVAPORATIVE AIR COOLING UNITS FOR COMMERCIAL AND INDUSTRIAL USE (U.S. CLS. 13, 21, 23, 31 AND 34).
FIRST USE 1-0-1997; IN COMMERCE 1-0-1997.

CLASS 11—(Continued).

SN 78-071,463. W.W. GRAINGER, INC., LAKE FOREST, IL. FILED 6-28-2001.

TRIDENT

FOR AUTOMATIC CLEANING DEVICE/MACHINE UTILIZING AN ELECTRONIC SENSOR TO AUTOMATICALLY FLUSH TOILETS AND URINALS AFTER USE AND WHICH DISPENSES A CHEMICAL FLUID; ELECTRIC HOT AIR HAND DRYERS (U.S. CLS. 13, 21, 23, 31 AND 34).

SN 78-080,179. NANTUCKET ISLAND RESORTS, LLC, NANTUCKET, MA. FILED 8-20-2001.

FIRECONE

FOR COOKING DEVICE, NAMELY A CHARCOAL BARBEQUE GRILL (U.S. CLS. 13, 21, 23, 31 AND 34).

SN 78-084,290. GENERAL ELECTRIC COMPANY, SCHEMECTADY, NY. FILED 9-18-2001.

SPECTRA

FOR ELECTRIC RANGES AND GAS RANGES FOR HOUSEHOLD USE (U.S. CLS. 13, 21, 23, 31 AND 34).

CLASS 12—VEHICLES

SN 74-408,279. IMCOA LICENSING AMERICA, INC., GILROY, CA. BY ASSIGNMENT TOMAS, MICHAEL J., RIVERSIDE, CA. FILED 7-2-1993.

KIWI INDIAN PARTS

OWNER OF U.S. REG. NO. 921,459.
NO CLAIM IS MADE TO THE EXCLUSIVE RIGHT TO USE "PARTS", APART FROM THE MARK AS SHOWN.
FOR STRUCTURAL PARTS FOR MOTORCYCLES (U.S. CL. 19).

SN 75-546,682. BRAKE PARTS INC., MCHENRY, IL. FILED 9-2-1998.

THE BEST IN BRAKES

NO CLAIM IS MADE TO THE EXCLUSIVE RIGHT TO USE "BRAKES", APART FROM THE MARK AS SHOWN. SEC. 2(F).
FOR LAND VEHICLE PARTS, NAMELY, BRAKE PADS, BRAKE BLOCKS, BRAKE WHEEL CYLINDERS, BRAKE LINES AND BRAKE HOSES (U.S. CLS. 19, 21, 23, 31, 35 AND 44).
FIRST USE 1-1-1988; IN COMMERCE 1-1-1988.

CLASS 12—(Continued).

SN 75-709,334. MAXIM TRUCKS, SCIPIO, IN. FILED 5-19-1999.

SURROUND VISION

FOR VEHICLE WINDOWS, NAMELY WINDOWS FOR CONCRETE TRUCK CABS (U.S. CLS. 19, 21, 23, 31, 35 AND 44).

SN 75-748,994. EGGER, R. CHRISTLAN, MARSHFLELD, WI. FILED 7-12-1999.

STOP ROADRAGE

FOR BUMPERSTICKERS (U.S. CLS. 19, 21, 23, 31, 35 AND 44).

SN 75-795,700. DAIMLERCHRYSLER AG, 70567 STUTTGART, FED REP GERMANY, FILED 9-8-1999.

C 32

PRIORITY CLAIMED UNDER SEC. 44(D) ON FED REP GERMANY APPLICATION NO. 39937763.812, FILED 6-29-1999, REG. NO. 39937763, DATED 8-13-1999, EXPIRES 6-30-2009.

OWNER OF U.S. REG. NO. 2,248,690.
NO CLAIM IS MADE TO THE EXCLUSIVE RIGHT TO USE "32", APART FROM THE MARK AS SHOWN.
FOR AUTOMOBILES (U.S. CLS. 19, 21, 23, 31, 35 AND 44).

SN 75-886,448. IOWA MOLD TOOLING, INC., GARNER, IA. FILED 1-4-2000.

DOMINATOR

FOR MECHANICS AND UTILITY SERVICE TRUCK BODIES FOR INSTALLATION ON TRUCK CHASSIS (U.S. CLS. 19, 21, 23, 31, 35 AND 44).
FIRST USE 0-0-1993; IN COMMERCE 0-0-1993.

SN 75-900,720. DELTA AUTOMOTIVE PRODUCTS, L.L.C., BUFFALO GROVE, IL. FILED 1-20-2000.

DELTA V

NO CLAIM IS MADE TO THE EXCLUSIVE RIGHT TO USE "V", APART FROM THE MARK AS SHOWN.
FOR NEW AND REMANUFACTURED REPLACEMENT BRAKES FOR AUTOMOTIVE USE (U.S. CLS. 19, 21, 23, 31, 35 AND 44).

CLASS 12—(Continued).

SN 75-909,780. TIBS, INC., BELMONT, NC. FILED 2-3-2000.

TRUKSAK

FOR TOOL BOXES SPECIALLY DESIGNED TO BE INSTALLED IN AUTOMOBILES, LUGGAGE CARRIERS FOR AUTOMOBILES AND SECURING STRAPS, LOOPS AND HOOKS FOR TRUCK BEDS SOLD TOGETHER AS A UNIT (U.S. CLS. 19, 21, 23, 31, 35 AND 44).

SN 76-073,496. WING ENTERPRISES, INC., SPRINGVILLE, UT. FILED 6-19-2000.

FASTEST HITCH IN THE WEST

FOR TOWING EQUIPMENT, NAMELY, TRAILER HITCHES AND RELATED ACCESSORIES THEREFOR (U.S. CLS. 19, 21, 23, 31, 35 AND 44).

SN 76-087,219. CASIO KEISANKI KABUSHIKI KAISHA, DBA CASIO COMPUTER CO., LTD., SHIBUYA-KU, TOKYO, JAPAN, FILED 7-11-2000.

G-SHOCK

OWNER OF JAPAN REG. NO. 2424099-2, DATED 8-21-1998, EXPIRES 6-30-2002.
FOR AUTOMOBILES (U.S. CLS. 19, 21, 23, 31, 35 AND 44).

SN 76-091,261. TRELLEBORG WHEEL SYSTEMS AMERICAS, INC., HARTVILLE, OH. FILED 7-19-2000.

T-900

FOR PNEUMATIC TIRES FOR USE WITH INDUSTRIAL FORKLIFTS (U.S. CLS. 19, 21, 23, 31, 35 AND 44).
FIRST USE 10-0-1999; IN COMMERCE 10-0-1999.

SN 76-091,274. TRELLEBORG WHEEL SYSTEMS AMERICAS, INC., HARTVILLE, OH. FILED 7-19-2000.

ECONOMISER

FOR SOLID AND PNEUMATIC INDUSTRIAL TIRES (U.S. CLS. 19, 21, 23, 31, 35 AND 44).
FIRST USE 5-0-1999; IN COMMERCE 5-0-1999.

CLASS 12—(Continued).

SN 76-093,579. TITAN INTERNATIONAL, INC., QUINCY, IL. FILED 7-21-2000.

LSW 48H

FOR TIRES (U.S. CLS. 19, 21, 23, 31, 35 AND 44).
FIRST USE 1-1-1994; IN COMMERCE 1-1-1994.

SN 76-093,585. TITAN INTERNATIONAL, INC., QUINCY, IL. FILED 7-21-2000.

TT 472

FOR TIRES (U.S. CLS. 19, 21, 23, 31, 35 AND 44).
FIRST USE 1-1-1994; IN COMMERCE 1-1-1994.

SN 76-107,006. ENKEI INTERNATIONAL, INC., MADISON HEIGHTS, MI. FILED 8-10-2000.

ETX

FOR WHEELS FOR LAND VEHICLES AND STRUCTURAL PARTS THEREFOR (U.S. CLS. 19, 21, 23, 31, 35 AND 44).

SN 76-108,913. SHALLEY, JACK E., LEE'S SUMMIT, MO. FILED 8-14-2000.

TUBE SCOOTER

NO CLAIM IS MADE TO THE EXCLUSIVE RIGHT TO USE "TUBE". APART FROM THE MARK AS SHOWN.
FOR RECREATIONAL WATERCRAFT IN THE NATURE OF MOTORIZED PERSONAL TUBE FLOATS (U.S. CLS. 19, 21, 23, 31, 35 AND 44).

SN 76-122,463. SKYLINE CORPORATION, ELKHART, IN. FILED 9-1-2000.

RISING STAR

FOR RECREATIONAL VEHICLES, NAMELY NON-MOTORIZED TOWABLE TRAVEL TRAILERS AND FIFTH WHEELS (U.S. CLS. 19, 21, 23, 31, 35 AND 44).
FIRST USE 4-21-2000; IN COMMERCE 4-21-2000.

CLASS 12—(Continued).

SN 76-122,675. BLUE BIRD BODY COMPANY, FORT VALLEY, GA. FILED 9-5-2000.



FOR BUSES (U.S. CLS. 19, 21, 23, 31, 35 AND 44).
FIRST USE 1-0-1956; IN COMMERCE 1-0-1956.

SN 76-127,597. WINNER INTERNATIONAL ROYALTY LLC, SHARON, PA. FILED 9-14-2000.



OWNER OF U.S. REG. NOS. 1,577,674, 2,051,573 AND OTHERS.

THE MARK CONSISTS IN PART OF A STYLIZED DESIGN OF A VEHICLE ANTI-THEFT DEVICE FORMING PART OF THE WORD "CLICK".

FOR ANTI-THEFT DEVICES FOR MOTOR VEHICLES, NAMELY STEERING WHEEL LOCKS (U.S. CLS. 19, 21, 23, 31, 35 AND 44).

SN 76-143,006. SUBARU OF AMERICA, INC., CHERRY HILL, NJ. FILED 10-6-2000.

BOULDER

FOR AUTOMOBILES AND STRUCTURAL PARTS THEREFORE (U.S. CLS. 19, 21, 23, 31, 35 AND 44).

SN 76-171,493. HANKOOK TIRE CO., LTD., KANGNAM-KU, SEOUL, REPUBLIC OF KOREA, FILED 11-27-2000.

ICEBEAR

FOR TIRES AND TUBES FOR VEHICLES (U.S. CLS. 19, 21, 23, 31, 35 AND 44).

CLASS 12—(Continued).

SN 76-191,773. AIRCRAFT RUBBER MANUFACTURING, INC., DBA FUEL SAFE SYSTEMS, BEND, OR. FILED 1-10-2001.

OUTLAW

FOR AUTOMOTIVE STRUCTURAL PARTS FOR RACING PURPOSES, NAMELY FUEL STORAGE CELLS (U.S. CLS. 19, 21, 23, 31, 35 AND 44).

FIRST USE 1-10-1997; IN COMMERCE 1-10-1997.

SN 76-213,993. ENKEI FLORIDA, INC., JACKSONVILLE, FL. FILED 2-21-2001.

STELLAR

FOR AUTOMOBILE WHEELS (U.S. CLS. 19, 21, 23, 31, 35 AND 44).

SN 76-216,912. AMERICAN RACING EQUIPMENT, INC., RANCHO DOMINGUEZ, CA. FILED 2-27-2001.



OWNER OF U.S. REG. NOS. 863,444, 2,001,979 AND OTHERS.

NO CLAIM IS MADE TO THE EXCLUSIVE RIGHT TO USE "SINCE 1956" AND "RACING CUSTOM WHEELS MOTORSPORTS", APART FROM THE MARK AS SHOWN.

FOR AUTOMOTIVE VEHICLE WHEELS (U.S. CLS. 19, 21, 23, 31, 35 AND 44).

SN 76-219,975. AUTOSOCK AS, 1450 NESODDTANGEN, NORWAY, FILED 3-6-2001.

AUTOSOCK

OWNER OF NORWAY REG. NO. 201492, DATED 2-10-2000, EXPIRES 2-10-2010.

FOR NON-METAL, NON-SKID DEVICES FOR VEHICLE TIRES, INCLUDING NON-SKID DEVICES OF TEXTILE MATERIAL FOR VEHICLE TIRES, NAMELY, TIRE COVERS (U.S. CLS. 19, 21, 23, 31, 35 AND 44).

CLASS 12—(Continued).

SN 76-263,755. BROADWAY VAN CITY, INC., DEPEW, NY. FILED 5-29-2001.

BVC HAWK WING

FOR LAND VEHICLE PARTS, NAMELY, POWER-ACTIVATED HATCH DOORS FOR USE IN VANS MODIFIED FOR USE BY INDIVIDUALS WITH DISABILITIES (U.S. CLS. 19, 21, 23, 31, 35 AND 44).

SN 76-273,470. RADMONT, INC., CRAFTSBURY COMMON, VT. FILED 6-19-2001.

JACKAL

FOR ALL TERRAIN VEHICLES (U.S. CLS. 19, 21, 23, 31, 35 AND 44).

SN 76-281,017. KIA MOTORS CORPORATION, SEOUL, 137-938, REPUBLIC OF KOREA, FILED 7-6-2001.

SORRENTO

FOR PASSENGER CARS, LORRIES, BUSES, MINIBUSES, VANS, MINIVANS, FOURWHEEL DRIVE VEHICLES, MULTIPURPOSE CARS, OMNIBUSES AND LEISURE CARS (U.S. CLS. 19, 21, 23, 31, 35 AND 44).

SN 76-284,343. MONKEY BARS CUSTOM ROLL CAGES, PICO RIVERA, CA. FILED 7-13-2001.

MONKEY BARS

FOR ROLL BARS USED IN VEHICLES (U.S. CLS. 19, 21, 23, 31, 35 AND 44).

SN 76-289,315. DOREL JUVENILE GROUP, INC., COLUMBUS, IN. FILED 7-24-2001.

GEMINI

FOR JUVENILE STROLLERS; COMBINATION CAR SEAT/STROLLERS (U.S. CLS. 19, 21, 23, 31, 35 AND 44).

SN 76-289,317. DOREL JUVENILE GROUP, INC., COLUMBUS, IN. FILED 7-24-2001.

FIRST RIDE

OWNER OF U.S. REG. NO. 1,268,583.
FOR JUVENILE STROLLERS; COMBINATION CAR SEAT/STROLLERS (U.S. CLS. 19, 21, 23, 31, 35 AND 44).

CLASS 12—(Continued).

SN 76-310,398. WINNEBAGO INDUSTRIES, INC., FOREST CITY, IA. FILED 9-10-2001.

SUNOVA

FOR MOTOR HOMES (U.S. CLS. 19, 21, 23, 31, 35 AND 44).
FIRST USE 6-16-2001; IN COMMERCE 6-16-2001.

SN 76-314,468. CANNONDALE CORPORATION, BETHEL, CT. FILED 9-19-2001.

CANNONDALE CANNIBAL

OWNER OF U.S. REG. NOS. 1,032,202, 2,416,442 AND OTHERS.

FOR ALL TERRAIN VEHICLES (U.S. CLS. 19, 21, 23, 31, 35 AND 44).
FIRST USE 6-1-2001; IN COMMERCE 6-1-2001.

SN 78-039,961. AGUILAR, FRANK, LOS ANGELES, CA. FILED 12-19-2000.

SLOPECYCLE

FOR BICYCLES, NAMELY, NON-MOTORIZED RECREATIONAL SNOW BIKES AND SNOW BICYCLE PARTS, NAMELY, FRAMES, HANDLE BARS, SEATS, FORKS, SHOCK ABSORBERS (U.S. CLS. 19, 21, 23, 31, 35 AND 44).

SN 78-050,313. HOLOPUNI CANOES, INC., TAHOE CITY, CA. FILED 2-26-2001.

HOLOPUNI CANOES

NO CLAIM IS MADE TO THE EXCLUSIVE RIGHT TO USE "CANOES", APART FROM THE MARK AS SHOWN.

THE ENGLISH TRANSLATION OF THE WORD "HOLOPUNI" IN THE MARK IS "TO SAIL EVERYWHERE".

FOR OUTRIGGER PADDLING CANOES, OUTRIGGER SAILING CANOES; OUTRIGGER CANOE PARTS AND ACCESSORIES, NAMELY, PADDLES AND CROSS ARMS (U.S. CLS. 19, 21, 23, 31, 35 AND 44).

FIRST USE 1-1-1998; IN COMMERCE 1-1-1999.

SN 78-073,180. SHELL OIL COMPANY, HOUSTON, TX. FILED 7-10-2001.

WELLCAB

FOR DOWNHOLE AUTONOMOUS TRACTOR FOR MOVING EQUIPMENT IN AND OUT OF OIL AND GAS WELLS (U.S. CLS. 19, 21, 23, 31, 35 AND 44).

CLASS 12—(Continued).

SN 78-073,188. WAYSON U.S.A., LLC., HAYWARD, CA. FILED 7-10-2001.

UROGEAR

FOR AUTOMOBILE CUSTOM ACCESSORIES, CONTAINING AUTOMOBILE FIBERGLASS BODY COMPONENTS, NAMELY, HOODS, FENDERS, BUMPERS AND SPOILERS FOR AUTOMOBILES (U.S. CLS. 19, 21, 23, 31, 35 AND 44).

SN 78-079,138. GENERAL MOTORS CORPORATION, DETROIT, MI. FILED 8-14-2001.

SELECTIVE RIDE

FOR SUSPENSION COMPONENTS FOR MOTOR LAND VEHICLES NAMELY, SHOCK ABSORBERS, STRUTS, SPRINGS, TORSION BARS, MOUNTINGS AND BRACKETS (U.S. CLS. 19, 21, 23, 31, 35 AND 44).

SN 78-079,141. SATURN CORPORATION, DETROIT, MI. FILED 8-14-2001.

SATURN SKY

OWNER OF U.S. REG. NOS. 1,762,693, 1,770,560 AND OTHERS.

FOR MOTOR LAND VEHICLES NAMELY, AUTOMOBILES, SPORT UTILITY VEHICLES, TRUCKS, VANS, ENGINES THEREFOR AND STRUCTURAL PARTS THEREOF (U.S. CLS. 19, 21, 23, 31, 35 AND 44).

SN 78-083,595. FIAT AUTO S.P.A., TORINO, ITALY, FILED 9-12-2001.

GRADUATE

OWNER OF ITALY REG. NO. 683487, DATED 7-4-1996, EXPIRES 6-7-2004.

FOR MOTOR VEHICLES AND STRUCTURAL PARTS THEREOF (U.S. CLS. 19, 21, 23, 31, 35 AND 44).

SN 78-084,666. SWEENEY, PATRICIA H., LAVALLETTE, NJ. FILED 9-20-2001.

SKYJACKET

FOR PARACHUTE (U.S. CLS. 19, 21, 23, 31, 35 AND 44).

CLASS 13—FIREARMS

CLASS 13—(Continued).

SN 76-090,336. BLOUNT, INC., MONTGOMERY, AL. FILED 7-17-2000.

X DIE

NO CLAIM IS MADE TO THE EXCLUSIVE RIGHT TO USE "DIE", APART FROM THE MARK AS SHOWN. FOR DIES FOR RELOADING AMMUNITION (U.S. CLS. 2 AND 9). FIRST USE 7-31-1997; IN COMMERCE 7-31-1997.

SN 76-213,215. CHINA NATIONAL SAMKWONG FIREWORKS CO., LTD., CAUSEWAY BAY, HONG KONG, FILED 2-13-2001.

MIGHTY MAX

FOR CONSUMER FIREWORKS (U.S. CLS. 2 AND 9).

SN 76-213,220. CHINA NATIONAL SAMKWONG FIREWORKS CO., LTD., CAUSEWAY BAY, HONG KONG, FILED 2-13-2001.

IONIC-BOMB

FOR CONSUMER FIREWORKS (U.S. CLS. 2 AND 9).

SN 76-226,314. PARA-ORDNANCE MFG. INC., SCARBOROUGH, ONTARIO M1X 1E7, CANADA, FILED 3-16-2001.

PARA

OWNER OF U.S. REG. NO. 1,882,082. FOR FIREARMS, DIE-MARKING PISTOLS, AND REPLACEMENT AND STRUCTURAL PARTS THEREFORE; AMMUNITION (U.S. CLS. 2 AND 9).

SN 78-073,176. HOLMES, JASON, J., GREENWOOD, IN. FILED 7-10-2001.

EVERYTHING BUT DYNAMITE

FOR FIREWORKS (U.S. CLS. 2 AND 9).

CLASS 14—JEWELRY

CLASS 14—(Continued).

SN 76-022,190. L I D., LTD., NEW YORK, NY. FILED 4-10-2000.

LID

FOR JEWELRY AND DIAMONDS (U.S. CLS. 2, 27, 28 AND 50).

FIRST USE 1-1-1995; IN COMMERCE 1-1-1995.

SN 76-065,160. NANIS DI MARANGON PIERO & C. S.N.C., 36070 TRISSINO (VICENZA), ITALY, FILED 6-6-2000.



THE NAME "PAOLO MARANGON" IDENTIFIES A LIVING INDIVIDUAL WHOSE CONSENT IS OF RECORD.

FOR NECKLACES, BRACELETS, EARRINGS, RINGS, BROOCHES AND PENDANTS, CUFF-LINKS, TIEPINS, CLIPS IN THE NATURE OF MONEY CLIPS FOR DOCUMENTS AND BANKNOTES, ALL OF THE AFORESAID GOODS BEING MADE OF GOLD AND/OR OTHER PRECIOUS METALS, WITH OR WITHOUT PRECIOUS STONES; PEARLS AND CULTURED PEARLS; WATCHES AND STRAPS FOR WATCHES; CHEAP JEWELRY; COSTUME JEWELRY MADE FROM LEATHER AND/OR INDIAN RUBBER STRINGS (U.S. CLS. 2, 27, 28 AND 50).

FIRST USE 5-0-2000; IN COMMERCE 5-0-2000.

SN 76-110,906. TRACHTMAN, DEBORAH WRIGHT, MERRITT ISLAND, FL. FILED 8-18-2000.

**THE SEA DRIFT
COLLECTION**

NO CLAIM IS MADE TO THE EXCLUSIVE RIGHT TO USE "COLLECTION", APART FROM THE MARK AS SHOWN.

FOR JEWELRY AND FASHION ACCESSORIES MADE FROM SEEDS, PRECIOUS AND SEMIPRECIOUS STONES, PRECIOUS AND SEMIPRECIOUS METALS, NAMELY BRACELETS, NECKLACES, EARRINGS, ANKLETS, COLLECTORS' BOXES, AND CANDLE RINGS (U.S. CLS. 2, 27, 28 AND 50).

FIRST USE 1-0-2000; IN COMMERCE 6-9-2000.

SN 76-218,674. HARTER, ALLISON E., LAKE PARK, FL. FILED 3-2-2001.

FUSHBON

FOR JEWELRY (U.S. CLS. 2, 27, 28 AND 50).
FIRST USE 5-25-2000; IN COMMERCE 7-11-2000.

CLASS 14—(Continued).

SN 76-258,943. TIMEX GROUP B.V., 1075 AD AMSTERDAM, NETHERLANDS, FILED 5-18-2001.

VIVIENE TAYLOR

THE NAME IN THE MARK DOES NOT IDENTIFY A LIVING INDIVIDUAL.

FOR WATCHES (U.S. CLS. 2, 27, 28 AND 50).

SN 76-290,955. GEMORO, INC., NEW YORK, NY. FILED 7-27-2001.

GEMORO

FOR PRECIOUS AND SEMI-PRECIOUS GEMSTONES AND JEWELRY, NAMELY RINGS, EARRINGS, PENDANTS, PINS, BRACELETS, NECKLACES OF PRECIOUS AND SEMI-PRECIOUS GEMSTONES AND GOLD, SILVER AND PLATINUM METALS (U.S. CLS. 2, 27, 28 AND 50).

FIRST USE 11-30-1996; IN COMMERCE 11-30-1996.

SN 76-315,475. TOMMY HILFIGER LICENSING, INC., NEWARK, DE. FILED 9-20-2001.

TH

OWNER OF U.S. REG. NO. 2,050,013.

THE INITIALS SHOWN IN THE MARK REFER TO A LIVING INDIVIDUAL, NAMELY, "TOMMY HILFIGER".
FOR JEWELRY AND WATCHES (U.S. CLS. 2, 27, 28 AND 50).

FIRST USE 5-0-2000; IN COMMERCE 5-0-2000.

SN 78-039,027. BAHADOURIAN, ARTHUR J., PASADENA, CA. FILED 12-12-2000.

PEARLMAID

FOR PEARLS AND PEARL JEWELRY (U.S. CLS. 2, 27, 28 AND 50).

CLASS 14—(Continued).

SN 78-062,627. AMATO, MICHELE, WAILUKU, HI. FILED 5-9-2001.

OPULENT DESIGNS

NO CLAIM IS MADE TO THE EXCLUSIVE RIGHT TO USE "DESIGNS", APART FROM THE MARK AS SHOWN.

FOR JEWELRY OF PRECIOUS METALS AND THEIR ALLOYS; GOODS OF PRECIOUS METALS OR COATED THERE-WITH, NAMELY - CANDLE HOLDERS, CANDLE RINGS, CANDLE SNUFFERS, COFFEE SERVICES, DRAWER PULLS, NAPKIN HOLDERS, NAPKIN RINGS, PILLBOXES, PILLER CANDLE PLATES, POTPOURRI DISHES, JEWELRY BOXES, JEWELRY CASES, MONEY CLIPS, SALT SHAKERS, SERVING PLATTERS, SERVING TRAYS, TEA BALLS, TEA INFUSERS, TEAPOTS; TIE CLIPS, TIE FASTENERS, TIE PINS, TIE TACKS; PRECIOUS AND SEMI PRECIOUS STONES; IMITATION JEWELRY; OBJECTS OF ART IN PRECIOUS METALS, NAMELY - DECORATIVE BOXES, SCULPTURES, FIGURINES, ORNAMENTS, VASES (U.S. CLS. 2, 27, 28 AND 50).

SN 78-066,237. HILL, TIMOTHY A., DBA T.A.HILL, CY-PRESS, TX. FILED 5-29-2001.

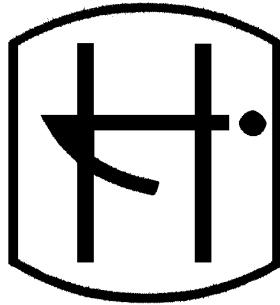

FOR JEWELRY (U.S. CLS. 2, 27, 28 AND 50).
FIRST USE 2-7-2001; IN COMMERCE 2-7-2001.

SN 78-079,189. SCHWARTZ, TIBOR, NEW YORK, NY. FILED 8-14-2001.

ST

FOR JEWELRY (U.S. CLS. 2, 27, 28 AND 50).

SN 78-084,165. PLANO, JOAN, E., MOHAWK, NY. FILED 9-17-2001.

BLUEWAVEART

FOR JEWELRY; NAMELY, NECKLACES, EARRINGS, BRACELETS, BROOCHES, RINGS, AND PENDANTS (U.S. CLS. 2, 27, 28 AND 50).

CLASS 14—(Continued).

SN 78-084,621. CHOI, JAY K., WHITESTONE, NY. FILED 9-19-2001.

OLZE

FOR JEWELRY, DIAMONDS, EMERALDS, PEARLS, PRECIOUS GEMSTONES, SEMI-PRECIOUS GEMSTONES, PRECIOUS METALS, BRACELET, BROOCHES, EARRINGS, NECKLACES, PENDANTS, COSTUME JEWELRY, WATCHES, WATCH BAND, WATCH CHAIN, WATCH MOVEMENTS, WRISTWATCH (U.S. CLS. 2, 27, 28 AND 50).

CLASS 15—MUSICAL INSTRUMENTS

SN 75-609,369. AVEDIS ZILDJIAN CO., NORWELL, MA. FILED 12-21-1998.



AZILDJIAN&C^{IE}

NO CLAIM IS MADE TO THE EXCLUSIVE RIGHT TO USE "COMPANY" AND "CIE", APART FROM THE MARK AS SHOWN.

THE NAME "AVEDIS ZILDJIAN" DOES NOT IDENTIFY A LIVING INDIVIDUAL.

THE NON-LATIN CHARACTERS IN THE MARK TRANSLITERATE TO "A FI DES ZILGIAN SHA RE KAT" AND THIS MEANS "AVEDIS ZILDJIAN COMPANY" IN ENGLISH.

FOR MUSICAL INSTRUMENTS, NAMELY, CYMBALS (U.S. CLS. 2, 21 AND 36).

CLASS 15—(Continued).

SN 75-941,956. KUSTOM MUSICAL AMPLIFICATION INC., CINCINNATI, OH. FILED 3-11-2000.

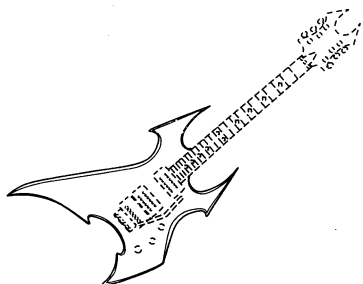

THE MARK COMPRISES THE FANCIFUL DESIGN OF A GUITAR BODY, THE NECK, HEADSTOCK, FRETS, PICK-UPS AND OTHER PICTURED GUITAR PARTS ARE SHOWN IN BROKEN LINES AND FORM NO PART OF THE MARK.

SEC. 2(F).
FOR STRINGED INSTRUMENTS, NAMELY GUITARS (U.S. CLS. 2, 21 AND 36).
FIRST USE 0-0-1997; IN COMMERCE 0-0-1997.

SN 76-080,832. TEAM INTERNATIONAL MUSIC CO., LTD., TAIWAN, CHINA, FILED 6-29-2000.

THE ENGLISH TRANSLATION OF "MAHALO" IS "THANK YOU".

FOR VIOLINS; BOWS FOR MUSICAL INSTRUMENTS; UKULELES; GUITARS; ELECTRIC GUITARS; FOLK GUITARS; PERCUSSION INSTRUMENTS; CLASSIC GUITARS; GUITAR STRINGS; VIOLIN STRINGS; VIOLIN CHIN RESTS; CONDUCTOR'S BATONS; TUNING FORKS; TUNERS FOR MUSICAL INSTRUMENTS; CARRYING CASES FOR MUSICAL INSTRUMENTS; GUITAR PICKS; PLECTRUMS; GUITAR EFFECTORS; DRUMS; DRUMSTICKS; DRUM STANDS; MUSICAL INSTRUMENT STANDS; MUSIC BOXES; BASS GUITARS (U.S. CLS. 2, 21 AND 36).

FIRST USE 8-13-1999; IN COMMERCE 3-22-2000.

CLASS 15—(Continued).

SN 76-196,558. GREENBERG, MITCH, WHEELING, IL. FILED 1-17-2001.



NO CLAIM IS MADE TO THE EXCLUSIVE RIGHT TO USE "DRUM", APART FROM THE MARK AS SHOWN, FOR MUSICAL INSTRUMENTS (U.S. CLS. 2, 21 AND 36).

FIRST USE 10-15-1996; IN COMMERCE 10-15-1996.

SN 76-278,594. DEAN MARKLEY STRINGS, INC., SANTA CLARA, CA. FILED 6-29-2001.

NPS ROUND CORE

NO CLAIM IS MADE TO THE EXCLUSIVE RIGHT TO USE "ROUND CORE", APART FROM THE MARK AS SHOWN.

FOR STRINGS FOR MUSICAL INSTRUMENTS AND ACCESSORIES FOR MUSICAL INSTRUMENTS, NAMELY, NECK STRAPS, SHOULDER STRAPS, INSTRUMENT SHOULDER PADS, STANDS, CARRYING CASES, COVERS AND BAGS FOR MUSICAL INSTRUMENTS, BOWS, PITCH PIPES, ROSIN, TUNING FORKS, BRIDGES, ENDPINS, MACHINE HEADS, PEGS, STRING ADJUSTERS, TAILPIECES, FRETS, PICKS, SLIDES, AND PADS FOR MUSICAL INSTRUMENTS (U.S. CLS. 2, 21 AND 36).

SN 76-313,303. GIBSON GUITAR CORP., NASHVILLE, TN. FILED 9-11-2001.

FOR GUITAR STRINGS (U.S. CLS. 2, 21 AND 36).

SN 78-071,726. CHEN, MICHAEL, CITY OF INDUSTRY, CA. FILED 6-29-2001.

LEGION

FOR MUSICAL INSTRUMENTS, NAMELY, DRUMS, SAXOPHONES, VIOLINS, VIOLAS, HARPS, GUITARS, ELECTRICAL ORGANS, STRINGED INSTRUMENTS, MUSICAL KEYBOARDS AND PIANOS (U.S. CLS. 2, 21 AND 36).

CLASS 16—PAPER GOODS AND PRINTED MATTER

SN 75-138,682. IMCOA LICENSING AMERICA, INC., TORONTO, ONTARIO, CANADA. BY ASSIGNMENT INDIAN MOTORCYCLE SUPPLY INC., SUGAR GROVE, IL. FILED 7-23-1996.



OWNER OF U.S. REG. NOS. 652,777 AND 921,459. FOR DECALS (U.S. CLS. 2, 5, 22, 23, 29, 37, 38 AND 50). FIRST USE 8-25-1936; IN COMMERCE 8-25-1936.

SN 75-462,269. PRO-INNOVATIVE CONCEPTS, INC., PHOENIX, AZ. FILED 4-6-1998.

PAGE PAL

FOR PORTABLE TABLE-TOP STANDS FOR MAGAZINES, NEWSPAPERS, BOOKS AND LOOSE PAPERS (U.S. CLS. 2, 5, 22, 23, 29, 37, 38 AND 50).

SN 75-519,649. BARKER, ELAINE A., HAVERHILL, MA. FILED 7-16-1998.

PAPER POTPOURRI



NO CLAIM IS MADE TO THE EXCLUSIVE RIGHT TO USE "PAPER", APART FROM THE MARK AS SHOWN.

THE LINING IN THE DRAWING IS A FEATURE OF THE MARK, AND DOES NOT INTENDED TO INDICATE COLOR.

FOR PRINTED MATTER; NAMELY, STATIONERY, INVITATIONS, NOTE CARDS, ANNOUNCEMENT CARDS, BUSINESS CARDS, AND HOLIDAY CARDS (U.S. CLS. 2, 5, 22, 23, 29, 37, 38 AND 50).

FIRST USE 0-0-1978; IN COMMERCE 0-0-1978.

CLASS 16—(Continued).

SN 75-653,529. DATAMARK SYSTEMS GROUP INC., QUEBEC, CANADA, BY CHANGE OF NAME DATAMARK INC., LASALLE, QUEBEC, CANADA, FILED 3-4-1999.

DATAMARK SYSTEMS

PRIORITY CLAIMED UNDER SEC. 44(D) ON CANADA APPLICATION NO. 1001328, FILED 1-6-1999.

OWNER OF U.S. REG. NO. 1,001,328.

NO CLAIM IS MADE TO THE EXCLUSIVE RIGHT TO USE "SYSTEMS", APART FROM THE MARK AS SHOWN.

FOR PRINTED AIRLINE TICKETS, PAPER IDENTIFICATION TAGS FOR BAGGAGE AND AIRLINE DOCUMENTS, NAMELY BOARDING PASSES AND WAYBILLS (U.S. CLS. 2, 5, 22, 23, 29, 37, 38 AND 50).

SN 75-706,722. MAVETY MEDIA GROUP, LTD, NEW YORK, NY. BY ASSIGNMENT FORTY ACRES AND A MULE COMMUNICATIONS, INC., MIAMI, FL. FILED 5-14-1999.

LATIN SUPERHUNKS PRESENTS

NO CLAIM IS MADE TO THE EXCLUSIVE RIGHT TO USE "LATIN SUPERHUNKS", APART FROM THE MARK AS SHOWN.

FOR ADULT ENTERTAINMENT MAGAZINES, FEATURING CELEBRITIES (U.S. CLS. 2, 5, 22, 23, 29, 37, 38 AND 50).

SN 75-770,744. KELLEY, KATHLEEN P., DENTON, TX. FILED 8-9-1999.

HYSTER SISTERS

FOR SERIES OF NON-FICTION, INFORMATIONAL BOOKS ON THE TOPIC OF HYSTERECTOMY RECOVERY (U.S. CLS. 2, 5, 22, 23, 29, 37, 38 AND 50).

FIRST USE 10-1-1998; IN COMMERCE 7-7-1999.

SN 75-784,001. QUILL COMPANY, INC., THE, CRANSTON, RI. FILED 8-25-1999.

DURAPRINT

OWNER OF U.S. REG. NOS. 1,153,921, 2,167,756 AND OTHERS.

FOR WRITING INSTRUMENTS, NAMELY, BALL-POINT, FOUNTAIN, ROLLER-BALL AND MARKER PENS, MECHANICAL PENCILS AND REFILLS THEREFOR (U.S. CLS. 2, 5, 22, 23, 29, 37, 38 AND 50).

FIRST USE 9-27-1999; IN COMMERCE 9-27-1999.

CLASS 16—(Continued).

SN 75-835,004. FIELD OF DREAMS PRODUCTS, KNOXVILLE, TN. AND ANIMALGREETINGCARDS.COM, KNOXVILLE, TN. FILED 11-13-1999.



NO CLAIM IS MADE TO THE EXCLUSIVE RIGHT TO USE "PRODUCTS, WWW.ANIMALGREETINGCARDS.COM, WWW.FIELDOFDREAMSFARM.COM, 5340 MILLERTOWN PIKE, #114, KNOXVILLE, TN 37924, AND PHONE 865-281-0770 FAX 865-688-5801", APART FROM THE MARK AS SHOWN.

FOR GREETING CARDS POSTERS PHOTOGRAPHIC PRINTS POSTCARDS (U.S. CLS. 2, 5, 22, 23, 29, 37, 38 AND 50).

FIRST USE 10-1-1998; IN COMMERCE 10-1-1998.

SN 75-856,358. BANCO BILBAO VIZCAYA ARGENTARIA, S.A., 48005 BILBAO, SPAIN, BY MERGER, BY CHANGE OF NAME BANCO BILBAO VIZCAYA, S.A., 48005 BILBAO, SPAIN, FILED 11-23-1999.

BBVA

PRIORITY CLAIMED UNDER SEC. 44(D) ON SPAIN APPLICATION NO. 2.265302, FILED 10-22-1999, REG. NO. 2265302-3, DATED 3-6-2000, EXPIRES 3-6-2010.

FOR PAMPHLETS, BROCHURES AND NEWSLETTERS RELATING TO BANKING, BUSINESS, FINANCE, INSURANCE, REAL ESTATE AND/OR COMMERCE (U.S. CLS. 2, 5, 22, 23, 29, 37, 38 AND 50).

SN 75-856,403. BANCO BILBAO VIZCAYA ARGENTARIA, S.A., 48005 BILBAO, SPAIN, BY MERGER, BY CHANGE OF NAME BANCO BILBAO VIZCAYA, S.A., 48005 BILBAO, SPAIN, FILED 11-23-1999.

LATINBANK

PRIORITY CLAIMED UNDER SEC. 44(D) ON SPAIN APPLICATION NO. 2.268,419, FILED 11-5-1999, REG. NO. 2268419-0, DATED 3-20-2000, EXPIRES 3-20-2010.

FOR PAMPHLETS, BROCHURES AND NEWSLETTERS RELATING TO BANKING, BUSINESS, FINANCE, INSURANCE, REAL ESTATE AND/OR COMMERCE (U.S. CLS. 2, 5, 22, 23, 29, 37, 38 AND 50).

CLASS 16—(Continued).

SN 75-863,287. DAVIS, BILL, DBA FINANCIAL DECISION DATA CO., ENGLEWOOD, CA. FILED 12-3-1999.

LOVESTOCKS

FOR PRINTED MATTER, NAMELY, DAILY REPORTS FEATURING PRICES AND TECHNICAL INDICATORS FOR A SPECIFIC GROUP OF COMMON STOCKS (U.S. CLS. 2, 5, 22, 23, 29, 37, 38 AND 50).

FIRST USE 7-5-1999; IN COMMERCE 7-5-1999.

SN 75-894,206. RESEARCH AND EDUCATION ASSOCIATION, PISCATAWAY, NJ. FILED 1-10-2000.

MATH MADE NICE-N-EASY

OWNER OF U.S. REG. NO. 2,246,194.

NO CLAIM IS MADE TO THE EXCLUSIVE RIGHT TO USE "MATH", APART FROM THE MARK AS SHOWN.

FOR EDUCATIONAL BOOKS IN THE FIELD OF MATHEMATICS (U.S. CLS. 2, 5, 22, 23, 29, 37, 38 AND 50).

FIRST USE 3-22-1999; IN COMMERCE 3-22-1999.

SN 75-905,773. BANCO BILBAO VIZCAYA ARGENTARIA, S.A., 48005 BILBAO, SPAIN, BY MERGER, BY CHANGE OF NAME BANCO BILBAO VIZCAYA, S.A., 48005 BILBAO, SPAIN, FILED 1-28-2000.

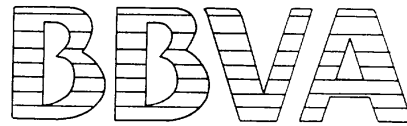

PRIORITY CLAIMED UNDER SEC. 44(D) ON SPAIN APPLICATION NO. 2.282,244, FILED 1-11-2000, REG. NO. 2282244-5, DATED 5-18-2000, EXPIRES 5-18-2010.

THE LINING SHOWN IN THE DRAWING REPRESENTS THE COLOR BLUE WHICH IS A FEATURE OF THE MARK. THE MARK CONSISTS OF "BBVA" COLOR, NAMELY, PANTENE REFLEXIVE BLUE.

FOR PAMPHLETS, BROCHURES AND NEWSLETTERS RELATING TO BANKING, BUSINESS, FINANCE, INSURANCE, REAL ESTATE AND/OR COMMERCE (U.S. CLS. 2, 5, 22, 23, 29, 37, 38 AND 50).

SN 75-906,530. ERIE BUSINESS MANAGEMENT CORP., ERIE, PA. FILED 1-31-2000.

101 THINGS TO DO

SEC. 2(F).

FOR MAGAZINES IN THE FIELD OF TRAVEL (U.S. CLS. 2, 5, 22, 23, 29, 37, 38 AND 50).

FIRST USE 12-0-1995; IN COMMERCE 12-0-1995.

CLASS 16—(Continued).

SN 75-917,661. AMERICAN EXPRESS COMPANY, NEW YORK, NY. FILED 2-12-2000.

**GOAL ACHIEVEMENT
PROJECTION (G.A.P.)
STATEMENT**

NO CLAIM IS MADE TO THE EXCLUSIVE RIGHT TO USE "GOAL ACHIEVEMENT PROJECTION STATEMENT", APART FROM THE MARK AS SHOWN.

FOR BOOKLET IN THE FIELD OF RETIREMENT PLANNING (U.S. CLS. 2, 5, 22, 23, 29, 37, 38 AND 50).

FIRST USE 11-24-1998; IN COMMERCE 11-24-1998.

SN 76-031,213. BARTEL, CINDY, LEAWOOD, KS. FILED 4-24-2000.

IMAGINE INK

FOR PRINTED MATTER, NAMELY, PERSONAL JOURNALS, INSPIRATIONAL BOOKS, PICTORIAL PRINTS, POETRY BOOKS, POEMS, SCRAPBOOK ALBUMS, PHOTOGRAPH ALBUMS AND PAPER KEEP-SAKE BOXES ALL SOLD INDIVIDUALLY AS GIFTS (U.S. CLS. 2, 5, 22, 23, 29, 37, 38 AND 50).

FIRST USE 6-0-1998; IN COMMERCE 6-0-1998.

SN 76-037,738. MEAD CORPORATION, THE, DAYTON, OH. FILED 4-27-2000.



FOR COATED AND UNCOATED PAPERS FOR PRINTING, WRITING, COPYING, PUBLICATION AND REPRODUCTION (U.S. CLS. 2, 5, 22, 23, 29, 37, 38 AND 50).

SN 76-044,025. NEWSTED, JASON, SAN FRANCISCO, CA. FILED 5-8-2000.

ECHOBRAIN

FOR POSTERS, CALENDARS, SONG BOOKS, PENS, PENCILS, GREETING CARDS, AUTOGRAPH BOOKS, POSTER BOOKS, PHOTOGRAPH ALBUMS, APPOINTMENT BOOKS, DECALS, STICKERS, NOTEBOOKS, AND STATIONERY (U.S. CLS. 2, 5, 22, 23, 29, 37, 38 AND 50).

CLASS 16—(Continued).

SN 76-051,806. WOODWARD LABORATORIES, INC., LOS ALAMITOS, CA. FILED 5-19-2000.

**SIMPLE AS ABC-ALWAYS BE
CLEAN**

FOR WRITTEN MATERIALS, NAMELY INSTRUCTIONAL MANUALS IN THE FIELD OF HAND HYGIENE EDUCATION FOR SCHOOL NURSES TO TEACH FACULTY, STAFF, PARENTS AND STUDENTS OF DIFFERENT AGES AND GRADE LEVELS (U.S. CLS. 2, 5, 22, 23, 29, 37, 38 AND 50).

FIRST USE 1-1-2000; IN COMMERCE 1-1-2000.

SN 76-054,241. WATERFORD PRESS LTD, BLAINE, WA. FILED 5-23-2000.

A LITTLE COMMON SENSE

NO CLAIM IS MADE TO THE EXCLUSIVE RIGHT TO USE "COMMON SENSE", APART FROM THE MARK AS SHOWN.

FOR POCKET REFERENCE CARDS REFLECTING COMMON SENSE (U.S. CLS. 2, 5, 22, 23, 29, 37, 38 AND 50).

FIRST USE 1-1-2000; IN COMMERCE 1-1-2000.

SN 76-055,268. BAXTER INTERNATIONAL INC., DEERFIELD, IL. FILED 5-24-2000.

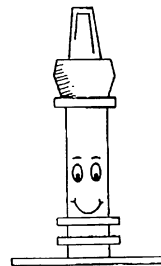

THE MARK CONSISTS OF AN ANIMATED VERSION OF A MOLDED INJECTION PORT THAT IS PART OF AN INTRAVENOUS SOLUTION CONTAINER ASSEMBLY.

FOR NEWSLETTERS THAT ARE DIRECTED TO CORPORATE EMPLOYEES AND CUSTOMERS FEATURING INFORMATION ON THE DRUG DELIVERY FACILITY OPERATIONS, AND NOTE PADS (U.S. CLS. 2, 5, 22, 23, 29, 37, 38 AND 50).

CLASS 16—(Continued).

SN 76-055,730. DAVID J. INSTANCE LIMITED, SEVINGTON, ASHFORD, KENT, UNITED KINGDOM, FILED 5-24-2000.



THE MARK CONSISTS OF THE WORDS AND SYMBOL "PROMO:" IN A RECTANGLE AND THE LETTERS TEXT WITH EACH LETTER IN A SEPARATE SLANTED. THE WORDS "PROMO" AND "TEXT" ARE LOWER CASE. THE LETTERS AND SYMBOL ARE RED AND THE WORD "TEXT" IS WHITE AND THE RECTANGLES ARE BLUE. THE COLORS RED, WHITE AND BLUE ARE CLAIMED AS A FEATURE OF THE MARK.

FOR PRINTED AND PARTIALLY PRINTED LABELS NOT OF TEXTILE, PRINTED AND PARTIALLY PRINTED SELF-ADHESIVE LABELS NOT OF TEXTILE AND PRINTED AND PARTIALLY PRINTED LEAFLET LABELS NOT OF TEXTILE (U.S. CLS. 2, 5, 22, 23, 29, 37, 38 AND 50).

SN 76-056,787. DAVID J. INSTANCE LIMITED, SEVINGTON, ASHFORD, KENT, UNITED KINGDOM, FILED 5-25-2000.

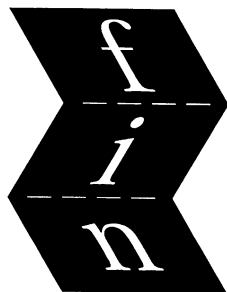

THE MARK CONSISTS OF THE LETTERS "FIN" AND THE LETTERS "FIN" ARE IN SEPARATE ACCORDION TRI-FOLD SLANTED RECTANGLES IN A VERTICAL ARRANGEMENT. THE LETTERS "FIN" APPEAR IN LOWER CASE. THE TOP AND BOTTOM VERTICAL RECTANGLES ARE RED AND THE MIDDLE RECTANGLE IS BLACK. THE LETTERS "FIN" ARE WHITE. THE COLORS RED, BLACK AND WHITE ARE CLAIMED AS A FEATURE OF THE MARK.

FOR PRINTED AND PARTIALLY PRINTED LABELS NOT OF TEXTILE, PRINTED AND PARTIALLY PRINTED SELF-ADHESIVE LABELS NOT OF TEXTILE AND PRINTED AND PARTIALLY PRINTED LEAFLET LABELS NOT OF TEXTILE (U.S. CLS. 2, 5, 22, 23, 29, 37, 38 AND 50).

CLASS 16—(Continued).

SN 76-057,977. DAVID J. INSTANCE LIMITED, SEVINGTON, ASHFORD, KENT, UNITED KINGDOM, FILED 5-26-2000.

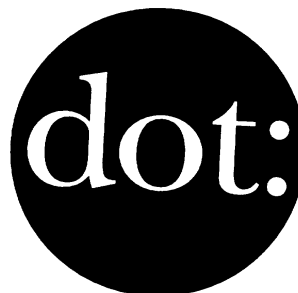

THE LETTERS "DOT" ARE LOWER CASE. THE LETTER "D" IS TEAL, THE "O" IS YELLOW, THE "T" IS PINK AND THE COLON IS GRAY. THE COLORS TEAL, YELLOW, PINK AND GRAY ARE CLAIMED AS A FEATURE OF THE MARK.

FOR PRINTED AND PARTIALLY PRINTED LABELS NOT OF TEXTILE, PRINTED AND PARTIALLY PRINTED SELF-ADHESIVE LABELS NOT OF TEXTILE AND PRINTED AND PARTIALLY PRINTED LEAFLET LABELS NOT OF TEXTILE (U.S. CLS. 2, 5, 22, 23, 29, 37, 38 AND 50).

SN 76-063,153. TAX ANALYSTS, ARLINGTON, VA. FILED 6-5-2000.

FEDERAL TAX BAEDEKER

SEC. 2(F).

FOR SERIES OF REFERENCE BOOKS IN THE FIELD OF TAX, NAMELY, PLAIN-LANGUAGE INTRODUCTIONS TO FEDERAL TAX LAW (U.S. CLS. 2, 5, 22, 23, 29, 37, 38 AND 50).

FIRST USE 8-12-1993; IN COMMERCE 8-12-1993.

SN 76-075,256. IDENTITY GROUP, INC., COOKEVILLE, TN. FILED 5-17-2000.

FLASHSTAMP

OWNER OF U.S. REG. NOS. 2,256,839 AND 2,266,865. FOR HAND HELD RUBBER STAMPS (U.S. CLS. 2, 5, 22, 23, 29, 37, 38 AND 50).

FIRST USE 10-1-1997; IN COMMERCE 10-1-1997.

CLASS 16—(Continued).

SN 76-082,044. SOKA GAKKAI INTERNATIONAL - USA, SANTA MONICA, CA. FILED 7-3-2000.

MIDDLEWAY PRESS

NO CLAIM IS MADE TO THE EXCLUSIVE RIGHT TO USE "PRESS", APART FROM THE MARK AS SHOWN.

FOR PUBLICATION OF GENERAL INTEREST BOOKS FOR SALE TO THE TRADE (U.S. CLS. 2, 5, 22, 23, 29, 37, 38 AND 50).

FIRST USE 9-9-1999; IN COMMERCE 9-9-1999.

CLASS 16—(Continued).

SN 76-093,689. LEE ENTERPRISES, INCORPORATED, DAVENPORT, IA. FILED 7-21-2000.

LINCOLN JOURNAL STAR

NO CLAIM IS MADE TO THE EXCLUSIVE RIGHT TO USE "LINCOLN JOURNAL", APART FROM THE MARK AS SHOWN.

FOR DAILY NEWSPAPER (U.S. CLS. 2, 5, 22, 23, 29, 37, 38 AND 50).

FIRST USE 8-7-1995; IN COMMERCE 8-7-1995.

SN 76-083,883. TIME WARNER ENTERTAINMENT COMPANY, L.P., NEW YORK, NY. FILED 7-6-2000.

GOLDEN SNITCH

FOR PRINTED MATTER AND PAPER GOODS - NAMELY, BOOKS FEATURING CHARACTERS FROM ANIMATED, ACTION ADVENTURE, COMEDY AND/OR DRAMA FEATURES, COMIC BOOKS, CHILDREN'S BOOKS, MAGAZINES FEATURING CHARACTERS FROM ANIMATED, ACTION ADVENTURE, COMEDY AND/OR DRAMA FEATURES, COLORING BOOKS, CHILDREN'S ACTIVITY BOOKS; STATIONERY, WRITING PAPER, ENVELOPES, NOTEBOOKS, DIARIES, NOTE CARDS, GREETING CARDS, TRADING CARDS; LITHOGRAPHS; PENS, PENCILS, CASES THEREFOR, ERASERS, CRAYONS MARKERS, COLORED PENCILS, PAINTING SETS, CHALK AND CHALKBOARDS; DECALS, HEAT TRANSFERS; POSTERS; MOUNTED AND/OR UNMOUNTED PHOTOGRAPHS; BOOK COVERS, BOOK MARKS, CALENDARS, GIFT WRAPPING PAPER; PAPER PARTY FAVORS AND PAPER PARTY DECORATIONS - NAMELY, PAPER NAPKINS, PAPER DOILIES, PAPER PLACE MATS, CREPE PAPER, PAPER HATS, INVITATIONS, PAPER TABLE CLOTHS, PAPER CAKE DECORATIONS; PRINTED TRANSFERS FOR EMBROIDERY OR FABRIC APPLIQUES; PRINTED PATTERNS FOR COSTUMES, PAJAMAS, SWEATSHIRTS AND T-SHIRTS; PAPER PHOTO FRAMES (U.S. CLS. 2, 5, 22, 23, 29, 37, 38 AND 50).

SN 76-087,950. FAIR HAVENS PUBLICATIONS, L.C., GAINESVILLE, TX. BY CHANGE OF NAME WHITE STONE PUBLICATIONS L.C., GAINESVILLE, TX. FILED 7-10-2000.

FAIR HAVENS PUBLICATIONS

NO CLAIM IS MADE TO THE EXCLUSIVE RIGHT TO USE "PUBLICATIONS", APART FROM THE MARK AS SHOWN.

FOR FICTION AND NON-FICTION BOOKS ON A WIDE VARIETY OF TOPICS (U.S. CLS. 2, 5, 22, 23, 29, 37, 38 AND 50).

SN 76-102,558. VICTOR, INC., LIBERTY, MS. FILED 8-2-2000.

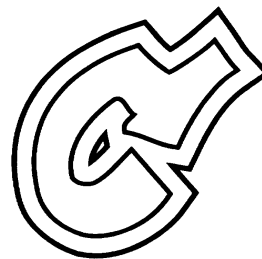

FOR SCHOOL SUPPLIES, NAMELY, WRITING INSTRUMENTS, PENCILS, PENS, ERASERS, PENCIL SHARPENERS, GRADUATED RULERS, PEN OR PENCIL HOLDERS, LOOSE LEAF BINDERS, FOLDERS, NOTEBOOKS, BOOK COVERS, STICKERS; BINDER SETS COMPRISED OF THREE-RING BINDERS, WRITING INSTRUMENTS, FOLDERS, NOTEBOOKS AND PEN AND PENCIL HOLDERS; BOOKS, NAMELY, CHILDREN'S, CHILDREN'S ACTIVITY AND COMIC BOOKS; COMIC STRIPS AND COMPUTERIZED VERSIONS OF SAID COMIC STRIPS AND CHILDREN'S, CHILDREN'S ACTIVITY AND COMIC BOOKS DISTRIBUTED VIA A GLOBAL COMMUNICATIONS NETWORK (U.S. CLS. 2, 5, 22, 23, 29, 37, 38 AND 50).

FIRST USE 11-30-1996; IN COMMERCE 11-30-1996.

SN 76-110,194. BABY'S PLACE COFFEE BAR, INC., KEY WEST, FL. FILED 8-16-2000.

EYE ON KEY WEST

NO CLAIM IS MADE TO THE EXCLUSIVE RIGHT TO USE "KEY WEST", APART FROM THE MARK AS SHOWN.

FOR PRINTED MATTER, NAMELY, NEWSLETTERS PROVIDING LISTINGS AND A GUIDE TO RESTAURANTS, NIGHTCLUBS, ART GALLERIES, SHOPPING, TRANSPORTATION, LODGING AND RELATED ENTERTAINMENT SERVICES (U.S. CLS. 2, 5, 22, 23, 29, 37, 38 AND 50).

CLASS 16—(Continued).

SN 76-110,344. MERCK-MEDCO MANAGED CARE, L.L.C., FRANKLIN LAKES, NJ. FILED 8-17-2000.

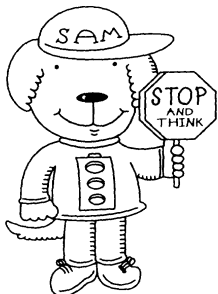

FOR PRINTED EDUCATIONAL MATERIALS IN THE FIELD OF SAFETY AND POISON PREVENTION (U.S. CLS. 2, 5, 22, 23, 29, 37, 38 AND 50).
FIRST USE 3-18-2001; IN COMMERCE 3-18-2001.

SN 76-112,780. TREAT ENTERTAINMENT, INC., FLORENCE, AL. FILED 8-18-2000.



FOR COLORING BOOKS, CHILDREN'S ACTIVITY BOOKS, STORY BOOKS AND CRAYONS (U.S. CLS. 2, 5, 22, 23, 29, 37, 38 AND 50).
FIRST USE 6-14-2000; IN COMMERCE 6-14-2000.

SN 76-115,375. LAURIN PUBLISHING COMPANY, INC., PITTSFIELD, MA. FILED 8-24-2000.

PHOTONICSWEB

OWNER OF U.S. REG. NOS. 1,243,623, 2,206,773 AND OTHERS.

FOR PRINTED PUBLICATION, NAMELY, A MAGAZINE PROVIDING INFORMATION ABOUT OPTICAL, LASER, IMAGING, FIBER OPTICS, ELECTRO-OPTICS AND OPTOELECTRONICS, AND RELATED FIELDS FOUND ON THE INTERNET (U.S. CLS. 2, 5, 22, 23, 29, 37, 38 AND 50).

FIRST USE 7-25-2000; IN COMMERCE 7-25-2000.

CLASS 16—(Continued).

SN 76-119,198. CASIANO COMMUNICATIONS, INC., SAN JUAN, PUERTO RICO, FILED 8-30-2000.

VIDA ACTUAL

FOR PUBLICATIONS, NAMELY, NEWSPAPERS PROVIDING NEWS AND INFORMATION OF GENERAL INTEREST, PUBLISHED IN SPANISH AND DELIVERED BY MAIL (U.S. CLS. 2, 5, 22, 23, 29, 37, 38 AND 50).
FIRST USE 9-6-2000; IN COMMERCE 9-6-2000.

SN 76-125,995. XO COMMUNICATIONS, INC., RESTON, VA. BY CHANGE OF NAME NEXTLINK COMMUNICATIONS, INC, MCLEAN, VA. FILED 9-8-2000.

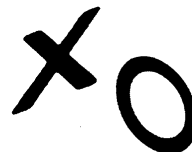

THE MARK CONSISTS OF THE LETTERS "XO" IN STYLIZED FORM, AS SHOWN ON THE ATTACHED DRAWING PAGE.

FOR PRINTED PUBLICATIONS, NAMELY, MAGAZINES, BROCHURES, PAMPHLETS, BOOKS, BOOKLETS, LEAFLETS, MANUALS, AND NEWSLETTERS RELATING TO TELECOMMUNICATIONS SERVICES, TELECOMMUNICATIONS COMPUTER PROGRAMS, THE MAINTENANCE AND OPERATION OF TELECOMMUNICATIONS NETWORKS, COMPUTERS, COMPUTER NETWORKS, COMPUTER DATABASES, COMPUTER SERVICES, OR INTERNET SERVICES; PRINTED REPORTS REGARDING INFORMATION CONTAINED IN DATABASES; PRINTED REPORTS REGARDING COMPUTER AND WEBSITE SECURITY; MANUALS AND PRINTED INSTRUCTIONAL MATERIALS RELATING TO TELECOMMUNICATIONS SERVICES, TELECOMMUNICATIONS COMPUTER PROGRAMS, AND THE MAINTENANCE AND OPERATION OF TELECOMMUNICATIONS NETWORKS, COMPUTERS, COMPUTER NETWORKS, COMPUTER DATABASES, COMPUTER SERVICES, OR INTERNET SERVICES; STATIONARY; POSTERS; MAPS; MOUNTED AND UNMOUNTED PHOTOGRAPHS; PRINTED ADVERTISING AND PROMOTIONAL MATERIALS FOR OTHERS, NAMELY, BROCHURES, FLYERS, PAMPHLETS, NEWSLETTERS, AND MAGAZINE AND NEWSPAPER INSERTS IN THE TELECOMMUNICATIONS, COMPUTER, AND INTERNET FIELDS; PRINTED MATTER, NAMELY, WEB PAGES DOWNLOADED FROM THE INTERNET; DIRECTORIES FOR TELEPHONE NUMBERS, INTERNET WEBSITES, OR E-MAIL ADDRESSES (U.S. CLS. 2, 5, 22, 23, 29, 37, 38 AND 50).

SN 76-149,523. NATIONAL REINING HORSE ASSOCIATION, OKLAHOMA CITY, OK. FILED 10-18-2000.

REINER

SEC. 2(F).

FOR MAGAZINE PROMOTING THE REINING HORSE AND REINING HORSE COMPETITIONS, EVENTS AND SHOWS (U.S. CLS. 2, 5, 22, 23, 29, 37, 38 AND 50).

FIRST USE 1-0-1985; IN COMMERCE 1-0-1985.

CLASS 16—(Continued).

SN 76-170,650. HEINRICH, ADEL V., RUSSELL, OH. FILED 11-27-2000.

LYRIC ART

FOR SHEET MUSIC FEATURING ORIGINAL MUSICAL COMPOSITIONS FOR PIANO BASED ON NATURE SUBJECTS AND SHEET MUSIC JACKETS WITH ORIGINAL PAINTINGS AND INTRODUCTORY POEMS (U.S. CLS. 2, 5, 22, 23, 29, 37, 38 AND 50).

SN 76-180,763. STREET LAW, INC., WASHINGTON, DC. FILED 12-13-2000.

CIVIC FITNESS

FOR PRINTED PUBLICATIONS, NAMELY, BOOKS, MANUALS, WORKBOOKS, NEWSLETTERS, PRINTED TESTS AND PRINTED QUIZZES ALL IN THE FIELDS OF LAW, CRIME PREVENTION, CONFLICT RESOLUTION, CIVICS, COMMUNITY LEADERSHIP, HUMAN RIGHTS AND CITIZENSHIP (U.S. CLS. 2, 5, 22, 23, 29, 37, 38 AND 50).

SN 76-181,111. KIMMITT, THOMAS J., IV, HEATHSVILLE, VA. FILED 12-14-2000.

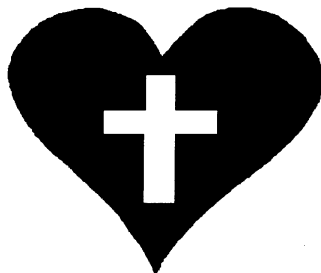

THE DESIGN COMPRISES A RED HEART WITH A WHITE CROSS INSIDE THE HEART AT THE CENTER OF THE HEART.
FOR CHRISTIAN STATIONERY PRODUCTS, NAMELY ERASERS, UNGRADUATED RULERS, PENCILS AND STATIONERY; BUMPER STICKERS (U.S. CLS. 2, 5, 22, 23, 29, 37, 38 AND 50).

CLASS 16—(Continued).

SN 76-182,525. GOURMET CURRICULUM PRESS, INC., NEW BRAUNFELS, TX. FILED 12-18-2000.

GOURMET READING NOVEL DISH SERIES

NO CLAIM IS MADE TO THE EXCLUSIVE RIGHT TO USE "READING NOVEL" AND "SERIES", APART FROM THE MARK AS SHOWN.

FOR PAPER GOODS, NAMELY, A SERIES OF STUDY GUIDES AND TEACHING MANUALS IN THE FIELD OF FICTION AND NONFICTION LITERATURE (U.S. CLS. 2, 5, 22, 23, 29, 37, 38 AND 50).
FIRST USE 6-1-1999; IN COMMERCE 6-1-1999.

SN 76-182,713. INTEGRITY SYSTEMS, INC., PHOENIX, AZ. FILED 12-19-2000.

AID, INC.

OWNER OF U.S. REG. NOS. 1,421,024 AND 1,421,492.
NO CLAIM IS MADE TO THE EXCLUSIVE RIGHT TO USE "INC.", APART FROM THE MARK AS SHOWN.

FOR PRINTED INSTRUCTIONAL AND TRAINING MATERIALS IN THE FORM OF BOOKS AND PAMPHLETS IN THE FIELD OF SALES, SALES TRAINING AND PERSONAL DEVELOPMENT (U.S. CLS. 2, 5, 22, 23, 29, 37, 38 AND 50).
FIRST USE 1-1-1995; IN COMMERCE 1-1-1995.

SN 76-185,689. SILVERSTREAM SOFTWARE, INC., BILLERICA, MA. FILED 12-22-2000.

STREAMLINES

FOR PRINTED MATERIAL, NAMELY, JOURNALS AND NEWSLETTERS IN THE FIELDS OF COMPUTERS AND INFORMATION TECHNOLOGY (U.S. CLS. 2, 5, 22, 23, 29, 37, 38 AND 50).
FIRST USE 4-3-2001; IN COMMERCE 4-3-2001.

SN 76-188,167. MOTTO CITIZENS, LLC, DENMARK, ME. FILED 12-24-2000.

(W)HOLE

FOR BOOKS AND PRINTED INSTRUCTIONAL, EDUCATIONAL, AND TEACHING MATERIALS IN THE FIELD OF CONTEMPLATIVE, PHILOSOPHICAL AND MEDITATIVE STUDIES (U.S. CLS. 2, 5, 22, 23, 29, 37, 38 AND 50).
FIRST USE 12-1-1999; IN COMMERCE 12-1-1999.

CLASS 16—(Continued).

SN 76-194,714. PACIFIC TELECOMMUNICATIONS COUNCIL, HONOLULU, HI. FILED 1-12-2001.

PTR

FOR MAGAZINES IN THE FIELD OF TELECOMMUNICATIONS (U.S. CLS. 2, 5, 22, 23, 29, 37, 38 AND 50).
FIRST USE 9-1-1992; IN COMMERCE 9-1-1992.

SN 76-195,373. NISSAN JIDOSHA KABUSHIKI KAISHA, TA NISSAN MOTOR CO., LTD., KANAGAWA-KEN, JAPAN, FILED 1-11-2001.

XTERRA

FOR BUSINESS CARD HOLDERS (U.S. CLS. 2, 5, 22, 23, 29, 37, 38 AND 50).

SN 76-196,034. MAGGIE WALKER DESIGN, INC., ELVERSON, PA. FILED 1-19-2001.

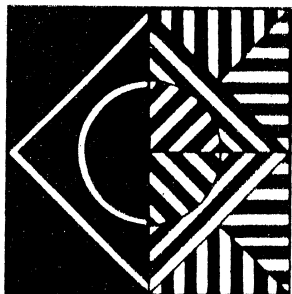

FOR POSTERS, NOTE CARDS, EMBROIDERY DESIGN PATTERNS FOR QUILTS AND CLOTHING (U.S. CLS. 2, 5, 22, 23, 29, 37, 38 AND 50).
FIRST USE 1-0-1992; IN COMMERCE 1-0-1993.

CLASS 16—(Continued).

SN 76-198,648. MVI STUDIOS, INC., SHERMAN OAKS, CA. FILED 1-23-2001.

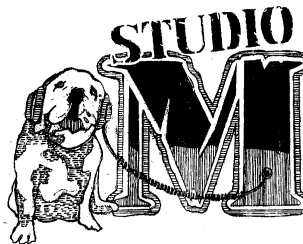

NO CLAIM IS MADE TO THE EXCLUSIVE RIGHT TO USE "STUDIO", APART FROM THE MARK AS SHOWN. THE DRAWING IS LINED FOR THE COLORS BLACK, RED, BLUE AND GRAY.

FOR PRINTED MATTER, NAMELY BOOKS ABOUT MUSIC SHOWS, NEWS SHOWS, AWARD SHOWS, FASHION SHOWS, COMEDY SHOWS, GAME SHOWS, ANIMATED SHOWS, AND MOVIES; NEWSLETTERS ABOUT MUSIC SHOWS, NEWS SHOWS, AWARD SHOWS, FASHION SHOWS, COMEDY SHOWS, GAME SHOWS, ANIMATED SHOWS, AND MOVIES; POSTERS, STICKERS, CALENDARS, TRADING CARDS, PENS, PENCILS, PLAYING CARDS, STATIONERY, AND NOTE PADS (U.S. CLS. 2, 5, 22, 23, 29, 37, 38 AND 50).

FIRST USE 1-22-2001; IN COMMERCE 1-22-2001.

SN 76-205,101. CARTOON NETWORK LP, LLLP, THE, ATLANTA, GA. FILED 2-5-2001.



FOR PAPER GOODS AND PRINTED MATTER, NAMELY, STICKERS, CALENDARS, TRADING CARDS, POSTERS, ARTS AND CRAFTS PAINT SETS FOR CHILDREN, PENS, PENCILS, CHILDREN'S BOOKS, BINDERS, PENCIL CASES, COMIC BOOKS, COLORING BOOKS, POSTCARDS, GREETING CARDS; PAPER PARTY GOODS, NAMELY, HATS, STREAMERS, BLOWERS, TABLECLOTHS, NAPKINS, GIFT WRAP, BANNERS, DOOR SIGNS, TAGS, PARTY DECORATIONS, LUNCH BAGS; AND BANK CHECKS (U.S. CLS. 2, 5, 22, 23, 29, 37, 38 AND 50).

SN 76-206,035. IDEAVILLAGE.COM, LLC, FAIRFIELD, NJ. FILED 2-5-2001.

EDGEMASTER

FOR PAINT ACCESSORIES, NAMELY, ROLLERS WITH EDGE GUARDS, BRUSHES, ROLLER PANS (U.S. CLS. 2, 5, 22, 23, 29, 37, 38 AND 50).
FIRST USE 3-17-2001; IN COMMERCE 3-17-2001.

CLASS 16—(Continued).

SN 76-209,448. DESERET BOOK COMPANY, SALT LAKE CITY, UT. FILED 2-13-2001.

BOOKCRAFT

OWNER OF U.S. REG. NO. 1,463,946.
 FOR FICTION AND NON-FICTION BOOKS IN THE FIELDS OF SELF-HELP, SOCIAL ISSUES AND INSPIRATIONAL AND RELIGIOUS TOPICS, INCLUDING TITLES FOR FAMILIES, WOMEN, CHILDREN, AND YOUTH (U.S. CLS. 2, 5, 22, 23, 29, 37, 38 AND 50).
 FIRST USE 7-27-1943; IN COMMERCE 7-27-1943.

CLASS 16—(Continued).

SN 76-217,546. LIPPINCOTT, WILLIAMS & WILKINS, INC., PHILADELPHIA, PA. FILED 2-28-2001.

INTERACTION ALERT

NO CLAIM IS MADE TO THE EXCLUSIVE RIGHT TO USE "INTERACTION", APART FROM THE MARK AS SHOWN.
 FOR BOOKS, NEWSLETTERS AND JOURNALS CONTAINING INFORMATION REGARDING PHARMACEUTICAL (U.S. CLS. 2, 5, 22, 23, 29, 37, 38 AND 50).

SN 76-211,115. CLEVELAND INDIANS BASEBALL COMPANY LIMITED PARTNERSHIP, CLEVELAND, OH. FILED 2-15-2001.



OWNER OF U.S. REG. NOS. 1,031,410, 1,857,634 AND OTHERS.
 FOR PAPER GOODS AND PRINTED MATTER, NAMELY, TRADING CARDS, PLAYING CARDS, POSTERS, STICKERS, DECALS, TEMPORARY TATTOOS, BUMPER STICKERS, SCOREBOOKS, SCORECARDS, PRINTED BASEBALL GAME PROGRAMS, MAGAZINES AND BOOKS FEATURING BASEBALL, NOTE PAPER, STATIONERY FOLDERS, PREPRINTED AGENDA ORGANIZERS, AUTOGRAPH BOOKS, BOOK COVERS, CALENDARS, GREETING CARDS, BANK CHECKS, CREDIT CARDS NOT MAGNETICALLY READABLE, GIFT WRAPPING PAPER, PAPER GIFT AND PARTY BAGS, PAPER PARTY GOODS, PAPER COASTERS, PAPER NAPKINS, PAPER TABLECLOTHS, LITHOGRAPHS, PAPERWEIGHTS, LETTER OPENERS, PENS, PENCILS, DESK STANDS AND HOLDER FOR PENS, PENCILS AND INK, NON-ELECTRIC ERASERS, AND UNGRADUATED RULERS (U.S. CLS. 2, 5, 22, 23, 29, 37, 38 AND 50).
 FIRST USE 4-0-1951; IN COMMERCE 4-0-1951.

SN 76-213,554. SNOW & ICE BUSINESS MANAGEMENT ASSOCIATION, INC., ERIE, PA. FILED 2-21-2001.

SNOW BUSINESS

NO CLAIM IS MADE TO THE EXCLUSIVE RIGHT TO USE "BUSINESS", APART FROM THE MARK AS SHOWN.
 FOR PERIODIC MAGAZINE SERVING THE SNOW AND ICE CONTROL INDUSTRY (U.S. CLS. 2, 5, 22, 23, 29, 37, 38 AND 50).
 FIRST USE 7-20-2000; IN COMMERCE 9-0-2000.

SN 76-218,749. RUKEYSER, LOUIS, GREENWICH, CT. FILED 3-2-2001.

LOUIS RUKEYSER'S

FOR SERIES OF MONTHLY NEWSLETTERS ON THE TOPIC OF FINANCIAL INVESTING (U.S. CLS. 2, 5, 22, 23, 29, 37, 38 AND 50).
 FIRST USE 0-0-1996; IN COMMERCE 0-0-1996.

SN 76-227,979. KIMBERLY-CLARK CORPORATION, NEE-NAH, WI. FILED 3-22-2001.

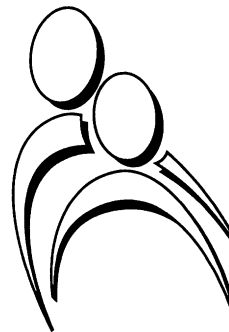

OWNER OF U.S. REG. NOS. 2,225,947, 2,226,371 AND OTHERS.
 FOR DISPOSABLE PAPER TOWELS, AND DISPOSABLE WASHCLOTHS, DISPOSABLE BIBS, DISPOSABLE FLOOR MATS, AND DISPOSABLE MATTRESS PADS ALL MADE OF PAPER (U.S. CLS. 2, 5, 22, 23, 29, 37, 38 AND 50).

SN 76-228,030. ITOYA OF AMERICA, LTD., TORRANCE, CA. FILED 3-21-2001.

O'NETTS

FOR WRITING PENS (U.S. CLS. 2, 5, 22, 23, 29, 37, 38 AND 50).

CLASS 16—(Continued).

SN 76-230,421. DICKENSON, THOMAS B., ROANOKE, VA. FILED 3-26-2001.

THERE IS NOTHING TO DO

FOR SERIES OF NON-FICTION BOOKS IN THE FIELD OF TRAVEL AND TOURISM, BOOK COVERS (U.S. CLS. 2, 5, 22, 23, 29, 37, 38 AND 50).

SN 76-237,970. CHILDREN'S RECYCLING COALITION, L.L.C., THE, AUSTIN, TX. FILED 4-9-2001.

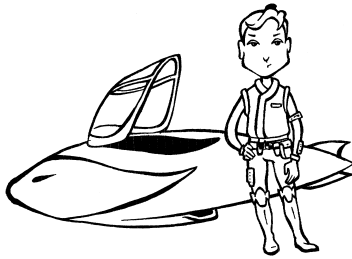

FOR BROCHURES AND PRINTED INSTRUCTIONAL, EDUCATIONAL, AND TEACHING MATERIALS FOR PROMOTING THE BENEFITS OF GENERAL RECYCLING (U.S. CLS. 2, 5, 22, 23, 29, 37, 38 AND 50).

SN 76-242,796. ASPEN PET PRODUCTS, INC., DENVER, CO. FILED 4-18-2001.

WAY TO GO!

FOR DISPOSABLE HOUSEBREAKING PADS FOR PETS (U.S. CLS. 2, 5, 22, 23, 29, 37, 38 AND 50). FIRST USE 0-0-1995; IN COMMERCE 0-0-1995.

SN 76-243,755. GLOBALQUEST, LLC, PRINCETON, NJ. FILED 4-23-2001.

FRONTLINE

FOR PRINTED MATTER, NAMELY SERIES OF BOOKS AND NEWSLETTERS IN THE FIELDS OF LAW, BUSINESS AND TOPICS OF INTEREST TO TOP LEVEL EXECUTIVES (U.S. CLS. 2, 5, 22, 23, 29, 37, 38 AND 50).

CLASS 16—(Continued).

SN 76-244,280. BURGOS, ROBIN, DBA INSPIRATIONS & OBSERVATIONS MINDFULLY EXPRESSED/IOME, LYNDHURST, NJ. FILED 4-23-2001.



FOR GREETING CARDS, BOOKMARKS, BLANK JOURNALS, WRITING JOURNALS FEATURING POEMS, PHOTOGRAPHS, POSTERS, WALLET CALENDARS, CALENDARS, ADDRESS AND PHONE BOOKS, NOTEPADS, MAGAZINES IN THE FIELD OF HEALTH AND WELLNESS, PHOTO ALBUMS, BOOK OF POEMS, PAPER INVITATIONS, PAPER FAVOR TAGS, SCRAPBOOKS, PAPER GIFT BAGS FOR ALL OCCASIONS, WRAPPING PAPER, NAPKINS FOR ALL OCCASIONS, PAPER TOWELS, PAPER DECORATION CUT OUTS, PERSONAL BANK CHECKS AND PAPER MAILING LABELS, PLAYING CARDS FEATURING INSPIRATIONAL MESSAGES, FAMILY TREE ALBUMS, ALL OF THE ABOVE WITH AND WITHOUT PHOTO INSERTS; BOOKS IN THE FIELD OF HEALTH AND WELLNESS WITH AND WITHOUT PHOTO INSERTS FOR BODY WORKERS AND THERAPISTS, PAPER FOR WRAPPING AND PACKAGING NATURAL FOODS, SUNDRIES, AND BEVERAGES, BOOKLETS FOR CHILDREN REGARDING DIVORCE ISSUES WITH AND WITHOUT PHOTO INSERTS, BOOKLETS FEATURING INSPIRATIONAL MESSAGES FOR NON-DENOMINATIONAL YOUTH ORGANIZATIONS AND EDUCATIONAL CENTERS WITH AND WITHOUT PHOTO INSERTS, PAPER WINE LABELS, AND CALENDARS FOR DOCTOR'S OFFICES AND FOR PATIENTS TO TRACK VISITS (U.S. CLS. 2, 5, 22, 23, 29, 37, 38 AND 50).

SN 76-254,642. CHRISTIAN CHILDREN'S FUND, INCORPORATED, RICHMOND, VA. FILED 5-9-2001.

CHILDREN'S CIRCLE NEWS

NO CLAIM IS MADE TO THE EXCLUSIVE RIGHT TO USE "NEWS", APART FROM THE MARK AS SHOWN.

FOR PRINTED PUBLICATIONS, NAMELY, NEWSLETTERS PROVIDING INFORMATION ABOUT SERVICES AND PROGRAMS FOR NEEDY CHILDREN THROUGHOUT THE WORLD (U.S. CLS. 2, 5, 22, 23, 29, 37, 38 AND 50).

FIRST USE 0-0-1995; IN COMMERCE 0-0-1995.

CLASS 16—(Continued).

SN 76-257,256. NINTENDO OF AMERICA INC., REDMOND, WA. FILED 5-15-2001.

PIKMIN

FOR PRINTED MATTER AND PUBLICATIONS, NAMELY ADDRESS BOOKS; ARTISTS' BRUSHES; ARTISTS' PASTELS; ARTS AND CRAFTS PAINT KITS; BOOK COVERS; BOOKMARKS; BOOKPLATES; CALENDARS; CARDBOARD GIFT BOXES; CHILDREN'S BOOKS; COLORING AND ACTIVITY BOOKS; COMIC BOOKS; CRAYONS; DECORATIVE FIGURES ATTACHABLE TO PENCILS; DRAWING RULERS; DRY ERASE WRITING BOARDS; ERASERS; FELT-TIP MARKERS; GIFT WRAPPING PAPER; GREETING CARDS; INVITATION CARDS; IRON-ON TRANSFERS; MAGAZINES REGARDING VIDEO GAMES; MAGNETIC SLATE BOARDS FOR WRITING; MEMO BOARDS; MEMO PADS; NEWSPAPER CARTOONS; NOTEBOOKS; NOTE-PADS; PAINTING SETS FOR ARTISTS; PAINTING SETS FOR CHILDREN; PAPER BANNERS; PAPER DECORATIONS MOUNTABLE ON DOORS; PAPER NAPKINS; PAPER PARTY FAVORS; PAPER PARTY HATS; PAPER PLACEMATS; PAPER TABLE COVERS; PAPERBACK BOOKS FOR CHILDREN; PENCIL BOXES WITH MAGNETIC CLOSURES; PENCIL SHARPENERS; PENCILS; PENS; PICTURE STORYBOOKS FOR CHILDREN; PLAYING CARDS; POSTCARDS; POSTERS; RING BINDERS; RUBBER STAMPS; SCORE BOOKS; SCRAPBOOKS AND STAMP COLLECTOR BOOKS; SCRATCH PADS; STAPLERS; STATIONERY-TYPE PORTFOLIOS; STICKER ALBUMS; STICKERS; CHILDREN'S STORYBOOK AND AUDIO CASSETTES SOLD AS A UNIT; AND TRADING CARDS (U.S. CLS. 2, 5, 22, 23, 29, 37, 38 AND 50).

SN 76-257,538. GOODWAY GROUP, JENKINTOWN, PA. FILED 5-15-2001.

MINIZONE

FOR NEWSPAPER INSERTS FEATURING THIRD-PARTY ADVERTISEMENTS (U.S. CLS. 2, 5, 22, 23, 29, 37, 38 AND 50).

SN 76-257,982. SCRANTON TIMES, L.P., THE, SCRANTON, PA. FILED 5-16-2001.

TIMES • SHAMROCK

FOR NEWSPAPERS (U.S. CLS. 2, 5, 22, 23, 29, 37, 38 AND 50).
FIRST USE 12-0-1987; IN COMMERCE 12-0-1987.

CLASS 16—(Continued).

SN 76-261,215. GEORGE LITHOGRAPH COMPANY, BRISBANE, CA. FILED 5-22-2001.



THE MARK CONSISTS OF THE WORD PHRASE "GEO-PAQUE" AND THE DESIGN OF A CIRCLE CONTAINING THREE-ARROW DESIGN, REPRESENTING THE LETTER "O".

FOR PRINTING PAPER, COPY PAPER, RECYCLED PAPER, REPRODUCTION PAPER AND BOND PAPER (U.S. CLS. 2, 5, 22, 23, 29, 37, 38 AND 50).

SN 76-261,319. TURNER REGIONAL ENTERTAINMENT NETWORK, INC., ATLANTA, GA. FILED 5-23-2001.

OFF THE MENU

FOR PRINTED MATERIALS, NAMELY, BOOKS AND MAGAZINES REGARDING COOKING, STATIONARY, PHOTOGRAPHS, PENS, PENCILS, POST CARDS, AND GREETING CARDS (U.S. CLS. 2, 5, 22, 23, 29, 37, 38 AND 50).

SN 76-261,783. NATIONAL HOCKEY LEAGUE, NEW YORK, NY. FILED 5-23-2001.

NHL HOCKEY RULES

FOR INSTRUCTIONAL BOOKS AND BOOKLETS RELATING TO HOCKEY, EXCLUDING BOOKS AND BOOKLETS RELATING TO THE RULES OF HOCKEY; POSTERS, MOUNTED PHOTOGRAPHS, UNMOUNTED PHOTOGRAPHS, PRINTED PAPER SIGNS, STICKER PACKS AND ALBUMS, TRADING CARDS AND ALBUMS, BOOK COVERS, BOOK MARKS, DECALS, BUMPER STICKERS AND PAPER DOOR KNOB HANGER SIGNS (U.S. CLS. 2, 5, 22, 23, 29, 37, 38 AND 50).

SN 76-262,278. DESIGN 1-2-3, INC., BELLAIRE, TX. FILED 5-24-2001.



FOR DESIGN PATTERNS AND INSTRUCTIONS FOR MAKING FURNITURE AND ORNAMENTAL AND GRAPHICAL DESIGNS TO BE APPLIED TO FURNITURE (U.S. CLS. 2, 5, 22, 23, 29, 37, 38 AND 50).

CLASS 16—(Continued).

SN 76-263,521. E.K. SUCCESS, LTD., CLIFTON, NJ. FILED 5-29-2001.

COLORBRUSH TWIN

OWNER OF U.S. REG. NO. 2,474,269.
FOR MARKERS (U.S. CLS. 2, 5, 22, 23, 29, 37, 38 AND 50).

SN 76-268,582. CHANG, MARLON, NEW BRITAIN, CT.
FILED 6-8-2001.

GUNDILERO

FOR COMIC BOOKS (U.S. CLS. 2, 5, 22, 23, 29, 37, 38 AND 50).

SN 76-272,859. CFW ENTERPRISES, INC., BURBANK, CA.
FILED 6-18-2001.

INSIDE KARATE

NO CLAIM IS MADE TO THE EXCLUSIVE RIGHT TO USE "KARATE", APART FROM THE MARK AS SHOWN.
FOR MAGAZINE IN THE FIELD OF MARTIAL ARTS (U.S. CLS. 2, 5, 22, 23, 29, 37, 38 AND 50).
FIRST USE 1-1-1985; IN COMMERCE 1-1-1985.

SN 76-275,699. FLORSHEIM, KATHIE R., PROVIDENCE, RI.
FILED 6-21-2001.

A DAY AT THE BEACH

FOR POSTCARDS, NOTE CARDS, DIARIES AND GUEST BOOKS, ALL CONTAINING PHOTOGRAPHS OR MODIFIED PHOTOGRAPHS (U.S. CLS. 2, 5, 22, 23, 29, 37, 38 AND 50).

SN 76-275,897. KIDS FOUNDATION, BEL AIR, CA. FILED 6-22-2001.

HAPPINESS HAPPENS THROUGH MY EYES

FOR SERIES OF CHILDREN'S EDUCATIONAL BOOKS, PENCILS, PENS, PENCIL BOXES, PEN BOXES, POSTCARDS, BINDERS, BOOKMARKS, SCRAPBOOK ALBUMS, CALENDARS, FLASH CARDS, TRADING CARDS, SERIES OF COLORING BOOKS, BOOK COVERS, DECALS, STICKERS, CROSSWORD PUZZLES, POSTERS, PLAYING CARDS AND PICTURE BOOKS (U.S. CLS. 2, 5, 22, 23, 29, 37, 38 AND 50).

CLASS 16—(Continued).

SN 76-275,899. KIDS FOUNDATION, BEL AIR, CA. FILED 6-22-2001.

HAPPINESS HAPPENS THROUGH MY NOSE

FOR SERIES OF CHILDREN'S EDUCATIONAL BOOKS, PENCILS, PENS, PENCIL BOXES, PEN BOXES, POSTCARDS, BINDERS, BOOKMARKS, SCRAPBOOK ALBUMS, CALENDARS, FLASH CARDS, TRADING CARDS, SERIES OF COLORING BOOKS, BOOK COVERS, DECALS, STICKERS, CROSSWORD PUZZLES, POSTERS, PLAYING CARDS AND PICTURE BOOKS (U.S. CLS. 2, 5, 22, 23, 29, 37, 38 AND 50).

SN 76-276,274. LEISURE ARTS, INC., BIRMINGHAM, AL.
FILED 6-26-2001.

A PALETTE PUBLICATION

NO CLAIM IS MADE TO THE EXCLUSIVE RIGHT TO USE "PUBLICATION", APART FROM THE MARK AS SHOWN.

FOR PRINTED REFERENCE AND EDUCATIONAL SERIES OF LEAFLETS IN THE FIELD OF ART AND PAINTS (U.S. CLS. 2, 5, 22, 23, 29, 37, 38 AND 50).
FIRST USE 5-1-2001; IN COMMERCE 5-1-2001.

SN 76-276,383. LOCAL CHURCH MINISTRIES, CLEVELAND, OH. FILED 6-25-2001.



OWNER OF U.S. REG. NO. 727,331.
NO CLAIM IS MADE TO THE EXCLUSIVE RIGHT TO USE "PRESS", APART FROM THE MARK AS SHOWN.
FOR RELIGIOUS BOOKS, RELIGIOUS MAGAZINES AND PAMPHLETS (U.S. CLS. 2, 5, 22, 23, 29, 37, 38 AND 50).
FIRST USE 12-13-2000; IN COMMERCE 1-20-2001.

CLASS 16—(Continued).

SN 76-276,413. MISTRETTA, ANDREA, WALDWICK, NJ. FILED 6-25-2001.

BLIZZKIDZZ

FOR PRINTED ARTWORK, NAMELY, ART PRINTS, CALENDARS, GREETING CARDS, POSTERS, STICKERS, GIFT WRAPPING PAPER, WALL PAPER SAMPLE BOOKS, SHELF PAPER, ART BOOKS, CHILDREN'S BOOKS, BOOKMARKS, BOOK COVERS, PAPER PLACE MATS, PLASTIC PLACE MATS, STATIONERY, PAPER GIFT BOXES, PAPER GIFT BAGS (U.S. CLS. 2, 5, 22, 23, 29, 37, 38 AND 50).

SN 76-276,441. HARPER, BEN, LOS ANGELES, CA. FILED 6-25-2001.

BEN HARPER

OWNER OF U.S. REG. NO. 2,353,193.
FOR PRINTED MATTER, PAPER AND STATIONERY PRODUCTS, NAMELY, POSTERS, STICKERS, BUMPER STICKERS, DECALS AND CONCERT SOUVENIR PROGRAMS (U.S. CLS. 2, 5, 22, 23, 29, 37, 38 AND 50).
FIRST USE 4-0-1992; IN COMMERCE 4-0-1992.

SN 76-287,218. AMERICAN AUTOMOBILE ASSOCIATION, INC., HEATHROW, FL. FILED 7-18-2001.

**AAA NORTH AMERICAN
ATLAS FOR TEENS**

OWNER OF U.S. REG. NOS. 703,556, 926,898 AND 952,027.
NO CLAIM IS MADE TO THE EXCLUSIVE RIGHT TO USE "NORTH AMERICAN ATLAS FOR TEENS", APART FROM THE MARK AS SHOWN.
FOR REFERENCE ATLASES, (U.S. CLS. 2, 5, 22, 23, 29, 37, 38 AND 50).

SN 76-289,321. QWEST COMMUNICATIONS INTERNATIONAL INC., DENVER, CO. FILED 7-23-2001.

QWEST FOR HOME

FOR PERIODIC PUBLICATION, NAMELY, A NEWSLETTER WITH AN EMPHASIS ON TELECOMMUNICATIONS (U.S. CLS. 2, 5, 22, 23, 29, 37, 38 AND 50).

CLASS 16—(Continued).

SN 76-289,659. BREEDERS' CUP LIMITED, LEXINGTON, KY. FILED 7-24-2001.



OWNER OF U.S. REG. NO. 1,329,566.
FOR PAPER AND PRINTED MATTER; NAMELY, RACING PROGRAMS, PRINTED TICKETS, TRADING CARDS, POSTERS AND BOOKS AND MAGAZINES FEATURING INFORMATION ON HORSE RACING (U.S. CLS. 2, 5, 22, 23, 29, 37, 38 AND 50).

SN 76-289,754. ELMER'S INVESTMENTS, INC., WILMINGTON, DE. FILED 7-25-2001.

JELLY GELS

OWNER OF U.S. REG. NOS. 2,152,068, 2,246,272 AND OTHERS.
NO CLAIM IS MADE TO THE EXCLUSIVE RIGHT TO USE "GEL", APART FROM THE MARK AS SHOWN.
FOR DECORATIVE GLUE AND PAINT PENS FOR HOUSEHOLD AND STATIONERY USE (U.S. CLS. 2, 5, 22, 23, 29, 37, 38 AND 50).

SN 76-302,794. CORCETTO ENTERPRISES LTD., REINHOLDS, PA. FILED 8-22-2001.

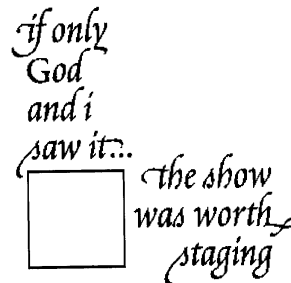

FOR PICTURE BOOKS, ART PRINTS, POSTERS, NOTE CARDS, POSTCARDS, DATE BOOKS (U.S. CLS. 2, 5, 22, 23, 29, 37, 38 AND 50).

CLASS 16—(Continued).

SN 76-308,123. BINNEY & SMITH INC., EASTON, PA. FILED 9-4-2001.

CLICK'EM ON

FOR MARKERS (U.S. CLS. 2, 5, 22, 23, 29, 37, 38 AND 50).

SN 76-308,686. AMBROSE INTERNATIONAL, INC., TROY, MI. FILED 9-5-2001.

WHITE TIGER

FOR BOND PAPER (U.S. CLS. 2, 5, 22, 23, 29, 37, 38 AND 50).

SN 76-308,717. BUDDY PRODUCTS DIVISION, NINA ENTERPRISES, INC., CHICAGO, IL. FILED 9-4-2001.

SUNSET

FOR OFFICE REQUISITES, NAMELY, DESKTOP AND WALL-HUNG MULTIPOCKET PAPER SHEET AND ENVELOPE HOLDERS (U.S. CLS. 2, 5, 22, 23, 29, 37, 38 AND 50).

FIRST USE 10-0-1997; IN COMMERCE 10-0-1997.

SN 76-310,347. KISS CATALOG LTD., PORT WASHINGTON, NY. FILED 9-7-2001.

STARCHILD

FOR COMIC BOOKS (U.S. CLS. 2, 5, 22, 23, 29, 37, 38 AND 50).

SN 78-012,609. PILOTS EXPRESS, LTD., OMAHA, NE. BY ASSIGNMENT BARBER, CAROL A., FORTSON, GA. FILED 6-14-2000.

THE PILOTS EXPRESS

NO CLAIM IS MADE TO THE EXCLUSIVE RIGHT TO USE "PILOTS", APART FROM THE MARK AS SHOWN.

FOR PUBLICATIONS, NAMELY, AIRPORT DIRECTORIES (U.S. CLS. 2, 5, 22, 23, 29, 37, 38 AND 50).

FIRST USE 6-8-2000; IN COMMERCE 6-8-2000.

CLASS 16—(Continued).

SN 78-015,838. DIVISION SALES, INC., ITASCA, IL. FILED 7-7-2000.

PERFECT ACCESSORIES COLLECTION

NO CLAIM IS MADE TO THE EXCLUSIVE RIGHT TO USE "ACCESSORIES COLLECTION", APART FROM THE MARK AS SHOWN.

FOR PAPER GIFT BAGS, GIFT-WRAPPING PAPER, PAPER RIBBONS, AND TISSUE PAPER (U.S. CLS. 2, 5, 22, 23, 29, 37, 38 AND 50).

SN 78-019,594. KASTEN, ERIC, P., DEWITT, MI. FILED 8-3-2000.

SUN PUPPY

FOR COMIC STRIPS, CARTOON PRINTS, CARTOON STRIPS (U.S. CLS. 2, 5, 22, 23, 29, 37, 38 AND 50).

FIRST USE 1-30-2000; IN COMMERCE 5-14-2000.

SN 78-022,266. GENERAL MOTORS CORPORATION, DETROIT, MI. FILED 8-22-2000.

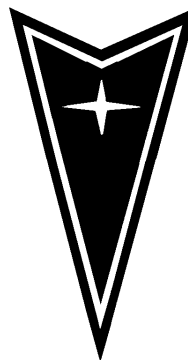

OWNER OF U.S. REG. NOS. 1,660,240, 1,751,115 AND OTHERS.

FOR PRESSURE SENSITIVE GRAPHICS FOR APPLICATION TO AUTOMOBILES AND WINDOWS, DECALS, PENS, PENCILS, CALENDARS, PHOTOGRAPH ALBUMS, NOTE PAPER, PLAYING CARDS, STATIONERY (U.S. CLS. 2, 5, 22, 23, 29, 37, 38 AND 50).

FIRST USE 9-30-1975; IN COMMERCE 9-30-1975.

CLASS 16—(Continued).

SN 78-022,793. PEARSON, RICHARD M., GRANTSBURG, WI. FILED 8-24-2000.



THE LINING IS A FEATURE OF THE MARK AND DOES NOT INDICATE COLOR.

FOR PRINTED PAPER SLEEVES USED FOR THE PROTECTION, STORAGE AND DISPLAY OF 78RPM PHONOGRAPH RECORDS (U.S. CLS. 2, 5, 22, 23, 29, 37, 38 AND 50).

FIRST USE 8-18-2000; IN COMMERCE 8-18-2000.

CLASS 16—(Continued).

SN 78-034,024. AGENCY FOR INSTRUCTIONAL TECHNOLOGY, BLOOMINGTON, IN. FILED 11-6-2000.



NO CLAIM IS MADE TO THE EXCLUSIVE RIGHT TO USE "READING", APART FROM THE MARK AS SHOWN.

FOR PRINTED MATERIALS, NAMELY, BOOKS COVERS; DUPLICATING MASTERS; CARDBOARD AND PAPER CONTAINERS FOR STORING EDUCATIONAL PUBLICATIONS (U.S. CLS. 2, 5, 22, 23, 29, 37, 38 AND 50).

SN 78-025,809. BRADDOCK, P. J., LAS VEGAS, NV. FILED 9-14-2000.

HOLLYWOOD PROPHET

FOR SERIES OF NON-FICTION AND FICTION BOOKS ON SELF-AWARENESS AND SPIRITUAL GROWTH, NEWSLETTERS, MAGAZINES, PRINTED ARTICLES, BULLETINS AND BROCHURES, INSTRUCTIONAL MANUALS, PRINTED CORRESPONDENCE COURSE MATERIALS, GUIDEBOOKS AND PRINTED MATERIALS ALL FOR USE IN TEACHING SELF AWARENESS AND SPIRITUAL GROWTH, STATIONERY, WRITING PAPER, ENVELOPES, NOTEBOOKS, NOTE CARDS, GREETING CARDS, POSTCARDS, POSTERS, PENS, PENCILS, DECALS, BOOKMARKS, BOOK COVERS, CALENDARS, TELEPHONE AND ADDRESS BOOKS, STICKERS, ENGAGEMENT BOOKS, NOTEBOOKS, RING BINDERS, PRINTED IRON-ON TRANSFERS FOR EMBROIDERY OR FABRIC APPLIQUES, PRINTED PATTERNS FOR USE IN APPLYING ON SWEATSHIRTS, T-SHIRTS, HATS, TOTE BAGS AND COFFEE MUGS (U.S. CLS. 2, 5, 22, 23, 29, 37, 38 AND 50).

SN 78-038,295. MENTOR TOOL SHOP LLC, THE, SEATTLE, WA. FILED 12-7-2000.



NO CLAIM IS MADE TO THE EXCLUSIVE RIGHT TO USE "MAKING STEP-RELATIONSHIPS WORK", APART FROM THE MARK AS SHOWN.

FOR PRINTED MATTER, NAMELY SERIES OF FICTION AND NON-FICTION BOOKS, CALENDARS, GREETING CARDS, STATIONERY, NOTE CARDS, BOOKMARKS, MAGAZINES, NEWSLETTERS AND CATALOGS ALL IN THE FIELD OF FAMILY RELATIONSHIPS (U.S. CLS. 2, 5, 22, 23, 29, 37, 38 AND 50).

FIRST USE 11-21-2000; IN COMMERCE 11-21-2000.

SN 78-026,240. ACCENT MIAMI, INCORPORATED, MIAMI BEACH, FL. FILED 9-17-2000.

ACCENT MIAMI

NO CLAIM IS MADE TO THE EXCLUSIVE RIGHT TO USE "MIAMI", APART FROM THE MARK AS SHOWN.

FOR MAGAZINE DEALING WITH IDEAS, ARTS AND COMMENTARY RELATING TO THE CITY AND REGION OF MIAMI, FLORIDA (U.S. CLS. 2, 5, 22, 23, 29, 37, 38 AND 50).

SN 78-041,864. POLYMER ENGINEERING CORPORATION, OXNARD, CA. FILED 1-5-2001.

BODY PARTS

FOR CALENDARS (U.S. CLS. 2, 5, 22, 23, 29, 37, 38 AND 50).

SN 78-028,441. PINEDA, EARL B., SAN FRANCISCO, CA. FILED 9-30-2000.

PLAYSIA

FOR MAGAZINES IN THE FIELD OF ADULT ENTERTAINMENT (U.S. CLS. 2, 5, 22, 23, 29, 37, 38 AND 50).

SN 78-045,280. REPELLENT CO., JERSEY CITY, NJ. FILED 1-27-2001.

REPELLENT

FOR MAGAZINES IN THE FIELD OF FREESTYLE EXPRESSIONISM, NAMELY PHOTOGRAPHY, POETRY, ART, MUSIC, OPINIONS, UNDERGROUND WORKING HEROES, AND STREET STYLE (U.S. CLS. 2, 5, 22, 23, 29, 37, 38 AND 50).

CLASS 16—(Continued).

SN 78-050,838. AMERICAN AUTOMOBILE ASSOCIATION, INC., HEATHROW, FL. FILED 3-1-2001.

AAA AUTO GUIDE

NO CLAIM IS MADE TO THE EXCLUSIVE RIGHT TO USE "AUTO GUIDE", APART FROM THE MARK AS SHOWN.

FOR SERIES OF BOOKS FOR GUIDANCE ON AUTOMOTIVE TOPICS; NAMELY, CARE CARE, BUYING AND LEASING, AND DRIVER SAFETY (U.S. CLS. 2, 5, 22, 23, 29, 37, 38 AND 50).

SN 78-053,567. INTERNATIONAL MASTERS PUBLISHERS AB, MALMO, SWEDEN, FILED 3-16-2001.

CREATIVE HOME LIVING

OWNER OF U.S. REG. NOS. 1,939,018, 2,245,156 AND 2,245,157.

FOR PERIODICAL PUBLICATION ON THE SUBJECT OF INTERIOR DESIGN AND RENOVATION, LANDSCAPING, COOKING, FITNESS, HEALTH AND NUTRITION IN THE NATURE OF A MAGAZINE (U.S. CLS. 2, 5, 22, 23, 29, 37, 38 AND 50).

SN 78-057,179. BREYCHAK, KATHY, COLUMBIA STATION, OH. FILED 4-6-2001.

CHAMPIONS OF THE HEART

FOR TRADING CARDS FEATURING PICTURES OF ANIMALS (U.S. CLS. 2, 5, 22, 23, 29, 37, 38 AND 50).
FIRST USE 4-5-2001; IN COMMERCE 4-5-2001.

SN 78-066,750. ESPINOSA, CHRISTOPHER THOMAS, KELLER, TX. FILED 5-31-2001.

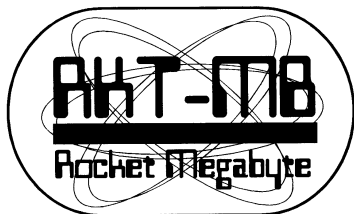

FOR CHILDREN'S BOOKS (U.S. CLS. 2, 5, 22, 23, 29, 37, 38 AND 50).

CLASS 16—(Continued).

SN 78-069,893. LOWTHER, ALAN ROCKY, AKRON, OH. FILED 6-19-2001.

HOT ROD GUITARS

NO CLAIM IS MADE TO THE EXCLUSIVE RIGHT TO USE "GUITARS", APART FROM THE MARK AS SHOWN.

FOR MAGAZINES AND BOOKS ON THE SUBJECT OF ELECTRIC GUITARS (U.S. CLS. 2, 5, 22, 23, 29, 37, 38 AND 50).

SN 78-073,181. HARPERCOLLINS PUBLISHERS LIMITED, GLASGOW, UNITED KINGDOM, FILED 7-10-2001.



FOR SERIES OF NON-FICTION BOOKS ON THE SUBJECT OF PERSONAL GROWTH AND DEVELOPMENT, PERSONAL RELATIONSHIPS, DIVINATION, ASTROLOGY, PARENTING; AND MENTAL, PHYSICAL AND SPIRITUAL HEALTH, FITNESS AND AWARENESS (U.S. CLS. 2, 5, 22, 23, 29, 37, 38 AND 50).
FIRST USE 11-30-1999; IN COMMERCE 11-30-1999.

SN 78-078,022. PASS!TIME MARKETING, SAN JOSE, CA. FILED 8-7-2001.

FLATCH U. LENTS

FOR COMIC STRIPS; COMIC BOOKS; BOOKS CONTAINING COMPILATIONS OF COMIC STRIPS; GREETING CARDS; PRINTED INVITATIONS; MEMO PADS; BOOK COVERS; BOOK ENDS; BOOKMARKS; CALENDARS; APPOINTMENT CALENDARS; FRAMED COLLECTIBLE COMIC STRIPS; POSTERS; BUMPER STICKERS; BUSINESS CARDS; DESK PADS; STICKERS; POSTCARDS (U.S. CLS. 2, 5, 22, 23, 29, 37, 38 AND 50).

SN 78-079,419. EVANS, AMANDA LOUISE, AUSTIN, TX. FILED 8-15-2001.

PENTALIA

FOR SERIES OF FICTION BOOKS (U.S. CLS. 2, 5, 22, 23, 29, 37, 38 AND 50).

CLASS 16—(Continued).

SN 78-079,420. RAIKES, CAROL L., TUCSON, AZ. FILED 8-15-2001.

SLEEPY GNOME PUBLISHING

NO CLAIM IS MADE TO THE EXCLUSIVE RIGHT TO USE "PUBLISHING", APART FROM THE MARK AS SHOWN.

FOR SERIES OF FICTION AND NON-FICTION BOOKS ON A VARIETY OF TOPICS (U.S. CLS. 2, 5, 22, 23, 29, 37, 38 AND 50).

SN 78-084,162. SMITHKLINE BEECHAM CORPORATION, PHILADELPHIA, PA. FILED 9-17-2001.

BIG HELP FOR LITTLE EARS

FOR PRINTED EDUCATIONAL MATERIALS, NAMELY BROCHURES, PAMPHLETS, AND NEWSLETTERS CONCERNING THE TREATMENT OF CHILDREN'S EAR INFECTIONS (U.S. CLS. 2, 5, 22, 23, 29, 37, 38 AND 50).

SN 78-084,660. W.A. CHARNSTROM CO. INC., SHAKOPEE, MN. FILED 9-20-2001.

WIRE-PLACE

FOR WORKPLACE ORGANIZERS, DESK TOP ORGANIZERS, PERSONAL ORGANIZERS, ORGANIZERS FOR STATIONERY USE, AND ACCESSORIES THEREFOR (U.S. CLS. 2, 5, 22, 23, 29, 37, 38 AND 50).

CLASS 17—RUBBER GOODS

SN 75-681,266. IPEX INC., DON MILLS, ONTARIO, CANADA, FILED 4-13-1999.

FIBERTEL

PRIORITY CLAIMED UNDER SEC. 44(D) ON CANADA APPLICATION NO. 898,483, FILED 12-3-1998, REG. NO. 532722, DATED 9-14-2000, EXPIRES 9-14-2015.

FOR PLASTIC PIPE AND DUCT FOR VOICE AND DATA COMMUNICATION CABLES, WIRES AND LINES AND POWER CABLES, WIRE AND LINES (U.S. CLS. 1, 5, 12, 13, 35 AND 50).

CLASS 17—(Continued).

SN 75-847,926. ITT INDUSTRIES, INC., WHITE PLAINS, NY. FILED 11-15-1999.

ZEROPERM

OWNER OF U.S. REG. NO. 1,912,518.
FOR PLASTIC TUBING CONTAINING ALUMINUM FOR FUEL LINES DELIVERY SYSTEMS FOR VEHICLES (U.S. CLS. 1, 5, 12, 13, 35 AND 50).

SN 76-075,991. FARREL CORPORATION, ANSONIA, CT. FILED 6-23-2000.

ECO-GLAND

OWNER OF U.S. REG. NO. 594,188.
FOR SELF-LUBRICATING DUST SEALS FOR INDUSTRIAL MECHANICAL MIXERS FOR PROCESSING RUBBER, PLASTIC AND OTHER COMPOSITIONS (U.S. CLS. 1, 5, 12, 13, 35 AND 50).

FIRST USE 9-1-1995; IN COMMERCE 9-29-1995.

SN 76-100,112. NIHON WAVELOCK KABUSHIKI KAISHA, AKA JAPAN WAVELOCK CO., LTD., CHUO-CU, TOKYO, JAPAN, FILED 7-31-2000.

SUPER TECHMIRROR

NO CLAIM IS MADE TO THE EXCLUSIVE RIGHT TO USE "SUPER", APART FROM THE MARK AS SHOWN.

FOR LAMINATED PLASTIC FILM FOR USE IN EXTERIOR DECOR OF AUTOMOBILES, NAMELY LAMP REFLECTORS, RADIATOR GRILLES, FRONT BUMPER MOLDINGS, WHEEL CAPS, FRONT WINDOW/WINDSHIELD MOLDINGS, SIDE MOLDINGS, SIDE GARNISHES, SIDE WINDOW SASH MOLDINGS, REAR WINDOW MOLDINGS AND REAR BUMPER MOLDINGS; PLASTIC FILMS FOR INDUSTRIAL AND COMMERCIAL PACKING USE OTHER THAN WRAPPING; PLASTIC FILMS OTHER THAN WRAPPING, NAMELY FOR GENERAL INDUSTRIAL USE AND FOR USE IN MANUFACTURING AUTOMOBILES AND THEIR PARTS; PLASTIC SHEETS, NAMELY EXTRUDED PLASTIC IN THE FORM OF SHEETS FOR USE IN MANUFACTURING; PLASTIC IN SHEETS FOR GENERAL INDUSTRIAL USE; PLASTIC IN THE FORM OF SHEETS FOR USE IN MANUFACTURING AUTOMOBILES AND ITS PARTS (U.S. CLS. 1, 5, 12, 13, 35 AND 50).

FIRST USE 8-1-1981; IN COMMERCE 8-1-1991.

SN 76-105,153. HERMAN, ROBERT S., DBA ENVIRO SHIELD PRODUCTS, YUMA, AZ. FILED 8-9-2000.

ENVIRO SHIELD PRODUCTS

NO CLAIM IS MADE TO THE EXCLUSIVE RIGHT TO USE "PRODUCTS", APART FROM THE MARK AS SHOWN.

FOR PORTABLE OIL ABSORBENT CONTAINMENT BERMS FOR CONTAINING OIL SPILLS; AND OIL ABSORBENT PADS AND PILLOWS ATTACHED UNDER VEHICLES FOR CONTAINING OIL SPILLS (U.S. CLS. 1, 5, 12, 13, 35 AND 50).

FIRST USE 4-0-1995; IN COMMERCE 4-0-1995.

CLASS 17—(Continued).

SN 76-108,348. ROBBINS SCIENTIFIC CORPORATION, SUNNYVALE, CA. FILED 8-14-2000.

CHEMTUF

FOR NON-METAL SEALING GASKETS FOR LABORATORY SYNTHESIS (U.S. CLS. 1, 5, 12, 13, 35 AND 50).

FIRST USE 10-19-1998; IN COMMERCE 10-19-1998.

SN 76-212,618. GLIDDEN COMPANY, THE, CLEVELAND, OH. FILED 2-20-2001.

WIND JAMMER

FOR SEALANTS FOR ELASTOMERIC WEATHER STRIPPING AND OTHERWISE SEALING DOORS, WINDOWS, AND OTHER OPENINGS OR VOIDS IN RESIDENTIAL AND COMMERCIAL BUILDINGS (U.S. CLS. 1, 5, 12, 13, 35 AND 50).

FIRST USE 1-31-2001; IN COMMERCE 1-31-2001.

SN 76-261,919. ASSOCIATED MATERIALS, INCORPORATED, DBA ALSIDE, AKRON, OH. FILED 5-25-2001.

CLIMASHIELD

FOR FOAM INSULATION FOR SIDING (U.S. CLS. 1, 5, 12, 13, 35 AND 50).

SN 78-022,759. W. L. GORE & ASSOCIATES, INC., NEWARK, DE. FILED 8-24-2000.

CELERUS

FOR PLASTIC IN THE FORM OF SHEETS FOR USE AS NON-METAL GASKETS (U.S. CLS. 1, 5, 12, 13, 35 AND 50).

SN 78-048,570. A.G.S. AUSTRALIAN GLOBAL SERVICES, INC., PERRYVILLE, OH. FILED 2-15-2001.

AVS96

SEC. 2(F).
FOR PLUMBING SUPPLIES, NAMELY, NON-METAL HOSES FOR MARINE AND RECREATIONAL VEHICLE SEWAGE HANDLING UNITS (U.S. CLS. 1, 5, 12, 13, 35 AND 50).

FIRST USE 0-0-1995; IN COMMERCE 0-0-1995.

CLASS 17—(Continued).

SN 78-055,439. PLASTICS R UNIQUE, WADSWORTH, OH. FILED 3-28-2001.



NO CLAIM IS MADE TO THE EXCLUSIVE RIGHT TO USE "PAD", APART FROM THE MARK AS SHOWN.

FOR EQUIPMENT BASE PADS USED FOR SOUND AND VIBRATION ABSORPTION FOR PLACEMENT UNDER SWIMMING POOL PUMPS AND FILTERS, WHIRLPOOL BATHS OR SPAS, AIR CONDITIONERS, CONDENSING UNITS AND WATER HEATERS (U.S. CLS. 1, 5, 12, 13, 35 AND 50).

FIRST USE 6-0-1997; IN COMMERCE 6-0-1997.

SN 78-059,347. GENERAL ELECTRIC COMPANY, SCHENECTADY, NY. FILED 4-19-2001.

HOME SOLUTIONS

NO CLAIM IS MADE TO THE EXCLUSIVE RIGHT TO USE "HOME", APART FROM THE MARK AS SHOWN.

FOR ADHESIVE SEALANTS FOR GENERAL USE; CAULKING AND CAULKING COMPOUND; GENERAL PURPOSE SILICONE RUBBER SEALANT; SEALANTS FOR BUILDINGS; RUBBER SEALANT FOR CAULKING AND ADHESIVE PURPOSES; GENERAL ADHESIVE FOR USE ON TILE, NAMELY, GROUT SUBSTITUTE (U.S. CLS. 1, 5, 12, 13, 35 AND 50).

CLASS 18—LEATHER GOODS

SN 75-911,478. TRAVELPRO INTERNATIONAL, INC., BOCA RATON, FL. FILED 2-3-2000.

PILOT DESIGNED, FLIGHT CREW TESTED

OWNER OF U.S. REG. NO. 1,927,128.
FOR LUGGAGE (U.S. CLS. 1, 2, 3, 22 AND 41).
FIRST USE 0-0-1997; IN COMMERCE 0-0-1997.

SN 76-029,163. MARMOT MOUNTAIN LTD., SANTA ROSA, CA. FILED 4-19-2000.

MARMOT BIOSPAN

OWNER OF U.S. REG. NOS. 1,461,945 AND 1,462,942.
FOR BACKPACKS (U.S. CLS. 1, 2, 3, 22 AND 41).
FIRST USE 1-0-1998; IN COMMERCE 1-0-1998.

CLASS 18—(Continued).

SN 76-053,095. BURTON CORPORATION, THE, BURLINGTON, VT. FILED 5-22-2000.

BURTON ARCTIC

OWNER OF U.S. REG. NOS. 1,715,746, 2,206,266 AND OTHERS.

FOR ALL PURPOSE SPORTS BAGS, DUFFEL BAGS, CARRY BAGS, TRAVEL BAGS, TRAVEL CASES, DAY-PACKS, BACKPACKS, FANNY PACKS, TEAM BAGS FOR CARRYING GENERAL ITEMS, RUCKSACKS, LEASHES, CHEST POUCHES, LAUNDRY BAGS (U.S. CLS. 1, 2, 3, 22 AND 41).

SN 76-173,772. ROCKY MOUNTAIN PET PRODUCTS, INC., LOGAN, UT. FILED 11-30-2000.

ROCKY MOUNTAIN

FOR PET ACCESSORIES, NAMELY, DOG LEASHES, DOG COLLARS, DOG APPAREL, DOG CLOTHING, PET LEASHES, PET COLLARS, PET APPAREL, PET CLOTHING, PET CUSHIONS, PET BEDS (U.S. CLS. 1, 2, 3, 22 AND 41).

SN 76-317,017. MICHELIN NORTH AMERICA, INC., GREENVILLE, SC. FILED 9-25-2001.

MICHELIN

OWNER OF U.S. REG. NO. 1,399,361.

FOR TRAVELLING BAGS AND CASES, TRUNKS, BRIEFCASES, LUGGAGE, HANDBAGS, PURSES, RUCKSACKS, WALLETS, BAGS FOR THE TRANSPORT OF MATERIALS IN BULK, BAGS FOR CAMPERS, BAGS FOR THE BEACH, BAGS FOR CLIMBERS, BAGS FOR PACKING CLOTHES, VISIT CARD HOLDERS, CREDIT CARD HOLDERS (U.S. CLS. 1, 2, 3, 22 AND 41).

SN 78-022,262. GENERAL MOTORS CORPORATION, DETROIT, MI. FILED 8-22-2000.

PONTIAC

OWNER OF U.S. REG. NOS. 1,708,037, 1,775,048 AND OTHERS.

FOR WAIST PACKS, DUFFEL BAGS, UMBRELLAS, TOTE BAGS, LUGGAGE, WALLETS, BACKPACKS, CARD CASES, NAMELY, BUSINESS CARD CASES, CALLING CARD CASES AND CREDIT CARD CASES (U.S. CLS. 1, 2, 3, 22 AND 41).

FIRST USE 9-30-1979; IN COMMERCE 9-30-1979.

CLASS 18—(Continued).

SN 78-030,209. BANANA BONE, INC., DBA DIVABAGZ, CHARLOTTE, NC. FILED 10-11-2000.

DIVABAGZ

FOR HANDBEADED AND EMBROIDERED HANDBAGS/PURSES (U.S. CLS. 1, 2, 3, 22 AND 41).
FIRST USE 4-16-2000; IN COMMERCE 4-16-2000.

SN 78-044,431. SYMBIOSIS, INC, KAYSVILLE, UT. FILED 1-23-2001.

LEASHABLES

FOR HOLDERS FOR LIP BALM AND CIGARETTE LIGHTERS (U.S. CLS. 1, 2, 3, 22 AND 41).

SN 78-060,315. DIRECT SOURCE INNOVATIONS, LLC, GLEN ALLEN, VA. FILED 4-25-2001.

JIFFY CART

NO CLAIM IS MADE TO THE EXCLUSIVE RIGHT TO USE "CART", APART FROM THE MARK AS SHOWN.
FOR NON-MOTORIZED COLLAPSIBLE TROLLEY ON WHEELS, USED TO TRANSPORT LUGGAGE AND OTHER HEAVY ARTICLES OR LOADS (U.S. CLS. 1, 2, 3, 22 AND 41).

SN 78-064,645. SAMSONITE CORPORATION, DENVER, CO. FILED 5-21-2001.

SENEKA

FOR LUGGAGE (U.S. CLS. 1, 2, 3, 22 AND 41).

SN 78-078,474. BABIARZ DAVID, TUCSON, AZ. FILED 8-9-2001.

SNAKE PIT

FOR LUGGAGE, SUITCASES, GARMENT BAGS, TRAVEL BAGS, TOTE BAGS, BACKPACKS, FANYPACKS, SHOULDER PACKS, SOFT SIDED LUGGAGE, UMBRELLAS (U.S. CLS. 1, 2, 3, 22 AND 41).
FIRST USE 4-14-2001; IN COMMERCE 4-14-2001.

CLASS 19—NON-METALLIC BUILDING MATERIALS

CLASS 19—(Continued).

SN 75-536,568. CABINET MOUNTAIN LOG WORKS, L.L.C., THOMPSON FALLS, MT. FILED 8-12-1998.

AIR-LOCK

OWNER OF U.S. REG. NO. 1,091,440.
FOR BUILDING CONSTRUCTION LOGS AND PRE-CUT LOG HOMES (U.S. CLS. 1, 12, 33 AND 50).
FIRST USE 12-31-1946; IN COMMERCE 12-31-1946.

SN 75-856,820. ASFALTOS CHOVA S.A., 46760 VALENCIA, SPAIN, FILED 11-23-1999.

CHOVA S.A.

PRIORITY CLAIMED UNDER SEC. 44(D) ON SPAIN APPLICATION NO. 2266026, FILED 10-25-1999, REG. NO. 2266026, DATED 3-6-2000, EXPIRES 10-25-2009.

NO CLAIM IS MADE TO THE EXCLUSIVE RIGHT TO USE "S.A.", APART FROM THE MARK AS SHOWN.

FOR ASPHALT, PITCH AND, AND NON-METALLIC TRANSPORTABLE BUILDINGS (U.S. CLS. 1, 12, 33 AND 50).

SN 75-928,217. INTERNATIONAL AMERICAN CERAMICS, INC., TULSA, OK. FILED 2-25-2000.

PRESERVATIONS

FOR CERAMIC TILE (U.S. CLS. 1, 12, 33 AND 50).

SN 76-051,587. L.B. PLASTICS LIMITED, BELPER, DERBY, ENGLAND, FILED 5-18-2000.

SHEERFLOW

OWNER OF U.S. REG. NOS. 1,075,542 AND 1,315,746.
FOR NON-METAL BUILDING MATERIALS, NAMELY, GUARDS FOR RAIN GUTTERS (U.S. CLS. 1, 12, 33 AND 50).

SN 76-056,607. ANCHOR BLOCK OF FLORIDA, INC., MINNETONKA, MN. BY ASSIGNMENT TARMAC AMERICA, INC., NORFOLK, VA. FILED 5-25-2000.

DEMACO BLOCK

NO CLAIM IS MADE TO THE EXCLUSIVE RIGHT TO USE "BLOCK", APART FROM THE MARK AS SHOWN.

FOR CONCRETE BUILDING MATERIALS, NAMELY, BLOCKS (U.S. CLS. 1, 12, 33 AND 50).

FIRST USE 5-1-1998; IN COMMERCE 5-1-1998.

CLASS 19—(Continued).

SN 76-063,372. G-P GYPSUM CORPORATION, ATLANTA, GA. FILED 6-5-2000.

R P

FOR CEMENT, NAMELY, GRAY, FAST-SETTING CEMENTITIOUS PATCHING PRODUCT FOR PATCHING/REPAIRING ROADS, SIDEWALKS AND CONCRETE SURFACES IN INDUSTRIAL SETTINGS (U.S. CLS. 1, 12, 33 AND 50).

SN 76-070,584. S & S INTERSOURCE, LLC, WARRENDALE, PA. FILED 6-15-2000.

NISIC

FOR REFRACTORY BRICKS (U.S. CLS. 1, 12, 33 AND 50).

SN 76-094,406. CERAMICHE ARTISTICHE LEA S.P.A., 41042 FIORANO MODENESE (MO), ITALY, FILED 7-24-2000.

METEOR

FOR CERAMIC TILES AND CERAMIC MATERIALS FOR FLOORINGS AND COVERINGS, NAMELY, STONWARE (U.S. CLS. 1, 12, 33 AND 50).
FIRST USE 3-0-2000; IN COMMERCE 3-0-2000.

SN 76-114,391. ALEXANDER JULIAN, INC., RIDGEFIELD, CT. FILED 8-22-2000.



THE LINING IN THE DRAWING IS NOT A FEATURE OF THE MARK AND IS MEANT TO INDICATE THE COLORS BLUE, RED AND GREEN.

THE NAME "ALEXANDER JULIAN" IDENTIFIES A LIVING INDIVIDUAL WHOSE CONSENT IS OF RECORD.
FOR CERAMIC TILES; WOODEN FLOOR TILES; NON-METAL LAMINATED FLOOR TILES, NON-METAL DOORS AND WOOD DOOR MOLDINGS (U.S. CLS. 1, 12, 33 AND 50).

CLASS 19—(Continued).

SN 76-159,253. LAUGHLIN PRODUCTS, INC., GRAPEVINE, TX. FILED 11-3-2000.

DR. LAUGHLIN'S

THE NAME "DR. LAUGHLIN" IDENTIFIES A LIVING INDIVIDUAL WHOSE CONSENT IS OF RECORD.
 FOR SUNLESS TANNING EQUIPMENT, NAMELY, TANNING ENCLOSURES AND BOOTHS FOR SPRAYING SUNLESS TANNING PREPARATIONS (U.S. CLS. 1, 12, 33 AND 50).
 FIRST USE 3-1-1997; IN COMMERCE 3-1-1997.

SN 76-178,045. THAI CERAMIC CO., LTD., THE, BANGSUE BANGKOK, THAILAND, FILED 12-8-2000.

MONET

FOR CERAMIC TILES (U.S. CLS. 1, 12, 33 AND 50).

SN 76-229,011. YODOCK WALL COMPANY, INC., THE, FORT LAUDERDALE, FL. FILED 3-22-2001.

YODOCK

SEC. 2(F).
 FOR HOLLOW PLASTIC CRASH BARRIERS THAT CAN BE FILLED WITH A BALLAST MATERIAL AND USED TO CONTROL VEHICLE AND PEDESTRIAN TRAFFIC (U.S. CLS. 1, 12, 33 AND 50).
 FIRST USE 6-0-1996; IN COMMERCE 6-0-1996.

SN 76-243,415. WOODGRAIN MILLWORK, INC., FRUITLAND, IN. FILED 4-18-2001.

WIN/WIN ... ANY WAY YOU LOOK AT IT.

FOR NON-METAL WINDOWS, NON-METAL DOORS, AND STRUCTURAL AND REPLACEMENT PARTS THEREFOR (U.S. CLS. 1, 12, 33 AND 50).

SN 76-261,918. ASSOCIATED MATERIALS, INCORPORATED, DBA ALSIDE, AKRON, OH. FILED 5-25-2001.

ULTRABEAM

FOR VINYL SIDING (U.S. CLS. 1, 12, 33 AND 50).

CLASS 19—(Continued).

SN 76-280,522. GERBI REVESTIMENTOS CERAMICOS LTDA., SAO PAULO, BRAZIL, FILED 7-5-2001.

GERBI

FOR BUILDING MATERIALS, NAMELY, CERAMIC TILES FOR WALLS, ROOFS, AND FLOORS, EARTHWARE TUBES AND TUBE CONNECTIONS, BRICKS AND EXPANDED CLAY (U.S. CLS. 1, 12, 33 AND 50).
 FIRST USE 9-25-1978; IN COMMERCE 8-0-1982.

SN 76-282,059. CEDAR SHAKE & SHINGLE BUREAU, SUMAS, WA. FILED 7-9-2001.

CERTI-RIDGE

FOR WOOD SHINGLES AND SHAKES (U.S. CLS. 1, 12, 33 AND 50).
 FIRST USE 4-0-1992; IN COMMERCE 4-0-1992.

SN 76-284,927. ORIGINAL STYLE LIMITED, EXETER, DEVON, EX4 4HJ, UNITED KINGDOM, FILED 7-13-2001.



OWNER OF UNITED KINGDOM REG. NO. 2201557, DATED 2-16-2001, EXPIRES 6-30-2009.
 NO CLAIM IS MADE TO THE EXCLUSIVE RIGHT TO USE "TILE COMPANY", APART FROM THE MARK AS SHOWN.
 FOR HAND MADE AND HAND PAINTED NON-METAL TILES (U.S. CLS. 1, 12, 33 AND 50).

SN 76-288,208. A. C. HESSE CONTRACTORS, LLC, TOMS RIVER, NJ. FILED 7-23-2001.

AUTUMN'S PETRIFIED FOREST BLEND

NO CLAIM IS MADE TO THE EXCLUSIVE RIGHT TO USE "BLEND", APART FROM THE MARK AS SHOWN.
 FOR LANDSCAPING SUPPLIES, NAMELY, CRUSHED STONE (U.S. CLS. 1, 12, 33 AND 50).
 FIRST USE 4-1-1999; IN COMMERCE 4-1-1999.

CLASS 19—(Continued).

SN 76-291,589. ROYAL GROUP TECHNOLOGIES LIMITED, VAUGHAN, ONTARIO, CANADA, FILED 7-30-2001.

ROYAL ECO

FOR STORAGE AND TOOL SHEDS, BASEMENT WINDOWS, DOOR FRAMES, GARAGE DOOR FRAMES, ROOF TILES AND FENCES, ALL MADE OF PLASTIC (U.S. CLS. 1, 12, 33 AND 50).

FIRST USE 12-0-2000; IN COMMERCE 12-0-2000.

SN 76-310,963. U.S. PLASTIC IP CORPORATION, BOCA RATON, FL. FILED 9-11-2001.

CAREFREE XTERIORS

FOR BUILDING MATERIAL MADE FROM PLASTIC USED TO CONSTRUCT A DECK CONSISTING OF DECKBOARDS, STAIRTREADS, RAILS WITH SPINDLES, POSTS AND POST CAPS (U.S. CLS. 1, 12, 33 AND 50).

FIRST USE 8-1-2001; IN COMMERCE 8-1-2001.

SN 76-313,458. HALLIBURTON ENERGY SERVICES, INC., CARROLLTON, TX. FILED 9-18-2001.

TUNED

FOR CEMENTING SYSTEMS, NAMELY, SPACERS AND CEMENT SLURRIES USED FOR CEMENTING OPERATIONS IN THE OIL AND GAS INDUSTRY (U.S. CLS. 1, 12, 33 AND 50).

SN 76-318,691. CEDAR SHAKE & SHINGLE BUREAU, SUMAS, WA. FILED 9-27-2001.

CERTI-CUT

FOR WOOD SHINGLES AND SHAKES (U.S. CLS. 1, 12, 33 AND 50).

CLASS 19—(Continued).

SN 78-012,738. GRESITEC, S.A., ONDA-CASTELLON, SPAIN, FILED 6-14-2000.

**GRESITEC**

THE MARK CONSISTS OF THE STYLIZED WORDING GRESITEC WITH A GEOMETRIC DESIGN TO THE RIGHT OF THE WORDS CONSISTING OF A SQUARE SUPERIMPOSED ON A DIAMOND WITH THE LETTER "G" IN THE MIDDLE OF THE DESIGN, TILTED AT AN ANGLE.

FOR NON METALLIC BUILDING MATERIALS NAMELY ALABASTER, BOARD MATERIAL MADE OF POLYETHYLENE USED AS A WOOD SUBSTITUTE, BRICKS, CERAMIC ENAMEL TILES, NON METAL FLOOR TILES, PAVEMENT TILES, NON METALLIC TUBING OR NON FLEXIBLE PIPING FOR BUILDING, ASPHALT, TAR-BASED ASPHALT SEALANTS AND BITUMEN ASPHALT; NON METALLIC TRANSPORTABLE BUILDINGS; NON METALLIC MONUMENTS; SPECIALTY CERAMIC TILES AND SANDSTONE TILES (U.S. CLS. 1, 12, 33 AND 50).

FIRST USE 11-28-1995; IN COMMERCE 9-1-1996.

SN 78-074,503. MARCO WOOD PRODUCTS, INC., WARREN, MI. FILED 7-18-2001.

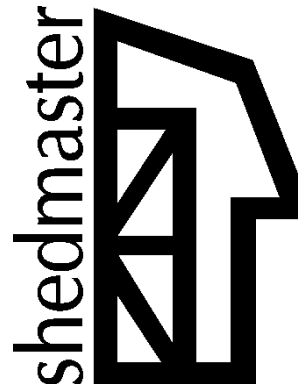

FOR NON-METAL STORAGE SHEDS AND BUILDINGS (U.S. CLS. 1, 12, 33 AND 50).

FIRST USE 1-31-2000; IN COMMERCE 1-31-2000.

SN 78-084,698. MOHAWK BRANDS, INC., WILMINGTON, DE. FILED 9-20-2001.

**NORTHERN FOREST
COLLECTION**

NO CLAIM IS MADE TO THE EXCLUSIVE RIGHT TO USE "COLLECTION", APART FROM THE MARK AS SHOWN.

FOR HARDWOOD FLOORING (U.S. CLS. 1, 12, 33 AND 50).

CLASS 20—FURNITURE AND ARTICLES NOT OTHERWISE CLASSIFIED

SN 75-842,567. CASTELLI S.P.A., BO, ITALY, FILED 11-4-1999.



OWNER OF ITALY REG. NO. 00787772, DATED 5-5-1999, EXPIRES 5-5-2009.

FOR CHAIRS, ARMCHAIRS, OFFICE CHAIRS, OFFICE ARMCHAIRS; SOFAS, METAL CHAIRS, UPHOLSTERED CHAIRS, FOLDING CHAIRS, ROWS OF FOLDING SEATS; FURNITURE, NAMELY TABLES AND SMALL TABLES; OFFICE FURNITURE AND MODULAR FURNITURE, NAMELY TABLES, SMALL TABLES, TABLES FOR MEETINGS, CONGRESSES AND CONFERENCES; SMALL TABLES; DESKS; OFFICE FITTINGS; STANDS FOR TELEPHONES; WARDROBE LOCKERS; FILING CABINETS; OFFICE FURNITURE AND UPHOLSTERED OFFICE FURNITURE, NAMELY MOVABLE OFFICE PARTITIONS, DIVIDING MOVABLE WALLS FOR OFFICE USE, WALLS COMPLETE WITH FIXTURES SOLD AS A UNIT; CLOTHES HANGERS; UMBRELLA STANDS (U.S. CLS. 2, 13, 22, 25, 32 AND 50).

SN 76-047,967. MCALLISTER INDUSTRIES, SOLANA BEACH, CA. FILED 5-15-2000.

BAG GRABBER

NO CLAIM IS MADE TO THE EXCLUSIVE RIGHT TO USE "BAG", APART FROM THE MARK AS SHOWN.
FOR NON METAL CLAMPS (U.S. CLS. 2, 13, 22, 25, 32 AND 50).

SN 76-072,591. WIN-PLUS TRADING INC., SANTA FE SPRINGS, CA. FILED 6-19-2000.

CHAIR MASTER

NO CLAIM IS MADE TO THE EXCLUSIVE RIGHT TO USE "CHAIR", APART FROM THE MARK AS SHOWN.
FOR CHAIRS (U.S. CLS. 2, 13, 22, 25, 32 AND 50).
FIRST USE 3-0-2000; IN COMMERCE 5-0-2000.

CLASS 20—(Continued).

SN 76-075,651. SOUTHWEST SPECIALTY PRODUCTS, LLC, PHOENIX, AZ. FILED 6-23-2000.



NO CLAIM IS MADE TO THE EXCLUSIVE RIGHT TO USE "SAFE", APART FROM THE MARK AS SHOWN.
FOR PERSONAL NON-METAL SAFES (U.S. CLS. 2, 13, 22, 25, 32 AND 50).
FIRST USE 2-3-1998; IN COMMERCE 2-3-1998.

SN 76-083,888. AMERICAN WOODMARK CORPORATION, WINCHESTER, VA. FILED 7-6-2000.

WINTER

FOR KITCHEN CABINETS AND BATHROOM VANITIES (U.S. CLS. 2, 13, 22, 25, 32 AND 50).

SN 76-107,317. W.J. COWEE, INC., BERLIN, NY. FILED 8-11-2000.



OWNER OF U.S. REG. NO. 2,419,080.
THE LINING SHOWN IN THE DRAWING IS A FEATURE OF THE MARK AND IS NOT INTENDED TO INDICATE COLOR.

FOR WOODEN PLANT STAKES AND PICKS FOR USE WITH FRESH, SILK OR DRIED FLOWER FLORAL ARRANGEMENTS TO POSITION AND SECURE ITEMS IN THE FLORAL ARRANGEMENTS (U.S. CLS. 2, 13, 22, 25, 32 AND 50).
FIRST USE 9-0-1995; IN COMMERCE 9-0-1995.

SN 76-118,147. DREXEL HERITAGE FURNISHINGS INC., DREXEL, NC. FILED 8-28-2000.

SIGNATURES BY HERITAGE

OWNER OF U.S. REG. NOS. 1,284,363, 1,690,208 AND OTHERS.
FOR FURNITURE (U.S. CLS. 2, 13, 22, 25, 32 AND 50).
FIRST USE 4-0-1991; IN COMMERCE 9-0-1991.

CLASS 20—(Continued).

SN 76-146,247. DENVER MATTRESS CO., LLC, LAKEWOOD, CO. FILED 10-12-2000.

SPINALBRIDGE

FOR MATTRESSES (U.S. CLS. 2, 13, 22, 25, 32 AND 50).

SN 76-166,397. DISPLAY TECHNOLOGIES, LLC, COLLEGE POINT, NY. FILED 11-16-2000.

VISI-FLOOR

OWNER OF U.S. REG. NO. 2,177,340.
FOR MODULAR STORAGE RACKS FOR SLIDABLE PRODUCTS; DISPLAY RACKS FOR SLIDABLE PRODUCTS (U.S. CLS. 2, 13, 22, 25, 32 AND 50).

SN 76-195,915. TOPSTAR-MOBEL GMBH, LANGENNEUF-NACH, FED REP GERMANY, FILED 1-18-2001.



OWNER OF FED REP GERMANY REG. NO. 2900279, DATED 1-19-1995, EXPIRES 1-14-2003.
FOR FURNITURE, IN PARTICULAR OFFICE FURNITURE AND OFFICE CHAIRS; UPHOLSTERED FURNITURE; SWIVEL ARM CHAIRS; WORKING CHAIRS (U.S. CLS. 2, 13, 22, 25, 32 AND 50).

SN 76-201,771. KAEMARK, INC., GIDDINGS, TX. FILED 1-30-2001.



NO CLAIM IS MADE TO THE EXCLUSIVE RIGHT TO USE "SALON FURNISHINGS", APART FROM THE MARK AS SHOWN.
FOR BEAUTY SALON FURNITURE (U.S. CLS. 2, 13, 22, 25, 32 AND 50).

CLASS 20—(Continued).

SN 76-225,511. HELTZER INCORPORATED, CHICAGO, IL. FILED 3-16-2001.



FOR FURNITURE (U.S. CLS. 2, 13, 22, 25, 32 AND 50).
FIRST USE 1-0-1993; IN COMMERCE 1-0-1993.

SN 76-244,939. HOMEDICS, INC., COMMERCE TOWNSHIP, MI. FILED 4-23-2001.

HOMEDICS

OWNER OF U.S. REG. NO. 1,695,935.
FOR BACK CUSHIONS, CUSHIONS WITH MASSAGING FEATURE, BACK SUPPORT CUSHIONS AND RECLINING CHAIRS (U.S. CLS. 2, 13, 22, 25, 32 AND 50).
FIRST USE 4-15-1988; IN COMMERCE 4-15-1988.

SN 76-249,124. SMITHERS-OASIS COMPANY, CUYAHOGA FALLS, OH. FILED 5-2-2001.

SHAPE-A-SCAPES

FOR FLORAL AND CRAFT SUPPORTS, NAMELY, MOLDED URETHANE WREATHS, TOPIARIES, CONES, AND BALLS FOR USE IN THE FLORAL AND CRAFT INDUSTRIES (U.S. CLS. 2, 13, 22, 25, 32 AND 50).

SN 76-282,821. BERNE FURNITURE COMPANY, INC., BERNE, IN. FILED 7-10-2001.

PLATINUM COLLECTION

NO CLAIM IS MADE TO THE EXCLUSIVE RIGHT TO USE "COLLECTION", APART FROM THE MARK AS SHOWN.
FOR FURNITURE, NAMELY TABLES, CABINETS, CHESTS, CREDENZAS, DESKS, HUTCHES AND BEDROOM FURNITURE (U.S. CLS. 2, 13, 22, 25, 32 AND 50).

SN 76-290,710. Z-LINE DESIGNS, SAN RAMON, CA. FILED 7-26-2001.

Z-LINE DESIGNS

NO CLAIM IS MADE TO THE EXCLUSIVE RIGHT TO USE "DESIGNS", APART FROM THE MARK AS SHOWN.
FOR FURNITURE (U.S. CLS. 2, 13, 22, 25, 32 AND 50).
FIRST USE 10-0-1996; IN COMMERCE 10-0-1996.

CLASS 20—(Continued).

SN 76-295,117. WOODHARBOR MOLDING & MILLWORKS, INC., MASON CITY, IA. FILED 8-3-2001.

ROCKGLEN

FOR WOOD CABINETRY (U.S. CLS. 2, 13, 22, 25, 32 AND 50).

SN 76-308,719. EXECUTIVE OFFICE CONCEPTS, COMP-
TON, CA. FILED 9-4-2001.

INNERLINK

FOR OFFICE FURNITURE, NAMELY CHAIRS, TA-
BLES AND BOOKCASES (U.S. CLS. 2, 13, 22, 25, 32 AND
50).

FIRST USE 7-7-2000; IN COMMERCE 7-7-2000.

SN 76-310,106. NEEDLE KING GROUP INC., ANAHEIM, CA.
FILED 9-7-2001.

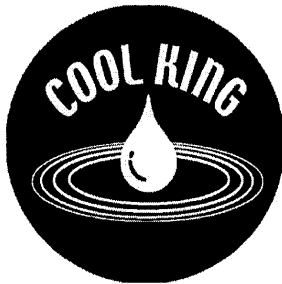

FOR SEAT CUSHIONS AND SUPPORT PILLOWS (U.S.
CLS. 2, 13, 22, 25, 32 AND 50).

FIRST USE 9-4-2001; IN COMMERCE 9-4-2001.

SLEEPING PRETTY

FOR PILLOWS (U.S. CLS. 2, 13, 22, 25, 32 AND 50).

CLASS 20—(Continued).

SN 78-071,189. A&E PRODUCTS GROUP LP, SECAUCUS, NJ.
FILED 6-27-2001.

DROP CLIP

NO CLAIM IS MADE TO THE EXCLUSIVE RIGHT TO
USE "CLIP", APART FROM THE MARK AS SHOWN.
FOR GARMENT HANGER (U.S. CLS. 2, 13, 22, 25, 32
AND 50).

FIRST USE 4-3-2001; IN COMMERCE 4-3-2001.

SN 78-079,156. TARGET BRANDS, INC., MINNEAPOLIS,
MN. FILED 8-14-2001.

KD BASICS

FOR BOOKCASES, DESKS, TV CARTS, ENTERTAIN-
MENT STANDS, UTILITY CARTS, SHELF UNITS (U.S.
CLS. 2, 13, 22, 25, 32 AND 50).

SN 78-083,645. CLOPAY BUILDING PRODUCTS R&D COM-
PANY, INC., DBA CLOPAY BUILDING PRODUCTS
COMPANY, INC., CINCINNATI, OH. FILED 9-12-2001.

SAFE-T-HINGE

FOR NON-METAL GARAGE DOOR HARDWARE,
NAMELY PLASTIC GUARD TO PROTECT FINGERS
FROM BEING PINCHED (U.S. CLS. 2, 13, 22, 25, 32
AND 50).

CLASS 21—HOUSEWARES AND GLASS

SN 75-626,389. MELARD MANUFACTURING CORP., PAS-
SAIC, NJ. FILED 1-25-1999.

GREENWICH

FOR BATHROOM ACCESSORIES, NAMELY, TOWEL
BARS, TOWEL RINGS, TISSUE HOLDERS AND TOOTH-
BRUSH TUBMLER HOLDERS (U.S. CLS. 2, 13, 23, 29, 30,
33, 40 AND 50).

SN 76-027,966. GRAND CRYSTAL CO., LTD, PEI-TOU
TAIPEI, CHINA, FILED 4-18-2000.

TITTOT

FOR GLASS FOR HOUSEHOLD USE AND HOUSE-
HOLD DECORATION, NAMELY, GLASS SCULPTURES;
COLORED GLASS BASES, BOWLS AND STATUES;
GLASSWARE, NAMELY DRINKING VESSELS, BOWLS,
SAUCERS, DISHES, CUPS, TEAPOTS, BASINS, JARS,
BOTTLES SOLD EMPTY AND CANDLESTICKS, UN-
WROUGHT GLASS AND GLASS ORNAMENTS NOT
INCLUDING CHRISTMAS TREE ORNAMENTS (U.S.
CLS. 2, 13, 23, 29, 30, 33, 40 AND 50).

CLASS 21—(Continued).

SN 76-073,823. QUATTROCHI, PAMELA ANN, SAN FRANCISCO, CA. FILED 6-19-2000.

GLASS ALCHEMY

NO CLAIM IS MADE TO THE EXCLUSIVE RIGHT TO USE "GLASS", APART FROM THE MARK AS SHOWN.
FOR GLASS SCULPTURES, GLASS BOWLS, GLASS FIGURINES (U.S. CLS. 2, 13, 23, 29, 30, 33, 40 AND 50).
FIRST USE 9-25-1998; IN COMMERCE 5-15-1999.

SN 76-077,406. PRODUCTS UNLIMITED, INC., OMAHA, NE. FILED 6-26-2000.



FOR HOUSEHOLD UTENSILS; CONTAINERS FOR HOUSEHOLD AND KITCHEN USE, NOT OF PRECIOUS METAL; FRYING PANS AND COOKING POTS (U.S. CLS. 2, 13, 23, 29, 30, 33, 40 AND 50).

SN 76-083,886. TIME WARNER ENTERTAINMENT COMPANY, L.P., NEW YORK, NY. FILED 7-6-2000.

GOLDEN SNITCH

FOR GLASS, CERAMIC AND EARTHENWARE GOODS, NAMELY, COFFEE MUGS, MUGS, JUGS, BOWLS, PLATES, COFFEE CUPS, AND CUPS; BEVERAGE GLASSWARE, NAMELY, JUGS, MUGS AND DRINKING GLASSES; DEMITASSE SETS CONSISTING OF CUPS AND SAUCERS; SUGAR AND CREAMER SETS; INFANT CUPS; COOKIE JARS; CERAMIC, GLASS AND CHINA FIGURINES; NON-ELECTRIC COFFEE POTS; WASTEPAPER BASKETS; ICE BUCKETS; PLASTIC BUCKETS; SHOWER CADDIES; TEA CADDIES; CAKE MOLDS; SERVING UTENSILS, NAMELY, PIE SERVERS, CAKE TURNERS, SPATULAS, SCRAPERS, AND CAKE SERVERS; CANTEENS; CHAMPAGNE BUCKETS; PLASTIC COASTERS; COCKTAIL SHAKERS; THERMAL INSULATED CONTAINERS FOR FOOD OR BEVERAGES; COOKIE CUTTERS; CORK SCREWS; CORN COB HOLDERS; WATER BOTTLES; VACUUM BOTTLES; DECANTERS; DRINKING FLASKS; GARDENING GLOVES; RUBBER HOUSEHOLD GLOVES; AND DINNERWARE, NAMELY, PAPER PLATES AND PAPER CUPS (U.S. CLS. 2, 13, 23, 29, 30, 33, 40 AND 50).

CLASS 21—(Continued).

SN 76-092,205. ZENITH PRODUCTS CORPORATION, NEW CASTLE, DE. FILED 7-20-2000.



NO CLAIM IS MADE TO THE EXCLUSIVE RIGHT TO USE "NEW DESIGN! JUST THE RIGHT AMOUNT WITH ONE PUMP", APART FROM THE MARK AS SHOWN.
FOR BATHROOM ACCESSORIES, NAMELY, DISPENSERS FOR LIQUID SOAP, SHAMPOO AND THE LIKE (U.S. CLS. 2, 13, 23, 29, 30, 33, 40 AND 50).

SN 76-104,862. MELARD MANUFACTURING CORP., PASAIC, NJ. FILED 8-7-2000.

BELMONT

FOR BATHROOM ACCESSORIES, NAMELY, TOWEL BARS, TOWEL RINGS, SOAP DISHES, AND TOOTHBRUSH-TUMBLER HOLDERS (U.S. CLS. 2, 13, 23, 29, 30, 33, 40 AND 50).

SN 76-104,863. MELARD MANUFACTURING CORP., PASAIC, NJ. FILED 8-7-2000.

DELFT

FOR BATHROOM ACCESSORIES, NAMELY, TOWEL BARS, TOWEL RINGS, SOAP DISHES, AND TOOTHBRUSH-TUMBLER HOLDERS (U.S. CLS. 2, 13, 23, 29, 30, 33, 40 AND 50).

SN 76-104,864. MELARD MANUFACTURING CORP., PASAIC, NJ. FILED 8-7-2000.

SAMARA

FOR BATHROOM ACCESSORIES, NAMELY, TOWEL BARS, TOWEL RINGS, SOAP DISHES, AND TOOTHBRUSH-TUMBLER HOLDERS (U.S. CLS. 2, 13, 23, 29, 30, 33, 40 AND 50).

CLASS 21—(Continued).

SN 76-104,873. MELARD MANUFACTURING CORP., PAS-SAIC, NJ. FILED 8-7-2000.

TRISTAN

FOR BATHROOM ACCESSORIES, NAMELY, TOWEL BARS, TOWEL RINGS, SOAP DISHES, AND TOOTH-BRUSH-TUMBLER HOLDERS (U.S. CLS. 2, 13, 23, 29, 30, 33, 40 AND 50).

SN 76-119,632. RAT MAN INC., SEATTLE, WA. FILED 8-31-2000.

RAT INN

NO CLAIM IS MADE TO THE EXCLUSIVE RIGHT TO USE "RAT", APART FROM THE MARK AS SHOWN.
FOR RAT TRAPS (U.S. CLS. 2, 13, 23, 29, 30, 33, 40 AND 50).

SN 76-127,096. ISBELL, JOHN PAUL, KIRKLAND, WA. FILED 9-13-2000.

TIPTOP

FOR HOUSE HOLD UTENSILS, NAMELY CRADLES FOR HOLDING BOTTLES AND OTHER CONTAINERS IN A DESIRED ORIENTATION (U.S. CLS. 2, 13, 23, 29, 30, 33, 40 AND 50).

SN 76-137,551. QUICKIE MANUFACTURING CORPORATION, CINNAMINSON, NJ. FILED 9-28-2000.

RING-A-MOP

OWNER OF U.S. REG. NO. 994,691.
FOR FLOOR MOPS (U.S. CLS. 2, 13, 23, 29, 30, 33, 40 AND 50).
FIRST USE 8-15-1961; IN COMMERCE 8-15-1961.

SN 76-152,762. 2559170 CANADA INC., POINTE-CLAIRE, QUEBEC, CANADA, BY CHANGE OF NAME CORANCO CORPORATION LIMITED, POINTE-CLAIRE, H9R 1B9, QUEBEC, FILED 10-24-2000.

PRO-FORGE

FOR COOKWARE AND KITCHEN ACCESSORIES, NAMELY NON-ELECTRIC KETTLES, SAUCEPANS, SAUTE PANS, FRYING PANS, SKILLETTS, POTS, METAL COOKING PANS, CASSEROLES, COLANDERS, STEAMER BASKETS AND UTENSILS IN THE NATURE OF SPATULAS, STRAINERS, TURNERS, POT AND PAN SCRAPERS, ROLLING PINS, AND WHISKS (U.S. CLS. 2, 13, 23, 29, 30, 33, 40 AND 50).

CLASS 21—(Continued).

SN 76-159,527. ALTENBURG, CHARLES L., LAS VEGAS, NV. FILED 11-3-2000.

FLY STOP

NO CLAIM IS MADE TO THE EXCLUSIVE RIGHT TO USE "FLY", APART FROM THE MARK AS SHOWN.
FOR CONTAINERS FOR TRAPPING FLYING INSECTS (U.S. CLS. 2, 13, 23, 29, 30, 33, 40 AND 50).

SN 76-178,524. SCHWARTZ, NAN, LAS VEGAS, NV. FILED 12-7-2000.

NANNIES' NAUGHTY NELLIES

FOR TOWEL RACKS NOT OF PRECIOUS METAL, CANDLESTICKS NOT OF PRECIOUS METAL, DECORATIVE CENTERPIECES MADE PRIMARILY OF CERAMIC AND GLASS, AND PLASTIC GOODS FOR HOUSEHOLD USE, NAMELY, TISSUE BOXES AND CARRYING TRAYS (U.S. CLS. 2, 13, 23, 29, 30, 33, 40 AND 50).

SN 76-181,155. WINITSKY, KATHLEEN M., WEST PALM BEACH, FL. FILED 12-12-2000.

DERMASPONGE "A YOUNGER YOU"

NO CLAIM IS MADE TO THE EXCLUSIVE RIGHT TO USE "DERMASPONGE", APART FROM THE MARK AS SHOWN.

FOR COSMETIC FACIAL SCRUB SPONGES (U.S. CLS. 2, 13, 23, 29, 30, 33, 40 AND 50).

SN 76-196,099. OURPET'S COMPANY, FAIRPORT HARBOR, OH. FILED 1-18-2001.

DELIDOME

FOR PET FEEDERS THAT INCLUDE DISPENSERS FOR RELEASING PET TOY FEEDER BALLS WITH PET FOOD AND PET TREATS THEREIN (U.S. CLS. 2, 13, 23, 29, 30, 33, 40 AND 50).

FIRST USE 8-0-1999; IN COMMERCE 8-0-1999.

SN 76-199,199. RINGELSTETTER ENTERPRISES, INC., PRAIRIE DU SAC, WI. FILED 1-26-2001.

WAG'N LOAD

FOR SANITARY ANIMAL WASTE COLLECTION CONTAINER IN THE FORM OF A PURSE-LIKE POUCH OR SAC (U.S. CLS. 2, 13, 23, 29, 30, 33, 40 AND 50).

FIRST USE 12-0-1999; IN COMMERCE 12-0-1999.

CLASS 21—(Continued).

SN 76-202,325. SOLOMON, JEANNETTE G., STOCKTON, NJ. FILED 1-31-2001.

TSUKI KAME

THE ENGLISH TRANSLATION OF "TSUKI KAME" IS "MOON TURTLE".
FOR POTTERY, NAMELY VASES, POTS, BOWLS AND PLATE (U.S. CLS. 2, 13, 23, 29, 30, 33, 40 AND 50).

SN 76-207,502. TRAVEL CADDY, INC., DBA TRAVELON, DES PLAINES, IL. FILED 2-7-2001.

TIP

FOR THERMAL INSULATED CONTAINERS AND INSULATED PACKING FOR FOOD OR BEVERAGES (U.S. CLS. 2, 13, 23, 29, 30, 33, 40 AND 50).

SN 76-217,577. DIRECT BUSINESS TECHNOLOGIES, INC., CENTERVILLE, OH. FILED 2-28-2001.

FILL IT AND FORGET IT

FOR WATERING AND FEEDING DEVICE, NAMELY, AN AUTOMATIC PLANT WATERING AND FEEDING SYSTEM CONSISTING OF A CONTAINER FOR PLANTS HAVING A WATER RESERVOIR FOR INDOOR OR OUTDOOR USE (U.S. CLS. 2, 13, 23, 29, 30, 33, 40 AND 50).

FIRST USE 10-1-2000; IN COMMERCE 10-1-2000.

SN 76-230,817. GLOVES, INC., TAUNTON, MA. FILED 3-27-2001.

EXACTO

FOR LATEX DISPOSABLE GLOVES FOR GENERAL USE (U.S. CLS. 2, 13, 23, 29, 30, 33, 40 AND 50).

SN 76-241,270. ARABICA FUNDING, INC., BABYLON, NY. BY ASSIGNMENT CARIBOU COFFEE COMPANY, INC., MINNEAPOLIS, MN. FILED 4-16-2001.

CARIBOU COFFEE

NO CLAIM IS MADE TO THE EXCLUSIVE RIGHT TO USE "COFFEE", APART FROM THE MARK AS SHOWN.
FOR MUGS AND TUMBLERS (U.S. CLS. 2, 13, 23, 29, 30, 33, 40 AND 50).
FIRST USE 12-14-1992; IN COMMERCE 9-4-1994.

CLASS 21—(Continued).

SN 76-253,717. LODGE MANUFACTURING COMPANY, SOUTH PITTSBURG, TN. FILED 5-8-2001.

LODGE LITE

OWNER OF U.S. REG. NO. 1,497,789.
FOR CAST-IRON COOKWARE AND BAKEWARE, NAMELY, SKILLETS, PANS, DUTCH OVENS, TRIVETS, POTS, NON-ELECTRIC GRIDDLES AND NON-ELECTRIC DEEP FRYERS (U.S. CLS. 2, 13, 23, 29, 30, 33, 40 AND 50).

SN 76-260,187. QSL CORPORATION, DRACUT, MA. FILED 5-21-2001.

WAXCESSORIES

FOR CANDLE HOLDERS, CANDLE JARS, CANDLE PLATES, CANDLE POTS, AND CANDLE SHADES, ALL NOT OF PRECIOUS METAL (U.S. CLS. 2, 13, 23, 29, 30, 33, 40 AND 50).
FIRST USE 11-0-1994; IN COMMERCE 11-0-1994.

SN 76-289,660. BREEDERS' CUP LIMITED, LEXINGTON, KY. FILED 7-24-2001.



OWNER OF U.S. REG. NO. 1,329,595 AND OTHERS.
FOR HOUSEWARES AND GLASS; NAMELY, DRINKING GLASSES AND SHOT GLASSES (U.S. CLS. 2, 13, 23, 29, 30, 33, 40 AND 50).

SN 76-300,069. UNITED COMB & NOVELTY CORPORATION, LEOMINSTER, MA. FILED 8-15-2001.

TRASHMASTER

FOR PLASTIC TRASH CANS (U.S. CLS. 2, 13, 23, 29, 30, 33, 40 AND 50).
FIRST USE 7-0-2000; IN COMMERCE 9-0-2000.

CLASS 21—(Continued).

SN 76-300,270. MENASHA CORPORATION, NEENAH, WI. FILED 8-16-2001.

RACK MAX

NO CLAIM IS MADE TO THE EXCLUSIVE RIGHT TO USE "RACK", APART FROM THE MARK AS SHOWN.
FOR PLASTIC DISH RACKS FOR USE IN RESTAURANTS AND OTHER EATING ESTABLISHMENTS (U.S. CLS. 2, 13, 23, 29, 30, 33, 40 AND 50).

SN 78-007,114. COLE ROBIN D, MESA, AZ. FILED 5-6-2000.

LAUGHING PLANET

FOR HANDCRAFTED SCULPTURES AND DECORATIVE DISPLAYS, NAMELY, DECORATIVE MASKS, GARDEN DISPLAYS IN THE NATURE OF HAND CRAFTED SCULPTURES OF REAL AND FANTASY CREATURES, AND VESSELS IN THE NATURE OF HANDCRAFTED FLOWER POTS, CUPS, AND FUNCTIONAL AND DECORATIVE VASES, ALL OF THE FOREGOING MADE OF CLAY AND CELLULOSE MIXTURES, AND INTENDED FOR USE INDOORS AND OUTDOORS (U.S. CLS. 2, 13, 23, 29, 30, 33, 40 AND 50).
FIRST USE 3-0-1999; IN COMMERCE 4-0-1999.

SN 78-027,775. TOTAL SOURCE MANUFACTURING, SAN DIEGO, CA. FILED 9-26-2000.



The logo for UNITEK features the word "UNITEK" in a bold, black, sans-serif font. A thick, black, curved line arches over the letters, resembling a stylized orbit or a swoosh.

FOR CLEANING CLOTH WIPER PRODUCTS, NAMELY, PRESATURATED WIPES, SEALED-EDGED FABRIC WIPES, LAUNDERED SYNTHETIC WIPES, NONWOVEN WIPES, AND TACK CLOTH WIPES; CLEANING COVER CLOTHS FOR POLE-MOUNTED WIPING DEVICES; AND PIPE CLEANING CLOTH PIGS, NAMELY FABRIC WIPES FOR CLEANING PIPES AND TUBES (U.S. CLS. 2, 13, 23, 29, 30, 33, 40 AND 50).
FIRST USE 8-15-1999; IN COMMERCE 8-15-1999.

CLASS 21—(Continued).

SN 78-034,370. KOFFEE KOMPANIONS, INCORPORATED, COLORADO SPRINGS, CO. FILED 11-8-2000.

KUP KOLLAR

NO CLAIM IS MADE TO THE EXCLUSIVE RIGHT TO USE "CUP", APART FROM THE MARK AS SHOWN.
FOR THERMAL INSULATED FABRIC WRAPS FOR HOT AND COLD TAKEOUT CUPS, TAPERED DRINKING GLASSES, PLASTIC BOTTLES, GLASS BOTTLES, AND CANS (U.S. CLS. 2, 13, 23, 29, 30, 33, 40 AND 50).
FIRST USE 3-21-1996; IN COMMERCE 11-28-1997.

SN 78-050,271. PROCTER & GAMBLE COMPANY, THE, CINCINNATI, OH. FILED 2-26-2001.

LA BOLITA

THE ENGLISH TRANSLATION OF THE WORD "BOLITA" IN THE MARK IS "LITTLE BALL".
FOR PLASTIC CONTAINER FOR USE IN LAUNDRY MACHINES FOR DISPENSING LAUNDRY DETERGENT AND FABRIC SOFTENER AND FOR PRETREATING LAUNDRY (U.S. CLS. 2, 13, 23, 29, 30, 33, 40 AND 50).

SN 78-050,275. PROCTER & GAMBLE COMPANY, THE, CINCINNATI, OH. FILED 2-26-2001.

CAZAMANCHAS

THE ENGLISH TRANSLATION OF THE WORD "CAZAMANCHAS" IN THE MARK IS "HUNTER OF STAINS".
FOR PLASTIC CONTAINER FOR USE IN LAUNDRY MACHINES FOR DISPENSING LAUNDRY DETERGENT AND FOR PRETREATING LAUNDRY (U.S. CLS. 2, 13, 23, 29, 30, 33, 40 AND 50).

SN 78-071,199. CONAIR CORPORATION, STAMFORD, CT. FILED 6-27-2001.

SAF-T-LOK

FOR COMPONENT OF ELECTRIC AND /OR BATTERY OPERATED TOOTHBRUSHES, NAMELY, BATTERY DOOR COVERS (U.S. CLS. 2, 13, 23, 29, 30, 33, 40 AND 50).

CLASS 21—(Continued).

SN 78-071,249. BLUE RIBBON PET PRODUCTS, INC.,
COMMACK, NY. FILED 6-27-2001.

CAGE CONNECTION EUROPA SERIES

OWNER OF U.S. REG. NO. 2,142,285.
NO CLAIM IS MADE TO THE EXCLUSIVE RIGHT TO
USE "CAGE" AND "SERIES", APART FROM THE MARK AS
SHOWN.
FOR BIRD AND SMALL ANIMAL CAGES (U.S. CLS. 2,
13, 23, 29, 30, 33, 40 AND 50).

CLASS 24—FABRICS

SN 75-881,904. ALEXANDER JULIAN, INC., RIDGEFIELD,
CT. FILED 12-28-1999.

ALEXANDER JULIAN AT HOME

THE NAME "ALEXANDER JULIAN" IDENTIFIES A
LIVING INDIVIDUAL WHOSE CONSENT IS OF RECORD.
FOR BED SHEETS, PILLOW CASES, DRAPERIES,
COMFORTERS, SHAMS, TROWS, AFGHANS; BATH,
BEACH AND KITCHEN TOWELS; DECORATIVE FAB-
RICS SHOWER CURTAINS; KITCHEN ACCESSORIES,
NAMELY, GLASS CLOTHS, OVEN MITTENS AND POT
HOLDERS; WINDOW TREATMENTS, NAMELY, WIN-
DOW CURTAINS; TABLE CLOTHS, LINENS, NAPKINS
AND PLACEMATS, ALL MADE OF TEXTILE FABRIC
(U.S. CLS. 42 AND 50).

SN 76-259,863. ULTRAFABRICS, LLC, ELMSFORD, NY.
FILED 5-21-2001.

ULTRATECH 7000

FOR TEXTILE FABRICS FOR USE IN UPHOLSTERY
FOR AIRCRAFT AND AUTOMOBILE SEATING AND
WALLCOVERINGS, AND IN THE MANUFACTURE OF
FURNITURE (U.S. CLS. 42 AND 50).

CLASS 22—CORDAGE AND FIBERS

SN 76-121,881. COVAS, JOSEP A., COLORADO SPRINGS, CO.
FILED 9-6-2000.

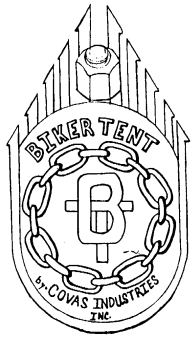

NO CLAIM IS MADE TO THE EXCLUSIVE RIGHT TO
USE "BIKER TENT" AND "INDUSTRIES INC.", APART
FROM THE MARK AS SHOWN.
FOR TENT FOR INDIVIDUAL HAVING SEPARATE
COMPARTMENT FOR SPORTS VEHICLE (U.S. CLS. 1, 2,
7, 19, 22, 42 AND 50).
FIRST USE 6-1-2000; IN COMMERCE 6-1-2000.

SN 78-071,194. LOUISVILLE BEDDING COMPANY, LOUIS-
VILLE, KY. FILED 6-27-2001.

ULTRA ZONE

FOR MATTRESS PADS (U.S. CLS. 42 AND 50).

SN 78-080,182. AVALOS, DAVID, G., BURBANK, CA. FILED
8-20-2001.

INSECURITY BLANKET

NO CLAIM IS MADE TO THE EXCLUSIVE RIGHT TO
USE "BLANKET", APART FROM THE MARK AS SHOWN.
FOR FLEECE BED BLANKETS; BLANKET TROWS
WITH EMBROIDERED LOGO (U.S. CLS. 42 AND 50).

CLASS 25—CLOTHING

SN 75-138,683. IMCOA LICENSING AMERICA, INC., TORONTO, ONTARIO, CANADA, BY ASSIGNMENT INDIAN MOTORCYCLE SUPPLY INC., SUGAR GROVE, IL. FILED 7-23-1996.

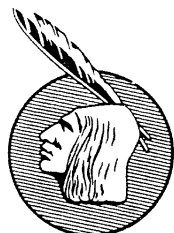

Indian

OWNER OF U.S. REG. NOS. 652,777 AND 921,459. THE LINING SHOWN ON THE DRAWING IS A FEATURE OF THE MARK AND DOES NOT INDICATE COLOR. FOR CLOTHING, NAMELY, PANTS, SHIRTS, JACKETS, SHORTS, SWEATERS, DRESSES, SKIRTS, UNDERWEAR, HATS, BELTS, TIES, AND SHOES (U.S. CLS. 22 AND 39).

FIRST USE 3-4-1953; IN COMMERCE 3-4-1953.

SN 75-535,799. FAT BOY POSSE ENTERPRISES, DALLAS, TX. FILED 8-13-1998.

BITCH

FOR CLOTHING, NAMELY, T-SHIRTS, HATS, AND CAPS (U.S. CLS. 22 AND 39).

SN 75-571,467. BLAUER MANUFACTURING COMPANY, INC., BOSTON, MA. FILED 10-16-1998.

B.LINER

FOR UNIFORM CLOTHING FOR SERVICE PERSONNEL, NAMELY, JACKETS, CAPS, PANTS, AND SWEATERS THAT ARE WIND RESISTANT (U.S. CLS. 22 AND 39).

SN 75-617,578. VULCAN NORTHWEST, BELLEVUE, WA. FILED 1-8-1999.

WIRED WORLD

FOR CLOTHING, NAMELY, T-SHIRTS, SHIRTS, SWEATSHIRTS, JACKETS, COATS, PANTS, SHORTS, SWEATERS, OUTDOORWEAR AND SPORTSWEAR, NAMELY, BATHING SUITS, HIKING BOOTS, RAINWEAR, SWEATPANTS, SWEATSHORTS, SWEATSUITS, SCARVES, CAPS, HATS, VISORS, SHOES, ATHLETIC FOOTWEAR, GLOVES (U.S. CLS. 22 AND 39).

CLASS 25—(Continued).

SN 75-729,891. KABUSHIKI KAISHA ONWARD KASHIYAMA, TOKYO, JAPAN, FILED 6-16-1999.

ICB

FOR SUITS, COATS, JACKETS, SHIRTS, T-SHIRTS, DRESSES, SKIRTS, BLOUSES, TROUSERS, PANTS, SHORTS, JUMPERS, SWEATERS, CARDIGANS, VESTS, SCARVES, MUFFS, SHAWLS, NECKERCHIEVES, GLOVES, MITTENS, NECKTIES, SOCKS, STOCKINGS, TIGHTS, UNDERCLOTHING, PAJAMAS, HATS, CAPS, APRONS, BATH ROBES, BATHING CAPS, SWIMMING SUITS, GOLF WEAR, NAMELY, SHOES, SHIRTS, GLOVES, JACKETS, SHORTS, PANTS, SKIRTS, SKI WEAR, ANORAKS, UNIFORMS, RAIN WEAR, NAMELY, PANTS, JACKETS, COATS, SHIRTS, BOOTS, WIND-RESISTANT JACKETS, WET SUITS FOR SCUBA DIVING, WET SUITS FOR WATER SKIING; SPORTS SHOES, SKI BOOTS, GOLF SHOES, FOOTBALL SHOES, MOUNTAINEERING BOOTS, SNEAKERS, HORSE-RIDING BOOTS; GARTER BELTS, SOCK SUSPENDERS, SUSPENDERS, HEAD, NECK, SWEAT AND WRIST BANDS, CLOTHING BELTS, AND FOOTWEAR (U.S. CLS. 22 AND 39).

SN 75-736,610. HOUSE OF LOUNGE, LLC, NEW ORLEANS, LA. FILED 6-24-1999.

HOUSE OF LOUNGE

FOR LINGERIE; UNDERGARMENTS; ROBES, BATH ROBES, KIMONOS, SMOKING JACKETS AND SARIS; PAJAMAS, TEDDIES AND NIGH GOWNS; GARTERS AND GARTER BELTS; STOCKINGS AND PANTY HOSE; SLIPPERS; BRAS; PANTIES; GLOVES, SCARVES, SHAWLS, HATS AND FEATHER BOAS; SLIPS AND CAMISOLES; CORSETS AND BUSTIERS; ANGEL WINGS AND FAIRY WINGS; CAPES AND MASKS; PURSES AND HANDBAGS; HAIR ORNAMENTS; FUR HANDCUFFS; EVENINGS GOWNS AND LADIES DRESSES; MEN'S AND WOMEN'S DRESS SHIRTS AND BLOUSES; OVERCOATS; PANTS AND PANT-SLACKS; WALKING SHORTS, AND MEN'S AND WOMEN'S SWIMWARE (U.S. CLS. 22 AND 39).

FIRST USE 2-0-1998; IN COMMERCE 2-0-1998.

SN 75-762,048. DESERT TROON LIMITED, L.L.C., SCOTTSDALE, AZ. FILED 7-27-1999.

TORREON

THE ENGLISH TRANSLATION OF "TORREON" IS "LARGE FORTIFIED TOWER".

FOR GOLF WEAR AND CLOTHING, NAMELY, SPORT SHIRTS, DRESS SHIRTS, TEE SHIRTS, BLOUSES, HATS, BASEBALL CAPS, VISORS, GLOVES, MITTENS, SOCKS, BOXER, SHORTS, SLACKS AND SHORTS (U.S. CLS. 22 AND 39).

FIRST USE 8-1-1998; IN COMMERCE 8-1-1998.

CLASS 25—(Continued).

SN 76-040,296. ISAAC CLASS, BRONX, NY. FILED 5-3-2000.



FOR MEN'S AND WOMEN'S CLOTHING, NAMELY, TIES, SCARVES, SUITS, TUXEDOS, JACKETS, SLACKS, SHIRTS, VESTS, SWEATERS, KNIT SHIRTS, BELTS, COATS, OVERCOATS, DRESSES, PANTS, SHORTS, SKIRTS, BLOUSES, GLOVES, SHOES, BOOTS, SUSPENDERS, TIE PINS, CUFFLINKS, NECKERCHIEFS, KERCHIEFS, SOCKS, MUFFLERS, SHAWLS, AND HATS (U.S. CLS. 22 AND 39).

FIRST USE 2-0-2000; IN COMMERCE 2-0-2000.

SN 76-048,093. U.B. TUFF LLC, PERTH AMBOY, NJ. FILED 5-15-2000.



NO CLAIM IS MADE TO THE EXCLUSIVE RIGHT TO USE "BRAND" AND "COLLECTION", APART FROM THE MARK AS SHOWN.

FOR LEATHER OUTERWEAR, NAMELY LEATHER JACKETS, LEATHER COATS, LEATHER PANTS, LEATHER GLOVES AND HATS (U.S. CLS. 22 AND 39).

SN 76-061,516. ROUSH CORPORATION, DBA ROUSH RACING, LIVONIA, MI. FILED 6-2-2000.



OWNER OF U.S. REG. NOS. 2,163,089 AND 2,327,805.

FOR CLOTHING, NAMELY, TOPS, HATS, NIGHT SHIRTS, SOCKS, SWEAT SHIRTS, T-SHIRTS, TANK TOPS, CAPS, JACKETS, SHORTS, VISORS, SWEAT PANTS, SWEATERS, SWEAT SUITS, SUSPENDERS, PANTS, AND CLOTH INFANT BIBS SOLD AS PROMOTIONAL MATERIALS AT RACE AND MOTOR-SPORT VENUES (U.S. CLS. 22 AND 39).

FIRST USE 1-1-1998; IN COMMERCE 1-1-1998.

CLASS 25—(Continued).

SN 76-067,466. TERESI ENTERPRISES, LLC, FORT LAUDERDALE, FL. FILED 6-9-2000.

DYNO-DRAGS

FOR CLOTHING, NAMELY SWEATSHIRTS, SWEAT-PANTS, SHORTS, JOGGING SUITS, TOPS, BRA TOPS, T-SHIRTS, SHIRTS, SUSPENDERS, WIND RESISTANT JACKETS, JACKETS, VESTS, CHAPS, JEANS, LEATHER JEANS, SKIRTS, SWIMWEAR, BOOTS, BANDANNAS, GLOVES, HATS, CAPS, SCARVES, LEG WARMERS, BERETS, HEADBANDS, UNDERWEAR, HOSIERY, PANTIES, TEDDIES, BELTS, AND BOLO TIES (U.S. CLS. 22 AND 39).

SN 76-077,687. AQUATICUS, LLC, TRENTON, NJ. FILED 6-26-2000.

AQUATICUS

FOR CLOTHING AND ACCESSORIES, NAMELY, TEE-SHIRTS, SWEATSHIRTS, HATS, CAPS AND SWIMSUITS (U.S. CLS. 22 AND 39).

SN 76-080,317. FORD MOTOR COMPANY, DEARBORN, MI. FILED 6-29-2000.

KIDS REVVIN' WITH FORD

OWNER OF U.S. REG. NOS. 74,530, 1,874,207 AND OTHERS.

FOR CLOTHING, NAMELY, T-SHIRTS, SWEAT SHIRTS, POLO SHIRTS, GOLF SHIRTS, DRESS SHIRTS, SWEATERS, VESTS, JACKETS, RAINWEAR, WORK COATS, OVERALLS, SHORTS, PANTS, SCARVES, SLEEP WEAR, NECKTIES; HEADWEAR, NAMELY, CAPS, HATS, SUNVISORS, HEADBANDS; FOOTWEAR, NAMELY, ATHLETIC SHOES, SLIPPERS AND MOCCASINS (U.S. CLS. 22 AND 39).

CLASS 25—(Continued).

SN 76-080,321. FORD MOTOR COMPANY, DEARBORN, MI. FILED 6-29-2000.



OWNER OF U.S. REG. NOS. 74,530, 1,874,207 AND OTHERS.

FOR CLOTHING, NAMELY, T-SHIRTS, SWEAT SHIRTS, POLO SHIRTS, GOLF SHIRTS, DRESS SHIRTS, SWEATERS, VESTS, JACKETS, RAINWEAR, WORK COATS, OVERALLS, SHORTS, PANTS, SCARVES, SLEEP WEAR, NECKTIES; HEADWEAR, NAMELY, CAPS, HATS, SUNVISORS, HEADBANDS; FOOTWEAR, NAMELY, ATHLETIC SHOES, SLIPPERS AND MOCCASINS (U.S. CLS. 22 AND 39).

SN 76-088,011. SAPRA, AMAR S., WEST COVINA, CA. FILED 7-13-2000.

SILVER TOUCH USA

NO CLAIM IS MADE TO THE EXCLUSIVE RIGHT TO USE "SILVER" AND "USA", APART FROM THE MARK AS SHOWN.

FOR CLOTHING AND APPAREL FOR MEN, BOYS, WOMEN, GIRLS, AND TODDLERS, NAMELY SHIRTS, PANTS, SUITS, UNDERWEAR, SWEATERS, FOOTWEAR AND HEADWEAR; INFANTWARE (U.S. CLS. 22 AND 39).

SN 76-089,218. BILLIARD CONGRESS OF AMERICA, INC., COLORADO SPRINGS, CO. FILED 7-14-2000.

USA CUE SPORTS

NO CLAIM IS MADE TO THE EXCLUSIVE RIGHT TO USE "USA" AND "SPORTS", APART FROM THE MARK AS SHOWN.

FOR CLOTHING, NAMELY SHIRTS, T-SHIRTS, SWEATSHIRTS, SWEATPANTS, SHORTS, POLO-STYLE SHIRTS, JERSEYS, JACKETS AND BASEBALL STYLE CAPS (U.S. CLS. 22 AND 39).

FIRST USE 5-15-2001; IN COMMERCE 5-15-2001.

CLASS 25—(Continued).

SN 76-096,261. WARNACO U.S., INC., MILFORD, CT. FILED 7-24-2000.

LACE LIFT

OWNER OF U.S. REG. NOS. 1,600,121, 2,285,381 AND OTHERS.

FOR INTIMATE APPAREL AND FIGURE ENHANCING GARMENTS, NAMELY, BRAS, PANTIES, UNDERWEAR, UNDERPANTS, UNDERGARMENTS, UNDERCLOTHES, TEDDIES, SLIPS, SARONGS, NEGLIGEEES, LINGERIE, FOUNDATION GARMENTS, GIRDLES, CORSETS, CAMISOLES, BODY SLIPS AND BODY SUITS, SLEEPWEAR AND NIGHTGOWNS (U.S. CLS. 22 AND 39).

SN 76-103,021. BAEKE, JOHN L., JR., OVERLAND PARK, KS. FILED 8-4-2000.



FOR WOMEN'S APPAREL, NAMELY, BRASSIERES, PANTIES, UNDERWEAR, SHIRTS, BLOUSES, PANTS, DRESSES, SKIRTS AND LINGERIE (U.S. CLS. 22 AND 39).

SN 76-103,662. TOUCH OF LIFE MINISTRIES, INC., LAS VEGAS, NV. FILED 8-7-2000.

CHOSEN WOMAN

NO CLAIM IS MADE TO THE EXCLUSIVE RIGHT TO USE "WOMAN", APART FROM THE MARK AS SHOWN. FOR T-SHIRTS (U.S. CLS. 22 AND 39).

SN 76-117,168. RINGWALD, RAYMOND, MEDINAH, IL. FILED 8-28-2000.

JOE GOLFER

FOR CLOTHING, NAMELY, SHIRTS, PANTS, T-SHIRTS, HATS, POLO SHIRTS, DRESS SHIRTS, JACKETS, AND-SWEATERS AND SWEATSHIRTS (U.S. CLS. 22 AND 39).

FIRST USE 4-1-1991; IN COMMERCE 4-1-1991.

CLASS 25—(Continued).

SN 76-118,805. VIKINGSEXTREME, INC., PLANO, TX. FILED 8-28-2000.



FOR CLOTHING, NAMELY SHIRTS, HATS, BOXERS (UNDERGARMENTS), SWEATSHIRTS, FLEECES, SHORTS, PANTS, AND COATS (U.S. CLS. 22 AND 39).

SN 76-119,216. POLAKOW, JASON NICHOLAS, VICTORIA 3228, AUSTRALIA, FILED 8-30-2000.



NO CLAIM IS MADE TO THE EXCLUSIVE RIGHT TO USE "AUSTRALIA", APART FROM THE MARK AS SHOWN.

FOR CLOTHING, NAMELY, SWEATERS, COATS, JACKETS, SHIRTS, T-SHIRTS, SHORTS, PANTS, DRESSES, SKIRTS, LEGGINGS, SCARVES, BELTS, SWEAT PANTS, SWEATSHIRTS, SWIM WEAR, WET SUITS, BEACH COVERUPS, WRAPS, BODY SUITS, FOOTWEAR, AND HEADWEAR (U.S. CLS. 22 AND 39).

CLASS 25—(Continued).

SN 76-124,970. NIKKEN, INC., IRVINE, CA. FILED 9-11-2000.



NO CLAIM IS MADE TO THE EXCLUSIVE RIGHT TO USE "EQL" AND "FIR", APART FROM THE MARK AS SHOWN.

THE ENGLISH TRANSLATION OF THE WORD "EQL" AND "FIR" IN THE MARK IS "EQUILATERAL" AND "FAR INFRA RED".

FOR MAGNETIC INSOLES FOR SHOES (U.S. CLS. 22 AND 39).

SN 76-126,787. XO COMMUNICATIONS, INC., RESTON, VA. BY CHANGE OF NAME NEXTLINK COMMUNICATIONS, INC., MCLEAN, VA. FILED 9-8-2000.

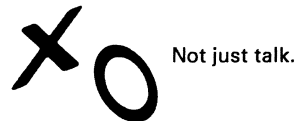

THE MARK CONSISTS OF THE LETTERS "XO" IN STYLIZED FORM APPEARING TO THE LEFT OF THE PHRASE "NOT JUST TALK".

FOR CLOTHING, NAMELY, SHIRTS, SHORTS, T-SHIRTS, SWEATSHIRTS, SWEATPANTS, AND SOCKS; FOOTWEAR; HEADGEAR, NAMELY HATS, VISORS, NOVELTY VISORS, AND BELTS (U.S. CLS. 22 AND 39).

SN 76-129,325. TORI RICHARD, LTD., HONOLULU, HI. FILED 9-14-2000.

PAU HANA

FOR SHIRTS, DRESSES, SKIRTS, PANTS AND BLOUSES (U.S. CLS. 22 AND 39).
FIRST USE 7-7-1995; IN COMMERCE 8-30-1996.

SN 76-191,200. FLORSHEIM GROUP INC., CHICAGO, IL. FILED 1-8-2001.

@LEISURE

OWNER OF U.S. REG. NOS. 2,271,689, 2,386,719 AND OTHERS.

FOR MEN'S FOOTWEAR, SHOES, AND SLIPPERS (U.S. CLS. 22 AND 39).

CLASS 25—(Continued).

SN 76-191,249. FTS APPAREL, INC., COLORADO SPRINGS, CO. FILED 1-8-2001.



THE MARK CONSISTS OF A REPRESENTATION OF A STYLIZED LIGHT SWITCH.

FOR CLOTHING, NAMELY PARKAS, BATHING TRUNKS, BEACH WEAR, SHORTS, UNDERWEAR, TANK TOPS, UNDERSHIRTS, T-SHIRTS, TURTLE-NECKS, SOCKS, SHIRTS, SPORT SHIRTS, SWEAT SHIRTS, KNIT SHIRTS, NIGHT SHIRTS, GOLF SHIRTS, POLO SHIRTS, JERSEYS, SWEATERS, JACKETS, PONCHOS, COATS, JOGGING SUITS, SWEAT SUITS, WARM-UP SUITS, SWEATPANTS, PANTS, HEAD WEAR, HATS, CAPS HEADBANDS, SUN VISORS, GLOVES, SCARVES, FOUL WEATHER GEAR, VESTS (U.S. CLS. 22 AND 39).

SN 76-196,577. COLDWATER CREEK INC., SANDPOINT, ID. FILED 1-19-2001.

WHAT A BEAUTIFUL FIT!

OWNER OF U.S. REG. NO. 1,876,534.
FOR CLOTHING; NAMELY, SHIRTS, JACKETS, BLOUSES, PANTS, SWEATSHIRTS, SWEATPANTS, DRESSES AND SLEEPWEAR (U.S. CLS. 22 AND 39).
FIRST USE 1-1-2001; IN COMMERCE 1-1-2001.

SN 76-196,580. COLDWATER CREEK INC., SANDPOINT, ID. FILED 1-19-2001.

**ALL SIZES, ONE PRICE
WHAT A BEAUTIFUL FIT!**

OWNER OF U.S. REG. NO. 1,876,534.
FOR CLOTHING; NAMELY, SHIRTS, JACKETS, BLOUSES, PANTS, SWEATSHIRTS, SWEATPANTS, DRESSES AND SLEEPWEAR (U.S. CLS. 22 AND 39).
FIRST USE 1-1-2001; IN COMMERCE 1-1-2001.

CLASS 25—(Continued).

SN 76-205,319. MARS, INCORPORATED, MCLEAN, VA. FILED 2-6-2001.

I DON'T DO COMMERCIALS

FOR CLOTHING, NAMELY T-SHIRTS, AND SLEEPWEAR, NAMELY NIGHTSHIRTS (U.S. CLS. 22 AND 39).

SN 76-242,859. FLEET STREET, LTD., AVENEL, NJ. FILED 4-18-2001.

STUDIO RAY

NO CLAIM IS MADE TO THE EXCLUSIVE RIGHT TO USE "STUDIO", APART FROM THE MARK AS SHOWN.

FOR CLOTHING, NAMELY, PANTS, COATS, JACKETS, SHIRTS, VESTS AND SWEATERS (U.S. CLS. 22 AND 39).

SN 76-247,804. TURNER NETWORK TELEVISION LP, LLLP, ATLANTA, GA. FILED 4-27-2001.

WE KNOW DRAMA

FOR CLOTHING FOR MEN, WOMEN AND CHILDREN, NAMELY, SHIRTS, T-SHIRTS, SWEATSHIRTS, JOGGING SUITS, HATS, CAPS AND SUN-VISORS (U.S. CLS. 22 AND 39).

SN 76-253,523. C.S.F. CORP., WILMINGTON, DE. FILED 5-9-2001.

MAGIC SUPPORT

NO CLAIM IS MADE TO THE EXCLUSIVE RIGHT TO USE "SUPPORT", APART FROM THE MARK AS SHOWN.

FOR WOMEN'S APPAREL, NAMELY BRAS (U.S. CLS. 22 AND 39).

CLASS 25—(Continued).

SN 76-259,956. TOP COW PRODUCTIONS, INC., LOS ANGELES, CA. FILED 5-17-2001.

THE DAMNED

FOR CLOTHING, NAMELY, UNDERWEAR, RAINWEAR, SLEEPWEAR, HOSIERY, FOOTWEAR, BELTS, SUSPENDERS, CAPS, HEAD WEAR, KNIT CAPS, ATHLETIC SHOES, BATHROBES, COATS, SHIRTS, GLOVES, HATS, JACKETS, JOGGING SUITS, LEATHER JACKETS, MITTENS, PAJAMAS, SCARVES, SHORTS, PANTS, SKIRTS, DRESSES, SLIPPERS, SOCKS, SWEATERS, SWIM WEAR, TANK TOPS, TIES, VESTS, MASQUERADE COSTUMES AND MASKS AND ACCESSORIES SOLD IN CONNECTION THEREWITH, CHILDREN'S FOOTWEAR, BOXER SHORTS, LONG UNDERWEAR, BRAS, FITNESS TOPS, HEADBANDS, WRISTBANDS, LEOTARDS, SINGLETTS, UNITARDS, VISORS, WARM-UP SUITS, OVERALLS, WIND RESISTANT JACKETS, PARKAS, JUMP SUITS, CROP TOPS, TIGHTS, TENNIS WEAR, ANORAKS, SWEAT SHIRTS, SWEAT PANTS, AND T-SHIRTS (U.S. CLS. 22 AND 39).

SN 76-261,174. TURNER REGIONAL ENTERTAINMENT NETWORK, INC., ATLANTA, GA. FILED 5-23-2001.

OFF THE MENU

FOR CLOTHING FOR MEN, WOMEN AND CHILDREN, NAMELY, SHIRTS, T-SHIRTS, SWEATSHIRTS, JOGGING SUITS, TROUSERS, JEANS, SHORTS, TANK TOPS, RAINWEAR, CLOTH BIBS, SKIRTS, BLOUSES, DRESSES, SUSPENDERS, SWEATERS, JACKETS, COATS, RAINCOATS, SNOWSUITS, TIES, ROBES, HATS, CAPS, SUNVISORS, BELTS, SCARVES, SLEEPWEAR, PAJAMAS, LINGERIE, UNDERWEAR, BOXER SHORTS, SOCKS AND SHOES (U.S. CLS. 22 AND 39).

SN 76-269,023. BCNY INTERNATIONAL INC., NEW YORK, NY. FILED 6-8-2001.

ActionFlex Comfort

NO CLAIM IS MADE TO THE EXCLUSIVE RIGHT TO USE "COMFORT", APART FROM THE MARK AS SHOWN, FOR FOOTWEAR (U.S. CLS. 22 AND 39).

SN 76-275,306. JENNIFER LANTZ CORPORATION, FERNDALE, MI. FILED 6-22-2001.

SLEEP BY JML

FOR WOMEN'S AND MEN'S CLOTHING, NAMELY, ROBES, GOWNS, T-SHIRTS, TANK TOPS, PAJAMA TOPS, PAJAMA BOTTOMS, AND LOUNGEWEAR (U.S. CLS. 22 AND 39).

CLASS 25—(Continued).

SN 76-275,847. FITNESS DE FABRI, INC., LAS VEGAS, NV. FILED 6-25-2001.

FABRIVEST

FOR VESTS AND JACKETS FOR USE IN EXERCISE, FITNESS, AND PHYSICAL TRAINING ACTIVITIES (U.S. CLS. 22 AND 39).

SN 76-290,126. PEEKAY, INC., AUBURN, WA. FILED 7-25-2001.

SHUNGA EROTIC

NO CLAIM IS MADE TO THE EXCLUSIVE RIGHT TO USE "EROTIC", APART FROM THE MARK AS SHOWN.

THE ENGLISH TRANSLATION OF "SHUNGA" IS "IMAGES OF SPRING".

FOR CLOTHING, NAMELY, LINGERIE, BRAS, PANTIES, BOXERS, NAMELY, BOXER SHORTS AND BOXER BRIEFS, BRIEFS, CAMISOLES, CORSETS, BUSTIERS, UNDERWEAR, UNDERGARMENTS, HOSIERY, GARTER BELTS, BODY STOCKINGS, HOSIERY ACCESSORIES, NAMELY, GLOVES AND BELTS WITH ATTACHABLE RHINESTONES AND OTHER COSTUME JEWELRY AND SWIMWEAR; SLEEPWEAR, NAMELY, PAJAMAS, NIGHTGOWNS, NEGLIGEEES, ROBES; LOUNGEWEAR; AND DAYWEAR, NAMELY, PANTS, SHIRTS AND SHORTS (U.S. CLS. 22 AND 39).

SN 76-294,301. FOX RACING, INC., MORGAN HILL, CA. FILED 8-3-2001.



THE NAME "RICKY CARMICHAEL" IDENTIFIES A LIVING INDIVIDUAL WHOSE CONSENT IS OF RECORD.

FOR CLOTHING, NAMELY, JACKETS, RAINCOATS, SWEATSHIRTS, JERSEYS, SHIRTS, PANTS, HATS, CAPS, SWEATBANDS, GLOVES, SOCKS, APRONS, POLO SHIRTS (U.S. CLS. 22 AND 39).

SN 76-297,590. BESH INTERNATIONAL, INC., SAN DIEGO, CA. FILED 8-9-2001.

XENT

FOR CLOTHING, NAMELY, GOLF SHIRTS, DRESSES, JUMPERS, CARDIGANS, TUXEDOS, SUITS, OVERCOATS, TROUSERS, JACKETS, SINGLETTS, LINGERIE, BELTS, KNIT SHIRTS, SPORT SHIRTS, SWEAT SHIRTS, T SHIRTS, PANTS, SWEATERS, SOCKS, TIES, BOW TIES, SHORTS, BEACH VISORS, BEACHWEAR, SWIMSUITS, HATS, CAPS, BEANIE HATS, BLOUSES, UNDERWEAR, PULL OVERS, SPORTING SHIRTS, JERSEYS, FOOTWEAR, AND SHOES (U.S. CLS. 22 AND 39).

FIRST USE 1-1-2000; IN COMMERCE 1-1-2000.

CLASS 25—(Continued).

SN 76-297,632. BC HATS, INC., ST. AUGUSTINE, FL. FILED 8-1-2001.

BILL CONNER

THE NAME SHOWN IN THE MARK IDENTIFIES A LIVING INDIVIDUAL WHOSE CONSENT IS OF RECORD. FOR HATS (U.S. CLS. 22 AND 39).
FIRST USE 4-0-1969; IN COMMERCE 4-0-1969.

SN 76-310,551. FREEHAVEN INVESTMENTS LTD., CHARLESTOWN, ST. CHRIST-NEVIS, FILED 9-6-2001.

VASYLI

FOR FOOTWEAR; CLOTHING, NAMELY, SHIRTS, BLOUSES, TIES, PANTS, SWEATPANTS, SHORTS, JACKETS, HATS, VISORS, SOCKS, SWEATERS, SWEATSUITS, COATS, WIND RESISTANT JACKETS AND SCARVES (U.S. CLS. 22 AND 39).

SN 76-314,305. MEYNARD DESIGNS, INC., WALTHAM, MA. FILED 9-19-2001.

EARTH ORIGINS

FOR CLOTHING, NAMELY SOCKS, T-SHIRTS, JEANS, PANTS, CAPS, BELTS, SHIRTS, HATS, SWEATSHIRTS, SWEATERS, JACKETS, COATS AND FOOTWEAR (U.S. CLS. 22 AND 39).

SN 78-011,604. SEATTLE PACIFIC INDUSTRIES, INC., SEATTLE, WA. FILED 6-7-2000.



OWNER OF U.S. REG. NOS. 1,269,860, 1,587,917 AND OTHERS.

THE MARK CONSISTS OF A STEERHEAD DESIGN. FOR CLOTHING, NAMELY, PANTS, SHIRTS, BLOUSES, KNIT TOPS, VESTS, JACKETS, SKIRTS, DRESSES, JEANS, SHORTS AND SWEATERS (U.S. CLS. 22 AND 39).
FIRST USE 1-4-1999; IN COMMERCE 1-4-1999.

CLASS 25—(Continued).

SN 78-013,240. PLAYTEX APPAREL, INC., STAMFORD, CT. FILED 6-19-2000.

B.R.A.

NO CLAIM IS MADE TO THE EXCLUSIVE RIGHT TO USE "BRA", APART FROM THE MARK AS SHOWN. FOR BRAS (U.S. CLS. 22 AND 39).

SN 78-014,246. DFUNC, LLC, SAN FRANCISCO, CA. FILED 6-25-2000.

PORTLAND BREAKERS

FOR CLOTHING, NAMELY SHIRTS, SWEATSHIRTS, SWEATERS, PANTS, SHORTS, AND JACKETS; FOOTWEAR; CAPS AND HATS (U.S. CLS. 22 AND 39).

SN 78-014,254. DFUNC, LLC, SAN FRANCISCO, CA. FILED 6-25-2000.

NEW JERSEY GENERALS

FOR CLOTHING, NAMELY SHIRTS, SWEATSHIRTS, SWEATERS, PANTS, SHORTS, AND JACKETS; FOOTWEAR; CAPS AND HATS (U.S. CLS. 22 AND 39).

SN 78-014,272. DFUNC LLC, SAN FRANCISCO, CA. FILED 6-26-2000.

TULSA ROUGHNECKS

FOR CLOTHING, NAMELY SHIRTS, SWEATSHIRTS, SWEATERS, PANTS, SHORTS, AND JACKETS; FOOTWEAR; CAPS AND HATS (U.S. CLS. 22 AND 39).

SN 78-014,274. DFUNC LLC, SAN FRANCISCO, CA. FILED 6-26-2000.

MIAMI GATOS

FOR CLOTHING, NAMELY SHIRTS, SWEATSHIRTS, SWEATERS, PANTS, SHORTS, AND JACKETS; FOOTWEAR; CAPS AND HATS (U.S. CLS. 22 AND 39).

CLASS 25—(Continued).

SN 78-018,207. FERMAN/PANAMENO, MIGUEL A., LOS ANGELES, CA. AND GARAY, RICHARD E, LOS ANGELES, CA. FILED 7-25-2000.



FOR MEN'S, WOMEN'S AND CHILDREN'S CLOTHING, NAMELY, SWEATSHIRTS, SHIRTS, T-SHIRTS, TANK-TOPS, JEANS, JACKETS, COATS, SHORTS, SWEATPANTS, SLACKS, SUITS, HATS, HEADBANDS, VISORS, CAPS, DRESSES, SHOES, SNEAKERS, AND BOOTS (U.S. CLS. 22 AND 39).

SN 78-022,261. GENERAL MOTORS CORPORATION, DETROIT, MI. FILED 8-22-2000.

PONTIAC

OWNER OF U.S. REG. NOS. 1,708,037, 1,775,048 AND OTHERS.

FOR CLOTHING, NAMELY, JACKETS, JOGGING SUITS, PARKAS, COATS, SWEAT SHIRTS, SWEAT PANTS, BASEBALL SHIRTS, SHORTS, T-SHIRTS, HATS, SHOES, BANDANAS, GLOVES, ROBES, SWEATERS, TIES, SOCKS, APRONS, SHIRTS, BOOTS (U.S. CLS. 22 AND 39).

FIRST USE 9-30-1976; IN COMMERCE 9-30-1976.

SN 78-023,761. VIACOM INTERNATIONAL INC., NEW YORK, NY. FILED 8-30-2000.

RUGRATS DIL'S WORLD

OWNER OF U.S. REG. NOS. 1,741,449, 2,120,059 AND 2,121,831.

FOR BATHING SUITS, BATHROBES, BEACHWEAR, CLOTHING BELTS, SHORTS, JACKETS, COATS, SOCKS, FOOTWEAR, BANDANAS, SWEATERS, HALLOWEEN COSTUMES, DRESSES, GLOVES, GYM SHORTS, EAR MUFFS, NECKWEAR, PAJAMAS, PANTS, SHIRTS, SKI WEAR, SLACKS, SUN VISORS, SUSPENDERS, TURTLE-NECKS, UNDERCLOTHES, VESTS, WARM-UP SUITS, HEADWEAR (U.S. CLS. 22 AND 39).

CLASS 25—(Continued).

SN 78-025,173. BOOT, JEREMY ROBIN, SANTA CRUZ, CA. FILED 9-9-2000.



FOR SHIRTS, PANTS, HATS, CAPS, JACKETS, SWEAT-SHIRTS, SWEAT-PANTS, SHORT-PANTS, T-SHIRTS, SURF-TRUNKS, SWEATERS (U.S. CLS. 22 AND 39).

FIRST USE 5-2-2000; IN COMMERCE 8-22-2000.

SN 78-031,007. SCHWARTZ, DENISE M., SAN DIEGO, CA. FILED 10-17-2000.

GRAPHICS A GO-GO

NO CLAIM IS MADE TO THE EXCLUSIVE RIGHT TO USE "GRAPHICS", APART FROM THE MARK AS SHOWN, FOR WEARING APPAREL, NAMELY, IMPRINTED T-SHIRTS AND SWEATSHIRTS (U.S. CLS. 22 AND 39).

FIRST USE 0-0-2000; IN COMMERCE 0-0-2000.

SN 78-032,562. HEAD PORTER CO., LTD., TOKYO, JAPAN, FILED 10-26-2000.

HEAD PORTER

FOR DRESSES, UNIFORMS, CLOTHING, WORKING CLOTHING, JACKETS, SUITS, SKIRTS, TROUSERS, SMOCKS, FORMAL WEAR, OVERCOATS, TOPCOATS, MANTLES, RAINCOATS, CARDIGANS, SWEATERS, WAISTCOATS, OPEN-NECKED SHIRTS, CUFFS, COLLARS, SPORT SHIRTS, BLOUSES, POLO SHIRTS, WHITE SHIRTS, NIGHTGOWNS, NEGLIGEEES, NIGHT WEAR, PAJAMAS, BATH ROBES, CAMISOLES, CORSETS, COMBINATIONS, UNDERSHIRTS, CHEMISES, DRAWERS, SLIPS, PANTS, BRASSIERES, PETTICOATS, SWIMMING WEAR, SWIMMING CAPS, JAPANESE KIMONOS, APRONS, SOCKS, GAITERS, FUR STOLERS, SHAWLS, SCARVES, GLOVES, CHILDREN'S CLOTH DIAPERS, NECKTIES, NECKERCHIEVES, MUFFLERS, EAR-MUFFLERS, HOODS, SEDGEHATS, NIGHTCAPS, HELMETS, HATS AND CAPS, GARTERS, SOCKS-SUSPENDERS, SUSPENDERS, BANDS, BELTS, BANDANAS, WARMING SUPPORTERS, SHOES, BOOTS, RAIN SHOES, SANDAL SHOES, FIELD SNEAKERS, HALF BOOTS, LADY SHOES, SLIPPERS, ANORAKS, KARATE UNIFORMS, GROUND COATS, KENDO UNIFORMS, JUDO UNIFORMS, SKIING WEAR, HEADBANDS, BASEBALL UNIFORMS AND STOCKINGS, FOOTBALL UNIFORMS AND STOCKINGS, BASKETBALL UNIFORMS AND STOCKINGS, VOLLEYBALL UNIFORMS AND STOCKINGS, HANDBALL UNIFORMS AND STOCKINGS, TENNIS UNIFORMS AND STOCKINGS,

CLASS 25—(Continued).

GOLF UNIFORMS AND STOCKINGS, WRISTBANDS, GOLF SHOES, SOCCER SHOES, SKI BOOTS, GYMNAS-TIC SHOES, TENNIS SHOES, MOUNTAINEERING BOOTS, BASKETBALL SHOES, VOLLEY SHOES, HANDBALL SHOES, BOWLING SHOES, BOXING SHOES, HOCKEY SHOES, BASEBALL SHOES, RUGBY SHOES, ATHLETIC SHOES, ANORAKS, KARATE UNIFORMS, GROUND COATS, KENDO UNIFORMS, JUDO UNI-FORMS, SKIING WEAR, HEADBANDS, BASEBALL UNIFORMS AND STOCKINGS, FOOTBALL UNIFORMS AND STOCKINGS, BASKETBALL UNIFORMS AND STOCKINGS, VOLLEYBALL UNIFORMS AND STOCKINGS, HANDBALL UNIFORMS AND STOCKINGS, TEN-NIS UNIFORMS AND STOCKINGS, GOLF UNIFORMS AND STOCKINGS, WRISTBANDS, GOLF SHOES, SOC-CER SHOES, SKI BOOTS, GYMNAS-TIC SHOES, TENNIS SHOES, MOUNTAINEERING BOOTS, BASKETBALL SHOES, VOLLEY SHOES, HANDBALL SHOES, BOWL-ING SHOES, BOXING SHOES, HOCKEY SHOES, BASE-BALL SHOES, RUGBY SHOES, ATHLETIC SHOES; HORSE RIDING SHOES (U.S. CLS. 22 AND 39).

SN 78-041,329. REVELLI, MATT, SAN FRANCISCO, CA. FILED 1-2-2001.

DJANE

THE NAME "DJANE" THE MARK DOES NOT REFER TO AN INDIVIDUAL.
FOR MEN'S AND WOMEN'S CLOTHING, NAMELY, SHIRTS, SWEATERS, VESTS, SHORTS, PANTS, JACK-ETS, SOCKS, AND HATS (U.S. CLS. 22 AND 39).
FIRST USE 6-1-2000; IN COMMERCE 11-1-2000.

SN 78-043,969. LUMSDEN, JULIUS, NEW YORK, NY. FILED 1-19-2001.

JULIUS LUMSDEN

THE NAME "JULIUS LUMSDEN" IDENTIFIES A LIVING INDIVIDUAL WHOSE CONSENT IS OF RECORD.
FOR COATS, DRESSES, PANTS, TOPS, SWEATERS, AND T-SHIRTS (U.S. CLS. 22 AND 39).

SN 78-045,457. STEPHANIE'S SPECS, CORP., MIAMI, FL. FILED 1-29-2001.



FOR WOMEN'S CLOTHING, NAMELY, PANTS, SHIRTS, AND DRESSES (U.S. CLS. 22 AND 39).
FIRST USE 1-6-2001; IN COMMERCE 1-6-2001.

CLASS 25—(Continued).

SN 78-048,042. NINE WEST DEVELOPEMENT CORP., WIL-MINGTON, DE. FILED 2-13-2001.

NINE & COMPANY

OWNER OF U.S. REG. NOS. 1,724,670, 1,933,092 AND OTHERS.

NO CLAIM IS MADE TO THE EXCLUSIVE RIGHT TO USE "NINE & COMPANY", APART FROM THE MARK AS SHOWN.

FOR WEARING APPAREL FOR WOMEN NAMELY, LEATHER, KNIT AND WOVEN DRESSES, COATS, SUITS, JACKETS, BLOUSES, SHIRTS, SWEATERS, T-SHIRTS, TANK-TOPS, CAMISOLES, CARDIGANS, PULLOVERS, VESTS, PANTS, SHORTS, JEANS, SKIRTS, SCARVES AND HATS (U.S. CLS. 22 AND 39).

SN 78-051,146. SARA LEE CORPORATION, WINSTON-SALEM, NC. FILED 3-2-2001.

**PARA LA MUJER QUE SABE
LO QUE QUIERE. . . HANES
HOSIERY**

OWNER OF U.S. REG. NOS. 1,779,721, 2,065,761 AND OTHERS.

NO CLAIM IS MADE TO THE EXCLUSIVE RIGHT TO USE "HOSIERY", APART FROM THE MARK AS SHOWN.

THE ENGLISH TRANSLATION OF FOREIGN WORDING IN THE MARK IS "FOR THE WOMAN WHO KNOWS WHAT SHE WANTS".

FOR HOSIERY, PANTYHOSE, SOCKS AND KNEE-HIGHS (U.S. CLS. 22 AND 39).

SN 78-051,149. SARA LEE CORPORATION, WINSTON-SALEM, NC. FILED 3-2-2001.

**QUALITY AND STYLE
WITHOUT LIMITS . . .
HANES HOSIERY**

OWNER OF U.S. REG. NOS. 1,779,721, 2,065,761 AND OTHERS.

NO CLAIM IS MADE TO THE EXCLUSIVE RIGHT TO USE "HOSIERY", APART FROM THE MARK AS SHOWN.

FOR HOSIERY, PANTYHOSE, SOCKS AND KNEE-HIGHS (U.S. CLS. 22 AND 39).

CLASS 25—(Continued).

SN 78-055,114. COUTURIER, BRIAN J, LAS VEGAS, NV.
FILED 3-26-2001.

CLASS 25—(Continued).

SN 78-060,534. GAP (APPAREL) INC., SAN BRUNO, CA.
FILED 4-26-2001.

STORM BUSTER

MONSTER
HARDWEAR

FOR CLOTHING, NAMELY JEANS, SHIRTS, T-SHIRTS, FLEECE TOPS, TANK TOPS, SHORTS, PANTS, TROUSERS, KHAKIS, CARGO PANTS, SKIRTS, SWEATERS, JACKETS, COATS, ANORAKS, RAINWEAR, SWEATSHIRTS, SWEATPANTS, DRESSES, BELTS, HATS, SOCKS, GLOVES, VESTS, SCARVES, SHAWLS, SLEEPWEAR, PAJAMAS, NIGHTGOWNS, UNDERWEAR, LINGERIE, ROBES, BRASSIERES, SHAPEWEAR, SPORT BRAS, CAMISOLES, SLIPS, BODYSUITS, BOXER SHORTS, GYM SHORTS, BATHING SUITS, TANKINIS, SWIM TRUNKS, HOSIERY, TIGHTS, LEGGINGS, ROMPERS, OVERALLS, SHORTALLS, TIES, SLIPPERS, SHOES, CAPS, HATS (U.S. CLS. 22 AND 39).

FOR CLOTHING, NAMELY, T-SHIRTS AND TANK TOPS (U.S. CLS. 22 AND 39).

SN 78-069,789. 6TH BORO CLOTHING COMPANY, LLC,
PATERSON, NJ. FILED 6-18-2001.

SN 78-057,169. TIME WARNER ENTERTAINMENT COMPANY, L.P., NEW YORK, NY. FILED 4-6-2001.

6TH BORO**SMASH ZONE**

FOR DESIGNER CLOTHING, NAMELY, SHIRTS, HEADWEAR, PANTS, SHOES, SOCKS AND UNDERWEAR (U.S. CLS. 22 AND 39).

FOR CLOTHING FOR MEN, WOMEN AND CHILDREN - NAMELY, SHIRTS, T-SHIRTS, SWEATSHIRTS, JOGGING SUITS, TROUSERS, PANTS, SHORTS, TANK TOPS, RAINWEAR, CLOTH BIBS, SKIRTS, BLOUSES, DRESSES, SUSPENDERS, SWEATERS, JACKETS, COATS, RAINCOATS, SNOW SUITS, TIES, ROBES, HATS, CAPS, SUNVISORS, BELTS, SCARVES, SLEEPWEAR, PAJAMAS, LINGERIE, UNDERWEAR, BOOTS, SHOES, SNEAKERS, SANDALS, BOOTIES, SLIPPER SOCKS, SWIMWEAR AND MASQUERADE AND HALLOWEEN COSTUMES AND MASKS SOLD IN CONNECTION THEREWITH (U.S. CLS. 22 AND 39).

SN 78-070,941. MAYS, VIVECA A., ALAMEDA, CA. AND
MAYS, MICHAEL O., ALAMEDA, CA. FILED 6-25-2001.

Half Sox

SN 78-059,925. WOOD, CHESTER JAMES, BUENA PARK, CA. AND WOOD, BETTY JANE, BUENA PARK, CA.
FILED 4-23-2001.

BANDITOS

THE ENGLISH TRANSLATION OF THE WORD "BANDITOS" IN THE MARK IS SPANISH FOR "BANDITS".
FOR MULTI-PURPOSE BANDANNAS AND SCARFS (U.S. CLS. 22 AND 39).

NO CLAIM IS MADE TO THE EXCLUSIVE RIGHT TO USE "SOCKS", APART FROM THE MARK AS SHOWN.
FOR SOCKS MADE WITH OR WITHOUT SUPPORT STRAPS THAT WRAP AROUND THE BACK OF YOUR ANKLE (U.S. CLS. 22 AND 39).

CLASS 25—(Continued).

SN 78-072,896. HARRISON, PHILLIP, AMELIA, VA. FILED 7-9-2001.



PARIS DANES

NO CLAIM IS MADE TO THE EXCLUSIVE RIGHT TO USE "PARIS", APART FROM THE MARK AS SHOWN. THE STIPPLING IS FOR SHADING, AND IS NOT AN INDICATION OF COLOR.
FOR CLOTHING, NAMELY, HATS, SOCKS, UNDERWEAR (U.S. CLS. 22 AND 39).

SN 78-073,242. SHEVACK, BRETT, NEW YORK, NY. FILED 7-10-2001.

WHERE YOU FROM?

FOR MEN'S, WOMEN'S AND CHILDREN'S CLOTHING, NAMELY, T-SHIRTS, JACKETS, SHIRTS, SWEATSHIRTS, HATS, CAPS, SWEATPANTS, COATS, SHOES, BOXER SHORTS, UNDERWEAR, SHORTS, SLEEP WEAR, SOCKS, SWEATERS AND NECKTIES (U.S. CLS. 22 AND 39).

SN 78-083,739. KLOTZ, ROBERT J., LAGUNA NIGUEL, CA. FILED 9-13-2001.

ONE SKIN

FOR MENS AND LADIES CLOTHING, NAMELY, SHIRTS, SWEATSHIRTS, JACKETS, VEST, PANTS, SHORTS, SKIRTS, DRESSES, T-SHIRTS, CAPS (U.S. CLS. 22 AND 39).

CLASS 26—FANCY GOODS

SN 76-265,301. BUCILLA CORPORATION, NORCROSS, GA. FILED 5-30-2001.

IN-A-STITCH

FOR STITCHERY KITS, CONSISTING OF A NEEDLE, PATTERNED FABRIC, YARN, AND AN INSTRUCTION SHEET (U.S. CLS. 37, 39, 40, 42 AND 50).

CLASS 26—(Continued).

SN 78-067,285. REVAH ENTERTAINMENT CO., INC., LOS ANGELES, CA. FILED 6-4-2001.

FLAMEHEAD

OWNER OF U.S. REG. NOS. 2,221,316, 2,422,927 AND OTHERS.
FOR HAIR ORNAMENTS, HAIR BARRETTES, HAIR PINS, HAIR RIBBONS, HAIR BOWS, HAIR BUCKLES, HAIR CLIPS, HAIR SCRUNCHIES, AND SHOE LACES (U.S. CLS. 37, 39, 40, 42 AND 50).

CLASS 27—FLOOR COVERINGS

SN 76-099,854. EISENHART WALLCOVERINGS CO., HANOVER, PA. FILED 7-31-2000.

ARCHETYPE

FOR WALLPAPER AND VINYL WALLCOVERINGS (U.S. CLS. 19, 20, 37, 42 AND 50).

SN 76-116,396. DOMCO TARKETT INC., FARNHAM, QUEBEC, CANADA, FILED 8-24-2000.

CORNERSTONE

PRIORITY CLAIMED UNDER SEC. 44(D) ON CANADA APPLICATION NO. 1,060,440, FILED 5-24-2000.
FOR VINYL FLOOR COVERINGS (U.S. CLS. 19, 20, 37, 42 AND 50).

SN 76-164,820. BREWSTER WALLCOVERING COMPANY, RANDOLPH, MA. FILED 11-14-2000.

COMFORTABLE SURROUNDINGS

FOR WALLCOVERINGS MADE OF PAPER, VINYL OR CLOTH (U.S. CLS. 19, 20, 37, 42 AND 50).

SN 76-176,326. LAMINATING SERVICES INC., LOUISVILLE, KY. FILED 12-6-2000.

CIRQA

FOR NON-WOVEN, VINYL, COMMERCIAL WALLCOVERINGS (U.S. CLS. 19, 20, 37, 42 AND 50).

CLASS 27—(Continued).

SN 76-243,179. YORK WALLCOVERINGS, INC., YORK, PA.
FILED 4-19-2001.

RISKY BUSINESS

FOR WALLPAPER (U.S. CLS. 19, 20, 37, 42 AND 50).

SN 76-283,363. MANNINGTON CARPETS, INC., CALHOUN,
GA. FILED 7-12-2001.

SIMPLY PERFORMING

FOR CARPETS (U.S. CLS. 19, 20, 37, 42 AND 50).

SN 76-324,029. SPEED STACKS, INC., ENGLEWOOD, CO.
FILED 10-10-2001.

STACKMAT

FOR MATS FOR ACTION SKILL GAMES (U.S. CLS.
19, 20, 37, 42 AND 50).

SN 78-079,358. MOHAWK BRANDS, INC., WILMINGTON,
DE. FILED 8-15-2001.

**ESSENTIALS BY MOHAWK
HOME**

OWNER OF U.S. REG. NOS. 1,099,660 AND 2,331,148.
FOR CARPET NAMELY RUGS (U.S. CLS. 19, 20, 37, 42
AND 50).

CLASS 28—TOYS AND SPORTING GOODS

SN 75-496,843. QUIKBLADE INC., MARKHAM, ONTARIO
L3R 5E5, CANADA, BY ASSIGNMENT MULTIMATIC
INC., MARKHAM, ONTARIO, FILED 6-5-1998.

QUIKBLADE

PRIORITY CLAIMED UNDER SEC. 44(D) ON CANADA
APPLICATION NO. 087402200, FILED 3-19-1998, REG. NO.
537907, DATED 11-28-2000, EXPIRES 11-28-2015.

FOR SKATES, SKATE BLADES, REPLACEABLE
PARTS FOR SKATES (U.S. CLS. 22, 23, 38 AND 50).

CLASS 28—(Continued).

SN 75-710,757. ALAMEDA FISHING TACKLE COMPANY,
CORPUS CHRISTI, TX. FILED 5-20-1999.

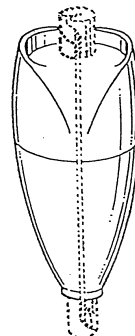

THE MARK CONSISTS OF THE CONFIGURATION OF A
FISHING FLOAT HAVING AN OFF-CENTER LINE ABOUT
ITS CIRCUMFERENCE. THE FLOAT IS GENERALLY
CYLINDRICAL, TAPERED AT THE BOTTOM END TO
SUBSTANTIALLY FORM A CONE, SLIGHTLY TAPERED
AT THE TOP END, AND FORMS A LIP ABOUT A PORTION
OF THE PERIMETER OF THE TOP END, CREATING A
PARTIALLY CONCAVE SURFACE. THE BROKEN LINES
REPRESENT THE TOP AND BOTTOM FISHING LINE
GUIDES, AN INTERNAL BORE WITHIN THE FLOAT,
AND A LENGTHWISE SIDE SLOT FOR HOLDING THE
FISHING LINE IN PLACE, AND ARE NOT CLAIMED AS
PART OF THE MARK.

SEC. 2(F).
FOR FISHING FLOATS AND ATTRACTANTS (U.S.
CLS. 22, 23, 38 AND 50).

FIRST USE 0-0-1958; IN COMMERCE 0-0-1958.

SN 75-722,020. AMERICA'S CUP PROPERTIES, INC., AL-
BANY, NY. FILED 6-4-1999.

AMERICA'S CUP

OWNER OF U.S. REG. NOS. 1,077,615, 2,219,830 AND
OTHERS.

FOR TOYS AND GAMES, NAMELY, SPORTS BALLS,
BATH TOYS, BOARD GAMES, CARD GAMES, WATER
SQUIRTING TOYS, TOY BOATS, MODELS FOR BUILD-
ING BOATS; SPORTING GOODS, NAMELY WATER
SKIS, TOW ROPES, WATER SKI ROPE BRIDGES,
WATER SKI BINDINGS, WATER SKI BRIDLES AND
HARNESSES, WATER SKI CARRYING CASES, WATER
SKI GLOVES, WATER WING SWIM AIDS FOR RECREA-
TIONAL USE, SWIM FLOATS FOR RECREATIONAL
USE, WAKE BOARDS, KNEE BOARDS, SURFBOARDS,
AND TOWABLE INFLATABLE WATER TOYS FOR
AQUATIC RECREATIONAL USE (U.S. CLS. 22, 23, 38
AND 50).

SN 75-788,027. BMC INDUSTRIES, INC., MINNEAPOLIS,
MN. FILED 8-30-1999.

SUNSPORT

FOR SPORT GOGGLES FOR USE IN SNOW SKIING,
WIND SURFING, MOUNTAIN CLIMBING AND OTHER
OUTDOOR ACTIVITIES (U.S. CLS. 22, 23, 38 AND 50).

CLASS 28—(Continued).

SN 75-891,024. LUTHERAN UNIVERSITY ASSOCIATION, INC., THE, VALPARAISO, IN. FILED 1-7-2000.

VALPARAISO CRUSADERS

NO CLAIM IS MADE TO THE EXCLUSIVE RIGHT TO USE "VALPARAISO", APART FROM THE MARK AS SHOWN.

FOR GAMES AND PLAY THINGS, NAMELY, CARD GAMES, BOARD GAMES, AND CHRISTMAS TREE DECORATIONS (U.S. CLS. 22, 23, 38 AND 50).

FIRST USE 7-0-1996; IN COMMERCE 7-0-1996.

SN 75-913,694. GREENWORKS INTERNATIONAL LIMITED, KOWLOON, HONG KONG, BY CHANGE OF NAME STARLITE ENVIRONMENTAL FRIENDLY CENTRE, LTD., KOWLOON, HONG KONG, FILED 2-10-2000.



THE LINING IS A FEATURE OF THE MARK AND DOES NOT INDICATE COLOR.

THE MARK CONTAINS THE WORDS "GREEN" AND "WORKS" IN CAPITAL LETTERS BELOW THE IMAGE OF A TREE WITH LEAVES THAT OBSCURE THE TREE BRANCHES. SURROUNDING THE TREE AND THE WORDS IS THE IMAGE OF A PRODUCT TAG WITH A PIECE OF STRING LOOPED THROUGH THE GROMMIT HOLE.

FOR GAMES AND PLAYTHINGS, NAMELY, PLAYSETS FOR TOY PAINTINGS, AND TOY ARTS AND CRAFTS, PLAYSETS FOR CHRISTMAS ORNAMENTS, PLAYSETS FOR TOY MASKS, PLAYSETS FOR CHRISTMAS TREES, PLAYSETS FOR TOY PICTURE FRAMES, PLAYSETS FOR HALLOWEEN; PAPER FACE MASKS; DECORATIONS FOR CHRISTMAS TREES; CHRISTMAS TREE ORNAMENTS; PLAYSETS FOR TOY WALL DECORATIONS; PLAYSETS FOR TOY MOBILES; AND PLAYSETS FOR TOY CLOCKS (U.S. CLS. 22, 23, 38 AND 50).

SN 75-960,305. TOY VAULT, INC., PLAYA DEL REY, CA. FILED 3-15-2000.

TOY VAULT

NO CLAIM IS MADE TO THE EXCLUSIVE RIGHT TO USE "TOY", APART FROM THE MARK AS SHOWN.

FOR TOY ACTION FIGURES, COLLECTIBLE TOY FIGURES, POSITIONAL TOY FIGURES (U.S. CLS. 22, 23, 38 AND 50).

FIRST USE 5-15-1998; IN COMMERCE 5-31-1998.

CLASS 28—(Continued).

SN 76-036,538. SPORTS INNOVATIONS, INC., BOULDER, CO. FILED 4-28-2000.



THE BORDER OF THE MARK AND THE WORDS "WATER BUGS" ARE LINED FOR A RELATIVE DEEP BLUE, THE BACK GROUND BEHIND THE DESIGN IS LINED TO FADE FROM A MEDIUM TO LIGHT BLUE, THE BACKGROUND BELOW THE DESIGN IS LINED FOR A MEDIUM BLUE, THE FACE OF THE DESIGN IS LINED FOR GOLD WITH A GREEN BODY, AND THE FEET AND ANTENNAE OF THE DESIGN ARE LINED FOR ORANGE.

FOR SWIM AND FISHING FLOATS FOR RECREATIONAL USE (U.S. CLS. 22, 23, 38 AND 50).

SN 76-044,293. CARTOON NETWORK LP, LLLP, THE, ATLANTA, GA. FILED 5-9-2000.



FOR TOYS AND SPORTING GOODS, NAMELY, PLUSH DOLLS, VINYL DOLLS, RAG DOLLS, ACTION FIGURES AND ACCESSORIES THEREFOR, PLAY KITCHEN AND COOKWARE, WIND-UP, PULL BACK AND FRICTION POWERED TOYS, TOY FIGURES, PLASTIC TOY VEHICLES, KITES, PLAYGROUND AND SPORTS BALLS, BASEBALL BATS, GOLF CLUBS, FISHING RODS AND REELS, SANDBOX TOY PAILS, RING TOSS GAMES, HORSE SHOES FOR RECREATIONAL PURPOSES, PADDLE BALL, BADMINTON SETS, PLAY BOWLING SETS, RIDE-ON TOYS, TOY PEDAL CARS, SWIM AIDS, NAMELY, POOL RINGS FOR RECREATIONAL USE, SURF BOARDS, PLAY HOUSES, PLASTIC INFLATED BOP BAGS, BOARD GAMES, SKIN DIVING MASKS AND SWIM FINS, FLOATING ACTION SKILL GAMES FOR USE IN WATER, FLOATING ACTION TARGET GAMES FOR USE IN WATER, JIGSAW PUZZLES, CHESS SETS, HAND-HELD ELECTRONIC GAMES, THROW TARGET GAMES, CHILDREN'S THREE-DIMENSIONAL VIEWERS AND PROJECTORS AND CHRISTMAS TREE ORNAMENTS (U.S. CLS. 22, 23, 38 AND 50).

CLASS 28—(Continued).

SN 76-053,308. TAG TOYS, INC., COMPTON, CA. FILED 5-18-2000.

TAG THINK & GROW

FOR BABY'S AND CHILDREN'S MULTIPLE ACTIVITY TOYS DESIGNED TO STIMULATE IMAGINATION AND LEARNING ABILITY (U.S. CLS. 22, 23, 38 AND 50). FIRST USE 0-0-1985; IN COMMERCE 0-0-1985.

SN 76-080,751. NORMARK CORPORATION, MINNETONKA, MN. FILED 6-29-2000.

TAIL DANCER

FOR ARTIFICIAL FISHING LURES (U.S. CLS. 22, 23, 38 AND 50).

SN 76-083,887. TIME WARNER ENTERTAINMENT COMPANY, L.P., NEW YORK, NY. FILED 7-6-2000.

GOLDEN SNITCH

FOR ELECTRONIC HAND-HELD GAME UNIT; GAME EQUIPMENT SOLD AS A UNIT FOR PLAYING A BOARD GAME, A CARD GAME, A MANIPULATIVE GAME, A PARLOR GAME AND AN ACTION TYPE TARGET GAME; STAND ALONE VIDEO OUTPUT GAME MACHINES; JIGSAW AND MANIPULATIVE PUZZLES; PAPER FACE MASKS; SKATEBOARDS; ICE SKATES; WATER SQUIRTING TOYS; BALLS - NAMELY, PLAYGROUND BALLS, SOCCER BALLS, BASEBALLS, BASKETBALLS; BASEBALL GLOVES; SWIMMING FLOATS FOR RECREATIONAL USE; KICKBOARD FLOTATION DEVICES FOR RECREATIONAL USE; SURFBOARDS; SWIM BOARDS FOR RECREATIONAL USE; SWIM FINS; TOY BAKEWARE AND TOY COOKWARE; TOY BANKS; AND CHRISTMAS TREE ORNAMENTS (U.S. CLS. 22, 23, 38 AND 50).

SN 76-099,122. MISSIONSIX LLC., MAMMOTH LAKES, CA. FILED 7-28-2000.

MISSIONSIX

FOR SNOWBOARDS, SNOWBOARD BINDINGS, AND SNOWBOARD BAGS (U.S. CLS. 22, 23, 38 AND 50).

SN 76-102,693. ANGEL OF MY OWN, LLC, ST. CHARLES, MO. FILED 8-3-2000.

ANGEL OF MY OWN

FOR PLUSH TOYS, BOARD GAMES, TOY FIGURES AND PLUSH TOY PILLOW CARRYING CASES USED AS ACCESSORIES WITH PLUSH TOYS (U.S. CLS. 22, 23, 38 AND 50).

CLASS 28—(Continued).

SN 76-106,543. PEARSON TELEVISION OPERATIONS BV, HILVERSUM, NETHERLANDS, FILED 8-9-2000.

PRICE IS RIGHT

FOR TARGET GAMES, BOARD GAMES AND CARD GAMES; KITES; TOY ACTION FIGURES; DISC-TYPE TOSS TOYS; BOWS AND ARROWS; PLAYGROUND BALLS; DOLLS, DOLL PLAYSETS, PLUSH TOYS; TOY VEHICLES, TOY CARS, TOY TRUCKS, TOY BUCKET AND SHOVEL SETS, ROLLER SKATES, TOY MODEL HOBBYCRAFT KITS, TOY ROCKETTS, TOY GUNS, TOY HOLSTERS, MUSICAL TOYS, JIGSAW PUZZLES, BADMINTON SETS, BUBBLE MAKING WANDS AND SOLUTION SETS, TOY FIGURINES, TOY BANKS, PUPPETS, TOY BALLOONS, YO-YOS, SKATEBOARDS, SCOOTERS, PAPER FACE MASKS AND COSTUME FACE MASKS, VIDEO AND LCD GAME MACHINES, AND COMPUTER GAME EQUIPMENT CONTAINING MEMORY DEVICES, NAMELY, DISCS (U.S. CLS. 22, 23, 38 AND 50).

SN 76-106,871. SHIMANO INC., SAKAI, OSAKA, 590-8577, JAPAN, FILED 8-10-2000.

P.W.D.S.

PROPER WEIGHT DISTRIBUTION SYSTEM

NO CLAIM IS MADE TO THE EXCLUSIVE RIGHT TO USE "PROPER WEIGHT DISTRIBUTION SYSTEM", APART FROM THE MARK AS SHOWN.

FOR GOLF CLUBS, GOLF BALLS, GOLF BAGS, HEAD COVERS OF GOLF CLUBS (U.S. CLS. 22, 23, 38 AND 50).

SN 76-120,479. BABY EINSTEIN COMPANY, LLC, THE, LITTLETON, CO. FILED 8-31-2000.

GREAT MINDS START LITTLE

FOR GAMES, PLAYTHINGS AND TOYS FOR CHILDREN, NAMELY PUPPETS, PLUSH TOYS, PULL TOYS, CRIB TOYS, ELECTRONIC ACTION TOYS, BOARD GAMES, HAND-HELD ELECTRONIC GAMES, ROLE-PLAYING GAMES, AND MUSIC, ART, LANGUAGE, POETRY, MATH AND SCIENCE MULTIPLE-ACTIVITY TOYS (U.S. CLS. 22, 23, 38 AND 50).

SN 76-137,991. THINKING TECHNOLOGY INC., NASSAU, BAHAMAS, FILED 9-29-2000.

'N STYLE GIRLS

FOR DOLLS, DOLL CLOTHING AND DOLL ACCESSORIES, AND PLAY SETS FOR DOLLS (U.S. CLS. 22, 23, 38 AND 50).

CLASS 28—(Continued).

SN 76-137,992. THINKING TECHNOLOGY INC., NASSAU, BAHAMAS, FILED 9-29-2000.

'N STYLE COLLECTION

NO CLAIM IS MADE TO THE EXCLUSIVE RIGHT TO USE "COLLECTION", APART FROM THE MARK AS SHOWN.

FOR DOLLS, DOLL CLOTHING AND DOLL ACCESSORIES, AND PLAY SETS FOR DOLLS (U.S. CLS. 22, 23, 38 AND 50).



SN 76-148,920. DAN-DEE INTERNATIONAL, LTD, JERSEY CITY, NJ. FILED 10-18-2000.

SANTA'S ATTIC

NO CLAIM IS MADE TO THE EXCLUSIVE RIGHT TO USE "SANTA'S", APART FROM THE MARK AS SHOWN.

FOR STUFFED TOYS; TOY FIGURINES; PORCELAIN DOLLS; TABLETOP AND WALL DECORATIONS; HOLIDAY ORNAMENTS, NAMELY, DECORATIVE FIGURINES; PLAQUES (U.S. CLS. 22, 23, 38 AND 50).



SN 76-155,034. ORION ELECTRONICS, INC., GARDENA, CA. FILED 10-27-2000.

SLIM HOOP

NO CLAIM IS MADE TO THE EXCLUSIVE RIGHT TO USE "HOOP", APART FROM THE MARK AS SHOWN.

FOR PLASTIC EXERCISE AND TOY HOOPS (U.S. CLS. 22, 23, 38 AND 50).

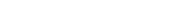

SN 76-155,533. WRIGHT & MCGILL CO., DENVER, CO. FILED 10-27-2000.



THE PORTRAIT IN THE MARK IDENTIFIES AN INDIVIDUAL WHOSE CONSENT IS OF RECORD.
FOR FISHING HOOKS (U.S. CLS. 22, 23, 38 AND 50).
FIRST USE 0-0-1953; IN COMMERCE 0-0-1953.

CLASS 28—(Continued).

SN 76-158,270. M & C TOY CENTRE LTD., KOWLOON, HONG KONG, FILED 11-2-2000.

ASSAULT COMMANDO

FOR TOYS, TOY ACTION FIGURES, DOLLS, TOY GUNS, TOY ARMOUR, TOY WEAPONS, DOLL COSTUMES, INFLATABLE TOY RAFTS, TOY WALKIE TALKIES, TOY SWORDS, TOY BINOCULARS NOT OF CAPABLE OF MAGNIFICATION, TOY DAGGER; THREE-DIMENSIONAL PLAYSETS DEPICTING SCENES AND SCENERY; PLAYSETS COMPRISING ONE OR MORE OF THE FOREGOING ITEMS; TOY SUBMARINE, TOY VEHICLES (U.S. CLS. 22, 23, 38 AND 50).

FIRST USE 12-30-2000; IN COMMERCE 3-4-2001.



SN 76-163,094. THINKING TECHNOLOGY INC., NASSAU, BAHAMAS, FILED 11-9-2000.

STYLE GIRLS

FOR DOLLS, DOLL CLOTHING AND DOLL ACCESSORIES, AND PLAY SETS FOR DOLLS (U.S. CLS. 22, 23, 38 AND 50).



SN 76-176,753. SHIMANO INC., SAKAI, OSAKA, JAPAN, FILED 12-6-2000.

ULTEGRA

OWNER OF U.S. REG. NO. 1,623,540.
FOR GOLF GOODS, NAMELY, GOLF CLUBS, GOLF BALLS, GOLF BAGS, HEAD COVERS OF GOLF CLUBS (U.S. CLS. 22, 23, 38 AND 50).



SN 76-178,992. SALCO ENTERPRISES, LLC, COLUMBUS, GA. FILED 12-11-2000.

SALCO

FOR FISHING EQUIPMENT, NAMELY, RODS AND REELS, LURES, SCENT SPRAY, SOFT AND HARD BAIT, FISHING CONTAINERS (U.S. CLS. 22, 23, 38 AND 50).

FIRST USE 6-0-1999; IN COMMERCE 6-0-1999.

CLASS 28—(Continued).

SN 76-178,999. COBRA KING INDUSTRY CO., LTD., YUN LIN HSIEN, TAIWAN, FILED 12-11-2000.

ROTOGLO

FOR NON-MOTORIZED SCOOTERS; AND PARTS AND ACCESSORIES THEREFOR, NAMELY, WHEELS, HANDLEBARS, PEDALS, BRACKETS, FRONT FORK TUBES; IN-LINE SKATES; ROLLER SKATES; ICE SKATES; SNOW SLEDGES; SNOWSHOES; SKI STICKS; SKIING BOARDS; SPORTS AND EXERCISE PROTECTORS; SURF BOARDS; STATIONARY BICYCLES; EXERCISE TREADMILLS (U.S. CLS. 22, 23, 38 AND 50).

SN 76-186,435. TOPPER SUPPLY CO., COLUMBUS, OH. FILED 12-27-2000.

PRO BANDS

NO CLAIM IS MADE TO THE EXCLUSIVE RIGHT TO USE "BANDS", APART FROM THE MARK AS SHOWN.
FOR ELASTIC BANDS USED IN WEIGHT AND POWER LIFTING (U.S. CLS. 22, 23, 38 AND 50).
FIRST USE 12-5-2000; IN COMMERCE 12-5-2000.

SN 76-192,737. HASBRO, INC., PAWTUCKET, RI. FILED 1-12-2001.

PAT PENGUIN'S FISHY BUSINESS

FOR EQUIPMENT SOLD AS A UNIT FOR PLAYING A PARLOR GAME (U.S. CLS. 22, 23, 38 AND 50).

SN 76-197,387. YOMEGA CORP., FALL RIVER, MA. FILED 1-23-2001.

POP-SCOTCH

FOR HOPSCOTCH ACTION SKILL GAMES THAT USE MARKERS SHAPED LIKE BOTTLE CAPS (U.S. CLS. 22, 23, 38 AND 50).

CLASS 28—(Continued).

SN 76-209,513. ST. LOUIS CARDINALS, L.P., ST. LOUIS, MO. FILED 2-12-2001.



OWNER OF U.S. REG. NOS. 841,051, 1,646,801 AND OTHERS.

FOR TOYS AND SPORTING GOODS, NAMELY, STUFFED TOYS, PLUSH TOYS, BEAN BAG TOYS, BEAN BAGS, CHECKER SETS, BOARD GAMES, DART BOARDS AND DART BOARD ACCESSORIES, TOY CARS AND TRUCKS, BALLOONS, PUZZLES, TOY BASEBALL BATS, INFLATABLE BASEBALL BATS, DECORATIVE WIND SOCKS, MINIATURE BATS, BASEBALLS AND BASEBALL HOLDERS, AUTOGRAPHED BASEBALLS, PLAYGROUND BALLS, RUBBER ACTION BALLS, BASKETBALLS, GOLF BALLS, GOLF CLUB COVERS, GOLF CLUB BAGS, GOLF PUTTERS, BASEBALL BATS, CATCHER'S MASKS, MITTS, PARTY FAVORS IN THE NATURE OF NOISE MAKERS, AND CHRISTMAS TREE ORNAMENTS (U.S. CLS. 22, 23, 38 AND 50).

FIRST USE 11-15-1997; IN COMMERCE 11-15-1997.

SN 76-218,192. FITNESS QUEST INC., CANTON, OH. FILED 3-2-2001.

EDGE CARDIO

FOR MANUALLY OPERATED EXERCISE EQUIPMENT (U.S. CLS. 22, 23, 38 AND 50).

SN 76-225,028. JEREMIAH GROUP, LTD., THE, WHITE LAKE, MI. BY ASSIGNMENT DAVIS, GLEN, WHITE LAKE, MI. FILED 3-14-2001.

SKIPNROCKS

FOR WATER SKIPPING PROJECTILE TOYS (U.S. CLS. 22, 23, 38 AND 50).

CLASS 28—(Continued).

SN 76-238,201. HASBRO, INC., PAWTUCKET, RI. FILED 4-11-2001.

POCKET PAWS

NO CLAIM IS MADE TO THE EXCLUSIVE RIGHT TO USE "POCKET", APART FROM THE MARK AS SHOWN. FOR INTERACTIVE PLUSH TOYS AND ACCESSORIES FOR USE THEREWITH (U.S. CLS. 22, 23, 38 AND 50).

SN 76-240,413. JILLMERICA, LLC, PHOENIX, AZ. FILED 4-14-2001.

BLARNEY STONED

FOR ACTION FIGURES, BATH TOYS, BENDABLE TOYS, CHRISTMAS TREE ORNAMENTS, COSTUME MASKS, DOLLS, KITES, PLUSH TOYS, PARTY FAVORS IN NATURE OF SMALL TOYS, PORCELAIN DOLLS, SOFT SCULPTURE DOLLS, SQUEEZE TOYS, AND TOY BANKS, WIND-UP TOYS; ACTION FIGURE, DOLL, AND PLUSH TOY CLOTHING; DOLL HOUSES, SETS, STAGES, DOLL HOUSE FURNISHINGS, AND CARRYING CASES, ALL FOR DOLLS AND PLUSH TOYS; AND BOARD GAMES AND HAND HELD UNITS FOR PLAYING BOTH ELECTRONIC GAMES AND VIDEO GAMES (U.S. CLS. 22, 23, 38 AND 50).

SN 76-243,753. HASBRO, INC., PAWTUCKET, RI. FILED 4-23-2001.

CROCKEY HOCKEY

NO CLAIM IS MADE TO THE EXCLUSIVE RIGHT TO USE "HOCKEY", APART FROM THE MARK AS SHOWN. FOR EQUIPMENT SOLD AS A UNIT FOR PLAYING A PARLOR GAME (U.S. CLS. 22, 23, 38 AND 50).

SN 76-248,113. HEAVYHANDS FLORIDA, INC., WEST PALM BEACH, FL. FILED 4-27-2001.

LONGSTRENGTH

FOR EXERCISE MACHINES AND EXERCISE WEIGHTS (U.S. CLS. 22, 23, 38 AND 50).

SN 76-255,119. NOBREGA, ROD A., SR., HYANNIS, MA. FILED 5-9-2001.

SO, YOU THINK YOU KNOW BOSTON?

FOR TRIVIA CARDS RELATING TO BOSTON (U.S. CLS. 22, 23, 38 AND 50).

CLASS 28—(Continued).

SN 76-256,946. NINTENDO OF AMERICA INC., REDMOND, WA. FILED 5-15-2001.

PIKMIN

FOR ACTION SKILL GAMES; ARTICULATED AND NON-ARTICULATED DOLLS; BATH TOYS; BOARD GAMES; CARD GAMES; CHILDREN'S PLAY COSMETICS; CHRISTMAS TREE ORNAMENTS; COSTUME MASKS; ELECTRONIC GAME EQUIPMENT WITH A WATCH FUNCTION; FLOATING RECREATIONAL LOUNGE CHAIRS, INFLATABLE FLOAT MATTRESSES AND PADS FOR RECREATIONAL USE; GOLF BALLS; HAND-HELD PINBALL GAMES; HAND-HELD UNIT FOR PLAYING ELECTRONIC GAMES IN THE NATURE OF A VIRTUAL PET; HAND-HELD UNIT FOR PLAYING ELECTRONIC GAMES; HAND-HELD UNIT FOR PLAYING VIDEO GAMES; HAND-HELD VIDEO GAME SYSTEMS, COMPRISING HAND-HELD UNITS FOR PLAYING VIDEO GAMES AND ASSOCIATED GAME CARTRIDGES SOLD AS A UNIT; INFLATABLE TOYS; IN-LINE SKATES; JIGSAW PUZZLES; JUMP ROPES; KITES; MANIPULATIVE PUZZLES; MUSIC BOX TOYS; NONELECTRIC HAND-HELD ACTION SKILL GAMES; PAPER DOLLS; PARLOR GAMES; PLUSH DOLLS; POSITIONABLE TOY FIGURES; PROMOTIONAL GAME CARDS; PUPPETS; RIDE-ON TOYS; ROLE PLAYING GAMES; ROLLER SKATES; RUBBER ACTION BALLS; SKATEBOARDS; SNOW BOARDS; SNOW SKIS; SPORTS BALLS; STAND ALONE VIDEO GAME MACHINES; STUFFED TOYS; TOY ACTION BALLS; TOY ACTION FIGURES; TOY BAKEWARE AND COOKWARE; TOY BALLOONS; TOY BANKS; TOY BINOCULARS; TOY BUILDING BLOCKS; TOY CAP PISTOLS; TOY CARRYING CASES; TOY CONSTRUCTION PLAYSETS; TOY DECORATIVE WIND SOCKS; TOY KEY CHAINS WITH AND WITHOUT SOUND DEVICE; TOY MOBILES; TOY MUSICAL INSTRUMENTS; TOY PUNCHING BAGS; TOY TEA SETS; TOY VEHICLES; TOY WHISTLES; WATER SQUIRTING TOYS; WIND-UP TOYS; YO-YOS (U.S. CLS. 22, 23, 38 AND 50).

SN 76-257,608. BOSWORTH, CHRISTINE, PACIFIC PALISADES, CA. FILED 5-16-2001.

TIME PIECE

FOR BOARD GAMES, JIGSAW AND GEOMETRIC PUZZLES, AND EDUCATIONAL BOARD GAMES (U.S. CLS. 22, 23, 38 AND 50).

SN 76-257,769. LITTLE KIDS, INC., PROVIDENCE, RI. FILED 5-16-2001.

WACKY WANDS

NO CLAIM IS MADE TO THE EXCLUSIVE RIGHT TO USE "WANDS", APART FROM THE MARK AS SHOWN. FOR TOY BUBBLE WANDS (U.S. CLS. 22, 23, 38 AND 50).

CLASS 28—(Continued).

SN 76-261,650. NATIONAL HOCKEY LEAGUE, NEW YORK, NY. FILED 5-23-2001.

NHL HOCKEY RULES

FOR ACTION FIGURES, BALLOONS, BOBBLE HEAD DOLLS, CHEERLEADING POMPOMS, CHRISTMAS TREE ORNAMENTS; DOLLS; ELBOW PADS FOR ATHLETIC USE; FLYING DISKS, GOALIE FACE MASKS FOR STREET, FIELD, ROLLER, IN-LINE, AND ICE HOCKEY; GOLF BAGS; HANDHELD UNITS FOR PLAYING ELECTRONIC GAMES; HEAD COVERS FOR GOLF CLUBS; FIELD, STREET, IN LINE AND ROLLER HOCKEY BALLS; HOCKEY GLOVES; HOCKEY PUCKS; HOCKEY STICKS; ICE SKATE BLADE COVERS AND ICE SKATE BLADE GUARDS; ICE SKATES; IN-LINE AND CONVENTIONAL ROLLER SKATES; JIGSAW AND OTHER MANIPULATIVE PUZZLES; BOARD GAMES, KNEE PADS FOR ATHLETIC USE; NOVELTY MINIATURE GOALIE MASKS FOR STREET, FIELD, ROLLER, IN-LINE, AND ICE HOCKEY; NOVELTY GOLF BALLS; PLASTIC AND WOOD GOALIE STICKS FOR STREET, FIELD, ROLLER, IN-LINE, AND ICE HOCKEY; PLASTIC TOY CANTEENS; PLUSH ANIMAL TOYS; POOL CUES; PUPPETS; SHIN PADS FOR ATHLETIC USE; SUCTION CUP STUFFED TOY ANIMALS; SUCTION CUP TOY HOCKEY PUCKS; TABLETOP HOCKEY GAMES USING A ROD TO MOVE THE HOCKEY GAME PLAYERS; TOY TRUCKS; AND YO-YOS (U.S. CLS. 22, 23, 38 AND 50).

SN 76-267,651. SHARPER IMAGE CORPORATION, SAN FRANCISCO, CA. FILED 6-6-2001.

ROBOCUB

FOR TOY ROBOT (U.S. CLS. 22, 23, 38 AND 50).

SN 76-269,683. LITTLE KIDS, INC., PROVIDENCE, RI. FILED 6-11-2001.

QUICK DIP BUBBLE BLOWER

NO CLAIM IS MADE TO THE EXCLUSIVE RIGHT TO USE "BUBBLE BLOWER", APART FROM THE MARK AS SHOWN.

FOR BUBBLE BLOWING WANDS AND BUBBLE BLOWING WAND AND SOLUTION SETS (U.S. CLS. 22, 23, 38 AND 50).

SN 76-269,772. BALLISTIC ARCHERY, INC., STOCKTON, NJ. FILED 6-11-2001.

HELLFIRE

FOR ARCHERY EQUIPMENT, NAMELY, ARCHERY BROADHEADS (U.S. CLS. 22, 23, 38 AND 50). FIRST USE 2-8-2001; IN COMMERCE 2-8-2001.

CLASS 28—(Continued).

SN 76-272,908. DGE CORPORATION, ENGLEWOOD, NJ. FILED 6-15-2001.

MY FIRST PUPPY

NO CLAIM IS MADE TO THE EXCLUSIVE RIGHT TO USE "PUPPY", APART FROM THE MARK AS SHOWN. FOR PLUSH TOYS (U.S. CLS. 22, 23, 38 AND 50). FIRST USE 9-28-1998; IN COMMERCE 9-28-1998.

SN 76-273,248. KNIGHT MANUFACTURING CO., INC., DBA CREME LURE CO., TYLER, TX. FILED 6-19-2001.

FISH TICKLER

NO CLAIM IS MADE TO THE EXCLUSIVE RIGHT TO USE "FISH", APART FROM THE MARK AS SHOWN. FOR FISHING TACKLE (U.S. CLS. 22, 23, 38 AND 50). FIRST USE 5-14-2001; IN COMMERCE 5-14-2001.

SN 76-273,726. RADIO CITY TRADEMARKS, LLC, NEW YORK, NY. FILED 6-18-2001.

RADIO CITY ROCKETTES

OWNER OF U.S. REG. NOS. 1,223,250, 2,147,635 AND OTHERS. FOR DOLLS (U.S. CLS. 22, 23, 38 AND 50). FIRST USE 0-0-1996; IN COMMERCE 0-0-1996.

SN 76-275,864. BETTA PRODUCTS, INC., HEALDSBURG, CA. FILED 6-20-2001.

GLO FUN

FOR TOYS, NAMELY, CHEMICAL FILLED TUBES THAT GLOW IN THE DARK (U.S. CLS. 22, 23, 38 AND 50).

SN 76-275,890. KIDS FOUNDATION, BEL AIR, CA. FILED 6-22-2001.

HAPPINESS HAPPENS THROUGH MY NOSE

FOR TOYS, NAMELY, ACTION SKILL GAMES, ACTION FIGURES, PLUSH TOYS, DOLLS AND ACCESSORIES THEREFOR, PLAY FIGURES, BOARD GAMES, CARD GAMES, PARLOR GAMES, MUSICAL TOYS, TOY NOISEMAKERS, JIGSAW PUZZLES, MANIPULATIVE PUZZLES, STUFFED TOYS, WIND-UP TOYS, AND YO-YOS; TOYS, NAMELY, BATTERY-POWERED COMPUTER GAMES WITH LCD SCREEN THAT FEATURE ANIMATION AND SOUND EFFECTS (U.S. CLS. 22, 23, 38 AND 50).

CLASS 28—(Continued).

SN 76-275,891. KIDS FOUNDATION, BEL AIR, CA. FILED 6-22-2001.

HAPPINESS HAPPENS THROUGH MY HANDS

FOR TOYS, NAMELY, ACTION SKILL GAMES, ACTION FIGURES, PLUSH TOYS, DOLLS AND ACCESSORIES THEREFOR, PLAY FIGURES, BOARD GAMES, CARD GAMES, PARLOR GAMES, MUSICAL TOYS, TOY NOISEMAKERS, JIGSAW PUZZLES, MANIPULATIVE PUZZLES, STUFFED TOYS, WIND-UP TOYS, AND YO-YOS; TOYS, NAMELY, BATTERY-POWERED COMPUTER GAMES WITH LCD SCREEN THAT FEATURE ANIMATION AND SOUND EFFECTS (U.S. CLS. 22, 23, 38 AND 50).

SN 76-287,150. IMATOH, YASUYUKI, TOKYO, JAPAN, FILED 7-19-2001.

IMATONIC ARM

FOR PITCHING PRACTICE APPARATUS FOR ENABLING BASEBALL PITCHERS AND FIELDERS TO HEALTHFULLY AND COMFORTABLY ACQUIRE IDEAL THROWING FORM WHEN PLAYING BASEBALL (U.S. CLS. 22, 23, 38 AND 50).

SN 76-288,735. BIMINI BAY OUTFITTERS, LTD., MAHWAH, NJ. FILED 7-20-2001.

TUFF TIP

NO CLAIM IS MADE TO THE EXCLUSIVE RIGHT TO USE "TIP", APART FROM THE MARK AS SHOWN.

FOR FISHING PRODUCTS, NAMELY, RODS, REELS, LURES, FISHING LINE, TERMINAL TACKLE, TACKLE BAGS AND TACKLE BOXES (U.S. CLS. 22, 23, 38 AND 50).

SN 76-302,295. MERRY THE CRANBERRY, L.L.C., PHOENIX, AZ. FILED 8-21-2001.

MERRY THE CRANBERRY

FOR DOLLS AND ACTION FIGURES (U.S. CLS. 22, 23, 38 AND 50).

CLASS 28—(Continued).

SN 76-302,975. ANACONDA SPORTS, INC., LAKE KATRINE, NY. FILED 8-21-2001.

SPECIAL DAY BASEBALLS

OWNER OF U.S. REG. NO. 2,453,279.
NO CLAIM IS MADE TO THE EXCLUSIVE RIGHT TO USE "BASEBALLS", APART FROM THE MARK AS SHOWN.
FOR PERSONALIZED BASEBALLS (U.S. CLS. 22, 23, 38 AND 50).

FIRST USE 3-1-1999; IN COMMERCE 3-1-1999.

SN 76-303,363. GARTLAND, WILLIAM, YOUNGSTOWN, OH. FILED 8-22-2001.

WHITE TAILS

FOR ARCHERY PRODUCTS, NAMELY ARROWS, ARROW POINTS, ARROW COMPONENTS, AND ARCHERY ACCESSORIES, NAMELY ARM GUARDS, ARROW FLETCHING DEVICES, BOW CASES, QUIVERS, BAGS, BACKPACKS, FANNY PACKS, FINGER TABS, AND ARCHERY STRINGERS (U.S. CLS. 22, 23, 38 AND 50).

SN 76-306,536. ELLIS, ROBERT GARY, TOPANGA, CA. FILED 8-28-2001.

YOBABY

FOR SKATEBOARDS WITH WHEELS, AND SKATEBOARDS WITHOUT WHEELS (U.S. CLS. 22, 23, 38 AND 50).

SN 76-306,537. ELLIS, ROBERT GARY, TOPANGA, CA. FILED 8-28-2001.

YOKID

FOR SKATEBOARDS WITH WHEELS, AND SKATEBOARDS WITHOUT WHEELS (U.S. CLS. 22, 23, 38 AND 50).

SN 76-307,834. ALPHA INTERNATIONAL, INC., CEDAR RAPIDS, IA. FILED 9-4-2001.

THE WORLD KNOWS NO BETTER QUALITY

FOR COLLECTIBLES, NAMELY SCALE TOY REPLICAS OF AIRCRAFT, CARS, TRUCKS, FARM TRACTORS, FARM IMPLEMENTS AND CANNED GOODS; TOYS, NAMELY PLAY FIGURINES, AIRCRAFT, CARS, TRUCKS AND DOLLS (U.S. CLS. 22, 23, 38 AND 50).

CLASS 28—(Continued).

SN 76-308,264. DSI TOYS, INC., HOUSTON, TX. FILED 8-30-2001.

JAYLA

FOR TOYS, NAMELY, DOLLS, DOLL CLOTHING, AND DOLL ACCESSORIES (U.S. CLS. 22, 23, 38 AND 50).

SN 78-000,566. HSD ENTERPRISES, INC., BURR RIDGE, IL. FILED 3-22-2000.

PAWDLERS

FOR DOLLS, PAPER DOLLS, DOLL CLOTHING, AND DOLL ACCESSORIES; TOYS, NAMELY, STUFFED TOY ANIMALS AND CLOTHING AND ACCESSORIES FOR STUFFED TOY ANIMALS; CHILDREN'S GAMES, NAMELY BOARD GAMES, CARD GAMES, ACTION SKILL GAMES, CHILDREN'S PARTY GAMES, AERODYNAMIC DISK FOR USE IN PLAYING CATCHING GAMES, BALL GAMES, HUNTING GAME CALLS, TARGET GAMES (U.S. CLS. 22, 23, 38 AND 50).

SN 78-017,204. SAFE SITTER, INC., INDIANAPOLIS, IN. FILED 7-18-2000.

SAFE SITTER

OWNER OF U.S. REG. NO. 1,499,952.
FOR DOLLS AND DOLL ACCESSORIES (U.S. CLS. 22, 23, 38 AND 50).

SN 78-019,076. LOVSTAD, ERIC T., PHOENIX, AZ. FILED 7-31-2000.

RIVERFARM

FOR TOYS, NAMELY MINIATURE REPLICAS OF FARMING TOOLS AND EQUIPMENT (U.S. CLS. 22, 23, 38 AND 50).

SN 78-030,769. MATTEL, INC., EL SEGUNDO, CA. FILED 10-16-2000.

SUPER SCOOTER SHANNEN

OWNER OF U.S. REG. NO. 2,413,049.
NO CLAIM IS MADE TO THE EXCLUSIVE RIGHT TO USE "SCOOTER", APART FROM THE MARK AS SHOWN.
FOR REMOTE-CONTROLLED DOLLS AND ACCESSORIES THEREFOR (U.S. CLS. 22, 23, 38 AND 50).

CLASS 28—(Continued).

SN 78-052,661. MONNICH, JOHN M., SAN FRANCISCO, CA. FILED 3-12-2001.



FOR ERGONOMIC AND HYDRODYNAMICALLY DESIGNED SNORKEL FOR SWIMMERS AND SKIN DIVERS; MOLDABLE FOR EACH USER IT HAS A UNIQUE PATENTED DRAINAGE AND PURGING SYSTEM (U.S. CLS. 22, 23, 38 AND 50).

SN 78-054,919. HOCKMEYER, WAYNE F., THE FORKS, ME. FILED 3-26-2001.

SHIMMER SHAD

FOR ARTIFICIAL FISHING BAIT (U.S. CLS. 22, 23, 38 AND 50).

SN 78-054,922. HOCKMEYER, WAYNE F., THE FORKS, ME. FILED 3-26-2001.

SHIMMER SHINER

FOR ARTIFICIAL FISHING BAIT (U.S. CLS. 22, 23, 38 AND 50).

SN 78-057,173. TIME WARNER ENTERTAINMENT COMPANY, L.P., NEW YORK, NY. FILED 4-6-2001.

SMASH ZONE

FOR TOYS AND SPORTING GOODS, INCLUDING GAMES AND PLAYTHINGS - NAMELY, ACTION FIGURES AND ACCESSORIES THEREFOR; PLUSH TOYS; BALLOONS; BATHTUB TOYS; RIDE-ON TOYS; EQUIPMENT SOLD AS A UNIT FOR PLAYING CARD GAMES; TOY VEHICLES; DOLLS; FLYING DISCS; ELECTRONIC HAND-HELD GAME UNIT; GAME EQUIPMENT SOLD AS A UNIT FOR PLAYING A BOARD GAME, A CARD GAME, A MANIPULATIVE GAME, A PARLOR GAME AND AN ACTION TYPE TARGET GAME; STAND ALONE VIDEO OUTPUT GAME MACHINES; JIGSAW AND MANIPULATIVE PUZZLES; PAPER FACE MASKS; SKATEBOARDS; ICE SKATES; WATER SQUIRTING TOYS; BALLS - NAMELY, PLAYGROUND BALLS, SOCCER BALLS, BASEBALLS, BASKETBALLS; BASEBALL GLOVES; SWIMMING FLOATS FOR RECREATIONAL USE; KICKBOARD FLOTATION DEVICES FOR RECREATIONAL USE; SURFBOARDS; SWIM BOARDS FOR RECREATIONAL USE; SWIM FINS; TOY BAKEWARE AND TOY COOKWARE; TOY BANKS; AND CHRISTMAS TREE ORNAMENTS (U.S. CLS. 22, 23, 38 AND 50).

CLASS 28—(Continued).

SN 78-060,021. NATAL, MICHELE, NEW YORK, NY. FILED 4-24-2001.



FOR TOY PLUSH ANIMALS THAT CAN BE BENT AND TWISTED INTO VARIOUS SHAPES (U.S. CLS. 22, 23, 38 AND 50).

SN 78-060,374. QUIKPOINT, INC., CONCORD, MA. FILED 4-25-2001.

ZERO BLASTER

FOR TOY GUN FOR JUST HAVING FUN (U.S. CLS. 22, 23, 38 AND 50).

SN 78-061,204. RENAUD, PHILIP, FRANCIS, DELRAY BEACH, FL. FILED 4-30-2001.

SNOW SNAKE

NO CLAIM IS MADE TO THE EXCLUSIVE RIGHT TO USE "SNAKE", APART FROM THE MARK AS SHOWN. FOR STUFFED TOY SNAKE (U.S. CLS. 22, 23, 38 AND 50).

SN 78-072,323. WHAM-O, INC., SAN FRANCISCO, CA. FILED 7-4-2001.

P.R.S.

FOR BODYBOARDS AND BODYBOARDING ACCESSORIES (U.S. CLS. 22, 23, 38 AND 50).

CLASS 28—(Continued).

SN 78-072,365. SUPER DUPER INC., DBA SUPER DUPER PUBLICATIONS, GREENVILLE, SC. FILED 7-5-2001.

ARTIC ARCADE

FOR EDUCATIONAL GAMES CONSISTING PRIMARILY OF A BOARD GAME AND FLASHCARDS SOLD AS A UNIT IN THE FIELD OF SPEECH, LANGUAGE, VOICE, FLUENCY, AND HEARING, FOR THE USE BY THE GENERAL PUBLIC, PUBLIC AND PRIVATE TEACHERS, HEALTH PROFESSIONALS OR THERAPISTS (U.S. CLS. 22, 23, 38 AND 50).

SN 78-072,369. SUPER DUPER INC., DBA SUPER DUPER PUBLICATIONS, GREENVILLE, SC. FILED 7-5-2001.

LOOK WHO'S LISTENING

FOR EDUCATIONAL GAME CONSISTING PRIMARILY OF A BOARD GAME, WORKBOOK, AND FLASHCARDS SOLD AS A UNIT IN THE FIELD OF SPEECH, LANGUAGE, VOICE, FLUENCY, AND HEARING, FOR THE USE BY THE GENERAL PUBLIC, PUBLIC AND PRIVATE TEACHERS, HEALTH PROFESSIONALS OR THERAPISTS (U.S. CLS. 22, 23, 38 AND 50).

SN 78-072,444. HIMEL, LAURENCE, PHILIP, TORONTO, ONTARIO, FILED 7-5-2001.

CHAMELEON

FOR EQUIPMENT INCLUDING A PLAYING BOARD, DICE, RULES OF PLAY, AND GAME PIECES SOLD AS A UNIT FOR PLAYING A BOARD GAME (U.S. CLS. 22, 23, 38 AND 50).

SN 78-072,525. JAS. D. EASTON, INC., VAN NUYS, CA. FILED 7-5-2001.

SC888

OWNER OF U.S. REG. NO. 2,144,474. FOR SPORTING GOODS, NAMELY, SOFTBALL, BASEBALL AND SOFTBALL AND BASEBALL YOUTH BATS (U.S. CLS. 22, 23, 38 AND 50).

SN 78-072,526. JAS. D. EASTON, INC., VAN NUYS, CA. FILED 7-5-2001.

SC900

OWNER OF U.S. REG. NO. 2,144,474. FOR SPORTING GOODS, NAMELY, SOFTBALL, BASEBALL AND SOFTBALL AND BASEBALL YOUTH BATS (U.S. CLS. 22, 23, 38 AND 50).

CLASS 28—(Continued).

SN 78-073,173. REDFEATHER SNOWSHOES, DENVER, CO. FILED 7-10-2001.

LYNX

FOR SNOWSHOES, SNOWSHOE COMPONENTS AND ACCESSORIES FOR SNOWSHOES (U.S. CLS. 22, 23, 38 AND 50).

SN 78-073,448. MYERS, JEFF D., PHOENIX, AZ. FILED 7-11-2001.



NO CLAIM IS MADE TO THE EXCLUSIVE RIGHT TO USE "BEAR", APART FROM THE MARK AS SHOWN. FOR CHILDRENS TOYS, NAMELY PLUSH ANIMALS (U.S. CLS. 22, 23, 38 AND 50). FIRST USE 3-1-1987; IN COMMERCE 3-1-1987.

SN 78-079,182. HENDERSON, CYNTHIA, C., ROCKVILLE, MD. FILED 8-14-2001.



NO CLAIM IS MADE TO THE EXCLUSIVE RIGHT TO USE "GAME FOR LOVERS", APART FROM THE MARK AS SHOWN. FOR CARD GAMES (U.S. CLS. 22, 23, 38 AND 50).

SN 78-083,588. BUILD-A-BEAR WORKSHOP, INC., ST. LOUIS, MO. FILED 9-12-2001.

CUBGRATULATIONS

FOR STUFFED AND PLUSH TOY ANIMALS (U.S. CLS. 22, 23, 38 AND 50).

CLASS 28—(Continued).

SN 78-084,550. LIMITED TREASURES, INC., RANCHO CORDOVA, CA. FILED 9-19-2001.

HOMETOWN HEROES

FOR PLUSH TOYS, NAMELY, BEARS (U.S. CLS. 22, 23, 38 AND 50). FIRST USE 6-22-2001; IN COMMERCE 8-29-2001.

SN 78-084,553. SIMPLE WISHES, INC., STUDIO CITY, CA. FILED 9-19-2001.

CUDDLEBOT

FOR ELECTRONIC PLUSH TOYS (U.S. CLS. 22, 23, 38 AND 50).

SN 78-084,555. SIMPLE WISHES, INC., STUDIO CITY, CA. FILED 9-19-2001.

PURRBALLS

FOR ELECTRONIC PLUSH TOYS (U.S. CLS. 22, 23, 38 AND 50).

SN 78-086,203. JAS. D. EASTON, INC., VAN NUYS, CA. FILED 9-28-2001.

OCTANE

FOR SPORTING GOODS, NAMELY, BASEBALL, SOFTBALL AND YOUTH BASEBALL BATS (U.S. CLS. 22, 23, 38 AND 50). FIRST USE 4-1-2001; IN COMMERCE 4-1-2001.

CLASS 29—MEATS AND PROCESSED FOODS

CLASS 29—(Continued).

SN 75-545,282. PRIMARY PRODUCERS CO-OPERATIVE SOCIETY LTD., DUNEDIN, NEW ZEALAND, FILED 8-31-1998.



FOR MEAT, POULTRY AND FOOD GAME; MEAT EXTRACTS; MEAT JELLIES; PREPARED FOOD PRODUCTS, MEALS AND SNACKS, ALL MADE FROM MEAT, POULTRY, FOOD GAME, SINGLY OR IN COMBINATION (U.S. CL. 46).
FIRST USE 7-0-1992; IN COMMERCE 7-0-1995.

SN 75-866,531. MOLKEREI ALOIS MULLER GMBH & CO., 8935 ARETSRIED, FED REP GERMANY, FILED 12-8-1999.

FRUIT CORNER

OWNER OF UNITED KINGDOM REG. NO. 1277965, DATED 9-8-1986, EXPIRES 9-8-2007.
NO CLAIM IS MADE TO THE EXCLUSIVE RIGHT TO USE "FRUIT", APART FROM THE MARK AS SHOWN.
FOR YOGURT (U.S. CL. 46).

SN 75-929,767. AXA ALIMENTOS, S. DE R.L. DE C.V., SAN NICOLAS DE LOS GARZA C.P., MEXICO, FILED 2-28-2000.

CAPERUCITA

THE ENGLISH TRANSLATION OF CAPERUCITA IS "LITTLE RED RIDING HOOD".
FOR CHEESE (U.S. CL. 46).

CLASS 29—(Continued).

SN 75-981,070. KABUSHIKI KAISHA KIBUN SHOKUHIN, DBA KIBUN FOODS INC., CHUO-KU, TOKYO, JAPAN, FILED 10-16-1998.

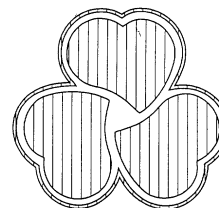

KIBUN

OWNER OF JAPAN REG. NO. 2019414, DATED 1-26-1988, EXPIRES 1-26-2008.
OWNER OF U.S. REG. NOS. 870,967, 2,044,266 AND OTHERS.
THE DRAWING IS LINED FOR THE COLOR(S) RED.
FOR SOYBEAN-BASED BEVERAGES (U.S. CL. 46).

SN 76-047,206. QUESOS CORCUERA SL, 45516 LA PUEBLA DE MONTALBAN (TOLEDO), SPAIN, FILED 5-12-2000.

CORCUERA

SEC. 2(F).
FOR DAIRY PRODUCTS EXCLUDING ICE CREAM, ICE MILK AND FROZEN YOGURT; CHEESES (U.S. CL. 46).
FIRST USE 0-0-1965; IN COMMERCE 0-0-1995.

SN 76-068,906. FREIREMAR, S.A., LAS PALMAS DE GRAN CANARIA, SPAIN, FILED 6-12-2000.

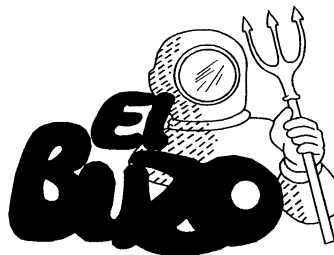

THE ENGLISH TRANSLATION OF THE WORD "EL BUZO" IN THE MARK IS "THE DIVER".
FOR FRESH, FROZEN AND PRESERVED FISH, SEA-FOOD, AND CEPHALOPODS (U.S. CL. 46).

CLASS 29—(Continued).

SN 76-072,927. DEMERS, RONALD J., FAIRFIELD, CT.
FILED 6-19-2000.

SAGITTARIO

OWNER OF U.S. REG. NO. 1,863,836.
THE ENGLISH TRANSLATION OF "SAGITTARIO" IS
"SAGITTARIUS".
FOR GOURMET FOODS, NAMELY OLIVE OIL AND
OLIVE PASTES (U.S. CL. 46).
FIRST USE 4-24-1992; IN COMMERCE 4-24-1992.

SN 76-080,349. LARGO FOOD EXPORTS LIMITED, COUNTY
MEATH EIRE, IRELAND, FILED 6-29-2000.

HUNKY DORYS

FOR SNACK FOODS, NAMELY, POTATO CHIPS,
POTATO CRISPS AND POTATO-BASED SNACK FOODS
(U.S. CL. 46).

SN 76-085,480. DOVE CORPORATION, THE, 1000 BRUSSELS,
BELGIUM, FILED 7-6-2000.



OWNER OF BENELUX REG. NO. 0665602, DATED 1-20-
2000, EXPIRES 1-20-2010.

THE ENGLISH TRANSLATION OF "AL WADI AL AKH-
DAR" IS "THE GREEN VALLEY".

FOR MEAT, FISH, POULTRY AND GAME; MEAT
EXTRACTS; PRESERVED, DRIED, COOKED AND FRO-
ZEN FRUITS AND VEGETABLES; JELLIES, JAMS,
FRUIT SAUCES; EDIBLE OILS AND FATS; CANNED
SLICED FRUITS AND VEGETABLES (U.S. CL. 46).

CLASS 29—(Continued).

SN 76-086,911. SCHAUB, THOMAS L., HILL CITY, SD.
FILED 7-12-2000.

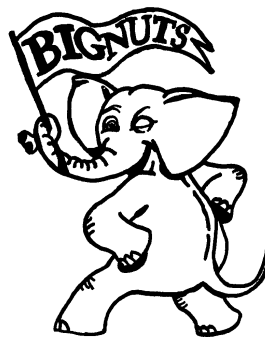

NO CLAIM IS MADE TO THE EXCLUSIVE RIGHT TO
USE "BIG NUTS", APART FROM THE MARK AS SHOWN.
FOR PROCESSED NUTS FOR HUMAN CONSUMP-
TION (U.S. CL. 46).

SN 76-087,958. DANNON COMPANY, INC, THE, TARRY-
TOWN, NY. FILED 7-10-2000.

la Crème

NO CLAIM IS MADE TO THE EXCLUSIVE RIGHT TO
USE "CREME", APART FROM THE MARK AS SHOWN.

THE ENGLISH TRANSLATION OF "LA CREME" IS "THE
CREAM".

FOR YOGURT (U.S. CL. 46).
FIRST USE 1-8-2001; IN COMMERCE 1-8-2001.

SN 76-096,711. DEARBORN SAUSAGE COMPANY, DEAR-
BORN, MI. FILED 7-26-2000.

DEARBORN

SEC. 2(F).
FOR MEATS (U.S. CL. 46).
FIRST USE 7-0-1985; IN COMMERCE 7-0-1985.

CLASS 29—(Continued).

SN 76-104,908. FUTURE PROPERTY MANAGEMENT, INC., WILMINGTON, DE. FILED 8-8-2000.

CLASS 29—(Continued).

SN 76-139,108. S.P.A. EGIDIO GALBANI, MELZO (MILAN), ITALY, FILED 10-2-2000.

OUR TOWN CAFE

FOR PREPARED ENTREES CONSISTING PRIMARILY OF PORK, FISH, GAME OR POULTRY; MEAT EXTRACTS; PRESERVED, DRIED AND COOKED FRUITS AND VEGETABLES; JELLIES, JAMS; EGGS, CHEESE, MILK, CHOCOLATE MILK, AND OTHER DAIRY PRODUCTS EXCLUDING ICE CREAM, ICE MILK AND FROZEN YOGURT; FRUIT PRESERVES, PICKLES; EDIBLE OILS AND FATS (U.S. CL. 46).



SN 76-111,457. VIZ CATTLE CORPORATION, DOMINGUEZ HILLS, CA. FILED 8-18-2000.

OWNER OF U.S. REG. NOS. 134,502, 1,270,899 AND OTHERS.

THE STIPPLING SHOWN IN THE DRAWING IS A FEATURE OF THE MARK AND IS NOT INTENDED TO INDICATE COLOR.

THE ENGLISH TRANSLATION OF THE WORDING "BEL PAESE" IS "BEAUTIFUL COUNTRY".
FOR CHEESE (U.S. CL. 46).



SN 76-176,734. WORNICK COMPANY, THE, CINCINNATI, OH. FILED 12-6-2000.

WORNICK FAMILY FOODS

"SUKARNE" IS THE PHONETIC REPRESENTATION OF "SU CARNE", MEANING "YOUR BEEF", AND THE ENGLISH TRANSLATION OF "CON SABOR DEL NORTE" IS "WITH THE TASTE (OR FLAVOR) OF THE NORTH".

FOR BEEF AND/OR PACKAGED ENTREES CONSISTING PRIMARILY OF BEEF (U.S. CL. 46).
FIRST USE 10-9-1999; IN COMMERCE 10-9-1999.

NO CLAIM IS MADE TO THE EXCLUSIVE RIGHT TO USE "FOODS", APART FROM THE MARK AS SHOWN.

FOR PACKAGED SHELF STABLE MEALS CONSISTING PRIMARILY OF MEAT OR POULTRY, AND ALSO CONTAINING VEGETABLES OR RICE (U.S. CL. 46).
FIRST USE 9-0-1999; IN COMMERCE 9-0-1999.

SN 76-120,934. PURITY FOODS, INC., CLAYTON, OH. FILED 9-5-2000.

DINNER WINNERS

NO CLAIM IS MADE TO THE EXCLUSIVE RIGHT TO USE "DINNER", APART FROM THE MARK AS SHOWN.

FOR PREPARED PACKAGED SIDE DISHES, NAMELY, SOUR CREAM AND CHIVE POTATOES, THREE CHEESE POTATOES, JULIENNE POTATOES, AU GRATIN POTATOES AND SCALLOP POTATOES (U.S. CL. 46).

SN 76-178,111. FERNANDO'S FOODS CORPORATION, LA PALMA, CA. FILED 12-11-2000.

ANDALE GOURMET

NO CLAIM IS MADE TO THE EXCLUSIVE RIGHT TO USE "GOURMET", APART FROM THE MARK AS SHOWN. THE ENGLISH TRANSLATION OF "ANDALE GOURMET" IS "HURRY UP GOURMET".

FOR SHREDDED BEEF, PORK AND CHICKEN; GROUND BEEF, PORK AND CHICKEN; BEEF STRIPS, CHICKEN STRIPS AND PORK STRIPS (U.S. CL. 46).

CLASS 29—(Continued).

SN 76-226,924. WILLOW BROOK FOODS, INC., SPRINGFIELD, MO. FILED 3-19-2001.

WILLOW BROOK FARMS

OWNER OF U.S. REG. NOS. 823,488 AND 1,093,905.
NO CLAIM IS MADE TO THE EXCLUSIVE RIGHT TO USE "FARMS", APART FROM THE MARK AS SHOWN.
FOR MEAT; MEAT PRODUCTS, NAMELY, PORK, BEEF, AND LUNCHEON MEAT; FRESH AND FROZEN POULTRY (U.S. CL. 46).
FIRST USE 6-20-1978; IN COMMERCE 6-20-1978.

SN 76-276,953. LUVJAM INDUSTRIES, L.L.C., ATLANTIC HIGHLANDS, NJ. FILED 6-27-2001.

LOVE JAM

NO CLAIM IS MADE TO THE EXCLUSIVE RIGHT TO USE "JAM", APART FROM THE MARK AS SHOWN.
FOR JELLIES; JAMS; FRUIT SAUCES; AND EDIBLE OILS (U.S. CL. 46).

SN 78-018,797. COCON FOOD INDUSTRIES SDN. BHD., KEDAH DARUL AMAN, MALAYSIA, FILED 7-28-2000.

COCON

FOR JELLY, JELLY POWDER, COFFEE JELLY, TEA JELLY, ALMOND JELLY (U.S. CL. 46).

SN 78-024,172. NABISCO BRANDS COMPANY, WILMINGTON, DE. FILED 9-1-2000.

NUT MATES

NO CLAIM IS MADE TO THE EXCLUSIVE RIGHT TO USE "NUT", APART FROM THE MARK AS SHOWN.
FOR PROCESSED NUTS WITH A WHEAT BASED COATING (U.S. CL. 46).

SN 78-024,174. NABISCO BRANDS COMPANY, WILMINGTON, DE. FILED 9-1-2000.

NUT CRISPS

NO CLAIM IS MADE TO THE EXCLUSIVE RIGHT TO USE "NUT", APART FROM THE MARK AS SHOWN.
FOR PROCESSED NUTS WITH A WHEAT BASED COATING (U.S. CL. 46).

CLASS 29—(Continued).

SN 78-033,466. GOODMANSON, DEBRA, KIRKLAND, WA. FILED 11-2-2000.

"THIS Can't Be SOY!"

NO CLAIM IS MADE TO THE EXCLUSIVE RIGHT TO USE "SOY", APART FROM THE MARK AS SHOWN.
FOR SNACK FOODS, NAMELY ROASTED SOYBEANS (U.S. CL. 46).
FIRST USE 8-26-2000; IN COMMERCE 8-26-2000.

SN 78-078,903. LANGLEE, ERIC L, COON RAPIDS, MN. FILED 8-13-2001.



NO CLAIM IS MADE TO THE EXCLUSIVE RIGHT TO USE "BAKED BEAN CO.", APART FROM THE MARK AS SHOWN.
FOR MIX FOR MAKING BAKED BEANS CONSISTING OF DRIED PINTO BEANS AND A SEASONING PACKET (U.S. CL. 46).

CLASS 30—STAPLE FOODS

SN 75-601,204. CONAGRA BRANDS, INC., OMAHA, NE.
FILED 12-7-1998.

BREAD STUFFS

NO CLAIM IS MADE TO THE EXCLUSIVE RIGHT TO USE "BREAD", APART FROM THE MARK AS SHOWN.
FOR PRE-COOKED, READY-TO-EAT, FROZEN BREAD HAVING A MEAT, CHEESE AND/OR VEGETABLE FILING (U.S. CL. 46).

SN 75-838,819. CORTICELLA MOLINIE PASTIFICI S.P.A., 1-40128 BOLOGNA, ITALY, FILED 11-3-1999.



PRIORITY CLAIMED UNDER SEC. 44(D) ON ERP N CMNTY TM OFC APPLICATION NO. 1200328, FILED 6-9-1999.

THE WORDS "RIVA DEL SOLE" CAN BE TRANSLATED INTO ENGLISH TO READ "SUNNY SHORE".
FOR PASTA (U.S. CL. 46).

SN 75-852,312. FIRMENICH SA, 1211 GENEVE 8, SWITZERLAND, FILED 11-18-1999.

NaturePrint

PRIORITY CLAIMED UNDER SEC. 44(D) ON SWITZERLAND APPLICATION NO. 04377/1999, FILED 5-19-1999, REG. NO. 471390, DATED 5-19-1999, EXPIRES 5-19-2009.

OWNER OF U.S. REG. NO. 2,247,460.
FOR AROMATIC FOOD ADDITIVES FOR NON-NUTRITIONAL PURPOSES; FOOD FLAVORINGS; FLAVORING SYRUP; FLAVORING FOR TOBACCO (U.S. CL. 46).

SN 75-853,598. OTAFUKU SAUCE CO., LTD., NISHI-KU, HIROSHIMA-SHI, HIROSHIMA, JAPAN, FILED 11-19-1999.

OTAFUKU

OWNER OF U.S. REG. NOS. 1,963,859 AND 1,967,895.
THE ENGLISH TRANSLATION OF "OTAFUKU" IS "A PLAIN LOOKING WOMAN".
FOR SEASONING AND SAUCES (U.S. CL. 46).
FIRST USE 12-0-1975; IN COMMERCE 12-0-1975.

CLASS 30—(Continued).

SN 75-924,438. MORALI, GEORGES-EMMANUEL, PARIS, FRANCE, FILED 2-22-2000.

**LE THE DES ECRIVAINS THE
TEA OF THE AUTHORS DER
TEE DER SCHRIFTSTELLER
EL TE DE LOS ESCRITORES
O CHA DOS ESCRITORES IL
TE DEGLI SCRITORRI**

OWNER OF FRANCE REG. NO. 99808784, DATED 8-20-1999, EXPIRES 8-20-1999.

NO CLAIM IS MADE TO THE EXCLUSIVE RIGHT TO USE "THE", "TEA", "TEE", "TE" AND "CHA", APART FROM THE MARK AS SHOWN.

THE ENGLISH TRANSLATION OF "LE THE DES ECRIVAINS", "DER TEE DER SCHRIFTSTELLER", "EL TE DE LOS ESCRITORES", "O CHA DOS ESCRITORES" AND "IL TE DEGLI SCRITORRI" IS "THE TEA OF THE AUTHORS".
FOR TEA (U.S. CL. 46).

SN 76-024,216. SHERWOOD BRANDS, LLC, ROCKVILLE, MD. BY ASSIGNMENT SHERWOOD BRANDS OF R.I., INC., PAWTUCKET, RI. FILED 4-12-2000.



OWNER OF U.S. REG. NO. 2,321,982.
NO CLAIM IS MADE TO THE EXCLUSIVE RIGHT TO USE "SUCKERS" OR "BRANDS", APART FROM THE MARK AS SHOWN.

FOR CANDY (U.S. CL. 46).
FIRST USE 12-0-1998; IN COMMERCE 12-0-1998.

SN 76-042,079. D&C VENTURES, INC., PETALUMA, CA. FILED 5-5-2000.

SPLENDIDO BISCOTTI

NO CLAIM IS MADE TO THE EXCLUSIVE RIGHT TO USE "BISCOTTI", APART FROM THE MARK AS SHOWN.
"SPLENDIDO" IS AN ITALIAN WORD WITH AN ENGLISH TRANSLATION OF "SPLENDID".

FOR SWEET AND SAVORY BISCUITS, BISCOTTI, BISCOTTI CONFECTIONS AND COOKIES (U.S. CL. 46).
FIRST USE 8-0-1992; IN COMMERCE 8-0-1992.

CLASS 30—(Continued).

SN 76-052,857. WALLACE, DONNA MARIE BAYLES, DBA BAYLES RANCH, BIGGS, CA. FILED 5-22-2000.

CAL RISO

NO CLAIM IS MADE TO THE EXCLUSIVE RIGHT TO USE "RISO", APART FROM THE MARK AS SHOWN. FOR RICE (U.S. CL. 46). FIRST USE 5-2-1997; IN COMMERCE 7-17-1997.

SN 76-075,314. BARATTI & MILANO S.R.L., 10121 TORINO, ITALY, FILED 6-22-2000.



PRIORITY CLAIMED UNDER SEC. 44(D) ON ITALY APPLICATION NO. 003423, FILED 3-23-2000, REG. NO. 00829838, DATED 3-23-2000, EXPIRES 3-23-2010.

NO CLAIM IS MADE TO THE EXCLUSIVE RIGHT TO USE "TORINO 1856" AND "CIOCCOLATERIA CONFETTERIA", APART FROM THE MARK AS SHOWN.

THE LINING WHICH APPEARS ON THE DRAWING OF THE MARK IS MERELY A FEATURE OF THE MARK AND IS NOT INTENDED TO REPRESENT COLOR.

THE ENGLISH TRANSLATION OF THE ITALIAN WORDING "CIOCCOLATERIA" AND "CONFETTERIA" IS "CHOCOLATE MANUFACTURERS" AND "CONFECTIONERY MANUFACTURERS", RESPECTIVELY.

FOR CANDIES, CHOCOLATES, CHOCOLATE-BARS, CAKES, FLAVORED ICES AND FRUIT ICES, SWEET PASTRIES, BISCUITS, COFFEE, TEA, COCOA, SUGAR, CEREAL-BASED SNACK FOOD (U.S. CL. 46).

SN 76-077,450. R.W. & R.W. INC., DBA LUIGI'S ITALIAN RESTAURANT, SAN DIEGO, CA. FILED 6-23-2000.



NO CLAIM IS MADE TO THE EXCLUSIVE RIGHT TO USE "WORLD FAMOUS GIANT SLICE PIZZA", APART FROM THE MARK AS SHOWN. FOR PIZZAS (U.S. CL. 46).

CLASS 30—(Continued).

SN 76-077,497. NEW WORLD PASTA COMPANY, HARRISBURG, PA. FILED 6-26-2000.



OWNER OF U.S. REG. NOS. 88,250, 1,642,927 AND OTHERS.

NO CLAIM IS MADE TO THE EXCLUSIVE RIGHT TO USE "FLORENTINE" AND "FETTUCCINE", APART FROM THE MARK AS SHOWN.

FOR PASTA (U.S. CL. 46). FIRST USE 5-0-1998; IN COMMERCE 8-0-1998.

SN 76-093,619. EUROBRAND, LLC, LOS ANGELES, CA. FILED 7-20-2000.



THE STIPPLING IS FOR SHADING PURPOSES ONLY. FOR CONFECTIONERY, NAMELY, CANDY MINTS, CHEWING GUM, CANDY, SHERBERT, AND TEA (U.S. CL. 46).

SN 76-102,627. LA TORTILLERIA, INC., WINSTON-SALEM, NC. FILED 7-24-2000.



NO CLAIM IS MADE TO THE EXCLUSIVE RIGHT TO USE "IRRESISTIBLY AUTHENTIC", APART FROM THE MARK AS SHOWN.

THE DRAWING IS LINED FOR THE COLOR(S) PURPLE. THE ENGLISH TRANSLATION OF THE WORD "CUERVITO MORADO" IN THE MARK IS "PURPLE CROW". FOR COOKIES (U.S. CL. 46).

CLASS 30—(Continued).

SN 76-104,909. FUTURE PROPERTY MANAGEMENT, INC., WILMINGTON, DE. FILED 8-8-2000.

OUR TOWN CAFE

FOR EDIBLE SANDWICHES FOR CONSUMPTION ON OR OFF THE PREMISES, COFFEE, COFFEE SUBSTITUTES, TEA, COCOA, SUGAR, HONEY, RICE, TAPIOCA, FLOUR, BREAKFAST CEREALS, PROCESSED CEREALS, CEREAL-BASED SNACK FOODS AND READY TO EAT CEREAL-DERIVED FOOD BARS; BREAD, BISCUITS, CAKES, PASTRIES, DAIRY-BASED SHAKES, SOFT-SERVE ICE CREAM, ICE MILK AND FROZEN YOGURT; YEAST, BAKING POWDER, SALT, MUSTARD, PEPPER, SAUCES, SPICES, SEASONINGS AND ICE (U.S. CL. 46).

SN 76-107,551. ZAXBY'S FRANCHISING, INC., ATHENS, GA. FILED 8-11-2000.

ZAX SAUCE

NO CLAIM IS MADE TO THE EXCLUSIVE RIGHT TO USE "SAUCE", APART FROM THE MARK AS SHOWN. FOR SAUCE FOR COOKED CHICKEN (U.S. CL. 46). FIRST USE 3-0-1990; IN COMMERCE 6-0-1991.

SN 76-111,525. CHATAM INTERNATIONAL INCORPORATED, WILMINGTON, DE. FILED 8-17-2000.

GOURMET COOKING MADE EASY

NO CLAIM IS MADE TO THE EXCLUSIVE RIGHT TO USE "GOURMET COOKING", APART FROM THE MARK AS SHOWN. FOR MARINADE (U.S. CL. 46).

SN 76-140,206. HILL AND WARD APIARIES, INC., WILLOWS, CA. FILED 10-5-2000.

LAUREL HILL HONEY

NO CLAIM IS MADE TO THE EXCLUSIVE RIGHT TO USE "HONEY", APART FROM THE MARK AS SHOWN. THE NAME "LAUREL HILL" IDENTIFIES A LIVING INDIVIDUAL WHOSE CONSENT IS OF RECORD. FOR HONEY (U.S. CL. 46). FIRST USE 6-1-2000; IN COMMERCE 9-7-2000.

CLASS 30—(Continued).

SN 76-142,975. BERNER CHEESE CORPORATION, ROSCOE, IL. FILED 10-6-2000.

PARTY CHEESE

OWNER OF U.S. REG. NO. 2,334,921. NO CLAIM IS MADE TO THE EXCLUSIVE RIGHT TO USE "CHEESE", APART FROM THE MARK AS SHOWN. FOR CHEESE SAUCE IN AN AEROSOL CONTAINER (U.S. CL. 46). FIRST USE 11-17-1997; IN COMMERCE 11-0-1997.

SN 76-144,379. NABISCO BRANDS COMPANY, WILMINGTON, DE. FILED 10-10-2000.

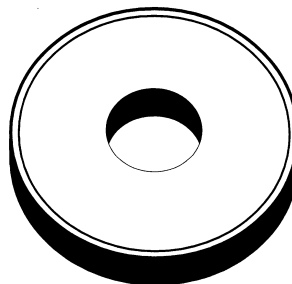

OWNER OF U.S. REG. NOS. 180,487, 1,707,055 AND OTHERS. THE MARK CONSISTS OF THE CONFIGURATION OF A CIRCULAR CONTAINER WITH A HOLE IN THE MIDDLE. FOR CANDY (U.S. CL. 46).

SN 76-145,722. NABISCO BRANDS COMPANY, WILMINGTON, DE. FILED 10-10-2000.

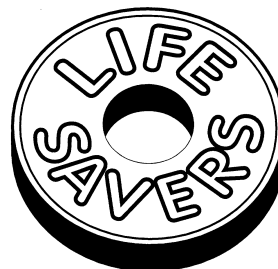

OWNER OF U.S. REG. NOS. 115,895, 1,130,067 AND OTHERS. THE MARK CONSISTS OF THE CONFIGURATION OF A CIRCULAR CONTAINER WITH A HOLE IN THE MIDDLE AND THE WORDS "LIFE SAVERS" PRINTED THEREON. FOR CANDY (U.S. CL. 46).

CLASS 30—(Continued).

SN 76-161,663. ROYAL ICE CREAM COMPANY, CLEVELAND, OH. FILED 11-8-2000.

BANANA BUDDIES

NO CLAIM IS MADE TO THE EXCLUSIVE RIGHT TO USE "BANANA", APART FROM THE MARK AS SHOWN.
FOR CHOCOLATE-COVERED FROZEN BANANAS (U.S. CL. 46).

FIRST USE 4-0-2001; IN COMMERCE 4-0-2001.

SN 76-171,786. VITAL WOMAN PTY LTD, KILLARA NSW 2071, AUSTRALIA, FILED 11-20-2000.



FOR FOOD PREPARATIONS CONSISTING OR CONTAINING CEREAL; RICE; SPICES; BREAD CRUMBS; FLOUR; YEAST; TAPIOCA; SAGO; FOOD STARCH; BISCUITS; BREADS; PASTA; CONFECTIONERY, NAMELY, FRUIT JELLIES, LICORICE, LOZENGES, PASTILLES, SUGAR CONFECTIONARY; CONFECTIONERY CONTAINING NUTS OR CHOCOLATES; FROZEN YOGHURT; HONEY; BAKING POWDER; PASTRY AND FLAVORED ICES (U.S. CL. 46).

SN 76-174,995. KENT GIDA MADDELERI SANAYII VE TICARET ANONIM SIRKETI, GEBZE, KOCAELI, TURKEY, FILED 12-4-2000.

RELAX

FOR CHEWING GUM AND BUBBLE GUM (U.S. CL. 46).

SN 76-184,221. A.B. COMPANY OF WISCONSIN, WEST ALLIS, WI. FILED 12-21-2000.

BOSANKA

FOR COOKIES AND CANDIES (U.S. CL. 46).
FIRST USE 12-5-2000; IN COMMERCE 12-5-2000.

CLASS 30—(Continued).

SN 76-187,534. MADE-RITE SANDWICH COMPANY OF CHATTANOOGA, INC., OOLTEWAH, TN. FILED 12-29-2000.



THE STIPPLING IS FOR SHADING PURPOSES ONLY AND DOES NOT INDICATE COLOR.

THE ENGLISH TRANSLATION OF THE TERM "CASA DEL TORO" IS "HOUSE OF THE BULL".

FOR BURRITOS, TACOS, CHIMICHANGAS, ENCHILADAS, TAMALES, CHALUPAS, TAQUITOS AND QUESADILLAS (U.S. CL. 46).

SN 76-201,608. TANG'S FAMILY CORPORATION, WASHINGTON, DC. FILED 1-30-2001.

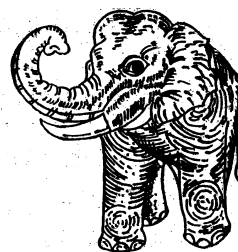

CON VOI ĐỒ
ELEPHANT BRAND

NO CLAIM IS MADE TO THE EXCLUSIVE RIGHT TO USE "BRAND", APART FROM THE MARK AS SHOWN.

THE LINING IN THE DRAWING IS FOR SHADING PURPOSES ONLY.

THE WORDS "CON VOI DO2" IS VIETNAMESE FOR "RED ELEPHANT".

FOR FOOD PRODUCTS, NAMELY RICE (U.S. CL. 46).
FIRST USE 6-28-1996; IN COMMERCE 6-28-1996.

CLASS 30—(Continued).

SN 76-207,852. PHOENIX INTANGIBLES HOLDING COMPANY, WILMINGTON, DE. FILED 2-9-2001.

PIZZA DI CASA

OWNER OF U.S. REG. NO. 1,980,381.
 NO CLAIM IS MADE TO THE EXCLUSIVE RIGHT TO USE "PIZZA", APART FROM THE MARK AS SHOWN.
 THE ENGLISH TRANSLATION OF "PIZZA DI CASA" IS "PIZZA OF THE HOUSE" OR "HOUSE PIZZA".
 FOR BREADSTICKS AND CALZONES (U.S. CL. 46).
 FIRST USE 1-0-1996; IN COMMERCE 1-0-1996.

CLASS 30—(Continued).

SN 76-230,773. GISELA'S SENSATIONS, INC., TEMPE, AZ. FILED 3-27-2001.

GISELA PIE

NO CLAIM IS MADE TO THE EXCLUSIVE RIGHT TO USE "PIE", APART FROM THE MARK AS SHOWN.
 FOR BAKERY GOODS (U.S. CL. 46).
 FIRST USE 8-22-2000; IN COMMERCE 8-22-2000.

SN 76-216,580. FARAGHER FAMILY FARM, NEWPORT, KY. FILED 2-26-2001.

TRIBAL TREATS

NO CLAIM IS MADE TO THE EXCLUSIVE RIGHT TO USE "TREATS", APART FROM THE MARK AS SHOWN.
 FOR BAKED SNACK GOODS, NAMELY COOKIES AND CRACKERS (U.S. CL. 46).

SN 76-226,967. NOVELTY INC., GREENFIELD, IN. FILED 3-19-2001.



NO CLAIM IS MADE TO THE EXCLUSIVE RIGHT TO USE "NOVELTY CANDY", APART FROM THE MARK AS SHOWN.
 FOR CANDY (U.S. CL. 46).
 FIRST USE 2-28-2001; IN COMMERCE 2-28-2001.

SN 76-230,772. GISELA'S SENSATIONS, INC., TEMPE, AZ. FILED 3-27-2001.

**IT'S NOT A MUFFIN IT'S
 NOT A PIE . . . IT'S THE
 MUFFIN WITH THE PIE
 INSIDE**

FOR BAKERY GOODS (U.S. CL. 46).
 FIRST USE 2-26-2001; IN COMMERCE 2-26-2001.

SN 76-231,109. OASIS BRAND, LLC, SAN DIEGO, CA. FILED 3-26-2001.



NO CLAIM IS MADE TO THE EXCLUSIVE RIGHT TO USE "NATURALS", APART FROM THE MARK AS SHOWN.
 THE STIPLING IS A FEATURE OF THE MARK AND DOES NOT INDICATE COLOR.
 FOR HUMMUS (U.S. CL. 46).
 FIRST USE 6-0-1998; IN COMMERCE 6-0-1998.

SN 76-233,948. PHOENIX INTANGIBLES HOLDING COMPANY, WILMINGTON, DE. FILED 3-30-2001.



OWNER OF U.S. REG. NOS. 1,287,433, 1,980,381 AND OTHERS.
 NO CLAIM IS MADE TO THE EXCLUSIVE RIGHT TO USE "PIZZA", APART FROM THE MARK AS SHOWN.
 THE ENGLISH TRANSLATION OF "PIZZA DI CASA" IS "PIZZA OF THE HOUSE" OR "HOUSE PIZZA".
 FOR PIZZA, BREADSTICKS AND CALZONES (U.S. CL. 46).
 FIRST USE 12-27-1993; IN COMMERCE 12-27-1993.

CLASS 30—(Continued).

SN 76-237,886. SAVE-A-LOT FOOD STORES, INC., EARTH CITY, MO. FILED 4-9-2001.

COCOA DIAMONDS

NO CLAIM IS MADE TO THE EXCLUSIVE RIGHT TO USE "COCOA", APART FROM THE MARK AS SHOWN. FOR BREAKFAST CEREAL (U.S. CL. 46).

SN 76-251,859. KOREA YAKULT CO., LTD., SAN JOSE, CA. FILED 5-7-2001.

KING BOWL

FOR PREPARED MEAL CONSISTING PRIMARILY OF NOODLES WITH BEEF, CHICKEN OR VEGETABLES (U.S. CL. 46). FIRST USE 4-1-2001; IN COMMERCE 4-1-2001.

SN 76-272,695. RECOT, INC., PLEASANTON, CA. FILED 6-15-2001.

DORITOS TACO TOPPERS

OWNER OF U.S. REG. NOS. 792,667, 2,428,495 AND OTHERS. NO CLAIM IS MADE TO THE EXCLUSIVE RIGHT TO USE "TACO", APART FROM THE MARK AS SHOWN. FOR CORN-BASED SNACK FOODS, NAMELY, TORTILLA CHIPS (U.S. CL. 46).

SN 76-272,696. RECOT, INC., PLEASANTON, CA. FILED 6-15-2001.

DORITOS NACHO TOPPERS

OWNER OF U.S. REG. NOS. 792,667, 2,428,495 AND OTHERS. NO CLAIM IS MADE TO THE EXCLUSIVE RIGHT TO USE "NACHO", APART FROM THE MARK AS SHOWN. FOR CORN-BASED SNACK FOODS, NAMELY, TORTILLA CHIPS (U.S. CL. 46).

SN 76-273,747. RECOT, INC., PLEASANTON, CA. FILED 6-14-2001.

DORITOS PIZZA TOPPERS

OWNER OF U.S. REG. NOS. 792,667, 2,428,495 AND OTHERS. NO CLAIM IS MADE TO THE EXCLUSIVE RIGHT TO USE "PIZZA", APART FROM THE MARK AS SHOWN. FOR CORN-BASED SNACK FOODS, NAMELY, TORTILLA CHIPS (U.S. CL. 46).

CLASS 30—(Continued).

SN 76-276,131. LIDL STIFTUNG & CO. KG, 74172 NECK-ARSULM, FED REP GERMANY, FILED 6-22-2001.

SIR EDWARD TEA

OWNER OF FED REP GERMANY REG. NO. 917417, DATED 4-18-1974, EXPIRES 1-31-2011.

NO CLAIM IS MADE TO THE EXCLUSIVE RIGHT TO USE "TEA", APART FROM THE MARK AS SHOWN. FOR TEA FROM ENGLISH SPEAKING COUNTRIES IN PACKETS OR TEABAGS (U.S. CL. 46).

SN 76-276,554. JEL SERT CO., THE, WEST CHICAGO, IL. FILED 6-26-2001.

FRUIT SQUEEZERS

OWNER OF U.S. REG. NO. 1,699,921. NO CLAIM IS MADE TO THE EXCLUSIVE RIGHT TO USE "FRUIT", APART FROM THE MARK AS SHOWN. FOR READY-TO-EAT FRUIT FLAVORED SWEETENED GELATIN DESSERTS (U.S. CL. 46).

SN 76-278,873. DREYER'S GRAND ICE CREAM, INC., OAKLAND, CA. FILED 6-27-2001.

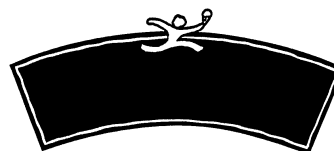

OWNER OF U.S. REG. NO. 2,089,948. THE MARK CONSISTS OF AN ABSTRACT HUMAN FIGURE AND A SCOOP OVER A BOX. FOR ICE CREAM, FROZEN YOGURT, FROZEN CONFECTION NOVELTIES AND FROZEN DAIRY AND NON-DAIRY CONFECTIONS (U.S. CL. 46). FIRST USE 1-3-2000; IN COMMERCE 1-3-2000.

SN 76-281,523. PHOENIX INTANGIBLES HOLDING COMPANY, WILMINGTON, DE. FILED 7-5-2001.

RUSTIC ITALIAN RECIPES

NO CLAIM IS MADE TO THE EXCLUSIVE RIGHT TO USE "ITALIAN RECIPES", APART FROM THE MARK AS SHOWN. FOR SALAD DRESSING (U.S. CL. 46).

CLASS 30—(Continued).

SN 76-285,258. DUNK'S HOT SAUCE, LLC., FOSTERS, AL. FILED 7-16-2001.

DUNK'S HOT SAUCE

NO CLAIM IS MADE TO THE EXCLUSIVE RIGHT TO USE "HOT SAUCE", APART FROM THE MARK AS SHOWN.
FOR HOT SAUCES AND BAR-B-Q SAUCE (U.S. CL. 46).
FIRST USE 5-0-1998; IN COMMERCE 4-2-2001.

SN 76-287,290. NATIONAL IMPORTERS INC., NEW WESTMINSTER, BRITISH COLUMBIA, CANADA, FILED 7-17-2001.



APPLICANT STATES THAT THE TERM "O'SHAY" DOES NOT IDENTIFY ANY LIVING INDIVIDUAL.
FOR CEREALS, NAMELY IRISH OATMEAL (U.S. CL. 46).

SN 76-287,924. J&J SNACK FOODS CORP., PENNSAUKEN, NJ. FILED 7-19-2001.

FRUIT & CREAM SWIRL

NO CLAIM IS MADE TO THE EXCLUSIVE RIGHT TO USE "FRUIT & CREAM", APART FROM THE MARK AS SHOWN.
FOR ICE CREAM AND WATER ICE CONFECTIONS (U.S. CL. 46).

CLASS 30—(Continued).

SN 76-292,338. KAFFE MAGNUM OPUS, INC., VINELAND, NJ. FILED 7-31-2001.

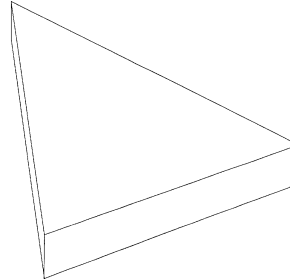

THE MARK IS A CONFIGURATION OF A TRIANGULARLY SHAPED BOX.
FOR COFFEE (U.S. CL. 46).
FIRST USE 4-10-2000; IN COMMERCE 4-10-2000.

SN 76-298,936. SILHOUETTE BRANDS, INC., MATAWAN, NJ. FILED 8-9-2001.

SILHOUETTE

OWNER OF U.S. REG. NO. 2,316,821.
FOR ICE CREAM; WHEAT-BASED SNACK FOODS AND FLAT BREADS (U.S. CL. 46).
FIRST USE 1-0-1994; IN COMMERCE 1-0-1994.

SN 78-002,868. ASIA PACIFIC TECHNOLOGIES CORP., DBA NATURAL ORIGINS ET AL, PLEASANT HILL, CA. FILED 4-6-2000.

THE PURE TEA PEOPLE

NO CLAIM IS MADE TO THE EXCLUSIVE RIGHT TO USE "PURE TEA", APART FROM THE MARK AS SHOWN.
FOR PURE BLACK TEA AND PURE GREEN TEA FOR FOOD PURPOSES (U.S. CL. 46).
FIRST USE 9-15-1999; IN COMMERCE 11-1-1999.

SN 78-030,739. CEDAR CREST SPECIALTIES, INC., CEDARBURG, WI. FILED 10-16-2000.

CARAMEL COLLISION

NO CLAIM IS MADE TO THE EXCLUSIVE RIGHT TO USE "CARAMEL", APART FROM THE MARK AS SHOWN.
FOR ICE CREAM, NAMELY, CARAMEL FLAVORED ICE CREAM (U.S. CL. 46).
FIRST USE 7-31-2000; IN COMMERCE 7-31-2000.

CLASS 30—(Continued).

SN 78-033,438. NABISCO BRANDS COMPANY, WILMINGTON, DE. FILED 11-2-2000.

A.1. STEAKHOUSE

OWNER OF U.S. REG. NOS. 26,824, 1,215,098 AND OTHERS.

NO CLAIM IS MADE TO THE EXCLUSIVE RIGHT TO USE "STEAKHOUSE", APART FROM THE MARK AS SHOWN.

FOR MARINADES (U.S. CL. 46).
FIRST USE 2-26-2001; IN COMMERCE 2-26-2001.

SN 78-033,602. ALANIS, JOSE EDUARDO, NUEVO LEON MONTERREY, MEXICO, FILED 11-2-2000.

MEXICO RICO

NO CLAIM IS MADE TO THE EXCLUSIVE RIGHT TO USE "MEXICO", APART FROM THE MARK AS SHOWN.

THE ENGLISH TRANSLATION OF "MEXICO RICO" IS "DELICIOUS MEXICO".

FOR FLAVORED AND SWEETENED GELATINS, CUSTARD, TORTILLAS, CORN SOPE SPICES (U.S. CL. 46).

SN 78-035,061. HOLY MOLE!, INC., ROUND ROCK, TX. FILED 11-13-2000.

THE BLESSING IS IN THE BOTTLE

FOR FOOD PRODUCTS, NAMELY SALSA, HOT SAUCE; CONDIMENTS, NAMELY SALAD DRESSING, RELISH, HOT MUSTARD; MARINADES AND BARBECUE SAUCE (U.S. CL. 46).

SN 78-041,607. BOOTH, RANDY REED, BISBEE, AZ. FILED 1-3-2001.

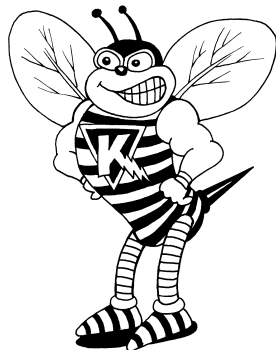

FOR KILLER BEE HONEY, HONEY BUTTERS AND HONEY MUSTARDS (U.S. CL. 46).
FIRST USE 0-0-1993; IN COMMERCE 0-0-1993.

CLASS 30—(Continued).

SN 78-041,841. KALAHARI LIMITED, ATLANTA, GA. FILED 1-5-2001.

CEREAL BAKED INTO A BAR

FOR SNACK FOOD, TOAST AND COOKIE (U.S. CL. 46).

FIRST USE 11-29-2000; IN COMMERCE 11-29-2000.

SN 78-047,957. NABISCO BRANDS COMPANY, WILMINGTON, DE. FILED 2-12-2001.

NABISCO KIDS

OWNER OF U.S. REG. NOS. 2,072,344, 2,209,475 AND OTHERS.

FOR COOKIES, CRACKERS, PRETZELS, CORN CHIPS, CHEESE FLAVORED PUFFED CORN SNACKS, SNACKS, NAMELY, WHEAT-BASED, RICE-BASED AND CORN-BASED SNACK FOODS, SNACK MIX CONSISTING PRIMARILY OF CRACKERS, PRETZELS AND POPPED POPCORN, CONES FOR ICE CREAM, COOKIE AND CRACKER CRUMBS, PIE CRUSTS, READY-TO-EAT CEREAL DERIVED FOOD BARS, GRANOLA-BASED SNACK BARS, TOASTER PASTRIES AND TARTS (U.S. CL. 46).

SN 78-055,303. QUAKER OATS COMPANY, THE, CHICAGO, IL. FILED 3-27-2001.

QUAKER FRUIT & OATMEAL NIBBLINS

OWNER OF U.S. REG. NOS. 1,190,876, 1,346,584 AND OTHERS.

NO CLAIM IS MADE TO THE EXCLUSIVE RIGHT TO USE "FRUIT & OATMEAL", APART FROM THE MARK AS SHOWN.

FOR GRAIN-BASED SNACKS (U.S. CL. 46).

SN 78-069,684. ALESSI LEANDRO & GABRIELLA S.R.L., PANZANO IN CHIANTI, ITALY, FILED 6-18-2001.

ASPERSO

THE ENGLISH TRANSLATION OF THE WORD "ASPERSO" IN THE MARK IS "SPRINKLED".

FOR SPICES (U.S. CL. 46).

SN 78-076,716. BRTEK, MARK D., ELK GROVE, CA. FILED 7-31-2001.

SINGING PIG

FOR PREPACKAGED SALSAS, MUSTARDS, MARINADES, BBQ SAUCES (U.S. CL. 46).
FIRST USE 1-1-1997; IN COMMERCE 3-15-1997.

CLASS 30—(Continued).

SN 78-083,596. J.M. SCHNEIDER INC., KITCHENER, ONTARIO, FILED 9-12-2001.

SCHNEIDERS SWEET STUFFS

OWNER OF U.S. REG. NOS. 1,058,615, 2,037,644 AND OTHERS.

NO CLAIM IS MADE TO THE EXCLUSIVE RIGHT TO USE "SWEET", APART FROM THE MARK AS SHOWN.

FOR FROZEN AND PREPACKAGED ENTREES AND MEALS, AND STUFFED PASTRY MEALS ALL CONSISTING PRIMARILY OF PASTRY, RICE, PASTA OR PASTRY, ICE CREAM, SAUCES OR ANY COMBINATION THEREOF (U.S. CL. 46).

SN 78-084,695. WOLFF, DEENA, SCARSDALE, NY. FILED 9-20-2001.

MUSEUMMINTS

FOR CANDY MINTS (U.S. CL. 46).

CLASS 31—NATURAL AGRICULTURAL PRODUCTS

SN 75-801,172. SCHWARZ, THOMAS V., CALEDONIA, MI. FILED 9-16-1999.

VICTORIA'S GARDEN

NO CLAIM IS MADE TO THE EXCLUSIVE RIGHT TO USE "GARDEN", APART FROM THE MARK AS SHOWN.

FOR PLANT SEED AND MULCH MIXTURE (U.S. CLS. 1 AND 46).

SN 75-809,563. PICKSEED CANADA INC., LINDSAY, ONTARIO, CANADA, FILED 9-28-1999.

GOOD THINGS GROWING

PRIORITY CLAIMED UNDER SEC. 44(D) ON CANADA APPLICATION NO. 1,011,085, FILED 4-7-1999, REG. NO. TMA544379, DATED 5-2-2001, EXPIRES 5-2-2016.

FOR TURF GRASS SEEDS, FORAGE GRASS SEEDS AND AGRICULTURAL LEGUME SEEDS (U.S. CLS. 1 AND 46).

SN 75-871,568. MINNESOTA CORN PROCESSORS, INC., MARSHALL, MN. FILED 12-14-1999.

LIQUID GOLD

NO CLAIM IS MADE TO THE EXCLUSIVE RIGHT TO USE "LIQUID", APART FROM THE MARK AS SHOWN. FOR ANIMAL FEED (U.S. CLS. 1 AND 46).

CLASS 31—(Continued).

SN 75-884,634. ADVANCED FOOD TECHNOLOGY, INC., CARMEL, IN. FILED 12-30-1999.

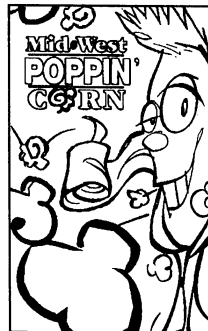

NO CLAIM IS MADE TO THE EXCLUSIVE RIGHT TO USE "POPPIN CORN", APART FROM THE MARK AS SHOWN.

FOR UNPOPPED POPCORN (U.S. CLS. 1 AND 46). FIRST USE 3-0-1998; IN COMMERCE 1-29-1999.

SN 75-910,624. BROWN EARTH COMPANY, INC., PAWLING, NY. FILED 2-5-2000.

BURLO

FOR BIODEGRADABLE PLANT PROTECTOR AND GROWTH ENHANCEMENT DEVICE, NAMELY PLANT GROWTH REGULATORS FOR AGRICULTURAL USE, WHICH ARE PLACED ON OR IN THE SOIL ADJACENT TO A PLANT (U.S. CLS. 1 AND 46). FIRST USE 4-11-2000; IN COMMERCE 4-11-2000.

SN 76-083,095. WEINERT, MICHAEL, 85551 KIRCHHEIM, FED REP GERMANY, FILED 7-5-2000.



OWNER OF FED REP GERMANY REG. NO. 39637291, DATED 10-15-1996, EXPIRES 8-31-2006.

THE ENGLISH TRANSLATION OF "FROSCH" IS "FROG". FOR NATURAL LIVING PLANTS (U.S. CLS. 1 AND 46).

CLASS 31—(Continued).

SN 76-093,288. BELMONT PRODUCE SALES, INC., REED-
LEY, CA. FILED 7-21-2000.

BELMONT

FOR FRESH FRUIT, NAMELY GRAPES (U.S. CLS. 1
AND 46).

FIRST USE 7-0-1989; IN COMMERCE 7-0-1989.

SN 76-103,213. EIGHT IN ONE PET PRODUCTS, INC.,
HAUPPAGUE, NY. FILED 8-3-2000.

TOOB SNAX

NO CLAIM IS MADE TO THE EXCLUSIVE RIGHT TO
USE "SNAX", APART FROM THE MARK AS SHOWN.

FOR PET FOOD AND EDIBLE DOG TREATS (U.S.
CLS. 1 AND 46).

SN 76-110,591. BLAINE DAIRY PRODUCTS COMPANY,
WATONGA, OK. FILED 8-17-2000.

HOSTEMARK

THE ENGLISH TRANSLATION OF THE MARK "HOSTE-
MARK" IS "HARVEST FIELDS".

FOR UNPROCESSED FRUIT, NAMELY GRAPES
USED IN WINE PRODUCTION; LIVE GRAPE PLANT
CUTTINGS (U.S. CLS. 1 AND 46).

FIRST USE 9-14-1998; IN COMMERCE 4-10-1999.

SN 76-111,707. RENESSEN LLC, BANNOCKBURN, IL.
FILED 8-17-2000.

XENGROW

FOR AGRICULTURAL SEED; ANIMAL FEED AND
FEED SUPPLEMENTS; UNPROCESSED GRAIN FOR
AGRICULTURAL PURPOSES (U.S. CLS. 1 AND 46).

SN 76-173,773. ROCKY MOUNTAIN PET PRODUCTS, INC.,
LOGAN, UT. FILED 11-30-2000.

ROCKY MOUNTAIN

FOR PET FOOD PRODUCTS, NAMELY, DOG BIS-
CUITS, DOG TREATS, PET BISCUITS, ANIMAL BIS-
CUITS, DOG FOOD, PET FOOD (U.S. CLS. 1 AND 46).

FIRST USE 5-1-2000; IN COMMERCE 5-1-2000.

CLASS 31—(Continued).

SN 76-192,254. AOKI CORPORATION, ACTON, MA. FILED
1-10-2001.

FILMCHIP

FOR PACKAGED UPROCESSED FOODSTUFFS,
NAMELY, UNPROCESSED HERBS, UNPROCESSED
BEANS, UNPROCESSED NUTS, UPROCESSED GRAINS
FOR EATING, UNPROCESSED OATS, UNPROCESSED
WHEAT, UNPROCESSED CEREALS AND FRESH
FRUITS AND VEGETABLES (U.S. CLS. 1 AND 46).

SN 76-200,730. INNOVATIVE PRODUCTS OF OHIO, LLC,
NORTH CANTON, OH. FILED 1-29-2001.

MUGSEY'S

FOR PET FOOD (U.S. CLS. 1 AND 46).

SN 76-229,598. SUNTORY LIMITED, KITA-KU, OSAKA,
JAPAN, FILED 3-23-2001.

SUMMER SPLASH

FOR AGRICULTURAL, HORTICULTURAL AND
FORESTRY PRODUCTS, NAMELY AGRICULTURAL
GRAINS FOR PLANTING, AGRICULTURAL AND HOR-
TICULTURAL SEEDS, FLOWER BULBS, SEEDLINGS,
LIVING PLANTS, LIVING FLOWERS, DRIED FLOWERS
FOR DECORATION, AND WREATHS OF LIVING
FLOWERS (U.S. CLS. 1 AND 46).

SN 76-231,437. TRIUMPH PET INDUSTRIES, INC., WAR-
WICK, NY. FILED 3-27-2001.

NATURE'S TREATS

OWNER OF U.S. REG. NO. 1,820,767.
NO CLAIM IS MADE TO THE EXCLUSIVE RIGHT TO
USE "TREATS", APART FROM THE MARK AS SHOWN.
FOR PET FOOD (U.S. CLS. 1 AND 46).

SN 76-231,523. ECOLOTREE, INC., IOWA CITY, IA. FILED 3-
28-2001.

EBUFFER

FOR LIVE TREE FOR USE IN ENVIRONMENTAL
REMEDICATION, NAMELY, PHYTOREMEDIATION (U.S.
CLS. 1 AND 46).

FIRST USE 3-0-1990; IN COMMERCE 3-0-1990.

CLASS 31—(Continued).

SN 76-279,089. SUNSHINE MILLS, INC., RED BAY, AL.
FILED 7-2-2001.

OMEGAPRIDE

FOR PET FOOD (U.S. CLS. 1 AND 46).

SN 78-024,142. MILLER, AMY, ALTO, MI. FILED 9-1-2000.

THE QUEEN MUM

FOR LIVE FLOWERS, LIVE PLANTS, AND FLOWER
AND PLANT SEEDS (U.S. CLS. 1 AND 46).

SN 78-073,758. UNIQUE PET CARE COMPANY, WILMING-
TON, DE. FILED 7-13-2001.

**PROSORPTION
TECHNOLOGY**

FOR PET FOOD (U.S. CLS. 1 AND 46).

SN 78-077,646. RALSTON PURINA COMPANY, ST. LOUIS,
MO. FILED 8-6-2001.

NF KIDNEY FUNCTION

NO CLAIM IS MADE TO THE EXCLUSIVE RIGHT TO
USE "KIDNEY FUNCTION", APART FROM THE MARK AS
SHOWN.

FOR PET FOOD (U.S. CLS. 1 AND 46).

SN 78-083,806. RALSTON PURINA COMPANY, ST. LOUIS,
MO. FILED 9-13-2001.

CHEW-RRRIFIC

FOR PET FOOD (U.S. CLS. 1 AND 46).

SN 78-084,628. DOLE FRESH FRUIT COMPANY, WES-
TLAKE VILLAGE, CA. FILED 9-19-2001.

TROPICAL GOLD

OWNER OF U.S. REG. NO. 1,265,895.
FOR FRESH FRUITS (U.S. CLS. 1 AND 46).

CLASS 32—LIGHT BEVERAGES

SN 75-259,261. MOOSEHEAD BREWERIES LIMITED, SAINT
JOHN, NEW BRUNSWICK, CANADA, FILED 3-18-1997.

**MOOSEHEAD INDIA PALE
ALE**

PRIORITY CLAIMED UNDER SEC. 44(D) ON CANADA
APPLICATION NO. 835535, FILED 2-4-1997, REG. NO.
TMA493300, DATED 4-21-1998, EXPIRES 4-21-2013.

NO CLAIM IS MADE TO THE EXCLUSIVE RIGHT TO
USE "INDIA PALE ALE", APART FROM THE MARK AS
SHOWN.

FOR BREWED ALCOHOLIC BEVERAGES, NAMELY,
BEERS AND ALES (U.S. CLS. 45, 46 AND 48).

SN 75-702,458. BLUE SKY NATURAL BEVERAGE COM-
PANY, SANTA FE, NM. FILED 5-11-1999.

ROOT BEER ENCORE

NO CLAIM IS MADE TO THE EXCLUSIVE RIGHT TO
USE "ROOT BEER", APART FROM THE MARK AS SHOWN.
FOR ORGANIC CARBONATED SOFT DRINKS (U.S.
CLS. 45, 46 AND 48).

SN 75-795,900. HEINZ ITALIA S.R.L., 04100 LATINA, ITALY,
FILED 9-9-1999.

BI-AGLUT

OWNER OF ITALY REG. NO. 425101, DATED 5-19-1986,
RENEWED AS REG. NO. 696667, DATED 12-12-1996, EX-
PIRES 6-10-2004.

OWNER OF U.S. REG. NO. 1,482,991.
FOR DIETETIC DRINKS, NAMELY, GLUTEN-FREE
SOFT DRINKS AND GLUTEN-FREE BEER (U.S. CLS. 45,
46 AND 48).

SN 76-036,296. ALASKAN BREWING CO., JUNEAU, AK.
FILED 5-1-2000.

ALASKAN WINTER ALE

OWNER OF U.S. REG. NO. 1,828,482.
NO CLAIM IS MADE TO THE EXCLUSIVE RIGHT TO
USE "WINTER ALE", APART FROM THE MARK AS
SHOWN.

SEC. 2(F) AS TO "ALASKAN".
FOR BEER AND ALE (U.S. CLS. 45, 46 AND 48).

CLASS 32—(Continued).

SN 76-066,076. GFY BEVERAGES COMPANY, NEW YORK, NY. FILED 6-8-2000.

JOSE MARTÍ

THE NAME "JOSE MARTI" DOES NOT IDENTIFY A LIVING INDIVIDUAL.
FOR BEER AND ALE (U.S. CLS. 45, 46 AND 48).

SN 76-073,404. AMERICAN ENTERPRISES INTERNATIONAL, INC., ORANGE, CA. FILED 6-19-2000.

American
Seltzer

NO CLAIM IS MADE TO THE EXCLUSIVE RIGHT TO USE "AMERICAN SELTZER", APART FROM THE MARK AS SHOWN.
FOR SPARKLING FLAVORED WATER BEVERAGE (U.S. CLS. 45, 46 AND 48).

SN 76-085,553. YADAX EXPORT-IMPORT UND SPEDITION GMBH, FRANKFURT, FED REP GERMANY, FILED 7-7-2000.



NO CLAIM IS MADE TO THE EXCLUSIVE RIGHT TO USE "PILSNER PREMIUM BEER", APART FROM THE MARK AS SHOWN.
THE MARK IS LINED FOR THE COLORS GOLDEN YELLOW AND RED.
FOR BEER (U.S. CLS. 45, 46 AND 48).

CLASS 32—(Continued).

SN 76-087,756. APPLE HILL ORCHARDS JUICE COMPANY, DOLORES, CO. FILED 7-11-2000.

**HONEST JUICE FROM
HONEST FRUIT**

FOR BEVERAGES NAMELY NATURAL FRUIT JUICE DRINKS (U.S. CLS. 45, 46 AND 48).
FIRST USE 5-17-2000; IN COMMERCE 5-17-2000.

SN 76-089,100. JOSEPH E. SEAGRAM & SONS, INC., NEW YORK, NY. FILED 7-14-2000.



NO CLAIM IS MADE TO THE EXCLUSIVE RIGHT TO USE "SPIKED LEMONADE", APART FROM THE MARK AS SHOWN.
FOR BEER-BASED FLAVORED MALT BEVERAGE (U.S. CLS. 45, 46 AND 48).
FIRST USE 5-8-2000; IN COMMERCE 5-8-2000.

SN 76-092,615. S. MARTINELLI & COMPANY, WATSONVILLE, CA. FILED 7-18-2000.

DRINK YOUR APPLE A DAY

OWNER OF U.S. REG. NO. 805,305.
SEC. 2(F).
FOR FRUIT JUICES, AERATED FRUIT JUICES AND SWEET CIDER (U.S. CLS. 45, 46 AND 48).
FIRST USE 9-0-1929; IN COMMERCE 9-0-1929.

SN 76-104,491. BRANDBREW S.A., LUXEMBOURG, BY ASSIGNMENT BASS MACHINE HOLDINGS LIMITED, LONDON, ENGLAND, FILED 7-31-2000.

HOOPER'S HOOCH ICE

OWNER OF U.S. REG. NOS. 2,223,486, 2,249,716 AND 2,354,537.
NO CLAIM IS MADE TO THE EXCLUSIVE RIGHT TO USE "ICE", APART FROM THE MARK AS SHOWN.
FOR SPARKLING ALCOHOLIC MALT LIQUOR; BREWED ALCOHOLIC MALT LIQUOR; FLAVOURED BEER; BEER (U.S. CLS. 45, 46 AND 48).

CLASS 32—(Continued).

SN 76-117,777. JUGOS DEL VALLE, S.A. DE C.V., EDO. DE MEXICO, MEXICO, FILED 8-28-2000.



OWNER OF U.S. REG. NOS. 1,587,050, 2,406,925 AND OTHERS.

NO CLAIM IS MADE TO THE EXCLUSIVE RIGHT TO USE "JUGOS", APART FROM THE MARK AS SHOWN.

THE ENGLISH TRANSLATION OF "JUGOS DEL VALLE" IS "JUICES OF THE VALLEY".

FOR MINERAL AND AERATED WATERS; NONALCOHOLIC MALT COOLERS; NONALCOHOLIC PUNCH, FRUIT FLAVORED SOFT DRINKS, FRUIT FLAVORED DRINKS, SOFT DRINKS, SPORTS DRINKS; FRUIT DRINKS AND FRUIT JUICES; CONCENTRATES, SYRUPS OR POWDERS USED IN THE PREPARATION OF SOFT DRINKS (U.S. CLS. 45, 46 AND 48).

FIRST USE 7-1-1999; IN COMMERCE 3-1-2000.

SN 76-156,297. SMUCKER QUALITY BEVERAGES, INC., CHICO, CA. FILED 10-30-2000.

TASTE HOW GOOD HEALTH CAN BE

FOR NON-ALCOHOLIC FRUIT BASED BEVERAGES (U.S. CLS. 45, 46 AND 48).

SN 76-156,298. SMUCKER QUALITY BEVERAGES, INC., CHICO, CA. FILED 10-30-2000.

INNER STRENGTH

FOR NON-ALCOHOLIC NUTRITIONALLY FORTIFIED FRUIT-BASED BEVERAGES (U.S. CLS. 45, 46 AND 48).

SN 76-199,887. TRIWATER USA, INC., NEPTUNE, NJ. FILED 1-25-2001.

DRINK YOUR OXYGEN!

FOR DRINKING WATER, NAMELY, FLAVORED, UNFLAVORED, CARBONATED AND NON-CARBONATED OXYGENATED DISTILLED DRINKING WATER (U.S. CLS. 45, 46 AND 48).

FIRST USE 1-0-2000; IN COMMERCE 1-0-2000.

CLASS 32—(Continued).

SN 76-213,387. COCA-COLA COMPANY, THE, ATLANTA, GA. FILED 2-21-2001.

MINUTE MAID PREMIUM BLENDS

OWNER OF U.S. REG. NOS. 927,454, 950,902 AND 1,041,924.

NO CLAIM IS MADE TO THE EXCLUSIVE RIGHT TO USE "PREMIUM BLENDS", APART FROM THE MARK AS SHOWN.

FOR FRUIT DRINKS, FRUIT JUICES AND FRUIT FLAVORED ADES AND PUNCHES; AND SYRUPS, CONCENTRATES AND POWDERS FOR MAKING FRUIT DRINKS, FRUIT JUICES AND FRUIT FLAVORED ADES AND PUNCHES (U.S. CLS. 45, 46 AND 48).

SN 76-247,401. LONG ISLAND LEMONADE COMPANY, INC., DIX HILLS, NY. FILED 4-27-2001.

MANGO MOUNTAIN

NO CLAIM IS MADE TO THE EXCLUSIVE RIGHT TO USE "MANGO", APART FROM THE MARK AS SHOWN.

FOR NON-ALCOHOLIC BEVERAGES, NAMELY LEMONADE AND SOFT DRINKS; CARBONATED AND NON-CARBONATED BEVERAGES WITH ADDITIONAL FLAVORS, NAMELY LEMON, LIME AND MANGO (U.S. CLS. 45, 46 AND 48).

SN 76-293,554. CAROLINA BEVERAGE CORPORATION, SALISBURY, NC. FILED 8-1-2001.

ISLAND PUNCH

NO CLAIM IS MADE TO THE EXCLUSIVE RIGHT TO USE "PUNCH", APART FROM THE MARK AS SHOWN.

FOR FRUIT FLAVORED DRINKS (U.S. CLS. 45, 46 AND 48).

SN 76-293,614. ITO EN (NORTH AMERICA) INC., NEW YORK, NY. FILED 8-1-2001.

GOTTA JUICE

NO CLAIM IS MADE TO THE EXCLUSIVE RIGHT TO USE "JUICE", APART FROM THE MARK AS SHOWN.

FOR VEGETABLE AND FRUIT JUICES (U.S. CLS. 45, 46 AND 48).

CLASS 32—(Continued).

SN 76-299,930. ITO EN (NORTH AMERICA) INC., NEW YORK, NY. FILED 8-14-2001.

**gotta
juice**

NO CLAIM IS MADE TO THE EXCLUSIVE RIGHT TO USE "JUICE", APART FROM THE MARK AS SHOWN.
FOR VEGETABLE AND FRUIT JUICES (U.S. CLS. 45, 46 AND 48).

SN 78-068,635. NULAB, INC., CLEARWATER, FL. FILED 6-12-2001.

KANGAROO FALLS

FOR LIGHT BEVERAGE, NAMELY, WATER WITH HERBAL EXTRACTS AND FLAVORINGS (U.S. CLS. 45, 46 AND 48).

SN 78-074,165. CSC BRANDS LP, CAMDEN, NJ. FILED 7-16-2001.

DID YOU KNOW?

FOR VEGETABLE JUICES (U.S. CLS. 45, 46 AND 48).

SN 78-075,014. CABO, RICHARD F., NEWPORT BEACH, CA. FILED 7-20-2001.

BEER BONG

NO CLAIM IS MADE TO THE EXCLUSIVE RIGHT TO USE "BEER", APART FROM THE MARK AS SHOWN.
FOR BEER (U.S. CLS. 45, 46 AND 48).

SN 78-083,650. PEPSICO, INC., PURCHASE, NY. FILED 9-12-2001.

**A LITTLE TWIST ON A
GOOD THING**

FOR SOFT DRINKS (U.S. CLS. 45, 46 AND 48).

CLASS 32—(Continued).

SN 78-083,656. PEPSICO, INC., PURCHASE, NY. FILED 9-12-2001.

**A LITTLE TWIST ON A
GREAT THING**

FOR SOFT DRINKS (U.S. CLS. 45, 46 AND 48).

CLASS 33—WINES AND SPIRITS

SN 75-350,912. CUSENIER SAIC, 1073 BUENOS AIRES, ARGENTINA, FILED 9-3-1997.

ETCHART



RIO de
PLATA

OWNER OF ARGENTINA REG. NO. 1753166, DATED 9-17-1999, EXPIRES 9-17-2009.

OWNER OF U.S. REG. NOS. 1,876,182 AND 1,971,617.
THE MARK CONSISTS OF A VERTICAL BAR CONTAINING DESIGNS OF A HOUSE, A WATERCOURSE, A PLAIN, A DESERT, TROPICAL VEGETATION AND A SNOW-COVERED MOUNTAIN.

THE ENGLISH TRANSLATION OF "RIO PLATA" IS "SILVER RIVER".

FOR WINES (U.S. CLS. 47 AND 49).

CLASS 33—(Continued).

SN 75-616,228. V&S VIN & SPRIT AKTIEBOLAG, S-117 97 STOCKHOLM, SWEDEN, FILED 1-6-1999.

ABSOLUT
Country of Sweden
MANDRIN

Absolut Mandrin is made from a unique blend of natural mandarin and orange flavors and vodka distilled from grain grown in the rich fields of southern Sweden. The distilling and flavoring of vodka is an age-old Swedish tradition. Vodka has been sold under the name Absolut since 1879.

OWNER OF U.S. REG. NOS. 1,302,003, 2,023,285 AND OTHERS.

NO CLAIM IS MADE TO THE EXCLUSIVE RIGHT TO USE "IS MADE FROM A UNIQUE BLEND OF NATURAL MANDARIN AND ORANGE FLAVORS AND VODKA DISTILLED FROM GRAIN GROWN IN THE RICH FIELDS OF SOUTHERN SWEDEN. THE DISTILLING AND FLAVORING OF VODKA IS AN AGE-OLD SWEDISH TRADITION. VODKA HAS BEEN SOLD UNDER THE NAME SINCE 1879", APART FROM THE MARK AS SHOWN.

THE ENGLISH TRANSLATION OF THE WORD "ABSOLUT" IN THE MARK IS "ABSOLUTE".

SEC. 2(F) AS TO "COUNTRY OF SWEDEN".

FOR ALCOHOLIC BEVERAGES, NAMELY VODKA (U.S. CLS. 47 AND 49).

FIRST USE 7-1-1999; IN COMMERCE 7-1-1999.

SN 75-902,762. N.B.I. ACQUISITIONS LLC, BERKELEY, CA. FILED 1-26-2000.

RIATA

FOR WINE (U.S. CLS. 47 AND 49).

SN 75-922,856. WARRE & CA. S.A., APARTADO 26, CODEX, PORTUGAL, FILED 2-17-2000.

WARRE'S OTIMA

OWNER OF U.S. REG. NOS. 1,124,132 AND 1,613,176. NO CLAIM IS MADE TO THE EXCLUSIVE RIGHT TO USE "OTIMA", APART FROM THE MARK AS SHOWN.

THE ENGLISH TRANSLATION OF "OTIMA" IS "EXCELLENT" OR "SUPERIOR".

FOR PORT WINE (U.S. CLS. 47 AND 49).

CLASS 33—(Continued).

SN 76-015,203. TEQUILA CUERVO LA ROJENA, S.A. DE C.V., ZAPOPAN JALISCO CODIGO 45070, MEXICO, FILED 3-31-2000.

JOSE CUERVO MARGARITA SEASON

OWNER OF U.S. REG. NOS. 1,404,313 AND 1,598,863.

NO CLAIM IS MADE TO THE EXCLUSIVE RIGHT TO USE "MARGARITA", APART FROM THE MARK AS SHOWN.

THE NAME "JOSE CUERVO" DOES NOT IDENTIFY A PARTICULAR LIVING INDIVIDUAL.

FOR PREPARED ALCOHOLIC COCKTAIL CONTAINING TEQUILA AND MARGARITA MIX (U.S. CLS. 47 AND 49).

SN 76-052,997. SANTA LUCIA WINERY, INC., TEMPLETON, CA. BY ASSIGNMENT VOLK III, KENNETH, TEMPLETON, CA. FILED 5-22-2000.



CHEVAL SAUVAGE

THE STIPPLING IN THE APPLICATION DRAWING IS NOT INTENDED TO INDICATE COLOR.

THE ENGLISH TRANSLATION OF THE WORDING "CHEVAL SAUVAGE" IS "SAVAGE HORSE".

FOR WINE (U.S. CLS. 47 AND 49).

FIRST USE 10-1-1992; IN COMMERCE 10-1-1992.

SN 76-061,191. BECKMEN, STEVE, LOS OLIVOS, CA. FILED 6-5-2000.

BECKMEN VINEYARDS

NO CLAIM IS MADE TO THE EXCLUSIVE RIGHT TO USE "VINEYARDS", APART FROM THE MARK AS SHOWN.

SEC. 2(F).

FOR WINE (U.S. CLS. 47 AND 49).

FIRST USE 6-1-1995; IN COMMERCE 6-1-1995.

CLASS 33—(Continued).

SN 76-062,292. TEQUILA CUERVO LA ROJENA, S.A. DE C.V., ZAPOPAN JALISCO, CODIGO 45070, MEXICO, FILED 6-5-2000.

SELECCION 1800

THE ENGLISH TRANSLATION OF "SELECCION" IS "SELECTION"
FOR ALCOHOLIC BEVERAGES, NAMELY TEQUILA (U.S. CLS. 47 AND 49).

SN 76-083,424. STIMSON LANE LTD., WOODINVILLE, WA. FILED 7-6-2000.

ELARA

FOR WINE (U.S. CLS. 47 AND 49).

SN 76-103,069. CASA LAPOSTOLLE S.A., SANTIAGO, CHILE, FILED 8-7-2000.

**CHILEAN BY NATURE,
FRENCH BY DESIGN**

FOR WINE (U.S. CLS. 47 AND 49).

SN 76-110,903. CAV. G.B. BERTANI S.R.L., NEGRAR FRAZIONE ARBIZZANO (VERONA), ITALY, FILED 8-17-2000.

LE LAVE

FOR WINE, RED WINE, WHITE WINE, APERITIF WINE, SPARKLING WINE, PORT WINE (U.S. CLS. 47 AND 49).
FIRST USE 12-31-1990; IN COMMERCE 7-1-1991.

CLASS 33—(Continued).

SN 76-158,184. FEDWAY ASSOCIATES, INC., KEARNY, NJ. FILED 11-2-2000.

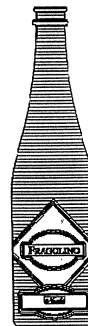

OWNER OF U.S. REG. NO. 1,087,809.
NO CLAIM IS MADE TO THE EXCLUSIVE RIGHT TO USE THE CONFIGURATION OF THE WINE BOTTLE OR THE TERM "FRAGOLINO", APART FROM THE MARK AS SHOWN.

THE MARK CONSISTS, IN PART, OF THE CONFIGURATION OF A WINE BOTTLE. THE BLUE COLOR OF THE BOTTLE IS CLAIMED AS A FEATURE OF THE MARK. THE LABEL ON THE BOTTLE CONTAINS THE WORDING "FRAGOLINO" AND "NANDO".

FOR SPARKLING WINE (U.S. CLS. 47 AND 49).
FIRST USE 9-1-2000; IN COMMERCE 9-1-2000.

SN 76-182,974. PIPER HEIDSIECK - ANCIENNE MAISON HEIDSIECK FONDEE EN 1785 COMPAGNIE CHAMPE-NOISE S.A., 51100 REIMS, FRANCE, FILED 12-19-2000.

BABY PIPER

PRIORITY CLAIMED UNDER SEC. 44(D) ON FRANCE APPLICATION NO. 003035209, FILED 6-19-2000, REG. NO. 00/3035209, DATED 6-19-2000, EXPIRES 6-19-2010.
FOR CHAMPAGNE (U.S. CLS. 47 AND 49).

SN 76-191,433. JOHNSON, JAMES R., DBA JAMES JOHNSON VINEYARDS, ST HELENA, CA. FILED 1-8-2001.

BISOU

THE ENGLISH TRANSLATION OF "BISOU" IS "KISS".
FOR WINE AND SPIRITS (U.S. CLS. 47 AND 49).

SN 76-205,425. UNITED STATES DISTILLED PRODUCTS COMPANY, PRINCETON, MN. FILED 2-5-2001.

WHITE EAGLE

NO CLAIM IS MADE TO THE EXCLUSIVE RIGHT TO USE "WHITE", APART FROM THE MARK AS SHOWN.
FOR VODKA (U.S. CLS. 47 AND 49).

CLASS 33—(Continued).

SN 76-284,752. GNEKOW FAMILY WINERY, COLLEGEVILLE, CA. FILED 7-13-2001.



NO CLAIM IS MADE TO THE EXCLUSIVE RIGHT TO USE THE OUTLINE OF THE STATE OF CALIFORNIA, APART FROM THE MARK AS SHOWN.
FOR WINE (U.S. CLS. 47 AND 49).
FIRST USE 4-28-2001; IN COMMERCE 4-28-2001.

SN 78-031,267. LA COFRADIA S.A. DE C.V., TEQUILA, JALISCO, MEXICO, FILED 10-18-2000.

TEQUILA DE LOS DORADOS

NO CLAIM IS MADE TO THE EXCLUSIVE RIGHT TO USE "TEQUILA", APART FROM THE MARK AS SHOWN.
THE ENGLISH TRANSLATION OF "TEQUILA DE LOS DORADOS" IS "TEQUILA OF THE GOLDEN" OR "TEQUILA OF THE GILT".
FOR TEQUILA (U.S. CLS. 47 AND 49).

SN 78-036,195. MBT WINE & SPIRITS, HALLANDALE, FL. FILED 11-21-2000.

SVOBODA

"SVOBODA", TRANSLATED INTO ENGLISH AS "FREEDOM".
FOR DISTILLED SPIRITS (U.S. CLS. 47 AND 49).
FIRST USE 11-21-2000; IN COMMERCE 11-21-2000.

SN 78-053,076. CHAIN OF PONDS WINES PTY LTD, FELIXSTOW, AUSTRALIA, FILED 3-14-2001.

PUDDING PAN

OWNER OF AUSTRALIA REG. NO. 860654, DATED 12-13-2000, EXPIRES 12-13-2010.
FOR WINES (U.S. CLS. 47 AND 49).

CLASS 33—(Continued).

SN 78-057,163. SOTER, TONY, NAPA, CA. FILED 4-6-2001.

BEACON HILL

FOR WINE (U.S. CLS. 47 AND 49).

SN 78-057,167. SOTER, TONY, NAPA, CA. FILED 4-6-2001.

PRAXIS

FOR WINE (U.S. CLS. 47 AND 49).

CLASS 34—SMOKERS' ARTICLES

SN 75-848,574. LOLA CIGARS CORPORATION, MIAMI, FL. FILED 11-16-1999.

SALSA

THE ENGLISH TRANSLATION OF "SALSA" IS "SAUCE".
FOR CIGARS (U.S. CLS. 2, 8, 9 AND 17).
FIRST USE 12-17-1999; IN COMMERCE 12-17-1999.

SN 76-194,774. TTGC, LIMITED, HARBOUR CENTRE, CAYMAN ISLANDS, FILED 1-16-2001.

WILD HORSE

FOR CIGARETTES (U.S. CLS. 2, 8, 9 AND 17).

SN 76-232,093. BELLO, PEDRO, SR., MIAMI, FL. FILED 3-19-2001.

P. BELLO Y CIA.

NO CLAIM IS MADE TO THE EXCLUSIVE RIGHT TO USE "Y CIA.", APART FROM THE MARK AS SHOWN.
"Y CIA." IS AN EQUIVALENT TO "AND COMPANY", WHERE "Y" IS THE SPANISH WORD FOR "AND", AND "CIA." IS THE ABBREVIATION FOR THE SPANISH WORD "COMPANIA".
FOR CIGARS, CIGAR CUTTERS, CASES, LIGHTERS NOT OF PRECIOUS METAL, ASHTRAYS (U.S. CLS. 2, 8, 9 AND 17).

CLASS 34—(Continued).

SN 76-233,074. P.T.C. BRANDS, INC., WILMINGTON, DE.
FILED 4-2-2001.

COUNTRY PRIDE

OWNER OF U.S. REG. NOS. 1,042,464, 1,304,051 AND
1,857,355.
FOR CHEWING TOBACCO (U.S. CLS. 2, 8, 9 AND 17).

SN 76-248,175. CONROS CORPORATION, SCARBOROUGH,
ONTARIO, FILED 4-30-2001.

STARTERMATCH

FOR MATCHES (U.S. CLS. 2, 8, 9 AND 17).

SN 76-258,648. ATLANTIC CIGAR CO., INC., MIAMI
BEACH, FL. FILED 5-17-2001.

FAIR EXCHANGE

FOR CIGARS (U.S. CLS. 2, 8, 9 AND 17).

SN 76-309,345. R & E ENTERPRISES, ROCKFORD, IL. FILED
8-30-2001.

DRI-DAMP

FOR CIGAR MOISTURE LEVEL INDICATOR (U.S.
CLS. 2, 8, 9 AND 17).
FIRST USE 8-15-2001; IN COMMERCE 8-15-2001.

SN 76-310,257. D&D OF SOUTH FLORIDA INC., DBA
SMOKE INN, TEQUESTA, FL. FILED 9-7-2001.

**BRINGING OLD
TRADITIONS TO NEW
FRIENDS**

FOR CIGARS (U.S. CLS. 2, 8, 9 AND 17).
FIRST USE 8-0-1997; IN COMMERCE 8-0-1997.

CLASS 34—(Continued).

SN 78-012,157. BORYSIEWICZ, JEFFREY M, ORLANDO, FL.
FILED 6-12-2000.

EL CHEAPO

"EL" IN SPANISH IS EQUIVALENT TO THE ENGLISH
WORD "THE".
FOR CIGARS (U.S. CLS. 2, 8, 9 AND 17).
FIRST USE 8-1-2000; IN COMMERCE 8-1-2000.

SN 78-017,979. TOBACCO & CANDY INTERNATIONAL,
MIAMI, FL. FILED 7-22-2000.

CORONADO CIGARETTES

NO CLAIM IS MADE TO THE EXCLUSIVE RIGHT TO
USE "CIGARETTES", APART FROM THE MARK AS
SHOWN.

FOR CIGARS; CIGARETTES; CIGARETTE PAPERS;
CIGARETTE LIGHTERS, CASES AND HOLDERS, NOT
OF PRECIOUS METALS; TOBACCO (U.S. CLS. 2, 8, 9
AND 17).

FIRST USE 6-1-2000; IN COMMERCE 6-1-2000.

SN 78-061,159. LANE LIMITED, TUCKER, GA. FILED 4-30-
2001.

EVER-CLEAR PACK

NO CLAIM IS MADE TO THE EXCLUSIVE RIGHT TO
USE "PACK", APART FROM THE MARK AS SHOWN.

FOR CIGARETTE TOBACCO (U.S. CLS. 2, 8, 9 AND
17).

SERVICE MARKS**CLASS 35—ADVERTISING AND BUSINESS**

SN 74-652,886. KENNEDY, PATRICK J., SAN ANTONIO, TX.
FILED 3-29-1995.

WATERMARK

FOR BUSINESS AND QUALITY ASSURANCE MAN-
AGEMENT SERVICES, NAMELY RENDERING TECH-
NICAL AID AND ASSISTANCE TO OTHERS IN THE
ESTABLISHMENT, MANAGEMENT, AND OPERATION
OF HOTELS, RESTAURANTS, AND BARS (U.S. CLS. 100,
101 AND 102).

CLASS 35—(Continued).

SN 75-260,715. AUTO STORE OF DIXON, LTD., THE, DIXON, IL. FILED 3-20-1997.

THE AUTO STORE

NO CLAIM IS MADE TO THE EXCLUSIVE RIGHT TO USE "AUTO", APART FROM THE MARK AS SHOWN.
SEC. 2(F).
FOR PRE-OWNED MOTOR VEHICLE DEALERSHIPS (U.S. CLS. 100, 101 AND 102).
FIRST USE 7-0-1992; IN COMMERCE 7-0-1992.

SN 75-505,153. MEA MEISINGER STAHL UND KUNSTSTOFF GMBH, 86543 AICHACH, FED REP GERMANY, AND JOSAM COMPANY, MICHIGAN CITY, IN. FILED 6-19-1998.

MEA-JOSAM

OWNER OF U.S. REG. NOS. 164,281 AND 1,343,778.
FOR WHOLESALE DISTRIBUTORSHIP SERVICES FEATURING DRAINAGE CHANNELS, TRENCH DRAIN FITTINGS, CATCH BASIS, GRATINGS, LOCKING MECHANISMS FOR GRATINGS, AND REINFORCED EDGING (U.S. CLS. 100, 101 AND 102).
FIRST USE 7-17-1995; IN COMMERCE 7-17-1995.

SN 75-506,734. VIRTUAL RAGS, L.L.C., EL PASO, TX. FILED 6-22-1998.

VIRTUAL RAGS

NO CLAIM IS MADE TO THE EXCLUSIVE RIGHT TO USE "RAGS", APART FROM THE MARK AS SHOWN.
FOR WHOLESALE AND RETAIL DISTRIBUTORSHIP OF CLOTHING AND CATALOG SERVICES FEATURING CLOTHING VIA A COMPUTERIZED GLOBAL INFORMATION NETWORK (U.S. CLS. 100, 101 AND 102).
FIRST USE 2-15-1998; IN COMMERCE 2-15-1998.

SN 75-706,744. IVY, JERRY, DBA IID, INC., SEATTLE, WA. FILED 5-14-1999.

Your Beauty Connection

FOR RETAIL SERVICES, NAMELY, COSMETICS, HEALTH AND BEAUTY PRODUCTS OFFERED VIA RETAIL OUTLETS, RETAIL STORES, WHOLESALE OUTLETS, WHOLESALE DISTRIBUTORSHIPS AND COMPUTER NETWORKS AND GLOBAL COMMUNICATION NETWORKS (U.S. CLS. 100, 101 AND 102).
FIRST USE 5-12-1999; IN COMMERCE 5-12-1999.

CLASS 35—(Continued).

SN 75-712,189. ECOUPONS.COM, INC., LOS ALTOS, CA. FILED 5-21-1999.



NO CLAIM IS MADE TO THE EXCLUSIVE RIGHT TO USE "ECOUPONS", APART FROM THE MARK AS SHOWN.
FOR DISSEMINATION OF ADVERTISING FOR OTHERS VIA AN ON-LINE ELECTRONIC COMMUNICATIONS NETWORK; PROMOTING THE SALE OF GOODS AND SERVICES OF OTHERS THROUGH THE DISTRIBUTION OF PRINTED MATERIAL; PROMOTING THE SALE OF GOODS AND SERVICES OF OTHERS THROUGH THE DISTRIBUTION OF DISCOUNT CARDS (U.S. CLS. 100, 101 AND 102).

SN 75-729,514. MULTEX.COM, INC., NEW YORK, NY. FILED 6-15-1999.

MULTEX.COM

OWNER OF U.S. REG. NOS. 2,027,388, 2,329,063 AND OTHERS.
FOR ON-LINE ORDERING SERVICES FEATURING INVESTMENT RESEARCH REPORTS AND RELATED FINANCIAL AND BUSINESS RESEARCH DOCUMENTS IN THE FIELDS OF FINANCIAL RESEARCH AND FINANCIAL INVESTMENT, VIA A WEBSITE ON THE GLOBAL COMPUTER NETWORK (U.S. CLS. 100, 101 AND 102).
FIRST USE 2-5-1999; IN COMMERCE 2-5-1999.

SN 75-750,456. FIRST SECURITY, INC, VANCOUVER BC, CANADA, FILED 8-9-1999.

REWARDPOINTS4ME

FOR PROMOTING THE GOODS AND SERVICES OF OTHERS BY PREPARING AND PLACING ADVERTISEMENTS IN AN ELECTRONIC MAGAZINE ACCESSED THROUGH A GLOBAL NETWORK; PROMOTING THE GOODS AND SERVICES OF OTHERS THROUGH THE DISSEMINATION OF ADVERTISING FOR OTHERS AND CONDUCTING MEMBERSHIP LOYALTY PROGRAMS AND DISCOUNT PROGRAMS COMPRISING THE ISSUANCE OF MEMBERSHIP CARDS, POINTS, AND VOUCHERS OF VALUE WHICH CAN BE REDEEMED AT PARTICIPATING MERCHANTS; DEVELOPING PROMOTIONAL CAMPAIGNS FOR BUSINESS INVOLVING CONSUMER LOYALTY PROGRAMS; AND SALES VOLUME TRACKING FOR OTHERS (U.S. CLS. 100, 101 AND 102).

CLASS 35—(Continued).

SN 75-770,958. KLIKBACK.COM, INC., LA JOLLA, CA. FILED 8-9-1999.

KLIKBACK.COM

FOR ON-LINE PROMOTION OF THE TELECOMMUNICATION SERVICES OF OTHERS BY PLACING ADVERTISING AND INFORMATION VIA A WEBSITE ON THE GLOBAL COMPUTER NETWORK; AND ON-LINE RETAIL SERVICES FEATURING COMPUTER HARDWARE AND ACCESSORIES, CONSUMER ELECTRONIC EQUIPMENT, HOUSEHOLD GOODS AND APPLIANCES, BOOKS, COMPACT DISCS, COMPUTER SOFTWARE, GIFT BASKETS, JEWELRY AND WATCHES VIA A WEBSITE ON THE GLOBAL COMPUTER INFORMATION NETWORK (U.S. CLS. 100, 101 AND 102).

SN 75-822,468. JUPITER COMMUNICATIONS, INC., NEW YORK, NY. BY ASSIGNMENT JUPITER COMMUNICATIONS LLC, NEW YORK, NY. FILED 10-14-1999.

ONLINE INTELLIGENCE

NO CLAIM IS MADE TO THE EXCLUSIVE RIGHT TO USE "ONLINE", APART FROM THE MARK AS SHOWN.

FOR BUSINESS RESEARCH; STRATEGIC BUSINESS PLANNING; BUSINESS MANAGEMENT AND CONSULTING; CONDUCTING TRADE SHOWS IN THE FIELDS OF GLOBAL COMPUTER COMMERCE AND ON-LINE COMMERCE, DIGITAL MEDIA, INFORMATION AND CONSUMER AND BUSINESS-TO-BUSINESS COMMUNICATIONS TECHNOLOGIES; ARRANGING AND CONDUCTING BUSINESS CONFERENCES (U.S. CLS. 100, 101 AND 102).

FIRST USE 6-1-1998; IN COMMERCE 6-1-1998.

SN 75-823,319. MARKETING MANAGEMENT, INC., FORT WORTH, TX. FILED 10-14-1999.



OWNER OF U.S. REG. NO. 2,447,307.
FOR BUSINESS MARKETING AND MERCHANDISING CONSULTATION SERVICES IN THE FOOD INDUSTRY, INDEPENDENT SCHOOL DISTRICTS, AUTO DEALERSHIPS AND TRUCKING, GIFT AND HOUSEWARES INDUSTRIES (U.S. CLS. 100, 101 AND 102).

FIRST USE 8-0-1999; IN COMMERCE 8-0-1999.

CLASS 35—(Continued).

SN 75-823,320. MARKETING MANAGEMENT, INC., FORT WORTH, TX. FILED 10-14-1999.

MMI INTERNETWORKING

OWNER OF U.S. REG. NO. 2,447,307.
NO CLAIM IS MADE TO THE EXCLUSIVE RIGHT TO USE "INTERNETWORKING", APART FROM THE MARK AS SHOWN.

FOR BUSINESS MARKETING AND MERCHANDISING CONSULTATION SERVICES IN THE FOOD INDUSTRY, INDEPENDENT SCHOOL DISTRICTS, AUTO DEALERSHIPS AND TRUCKING, GIFT AND HOUSEWARES INDUSTRIES (U.S. CLS. 100, 101 AND 102).

FIRST USE 8-0-1999; IN COMMERCE 8-0-1999.

SN 75-835,553. CONVERGENZ, TOLUCA LAKE, CA. FILED 11-18-1999.

CONVERGENZ

FOR PUBLIC RELATIONS, MARKET ANALYSIS AND RESEARCH IN THE FIELD OF CORPORATE STRATEGIES (U.S. CLS. 100, 101 AND 102).

FIRST USE 1-1-1995; IN COMMERCE 1-1-1995.

SN 75-838,118. ON-LINE DIGITAL ADVERTISING CONNECTION, INC., CAMBRIDGE, MA. FILED 11-2-1999.

ODAC

FOR COMPUTER SERVICES, NAMELY, COMPUTER DATABASE WHICH ENABLES USERS TO BUY AND SELL ADVERTISING SPACE AND TRACK AND MANAGE THE PLACEMENT AND RESULTS OF SAID ADVERTISEMENTS (U.S. CLS. 100, 101 AND 102).

SN 75-856,408. BANCO BILBAO VIZCAYA ARGENTARIA, S.A., 48005 BILBAO, SPAIN, BY MERGER, BY CHANGE OF NAME BANCO BILBAO VIZCAYA, S.A., 48005 BILBAO, SPAIN, FILED 11-23-1999.

LATINBANK

PRIORITY CLAIMED UNDER SEC. 44(D) ON SPAIN APPLICATION NO. 2,268,420, FILED 11-5-1999, REG. NO. 2268420-4, DATED 3-20-2000, EXPIRES 3-20-2010.

FOR BUSINESS MANAGEMENT AND CONSULTATION; MARKET RESEARCH; BUSINESS MARKETING CONSULTING SERVICES; BUSINESS INVESTIGATIONS; FINANCIAL AUDITING; AND PROVIDING COMMERCIAL AND STATISTICAL INFORMATION (U.S. CLS. 100, 101 AND 102).

CLASS 35—(Continued).

SN 75-857,626. CUSTOMER GROUP LLC, THE, CHICAGO, IL. FILED 11-24-1999.

GETDIRECTNOW

FOR BUSINESS MARKETING CONSULTING SERVICES; BUSINESS CONSULTING IN THE FIELD OF ELECTRONIC COMMERCE (U.S. CLS. 100, 101 AND 102).

FIRST USE 11-1-1999; IN COMMERCE 11-1-1999.



SN 75-860,005. LINKLEADS.COM, INC., PITTSBURGH, PA. FILED 12-12-1999.

LINKLEADS.COM

FOR DISSEMINATION OF ADVERTISING FOR OTHERS VIA AN ON-LINE COMMUNICATIONS NETWORK (U.S. CLS. 100, 101 AND 102).

FIRST USE 2-12-2000; IN COMMERCE 5-17-2000.



SN 75-860,160. DOS SANTOS, PAULO CHAME, DBA PURPLUS SOFT, SAUSALITO, CA. FILED 12-13-1999.

PURPLUS

FOR ONLINE RETAIL STORE FEATURING COMPUTER SOFTWARE, COMPUTER HARDWARE, COMPUTER ACCESSORIES AND COMPUTER BOOKS (U.S. CLS. 100, 101 AND 102).

FIRST USE 0-0-1995; IN COMMERCE 0-0-1995.



SN 75-861,352. KERSTEIN, ROBERT, FAIRFAX, VA. FILED 12-1-1999.

BOB.COM

FOR COMPUTERIZED ON-LINE RETAIL AND DISTRIBUTORSHIP SERVICES FEATURING OLD STOCK AND BOND CERTIFICATES AND COLLECTIBLE MEMORABILIA; ON-LINE TRADING SERVICES FEATURING OLD STOCK AND BOND CERTIFICATES AND COLLECTIBLE MEMORABILIA (U.S. CLS. 100, 101 AND 102).

FIRST USE 9-15-1999; IN COMMERCE 9-15-1999.

CLASS 35—(Continued).

SN 75-865,334. FIRST SECURITY, INC, VANCOUVER BC, CANADA, FILED 12-18-1999.

NETPOINTS4ME

FOR PROMOTING THE GOODS AND SERVICES OF OTHERS THROUGH THE DISSEMINATION OF ADVERTISING FOR OTHERS AND CONDUCTING MEMBERSHIP LOYALTY PROGRAMS AND DISCOUNT PROGRAMS COMPRISING THE ISSUANCE OF MEMBERSHIP CARDS, POINTS, AND VOUCHERS OF VALUE WHICH CAN BE REDEEMED AT PARTICIPATING MERCHANTS; PROMOTING THE GOODS AND SERVICES OF OTHERS BY PREPARING AND PLACING ADVERTISEMENTS IN AN ELECTRONIC MAGAZINE ACCESSED THROUGH A GLOBAL COMPUTER NETWORK; BUSINESS CONSULTATION IN THE FIELD OF CUSTOMER LOYALTY INCENTIVES AND REWARD PROGRAMS; AND SALES VOLUME TRACKING FOR OTHERS (U.S. CLS. 100, 101 AND 102).



SN 75-865,335. FIRST SECURITY, INC, VANCOUVER BC, CANADA, FILED 12-18-1999.

CLIXPOINT

FOR PROMOTING THE GOODS AND SERVICES OF OTHERS THROUGH THE DISSEMINATION OF ADVERTISING FOR OTHERS AND CONDUCTING MEMBERSHIP LOYALTY PROGRAMS AND DISCOUNT PROGRAMS COMPRISING THE ISSUANCE OF MEMBERSHIP CARDS, POINTS, AND VOUCHERS OF VALUE WHICH CAN BE REDEEMED AT PARTICIPATING MERCHANTS; PROMOTING THE GOODS AND SERVICES OF OTHERS BY PREPARING AND PLACING ADVERTISEMENTS IN AN ELECTRONIC MAGAZINE ACCESSED THROUGH A GLOBAL COMPUTER NETWORK; BUSINESS CONSULTATION IN THE FIELD OF CUSTOMER LOYALTY INCENTIVES AND REWARD PROGRAMS; AND SALES VOLUME TRACKING FOR OTHERS (U.S. CLS. 100, 101 AND 102).



SN 75-881,335. PROTEC MANUFACTURING INC., CALGARY, ALBERTA T2H 0T3, CANADA, FILED 12-22-1999.

FRESH POP

FOR WHOLESALE DISTRIBUTORSHIP SERVICES FEATURING COMMERCIAL POPCORN MACHINES AND SUPPLIES FOR MAKING POPCORN, NAMELY OIL, TOPPING, UNPOPPED CORN, BAGS, CARTONS AND HEATING LIGHTS (U.S. CLS. 100, 101 AND 102).

FIRST USE 7-0-1994; IN COMMERCE 7-0-1994.

CLASS 35—(Continued).

SN 75-881,498. GORDON, STUART O., WASHINGTON, DC. FILED 12-29-1999.

MEDIA CONCEPTIONS

NO CLAIM IS MADE TO THE EXCLUSIVE RIGHT TO USE "MEDIA", APART FROM THE MARK AS SHOWN.
FOR PROMOTING THE SALE OF GOODS AND SERVICES OF OTHERS THROUGH THE DISTRIBUTION OF PRINTED AND VISUAL MATERIAL VIA THE INTERNET, RADIO AND TELEVISION (U.S. CLS. 100, 101 AND 102).

SN 75-885,924. AWARDTRACK, INC., SCOTTS VALLEY, CA. FILED 1-3-2000.

AWARDNEWS

FOR ADMINISTRATION AND MANAGEMENT OF CUSTOMER LOYALTY AND INCENTIVE PROGRAMS FOR OTHERS VIA A GLOBAL COMPUTER NETWORK (U.S. CLS. 100, 101 AND 102).

SN 75-889,258. WHITNEY INFORMATION NETWORK, INC., CAPE CORAL, FL. FILED 1-6-2000.

UGETPAID

FOR ADVERTISING SERVICES, NAMELY, PROVIDING A WEBSITE FOR USERS WHICH ARRANGES FOR THE PLACEMENT OF ADVERTISEMENTS OF AFFILIATED MERCHANTS ON THE USER'S WEBSITE (U.S. CLS. 100, 101 AND 102).

SN 75-901,493. CARLSON MARKETING GROUP, INC., MINNEAPOLIS, MN. FILED 1-24-2000.

LifeRewards

FOR ORGANIZATION AND ADMINISTRATION OF INCENTIVE AND LOYALTY AWARD PROGRAMS FOR OTHERS TO PROMOTE, RECOGNIZE, AND AWARD LOYALTY AND/OR PERFORMANCE THROUGH THE DISTRIBUTION OF POINTS WHICH CAN BE REDEEMED FOR MERCHANDISE (U.S. CLS. 100, 101 AND 102).

CLASS 35—(Continued).

SN 75-907,188. EATEAT.COM, NEW YORK, NY. FILED 2-1-2000.



FOR COMPUTERIZED ON-LINE ORDERING SERVICE FEATURING FOOD AND BEVERAGES, NAMELY PROVIDING FOOD AND BEVERAGE INFORMATION TO MEMBERS, TAKING ORDERS FROM MEMBERS, AND TRANSMITTING THE SAME TO VARIOUS FOOD PROVIDERS (U.S. CLS. 100, 101 AND 102).

SN 75-908,689. DEKKER, LTD., SAN BERNARDINO, CA. FILED 2-3-2000.

DEKKER, LTD.

SEC. 2(F).
FOR CONSULTING SERVICES IN THE FIELDS OF ACCOUNTING, STRATEGIC BUSINESS PANNING AND PROJECT MANAGEMENT (U.S. CLS. 100, 101 AND 102).
FIRST USE 12-0-1984; IN COMMERCE 12-0-1984.

SN 75-909,770. ARTCITE, INC., BURKE, VA. FILED 2-4-2000.

AUCTIONCITES.COM

NO CLAIM IS MADE TO THE EXCLUSIVE RIGHT TO USE "AUCTIONSITES.COM", APART FROM THE MARK AS SHOWN.
FOR PROVIDING A REGISTRY OF FINANCIAL TRANSACTIONS INVOLVING ITEMS SOLD AT AUCTION, VIA THE GLOBAL COMPUTER NETWORK (U.S. CLS. 100, 101 AND 102).

SN 75-922,439. MUCHOINFO.COM, INC., DENVER, CO. FILED 2-18-2000.

MUCHOINFO.COM

FOR MARKET RESEARCH SURVEY MEASUREMENT, INFORMATION ACQUISITION SERVICES AND ANALYSIS OF ACQUIRED INFORMATION RELATING TO VISITORS TO WEB SITES OF GLOBALLY INTERCONNECTED COMPUTER NETWORKS (U.S. CLS. 100, 101 AND 102).
FIRST USE 11-0-1999; IN COMMERCE 11-0-1999.

CLASS 35—(Continued).

SN 75-935,983. RTC INDUSTRIES, INC., ROLLING MEADOWS, IL. FILED 3-3-2000.

STORE READY SOLUTIONS

NO CLAIM IS MADE TO THE EXCLUSIVE RIGHT TO USE "STORE READY", APART FROM THE MARK AS SHOWN.

FOR PROVIDING INFORMATION REGARDING MERCHANDISING AND DISPLAY SYSTEMS AND PRODUCTS ON A GLOBAL COMMUNICATIONS NETWORK (U.S. CLS. 100, 101 AND 102).

FIRST USE 10-0-1999; IN COMMERCE 10-0-1999.

SN 75-940,717. IDEASSOCIATES, LLC, MILWAUKEE, WI. FILED 3-8-2000.



FOR BUSINESS CONSULTATION SERVICES IN THE FIELD OF PROMOTING THE GOODS AND SERVICES OF COMPANIES IN THE FINANCIAL SERVICES INDUSTRY AND IN THE FIELD OF STRATEGIC CONSULTING FOR COMPANIES IN THE FINANCIAL SERVICES INDUSTRY (U.S. CLS. 100, 101 AND 102).

SN 75-941,890. VASTERA, INC., DULLES, VA. FILED 3-10-2000.

TRADE VANTAGE

NO CLAIM IS MADE TO THE EXCLUSIVE RIGHT TO USE "TRADE", APART FROM THE MARK AS SHOWN.

FOR BUSINESS MANAGEMENT AND CONSULTATION SERVICES IN THE FIELD OF IMPORT/EXPORT LOGISTICS AND COMPLIANCE PROVIDED TO OTHERS IN NEED OF OUTSOURCING THEIR IMPORT/EXPORT LOGISTICS AND COMPLIANCE SERVICES (U.S. CLS. 100, 101 AND 102).

SN 75-960,393. GIFT CHECK SOLUTIONS, BLUFFDALE, UT. FILED 3-15-2000.



NO CLAIM IS MADE TO THE EXCLUSIVE RIGHT TO USE "GIFT CHECK", APART FROM THE MARK AS SHOWN.

FOR PROMOTING THE GOODS AND SERVICES OF OTHERS THROUGH THE DISTRIBUTION OF GIFT CERTIFICATES (U.S. CLS. 100, 101 AND 102).

FIRST USE 3-15-2000; IN COMMERCE 4-1-2000.

CLASS 35—(Continued).

SN 75-981,191. INTEGRATE, INCORPORATED, BATON ROUGE, LA. FILED 6-22-1999.

INTEGRATE

FOR DATA PROCESSING FOR ENVIRONMENTAL DATA MANAGEMENT (U.S. CLS. 100, 101 AND 102).
FIRST USE 8-18-1997; IN COMMERCE 8-18-1997.

SN 76-009,789. 169321 CANADA INC., DBA HS PERSONNEL SYSTEMS, INC., OTTAWA, ONTARIO, FILED 3-27-2000.

COMPINSIGHT

PRIORITY CLAIMED UNDER SEC. 44(D) ON CANADA APPLICATION NO. 103298600, FILED 10-19-1999.

FOR CONDUCTING BUSINESS AND MARKET RESEARCH SURVEYS, NAMELY, CONDUCTING ONLINE SURVEYS AND ANALYSIS VIA A GLOBAL COMPUTER NETWORK, ON EMPLOYMENT COMPENSATION, INCENTIVES AND BENEFITS (U.S. CLS. 100, 101 AND 102).
FIRST USE 1-1-2000; IN COMMERCE 1-1-2000.

SN 76-011,452. ADVANSTAR.COM INC., CLEVELAND, OH. FILED 3-28-2000.

HIVE4

FOR COMPUTERIZED INFORMATION AND INTERACTIVE ONLINE SERVICES FOR AND AMONG BUSINESS COMMUNITIES, ACCESSED VIA A GLOBAL COMPUTER NETWORK, BY PROVIDING A DIGITAL MARKETPLACE TO BRING BUYERS AND SELLERS TOGETHER FOR THE EXCHANGE OF INFORMATION AND FOR BUSINESS TO BUSINESS TRANSACTIONS IN THE FIELDS OF APPAREL AND FASHION, TELECOMMUNICATIONS, CUSTOMER RELATIONSHIP MANAGEMENT, PHARMACEUTICALS, LABORATORY SCIENCES, SPECTROSCOPY, CHROMATOGRAPHY, MEDICAL DEVICES, AUTOMATED DATA CAPTURE, RETAIL SYSTEMS, SENSORS AND MOTION CONTROL, GEOSPATIAL SYSTEMS, TELECONFERENCING AND WEB-BASED COLLABORATION, MEDIA AND ENTERTAINMENT, DIGITAL PRINTING AND PUBLISHING, BEAUTY, TRAVEL, HOSPITALITY AND LODGING, ART AND FRAMING, POWER SPORT, AUTOMOTIVE AFTERMARKET, HOME VIDEO, MERCHANDISE LICENSING, LANDSCAPE AND GOLF COURSE MANAGEMENT, AND E-COMMERCE; AND, PROVIDING ADVERTISING SPACE AND PROMOTIONS OVER A GLOBAL COMPUTER NETWORK (U.S. CLS. 100, 101 AND 102).

SN 76-014,825. ACCELA.COM, INC., SOUTH SAN FRANCISCO, CA. FILED 3-31-2000.

VELOCITYHALL

FOR BUILDING RELATED SERVICES, NAMELY, ASSISTING OTHERS IN APPLYING FOR AND OBTAINING PERMITS, ASSISTING OTHERS IN TRACKING STATUS OF PERMITS, AND ASSISTING OTHERS IN SCHEDULING PERMIT-RELATED INSPECTIONS (U.S. CLS. 100, 101 AND 102).

CLASS 35—(Continued).

SN 76-023,746. DUN & BRADSTREET, INC., MURRAY HILL, NJ. FILED 4-11-2000.

SUPPLIEREDGE

FOR PROVIDING BUSINESS AND MARKETING SERVICES USED BY BUSINESSES TO IDENTIFY, DESCRIBE AND ACCREDIT POTENTIAL CUSTOMERS, INCLUDING INFORMATION ABOUT CREDIT SCORE AND WORTHINESS, THE SIZE OF THE POTENTIAL CUSTOMER, THE INDUSTRY AND SALES REVENUE OF THE POTENTIAL CUSTOMER AND THE LIKE (U.S. CLS. 100, 101 AND 102).

SN 76-027,118. MISSIRLIAN, PHILIP N., DIX HILLS, NY. FILED 4-17-2000.

GREYSTONE

FOR PERSONNEL PLACEMENT SERVICES (U.S. CLS. 100, 101 AND 102).

SN 76-030,662. TRAVELIN JACK ENTERPRISES, L.L.C., LAKE ORION, MI. FILED 4-20-2000.

TRAVELIN JACK

FOR ON LINE RETAIL STORE SERVICES FEATURING COMPUTERS AND COMPUTER COMPONENTS (U.S. CLS. 100, 101 AND 102).
FIRST USE 3-0-2000; IN COMMERCE 3-0-2000.

SN 76-031,297. SHAREYOURWORLD, INC., SAN FRANCISCO, CA. FILED 4-21-2000.

SHAREYOURWORLD YOUR PERSONAL TALENT AGENT

NO CLAIM IS MADE TO THE EXCLUSIVE RIGHT TO USE "TALENT AGENT", APART FROM THE MARK AS SHOWN.

FOR TALENT AGENCY SERVICES; COMPUTER SERVICES, NAMELY PROVIDING TALENT AGENCY SERVICES BY MEANS OF ELECTRONIC AND OPTICAL COMMUNICATIONS NETWORKS IN THE NATURE OF A WEB SITE WHERE INDIVIDUALS AND OTHER ENTITIES MAY POST AUDIO-VISUAL MATERIAL TO BE VIEWED AND OFFERED FOR LICENSING (U.S. CLS. 100, 101 AND 102).

CLASS 35—(Continued).

SN 76-032,071. SHAREYOURWORLD, INC., SAN FRANCISCO, CA. FILED 4-21-2000.

SHAREYOURWORLD

FOR TALENT AGENCY SERVICES; COMPUTER SERVICES, NAMELY PROVIDING TALENT AGENCY SERVICES BY MEANS OF ELECTRONIC AND OPTICAL COMMUNICATIONS NETWORKS IN THE NATURE OF A WEB SITE WHERE INDIVIDUALS AND OTHER ENTITIES MAY POST AUDIO-VISUAL MATERIAL TO BE VIEWED AND OFFERED FOR LICENSING (U.S. CLS. 100, 101 AND 102).

FIRST USE 10-18-1999; IN COMMERCE 12-1-1999.

SN 76-033,480. THINKSHED, INC., AUSTIN, TX. FILED 4-25-2000.

THINKSHED

FOR PROVIDING AN INTERNET WEBSITE FEATURING INFORMATION IN THE FIELDS OF CAREERS AND JOB OPPORTUNITIES (U.S. CLS. 100, 101 AND 102).

SN 76-035,842. SDN ONLINE, INC., LOS ANGELES, CA. FILED 4-26-2000.

WHAT'S YOUR ZKEY?

FOR PROVIDING AN ON-LINE COMPUTER DATABASE AND APPLICATIONS IN THE FIELD OF BUSINESS, NAMELY, THE EXCHANGE OF PROPRIETARY INFORMATION FOR BUSINESS PLANNING, SCHEDULING AND ORGANIZING AND BUSINESS MANAGEMENT VIA A GLOBAL COMPUTER INFORMATION NETWORK (U.S. CLS. 100, 101 AND 102).

FIRST USE 8-0-1999; IN COMMERCE 8-0-1999.

SN 76-039,992. ACCESS, INC., DALLAS, TX. FILED 5-3-2000.

IFLYSMART

FOR COMPUTERIZED ONLINE PURCHASING OF AIRLINE TICKETS, UTILIZING ON-LINE TRADING SERVICES TO FACILITATE THE BUYING AND SELLING OF COMMERCIAL AIRLINE TICKETS AND FREQUENT FLYER AWARD CERTIFICATES (U.S. CLS. 101 AND 102).

FIRST USE 2-1-2000; IN COMMERCE 2-1-2000.

CLASS 35—(Continued).

SN 76-040,023. MCHENRY, WALLACE, PHOENIX, AZ. FILED 5-3-2000.

KNOWATT

FOR PROVIDING STATISTICAL REPORTS AND INFORMATION SERVICES ON ENERGY METERING AND ENERGY USE MONITORING (U.S. CLS. 100, 101 AND 102).

SN 76-041,216. LOVE'S COUNTRY STORES, INC., OKLAHOMA CITY, OK. FILED 5-4-2000.

**CLEAN PLACES FRIENDLY
FACES**

FOR RETAIL CONVENIENCE STORE AND GASOLINE STATION SERVICES (U.S. CLS. 100, 101 AND 102). FIRST USE 10-0-1991; IN COMMERCE 10-0-1991.

SN 76-045,206. LOGOBUILDERS, INC., SETTLE, WA. BY CHANGE OF NAME LOGOBUILDERS.COM, INC., SEATTLE, WA. FILED 5-10-2000.

LOGOBUILDERS

FOR ORDERING SERVICES FOR BUSINESSES OF OTHERS IN THE FIELD OF PROMOTIONAL MERCHANDISE FEATURING THE BUSINESSES' LOGOS (U.S. CLS. 100, 101 AND 102).

SN 76-049,770. WEST MARINE IHC I, INC., WATSONVILLE, CA. BY ASSIGNMENT WEST MARINE IHC II, INC., WATSONVILLE, CA. FILED 5-16-2000.

**THE WEST ADVANTAGE
PROGRAM**

OWNER OF U.S. REG. NOS. 1,581,444, 1,584,599 AND OTHERS.

NO CLAIM IS MADE TO THE EXCLUSIVE RIGHT TO USE "PROGRAM", APART FROM THE MARK AS SHOWN.

FOR CUSTOMER BONUS AND INCENTIVE PROGRAM, NAMELY, A PROGRAM WHICH ALLOWS CUSTOMERS TO REDEEM CERTIFICATES FOR PURCHASES BASED UPON PRIOR PURCHASES (U.S. CLS. 100, 101 AND 102).

FIRST USE 2-0-2000; IN COMMERCE 2-0-2000.

CLASS 35—(Continued).

SN 76-056,377. ADAMS, DANIEL, SAN DIEGO, CA. FILED 5-25-2000.

PIC-A-DEAL.COM

FOR RETAIL VARIETY STORES; MAIL ORDER CATALOG SERVICES IN THE FIELD OF VARIETY ITEMS, NAMELY, SUNDRIES, BEVERAGES, CLOTHING, FOOTWEAR, TOYS, SPORTING GOODS, HOUSEWARES, HOUSEHOLD GOODS, DOMESTICS, DETERGENTS, SOAP AND CLEANING PRODUCTS, COSMETICS AND PERSONAL CARE PRODUCTS, LIGHTING SUPPLIES, BOOKS, COMPACT DISKS, BLANK AND PRERECORDED VIDEO AND AUDIO TAPES, JEWELRY AND WATCHES, SCHOOL SUPPLIES, ORGANIZERS, HAIR ACCESSORIES, KITES, AND BACKPACKS; COMPUTERIZED ONLINE RETAIL SERVICES IN THE FIELD OF VARIETY ITEMS, NAMELY, SUNDRIES, BEVERAGES, CLOTHING, FOOTWEAR, TOYS, SPORTING GOODS, HOUSEWARES, HOUSEHOLD GOODS, DOMESTICS, DETERGENTS, SOAP AND CLEANING PRODUCTS, COSMETICS AND PERSONAL CARE PRODUCTS, LIGHTING SUPPLIES, BOOKS, COMPACT DISKS, BLANK AND PRERECORDED VIDEO AND AUDIO TAPES, JEWELRY AND WATCHES, SCHOOL SUPPLIES, ORGANIZERS, HAIR ACCESSORIES, KITES, AND BACKPACKS (U.S. CLS. 100, 101 AND 102).

FIRST USE 8-24-1999; IN COMMERCE 8-24-1999.

SN 76-056,628. BRAD MUSIC, INC., PLEASANT RIDGE, MI. FILED 5-25-2000.

THE BAD LITTLE MAN

FOR PRODUCTION AND DISTRIBUTION OF RADIO AND TELEVISION COMMERCIALS (U.S. CLS. 100, 101 AND 102).

SN 76-058,786. RESTORATION HARDWARE, INC., SAN RAFAEL, CA. FILED 5-27-2000.

**FAMOUS FALL LIGHTING
SALE**

SEC. 2(F).

FOR RETAIL STORE SERVICES, CATALOGUE AND MAIL-ORDER SERVICES, AND ONLINE RETAIL STORE SERVICES FEATURING FURNITURE, GIFTS, LIGHTING FIXTURES, HOUSEWARES, MEMORABILIA, HARDWARE, AND LIGHTING ACCESSORIES; ADVERTISING, MARKET RESEARCH AND SALES PROMOTION SERVICES FEATURING FURNITURE, GIFTS, LIGHTING FIXTURES, HOUSEWARES, MEMORABILIA, HARDWARE, AND LIGHTING ACCESSORIES (U.S. CLS. 100, 101 AND 102).

FIRST USE 10-30-1990; IN COMMERCE 10-30-1990.

CLASS 35—(Continued).

SN 76-059,537. JUST FOR GIRLS SPORTS, LLC, LEESBURG, VA. FILED 5-31-2000.



NO CLAIM IS MADE TO THE EXCLUSIVE RIGHT TO USE "SPORTS", APART FROM THE MARK AS SHOWN.

THE DRAWING IS LINED FOR THE COLORS RED AND BLUE TO INDICATE THAT COLOR IS A FEATURE OF THE MARK.

FOR ONLINE RETAIL STORE SERVICES AND RETAIL STORE SERVICES IN THE FIELDS OF SPORTS APPAREL, ACCESSORIES, AND EQUIPMENT (U.S. CLS. 100, 101 AND 102).

FIRST USE 7-22-1999; IN COMMERCE 7-22-1999.

SN 76-062,866. GLOBAL DOCUGRAPHIX, INC., LINCOLN-SHIRE, IL. FILED 6-6-2000.

GDXNET ZONE

FOR ON-LINE PROCESSING OF COMMERCIAL TRANSACTIONS FOR BUSINESSES AND USERS, NAMELY, PROCESSING THE PURCHASE AND/OR EXCHANGE OF PROMOTIONAL ITEMS, OFFICE SUPPLIES, CUSTOM AND STANDARD BUSINESS FORMS AND LABELS FOR OTHERS OVER A GLOBAL COMPUTER NETWORK (U.S. CLS. 100, 101 AND 102).

SN 76-063,021. THERIGHTSIZE.COM, INC., SAN FRANCISCO, CA. FILED 6-5-2000.

ORBICUS

FOR BUSINESS CONSULTING SERVICES, BUSINESS MARKETING SERVICES, BUSINESS DEVELOPMENT SERVICES, SERVICES FOR DEVELOPING STANDARDS FOR BUSINESS PROCESS MANAGEMENT AND PROPRIETARY BUSINESS MANAGEMENT AND PRACTICES; BUSINESS MARKETING CONSULTING SERVICES; PROVIDING INFORMATION IN THE FIELDS OF BUSINESS MANAGEMENT AND BUSINESS PRACTICES, ALL IN THE FIELD OF CONSUMER GOODS AND THEIR APPROPRIATE MARKETS (U.S. CLS. 100, 101 AND 102).

CLASS 35—(Continued).

SN 76-064,226. MASON SHOE MANUFACTURING CO., CHIPPEWA FALLS, WI. FILED 6-6-2000.

ShoeMall

FOR COMPUTERIZED ON-LINE RETAIL SERVICES IN THE FIELD OF FOOTWEAR AND CLOTHING; MAIL ORDER CATALOG SERVICES FEATURING FOOTWEAR AND CLOTHING; RETAIL STORE SERVICES, AVAILABLE THROUGH COMPUTER COMMUNICATIONS AND INTERACTIVE TELEVISION, FEATURING FOOTWEAR AND CLOTHING (U.S. CLS. 100, 101 AND 102).

SN 76-065,602. FULL SPECTRUM TECHNOLOGIES, LLC, DENVER, CO. FILED 6-8-2000.

FULL SPECTRUM TECHNOLOGY

NO CLAIM IS MADE TO THE EXCLUSIVE RIGHT TO USE "TECHNOLOGY", APART FROM THE MARK AS SHOWN.

FOR RETAIL SERVICES BY DIRECT SOLICITATION BY SALES AGENTS IN THE FIELD OF CUSTOM EQUIPMENT, NAMELY, ULTRAVIOLET SPOT CURING SYSTEMS FOR USE BY ORIGINAL EQUIPMENT MANUFACTURES (U.S. CLS. 100, 101 AND 102).

SN 76-065,620. ACQUIS CONSULTING GROUP, LLC., NEW YORK, NY. FILED 6-8-2000.

ACQUIRE KNOWLEDGE

FOR BUSINESS MANAGEMENT CONSULTING SERVICES (U.S. CLS. 100, 101 AND 102).
FIRST USE 10-23-1998; IN COMMERCE 10-23-1998.

SN 76-073,596. HOMESTEAD HOUSE, INC., BROOMFIELD, CO. FILED 6-19-2000.

HOMESTEAD HOUSE

FOR RETAIL STORE SERVICES FEATURING FURNITURE AND HOME FURNISHINGS (U.S. CLS. 100, 101 AND 102).

FIRST USE 12-0-1954; IN COMMERCE 12-0-1954.

CLASS 35—(Continued).

SN 76-074,674. STANDARD TILE DISTRIBUTORS OF NEW HAVEN, INC., NEW HAVEN, CT. FILED 6-21-2000.



FOR WHOLESALE DISTRIBUTORSHIPS OF CERAMIC TILE, NATURAL STONE, MARBLE AND TILES (U.S. CLS. 100, 101 AND 102).
FIRST USE 8-1-1993; IN COMMERCE 8-1-1993.



SN 76-075,099. XELUS, INC., FAIRPORT, NY. FILED 6-22-2000.

XELUSVIA

FOR BUSINESS CONSULTING SERVICES IN THE FIELD OF INVENTORY MANAGEMENT, ONLINE BROKERAGE, AND COMPUTER SOFTWARE; OUTSOURCING SERVICES IN THE FIELD INVENTORY MANAGEMENT (U.S. CLS. 100, 101 AND 102).



SN 76-076,116. NATIONAL IMPORTERS WEST LTD., BRITISH COLUMBIA, CANADA, BY CHANGE OF NAME NATIONAL IMPORTERS LTD., NEW WESTMINSTER, BRITISH COLUMBIA, CANADA, FILED 6-23-2000.



OWNER OF CANADA REG. NO. TMA501469, DATED 9-29-1998, EXPIRES 9-29-2013.
THE MARK CONSISTS OF THE STYLIZED LETTERS "N" AND "i".
FOR IMPORT AGENCY SERVICES, FEATURING FOOD AND BEVERAGES (U.S. CLS. 100, 101 AND 102).

CLASS 35—(Continued).

SN 76-076,594. WELLS FARGO & COMPANY, MINNEAPOLIS, MN. FILED 6-23-2000.



NO CLAIM IS MADE TO THE EXCLUSIVE RIGHT TO USE "ENTERTAINMENT", APART FROM THE MARK AS SHOWN.

FOR TICKET AGENCY SERVICES, NAMELY PROVIDING VOUCHERS FOR TICKETS TO CITY AND TOURIST ATTRACTIONS BY MEANS OF ATM AND GLOBAL COMMUNICATIONS NETWORKS (U.S. CLS. 100, 101 AND 102).
FIRST USE 5-15-2000; IN COMMERCE 5-15-2000.



SN 76-077,605. SALVAGESALE.COM, INC., HOUSTON, TX. FILED 6-26-2000.



NO CLAIM IS MADE TO THE EXCLUSIVE RIGHT TO USE "SALVAGESALE", APART FROM THE MARK AS SHOWN.

FOR PROMOTION OF DAMAGED, DEVALUED, RETURNED, OBSOLETE, OVERSTOCK AND SALVAGED GOODS OF OTHERS THROUGH THE PLACEMENT OF OFFERS, ADVERTISEMENTS AND PROMOTIONAL DISPLAYS ON AN ELECTRONIC SITE ACCESSED VIA A GLOBAL COMPUTER NETWORK (U.S. CLS. 100, 101 AND 102).
FIRST USE 5-0-2000; IN COMMERCE 5-0-2000.



SN 76-081,305. GEOFFREY, INC., PARAMUS, NJ. FILED 6-29-2000.

TRU TOWN

OWNER OF U.S. REG. NOS. 902,125, 1,531,202 AND OTHERS.
FOR ONLINE RETAIL DEPARTMENT STORES IN THE FIELD OF CONSUMER PRODUCTS (U.S. CLS. 100, 101 AND 102).

CLASS 35—(Continued).

SN 76-084,832. AMERICAN MICROCELL CORPORATION, PHOENIX, AZ. FILED 7-7-2000.

WAGEWATCH

FOR PROVIDING A PORTAL WEBSITE FOR EMPLOYMENT INFORMATION AND HUMAN RESOURCE SERVICES, NAMELY GATHERING AND PROVIDING ON-LINE INFORMATION, NEWS, STATISTICS IN THE FIELDS OF EMPLOYMENT AND HUMAN RESOURCES; ON-LINE DATABASES IN THE FIELD OF EMPLOYMENT AND HUMAN RESOURCES; SERVICES IN THE FIELD OF EMPLOYMENT AND HUMAN RESOURCES, NAMELY DATA ON GEOGRAPHIC EMPLOYMENT AND COSTS; COLLECTION OF DATA FOR OTHERS IN THE FIELD OF COSTS (U.S. CLS. 100, 101 AND 102).
FIRST USE 1-15-2000; IN COMMERCE 1-15-2000.

SN 76-084,937. AMERICAN MICROCELL CORPORATION, PHOENIX, AZ. FILED 7-7-2000.

DATA THAT COUNTS

FOR PROVIDING A PORTAL WEBSITE FOR EMPLOYMENT INFORMATION AND HUMAN RESOURCE SERVICES, NAMELY GATHERING AND PROVIDING ON-LINE INFORMATION, NEWS, STATISTICS IN THE FIELDS OF EMPLOYMENT AND HUMAN RESOURCES; ON-LINE DATABASES IN THE FIELD OF EMPLOYMENT AND HUMAN RESOURCES; SERVICES IN THE FIELD OF EMPLOYMENT AND HUMAN RESOURCES, NAMELY DATA ON GEOGRAPHIC EMPLOYMENT AND COSTS; COLLECTION OF DATA FOR OTHERS IN THE FIELD OF COSTS (U.S. CLS. 100, 101 AND 102).
FIRST USE 1-15-2000; IN COMMERCE 1-15-2000.

SN 76-093,233. FARM PROGRESS COMPANIES, INC., CAROL STREAM, IL. FILED 7-21-2000.

NEW YORK FARM SHOW

OWNER OF U.S. REG. NO. 1,865,402 AND OTHERS.
NO CLAIM IS MADE TO THE EXCLUSIVE RIGHT TO USE "FARM SHOW", APART FROM THE MARK AS SHOWN.
SEC. 2(F).
FOR ORGANIZING AND CONDUCTING A TRADE SHOW RELATING TO AGRICULTURE AND LIVESTOCK (U.S. CLS. 100, 101 AND 102).
FIRST USE 0-0-1984; IN COMMERCE 0-0-1984.

CLASS 35—(Continued).

SN 76-093,235. FARM PROGRESS COMPANIES, INC., CAROL STREAM, IL. FILED 7-2-2000.

OKLAHOMA FARM SHOW

OWNER OF U.S. REG. NO. 1,865,402 AND OTHERS.
NO CLAIM IS MADE TO THE EXCLUSIVE RIGHT TO USE "FARM SHOW", APART FROM THE MARK AS SHOWN.

SEC. 2(F).
FOR ORGANIZING AND CONDUCTING A TRADE SHOW RELATING TO AGRICULTURE AND LIVESTOCK (U.S. CLS. 100, 101 AND 102).
FIRST USE 0-0-1964; IN COMMERCE 0-0-1964.

SN 76-095,396. STRATIX, SAN FRANCISCO, CA. FILED 7-24-2000.

S T R  T I X

FOR BUSINESS CONSULTING IN THE FIELD OF STRATEGIC MARKETING, MANAGEMENT, OPTIMIZING AND ENHANCING BUSINESS MANAGEMENT COMPUTER DATABASES AND SOFTWARE, AND COMPUTERIZED BUSINESS DATABASE MANAGEMENT (U.S. CLS. 100, 101 AND 102).
FIRST USE 1-1-1990; IN COMMERCE 1-1-1990.

SN 76-096,732. HICKORY SPRINGS MANUFACTURING COMPANY, HICKORY, NC. FILED 7-26-2000.



FOR RETAIL AND WHOLESALE DISTRIBUTORSHIP SERVICES FEATURING FURNITURE AND ACCESSORIES NAMELY BED FRAMES AND RAILS, BEDS, HEADBOARDS, FOOTBOARDS, FUTON FRAMES AND MATTRESSES, LOUNGERS, SLEEPER SOFA MATTRESSES AND SHEETS, AND ACCENT PIECES (U.S. CLS. 100, 101 AND 102).
FIRST USE 10-31-1998; IN COMMERCE 10-31-1998.

CLASS 35—(Continued).

SN 76-096,926. PAMPERED CHEF, LTD., THE, ADDISON, IL. FILED 7-26-2000.

KITCHEN SHOW

NO CLAIM IS MADE TO THE EXCLUSIVE RIGHT TO USE "KITCHEN", APART FROM THE MARK AS SHOWN.
 FOR SHOP-AT-HOME PARTY SERVICES IN THE FIELD OF HOUSEWARES, HOUSEHOLD AND KITCHEN UTENSILS, KITCHEN HAND TOOLS AND IMPLEMENTS, PRINTED MATTER, NAMELY, COOKBOOKS AND PRINTED RECIPES ON CARDS, PRE-RECORDED VIDEO TAPES AND FOOD (U.S. CLS. 100, 101 AND 102).
 FIRST USE 0-0-1986; IN COMMERCE 0-0-1986.

SN 76-101,070. SCJ ENTERPRISES, INC., COLCHESTER, CT. FILED 8-2-2000.

DOMAIN NAME NEWS

NO CLAIM IS MADE TO THE EXCLUSIVE RIGHT TO USE "DOMAIN NAME", APART FROM THE MARK AS SHOWN.
 FOR ONLINE RETAIL SERVICES IN THE FIELD OF DOMAIN NAMES; INTERNET DOMAIN NAME AUCTIONS (U.S. CLS. 100, 101 AND 102).
 FIRST USE 10-27-1999; IN COMMERCE 10-27-1999.

SN 76-107,866. LIANG, ERIC, DBA ARGOSYS ROBOTICS & ACCESSORIES, SAN JOSE, CA. FILED 8-10-2000.



NO CLAIM IS MADE TO THE EXCLUSIVE RIGHT TO USE "ROBOTICS", APART FROM THE MARK AS SHOWN.
 FOR RETAIL STORES, COMPUTERIZED ONLINE RETAIL SERVICES, AND DISTRIBUTORSHIPS IN THE FIELD OF ROBOTICS PARTS AND ACCESSORIES (U.S. CLS. 100, 101 AND 102).
 FIRST USE 1-1-2000; IN COMMERCE 1-1-2000.

SN 76-110,046. MERGERCOACH.COM, L.L.C., PLANO, TX. FILED 8-15-2000.

MERGERCOACH

FOR BUSINESS CONSULTING SERVICES AND BUSINESS PLANNING SERVICES (U.S. CLS. 100, 101 AND 102).
 FIRST USE 3-1-2000; IN COMMERCE 3-1-2000.

CLASS 35—(Continued).

SN 76-112,457. VETERINARY MARKETING SERVICES, INC., BURNET, TX. FILED 8-18-2000.

VETERINARY MARKETING SERVICES

SEC. 2(F).
 FOR WHOLE SALE DISTRIBUTORSHIPS FEATURING PHARMACEUTICAL PRODUCTS AND DEVICES (U.S. CLS. 100, 101 AND 102).
 FIRST USE 0-0-1982; IN COMMERCE 0-0-1982.

SN 76-114,210. POINTS.COM INC., TORONTO, ONTARIO, CANADA, FILED 8-22-2000.

WHERE EVERY POINT COUNTS

FOR PROVIDING A WEB SITE ON THE GLOBAL COMPUTER NETWORK FOR THE TRACKING AND EXCHANGE OF CUSTOMER LOYALTY REWARDS (U.S. CLS. 100, 101 AND 102).

SN 76-116,550. HART, TISHA S., DBA INTERACTIVE CAMPUS SOLUTIONS, BROOKLYN, NY. FILED 8-25-2000.

YOURCAMPUSMALL

FOR ON-LINE RETAIL SERVICES FEATURING VITAMINS, GROCERIES, CLOTHING, GIFTS FOR SPECIAL OCCASIONS AND ELECTRONIC ITEMS, FOR CAMPUS BASED STUDENTS (U.S. CLS. 100, 101 AND 102).
 FIRST USE 8-10-2000; IN COMMERCE 8-10-2000.

CLASS 35—(Continued).

SN 76-116,644. GUINNESS TELLI*PHONE CORPORATION, MILL VALLEY, CA. FILED 8-25-2000.

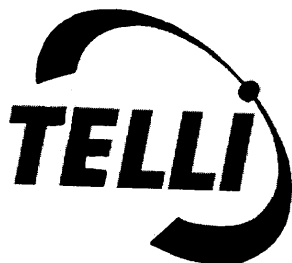

FOR TELEPHONE DIRECTORY INFORMATION; COMMUNITY DIRECTORY INFORMATION, NAMELY, DIRECTORY OF COMMUNITY EVENTS FEATURING A VARIETY OF ACTIVITIES, NAMELY, SPORTING EVENTS, ART EXHIBITIONS, FLEA MARKETS, AND ETHNIC DANCES; COMMERCIAL INFORMATION AND DIRECTORY AGENCY; DISSEMINATION OF ADVERTISING FOR OTHERS VIA AN ON-LINE ELECTRONIC COMMUNICATIONS NETWORK; DISSEMINATION OF ADVERTISING MATTER; SHOPPER'S GUIDE INFORMATION (U.S. CLS. 100, 101 AND 102).

FIRST USE 7-31-2000; IN COMMERCE 7-31-2000.

SN 76-117,690. ELDERLINK COMPANION CARE, INC., LITTLETON, CO. FILED 8-28-2000.

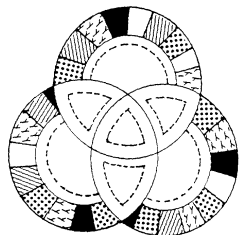

THE LINING OF THE MARK IS A FEATURE OF THE MARK AND DOES NOT INDICATE COLOR.

FOR PERSONAL CARE REFERRAL SERVICES FOR THE ELDERLY, NAMELY TO REFER AND PLACE INDEPENDENT COMPANION CARE PROVIDERS WITH ELDERLY PEOPLE WHO REQUIRE VARIOUS LEVELS OF LIVING ASSISTANCE (U.S. CLS. 100, 101 AND 102).

CLASS 35—(Continued).

SN 76-122,138. ST. VINCENT HOSPITAL AND HEALTH CARE CENTER, INC., INDIANAPOLIS, IN. FILED 9-5-2000.

TEAM FOCUS

NO CLAIM IS MADE TO THE EXCLUSIVE RIGHT TO USE "TEAM", APART FROM THE MARK AS SHOWN.

FOR PROVIDING FACILITIES FOR BUSINESS MEETINGS, FEATURING THE USE OF COMPUTERS AND SPECIALLY-DESIGNED COMPUTER SOFTWARE TO HOLD VIRTUAL MEETINGS AND FACILITATE STRATEGIC PLANNING AND GROUP DECISION MAKING (U.S. CLS. 100, 101 AND 102).

FIRST USE 10-18-1999; IN COMMERCE 10-18-1999.

SN 76-123,558. VIRTUALPORTAL CORPORATION, PINE, CO. FILED 9-6-2000.

IMAGE PLAYER

NO CLAIM IS MADE TO THE EXCLUSIVE RIGHT TO USE "IMAGE", APART FROM THE MARK AS SHOWN.

FOR ONLINE RETAIL SERVICES FEATURING POSTERS, PAINTINGS AND ART PRINTS OF OTHERS, SHOWN TO CONSUMERS VIA A COMPUTER IMAGE FILE WITH AN ICON WHICH CONSUMERS CAN CLICK IN ORDER TO PURCHASE THE IMAGE, WHICH TRANSFERS THE CONSUMER'S WEB BROWSER TO A WEB SITE FOR PURCHASE OF THE GOODS; AND ONLINE PROMOTING OF THE GOODS AND SERVICES OF OTHERS SHOWN TO CONSUMERS VIA A COMPUTER IMAGE FILE WITH AN ICON WHICH CONSUMERS CAN CLICK, WHICH TRANSFERS THE CONSUMER'S WEB BROWSER TO A WEB SITE FOR PURCHASE OF THE GOODS OR SERVICES (U.S. CLS. 100, 101 AND 102).

FIRST USE 8-0-1999; IN COMMERCE 8-0-1999.

SN 76-125,480. ADVENTIS CORPORATION, BOSTON, MA. BY CHANGE OF NAME RENAISSANCE STRATEGY WORLDWIDE, INC., BOSTON, MA. FILED 9-11-2000.

ADVENTIS

FOR BUSINESS CONSULTING SERVICES, NAMELY, BUSINESS MANAGEMENT, ANALYSIS, AND STRATEGIC PLANNING AND IMPLEMENTATION TO BUSINESSES AND OTHERS IN THE FIELDS OF TELECOMMUNICATIONS, COMPUTING AND INFORMATION SYSTEMS, AND ELECTRONIC COMMERCE; BUSINESS MARKETING CONSULTATION SERVICES, NAMELY, THE DEVELOPMENT AND EXPLOITATION OF PROPRIETARY INFORMATION AND CONTENT FOR OTHERS (U.S. CLS. 100, 101 AND 102).

CLASS 35—(Continued).

SN 76-127,588. SPANISH OFFICE SERVICES, INC., SMYRNA, GA. FILED 9-14-2000.

¡LA GUIA QUE LO GUIA!

THE ENGLISH TRANSLATION OF "LA GUIA QUE LO GUIA" IS "THE GUIDE CAN GUIDE YOU".

FOR PROMOTING THE GOODS AND SERVICES OF OTHERS BY PLACING ADVERTISEMENTS IN AN ELECTRONIC MAGAZINE ACCESSED THROUGH A GLOBAL COMPUTER NETWORK (U.S. CLS. 100, 101 AND 102).

FIRST USE 8-1-2000; IN COMMERCE 8-1-2000.

SN 76-127,645. INTERSHOP COMMUNICATIONS, INC, SAN FRANCISCO, CA. FILED 9-13-2000.

INTERSHOP OPEN

OWNER OF U.S. REG. NOS. 2,175,358, 2,175,359 AND 2,201,721.

FOR ARRANGING AND CONDUCTING TRADE SHOWS IN THE FIELD OF COMPUTERS AND E-COMMERCE (U.S. CLS. 100, 101 AND 102).

FIRST USE 10-3-1999; IN COMMERCE 10-3-1999.

SN 76-131,933. UNITED NATURAL FOODS, INC., DAYVILLE, CT. FILED 9-20-2000.

UNFONLINE

FOR RETAIL STORE, DISTRIBUTORSHIP AND MAIL ORDER SERVICES FEATURING NATURAL AND ORGANIC FOODS, VITAMINS, DIETARY SUPPLEMENTS AND HEALTH AND BEAUTY AIDS; PROVIDING RETAIL STORE, DISTRIBUTORSHIP AND MAIL ORDER SERVICES FEATURING NATURAL AND ORGANIC FOODS, VITAMINS, DIETARY SUPPLEMENTS AND HEALTH AND BEAUTY AIDS AVAILABLE THROUGH COMPUTER COMMUNICATIONS AND ELECTRONIC TELEVISION; ACCOUNT MANAGEMENT SERVICES, NAMELY, ASSISTING OTHERS WITH THE PURCHASING OF PRODUCTS, OFFICE ADMINISTRATION, INVENTORY CONTROL, BILLING AND PREPARATION OF ACCOUNT REPORTS; PROCUREMENT SERVICES, NAMELY, ORDER FULFILLMENT FOR OTHERS; ADVERTISING AND MARKETING OF THE PRODUCTS AND SERVICES OF OTHERS (U.S. CLS. 100, 101 AND 102).

CLASS 35—(Continued).

SN 76-132,557. GOOD SAMARITAN HOSPITAL MEDICAL CENTER, WEST ISLIP, NY. FILED 9-21-2000.

**THE FIRST IMPRESSIONS
QUEST PROGRAM**

NO CLAIM IS MADE TO THE EXCLUSIVE RIGHT TO USE "PROGRAM", APART FROM THE MARK AS SHOWN.

FOR CONDUCTING EMPLOYEE INCENTIVE AWARD PROGRAMS TO PROMOTE ON THE JOB GOOD WILL AMONG EMPLOYEES (U.S. CLS. 100, 101 AND 102).

SN 76-132,558. GOOD SAMARITAN HOSPITAL MEDICAL CENTER, WEST ISLIP, NY. FILED 9-21-2000.

**FIRST IMPRESSIONS ARE
LASTING**

FOR CONDUCTING EMPLOYEE INCENTIVE AWARD PROGRAMS TO PROMOTE ON THE JOB GOOD WILL AMONG EMPLOYEES (U.S. CLS. 100, 101 AND 102).

SN 76-133,069. FORETHOUGHT FINANCIAL SERVICES, INC., BATESVILLE, IN. FILED 9-21-2000.

ADVANTAGEONE

FOR PROMOTING THE SALE OF PRE-NEED FUNERAL PLANNING TRUSTS THROUGH THE ADMINISTRATION OF INCENTIVE AWARD PROGRAMS FOR FUNERAL DIRECTORS (U.S. CLS. 100, 101 AND 102).

SN 76-137,834. HEAFNER TIRE GROUP, INC., CHARLOTTE, NC. FILED 9-29-2000.

MARKETINGEDGE

FOR AUTOMOTIVE AND VEHICLE BUSINESS MARKETING CONSULTING, NAMELY, DEVELOPING MARKETING PROGRAMS FOR AUTOMOTIVE AND VEHICLE BUSINESSES IN THE FIELD OF RETAILING TIRES AND AFTER-MARKET ACCESSORIES AND REPLACEMENT PARTS, AND IN THE FIELD OF AUTOMOTIVE AND VEHICLE MAINTENANCE AND REPAIR SERVICES (U.S. CLS. 100, 101 AND 102).

CLASS 35—(Continued).

SN 76-141,096. NEXTPART, INC., EVANSTON, IL. FILED 10-4-2000.

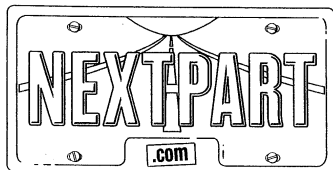

FOR DISTRIBUTORSHIPS AND RETAIL STORE SERVICES, ALL FEATURING RECYCLED PARTS FOR CARS, TRUCKS, MOTORCYCLES, BUSES, AND VANS, ALL VIA GLOBAL COMPUTER NETWORK AND TELEPHONE CALL CENTER (U.S. CLS. 100, 101 AND 102).

SN 76-141,325. THANEXUS, INCORPORATED, MANASQUAN, NJ. FILED 10-5-2000.

THANEXUS

FOR EMPLOYEE LEASING; OUTSOURCING SERVICES OF OTHERS IN THE FIELD OF FUNERAL DIRECTING AND OFFICE ADMINISTRATION TO FUNERAL ESTABLISHMENTS; BUSINESS MANAGEMENT AND CONSULTATION FOR FUNERAL SERVICE ESTABLISHMENTS; FUNERAL PRACTICE MANAGEMENT SERVICES; PERSONNEL MANAGEMENT; PAYROLL PREPARATION; TAX PREPARATION AND FILING; DEVELOPING FUNERAL BUSINESS OPERATIONS METHODS FOR OTHERS; COOPERATIVE ADVERTISING AND MARKETING; ADVERTISING SERVICES, NAMELY, PROMOTING THE SERVICES OF FUNERAL HOMES THROUGH THE DEVELOPMENT AND DISTRIBUTION OF PROMOTIONAL MATERIALS AND BY RENDERING SALES PROMOTION ADVICE (U.S. CLS. 100, 101 AND 102).

FIRST USE 9-17-1998; IN COMMERCE 9-17-1998.

SN 76-144,628. OILSPACE, INC., NEW YORK, NY. FILED 10-11-2000.

THE POWER OF COLLABORATIVE COMMERCE

FOR ONLINE BUSINESS TO BUSINESS RETAIL, AUCTION AND EXCHANGE SERVICE FOR BUYING AND SELLING COMMODITIES (U.S. CLS. 100, 101 AND 102).

CLASS 35—(Continued).

SN 76-145,034. GLACIER BAY SEAFOOD & MEAT CO., INC., SHAWNEE, KS. FILED 10-13-2000.

GBAY

FOR RETAIL STORE SERVICES THROUGH MAIL ORDER AND LIMITED HOME DELIVERY SERVICES FEATURING A WIDE VARIETY OF SEAFOOD AND OTHER MEATS, NAMELY, FISH, SHELLFISH, CHICKEN, BEEF AND PORK (U.S. CLS. 100, 101 AND 102).
FIRST USE 10-4-2000; IN COMMERCE 10-4-2000.

SN 76-147,018. LANVIN, JEAN-YVES, PARIS, FRANCE, FILED 10-16-2000.

LE WEBSTORE & WEBSTORE

NO CLAIM IS MADE TO THE EXCLUSIVE RIGHT TO USE "WEBSTORE & WEBSTORE", APART FROM THE MARK AS SHOWN.

FOR ONLINE RETAIL AND RETAIL STORE SERVICES FEATURING FASHION, FASHION ACCESSORIES, DESIGN, INTERIOR DECORATION, GOURMET FOOD AND RELATED PRODUCTS WITH A TECHNOLOGICAL ASPECT (U.S. CLS. 100, 101 AND 102).

SN 76-148,167. CITY PHOTO OF ST. LOUIS, INC., ST. LOUIS, MO. FILED 10-16-2000.



NO CLAIM IS MADE TO THE EXCLUSIVE RIGHT TO USE "DIGITAL", APART FROM THE MARK AS SHOWN.

FOR RETAIL SERVICES BY DIRECT SOLICITATION BY SALES AGENTS IN THE FIELD OF COMMERCIAL PHOTOGRAPHIC AND DIGITAL IMAGING EQUIPMENT (U.S. CLS. 100, 101 AND 102).

FIRST USE 8-1-1999; IN COMMERCE 8-1-1999.

CLASS 35—(Continued).

SN 76-150,361. CITIZENS FINANCIAL GROUP, INC., PROVIDENCE, RI. FILED 10-19-2000.



NO CLAIM IS MADE TO THE EXCLUSIVE RIGHT TO USE "BANK", APART FROM THE MARK AS SHOWN.
FOR PROCUREMENT, NAMELY, PURCHASING OF OFFICE SUPPLIES AND OFFICE FURNITURE FOR SMALL BUSINESSES VIA A GLOBAL COMPUTER INFORMATION NETWORK (U.S. CLS. 100, 101 AND 102).
FIRST USE 10-23-2000; IN COMMERCE 10-23-2000.

SN 76-151,328. YALE UNIVERSITY, NEW HAVEN, CT. FILED 10-20-2000.

YALE UNIVERSITY GOODS

OWNER OF U.S. REG. NOS. 1,391,543, 2,271,288 AND OTHERS.

NO CLAIM IS MADE TO THE EXCLUSIVE RIGHT TO USE "UNIVERSITY GOODS", APART FROM THE MARK AS SHOWN.

FOR RETAIL BOOKSTORE AND VARIETY STORE SERVICES; COMPUTERIZED ON-LINE RETAIL BOOKSTORE AND VARIETY STORE SERVICES (U.S. CLS. 100, 101 AND 102).

SN 76-151,329. YALE UNIVERSITY, NEW HAVEN, CT. FILED 10-20-2000.

THE YALE BOOKSTORE

OWNER OF U.S. REG. NOS. 1,391,543, 2,271,288 AND OTHERS.

NO CLAIM IS MADE TO THE EXCLUSIVE RIGHT TO USE "BOOKSTORE", APART FROM THE MARK AS SHOWN.

FOR RETAIL BOOKSTORE AND VARIETY STORE SERVICES; COMPUTERIZED ON-LINE RETAIL BOOKSTORE AND VARIETY STORE SERVICES (U.S. CLS. 100, 101 AND 102).

SN 76-151,922. EDWARDS CREATIVE LOGIC INC., PEORIA, IL. FILED 10-24-2000.

"LIVING THE BRAND"

FOR BUSINESS MARKETING; BUSINESS CONSULTATION; BUSINESS RESEARCH AND SURVEYS; DISSEMINATION OF ADVERTISING MATTER; AND PREPARING AND PLACING ADVERTISEMENTS FOR OTHERS (U.S. CLS. 100, 101 AND 102).

FIRST USE 10-2-2000; IN COMMERCE 10-2-2000.

CLASS 35—(Continued).

SN 76-159,696. GRAHAM ADVERTISING OF COLORADO, INC., COLORADO SPRINGS, CO. FILED 11-6-2000.

PREMIUM SELECT

NO CLAIM IS MADE TO THE EXCLUSIVE RIGHT TO USE "PREMIUM", APART FROM THE MARK AS SHOWN.
FOR RETAIL STORE SERVICES FOR AUTOMOBILES AND TRUCKS (U.S. CLS. 100, 101 AND 102).

SN 76-162,778. BOTANICALS ON THE PARK, INC., ST. LOUIS, MO. FILED 11-9-2000.

BOTANICALS ON THE PARK

NO CLAIM IS MADE TO THE EXCLUSIVE RIGHT TO USE "BOTANICALS" AND "PARK", APART FROM THE MARK AS SHOWN.

FOR RETAIL STORE SERVICES FEATURING DECORATIVE ITEMS, SEASONAL ITEMS, GIFTS, PLANTS, FLOWERS, TOYS, CARDS, FURNITURE, JEWELRY, AND CANDY (U.S. CLS. 100, 101 AND 102).

FIRST USE 8-30-1989; IN COMMERCE 8-30-1989.

SN 76-167,912. MERRILL & ASSOCIATES, INC., TUCKER, GA. FILED 11-20-2000.

COASTAL POND SUPPLY

NO CLAIM IS MADE TO THE EXCLUSIVE RIGHT TO USE "POND SUPPLY", APART FROM THE MARK AS SHOWN.

FOR WHOLESALE DISTRIBUTORSHIP FEATURING POND EQUIPMENT AND POND SUPPLIES FOR USE IN THE DESIGN, CONSTRUCTION AND MAINTENANCE OF DECORATIVE PONDS, WATERFALLS, STREAMBEDS, UNDERWATER LIGHTING AND CONTAINMENT BARRIERS (U.S. CLS. 100, 101 AND 102).

FIRST USE 0-0-1991; IN COMMERCE 0-0-1991.

SN 76-173,115. THRIVE!! INCORPORATED, RENO, NV. FILED 11-30-2000.

THRIVE!!

FOR EDUCATIONAL CONSULTING; AND INDIVIDUAL AND GROUP COACHING, NAMELY CONSULTING SERVICES IN THE FIELD OF OFFERING ADVICE REGARDING CUSTOMIZED ACTION AND STRATEGIC PLANNING, GOAL SETTING AND ACHIEVEMENT, DEVELOPMENT OF SUCCESSFUL OUTCOMES, CAREER DIRECTION AND TRANSITION, PERFORMANCE EXCELLENCE, LIFE DESIGN, FINANCIAL INTELLIGENCE, SYSTEMS DEVELOPMENT, MANAGING PROGRESS AND ACCOUNTABILITY, CONFLICT RESOLUTION AND COLLABORATION, LEADERSHIP, TEAMWORK, COMMUNICATION SKILLS, RISK MANAGEMENT, INNOVATION AND QUALITY IMPROVEMENT (U.S. CLS. 100, 101 AND 102).

FIRST USE 1-0-1997; IN COMMERCE 3-0-1997.

CLASS 35—(Continued).

SN 76-178,542. BOJORGES, ANGELA M. GIRALDO, IRVINE, CA. FILED 12-11-2000.

A.L.A.S. OF THE WORLD AMERICAN LABEL FOR ARTISTIC SOULS

FOR PROMOTION OF THE GOODS AND SERVICES OF OTHERS THROUGH THE ISSUANCE OF INCENTIVE AWARD CERTIFICATES, TO THOSE WHO ATTEND, SPONSOR OR PROMOTE LIVE RECORDINGS AT ENTERTAINMENT VENUES, WHICH ARE REDEEMABLE FOR MERCHANDISE AT PARTICIPATING VENDORS (U.S. CLS. 100, 101 AND 102).

SN 76-180,996. AUTOMOTIVE REBUILDERS SUPPLY, CHICAGO, IL. FILED 12-15-2000.



FOR WHOLESALE AND RETAIL STORE SERVICES FEATURING NEW AND USED HEAVY DUTY TRUCK PARTS (U.S. CLS. 100, 101 AND 102).

FIRST USE 0-0-1970; IN COMMERCE 0-0-1970.

CLASS 35—(Continued).

SN 76-182,498. MADISON SQUARE GARDEN, L.P., NEW YORK, NY. FILED 12-19-2000.



OWNER OF U.S. REG. NOS. 870,255, 2,197,935 AND OTHERS.

SEC. 2(F) AS TO "NEW YORK" AND THE REPRESENTATION OF THE BASKETBALL.

FOR COMPUTERIZED ON-LINE STORE, ORDERING, RETAIL, ELECTRONIC RETAILING, CATALOG AND MAIL ORDER CATALOG SERVICES FEATURING AUDIO RECORDINGS; VIDEO RECORDINGS; COMPUTER ACCESSORIES; COMPUTER GAMES; COMPUTER SOFTWARE; COMPUTER DATABASES; VIDEO GAMES; TELEPHONES; BINOCULARS; EYEWEAR; MAGNETS; COLLECTIBLE AND NOVELTY ITEMS; COLLECTIBLE COINS; MEDALLIONS; ALBUMS; SCRAPBOOKS; PHOTO FRAMES; SPORTS MEMORABILIA; TIME-PIECES; JEWELRY; JEWELRY BOXES; CREDIT CARDS; CALLING CARDS; PUBLICATIONS; CALENDARS; CATALOGS; ORGANIZERS; DIRECTORIES; STATIONERY; SCHOOL SUPPLIES; GIFTWARE; GIFT SETS; PORTFOLIOS; POSTERS; PHOTOS; TRADING CARDS; BOOKS; CARD HOLDERS; PAMPHLETS; PENNANTS; FLAGS; BANNERS; SOUVENIRS; CATALOGS; BANK CHECKS; BAGS; TRAVEL BAGS; TRAVEL CASES; SPORTS BAGS; LUNCH BOXES; WALLETS; UMBRELLAS; CLOTHING; TOYS; GAMES; SPORTING GOODS; CHRISTMAS ORNAMENTS; DECORATIONS; HOUSEWARES; LAMPS; LIGHTING FIXTURES; BEVERAGWEAR; KITCHENWARE; HOUSEHOLD SUPPLIES; CONTAINERS; BOXES; BED, BATH AND TABLE LINENS; FURNITURE, OFFICE FURNITURE AND ACCESSORIES; LOCKERS AND FOOTLOCKERS (U.S. CLS. 100, 101 AND 102).

FIRST USE 10-28-1995; IN COMMERCE 10-28-1995.

SN 76-183,557. NATIONAL RAILROAD PASSENGER CORPORATION, WASHINGTON, DC. FILED 12-7-2000.

AMTRAK GUEST REWARDS

OWNER OF U.S. REG. NOS. 960,643, 2,021,856 AND OTHERS.

NO CLAIM IS MADE TO THE EXCLUSIVE RIGHT TO USE "GUEST REWARDS", APART FROM THE MARK AS SHOWN.

FOR PROMOTING THE SALE OF GOODS AND SERVICES OF OTHERS BY AWARDING PURCHASE POINTS FOR MEMBERSHIP CARD AND MEMBERSHIP NUMBER USE (U.S. CLS. 100, 101 AND 102).

FIRST USE 11-29-2000; IN COMMERCE 11-29-2000.

CLASS 35—(Continued).

SN 76-184,962. EBAY INC., SAN JOSE, CA. FILED 12-22-2000.

**THE WORLD'S ONLINE
MARKETPLACE**

NO CLAIM IS MADE TO THE EXCLUSIVE RIGHT TO USE "ONLINE MARKETPLACE", APART FROM THE MARK AS SHOWN.

FOR ON-LINE TRADING SERVICES IN WHICH SELLER POSTS ITEMS TO BE AUCTIONED AND BIDDING IS DONE ELECTRONICALLY, AND PROVIDING EVALUATIVE FEEDBACK AND RATINGS OF SELLERS' GOODS AND SERVICES, THE VALUE AND PRICES OF SELLERS' GOODS, BUYERS' AND SELLERS' PERFORMANCE, DELIVERY, AND OVERALL TRADING EXPERIENCE IN CONNECTION THEREWITH (U.S. CLS. 100, 101 AND 102).

FIRST USE 5-9-2000; IN COMMERCE 5-9-2000.

SN 76-191,348. GROWTH COUNCIL OF OXFORD HILLS, SOUTH PARIS, ME. FILED 1-8-2001.

MAINE DISCOVERIES

OWNER OF U.S. REG. NO. 2,412,295.
NO CLAIM IS MADE TO THE EXCLUSIVE RIGHT TO USE "MAINE", APART FROM THE MARK AS SHOWN.

FOR RETAIL STORE SERVICES FEATURING HOUSEHOLD AND GIFT PRODUCTS WITH A CONNECTION TO THE STATE OF MAINE VIA A GLOBAL COMMUNICATIONS NETWORK (U.S. CLS. 100, 101 AND 102).

FIRST USE 11-1-2000; IN COMMERCE 11-1-2000.

SN 76-191,349. GROWTH COUNCIL OF OXFORD HILLS, SOUTH PARIS, ME. FILED 1-8-2001.

ENTERPRISEMAINE.COM

FOR PROMOTING THE ECONOMIC DEVELOPMENT OF THE STATE OF MAINE (U.S. CLS. 100, 101 AND 102).

SN 76-191,476. GROWTH COUNCIL OF OXFORD HILLS, SOUTH PARIS, ME. FILED 1-8-2001.

ENTERPRISEMAINE

FOR PROMOTING THE ECONOMIC DEVELOPMENT OF THE STATE OF MAINE (U.S. CLS. 100, 101 AND 102).

CLASS 35—(Continued).

SN 76-196,578. COLDWATER CREEK INC., SANDPOINT, ID. FILED 1-19-2001.

**ALL SIZES, ONE PRICE
WHAT A BEAUTIFUL FIT!**

OWNER OF U.S. REG. NO. 2,217,173.

FOR MAIL ORDER CATALOG SERVICES, RETAIL STORE SERVICES, AND ELECTRONIC MEDIA DISPLAY CATALOG SERVICES, ALL FEATURING BEDDING, LINEN, PILLOWS, WALL COVERINGS, TOWELS, WALL HANGINGS, BATHROOM ACCESSORIES AND DECORATIONS, BEDROOM ACCESSORIES AND DECORATIONS, BEDROOM FURNITURE, SLIPPERS, BATH ROBES, CANDLES, LAMPS, VASES, JEWELRY, PURSES, WATCHES, BELTS, CLOTHING, GIFTS AND CRAFTS (U.S. CLS. 100, 101 AND 102).

FIRST USE 1-1-2001; IN COMMERCE 1-1-2001.

SN 76-196,579. COLDWATER CREEK INC., SANDPOINT, ID. FILED 1-19-2001.

WHAT A BEAUTIFUL FIT!

OWNER OF U.S. REG. NO. 2,217,173.

FOR MAIL ORDER CATALOG SERVICES, RETAIL STORE SERVICES, AND ELECTRONIC MEDIA DISPLAY CATALOG SERVICES, ALL FEATURING BEDDING, LINEN, PILLOWS, WALL COVERINGS, TOWELS, WALL HANGINGS, BATHROOM ACCESSORIES AND DECORATIONS, BEDROOM ACCESSORIES AND DECORATIONS, BEDROOM FURNITURE, SLIPPERS, BATH ROBES, CANDLES, LAMPS, VASES, JEWELRY, PURSES, WATCHES, BELTS, CLOTHING, GIFTS AND CRAFTS (U.S. CLS. 100, 101 AND 102).

FIRST USE 1-1-2001; IN COMMERCE 1-1-2001.

SN 76-200,819. BOOZ ALLEN & HAMILTON, INC., MCLEAN, VA. FILED 1-26-2001.

SERVER2CEO

FOR MANAGEMENT CONSULTING SERVICES, NAMELY, STRATEGIC SUPPORT IN THE AREAS OF ONLINE BUSINESS, E-COMMERCE, AND INFORMATION TECHNOLOGY (U.S. CLS. 100, 101 AND 102).

CLASS 35—(Continued).

SN 76-201,582. OUTLOOK VISION SERVICES, MESA, AZ. FILED 12-18-2000.



OWNER OF U.S. REG. NO. 2,354,986.
NO CLAIM IS MADE TO THE EXCLUSIVE RIGHT TO USE "VISION SERVICES", APART FROM THE MARK AS SHOWN.

FOR PROMOTING THE EYEWEAR OF OTHERS THROUGH THE DISTRIBUTION OF DISCOUNT CARDS (U.S. CLS. 100, 101 AND 102).

FIRST USE 5-15-1989; IN COMMERCE 1-2-0090.

SN 76-202,000. A. VOGT MARKETING GROUP, INC., NEW BRAUNFELS, TX. FILED 1-30-2001.

THE PRESTIGIOUS MARK

NO CLAIM IS MADE TO THE EXCLUSIVE RIGHT TO USE "MARK", APART FROM THE MARK AS SHOWN.

FOR ADVERTISING SERVICES, NAMELY PROMOTING THE GOODS AND SERVICES OF OTHERS BY AFFIXING TRADEMARKS, TRADE NAMES, LOGOS, AND SERVICE MARKS OF OTHERS TO A WIDE VARIETY OF PROMOTIONAL GOODS (U.S. CLS. 100, 101 AND 102).

FIRST USE 1-12-2001; IN COMMERCE 1-12-2001.

SN 76-204,724. TRANSQUEST VENTURES, INC., WESTLAKE VILLAGE, CA. FILED 2-1-2001.



NO CLAIM IS MADE TO THE EXCLUSIVE RIGHT TO USE "VENTURES", APART FROM THE MARK AS SHOWN.

THE MARK CONSISTS IN PART OF THE LETTERS "TQ".
FOR BUSINESS SERVICES, NAMELY, TECHNICAL STAFFING AND TALENT AGENCY FOCUSED ON THE GLOBAL INFORMATION NETWORK AND EMERGING TECHNOLOGIES (U.S. CLS. 100, 101 AND 102).

FIRST USE 2-2-2000; IN COMMERCE 2-2-2000.

CLASS 35—(Continued).

SN 76-205,261. NOTHING BUT SILVER, INC., MONTEBELLO, CA. FILED 2-6-2001.



NO CLAIM IS MADE TO THE EXCLUSIVE RIGHT TO USE "NOTHING BUT SILVER", APART FROM THE MARK AS SHOWN.

FOR RETAIL STORE SERVICES IN THE FIELD OF JEWELRY, NAMELY, EARRINGS, BRACELETS, CHAINS, RINGS, CHARMS, AND OTHER RELATED ITEMS, SOME SET WITH SEMI-PRECIOUS STONES (U.S. CLS. 100, 101 AND 102).

FIRST USE 8-0-1994; IN COMMERCE 8-0-1994.

SN 76-211,329. ADVANTAGE ADVERTISING, INC., DEERFIELD, IL. FILED 2-15-2001.

CLIX

FOR EMPLOYEE RECRUITMENT ADVERTISING, COMMUNICATIONS AND CONSULTATION SERVICES, NAMELY, RESEARCH AND SELECTION FOR OTHERS OF EMPLOYEE RECRUITMENT SITES ACCESSED VIA GLOBAL COMPUTER NETWORKS AND PLACING FOR OTHERS RECRUITMENT POSTINGS ON SELECTED SITES (U.S. CLS. 100, 101 AND 102).

FIRST USE 10-30-2000; IN COMMERCE 10-30-2000.

SN 76-220,198. CLEARTRACK INFORMATION NETWORK, INC., BRENTWOOD, TN. FILED 3-6-2001.



FOR WEB BASED TRACKING OF SHIPMENTS FOR OTHERS AND PROVIDING INFORMATION ABOUT SHIPMENTS INCLUDING INFORMATION REGARDING SHIPMENT LOCATION (U.S. CLS. 100, 101 AND 102).

FIRST USE 2-15-2001; IN COMMERCE 2-15-2001.

CLASS 35—(Continued).

SN 76-222,181. DESIGN INTERSHOP, L.L.C., RICHMOND, VA. FILED 3-9-2001.

HELTEN BEST OF DESIGN

NO CLAIM IS MADE TO THE EXCLUSIVE RIGHT TO USE "BEST OF DESIGN", APART FROM THE MARK AS SHOWN.

FOR WHOLESALE DISTRIBUTORSHIP AND RETAIL STORE SERVICES IN THE AREAS OF FURNITURE, HOME ACCESSORIES AND OFFICE FURNITURE (U.S. CLS. 100, 101 AND 102).

SN 76-222,426. CABOULI, PAULINE, CHAPPAQUA, NY. FILED 3-9-2001.

FLORIMOND'S KITCHEN GARDEN

NO CLAIM IS MADE TO THE EXCLUSIVE RIGHT TO USE "KITCHEN GARDEN", APART FROM THE MARK AS SHOWN.

FOR RETAIL STORE SERVICES AND MAIL ORDER CATALOG SERVICES BOTH FEATURING THE FOLLOWING GOODS - VEGETABLE PLANTS AND SEEDS; HERB PLANTS AND SEEDS; LIVE FRUIT TREES AND VINES; FRUIT SHRUBS; LIVE NUT TREES; ORNAMENTAL FRUIT AND FLOWERING TREES; BERRY BUSHES; GARLIC BULBS, SHALLOT BULBS AND ONION BULBS; POTATO TUBERS; FLOWER BULBS; FLOWER SEEDS; ANNUAL AND PERENNIAL FLOWER PLANTS AND SHRUBS; FLOWERS; GRASSES; LAWN MOWERS; MULCHERS; TREE-TRAINING STAKES AND KITS; FERTILIZERS AND PLANT BOOSTERS; PLASTIC MULCH; FRUIT PICKERS; BASKETS; PROTECTIVE PLASTIC AND NETTING FOR PLANTS; ANIMAL AND BUG REPELLANTS; DECORATIVE GARDEN STATUES AND LAWN DECORATIONS; DECORATIVE GARDEN PLAQUES, STONES AND TILES; SUNDIALS; REFLECTIVE GARDEN GLOBES; WATER GARDEN KITS; FLAGS; FLAGPOLES; DECK AND WINDOW BOXES; VASES; BIRD FEEDERS; BIRD BATHS; BIRD SEED; SCARECROWS; BUTTERFLY HOUSES; BEE HOUSES; FLOWER-BASED PERFUMES AND COLOGNES; ESSENTIAL SCENTED OILS; FLOWER, VEGETABLE AND HERBAL SOAPS; BATH SALTS AND BUBBLE BATHS; ROOM FRAGRANCES; HAND AND BODY CREAMS; POTPOURRI; POTPOURRI AND SACHET KITS; PLANT DRYING AND PRESSING KITS; EGG DYEING KITS; PUMPKIN-CARVING KITS; BOTANICAL-THEME AND HISTORICAL-THEME DINNERWARE; TABLEWARE; TABLECLOTHS AND NAPKINS; CURTAINS; FABRICS AND UPHOLSTERY; BLANKETS AND THROWS; AREA RUGS; PILLOWS; WALLPAPER AND WALLPAPER TRIM; STENCILS; PAINTS; PAINT BRUSHES AND PAINT KITS; CRAFT ITEMS; MAGNETS; STORAGE BOXES AND CONTAINERS; PICNIC WARE; GARDEN TABLES; GARDEN BENCHES AND CHAIRS; LANTERNS; OUTDOOR LIGHTS; TRELLISES; GAZEBOS; FENCES; WATERING CANS; GARDEN HOSES AND IRRIGATION SUPPLIES; COMPOSTING PRODUCTS; GARDENING IMPLEMENTS, NAMELY TROWELS, WEEDERS, FORKS, LOPPERS, SCISSORS, PRUNERS, HEDGE TRIMMERS, SEEDERS AND SHOVELS; WHEELBARROWS; FRESH FLOWER PRESERVATIVE POWDERS; PLANT FOOD; GARDENING BOOKS; COOKBOOKS; COOKING IMPLEMENTS, NAMELY KNIVES, SPATULAS, SPOONS, TONGS; BARBEQUE IMPLEMENTS; APRONS; ICE CREAM AND GELATI MAKERS; JUICERS; POTS AND PANS; KITCHEN TOWELS, OVEN MITTS; GIFT CARDS, GREETING CARDS AND HOLIDAY CARDS; GIFT WRAPPING PAPER; GIFT PACKAGES AND GIFT BASKETS; CALENDARS; DATE BOOKS; PLANTING PLANNERS; JOURNALS; ART PENCILS AND ART PAPER; POSTCARDS; POSTERS; ADDRESS BOOKS; ORGANIZERS; PICTURE

CLASS 35—(Continued).

FRAMES; FRAMED PRINTS; STATIONERY; DECORATIVE STICKERS; SEWING, KNITTING AND CROCHET SUPPLIES; BUTTONS; NEEDLEPOINT PATTERNS AND EMBROIDERY KITS; QUILTING SUPPLIES; CLOCKS; CUPBOARDS; RIBBONS; GARDENING HATS; GARDENING T-SHIRTS; GARDENING PANTS; GARDENING SHOES; GARDENING GLOVES; OLIVE OIL; SALT; JAMS; JELLIES; PRESERVES; SAUCES; TEAS; TEAPOTS; COASTERS; COFFEE; COFFEE URNS; COOKIE CUTTERS; BAKING MIXES; SYRUPS; HONEY; COOKIES; CANDY; MUFFIN MIXES; BREAD MIXES AND BREAD MAKERS; VINEGARS; SALAD DRESSINGS; BUTTERS; CANDLES; CANDLE HOLDERS; PET HOUSES; PET BASKETS; PET BEDS; DECORATIVE SHELVES; AND COSTUME JEWELRY (U.S. CLS. 100, 101 AND 102).

SN 76-224,640. MINDBRANCH, INC., NORTH ADAMS, MA. FILED 3-15-2001.



THE MARK CONSISTS OF THE IMAGE OF A HUMAN FACE CONTAINED IN THE OUTLINE OF A LEAF. FOR MARKET RESEARCH AND RELATED SERVICES, NAMELY, MARKET ANALYSIS AND COMPILATION AND BUSINESS MARKETING CONSULTING SERVICES (U.S. CLS. 100, 101 AND 102). FIRST USE 8-28-2000; IN COMMERCE 8-28-2000.

SN 76-224,683. FIDENOR, COL. LOMAS DE SAN FRANCISCO, MEXICO, FILED 3-15-2001.

THE HEART OF NAFTA

NO CLAIM IS MADE TO THE EXCLUSIVE RIGHT TO USE "NAFTA", APART FROM THE MARK AS SHOWN. FOR CHAMBER OF COMMERCE SERVICES, NAMELY, PROMOTING BUSINESS DEVELOPMENT IN COLOMBIA, MEXICO (U.S. CLS. 100, 101 AND 102).

CLASS 35—(Continued).

SN 76-226,352. TECHNOLOGY FOR EDUCATION, INC., INVER GROVE HEIGHTS, MN. FILED 3-20-2001.

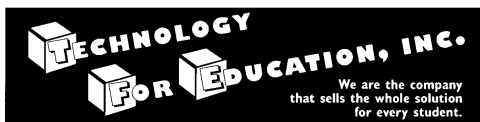

NO CLAIM IS MADE TO THE EXCLUSIVE RIGHT TO USE "TECHNOLOGY FOR EDUCATION, INC.", APART FROM THE MARK AS SHOWN.

FOR NATIONAL DISTRIBUTORSHIP SERVICES FEATURING ASSISTIVE TECHNOLOGY FOR SPECIAL NEEDS STUDENTS AND GENERAL LEARNING PRODUCTS AND ACCESSORIES FOR USE IN KINDERGARTEN THROUGH TWELFTH GRADE AND IN HIGHER EDUCATION INSTITUTIONS THROUGHOUT THE UNITED STATES (U.S. CLS. 100, 101 AND 102).

FIRST USE 4-0-1995; IN COMMERCE 4-0-1995.

SN 76-227,207. IRANI, BENAFSHA, SAN FRANCISCO, CA. FILED 3-19-2001.

WESTCOAST CONSULTING GROUP

NO CLAIM IS MADE TO THE EXCLUSIVE RIGHT TO USE "CONSULTING GROUP", APART FROM THE MARK AS SHOWN.

FOR BUSINESS CONSULTATION SERVICES IN THE FIELD OF WIRELESS COMMUNICATIONS (U.S. CLS. 100, 101 AND 102).

CLASS 35—(Continued).

SN 76-229,566. DENVER NUGGETS LIMITED PARTNERSHIP, THE, DENVER, CO. FILED 3-26-2001.



OWNER OF U.S. REG. NOS. 1,094,036, 1,903,645 AND OTHERS.

SEC. 2(F).

FOR COMPUTERIZED ON-LINE RETAIL STORE, ORDERING, RETAIL, ELECTRONIC RETAILING, CATALOG AND MAIL ORDER CATALOG SERVICES FEATURING AUDIO RECORDINGS; VIDEO RECORDINGS; COMPUTER ACCESSORIES; COMPUTER GAMES; COMPUTER SOFTWARE; COMPUTER DATABASES; VIDEO GAMES; TELEPHONES; BINOCULARS; EYEWEAR; MAGNETS; COLLECTIBLE AND NOVELTY ITEMS; COLLECTIBLE COINS; MEDALLIONS; ALBUMS; SCRAPBOOKS; PHOTO FRAMES; SPORTS MEMORABILIA; TIMEPIECES; JEWELRY; JEWELRY BOXES; CREDIT CARDS; CALLING CARDS; PUBLICATIONS; CALENDARS; CATALOGS; ORGANIZERS; DIRECTORIES; STATIONERY; SCHOOL SUPPLIES; GIFT WARE; GIFT SETS; PORTFOLIOS; POSTERS; PHOTOS; TRADING CARDS; BOOKS; CARD HOLDERS; PAMPHLETS; PENNANTS; FLAGS; BANNERS; SOUVENIRS; CATALOGS; BANK CHECKS; BAGS; TRAVEL BAGS; TRAVEL CASES; SPORTS BAGS; LUNCH BOXES; WALLET; UMBRELLAS; CLOTHING; TOYS; GAMES; SPORTING GOODS; CHRISTMAS ORNAMENTS; DECORATIONS; HOUSEWARES; LAMPS; LIGHTING FIXTURES; BEVERAGEWARE; KITCHENWARE; HOUSEHOLD SUPPLIES; CONTAINERS; BOXES; BED, BATH AND TABLE LINENS; FURNITURE, OFFICE FURNITURE AND ACCESSORIES; LOCKERS AND FOOTLOCKERS; PROMOTING THE GOODS AND SERVICES OF OTHERS BY ALLOWING SPONSORS TO AFFILIATE THESE GOODS AND SERVICES WITH A BASKETBALL PROGRAM; PROMOTING THE SALE OF GOODS AND SERVICES OF OTHERS THROUGH THE DISTRIBUTION OF PROMOTIONAL CONTESTS PROVIDED OVER THE INTERNET (U.S. CLS. 100, 101 AND 102).

FIRST USE 10-28-1995; IN COMMERCE 10-28-1995.

SN 76-229,664. OLIVIER OLIVE OIL PRODUCTS, INC., DBA OLIVIER NAPA VALLEY, ST. HELENA, CA. FILED 3-23-2001.

OLIVIER NAPA VALLEY

NO CLAIM IS MADE TO THE EXCLUSIVE RIGHT TO USE "NAPA VALLEY", APART FROM THE MARK AS SHOWN.

FOR RETAIL SHOPS AND RETAIL OUTLETS FEATURING GOURMET FOODS (U.S. CLS. 100, 101 AND 102).

FIRST USE 11-25-1999; IN COMMERCE 11-25-1999.

CLASS 35—(Continued).

SN 76-238,066. SHADOW VENTURES, LLC, BIRMINGHAM, AL. FILED 4-9-2001.



FOR BUSINESS MANAGEMENT SERVICES, NAMELY, PROVIDING BUSINESS MANAGEMENT SERVICES TO TECHNOLOGY START-UP COMPANIES (U.S. CLS. 100, 101 AND 102).

FIRST USE 9-18-2000; IN COMMERCE 9-18-2000.

SN 76-238,958. SM ADVISORS, INC., SHEBOYGAN, WI. FILED 4-11-2001.



NO CLAIM IS MADE TO THE EXCLUSIVE RIGHT TO USE "ADVISORS" AND "STRATEGIC MANAGEMENT", APART FROM THE MARK AS SHOWN.

THE LINING IN THE DRAWING IS A FEATURE OF THE MARK AND DOES NOT INDICATE COLOR.

THE MARK CONSISTS IN PART OF THE STYLIZED LETTERS "SM".

FOR BUSINESS PLANNING AND BUSINESS CONSULTING SERVICES (U.S. CLS. 100, 101 AND 102).

FIRST USE 1-0-2001; IN COMMERCE 1-0-2001.

SN 76-241,848. DEI MARKETING, LOS ANGELES, CA. BY CHANGE OF NAME GUERILLAPR, LOS ANGELES, CA. FILED 4-17-2001.

DIRECTLY ENGAGED INTERACTIVE IMPRESSION

NO CLAIM IS MADE TO THE EXCLUSIVE RIGHT TO USE "INTERACTIVE", APART FROM THE MARK AS SHOWN.

FOR BUSINESS MARKETING CONSULTING SERVICES; ADVERTISING AND MARKETING SERVICES, NAMELY, MARKET RESEARCH, COOPERATIVE ADVERTISING AND MARKETING, AND CONDUCTING MARKETING STUDIES (U.S. CLS. 100, 101 AND 102).

CLASS 35—(Continued).

SN 76-243,227. PROMINENTA, S.A., CORDOBA CITY 5001, ARGENTINA, FILED 4-17-2001.

PECTRA TECHNOLOGY

NO CLAIM IS MADE TO THE EXCLUSIVE RIGHT TO USE "TECHNOLOGY", APART FROM THE MARK AS SHOWN.

FOR BUSINESS MANAGEMENT AND CONSULTATION SERVICES; CONDUCTING BUSINESS MARKET SURVEYS; BUSINESS MANAGEMENT PLANNING; COMMERCIAL AND INDUSTRIAL MANAGEMENT ASSISTANCE; BUSINESS MARKETING SERVICES; COMMERCIAL INFORMATION AND DIRECTORY SERVICES; PREPARING BUSINESS REPORTS; BUSINESS RESEARCH AND PLANNING; PERSONNEL PLACEMENT, RECRUITMENT AND MANAGEMENT; BUSINESS SUPERVISION; ADVERTISING AND MARKETING SERVICES FOR OTHERS (U.S. CLS. 100, 101 AND 102).

SN 76-244,082. STEIN, LES, CLEVELAND, OH. FILED 4-23-2001.

H2O PERFORMANCE

FOR PROVIDING ON-LINE ADVERTISING, MARKETING AND SALES INFORMATION FOR OWNERS, MANUFACTURERS AND DEALERS OF HIGH PERFORMANCE BOATS AND ACCESSORIES (U.S. CLS. 100, 101 AND 102).

FIRST USE 3-8-2001; IN COMMERCE 3-8-2001.

SN 76-250,380. FEDERAL TECHNOLOGIES SOLUTIONS, INC., LAKE RIDGE, VA. FILED 5-2-2001.

FEDTEK

FOR DISTRIBUTORSHIPS IN THE FIELD OF COMPUTER HARDWARE, PERIPHERALS, COMPUTER SUPPLIES AND SOFTWARE; COMPUTERIZED ON-LINE ORDERING SERVICES IN THE FIELD OF COMPUTER HARDWARE, PERIPHERALS, COMPUTER SUPPLIES AND SOFTWARE (U.S. CLS. 100, 101 AND 102).

FIRST USE 10-0-1996; IN COMMERCE 10-0-1996.

SN 76-251,581. MERELINDA FARM LLC, DBA ALPACA-COM LLC, WHITMORE LAKE, MI. FILED 5-7-2001.

PACABID

FOR ON-LINE TRADING SERVICES IN WHICH SELLER POSTS PRODUCTS TO BE AUCTIONED AND BIDDING IS DONE VIA THE INTERNET (U.S. CLS. 100, 101 AND 102).

FIRST USE 2-15-2001; IN COMMERCE 2-15-2001.

CLASS 35—(Continued).

SN 76-254,532. RESPONSECODE LLC, BOTHELL, WA. FILED 5-10-2001.

RESPONSECODE

FOR MARKETING SERVICES, NAMELY, DIRECT MARKETING ADVERTISING SERVICES FOR OTHERS, DIRECT MAIL ADVERTISING, BUSINESS MARKETING AND DIRECT MAIL CONSULTING SERVICES, MARKETING ANALYSIS, AND MAILING LIST BROKERAGE SERVICES (U.S. CLS. 100, 101 AND 102).
FIRST USE 1-11-2000; IN COMMERCE 1-25-2000.

SN 76-259,640. SEARS, ROEBUCK AND CO., HOFFMAN ESTATES, IL. FILED 5-18-2001.

WE KNOW TIRES

NO CLAIM IS MADE TO THE EXCLUSIVE RIGHT TO USE "TIRES", APART FROM THE MARK AS SHOWN.
FOR RETAIL TIRE STORE SERVICES (U.S. CLS. 100, 101 AND 102).

SN 76-262,007. SPARTAN STORES, INC., GRAND RAPIDS, MI. FILED 5-25-2001.



THE LINING IS A FEATURE OF THE MARK AND DOES NOT INDICATE COLOR.

THE DESIGN IS COMPRISED OF A TRIANGLE WITH A RIBBON RUNNING OVER IT.

FOR RETAIL GROCERY STORE SERVICES (U.S. CLS. 100, 101 AND 102).

FIRST USE 7-12-2000; IN COMMERCE 7-12-2000.

SN 76-263,239. ELLISON EDUCATIONAL EQUIPMENT, INC., LAKE FOREST, CA. FILED 5-29-2001.

YOUR PARTNER IN CREATIVITY

FOR MAIL ORDER AND ON-LINE CATALOG SERVICES FEATURING HAND OPERATED DIE AND PLATE CUTTING, EMBOSsing AND STAMPING MACHINES, STEEL RULE DIES, AND PRODUCTS TO BE CUT, EMBOSSED AND STAMPED, NAMELY, SHEETS OF PAPER, FABRIC, PLASTIC, VELLUM, WOOD, SPONGE, FOIL AND LEATHER (U.S. CLS. 100, 101 AND 102).

FIRST USE 9-15-2000; IN COMMERCE 9-15-2000.

CLASS 35—(Continued).

SN 76-263,257. CAMERON ASHLEY BUILDING PRODUCTS, INC., GREENVILLE, SC. FILED 5-29-2001.

STORMLOCS

FOR WHOLESALE SERVICES THROUGH THE USE OF AN INDEPENDENT NETWORK OF CONTRACTORS FEATURING STORM PANELS (U.S. CLS. 100, 101 AND 102).

SN 76-268,280. SUBURBAN PROPANE, L.P., WHIPPANY, NJ. FILED 6-7-2001.



NO CLAIM IS MADE TO THE EXCLUSIVE RIGHT TO USE "CYLINDER EXPRESS", APART FROM THE MARK AS SHOWN.

COLOR IS A FEATURE OF THE MARK. THE COLOR BLUE IS USED TO OUTLINE THE GAS TANK. THE ARROWS AND THE WORD "EXPRESS" ARE ALSO COLORED BLUE. THE WORD "SUBURBAN" IS COLORED RED AND THE WORD "CYLINDER" IS COLORED LIGHT BLUE.

FOR FRANCHISING, NAMELY, OFFERING TECHNICAL ASSISTANCE IN THE ESTABLISHMENT AND/OR OPERATION OF DISTRIBUTORSHIPS FEATURING THE SALE AND DISTRIBUTION OF PROPANE GAS AND PROPANE RELATED EQUIPMENT (U.S. CLS. 100, 101 AND 102).

SN 76-268,281. SUBURBAN PROPANE, L.P., WHIPPANY, NJ. FILED 6-7-2001.



NO CLAIM IS MADE TO THE EXCLUSIVE RIGHT TO USE "CYLINDER EXPRESS", APART FROM THE MARK AS SHOWN.

COLOR IS A FEATURE OF THE MARK. THE ARROWS AND THE WORD "EXPRESS" ARE COLORED BLUE. THE WORD "SUBURBAN" IS COLORED RED AND THE WORD "CYLINDER" IS COLORED LIGHT BLUE.

FOR FRANCHISING, NAMELY, OFFERING TECHNICAL ASSISTANCE IN THE ESTABLISHMENT AND/OR OPERATION OF DISTRIBUTORSHIPS FEATURING THE SALE AND DISTRIBUTION OF PROPANE GAS AND PROPANE RELATED EQUIPMENT (U.S. CLS. 100, 101 AND 102).

CLASS 35—(Continued).

SN 76-268,938. RETREAT TO A MEMORY, LLC, EUBANK, KY. FILED 6-8-2001.

RETREAT TO A MEMORY

FOR RETAIL STORES FEATURING ANTIQUES, CRAFTS, FOODS, PLANTS, GIFTS, AND COLLECTIBLES (U.S. CLS. 100, 101 AND 102).

CLASS 35—(Continued).

SN 76-272,847. SHAPIRO, ROB, SAN FRANCISCO, CA. FILED 6-18-2001.

BAD COMPANY FILMS

NO CLAIM IS MADE TO THE EXCLUSIVE RIGHT TO USE "FILMS", APART FROM THE MARK AS SHOWN.
FOR PRODUCING COMMERCIALS FOR USE ON RADIO, TELEVISION, COMPUTER NETWORKS, AND AUDIO-VISUAL MEDIA, FOR OTHERS (U.S. CLS. 100, 101 AND 102).

SN 76-268,953. POWER BUYING DEALERS, USA, INC., OAKBROOK, IL. FILED 6-8-2001.

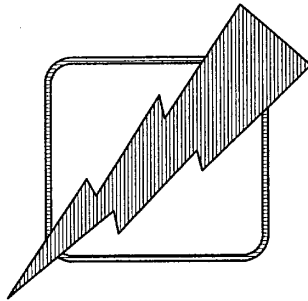

THE DRAWING IS LINED/SHADED TO DESIGNATE COLOR AS INDICATED BELOW. SAID DESIGNATED COLORS BEING A CLAIMED FEATURE OF THE MARK - LIGHTNING BOLT - RED ALL OTHER LINES - BLUE.

FOR PROVIDING AN ON-LINE COMPUTER DATABASE ON GLOBAL COMPUTER NETWORKS IN THE FIELD OF RETAIL GASOLINE STATION CONVENIENCE STORES (U.S. CLS. 100, 101 AND 102).

SN 76-275,433. GENOVA, JACK J., MIAMI, FL. FILED 6-25-2001.

MY POOL

NO CLAIM IS MADE TO THE EXCLUSIVE RIGHT TO USE "POOL", APART FROM THE MARK AS SHOWN.

FOR RETAIL STORE AND DISTRIBUTORSHIPS IN THE FIELD OF POOL, SPA AND PATIO SUPPLIES, NAMELY, FOUNTAINS, FURNITURE, BOOKS, BRUSHES, AIRBLOWERS, BASKETS, CHEMICALS, TEST KITS, ELECTRICAL LIGHTS, LEAF TRAPS, POLES, NETS, PUMPS, FILTERS, GAMES AND TOYS, INFLATABLES, LOUNGERS, SOLAR BLANKETS, HEATERS, THERMOMETERS, DIVING BOARDS, LADDERS AND SLIDES, MOTORS, AUTOMATIC CLEANERS, SKIMMERS AND VACUUMS (U.S. CLS. 100, 101 AND 102).

FIRST USE 3-21-1989; IN COMMERCE 3-21-1989.

SN 76-276,318. COMPLETE PANDEMONIUM LLC, SAN FRANCISCO, CA. FILED 6-25-2001.

MEKANISM

FOR CONSULTATION SERVICES, NAMELY CREATIVE AND STRATEGIC CONSULTATION REGARDING DEVELOPMENT AND PRODUCTION OF ADVERTISING CAMPAIGNS FOR OTHERS; DEVELOPMENT AND PRODUCTION OF ADVERTISING CAMPAIGNS FOR OTHERS (U.S. CLS. 100, 101 AND 102).

FIRST USE 9-1-2000; IN COMMERCE 9-1-2000.

SN 76-269,185. LADARRIN'S FRAGRANCES, GRAHAM, NC. FILED 6-11-2001.



NO CLAIM IS MADE TO THE EXCLUSIVE RIGHT TO USE "FRAGRANCES", APART FROM THE MARK AS SHOWN.

FOR RETAIL AND WHOLESALE STORE SERVICES FEATURING EXOTIC BODY OILS, PERFUMES, INCENSE, LOTIONS, SOAPS AND BATH GELS (U.S. CLS. 100, 101 AND 102).

FIRST USE 4-1-1997; IN COMMERCE 4-1-1997.

SN 76-277,007. GONEHOME.COM, INC., CANTON, OH. FILED 6-25-2001.

GONEHOME

FOR PROVIDING ONLINE AND DIRECT INFORMATION SERVICES IN THE FIELD OF REAL ESTATE MARKETING (U.S. CLS. 100, 101 AND 102).

FIRST USE 1-8-2000; IN COMMERCE 2-0-2000.

CLASS 35—(Continued).

SN 76-277,921. TOWER CONSULTANTS, LTD., STUART, FL. FILED 6-28-2001.

TOWER CONSULTANTS

NO CLAIM IS MADE TO THE EXCLUSIVE RIGHT TO USE "CONSULTANTS", APART FROM THE MARK AS SHOWN.

FOR HUMAN RESOURCE CONSULTING; EXECUTIVE SEARCHING AND PLACEMENT (U.S. CLS. 100, 101 AND 102).

FIRST USE 10-1-1988; IN COMMERCE 1-1-1999.

SN 76-278,022. GUMBALL GOURMET, INC., TAYLORS, SC. FILED 6-28-2001.

GUMBALL GOURMET

NO CLAIM IS MADE TO THE EXCLUSIVE RIGHT TO USE "GUMBALL", APART FROM THE MARK AS SHOWN. FOR RETAIL SERVICES FEATURING GUMBALLS (U.S. CLS. 100, 101 AND 102).

FIRST USE 4-1-1999; IN COMMERCE 6-6-2000.

SN 76-279,683. FIGARO'S ITALIAN PIZZA, INC., SALEM, OR. FILED 7-2-2001.

HOME OF THE FREE PIZZA

FOR RETAIL PIZZA STORE SERVICES FEATURING BAKED AND UNBAKED PIZZA AND BREADSTICKS; UNBAKED CALZONE AND LASAGNA AND GARLIC BREAD; COOKIES AND SOFT DRINKS, ALL FOR CUSTOMER TAKE-OUT (U.S. CLS. 100, 101 AND 102).

SN 76-291,254. NATIONAL CABLE COMMUNICATIONS LLC, NEW YORK, NY. FILED 7-23-2001.

FUSION

FOR ANALYZING DEMOGRAPHIC, GEOGRAPHIC, AUDIENCE ESTIMATE AND QUANTITATIVE INFORMATION FOR CABLE SYSTEMS AND CABLE INTERCONNECTS; MARKET RESEARCH SERVICES RELATING TO CABLE SYSTEMS AND CABLE INTERCONNECTS; ANALYZING THE LISTENING, VIEWING AND USAGE HABITS OF CABLE-RECEIVING AUDIENCES FOR OTHERS (U.S. CLS. 100, 101 AND 102).

FIRST USE 0-0-1998; IN COMMERCE 0-0-1998.

CLASS 35—(Continued).

SN 76-294,996. ROBUS, DEBBIE, HEBER SPRINGS, AZ. FILED 8-3-2001.

WORKCAMPER

OWNER OF U.S. REG. NOS. 1,675,865 AND 1,678,511. FOR PROVIDING INFORMATION ABOUT EMPLOYMENT OPPORTUNITIES WITH NON-PROFIT AND CHARITABLE ORGANIZATIONS VIA PRINTED MATERIALS AND VIA THE INTERNET (U.S. CLS. 100, 101 AND 102).

FIRST USE 7-25-2001; IN COMMERCE 7-25-2001.

SN 76-299,285. U.S. AND FOREIGN COMMERCIAL SERVICE, WASHINGTON, DC. FILED 8-15-2001.

BUYUSA

FOR BUSINESS INFORMATION AND CONSULTING SERVICES TO ASSIST THE UNITED STATES BUSINESS COMMUNITY IN THE FIELD OF INTERNATIONAL TRADE, NAMELY, CONSULTATION, INFORMATION AND ASSISTANCE CONCERNING THE IMPORT AND EXPORT OF GOODS AND SERVICES, PROVIDING A VENUE VIA A GLOBAL COMPUTER NETWORK FOR THE CONDUCT OF TRADE SHOWS AND THE MARKETING OF GOODS AND SERVICES, PROVIDING A DIRECTORY OF EXPORT SERVICE PROVIDERS, TRADING COMPANIES AND TRADE INTERMEDIARIES, AND THE PROVISION OF OVERSEAS TRADE LEADS TO THE UNITED STATES BUSINESS COMMUNITY (U.S. CLS. 100, 101 AND 102).

FIRST USE 6-25-2001; IN COMMERCE 6-25-2001.

SN 76-304,141. RBCO, L.L.C., NORWALK, IA. FILED 8-23-2001.

RESUMECANNON

FOR ELECTRONIC RESUME DISTRIBUTION (U.S. CLS. 100, 101 AND 102).

SN 76-312,376. ANTHONY MICHAEL & COMPANY, INC., ROCKLAND, MA. FILED 9-17-2001.

"The Art and Science of Executive Search"

FOR APPLICANT IS A RETAINED EXECUTIVE SEARCH FIRM PROVIDING EXECUTIVE SEARCH SERVICES FOR MUTUAL FUND COMPANIES AND INVESTMENT/ASSET MANAGEMENT FIRMS (U.S. CLS. 100, 101 AND 102).

CLASS 35—(Continued).

SN 76-324,032. GALLUP, INC., LINCOLN, NE. FILED 10-11-2001.

SF34

FOR PROVIDING AN INTERACTIVE WEB SITE ON A GLOBAL COMPUTER NETWORK FEATURING INFORMATION IN THE FIELD OF PERSONNEL EVALUATIONS AND ASSESSMENTS (U.S. CLS. 100, 101 AND 102).

CLASS 35—(Continued).

SN 78-019,065. INTELLECTMARKET, INC., WINDSOR, CA. FILED 7-31-2000.



SN 78-006,838. SZUMOWSKI, DANUSIA, PALO ALTO, CA. FILED 5-4-2000.

FOR ONLINE RETAIL STORE SERVICES FEATURING SOFTWARE COMPONENTS (U.S. CLS. 100, 101 AND 102).
FIRST USE 1-0-2000; IN COMMERCE 1-0-2000.



FOR MARKET RESEARCH; BUSINESS CONSULTATION SERVICES IN THE FIELD OF PRODUCT BRANDING AND POSITIONING FOR OTHERS (U.S. CLS. 100, 101 AND 102).
FIRST USE 2-0-1999; IN COMMERCE 2-0-1999.

SN 78-019,071. INTELLECTMARKET, INC., WINDSOR, CA. FILED 7-31-2000.

COMPONENTPLANET

SN 78-010,588. IAMS COMPANY, THE, CINCINNATI, OH. FILED 5-31-2000.

EUKANDOIT

FOR ONLINE RETAIL STORE AND WHOLESALE DISTRIBUTORSHIP SERVICES FEATURING SOFTWARE COMPONENTS (U.S. CLS. 100, 101 AND 102).
FIRST USE 8-0-2000; IN COMMERCE 11-0-2000.

OWNER OF U.S. REG. NOS. 2,174,581, 2,176,342 AND 2,178,041.

FOR PROVIDING INFORMATION ON PET FOOD PRODUCTS FOR PURCHASING PURPOSES (U.S. CLS. 100, 101 AND 102).

SN 78-020,239. STONE ANALYTICS, INC., SAN DIEGO, CA. FILED 8-8-2000.

STONE ANALYTICS

SN 78-012,983. EVANS, CANDICE S., SILVER SPRING, MD. FILED 6-16-2000.

**ADMINISTRATIVE
OUTSOURCE SOLUTIONS**

NO CLAIM IS MADE TO THE EXCLUSIVE RIGHT TO USE "ADMINISTRATIVE OUTSOURCE", APART FROM THE MARK AS SHOWN.

FOR BUSINESS MANAGEMENT AND ADMINISTRATION SERVICES FOR OTHERS (U.S. CLS. 100, 101 AND 102).

NO CLAIM IS MADE TO THE EXCLUSIVE RIGHT TO USE "ANALYTICS", APART FROM THE MARK AS SHOWN.

FOR CONSULTATION IN THE FIELD OF MARKET STATISTICAL MODELING, ANALYSIS OF CUSTOMER DATA, PRODUCT AND SERVICE PRICING, PROMOTIONAL CAMPAIGNS, AND ECONOMIC DATA FOR CLASSIFICATION AND FORECASTING PURPOSES (U.S. CLS. 100, 101 AND 102).

FIRST USE 9-1-1999; IN COMMERCE 9-1-1999.

CLASS 35—(Continued).

SN 78-020,375. STAMPS.COM INC., SANTA MONICA, CA. FILED 8-9-2000.

ESSURANCE.BIZ

FOR ONLINE ELECTRONIC POSTAL SERVICES, NAMELY, PROVIDING DIGITALLY-GENERATED POSTAL BAR CODES AND POSTAL INDICIA, ONLINE ADDRESS CORRECTION, INTEGRATION OF ADDRESS DATA, PACKAGE TRACKING, DELIVERY CONFIRMATION AND RETURN RECEIPT SERVICES, AND SERVICES FOR ORDERING AND PROVIDING POSTAL-RELATED SUPPLIES; ONLINE SERVICES, NAMELY, ONLINE PROMOTION OF THE GOODS AND SERVICES OF OTHERS VIA ADVERTISEMENTS AND A WEBSITE WHERE USERS CAN LINK TO WEB SITES OF OTHERS IN THE FIELDS OF MAILING, SHIPPING, MARKETING, DIRECT MAILING, PRINTING, COMPUTER SERVICES, NETWORK SERVICES, OFFICE SUPPLIES, INSURANCE, SMALL-OFFICE AND HOME-OFFICE SOLUTIONS, AND OTHER BUSINESS-RELATED PRODUCTS AND SERVICES; ONLINE SERVICES, NAMELY, PROVIDING MERCHANTS, BUSINESSES, CONSUMERS AND ONLINE USERS WITH RETAIL PURCHASING INFORMATION PERTAINING TO ORDERING, MAILING, SHIPPING, RETURNING, RECEIPT LOGS, INVENTORYING AND TRACKING OF MERCHANDISE AND ORDERS (U.S. CLS. 100, 101 AND 102).

SN 78-021,747. BAZAARDECOR SARL, NEUCHATEL, SWITZERLAND, FILED 8-17-2000.

ECLECTIC ELEGANCE

FOR ONLINE RETAIL STORE SERVICES FEATURING PERSONAL GOODS SUCH AS JEWELRY, WRITING INSTRUMENTS AND PICTURE FRAMES; PERSONAL CARE ITEMS, NAMELY, FRAGRANCES, CANDLES, SOAPS AND LOTIONS; HOUSEHOLD GOODS AND FURNISHINGS, NAMELY, VASES, GLASSWARE, DINNERWARE, LAMPS, DRAPERIES, CLOCKS, BED AND TABLE COVERINGS, FLOOR COVERINGS, KITCHEN AND TABLEWARE AND VESSELS MADE OF POTTERY, ALL WITH AN EMPHASIS ON CRAFTSMANSHIP AND DESIGN BY INDIVIDUAL ARTISANS FROM AROUND THE WORLD VIA THE INTERNET (U.S. CLS. 100, 101 AND 102).

SN 78-022,247. ALL SPORTS DISTRIBUTING, SPOKANE, WA. FILED 8-22-2000.

THE OFFICIAL BAG OF BASKETBALL

NO CLAIM IS MADE TO THE EXCLUSIVE RIGHT TO USE "BAG" AND "BASKETBALL", APART FROM THE MARK AS SHOWN.

FOR PROMOTING THE GOODS OF OTHERS BY PREPARING AND PLACING ADVERTISEMENTS FOR SPORT-SPECIFIC ATHLETIC BAGS FOR BASKETBALL PLAYERS AND TEAMS TO BE USED IN ALL FORMS OF MEDIA, NAMELY, PACKAGING, PRINT PUBLICATIONS, POINT OF SALE MERCHANDISING, THE INTERNET, MARKETING MATERIALS, NAMELY BROCHURES AND CATALOGS (U.S. CLS. 100, 101 AND 102).

CLASS 35—(Continued).

SN 78-024,605. KRANSON INDUSTRIES, INC., ST. LOUIS, MO. FILED 9-6-2000.

RAPIDFIND

FOR ON-LINE DATABASE SERVICES, NAMELY, PROVIDING INFORMATION REGARDING PRODUCT AND PACKAGING MATERIALS FOR GLASS AND PLASTIC BOTTLES, CLOSURES AND DISPENSERS (U.S. CLS. 100, 101 AND 102).

FIRST USE 6-0-2000; IN COMMERCE 7-1-2000.

SN 78-024,860. INTERNATIONAL SAMPLE DATA INC., EAST GRAND RAPIDS, MI. FILED 9-7-2000.

SAMPLEACCESS

FOR PROMOTING THE GOODS AND SERVICES OF OTHERS THROUGH THE DISTRIBUTION OF RX/PHARMACY SAMPLES, OVER THE COUNTER MEDICINE SAMPLES, AND ASSOCIATED LITERATURE AND EDUCATIONAL MATERIALS FOR USE BY PRESCRIBING MEDICAL PROFESSIONALS (U.S. CLS. 100, 101 AND 102).

SN 78-025,184. COOK BROTHERS, INC., CHICAGO, IL. FILED 9-9-2000.

JODY'S COLLECTIONS

NO CLAIM IS MADE TO THE EXCLUSIVE RIGHT TO USE "COLLECTIONS", APART FROM THE MARK AS SHOWN.

FOR MAIL ORDER CATALOG, COMPUTERIZED ONLINE RETAIL SERVICES AND RETAIL STORE SERVICES FEATURING CLOTHING, SPORTING GOODS, PERFUME, GAMES, FIGURINES, HOBBY PRODUCTS, HARDWARE, JEWELRY, COOK WARE, CUTLERY, ELECTRONIC AND ELECTRICAL PRODUCTS, SMALL APPLIANCES AND GENERAL HOUSEHOLD AND DOMESTIC MERCHANDISE, NAMELY BED AND TABLE LINENS, TOWELS AND RUGS, KITCHEN UTENSILS, GLASS WARE, PLASTIC WARE, CHINA, TABLE WARE, FLATWARE AND STORAGE CONTAINERS, RACKS, CARTS, AND TRAYS (U.S. CLS. 100, 101 AND 102).

SN 78-025,728. KOULOUKAS, CHRIS, ALPHARETTA, GA. FILED 9-13-2000.

MAIL & MORE...

FOR FRANCHISING, NAMELY, OFFERING TECHNICAL ASSISTANCE IN THE ESTABLISHMENT AND/OR OPERATION OF - MAIL SORTING, HANDLING, AND RECEIVING BUSINESSES; OF DOCUMENT COPYING BUSINESSES, OF PRINTING BUSINESSES; AND, OF SIGN PAINTING BUSINESSES (U.S. CLS. 100, 101 AND 102).

CLASS 35—(Continued).

SN 78-026,599. INSYDE SOFTWARE, INC., WESTBOROUGH, MA. FILED 9-19-2000.

TURN ON MEDIA

NO CLAIM IS MADE TO THE EXCLUSIVE RIGHT TO USE "MEDIA", APART FROM THE MARK AS SHOWN, FOR ADVERTISING FOR OTHERS VIA AN ON-LINE ELECTRONIC COMMUNICATIONS NETWORK (U.S. CLS. 100, 101 AND 102).

CLASS 35—(Continued).

SN 78-032,667. EPOSSE INC., NUTLEY, NJ. FILED 10-27-2000.

THE SUPPLY CHAIN IS THE COMPANY

NO CLAIM IS MADE TO THE EXCLUSIVE RIGHT TO USE "SUPPLY CHAIN", APART FROM THE MARK AS SHOWN, FOR BUSINESS SUPPLY CHAIN CONSULTATION SERVICES (U.S. CLS. 100, 101 AND 102).

SN 78-026,974. CAMERA CLUB, INC., THE, BROOKLYN, NY. FILED 9-21-2000.

CAMERA CLUB

NO CLAIM IS MADE TO THE EXCLUSIVE RIGHT TO USE "CAMERA", APART FROM THE MARK AS SHOWN, FOR ONLINE RETAIL STORE SERVICES IN THE FIELDS OF AUDIO, VIDEO AND PHOTOGRAPHIC EQUIPMENT AND ACCESSORIES (U.S. CLS. 100, 101 AND 102).

FIRST USE 8-17-2000; IN COMMERCE 8-17-2000.

SN 78-033,733. MARTELL, STEVE, MILWAUKIE, OR. AND CULLEN, BRETT, MILWAUKIE, OR. FILED 11-3-2000.

EVERCLEAR WINDOWS AND DOORS

NO CLAIM IS MADE TO THE EXCLUSIVE RIGHT TO USE "WINDOWS AND DOORS", APART FROM THE MARK AS SHOWN,

FOR RETAIL STORE SERVICES FEATURING WINDOWS, DOORS, SKYLIGHTS, GARAGE DOORS, GARAGE DOOR OPENERS, GLASS PRODUCTS, NAMELY GLASS FOR USE IN WINDOWS AND DOORS AND GENERAL MILLWORK, NAMELY INTERIOR TRIM AND COLUMNS FOR WINDOWS AND DOORS (U.S. CLS. 100, 101 AND 102).

SN 78-031,540. LAHEY, LISA, LASKOW, LEXINGTON, MA. FILED 10-19-2000.

MINDS AT WORK

FOR BUSINESS CONSULTING SERVICES TO BUSINESSES AND SCHOOLS CONCERNING PROFESSIONAL AND LEADERSHIP DEVELOPMENT, ORGANIZATIONAL CONSULTING, AND EFFECTIVE COMMUNICATIONS STRATEGIES (U.S. CLS. 100, 101 AND 102).

FIRST USE 4-0-1989; IN COMMERCE 4-0-1989.

SN 78-034,398. MOORE NORTH AMERICA, INC., GRAND ISLAND, NY. FILED 11-8-2000.

MARKETING REINVENTED

NO CLAIM IS MADE TO THE EXCLUSIVE RIGHT TO USE "MARKETING", APART FROM THE MARK AS SHOWN,

FOR BUSINESS MARKETING CONSULTING SERVICES PROVIDED OVER A GLOBAL COMMUNICATIONS NETWORK (U.S. CLS. 100, 101 AND 102).

SN 78-031,936. COMPAQ INFORMATION TECHNOLOGIES GROUP, L.P., HOUSTON, TX. FILED 10-23-2000.

BEQUIPT

FOR ONLINE AND TELEPHONE RETAIL ORDERING SERVICES FEATURING OFFICE SUPPLIES, OFFICE EQUIPMENT, OFFICE FURNITURE, TELEPHONES, PAGERS, AND RELATED OFFICE PRODUCTS AND ACCESSORIES (U.S. CLS. 100, 101 AND 102).

FIRST USE 10-23-2000; IN COMMERCE 10-23-2000.

SN 78-036,350. KRAFT FOODS HOLDINGS, INC., NORTH-FIELD, IL. FILED 11-22-2000.

SPEEDCART

FOR COMPUTERIZED ON-LINE ORDER PROCESSING SERVICES OFFERED ON AN E-COMMERCE INTERNET SITE IN THE FIELD OF GIFTS (U.S. CLS. 100, 101 AND 102).

CLASS 35—(Continued).

SN 78-039,923. MCINTOSH, IAN, LAS VEGAS, NV. FILED 12-19-2000.



FOR RETAIL STORE AND ONLINE RETAILING IN THE FIELD OF EQUIPMENT FOR COMMERCIAL EXERCISE ROOMS AND SPAS (U.S. CLS. 100, 101 AND 102).

FIRST USE 7-1-1999; IN COMMERCE 7-1-1999.

SN 78-040,230. KASELNAK, MICHAEL, ROCHESTER, MN. FILED 12-21-2000.

PIECE OF PIE MARKETING

NO CLAIM IS MADE TO THE EXCLUSIVE RIGHT TO USE "MARKETING", APART FROM THE MARK AS SHOWN.

FOR FINANCIAL SERVICES MARKETING, NAMELY, BUSINESS MARKETING CONSULTING SERVICES (U.S. CLS. 100, 101 AND 102).

SN 78-042,869. FULLERTON CORPORATION, IRVINE, CA. FILED 1-12-2001.

THE INCREDIBLE HOME DECORATING SUPERSTORE

NO CLAIM IS MADE TO THE EXCLUSIVE RIGHT TO USE "HOME DECORATING SUPERSTORE", APART FROM THE MARK AS SHOWN.

FOR RETAIL STORE SERVICES FEATURING HOME AND GARDEN FURNISHINGS (U.S. CLS. 100, 101 AND 102).

FIRST USE 8-18-2000; IN COMMERCE 8-18-2000.

SN 78-043,559. STRATEGIC MARKETING RESOURCES, INC., MINNEAPOLIS, MN. FILED 1-17-2001.

SMRI

FOR BUSINESS CONSULTATION SERVICES, INCLUDING CONSULTATION IN THE FIELD OF BRAND NAME DEVELOPMENT, BUSINESS MARKETING CONSULTATION SERVICES AND MARKET RESEARCH (U.S. CLS. 100, 101 AND 102).

CLASS 35—(Continued).

SN 78-044,849. TRUSERV CORPORATION, CHICAGO, IL. FILED 1-25-2001.

TWELVE GIFTS OF CHRISTMAS

FOR RETAIL HARDWARE STORE SERVICES (U.S. CLS. 100, 101 AND 102).

FIRST USE 0-0-1996; IN COMMERCE 0-0-1996.

SN 78-047,550. BUSINESS DEVELOPMENT PARTNERS, LLC., METAIRIE, LA. FILED 2-9-2001.



BUSINESS
DEVELOPMENT
PARTNERS

NO CLAIM IS MADE TO THE EXCLUSIVE RIGHT TO USE "BUSINESS DEVELOPMENT PARTNERS", APART FROM THE MARK AS SHOWN.

THE MARK CONSISTS OF A GOLD PELICAN IN FLIGHT, WITH A MOON AND A REPRESENTATION OF THE NIGHT SKY IN BLACK.

FOR SMALL BUSINESS CONSULTATION (U.S. CLS. 100, 101 AND 102).

SN 78-047,903. PAYLESS SHOESOURCE WORLDWIDE, INC., TOPEKA, KS. FILED 2-12-2001.

LUSTER

FOR RETAIL CLOTHING AND ACCESSORIES STORES (U.S. CLS. 100, 101 AND 102).

SN 78-048,054. ROTHSTEIN-TAUBER, INCORPORATED, STAMFORD, CT. FILED 2-13-2001.

MINDCAST

FOR MARKET RESEARCH SERVICES, NAMELY, CONDUCTING FOCUS GROUP SESSIONS FOR SUBSCRIBER MEMBER BUSINESSES OVER THE INTERNET (U.S. CLS. 100, 101 AND 102).

CLASS 35—(Continued).

SN 78-048,319. PASS!TIME MARKETING, SAN JOSE, CA. FILED 2-14-2001.

**FLATCH U. LENTS THE
STEPONNA DUCK**

FOR ADVERTISING SERVICES, NAMELY ADVERTISING SLOGAN AND CARTOON CHARACTER LICENSING (U.S. CLS. 100, 101 AND 102).

SN 78-051,436. INTERACTIVE MEDIA, INC., SCOTTSDALE, AZ. FILED 3-5-2001.

PRIZE-MERCIAL

FOR ADVERTISING SERVICES, NAMELY, CREATING CORPORATE AND BRAND IDENTITY FOR OTHERS (U.S. CLS. 100, 101 AND 102).

SN 78-053,805. JOBDOMINATOR.COM, SAN DIEGO, CA. FILED 3-19-2001.

JOBDOMINATOR.COM

FOR PROVIDING A WEB SITE FEATURING JOB POSTINGS, RESUME POSTINGS AND CAREER INFORMATION (U.S. CLS. 100, 101 AND 102).

SN 78-057,204. SYNTHESIS PARTNERS LLC, RESTON, VA. FILED 4-6-2001.

OFF-AXIS INTELLIGENCE

NO CLAIM IS MADE TO THE EXCLUSIVE RIGHT TO USE "INTELLIGENCE", APART FROM THE MARK AS SHOWN.
FOR BUSINESS RESEARCH (U.S. CLS. 100, 101 AND 102).
FIRST USE 3-30-2000; IN COMMERCE 3-30-2000.

SN 78-057,678. PAIGE, RICHARD, HONOLULU, HI. FILED 4-10-2001.

TIMEVENTURES

FOR COMPUTERIZED ON-LINE RETAIL SERVICES FEATURING WATCHES, CLOCKS, AND TIMEPIECES (U.S. CLS. 100, 101 AND 102).

CLASS 35—(Continued).

SN 78-060,074. HEDY'S GIFTS, INC., STATEN ISLAND, NY. FILED 4-24-2001.



NO CLAIM IS MADE TO THE EXCLUSIVE RIGHT TO USE "GIFTS", APART FROM THE MARK AS SHOWN.

FOR RETAIL STORE SERVICES AND MAIL ORDER SERVICES FEATURING GIFT MERCHANDISE, NAMELY, CHINA, CRYSTAL, FIGURINES, CERAMICS, FLATWARE, DINNERWARE AND RELATED ACCESSORIES, SILVERWARE, DECORATIVE BOXES, WRITING INSTRUMENTS, PEN CASES, PENCIL CASES, PAPERWEIGHTS, GIFTWARE, NOVELTY ITEMS, COMMEMORATIVE ITEMS, MEMORABILIA, LETTER OPENERS, DESK SETS, DESK-TOP ORGANIZERS, DESK ACCESSORIES, COASTERS, WORKS OF ART, COLLECTIBLES, JEWELRY, WATCHES, LIMITED EDITIONS, DECORATIVE ACCESSORIES, FURNITURE AND PROMOTIONAL ITEMS (U.S. CLS. 100, 101 AND 102).
FIRST USE 5-1-1988; IN COMMERCE 5-1-1988.

SN 78-061,187. CHAPPELL SKIBOARDS, LLC, DBA GET-BOARDS.COM, ANAHEIM, CA. FILED 4-30-2001.



FOR RETAIL CATALOG AND ONLINE RETAIL STORE SERVICES FEATURING CLOTHING (U.S. CLS. 100, 101 AND 102).

SN 78-062,614. AG BRENTWOOD, IRVING, TX. FILED 5-8-2001.

BROWSE ON

FOR PROVIDING BUSINESS INFORMATION TO BUSINESSES AND CONSUMERS IN THE FIELD OF BUSINESS DEVELOPMENT; PROVIDING ADVERTISING SERVICES TO BUSINESSES AND CONSUMERS, NAMELY, PROVIDING ELECTRONIC BILLBOARD ADVERTISING, DISSEMINATION OF ADVERTISING FOR OTHERS VIA AN ON-LINE ELECTRONIC COMMUNICATIONS NETWORK (U.S. CLS. 100, 101 AND 102).
FIRST USE 5-1-1998; IN COMMERCE 5-1-1998.

CLASS 35—(Continued).

SN 78-067,910. SCULLY SPORTSWEAR, INC., OXNARD, CA. FILED 6-7-2001.

JAVA RANCH

NO CLAIM IS MADE TO THE EXCLUSIVE RIGHT TO USE "JAVA", APART FROM THE MARK AS SHOWN.
FOR RETAIL STORE SERVICES FEATURING COFFEE (U.S. CLS. 100, 101 AND 102).

SN 78-070,096. INTERPUBLIC GROUP OF COMPANIES, INC., THE, NEW YORK, NY. FILED 6-20-2001.

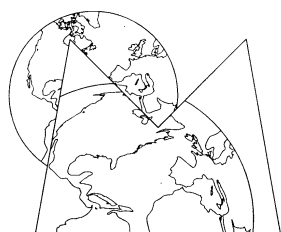

M A G N A
G L O B A L

NO CLAIM IS MADE TO THE EXCLUSIVE RIGHT TO USE "GLOBAL", APART FROM THE MARK AS SHOWN.
FOR ADVERTISING AGENCY SERVICES, NAMELY, ADVERTISING, MARKETING, MEDIA AND ART DESIGN (U.S. CLS. 100, 101 AND 102).

SN 78-070,138. AMERICAN MEDICAL SUPPLIES, INC., BOCA RATON, FL. FILED 6-20-2001.

AMERICAN MEDICAL SUPPLIES, INC.

NO CLAIM IS MADE TO THE EXCLUSIVE RIGHT TO USE "MEDICAL SUPPLIES, INC.", APART FROM THE MARK AS SHOWN.
SEC. 2(F).
FOR MAIL ORDER SERVICES FEATURING MEDICAL SUPPLIES, NAMELY DIABETIC STRIPS AND TESTING SUPPLIES (U.S. CLS. 100, 101 AND 102).
FIRST USE 9-20-1993; IN COMMERCE 9-20-1993.

SN 78-072,370. KT, LLC., ST. LOUIS PARK, MN. FILED 7-5-2001.

ELATIONS

FOR RETAIL STORE SERVICES IN THE NATURE OF GIFTS, COLLECTIBLES AND CLOTHING (U.S. CLS. 100, 101 AND 102).
FIRST USE 5-26-2001; IN COMMERCE 5-26-2001.

CLASS 35—(Continued).

SN 78-074,333. APA INTERNATIONAL PLACEMENT CONSULTANTS LLC, NEW YORK, NY. FILED 7-17-2001.

APA INTERNATIONAL PLACEMENT CONSULTANTS

NO CLAIM IS MADE TO THE EXCLUSIVE RIGHT TO USE "INTERNATIONAL PLACEMENT CONSULTANTS", APART FROM THE MARK AS SHOWN.
FOR EMPLOYMENT PLACEMENT SERVICES (U.S. CLS. 100, 101 AND 102).
FIRST USE 4-1-1987; IN COMMERCE 4-1-1987.

SN 78-074,636. INCWAY CORPORATION, SANTA CLARITA, CA. FILED 7-18-2001.

POOR DAD

FOR PROVIDING BUSINESS INFORMATION, CONSULTING AND PLANNING SERVICES RELATING TO CORPORATIONS, LIMITED LIABILITY COMPANIES AND RELATED BUSINESS DISCIPLINES (U.S. CLS. 100, 101 AND 102).
FIRST USE 9-27-2000; IN COMMERCE 9-27-2000.

SN 78-074,731. LONG, KENNETH J, RESTON, VA. FILED 7-19-2001.

GEOHUNT

FOR PROMOTING SPORTS COMPETITIONS AND/OR EVENTS OF OTHERS (U.S. CLS. 100, 101 AND 102).

SN 78-075,518. UNITED FACTORY FURNITURE CORPORATION, LAS VEGAS, NV. FILED 7-25-2001.

WALKERFURNITURE.COM

FOR COMPUTERIZED ON-LINE RETAIL SERVICES IN THE FIELD OF HOME FURNISHINGS; RETAIL STORE SERVICES IN THE FIELD OF HOME FURNISHINGS (U.S. CLS. 100, 101 AND 102).

SN 78-075,565. BENOW, INC., WAKEFIELD, MA. FILED 7-25-2001.

FASTTRACK

FOR MARKETING STUDIES UTILIZING A HOSTED COMPUTER DATABASE OF CUSTOMER INFORMATION (U.S. CLS. 100, 101 AND 102).

CLASS 35—(Continued).

SN 78-077,650. AUTOPOLL, INC., ANN ARBOR, MI. FILED 8-6-2001.

AUTOPOLL

FOR CONDUCTING BUSINESS AND MARKET RESEARCH SURVEYS VIA THE INTERNET; PROVIDING INFORMATION IN THE FIELD OF BUSINESS AND MARKET SURVEYS (U.S. CLS. 100, 101 AND 102).

SN 78-079,110. WARD, MICHAEL H., CINCINNATI, OH. FILED 8-14-2001.

CHIXLAX

FOR ON-LINE RETAIL STORE SERVICES FEATURING SPORTING GOODS, CLOTHING AND ACCESSORIES; AND PROMOTION OF SPORTS COMPETITIONS AND EVENTS OF OTHERS (U.S. CLS. 100, 101 AND 102).

SN 78-083,566. E BUSINESS TECHNOLOGIES, LLC, SPRINGFIELD, MO. FILED 9-12-2001.

SERIOUS ABOUT MARRIAGE

FOR ON-LINE RETAIL STORE SERVICES FEATURING BOOKS AND TAPES REGARDING MARRIAGE AND RELATIONSHIPS (U.S. CLS. 100, 101 AND 102).

SN 78-083,814. PERSIDEA, INC., AUSTIN, TX. FILED 9-13-2001.

MEETLOCKER

FOR BUSINESS MARKETING CONSULTING SERVICES (U.S. CLS. 100, 101 AND 102).

SN 78-084,679. RED THREE CONSULTING, INC., NEW YORK, NY. FILED 9-20-2001.

RED THREE THE NECESSARY EDGE

FOR CONSULTING SERVICES IN THE FIELDS OF BUSINESS TECHNOLOGY, BUSINESS PROCESSES AND PRACTICES, AND PERSONNEL MANAGEMENT, ORGANIZATION AND DEVELOPMENT (U.S. CLS. 100, 101 AND 102).

CLASS 36—INSURANCE AND FINANCIAL

CLASS 36—(Continued).

SN 75-294,391. CHARTER ONE FINANCIAL, INC., CLEVELAND, OH. FILED 5-19-1997.

NOW BANKING

NO CLAIM IS MADE TO THE EXCLUSIVE RIGHT TO USE "BANKING", APART FROM THE MARK AS SHOWN. FOR BANKING SERVICES, NAMELY PROVIDING ACCESS TO BANKING SERVICES BY MEANS OF A TELEPHONE OR AN ON-LINE COMPUTER INFORMATION NETWORK (U.S. CLS. 100, 101 AND 102).

SN 75-479,497. SCHEMETRUST INSURANCE SERVICES LIMITED, LONDON SW12 8JS, ENGLAND, FILED 5-5-1998.

SPORTSBANK

PRIORITY CLAIMED UNDER SEC. 44(D) ON ERPN CMNTY TM OFC APPLICATION NO. 799437, FILED 10-16-2000, REG. NO. 799437, DATED 10-16-2000, EXPIRES 10-16-2010.

FOR BANKING AND FINANCIAL SERVICES; CREDIT CARD, CHARGE CARD, CASH AND DEBIT CARD SERVICES, ADVISORY, CONSULTANCY, RESEARCH AND INFORMATION SERVICES RELATING TO THE AFORESAID (U.S. CLS. 100, 101 AND 102).

SN 75-529,876. AMERICA'S NOTE NETWORK, INC., BOULDER, CO. FILED 7-30-1998.

AMERICA'S NOTE NETWORK

SEC. 2(F). FOR PROVIDING A DATA BASE CONTAINING REAL ESTATE MORTGAGE NOTES AND OTHER FINANCIAL LOANS OVER A GLOBAL COMPUTER NETWORK (U.S. CLS. 100, 101 AND 102).

FIRST USE 1-17-1995; IN COMMERCE 1-17-1995.

SN 75-613,121. CALVERT GROUP, LTD., BETHESDA, MD. FILED 12-29-1998.

CALVERT SOCIAL INVESTMENT FUND

OWNER OF U.S. REG. NOS. 1,261,134, 2,047,531 AND OTHERS.

NO CLAIM IS MADE TO THE EXCLUSIVE RIGHT TO USE "SOCIAL INVESTMENT FUND", APART FROM THE MARK AS SHOWN.

SEC. 2(F) AS TO "CALVERT". FOR FINANCIAL INVESTMENT MANAGEMENT SERVICES (U.S. CLS. 100, 101 AND 102).

FIRST USE 10-24-1982; IN COMMERCE 10-24-1982.

CLASS 36—(Continued).

SN 75-616,418. NORWEST MORTGAGE, INC., DES MOINES, IA. FILED 1-6-1999.

PERSONALIZED SOLUTIONS

NO CLAIM IS MADE TO THE EXCLUSIVE RIGHT TO USE "PERSONALIZED", APART FROM THE MARK AS SHOWN.

FOR MORTGAGE LENDING SERVICES (U.S. CLS. 100, 101 AND 102).

SN 75-620,495. TCF FINANCIAL CORPORATION, MINNEAPOLIS, MN. FILED 1-13-1999.

TCF NATIONAL BANK ILLINOIS THE 7-DAY BANK

OWNER OF U.S. REG. NO. 2,042,642.
NO CLAIM IS MADE TO THE EXCLUSIVE RIGHT TO USE "NATIONAL BANK ILLINOIS", APART FROM THE MARK AS SHOWN.

FOR BANKING SERVICES (U.S. CLS. 100, 101 AND 102).

FIRST USE 12-30-1999; IN COMMERCE 12-30-1999.

SN 75-643,550. SOUTH JERSEY FEDERAL CREDIT UNION, DEPTFORD, NJ. FILED 2-18-1999.

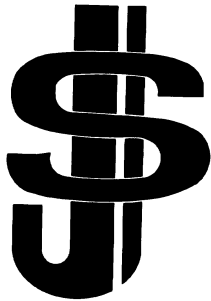

FOR CREDIT UNION FINANCIAL SERVICES (U.S. CLS. 100, 101 AND 102).

FIRST USE 3-15-1979; IN COMMERCE 6-15-1979.

SN 75-645,670. FINANCIAL CONTINUUM, LLC., PAPILLION, NE. FILED 2-22-1999.

QUANTUM ALLIANCE

FOR FINANCIAL SERVICES, NAMELY INVESTMENT, LIFE AND HEALTH INSURANCE UNDERWRITING, INSURANCE BROKERAGE, LIFE AND HEALTH INSURANCE CLAIMS ADMINISTRATION AND INVESTMENT BROKERAGE SERVICES (U.S. CLS. 100, 101 AND 102).

CLASS 36—(Continued).

SN 75-660,996. MELLON BANK, N.A., PITTSBURGH, PA. FILED 3-15-1999.

BUSINESS BUILDER

NO CLAIM IS MADE TO THE EXCLUSIVE RIGHT TO USE "BUSINESS", APART FROM THE MARK AS SHOWN, FOR BANKING SERVICES (U.S. CLS. 100, 101 AND 102).

FIRST USE 9-1-1994; IN COMMERCE 9-1-1994.

SN 75-661,247. SSB INVESTMENTS, INC., NEW YORK, NY. FILED 3-16-1999.

RISKTODAY

OWNER OF U.S. REG. NO. 2,158,035.
FOR PROVIDING A WEB SITE FEATURING CUSTOMIZED REPORTS OF FINANCIAL RISK ANALYSIS AND PROVIDING AN ON-LINE COMPUTER DATABASE VIA A GLOBAL COMPUTER NETWORK IN THE FIELD OF FINANCIAL RISK ANALYSIS (U.S. CLS. 100, 101 AND 102).

FIRST USE 8-1-1998; IN COMMERCE 8-1-1998.

SN 75-663,734. REGIONAL SOURCE PRODUCE, INC., SALINAS, CA. FILED 3-19-1999.

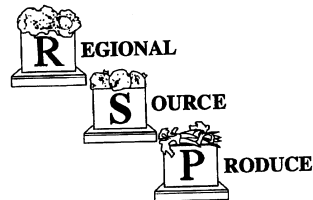

NO CLAIM IS MADE TO THE EXCLUSIVE RIGHT TO USE "REGIONAL SOURCE PRODUCE", APART FROM THE MARK AS SHOWN.

FOR PRODUCE BROKERAGE SERVICES (U.S. CLS. 100, 101 AND 102).

FIRST USE 11-15-1995; IN COMMERCE 11-15-1995.

CLASS 36—(Continued).

SN 75-722,891. PINNACLE GLOBAL GROUP, INC., HOUSTON, TX. FILED 6-7-1999.



FOR FINANCIAL SERVICES, NAMELY, FINANCIAL MANAGEMENT, VIA THE GLOBAL COMMUNICATIONS NETWORK (U.S. CLS. 100, 101 AND 102).
FIRST USE 11-1-1994; IN COMMERCE 9-5-1995.

SN 75-728,515. INTERACTIVE COMMUNICATION SYSTEMS, INC., COLORADO SPRINGS, CO. FILED 6-15-1999.

BUDGETALK

FOR TELEPHONE CALLING CARD SERVICES (U.S. CLS. 100, 101 AND 102).

SN 75-738,040. CAT INTERNET SERVICES, INC., MORRISVILLE, PA. BY ASSIGNMENT THEINTERNETCOMPANY, INC., PRINCETON JUNCTION, NJ. FILED 6-28-1999.

NAVIGATOR.COM

FOR COMPUTER SERVICES, NAMELY, PROVIDING ON-LINE INFORMATION TO HELP CONSUMERS ACCESS AND UNDERSTAND THEIR CREDIT REPORTS VIA A GLOBAL COMPUTER NETWORK (U.S. CLS. 100, 101 AND 102).
FIRST USE 3-17-1994; IN COMMERCE 3-17-1994.

SN 75-738,376. ACCELERATED BENEFITS CORPORATION, ORLANDO, FL. FILED 6-28-1999.

ABC

FOR VIATICAL SETTLEMENT SERVICES AND VIATICAL SETTLEMENT BROKERAGE SERVICES (U.S. CLS. 100, 101 AND 102).
FIRST USE 10-25-1995; IN COMMERCE 10-25-1995.

CLASS 36—(Continued).

SN 75-738,377. ACCELERATED BENEFITS CORPORATION, ORLANDO, FL. FILED 6-28-1999.

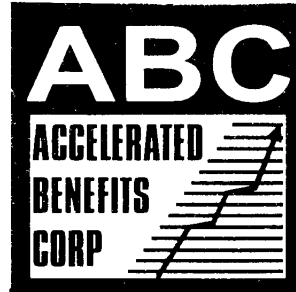

NO CLAIM IS MADE TO THE EXCLUSIVE RIGHT TO USE "ACCELERATED BENEFITS CORP", APART FROM THE MARK AS SHOWN.
THE LINING SHOWN IN THE DRAWING IS A FEATURE OF THE MARK AND IS NOT INTENDED TO INDICATE COLOR.

FOR VIATICAL SETTLEMENT SERVICES AND VIATICAL SETTLEMENT BROKERAGE SERVICES (U.S. CLS. 100, 101 AND 102).
FIRST USE 10-25-1995; IN COMMERCE 10-25-1995.

SN 75-755,604. CARLA BONTEN RENTALS, INC., BONITA SPRINGS, FL. FILED 7-20-1999.

The American Riviera

FOR LEASING OF VACATION PROPERTIES AND REAL ESTATE AGENCY (U.S. CLS. 100, 101 AND 102).
FIRST USE 3-1-1999; IN COMMERCE 3-1-1999.

SN 75-772,032. LINGLE FINANCIAL HOLDINGS INC., TORONTO, ONTARIO, CANADA, FILED 8-10-1999.



PRIORITY CLAIMED UNDER SEC. 44(D) ON CANADA APPLICATION NO. 1,014,267, FILED 5-5-1999, REG. NO. 540638, DATED 2-1-2001, EXPIRES 2-1-2016.

THE MARK CONSISTS OF A FANCIFUL REPRESENTATION OF THE CADUCEUS SYMBOL.
FOR INSURANCE SERVICES, NAMELY, INSURANCE BROKERAGE SERVICES, CLAIMS ADMINISTRATION AND PROCESSING SERVICES, AND UNDERWRITING HEALTH, LIFE, CASUALTY AND SPECIAL RISK INSURANCE (U.S. CLS. 100, 101 AND 102).

CLASS 36—(Continued).

SN 75-806,903. NEUBERGER BERMAN MANAGEMENT INC., NEW YORK, NY. FILED 9-23-1999.

NEUBERGER BERMAN CENTURY TRUST

OWNER OF U.S. REG. NOS. 1,939,545 AND 1,943,757.
NO CLAIM IS MADE TO THE EXCLUSIVE RIGHT TO USE "TRUST", APART FROM THE MARK AS SHOWN.
FOR INVESTMENT ADVISORY AND MUTUAL FUND SERVICES, NAMELY, SPONSORING MUTUAL FUNDS, PROVIDING ADMINISTRATION AND SHAREHOLDER SERVICES TO MUTUAL FUNDS, DISTRIBUTING MUTUAL FUND SHARES AND MANAGING FUNDS AND BONDS AND OTHER INVESTMENTS FOR INSTITUTIONS AND THE GENERAL PUBLIC (U.S. CLS. 100, 101 AND 102).

SN 75-806,906. NEUBERGER BERMAN MANAGEMENT INC., NEW YORK, NY. FILED 9-23-1999.

NEUBERGER BERMAN CENTURY FUND

OWNER OF U.S. REG. NOS. 1,939,545 AND 1,943,757.
NO CLAIM IS MADE TO THE EXCLUSIVE RIGHT TO USE "FUND", APART FROM THE MARK AS SHOWN.
FOR INVESTMENT ADVISORY AND MUTUAL FUND SERVICES, NAMELY, SPONSORING MUTUAL FUNDS, PROVIDING ADMINISTRATION AND SHAREHOLDER SERVICES TO MUTUAL FUNDS, DISTRIBUTING MUTUAL FUND SHARES AND MANAGING FUNDS AND BONDS AND OTHER INVESTMENTS FOR INSTITUTIONS AND THE GENERAL PUBLIC (U.S. CLS. 100, 101 AND 102).

SN 75-818,606. W.R. HAMBRECHT + CO., LLC., SAN FRANCISCO, CA. FILED 10-8-1999.

OPENBOOK

FOR INVESTMENT, BROKERAGE, OFFERING AND UNDERWRITING OF EQUITY SECURITIES FOR OTHERS VIA A GLOBAL COMPUTER NETWORK (U.S. CLS. 100, 101 AND 102).

SN 75-818,908. REALTY EXECUTIVES INTERNATIONAL, INC., PHOENIX, AZ. FILED 10-8-1999.



NO CLAIM IS MADE TO THE EXCLUSIVE RIGHT TO USE "SOLD", APART FROM THE MARK AS SHOWN.
FOR REAL ESTATE AFFAIRS, NAMELY, REAL ESTATE LISTING AND REAL ESTATE BROKERAGE SERVICES (U.S. CLS. 100, 101 AND 102).
FIRST USE 11-1-1998; IN COMMERCE 11-1-1998.

CLASS 36—(Continued).

SN 75-825,550. REBELINVESTOR.COM, EAST BERLIN, CT. FILED 11-9-1999.

REBELINVESTOR.COM

FOR ONLINE INVESTMENT INFORMATION SERVICES, NAMELY, PROVIDING FINANCIAL INDEXES AND DATABASES, AND WEBSITE LINKS TO OTHER CONTENT PROVIDERS IN THE FIELD OF INVESTMENT INFORMATION (U.S. CLS. 100, 101 AND 102).

SN 75-835,616. MERRILL LYNCH & CO., INC., NEW YORK, NY. FILED 10-29-1999.

MERRILL LYNCH RETIREMENT PREMIER

OWNER OF U.S. REG. NOS. 1,272,653, 2,177,813 AND OTHERS.

NO CLAIM IS MADE TO THE EXCLUSIVE RIGHT TO USE "RETIREMENT", APART FROM THE MARK AS SHOWN.

THE APPLICANT ON THE MARK DOES NOT REPRESENT A LIVING INDIVIDUAL.

FOR FINANCIAL INVESTMENT SERVICES, NAMELY, ANNUITY UNDERWRITING (U.S. CLS. 100, 101 AND 102).

SN 75-850,766. BLOOMBERG L.P., NEW YORK, NY. FILED 11-16-1999.

B - TRADE

FOR FINANCIAL SERVICES, NAMELY, PROVIDING A SECURITIES TRADING SYSTEM (U.S. CLS. 100, 101 AND 102).

FIRST USE 12-0-1996; IN COMMERCE 12-0-1996.

SN 75-856,259. BANCO BILBAO VIZCAYA ARGENTARIA, S.A., 48005 BILBAO, SPAIN, BY MERGER, BY CHANGE OF NAME BANCO BILBAO VIZCAYA, S.A., BILBAO, SPAIN, FILED 11-23-1999.

LATINBANK

PRIORITY CLAIMED UNDER SEC. 44(D) ON SPAIN APPLICATION NO. 2.268.421., FILED 11-5-1999, REG. NO. 2268421-2, DATED 3-20-2000, EXPIRES 3-20-2010.

FOR INSURANCE BROKERAGE SERVICES AND CONSULTATION; MONETARY EXCHANGE; FINANCIAL ANALYSIS AND CONSULTATION; FINANCIAL PLANNING AND PORTFOLIO MANAGEMENT; AND REAL ESTATE CONSULTATION (U.S. CLS. 100, 101 AND 102).

CLASS 36—(Continued).

SN 75-856,407. BANCO BILBAO VIZCAYA ARGENTARIA, S.A., 48005 BILBAO, SPAIN, BY MERGER, BY CHANGE OF NAME BANCO BILBAO VIZCAYA, S.A., 48005 BILBAO, SPAIN, FILED 11-23-1999.

BBVA

PRIORITY CLAIMED UNDER SEC. 44(D) ON SPAIN APPLICATION NO. 2,264,653, FILED 10-19-1999, REG. NO. 2264653-1, DATED 5-22-2000, EXPIRES 5-22-2010.

FOR INSURANCE BROKERAGE SERVICES AND CONSULTATION; MONETARY EXCHANGE; FINANCIAL ANALYSIS AND CONSULTATION; FINANCIAL PLANNING AND PORTFOLIO MANAGEMENT; AND REAL ESTATE CONSULTATION (U.S. CLS. 100, 101 AND 102).

SN 75-864,113. UNIFIED FINANCIAL SERVICES, INC., INDIANAPOLIS, IN. FILED 12-3-1999.

UNIFIED FINANCIAL SERVICES

OWNER OF U.S. REG. NO. 1,690,500.
NO CLAIM IS MADE TO THE EXCLUSIVE RIGHT TO USE "FINANCIAL SERVICES", APART FROM THE MARK AS SHOWN.

FOR FINANCIAL SERVICES, NAMELY, SECURITY BROKERAGE SERVICES, MUTUAL FUND INVESTMENT SERVICES, MUTUAL FUND ADMINISTRATION SERVICES, ESTATE MANAGEMENT SERVICES, RETIREMENT PLAN MANAGEMENT SERVICES, BANKING AND TRUST SERVICES, AND INVESTMENT ADVISORY SERVICES (U.S. CLS. 100, 101 AND 102).
FIRST USE 1-23-1998; IN COMMERCE 1-23-1998.

SN 75-870,184. ERS IMAGING SUPPLIES, INC., ERIE, PA. FILED 12-22-1999.



FOR CHARITABLE FUND RAISING INFORMATION FOR SCHOOLS AND OTHER CHARITABLE ORGANIZATIONS BY MEANS OF A GLOBAL COMPUTER NETWORK (U.S. CLS. 100, 101 AND 102).
FIRST USE 2-16-2000; IN COMMERCE 2-16-2000.

SN 75-870,196. ERS IMAGING SUPPLIES, INC., ERIE, PA. FILED 12-22-1999.

FUNDINGFACTORY

FOR PROVIDING CHARITABLE FUND RAISING INFORMATION FOR SCHOOLS AND OTHER CHARITABLE ORGANIZATIONS BY MEANS OF A GLOBAL COMPUTER NETWORK (U.S. CLS. 100, 101 AND 102).
FIRST USE 2-16-2000; IN COMMERCE 2-16-2000.

CLASS 36—(Continued).

SN 75-884,487. HYUNDAI MOTOR FINANCE COMPANY, FOUNTAIN VALLEY, CA. FILED 1-3-2000.

HYUNDAI

THE ENGLISH TRANSLATION OF "HYUNDAI" IS "PRESENT AGE" OR "MODERN".

FOR WHOLESALE LOAN FINANCING OF VEHICLE INVENTORIES, AND OTHER COMMERCIAL LOAN FINANCING FOR MOTOR VEHICLE DEALERS AND RETAIL PURCHASE AND LEASE FINANCING SERVICES IN THE FIELD OF MOTOR VEHICLES (U.S. CLS. 100, 101 AND 102).

FIRST USE 9-16-1989; IN COMMERCE 9-16-1989.

SN 75-892,658. CENTERSTONE INSURANCE AND FINANCIAL SERVICES, INC., DBA BENEFITMALL.COM, DALLAS, TX. FILED 1-7-2000.



FOR BROKERAGE IN THE FIELD OF HEALTH, LIFE AND DISABILITY INSURANCE; INSURANCE AGENCIES IN THE FIELD OF HEALTH, LIFE AND DISABILITY INSURANCE, UNDERWRITING SERVICES IN THE FIELD OF HEALTH, LIFE AND DISABILITY INSURANCE; ANNUITY UNDERWRITING; ADMINISTRATION OF EMPLOYEE BENEFIT PLANS VIA THE INTERNET; PROVIDING AND ONLINE COMPUTER DATABASE TO INSURANCE BROKERS, EMPLOYER AND EMPLOYEES IN THE FIELD OF PROGRAMS, BENEFITS, PRODUCTS AND SERVICES OF VARIOUS FULL SERVICE INSURANCE GENERAL AGENCIES AND INSURANCE BROKERAGE SERVICES (U.S. CLS. 100, 101 AND 102).

FIRST USE 7-15-1999; IN COMMERCE 7-15-1999.

SN 75-896,618. STAR PAYMENT SYSTEMS, INC., MAITLAND, FL. FILED 1-14-2000.

STAR SYSTEMS SECURITIES

NO CLAIM IS MADE TO THE EXCLUSIVE RIGHT TO USE "SYSTEMS SECURITIES", APART FROM THE MARK AS SHOWN.

FOR FINANCIAL PLANNING AND BROKERAGE IN THE FIELDS OF PUBLICLY TRADED EQUITIES AND INDEX OPTIONS, MUTUAL FUNDS, INSURANCE, CREDIT LINES, LOANS AND MORTGAGES; FINANCIAL PLANNING AND BROKERAGE IN THE FIELDS OF PUBLICLY TRADED EQUITIES AND INDEX OPTIONS, MUTUAL FUNDS, INSURANCE, CREDIT LINES, LOANS AND MORTGAGES ALL PROVIDED VIA GLOBAL COMPUTER NETWORK (U.S. CLS. 100, 101 AND 102).

CLASS 36—(Continued).

SN 75-903,519. MASSACHUSETTS MUTUAL LIFE INSURANCE COMPANY, SPRINGFIELD, MA. FILED 1-26-2000.



OWNER OF U.S. REG. NOS. 939,170, 2,356,296 AND OTHERS.

NO CLAIM IS MADE TO THE EXCLUSIVE RIGHT TO USE "FINANCIAL GROUP" OR "THE BLUE CHIP COMPANIES", APART FROM THE MARK AS SHOWN.

THE COLOR GRAY IS CLAIMED AS A FEATURE OF THE MARK. THE DRAWING IS LINED TO INDICATE THE COLOR GRAY.

ALL WORDS ARE IN WHITE LETTERS, AS IS THE HORIZONTAL LINE BELOW "FINANCIAL GROUP".

FOR INSURANCE AND FINANCIAL SERVICES, NAMELY, ACTUARIAL SERVICES, INSURANCE ADMINISTRATION, FINANCIAL ANALYSIS AND CONSULTATION, ASSET MANAGEMENT, ANNUITY UNDERWRITING, BANKING, COMMERCIAL LENDING, NAMELY, COMMERCIAL MORTGAGES, PRIVATELY PLACED DEBT SECURITIES AND BANK LOANS, INSURANCE AND SECURITIES BROKERAGE, BROKER-DEALER SERVICES, NAMELY, PURCHASE AND SALE OF SECURITIES PRODUCTS, NAMELY, STOCKS, BONDS, MUTUAL FUNDS AND UNIT INVESTMENT TRUSTS, CREDIT CARD SERVICES, MUTUAL FUND DISTRIBUTION SERVICES, ADMINISTRATION OF EMPLOYEE BENEFIT PLANS, FIDUCIARY REPRESENTATIVE SERVICES, ELECTRONIC FUNDS TRANSFERS, INVESTMENT ADVICE, INVESTMENT MANAGEMENT, MONEY MANAGEMENT, MUTUAL FUND SERVICES, ADMINISTRATION OF EMPLOYEE PENSION PLANS, POOLED INVESTMENT FUND MANAGEMENT, UNDERWRITING REINSURANCE, RETIREMENT INVESTMENT MANAGEMENT, ESTATE TRUST SERVICES, SECURITIES UNDERWRITING AND SECURITIES BROKERAGE (U.S. CLS. 100, 101 AND 102).

SN 75-956,038. CONTINENTAL REAL ESTATE GROUP, INC., HACKENSACK, NJ. FILED 3-13-2000.

CONTINENTAL REAL ESTATE

NO CLAIM IS MADE TO THE EXCLUSIVE RIGHT TO USE "REAL ESTATE", APART FROM THE MARK AS SHOWN.

FOR REAL ESTATE LISTING, ADVERTISING AGENCIES, REAL ESTATE BROKERAGE SERVICES (U.S. CLS. 100, 101 AND 102).

FIRST USE 1-12-1995. THE MARK WAS USED ANYWHERE IN A DIFFERENT FORM OTHER THAN THAT SOUGHT TO BE REGISTERED ON 01/12/1995; IN COMMERCE 1-12-1995. THE MARK WAS USED ANYWHERE IN A DIFFERENT FORM OTHER THAN THAT SOUGHT TO BE REGISTERED IN COMMERCE ON 01/12/1995.

CLASS 36—(Continued).

SN 76-008,862. LEHMAN BROTHERS INC., NEW YORK, NY. FILED 3-24-2000.

TAX BAN

NO CLAIM IS MADE TO THE EXCLUSIVE RIGHT TO USE "TAX", APART FROM THE MARK AS SHOWN.

FOR FUNDS INVESTMENT AND INVESTMENT ADVICE (U.S. CLS. 100, 101 AND 102).

FIRST USE 2-14-2000; IN COMMERCE 2-14-2000.

SN 76-019,581. AUTOMATIC DATA PROCESSING, INC., ROSELAND, NJ. FILED 4-6-2000.

MYKPLAN

FOR PROVIDING ONLINE INFORMATION IN THE FIELD OF MUTUAL FUND INVESTMENTS BY MEANS OF A GLOBAL COMPUTER NETWORK; INVESTMENT MANAGEMENT, INVESTMENT BROKERAGE, AND LOAN SERVICES, NAMELY, MAKING SHORT-TERM LOANS OF FUNDS ON DEPOSIT, ALL PROVIDED BY MEANS OF A GLOBAL COMPUTER NETWORK (U.S. CLS. 100, 101 AND 102).

SN 76-020,080. AMERICARES FOUNDATION, INC., NEW CANAAN, CT. FILED 4-6-2000.

AMERICARES FOUNDATION

OWNER OF U.S. REG. NOS. 2,310,959, 2,331,260 AND OTHERS.

NO CLAIM IS MADE TO THE EXCLUSIVE RIGHT TO USE "FOUNDATION", APART FROM THE MARK AS SHOWN.

FOR CHARITABLE FUND RAISING SERVICES TO SUPPORT THE DISTRIBUTION OF FOOD, CLOTHING, MEDICINE AND MEDICAL SERVICES (U.S. CLS. 100, 101 AND 102).

SN 76-025,482. AMERICAN MANAGEMENT SYSTEMS, INCORPORATED, FAIRFAX, VA. FILED 4-14-2000.

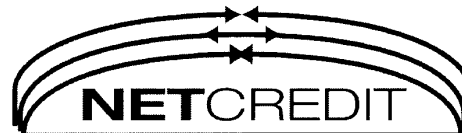

FOR CREDIT SERVICES, NAMELY PROVIDING AN ONLINE BROKERAGE NETWORK FOR CUSTOMERS, LENDERS AND FINANCIAL SERVICES PROVIDERS TO FACILITATE CONSUMER AND MORTGAGE LENDING VIA A GLOBAL COMPUTER NETWORK (U.S. CLS. 100, 101 AND 102).

FIRST USE 11-21-1999; IN COMMERCE 11-21-1999.

CLASS 36—(Continued).

SN 76-025,839. PERSONAL INJURY CAPITAL CORP., NEW YORK, NY. FILED 4-13-2000.



NO CLAIM IS MADE TO THE EXCLUSIVE RIGHT TO USE "PERSONAL INJURY CAPITAL CORP", APART FROM THE MARK AS SHOWN.
FOR FINANCIAL SERVICES, NAMELY, PROVIDING FUNDS FOR PENDING LAWSUITS OR CLAIMS AND FOR LITIGATION SETTLEMENTS (U.S. CLS. 100, 101 AND 102).
FIRST USE 10-15-1999; IN COMMERCE 10-15-1999.

SN 76-027,307. CREDIT SUISSE FIRST BOSTON ELECTRONIC BROKER, LLC, NEW YORK, NY. FILED 4-17-2000.

XELECT

FOR FINANCIAL SERVICES; NAMELY, INVESTMENT ADVISORY SERVICES; INVESTMENT MANAGEMENT SERVICES; ASSET MANAGEMENT SERVICES; AUTOMATED SECURITIES BROKERAGE SERVICES; AND DISSEMINATING AND COLLECTING A WIDE RANGE OF INFORMATION IN THE FIELDS OF SECURITIES, FINANCE, FINANCIAL INSTRUMENTS AND INVESTMENTS (U.S. CLS. 100, 101 AND 102).

SN 76-030,623. VIASTAR SERVICES CORPORATION, DALLAS, TX. FILED 4-20-2000.

VIASTAR GOLD

OWNER OF U.S. REG. NO. 2,251,870.
FOR PROVIDING BILL PAYMENT SERVICES AND CHECK PROCESSING SERVICES TO THE TRUCKING AND VEHICLE LEASING AND FINANCIAL INDUSTRIES (U.S. CLS. 100, 101 AND 102).

SN 76-032,310. MIDLAND LOAN SERVICES, INC., KANSAS CITY, MO. FILED 4-24-2000.

CMBS INVESTOR INSIGHT

NO CLAIM IS MADE TO THE EXCLUSIVE RIGHT TO USE "CMBS INVESTOR", APART FROM THE MARK AS SHOWN.
FOR PROVIDING INFORMATION IN THE FIELD OF COMMERCIAL MORTGAGE-BACKED SECURITY TRANSACTIONS VIA A GLOBAL COMPUTER INFORMATION NETWORK AND OTHER COMPUTER NETWORKS (U.S. CLS. 100, 101 AND 102).
FIRST USE 2-17-2000; IN COMMERCE 2-17-2000.

CLASS 36—(Continued).

SN 76-038,775. SIGUE CORPORATION, SAN FERNANDO, CA. FILED 5-2-2000.

SIGUE

THE ENGLISH TRANSLATION OF "SIGUE" IS "TO FOLLOW".
FOR FINANCIAL SERVICES, NAMELY, SERVICES OF ELECTRONIC TRANSFER OF FUNDS TO DOMESTIC AND INTERNATIONAL RECIPIENTS; FOREIGN MONEY EXCHANGE SERVICES (U.S. CLS. 100, 101 AND 102).

SN 76-046,844. SCORELAB, INC., SCOTTSDALE, AZ. FILED 5-12-2000.

PUTTING THE MARKET UNDER THE MICROSCOPE

FOR COMPUTER SERVICES, NAMELY, PROVIDING INFORMATION IN THE FIELD OF FINANCE, IN PARTICULAR, PROVIDING INFORMATION REGARDING ANALYSIS AND RANKINGS OF VARIOUS CORPORATE STOCK TRANSACTIONS; AND PROVIDING NEWS AND AN ONLINE DATABASE IN THE FIELD OF FINANCE (U.S. CLS. 100, 101 AND 102).

SN 76-047,320. MINNESOTA ZOO FOUNDATION, APPLE VALLEY, MN. FILED 5-12-2000.

CORNUCOPIA SOCIETY

NO CLAIM IS MADE TO THE EXCLUSIVE RIGHT TO USE "SOCIETY", APART FROM THE MARK AS SHOWN.
FOR CHARITABLE FUND RAISING SERVICES FOR ZOOLOGICAL FARM EXHIBITS VIA OFFER OF CHARITABLE DINNERS AND RECOGNITION MEMORABILIA SUCH AS PINS AND TIE TACKS (U.S. CLS. 100, 101 AND 102).

SN 76-048,751. SAFECO INSURANCE COMPANY OF AMERICA, SEATTLE, WA. FILED 5-15-2000.

YOUR BRIDGE TO THE FUTURE

FOR INSURANCE UNDERWRITING SERVICES IN THE FIELDS OF PROPERTY, CASUALTY, LIABILITY, LIABILITY-AUTO, WORKERS COMPENSATION, CONTRACTUAL LIABILITY, FIDELITY AND SURETY, TITLE, CREDIT, ACCIDENT AND HEALTH, LIFE, DISABILITY, ANNUITIES, AND REINSURANCE; INSURANCE UNDERWRITING IN THE FIELDS OF PROPERTY, CASUALTY, LIABILITY, LIABILITY-AUTO, WORKERS COMPENSATION, CONTRACTUAL LIABILITY, FIDELITY AND SURETY, TITLE, CREDIT, ACCIDENT AND HEALTH, LIFE, DISABILITY, ANNUITIES, AND REINSURANCE BY MEANS OF A GLOBAL COMPUTER NETWORK OR TELEPHONE; PROVIDING INFORMATION IN THE FIELD OF INSURANCE BY MEANS OF A GLOBAL COMPUTER NETWORK OR TELEPHONE (U.S. CLS. 100, 101 AND 102).

CLASS 36—(Continued).

SN 76-055,864. ARENA CAPITAL PARTNERS, LLC, NEW YORK, NY. FILED 5-24-2000.

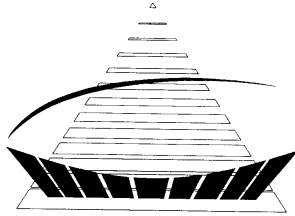

FOR MANAGEMENT OF, AND PROVISION OF INVESTMENT ADVICE AND ANALYSIS TO, A PRIVATE INVESTMENT FUND ENGAGED PRIMARILY IN INVESTING IN EQUITY INVESTMENTS OF PRIVATELY HELD COMPANIES (U.S. CLS. 100, 101 AND 102).

SN 76-056,432. DESFAIRE, INC., MINNEAPOLIS, MN. FILED 5-25-2000.

RENT READY

NO CLAIM IS MADE TO THE EXCLUSIVE RIGHT TO USE "RENT", APART FROM THE MARK AS SHOWN.
FOR RENTER CREDIT STATUS VERIFICATION (U.S. CLS. 100, 101 AND 102).

SN 76-057,858. CHOICE PRODUCTS USA, LLC, EAU CLAIRE, WI. FILED 5-26-2000.

DAIRYLAND FUNDRAISING

NO CLAIM IS MADE TO THE EXCLUSIVE RIGHT TO USE "FUNDRAISING", APART FROM THE MARK AS SHOWN.
FOR FUNDRAISING SERVICES FOR SCHOOL MUSIC GROUPS, CLASS TRIPS, ATHLETIC GROUPS, HOME-MAKERS GROUPS, FARMING AND AGRICULTURAL GROUPS, BUSINESS GROUPS, MARKETING GROUPS, SPORT ASSOCIATIONS, DAY CARE ORGANIZATIONS, BOY'S AND GIRL'S CLUBS AND ASSOCIATIONS, CHURCH GROUPS, CHURCH MINISTRIES, PAROCHIAL SCHOOL, ELDERLY PROGRAMS, YOUTH GROUPS, FRATERNITY ORGANIZATIONS, FAMILY REUNIONS, MEMORIALS, CHARITY ORGANIZATIONS (U.S. CLS. 100, 101 AND 102).
FIRST USE 0-0-1989; IN COMMERCE 0-0-1989.

CLASS 36—(Continued).

SN 76-063,617. NEXGEN BUILDING SOLUTIONS, LLC, CHICAGO, IL. FILED 5-26-2000.



NO CLAIM IS MADE TO THE EXCLUSIVE RIGHT TO USE "REAL ESTATE SOLUTIONS", APART FROM THE MARK AS SHOWN.
FOR REAL ESTATE MANAGEMENT, LEASING AND BROKERAGE SERVICES (U.S. CLS. 100, 101 AND 102).

SN 76-065,463. BANTERRA CORP., ELDORADO, IL. FILED 6-6-2000.



FOR BANKING SERVICES; MORTGAGE SERVICES, NAMELY MORTGAGE BANKING, MORTGAGE BROKERAGE AND MORTGAGE LENDING (U.S. CLS. 100, 101 AND 102).
FIRST USE 1-0-1984; IN COMMERCE 1-0-1984.

SN 76-065,467. BANTERRA INSURANCE SERVICES, INC., ELDORADO, IL. FILED 6-6-2000.



FOR INSURANCE BROKERAGE AND INVESTMENT BROKERAGE SERVICES (U.S. CLS. 100, 101 AND 102).
FIRST USE 5-0-1989; IN COMMERCE 5-0-1989.

SN 76-072,646. CANADA LIFE ASSURANCE COMPANY, THE, ATLANTA, GA. FILED 6-19-2000.

PASSPORT GLP20

FOR INSURANCE SERVICES, NAMELY, TERM LIFE INSURANCE UNDERWRITING SERVICES (U.S. CLS. 100, 101 AND 102).
FIRST USE 7-31-2000; IN COMMERCE 7-31-2000.

CLASS 36—(Continued).

SN 76-073,013. CANADA LIFE ASSURANCE COMPANY, THE, ATLANTA, GA. FILED 6-19-2000.

PASSPORT XLP20

FOR INSURANCE SERVICES, NAMELY, TERM LIFE INSURANCE UNDERWRITING SERVICES (U.S. CLS. 100, 101 AND 102).
FIRST USE 7-31-2000; IN COMMERCE 7-31-2000.

SN 76-080,318. FORD MOTOR COMPANY, DEARBORN, MI. FILED 6-29-2000.



OWNER OF U.S. REG. NOS. 74,530, 1,874,207 AND OTHERS.
FOR ELEMOSYNARY SERVICES IN THE AREA OF DONATIONS OF MONEY (U.S. CLS. 100, 101 AND 102).

SN 76-082,763. BENNETT GROUP, INC., THE, CHEVY CHASE, MD. FILED 7-3-2000.

THE INVITATION TO THE CELEBRATION OF LIFE

FOR PROVIDING PERSONAL FINANCIAL SERVICES, NAMELY, CASH MANAGEMENT AND BUDGETING, RISK MANAGEMENT ANALYSIS, EDUCATION FUND PLANNING, DEVELOPMENT, ADMINISTRATION, AND MANAGEMENT OF RETIREMENT PROGRAMS, ESTATE PLANNING, INVESTMENT PLANNING AND ASSET ALLOCATION, AND TAX PLANNING (U.S. CLS. 100, 101 AND 102).
FIRST USE 1-1-1994; IN COMMERCE 1-1-1997.

SN 76-083,909. GUIDEONE MUTUAL INSURANCE COMPANY, WEST DES MOINES, IA. FILED 7-6-2000.

GUIDEHOME

FOR INSURANCE UNDERWRITING IN THE FIELD OF PROPERTY, CASUALTY AND LIFE INSURANCE VIA GLOBAL COMPUTER NETWORK (U.S. CLS. 100, 101 AND 102).

CLASS 36—(Continued).

SN 76-083,948. EJMS SERVICES, LLC, LOS GATOS, CA. FILED 7-5-2000.

EJMS

OWNER OF U.S. REG. NO. 2,380,972.
FOR INSURANCE UNDERWRITING, NAMELY PERSONAL, COMMERCIAL, AND PROFESSIONAL INSURANCE; RISK MANAGEMENT AND FINANCIAL SERVICES; REAL ESTATE APPRAISAL; APPRAISALS FOR INSURANCE CLAIMS OF REAL AND PERSONAL PROPERTY; REAL ESTATE ASSET MANAGEMENT, LEASING OF REAL PROPERTY (U.S. CLS. 100, 101 AND 102).
FIRST USE 7-17-1997; IN COMMERCE 7-17-1997.

SN 76-086,175. GIROMEX, INC., SAN DIEGO, CA. FILED 7-10-2000.



THE WORD "GIROMEX" PROCEEDED BY A STYLIZED "G" AND FOLLOWED BY A PROFILE OF A ROOSTER FOR MONEY TRANSFER SERVICES, NAMELY, THE ELECTRONIC TRANSFER OF FUNDS (U.S. CLS. 100, 101 AND 102).
FIRST USE 4-30-1989; IN COMMERCE 4-30-1989.

SN 76-090,195. BUTTERS, LISA, SEATTLE, WA. FILED 7-14-2000.

CARING CAPITAL

NO CLAIM IS MADE TO THE EXCLUSIVE RIGHT TO USE "CAPITAL", APART FROM THE MARK AS SHOWN.
FOR FINANCIAL SERVICES, NAMELY, MAINTAINING SECURE DATABASES ON THE GLOBAL COMPUTER NETWORK CONSISTING OF LENDERS THAT OFFER FINANCING AND INVESTMENT AND BUSINESS OPPORTUNITIES (U.S. CLS. 100, 101 AND 102).

SN 76-090,413. BMO NESBITT BURNS CORPORATION LIMITED, MONTREAL, QUEBEC, CANADA, FILED 7-17-2000.

HALYARD CAPITAL FUND

NO CLAIM IS MADE TO THE EXCLUSIVE RIGHT TO USE "CAPITAL FUND", APART FROM THE MARK AS SHOWN.
FOR FINANCIAL SERVICES, NAMELY, A PRIVATE INVESTMENT FUND (U.S. CLS. 100, 101 AND 102).
FIRST USE 6-24-2000; IN COMMERCE 6-24-2000.

CLASS 36—(Continued).

SN 76-096,168. UPSHER-SMITH LABORATORIES, INC., MINNEAPOLIS, MN. FILED 7-25-2000.

3P PROGRAM PATIENT PHYSICIAN PHARMACY

NO CLAIM IS MADE TO THE EXCLUSIVE RIGHT TO USE "PROGRAM PATIENT PHYSICIAN" AND "PHARMACY", APART FROM THE MARK AS SHOWN.

FOR ADMINISTRATION OF A PRESCRIPTION DRUG BENEFIT PROGRAM (U.S. CLS. 100, 101 AND 102).

SN 76-097,473. SOURCINGLINK.NET, INC., SAN DIEGO, CA. FILED 7-24-2000.

SOURCELINK

FOR FINANCIAL INFORMATION PROVIDED BY ELECTRONIC MEANS, NAMELY ENABLING BUYERS TO PREPARE AND SUBMIT ON-LINE REQUESTS FOR PROPOSALS, QUOTES AND INFORMATION TO SELLERS, ENABLING SUPPLIERS TO MAKE ON-LINE BIDS AND OFFERS TO BUYERS, AND ENABLING BUYERS AND SUPPLIERS TO NEGOTIATE OFFERS VIA A GLOBAL COMPUTER NETWORK (U.S. CLS. 100, 101 AND 102).

FIRST USE 11-15-1999; IN COMMERCE 11-15-1999.

SN 76-097,853. FINACCESS INTERNATIONAL, INC., NEW YORK, NY. BY CHANGE OF NAME FINLATIN INTERNATIONAL, INC., NEW YORK, NY. FILED 7-27-2000.

FINACCES

FOR FINANCIAL AND INVESTMENT SERVICES, NAMELY, FINANCIAL ANALYSIS AND CONSULTING SERVICES; FINANCIAL INFORMATION SERVICES VIA A GLOBAL COMPUTER NETWORK; CREDIT CARD SERVICES; TELEPHONE CALLING CARD SERVICES; INVESTMENT CONSULTING SERVICES; FINANCIAL MANAGEMENT AND PORTFOLIO MANAGEMENT SERVICES; SECURITY BROKERAGE SERVICES; INVESTMENT BROKERAGE SERVICES; BILL PAYMENT SERVICES; AUTOMATIC TELLER MACHINE SERVICES; CASH MANAGEMENT ACCOUNT SERVICES (U.S. CLS. 100, 101 AND 102).

CLASS 36—(Continued).

SN 76-099,364. NATIONAL CITY CORPORATION, CLEVELAND, OH. FILED 7-28-2000.

NATIONAL CITY BUSINESS PRO

OWNER OF U.S. REG. NOS. 1,904,621, 2,350,903 AND OTHERS.

NO CLAIM IS MADE TO THE EXCLUSIVE RIGHT TO USE "NATIONAL" AND "BUSINESS", APART FROM THE MARK AS SHOWN.

FOR BANKING SERVICES DIRECTED TO SMALL BUSINESSES, NAMELY, CHECKING ACCOUNT SERVICES, MONEY MARKET ACCOUNT SERVICES, LOAN FINANCING SERVICES, INVESTMENT ADVISORY SERVICES AND FINANCIAL PLANNING SERVICES FOR RETIREMENT PURPOSES (U.S. CLS. 100, 101 AND 102).

SN 76-100,915. OANDA CORPORATION, NEW YORK, NY. FILED 7-31-2000.

FXCOMMERCE

FOR PROVIDING CURRENCY EXCHANGE SERVICES; PROVIDING FINANCIAL INFORMATION IN THE NATURE OF RATES OF EXCHANGE (U.S. CLS. 100, 101 AND 102).

FIRST USE 1-24-2000; IN COMMERCE 1-24-2000.

SN 76-102,130. TEXANS CREDIT UNION, RICHARDSON, TX. FILED 8-2-2000.

\$AVAR KIDS CLUB

NO CLAIM IS MADE TO THE EXCLUSIVE RIGHT TO USE "KIDS CLUB", APART FROM THE MARK AS SHOWN.

FOR BANKING SERVICES, NAMELY SAVINGS ACCOUNT CLUB FOR CHILDREN AND ACCOMPANYING PRINTED EDUCATIONAL MATERIALS AND NEWSLETTERS DISTRIBUTED THEREWITH (U.S. CLS. 100, 101 AND 102).

FIRST USE 6-1-2000; IN COMMERCE 6-1-2000.

SN 76-110,407. FAMILY WEALTH CONSULTANTS, L.L.C., SPRINGFIELD, MA. FILED 8-16-2000.

THE CRYSTAL BALL EXPERIENCE

FOR PROVIDING COMPREHENSIVE FINANCIAL ANALYSIS AND CONSULTATION FOR INDIVIDUALS IN MEETING THEIR LONG TERM FINANCIAL GOALS IN INCREASED WEALTH, FINANCIAL INVINCIBILITY, AND REDUCED FINANCIAL ANXIETY (U.S. CLS. 100, 101 AND 102).

CLASS 36—(Continued).

SN 76-116,685. FREEDOM PAY, INC., WAYNE, PA. FILED 8-25-2000.

A REVOLUTION WITHOUT CHANGE

FOR PROVIDING THE ABILITY TO PURCHASE AT VENDING MACHINES AND IN RETAIL STORES WITHOUT THE NEED FOR CASH OR A CREDIT CARD ON HAND, THROUGH AN ACCOUNT SET UP ON THE GLOBAL COMPUTER NETWORK (U.S. CLS. 100, 101 AND 102).

SN 76-116,882. VC EXPERTS, NEW YORK, NY. FILED 8-25-2000.

EXPERTISE AND OPPORTUNITY IN VENTURE CAPITAL

NO CLAIM IS MADE TO THE EXCLUSIVE RIGHT TO USE "VENTURE CAPITAL", APART FROM THE MARK AS SHOWN.

FOR VENTURE CAPITAL INVESTMENT MANAGEMENT AND INVESTMENT CONSULTATION AND ADVISE; FINANCIAL ANALYSIS AND CONSULTATION (U.S. CLS. 100, 101 AND 102).

FIRST USE 5-0-2000; IN COMMERCE 5-0-2000.

SN 76-122,839. VOLVO COMMERCIAL FINANCE LLC THE AMERICAS, GREENSBORO, NC. FILED 9-6-2000.



FOR FINANCING SERVICES; CREDIT CARD SERVICES; CUSTOMIZED FINANCIAL SERVICES, NAMELY, SERVICES FOR THE TRANSPORTATION AND CONSTRUCTION INDUSTRIES EXCLUDING FINANCIAL SERVICES IN THE FIELDS OF INVESTMENTS, BONDS AND FINANCIAL SECURITIES (U.S. CLS. 100, 101 AND 102).

SN 76-127,167. BUY OWNER INTERNATIONAL, INC., FORT LAUDERDALE, FL. FILED 9-13-2000.

STYLE REALTY

NO CLAIM IS MADE TO THE EXCLUSIVE RIGHT TO USE "REALTY", APART FROM THE MARK AS SHOWN.

FOR REAL ESTATE LISTING AND BROKERAGE SERVICES (U.S. CLS. 100, 101 AND 102).

FIRST USE 7-17-2000; IN COMMERCE 7-17-2000.

CLASS 36—(Continued).

SN 76-136,113. GENERAL ELECTRIC COMPANY, FAIRFIELD, CT. FILED 9-27-2000.

GE CREDIT LINE CALCULATOR

OWNER OF U.S. REG. NOS. 2,370,051, 2,387,887 AND 2,422,229.

NO CLAIM IS MADE TO THE EXCLUSIVE RIGHT TO USE "CREDIT LINE CALCULATOR", APART FROM THE MARK AS SHOWN.

FOR PROVIDING AN ELECTRONIC ONLINE WEBSITE FEATURING A CALCULATOR TO ASSIST IN ESTIMATING CREDIT LINE AVAILABILITY TO POTENTIAL BORROWERS (U.S. CLS. 100, 101 AND 102).

SN 76-143,233. GENERAL ELECTRIC COMPANY, SCHECTADY, NY. FILED 10-10-2000.

GE ESTATE PROTECTION SEVEN

NO CLAIM IS MADE TO THE EXCLUSIVE RIGHT TO USE "ESTATE PROTECTION", APART FROM THE MARK AS SHOWN.

FOR ANNUITY UNDERWRITING SERVICES (U.S. CLS. 100, 101 AND 102).

SN 76-145,158. IBM MID AMERICA EMPLOYEES FEDERAL CREDIT UNION, ROCHESTER, MN. FILED 10-13-2000.

THINK FEDERAL CREDIT UNION

NO CLAIM IS MADE TO THE EXCLUSIVE RIGHT TO USE "FEDERAL CREDIT UNION", APART FROM THE MARK AS SHOWN.

FOR FINANCIAL SERVICES IN THE NATURE OF FEDERAL CREDIT UNION SERVICES (U.S. CLS. 100, 101 AND 102).

SN 76-148,242. LEAR FINANCIAL INCORPORATED, SANTA MONICA, CA. FILED 10-17-2000.

GOLDCENTRAL

FOR GOLD, SILVER, PLATINUM, AND NUMISMATIC COINS AND BARS BROKERAGE SERVICES (U.S. CLS. 100, 101 AND 102).

FIRST USE 9-1-2000; IN COMMERCE 9-1-2000.

CLASS 36—(Continued).

SN 76-148,814. LIPPER & COMPANY, INC., NEW YORK, NY. FILED 10-17-2000.

LIPPER EUROPEAN CONVERTIBLES

NO CLAIM IS MADE TO THE EXCLUSIVE RIGHT TO USE "EUROPEAN CONVERTIBLES", APART FROM THE MARK AS SHOWN.

FOR INVESTMENT ADVISORY, INVESTMENT SUPERVISORY AND INVESTMENT MANAGEMENT SERVICES RELATING TO CONVERTIBLE SECURITIES AND HEDGED CONVERTIBLE SECURITIES; SECURITIES LENDING; FUND INVESTMENT SERVICES; FINANCIAL MANAGEMENT SERVICES, NAMELY, BUYING, SELLING, MAINTENANCE AND MANAGEMENT OF FUNDS AND INVESTMENTS FOR OTHERS (U.S. CLS. 100, 101 AND 102).

SN 76-149,215. MERIT CAPITAL ASSOCIATES, INC., WESTPORT, CT. FILED 10-18-2000.

PRIMA TERRA CAPITAL

NO CLAIM IS MADE TO THE EXCLUSIVE RIGHT TO USE "CAPITAL", APART FROM THE MARK AS SHOWN.

THE ENGLISH TRANSLATION OF THE WORDS "PRIMA TERRA" IS "FIRST EARTH".

FOR SECURITIES BROKERAGE, INVESTMENT BANKING AND RELATED FINANCIAL AND INVESTMENT SERVICES, NAMELY, MANAGEMENT, ANALYSIS AND CONSULTATION ON INVESTMENT MATTERS, BROKERAGE AND TRADING SERVICES FOR ALL TYPES OF SECURITIES (U.S. CLS. 100, 101 AND 102).

SN 76-170,994. CAPITAL ONE FINANCIAL CORPORATION, FALLS CHURCH, VA. FILED 11-27-2000.



OWNER OF U.S. REG. NOS. 1,763,253, 2,065,992 AND OTHERS.

NO CLAIM IS MADE TO THE EXCLUSIVE RIGHT TO USE "AUTO FINANCE", APART FROM THE MARK AS SHOWN.

"THE LINING SHOWN IN THE DRAWING IS A FEATURE OF THE MARK AND NOT INTENDED TO INDICATE COLOR".

FOR MOTOR VEHICLE FINANCING SERVICES (U.S. CLS. 100, 101 AND 102).

CLASS 36—(Continued).

SN 76-171,762. CUNA MUTUAL INSURANCE SOCIETY, MADISON, WI. FILED 11-28-2000.

MEMBER'S CHOICE

OWNER OF U.S. REG. NOS. 1,296,832, 1,522,075 AND OTHERS.

NO CLAIM IS MADE TO THE EXCLUSIVE RIGHT TO USE "MEMBERS", APART FROM THE MARK AS SHOWN.

FOR LIFE AND DISABILITY INSURANCE UNDERWRITING SERVICES, AND ADMINISTRATION OF MECHANICAL BREAKDOWN INSURANCE (U.S. CLS. 100, 101 AND 102).

FIRST USE 5-0-1988; IN COMMERCE 5-0-1988.

SN 76-174,903. TRANS UNION L.L.C, CHICAGO, IL. FILED 12-4-2000.

TRANS UNION DATA CONNECT

OWNER OF U.S. REG. NOS. 917,889, 2,092,132 AND OTHERS.

NO CLAIM IS MADE TO THE EXCLUSIVE RIGHT TO USE "DATA CONNECT", APART FROM THE MARK AS SHOWN.

FOR PROVIDING CREDIT INFORMATION AND PROFITS BY MEANS OF A GLOBAL COMPUTER NETWORK (U.S. CLS. 100, 101 AND 102).

SN 76-187,007. NETABACUS CORPORATION, SAN FRANCISCO, CA. FILED 12-27-2000.

RIVIO WORK FLOWS

FOR FINANCIAL SERVICES, NAMELY, FINANCIAL MANAGEMENT; ADMINISTRATION OF EMPLOYEE BENEFIT AND PENSION PLANS; INSURANCE SERVICES; FINANCIAL INFORMATION, EMPLOYEE BENEFIT AND PENSION PLAN INFORMATION, AND INSURANCE INFORMATION PROVIDED BY ELECTRONIC MEANS; TRACKING, FACILITATION, AND MANAGEMENT OF TRANSACTIONS IN THE FIELDS OF FINANCIAL SERVICES, EMPLOYEE BENEFIT AND PENSION PLAN SERVICES, AND INSURANCE SERVICES; ALL PROVIDED VIA COMPUTER NETWORKS, COMMUNICATIONS NETWORKS, AND THE INTERNET (U.S. CLS. 100, 101 AND 102).

SN 76-190,168. MERITAGE CORPORATION, SCOTTSDALE, AZ. FILED 1-5-2001.

MTH MORTGAGE

NO CLAIM IS MADE TO THE EXCLUSIVE RIGHT TO USE "MORTGAGE", APART FROM THE MARK AS SHOWN.

FOR MORTGAGE SERVICES (U.S. CLS. 100, 101 AND 102).

CLASS 36—(Continued).

SN 76-196,549. BLANSKI, PETER, KRONLAGE & ZOCH, P.A., MINNEAPOLIS, MN. FILED 1-16-2001.

**GOING BEYOND WHAT
MUST BE DONE TO WHAT
CAN BE DONE**

FOR TAX RETURN PREPARATION SERVICES AND TAX PLANNING, TAX MINIMIZATION, AND/OR TAX AVOIDANCE CONSULTATION SERVICES; BUSINESS PROFITABILITY IMPROVEMENT CONSULTATION SERVICES; WEALTH CREATION CONSULTATION SERVICES; RISK ACCEPTANCE/AVOIDANCE CONSULTATION SERVICES; BUSINESS SUCCESSION PLANNING SERVICES; ESTATE PLANNING SERVICES; FINANCIAL AND STRATEGIC PLANNING CONSULTATION SERVICES; BUSINESS VALUATION SERVICES; AND BUDGETING AND STRATEGIC PLANNING CONSULTATION SERVICES RELATED TO TECHNOLOGY AND TECHNOLOGY ACQUISITIONS (U.S. CLS. 100, 101 AND 102).

FIRST USE 5-13-1999; IN COMMERCE 5-19-1999.



SN 76-196,570. CALDWELL & ORKIN, INC., NORCROSS, GA. FILED 1-17-2001.



FOR INVESTMENT MANAGEMENT, INVESTMENT ADVICE, MUTUAL FUNDS, FINANCIAL PLANNING AND INVESTMENTS IN THE FIELD OF STOCKS AND BONDS (U.S. CLS. 100, 101 AND 102).

FIRST USE 10-25-1999; IN COMMERCE 10-25-1999.



SN 76-206,288. VC EXPERTS, NEW YORK, NY. FILED 2-7-2001.

**VENTURE CAPITAL
ENCYCLOPEDIA**

NO CLAIM IS MADE TO THE EXCLUSIVE RIGHT TO USE "VENTURE CAPITAL", APART FROM THE MARK AS SHOWN.

FOR VENTURE CAPITAL INVESTMENT MANAGEMENT AND INVESTMENT CONSULTATION AND ADVISE; FINANCIAL ANALYSIS AND CONSULTATION (U.S. CLS. 100, 101 AND 102).

CLASS 36—(Continued).

SN 76-206,363. VC EXPERTS, NEW YORK, NY. FILED 2-7-2001.

**ENCYCLOPEDIA OF
VENTURE CAPITAL**

NO CLAIM IS MADE TO THE EXCLUSIVE RIGHT TO USE "VENTURE CAPITAL", APART FROM THE MARK AS SHOWN.

FOR VENTURE CAPITAL INVESTMENT MANAGEMENT AND INVESTMENT CONSULTATION AND ADVISE; FINANCIAL ANALYSIS AND CONSULTATION (U.S. CLS. 100, 101 AND 102).



SN 76-206,629. VC EXPERTS, NEW YORK, NY. FILED 2-7-2001.

VC ENCYCLOPEDIA

NO CLAIM IS MADE TO THE EXCLUSIVE RIGHT TO USE "VC", APART FROM THE MARK AS SHOWN.

FOR VENTURE CAPITAL INVESTMENT MANAGEMENT AND INVESTMENT CONSULTATION AND ADVISE; FINANCIAL ANALYSIS AND CONSULTATION (U.S. CLS. 100, 101 AND 102).



SN 76-206,944. MADELYNE HALL FOUNDATION, INC., LYNDHURST, OH. FILED 2-9-2001.

RACE FOR CHILD SAFETY

NO CLAIM IS MADE TO THE EXCLUSIVE RIGHT TO USE "RACE", APART FROM THE MARK AS SHOWN.

FOR ORGANIZING AND PROMOTING A CHARITABLE FUNDRAISING SPORTING EVENT FOR CHILD CARE ISSUES (U.S. CLS. 100, 101 AND 102).

CLASS 36—(Continued).

SN 76-219,560. BELCO COMMUNITY CREDIT UNION, HARRISBURG, PA. FILED 3-5-2001.



NO CLAIM IS MADE TO THE EXCLUSIVE RIGHT TO USE "COMMUNITY CREDIT UNION", APART FROM THE MARK AS SHOWN.

FOR CREDIT UNION SERVICES (U.S. CLS. 100, 101 AND 102).

FIRST USE 4-0-1997; IN COMMERCE 4-0-1997.

SN 76-225,269. AMS DIVERSIFIED SERVICES, LTD., LAS VEGAS, NV. FILED 3-16-2001.



NO CLAIM IS MADE TO THE EXCLUSIVE RIGHT TO USE "HOME" AND "GRANTS", APART FROM THE MARK AS SHOWN.

FOR MORTGAGE BANKING, BANKING, MORTGAGE LENDING (U.S. CLS. 100, 101 AND 102).

FIRST USE 8-19-1999; IN COMMERCE 8-1-1999.

SN 76-229,351. CHAMPION-COPPELL INDUSTRIAL, LTD., ADDISON, TX. FILED 3-22-2001.

TRADEPOINT BUSINESS PARK

NO CLAIM IS MADE TO THE EXCLUSIVE RIGHT TO USE "BUSINESS PARK", APART FROM THE MARK AS SHOWN.

FOR LEASING OF BUILDINGS, OFFICES AND OFFICE PARKS (U.S. CLS. 100, 101 AND 102).

CLASS 36—(Continued).

SN 76-229,724. CIGNA INTELLECTUAL PROPERTY, INC., WILMINGTON, DE. FILED 3-26-2001.

CIGNA GROUP INSURANCE

OWNER OF U.S. REG. NOS. 1,270,224 AND 1,926,164.

NO CLAIM IS MADE TO THE EXCLUSIVE RIGHT TO USE "GROUP INSURANCE", APART FROM THE MARK AS SHOWN.

FOR UNDERWRITING, ADMINISTERING AND MANAGING TERM LIFE, ACCIDENT AND LONG-TERM DISABILITY INSURANCE PLANS; INSURANCE CLAIMS ADMINISTRATION IN THE FIELDS OF WORKERS' COMPENSATION AND SHORT-AND LONG-TERM DISABILITY (U.S. CLS. 100, 101 AND 102).
FIRST USE 9-1-1993; IN COMMERCE 9-1-1993.

SN 76-230,717. ORION CONSULTANTS, INC., REDINGTON SHORES, FL. FILED 3-27-2001.

WINDCALL

FOR WINDSTORM AND HAIL INSURANCE UNDERWRITING (U.S. CLS. 100, 101 AND 102).

FIRST USE 3-27-1997; IN COMMERCE 3-16-2000.

SN 76-232,815. UNIVERSAL UNDERWRITERS SERVICE CORPORATION, OVERLAND PARK, KS. FILED 3-29-2001.

VEHICLE REPAIR + PLUS

NO CLAIM IS MADE TO THE EXCLUSIVE RIGHT TO USE "VEHICLE REPAIR", APART FROM THE MARK AS SHOWN.

FOR ADMINISTERING VEHICLE SERVICE CONTRACTS FOR NEW AND USED VEHICLES (U.S. CLS. 100, 101 AND 102).

FIRST USE 3-1-2001; IN COMMERCE 3-1-2001.

SN 76-233,272. INTERNATIONAL COMFORT PRODUCTS CORPORATION (USA), LEWISBURG, TN. FILED 3-30-2001.

HELP

OWNER OF U.S. REG. NOS. 2,327,487 AND 2,447,344.

FOR PROVIDING EXTENDED WARRANTY CONTRACTS IN THE FIELD OF HOME HEATING AND COOLING SYSTEMS (U.S. CLS. 100, 101 AND 102).

CLASS 36—(Continued).

SN 76-243,766. TM ACQUISITION CORP., PHOENIX, AZ. FILED 4-23-2001.



NO CLAIM IS MADE TO THE EXCLUSIVE RIGHT TO USE "REAL ESTATE" AND "RESORT PROPERTIES INTERNATIONAL", APART FROM THE MARK AS SHOWN. THE MARK CONSISTS, IN PART, OF A STYLIZED DEPICTION OF A GLOBE AND A HOUSE. FOR REAL ESTATE BROKERAGE SERVICES (U.S. CLS. 100, 101 AND 102). FIRST USE 4-1-2001; IN COMMERCE 4-1-2001.

SN 76-248,761. CLARICA LIFE INSURANCE COMPANY - U.S., FARGO, ND. FILED 5-1-2001.

WAIT AND SEE

FOR INSURANCE UNDERWRITING SERVICES, NAMELY, LIFE INSURANCE UNDERWRITING (U.S. CLS. 100, 101 AND 102).

SN 76-251,295. BERGER LLC, DENVER, CO. FILED 5-4-2001.

BERGER IPT-NEW GENERATION FUND

OWNER OF U.S. REG. NOS. 1,667,846, 2,452,886 AND OTHERS. NO CLAIM IS MADE TO THE EXCLUSIVE RIGHT TO USE "FUND", APART FROM THE MARK AS SHOWN. FOR INVESTING THE FUND OF OTHERS; MUTUAL FUND SERVICES (U.S. CLS. 100, 101 AND 102). FIRST USE 5-1-2000; IN COMMERCE 5-1-2000.

CLASS 36—(Continued).

SN 76-252,042. BERGER LLC, DENVER, CO. FILED 5-4-2001.

BERGER IPT-INTERNATIONAL FUND

OWNER OF U.S. REG. NOS. 1,667,846, 2,452,886 AND OTHERS. NO CLAIM IS MADE TO THE EXCLUSIVE RIGHT TO USE "FUND", APART FROM THE MARK AS SHOWN. FOR INVESTING THE FUND OF OTHERS; MUTUAL FUND SERVICES (U.S. CLS. 100, 101 AND 102). FIRST USE 5-12-2000; IN COMMERCE 5-12-2000.

SN 76-254,526. INTERNATIONAL MEDICAL GROUP, INC., INDIANAPOLIS, IN. FILED 5-9-2001.

PORT MEDICAL NETWORK

NO CLAIM IS MADE TO THE EXCLUSIVE RIGHT TO USE "MEDICAL NETWORK", APART FROM THE MARK AS SHOWN. FOR INSURANCE PLAN ADMINISTRATION SERVICES (U.S. CLS. 100, 101 AND 102).

SN 76-258,557. SELLER'S ADVOCATE REALTY, INC., CARROLLTON, TX. FILED 5-18-2001.



NO CLAIM IS MADE TO THE EXCLUSIVE RIGHT TO USE "SELLER'S ADVOCATE REALTY", APART FROM THE MARK AS SHOWN. FOR REAL ESTATE BROKERAGE SERVICES, (U.S. CLS. 100, 101 AND 102). FIRST USE 3-22-2001; IN COMMERCE 3-22-2001.

SN 76-258,639. CORPREX, LLC, ORLANDO, FL. FILED 5-17-2001.

CORPREX

FOR REAL ESTATE ACQUISITION, DISPOSITION AND TAX DEFERRED EXCHANGE (U.S. CLS. 100, 101 AND 102). FIRST USE 7-7-2000; IN COMMERCE 7-7-2000.

CLASS 36—(Continued).

SN 76-259,419. SARATOGA'S COMMUNITY FEDERAL CREDIT UNION, SARATOGA SPRINGS, NY. FILED 5-21-2001.



NO CLAIM IS MADE TO THE EXCLUSIVE RIGHT TO USE "SARATOGA'S COMMUNITY FEDERAL CREDIT UNION", APART FROM THE MARK AS SHOWN. FOR BANKING (U.S. CLS. 100, 101 AND 102). FIRST USE 9-21-2000; IN COMMERCE 9-21-2000.

SN 76-268,429. INA CORPORATION, PHILADELPHIA, PA. FILED 6-7-2001.

ELITE YACHT PROGRAM

NO CLAIM IS MADE TO THE EXCLUSIVE RIGHT TO USE "YACHT PROGRAM", APART FROM THE MARK AS SHOWN.

FOR UNDERWRITING OF MARINE AND YACHT INSURANCE (U.S. CLS. 100, 101 AND 102).

SN 76-272,387. TRUSTMARK NATIONAL BANK, JACKSON, MS. FILED 6-15-2001.

TRUSTTOUCHWEB

FOR BANKING SERVICES, NAMELY CHECKING, SAVINGS AND LOAN SERVICES, INVESTMENT SERVICES, CASH MANAGEMENT AND ELECTRONIC BANKING VIA THE INTERNET; FINANCIAL SERVICES, NAMELY, CREDIT CARD SERVICES, FINANCIAL PLANNING, FINANCIAL PORTFOLIO MANAGEMENT, AND TRUST AND ASSET MANAGEMENT VIA THE INTERNET; PROVIDING INFORMATION IN THE FINANCIAL AND BANKING FIELDS VIA THE INTERNET; INSURANCE SERVICES, NAMELY, ANNUITY BROKERAGE SERVICES VIA THE INTERNET (U.S. CLS. 100, 101 AND 102).

SN 76-274,956. TOUCHCREDIT FINANCIAL SERVICES, INC., MARINA DEL REY, CA. FILED 6-21-2001.

NO CARD, NO ID, NO PROBLEM

FOR BANKING AND CREDIT SERVICES FEATURING BIOMETRIC IDENTIFICATION, AUTHENTICATION, AND VERIFICATION OF USERS, OFFERED VIA COMPUTER NETWORK AND AT POINT OF SALE (U.S. CLS. 100, 101 AND 102).

CLASS 36—(Continued).

SN 76-277,109. GLOBESPAN CAPITAL MANAGEMENT, INC., BOSTON, MA. FILED 6-27-2001.

GLOBESPAN CAPITAL PARTNERS

NO CLAIM IS MADE TO THE EXCLUSIVE RIGHT TO USE "CAPITAL PARTNERS", APART FROM THE MARK AS SHOWN.

FOR FINANCIAL SERVICES, NAMELY MANAGEMENT OF VENTURE CAPITAL FUNDS AND INVESTMENT SERVICES FOR OTHERS IN THE FIELD OF VENTURE CAPITAL (U.S. CLS. 100, 101 AND 102).

SN 76-280,067. TRANS UNION L.L.C., CHICAGO, IL. FILED 7-3-2001.

TRACKVISION

FOR IDENTIFYING AND LOCATING DELINQUENT DEBTORS THROUGH THE USE OF A SKIP TRACING DATABASE (U.S. CLS. 100, 101 AND 102).

SN 76-283,434. ADVANCE BANCORP, INC., LANSING, IL. FILED 7-11-2001.



FOR BANKING (U.S. CLS. 100, 101 AND 102). FIRST USE 9-1-1999; IN COMMERCE 9-1-1999.

SN 76-283,631. ASTERION CAPITAL LLC, CAMBRIDGE, MA. FILED 7-11-2001.

ASTERION CAPITAL

NO CLAIM IS MADE TO THE EXCLUSIVE RIGHT TO USE "CAPITAL", APART FROM THE MARK AS SHOWN.

FOR FINANCIAL AND INVESTMENT SERVICES IN THE FIELD OF SECURITIES; CONSULTATION, PORTFOLIO MANAGEMENT AND ADVISORY SERVICES IN THE FIELD OF SECURITIES; AND TRADING SERVICES INVOLVING SECURITIES OF ANY KIND (U.S. CLS. 100, 101 AND 102).

CLASS 36—(Continued).

SN 76-287,202. SUSAN G. KOMEN BREAST CANCER FOUNDATION, THE, DALLAS, TX. FILED 7-18-2001.

PRAYER FOR THE CURE

OWNER OF U.S. REG. NOS. 1,593,469, 2,484,982 AND OTHERS.

FOR CHARITABLE FUNDRAISING SERVICES, NAMELY, RAISING MONEY FOR BREAST CANCER RESEARCH AND RAISING MONEY FOR LOCAL COMMUNITY BREAST HEALTH AWARENESS PROGRAMS (U.S. CLS. 100, 101 AND 102).

CLASS 36—(Continued).

SN 76-306,389. NATHAN & LEWIS SECURITIES, INC., NEW YORK, NY. FILED 8-29-2001.

NATHAN & LEWIS

FOR FINANCIAL SERVICES, NAMELY, SECURITIES BROKERAGE SERVICES AND ONLINE SECURITIES BROKERAGE SERVICES; PROVISION OF FINANCIAL AND SECURITIES RELATED INFORMATION BY MEANS OF A GLOBAL COMPUTER NETWORK; INSURANCE BROKERAGE SERVICES (U.S. CLS. 100, 101 AND 102).
FIRST USE 0-0-1976; IN COMMERCE 0-0-1976.

SN 76-291,360. SOUTHWEST SECURITIES GROUP, INC., DALLAS, TX. FILED 7-27-2001.

SWS SECURITIES

OWNER OF U.S. REG. NOS. 2,358,973, 2,358,974 AND 2,418,656.

NO CLAIM IS MADE TO THE EXCLUSIVE RIGHT TO USE "SECURITIES", APART FROM THE MARK AS SHOWN.

FOR FINANCIAL SERVICES IN THE FIELD OF INVESTMENT AND SECURITIES BROKERAGE, NAMELY, BROKERAGE SERVICES CONCERNING SECURITIES, MUTUAL FUNDS AND COMMODITIES, FINANCIAL MANAGEMENT SERVICES; SECURITIES AND FINANCIAL CLEARING SERVICES; FINANCIAL ADVISORY SERVICES; FINANCIAL CONSULTATION SERVICES, INVESTMENT ACCOUNT PLANNING (U.S. CLS. 100, 101 AND 102).

SN 76-308,009. TPAC UNDERWRITERS, INC., MINNEAPOLIS, MN. FILED 8-31-2001.

SPAGGREGATE

FOR UNDERWRITING AND ADMINISTRATION SERVICES IN CONNECTION WITH CATASTROPHIC RISK COVERAGE FOR EMPLOYER-FUNDED MEDICAL PLANS (U.S. CLS. 100, 101 AND 102).

SN 76-308,549. HSN LP, ST. PETERSBURG, FL. FILED 9-4-2001.

HSN ESSENTIALS

OWNER OF U.S. REG. NOS. 1,482,734, 2,478,125 AND OTHERS.

FOR CREDIT CARD SERVICES (U.S. CLS. 100, 101 AND 102).

SN 76-306,275. GOPIN INC., TIMONIUM, MD. FILED 8-29-2001.

BILL ME IN INSTALLMENTS

FOR CREDIT SERVICES, NAMELY, PROVIDING REVOLVING CREDIT ACCOUNT SERVICES AND BILL PAYMENT SERVICES TO OTHERS VIA THE TELEPHONE AND THE WORLD WIDE WEB (U.S. CLS. 100, 101 AND 102).

SN 76-309,940. CANADA LIFE INSURANCE COMPANY OF NEW YORK, ARDSLEY, NY. FILED 9-6-2001.

TRIUMPH

FOR INSURANCE SERVICES, NAMELY UNIVERSAL LIFE INSURANCE UNDERWRITING SERVICES (U.S. CLS. 100, 101 AND 102).
FIRST USE 12-31-1997; IN COMMERCE 12-31-1997.

SN 76-306,360. GOPIN INC., TIMONIUM, MD. FILED 8-29-2001.

EMAIL ME A BILL

FOR CREDIT SERVICES, NAMELY, PROVIDING REVOLVING CREDIT ACCOUNT SERVICES AND BILL PAYMENT SERVICES TO OTHERS VIA THE TELEPHONE AND THE WORLD WIDE WEB (U.S. CLS. 100, 101 AND 102).

SN 78-008,646. TM ACQUISITION CORP., PHOENIX, AZ. FILED 5-18-2000.

CENTURY 21

OWNER OF U.S. REG. NOS. 1,063,488, 1,085,039 AND 1,304,095.
FOR MORTGAGE BANKING SERVICES (U.S. CLS. 100, 101 AND 102).

CLASS 36—(Continued).

SN 78-010,846. HAWKINS MCENTEE ADVISORS, LLC, GREENWICH, CT. FILED 6-1-2000.

COMPREHENSIVE GLOBAL STRATEGIES (CGS)

NO CLAIM IS MADE TO THE EXCLUSIVE RIGHT TO USE "GLOBAL STRATEGIES", APART FROM THE MARK AS SHOWN.

FOR FINANCIAL AND INVESTMENT MANAGEMENT AND CONSULTATION FOR OTHERS; INVESTMENT FUND AND HEDGE FUND SERVICES, NAMELY, THE INVESTMENT OF FUNDS FOR OTHERS IN STOCKS, BONDS, FINANCIAL SECURITIES AND DERIVATIVES (U.S. CLS. 100, 101 AND 102).

SN 78-012,614. PLAN 3 INC., ROCKVILLE, MD. FILED 6-14-2000.



OWNER OF U.S. REG. NO. 1,826,600.
NO CLAIM IS MADE TO THE EXCLUSIVE RIGHT TO USE "PLAN" AND "INC.", APART FROM THE MARK AS SHOWN.

FOR INSURANCE CONSULTATION AND INSURANCE BENEFIT PLAN ADMINISTRATION (U.S. CLS. 100, 101 AND 102).

FIRST USE 3-1-1997; IN COMMERCE 3-1-1997.

SN 78-017,429. UNX.COM, INC., BURBANK, CA. FILED 7-19-2000.

SYNTHETEX

FOR SECURITY BROKERAGE SERVICES, NAMELY, ON-LINE SECURITIES TRADING PROVIDED BY ELECTRONIC MEANS (U.S. CLS. 100, 101 AND 102).

SN 78-019,499. BRILL EDITORIAL SERVICES, INC., WEST BOYLSTON, MA. FILED 8-3-2000.

MUTUAL FUNDS 101

OWNER OF U.S. REG. NOS. 2,336,242 AND 2,345,528.
NO CLAIM IS MADE TO THE EXCLUSIVE RIGHT TO USE "MUTUAL FUNDS", APART FROM THE MARK AS SHOWN.

FOR PROVIDING FINANCIAL AND OTHER INFORMATION ON MUTUAL FUNDS AND OTHER INVESTMENT VEHICLES BY ELECTRONIC MEANS, NAMELY, THROUGH A GLOBAL COMPUTER INFORMATION NETWORK (U.S. CLS. 100, 101 AND 102).

CLASS 36—(Continued).

SN 78-019,696. CUBE MARKETING GROUP, LLC, MINNEAPOLIS, MN. FILED 8-4-2000.



NO CLAIM IS MADE TO THE EXCLUSIVE RIGHT TO USE "MARKETING GROUP AND LLC", APART FROM THE MARK AS SHOWN.

FOR INVESTMENT MARKETING SERVICES (U.S. CLS. 100, 101 AND 102).

SN 78-032,970. GUAGLIARDO, MARK, OXNARD, CA. FILED 10-30-2000.

CYBERCHARGE

FOR FINANCIAL SERVICES, NAMELY, CREDIT CARD SERVICES, LOAN FINANCING, MORTGAGE LENDING AND MORTGAGE BROKERAGE SERVICES; BANKING SERVICES; BILL PAYMENT SERVICES; PRE-PAYMENT SERVICES FOR SUBSEQUENT PURCHASES OF GOODS AND SERVICES; PROVIDING DEBIT ACCOUNTS FOR ONLINE PAYMENTS; ON-LINE FINANCIAL SERVICES, NAMELY, CREDIT CARD SERVICES, LOAN FINANCING, MORTGAGE LENDING AND MORTGAGE BROKERAGE SERVICES; ON-LINE BANKING SERVICES; ON-LINE BILL PAYMENT SERVICES; CREDIT CARD TRANSACTION PROCESSING; DEBIT CARD TRANSACTION PROCESSING, VIRTUAL CREDIT CARD PROCESSING; COLLECTION SERVICES, COLLECTION OF CASH AND EQUIVALENT PAYMENTS AT BRICK-AND-MORTAR LOCATIONS TO ESTABLISH OR RECHARGE AN ACCOUNT FOR ON-LINE TRANSACTIONS; PRE-PAYMENT AND POST-PAYMENT SERVICES (U.S. CLS. 100, 101 AND 102).

FIRST USE 7-29-1995; IN COMMERCE 7-29-1995.

SN 78-033,458. BANKERS LIFE AND CASUALTY COMPANY, CHICAGO, IL. FILED 11-2-2000.

PROVIDING GENERATIONS OF SUPPORT

FOR UNDERWRITING ANNUITIES AND LIFE AND HEALTH INSURANCE (U.S. CLS. 100, 101 AND 102).

FIRST USE 8-24-2000; IN COMMERCE 8-24-2000.

CLASS 36—(Continued).

SN 78-034,323. BANK OF AMERICA CORPORATION, CHARLOTTE, NC. FILED 11-8-2000.

EUR SERVES

NO CLAIM IS MADE TO THE EXCLUSIVE RIGHT TO USE "EUR", APART FROM THE MARK AS SHOWN.

FOR FINANCIAL SERVICES, NAMELY, PROVIDING FINANCIAL ANALYSIS, CONSULTATION, PLANNING AND MANAGEMENT, COMMERCIAL AND CONSUMER LENDING AND LEASING SERVICES, MORTGAGE LENDING, AND LOAN FINANCING; CREDIT CARD SERVICES; DEBIT CARD SERVICES; ELECTRONIC PAYMENT, NAMELY, ELECTRONIC PROCESSING AND TRANSMISSION OF BILL PAYMENT DATA; FINANCIAL INFORMATION IN THE NATURE OF RATES OF EXCHANGE; SECURITY SERVICES, NAMELY, GUARANTEEING LOANS; CASH MANAGEMENT; MORTGAGE BANKING; INVESTMENT SERVICES, NAMELY, PROVIDING INVESTMENT ANALYSIS, CONSULTATION, PLANNING, MANAGEMENT, ADVISORY, BROKERAGE, BANKING, AND RESEARCH SERVICES WITH RESPECT TO STOCKS, MUTUAL FUNDS, SECURITIES, BONDS, COMMODITIES, REAL ESTATE AND OTHER INSTRUMENTS OF INVESTMENT (U.S. CLS. 100, 101 AND 102).

SN 78-037,262. AGENCY HEALTH BROKERAGE, INC., HOT SPRINGS, AR. FILED 11-30-2000.

PROTECTOR PLUS MAJOR MEDICAL

NO CLAIM IS MADE TO THE EXCLUSIVE RIGHT TO USE "MAJOR MEDICAL", APART FROM THE MARK AS SHOWN.

FOR MEDICAL INSURANCE UNDERWRITING (U.S. CLS. 100, 101 AND 102).

SN 78-037,709. GUARD FINANCIAL GROUP, INC., WILKES-BARRE, PA. FILED 12-4-2000.



OWNER OF U.S. REG. NO. 1,614,207.

NO CLAIM IS MADE TO THE EXCLUSIVE RIGHT TO USE "CAPITAL", APART FROM THE MARK AS SHOWN.

FOR BANKING SERVICES; INVESTMENT SERVICES, NAMELY, INVESTMENT MANAGEMENT, INVESTMENT BROKERAGE, AND INVESTMENT CONSULTATION; FINANCIAL SERVICES, NAMELY, FINANCIAL EXCHANGE, FINANCIAL FORECASTING, FINANCIAL ANALYSIS AND CONSULTATION; AND INSURANCE SERVICES, NAMELY, INSURANCE ADMINISTRATION, INSURANCE BROKERAGE, INSURANCE CONSULTATION, INSURANCE CLAIMS PROCESSING, INSURANCE AGENCIES IN THE FIELDS OF HOME, BUSINESS, ACCIDENT AND FIRE (U.S. CLS. 100, 101 AND 102).

CLASS 36—(Continued).

SN 78-039,681. J. D. RYAN AGENCY INC., DBA THE RYAN AGENCY, HORNELLS, NY. FILED 12-18-2000.



NO CLAIM IS MADE TO THE EXCLUSIVE RIGHT TO USE "AGENCY", APART FROM THE MARK AS SHOWN.

FOR FINANCIAL AND INSURANCE CONSULTING (U.S. CLS. 100, 101 AND 102).

FIRST USE 7-1-1998; IN COMMERCE 7-1-1998.

SN 78-040,604. MARSHALL & ILSLEY CORPORATION, MILWAUKEE, WI. FILED 12-26-2000.

JUST THE PARTNER YOU NEED

FOR BANKING CONSULTATION SERVICES; CONSULTATION SERVICES IN THE FIELD OF CONSUMER LENDING; CONSUMER LENDING SERVICES; INVESTMENT CONSULTATION SERVICES; INVESTMENT MANAGEMENT SERVICES AND FINANCIAL CONSULTATION SERVICES (U.S. CLS. 100, 101 AND 102).

FIRST USE 8-31-1994; IN COMMERCE 8-31-1994.

SN 78-041,847. DEVONSHIRE FORTE, LTD., ALBANY, NY. FILED 1-5-2001.

NEXSTOX

FOR INTERNET BASED DISCOUNT STOCK BROKERAGE, ONLINE TRADING AND INVESTING (U.S. CLS. 100, 101 AND 102).

SN 78-053,464. VEJAR, LUIS, GUADALAJARA JALISCO, MEXICO, FILED 3-16-2001.



NO CLAIM IS MADE TO THE EXCLUSIVE RIGHT TO USE "AUTO" AND "VIAJE", APART FROM THE MARK AS SHOWN.

THE ENGLISH TRANSLATION OF THE WORD "AUTO FIN VIAJE" IN THE MARK IS "SELF FINANCING TRIPS".

FOR LEASING OF REAL PROPERTY AND APARTMENTS; FINANCIAL VALUATION OF PERSONAL PROPERTY AND REAL ESTATE, AUTOMOBILE LOAN FINANCING (U.S. CLS. 100, 101 AND 102).

CLASS 36—(Continued).

SN 78-054,083. PITANGO VENTURE CAPITAL MANAGEMENT (USA) L.L.C., MENLO PARK, CA. BY CHANGE OF NAME POLARIS VENTURE CAPITAL MANAGEMENT (USA) LLC, MENLO PARK, CA. FILED 3-20-2001.

PITANGO

FOR VENTURE CAPITAL FINANCIAL SERVICES, NAMELY, PROVIDING FINANCING TO SEED, EARLY, AND EXPANSION STAGE COMPANIES; AND MANAGING VENTURE CAPITAL FUNDS (U.S. CLS. 100, 101 AND 102).

FIRST USE 7-10-2001; IN COMMERCE 7-10-2001.

SN 78-055,156. GIBSON, MICHAEL B., ATLANTA, GA. FILED 3-27-2001.

NICHEBANK

FOR BANKING; MORTGAGE BANKING; MORTGAGE PROCUREMENT FOR OTHERS; MORTGAGE LENDING; CREDIT CARD SERVICES; ISSUING OF CREDIT CARDS; CREDIT CONSULTATION; CURRENCY EXCHANGE AND ADVICE; FINANCIAL EXCHANGE; MONETARY EXCHANGE; FINANCIAL INFORMATION IN THE NATURE OF RATES OF EXCHANGE; FINANCIAL MANAGEMENT; INVESTMENT MANAGEMENT; CHECKING AND SAVINGS ACCOUNT SERVICES; ONLINE BANKING SERVICES (U.S. CLS. 100, 101 AND 102).

SN 78-064,698. STRUCTUREONLINE, INC., SALEM, NH. FILED 5-21-2001.

STRUCTUREONLINE

FOR PROVIDING CONSULTATION SERVICES IN THE INSURANCE AND STRUCTURED SETTLEMENT INDUSTRIES, AND PROVIDING COMPUTER SOFTWARE RELATED THERETO (U.S. CLS. 100, 101 AND 102).

FIRST USE 12-1-1999; IN COMMERCE 12-1-1999.

CLASS 36—(Continued).

SN 78-065,339. DARMONTE ENTERPRISES, INC., WEST PALM BEACH, FL. FILED 5-23-2001.



NO CLAIM IS MADE TO THE EXCLUSIVE RIGHT TO USE "PARKINSON'S DISEASE", APART FROM THE MARK AS SHOWN.

THE LINING SHOWN IN THE DRAWING IS A FEATURE OF THE MARK AND NOT INTENDED TO INDICATE COLOR. THE STIPPLING SHOWN IN THE DRAWING IS A FEATURE OF THE MARK AND NOT INTENDED TO INDICATE COLOR.

FOR CHARITABLE FUND RAISING FOR RESEARCH TO FIND A CURE FOR PARKINSON'S DISEASE (U.S. CLS. 100, 101 AND 102).

SN 78-067,490. METROPOLITAN PROPERTY AND CASUALTY INSURANCE COMPANY, WARWICK, RI. FILED 6-5-2001.

PEOPLE LIKE ME

FOR PROVIDING INFORMATION IN THE FIELD OF INSURANCE AND FINANCIAL SERVICES, NAMELY, PROVIDING QUOTES FOR AUTOMOBILE INSURANCE POLICIES VIA A GLOBAL COMMUNICATIONS NETWORK (U.S. CLS. 100, 101 AND 102).

SN 78-068,892. FAY, RICHARD A., DBA RICHARD A. FAY & CO., SALT LAKE CITY, UT. FILED 6-13-2001.

FAY-TRADE

FOR FINANCIAL PORTFOLIO MANAGEMENT FOR OTHERS (U.S. CLS. 100, 101 AND 102).

CLASS 36—(Continued).

SN 78-075,709. CHICKASAW BANC HOLDING COMPANY, YUKON, OK. FILED 7-25-2001.

BANK2 TWICE THE BANK

FOR BANKING SERVICES, NAMELY, INSTALLMENT, COMMERCIAL AND REAL ESTATE LOANS; MORTGAGE LOAN SERVICES; AUTOMATIC TELLER MACHINE SERVICES; DEBIT CARD SERVICES; CREDIT CARD SERVICES; ELECTRONIC FUND TRANSFERS, PROVIDING BANKING SERVICES VIA INTERACTIVE BANKING INTERNET SITE; TRUST SERVICES, NAMELY PERSONAL AND CORPORATE INVESTMENT AND ASSET MANAGEMENT SERVICES; INSURANCE SERVICES, NAMELY COMMERCIAL AND CONSUMER UNDERWRITING SERVICES IN PROPERTY AND CASUALTY, LIFE INSURANCE, HEALTH INSURANCE AND ANNUITIES; CASH MANAGEMENT SERVICES; AND BROKERAGE SERVICES, NAMELY INVESTMENT BROKERAGE, INSURANCE BROKERAGE, AND MORTGAGE BROKERAGE SERVICES (U.S. CLS. 100, 101 AND 102).

SN 78-077,079. SAGE INSURANCE GROUP, INC., STAMFORD, CT. FILED 8-2-2001.

SECTOR PROTECTOR

NO CLAIM IS MADE TO THE EXCLUSIVE RIGHT TO USE "SECTOR", APART FROM THE MARK AS SHOWN. FOR INSURANCE AND INVESTMENT SERVICES FOR ALLOCATING ASSETS WITHIN VARIABLE ANNUITIES AND VARIABLE LIFE INSURANCE POLICIES (U.S. CLS. 100, 101 AND 102).

SN 78-077,195. HARPER, STEPHEN, AGOURA HILLS, CA. FILED 8-2-2001.

COUNTRYWORLDWIDE

FOR FINANCIAL SERVICES AND BANKING, NAMELY MORTGAGE LENDING, MORTGAGE BANKING, MORTGAGE BACKED SECURITIES BROKERAGE, SECURITIES BROKERAGE SERVICES, INSURANCE BROKERAGE AND AGENCY SERVICES, INVESTMENT SERVICES, NAMELY, INVESTMENT MANAGEMENT, AND INVESTMENT CONSULTING (U.S. CLS. 100, 101 AND 102).

SN 78-077,577. TEAM ADVANTAGE LLC, LEE'S SUMMIT, MO. FILED 8-6-2001.

THE BUYERS ADVANTAGE

NO CLAIM IS MADE TO THE EXCLUSIVE RIGHT TO USE "BUYERS", APART FROM THE MARK AS SHOWN. FOR REAL ESTATE BROKERAGE (U.S. CLS. 100, 101 AND 102). FIRST USE 3-1-2000; IN COMMERCE 3-15-2000.

CLASS 36—(Continued).

SN 78-077,622. AMERICAN EXPRESS COMPANY, NEW YORK, NY. FILED 8-6-2001.

**AMERICAN EXPRESS
BLUEPRINT**

OWNER OF U.S. REG. NOS. 1,024,840, 1,847,678 AND OTHERS.

FOR FINANCIAL SERVICES, NAMELY FUND AND SECURITY INVESTMENT (U.S. CLS. 100, 101 AND 102).

SN 78-077,640. FMR CORP., BOSTON, MA. FILED 8-6-2001.

**MORTGAGE CENTER AT
FIDELITY.COM**

OWNER OF U.S. REG. NOS. 1,277,373, 1,481,037 AND OTHERS.

NO CLAIM IS MADE TO THE EXCLUSIVE RIGHT TO USE "MORTGAGE CENTER", APART FROM THE MARK AS SHOWN.

FOR FINANCIAL INFORMATION PROCESSING IN THE FIELD OF MORTGAGES; MARGIN LOAN SERVICES RENDERED TO MORTGAGE BORROWERS TO ENABLE THEM TO AVOID MAKING DOWN PAYMENTS ON REAL ESTATE; PROVIDING INFORMATION IN THE FIELD OF MORTGAGES BY MEANS OF THE INTERNET; FINANCIAL INFORMATION PROVIDED BY ELECTRONIC MEANS (U.S. CLS. 100, 101 AND 102).

SN 78-082,684. PERFORMANCE TITLE COMPANY, INC., HANOVER, MD. FILED 9-5-2001.

**PERFORMANCE TITLE
COMPANY**

NO CLAIM IS MADE TO THE EXCLUSIVE RIGHT TO USE "TITLE COMPANY", APART FROM THE MARK AS SHOWN.

FOR REAL ESTATE TITLE INSURANCE BROKERAGE SERVICES (U.S. CLS. 100, 101 AND 102).

FIRST USE 3-1-1999; IN COMMERCE 3-1-1999.

SN 78-084,667. JOHN R. WOOD INC., REALTORS, NAPLES, FL. FILED 9-20-2001.

CYBER LINK

FOR REAL ESTATE BROKERAGE AND REAL ESTATE AGENCY SERVICES; REAL ESTATE BROKERAGE AND REAL ESTATE AGENCY SERVICES FOR HOME BASED REAL ESTATE PROFESSIONALS; PROVIDING INFORMATION IN THE FIELD OF REAL ESTATE BROKERAGE AND REAL ESTATE AGENCIES (U.S. CLS. 100, 101 AND 102).

CLASS 37—CONSTRUCTION AND REPAIR

CLASS 37—(Continued).

SN 75-482,990. LANDIS & STAEFA, INC., BUFFALO GROVE, IL. FILED 5-11-1998.

SMART UNIVERSITY

FOR INSTALLATION AND MAINTENANCE OF BUILDING RESOURCE CONTROL SYSTEMS, NAMELY, INSTALLATION AND MAINTENANCE OF HEATING, VENTILATION, AIR-CONDITIONING, LIGHTING, SECURITY, INDOOR AIR QUALITY, ENERGY-SAVING, AND BUILDING AND PERSONAL LIFE SAFETY SECURITY SYSTEMS (U.S. CLS. 100, 103 AND 106).

SN 75-838,579. MAG NORTH, INC., CENTEREACH, NY. FILED 11-4-1999.

**"YOU PROVIDE THE
POPCORN, WE PROVIDE
THE CLEAN..."**

FOR COMMERCIAL JANITORIAL AND CLEANING SERVICES (U.S. CLS. 100, 103 AND 106).
FIRST USE 12-0-1997; IN COMMERCE 12-0-1997.

SN 75-846,437. TRENDMAKER HOMES, HOUSTON, TX. FILED 11-12-1999.

SmartCenter Garage

NO CLAIM IS MADE TO THE EXCLUSIVE RIGHT TO USE "GARAGE", APART FROM THE MARK AS SHOWN.

FOR RESIDENTIAL CONSTRUCTION SERVICES, NAMELY, PROVIDING CUSTOMIZED GARAGE DESIGN FEATURES IN NEW HOMES (U.S. CLS. 100, 103 AND 106).

FIRST USE 2-15-1995; IN COMMERCE 4-15-1995.

SN 76-014,885. HOUSTON, MARSHALL S., GREENVILLE, SC. FILED 3-18-2000.

Bug a Pest

FOR ANY AND ALL TYPES OF PEST CONTROL SERVICES (U.S. CLS. 100, 103 AND 106).

FIRST USE 3-18-2000; IN COMMERCE 1-8-2000.

CLASS 37—(Continued).

SN 76-046,572. CSW CONTRACTORS, INC., PHOENIX, AZ. FILED 5-12-2000.



THE STIPPLING IS A FEATURE OF THE MARK AND DOES NOT INDICATE COLOR.

FOR CONSTRUCTION SERVICES, NAMELY, GRADING, ASPHALT PAVING, CONCRETE DRAINAGE, SEWER AND WATER LINE INSTALLATION (U.S. CLS. 100, 103 AND 106).

FIRST USE 6-0-1982; IN COMMERCE 6-0-1982.

SN 76-057,022. ANRITSU COMPANY, MORGAN HILL, CA. FILED 5-22-2000.

LIGHTWARE

FOR REPAIR AND MAINTENANCE OF COMMUNICATIONS SYSTEMS, NAMELY FIBER OPTIC COMMUNICATIONS SYSTEMS (U.S. CLS. 100, 103 AND 106).

SN 76-059,957. ARSIN CORPORATION, SANTA CLARA, CA. FILED 5-30-2000.

EPORTFOLIO

FOR COMPUTER SOFTWARE FOR DATA MANAGEMENT, STORAGE, AND TRANSFER OVER A CORPORATE INTRANET AND GLOBAL COMPUTER NETWORK AND USER MANUALS PACKAGED AS A UNIT THEREWITH (U.S. CLS. 100, 103 AND 106).

SN 76-065,891. DEL WEBB CORPORATION, PHOENIX, AZ. FILED 6-8-2000.

SUN CITY TEXAS

OWNER OF U.S. REG. NOS. 768,006, 2,235,857 AND OTHERS.

NO CLAIM IS MADE TO THE EXCLUSIVE RIGHT TO USE "TEXAS", APART FROM THE MARK AS SHOWN.

FOR PLANNING AND LAYING OUT OF RESIDENTIAL COMMUNITIES, RECREATIONAL FACILITIES, SOCIAL AND COMMUNITY FACILITIES, OFFICE COMPLEXES, SHOPPING CENTERS AND MEETING AND CONVENTION CENTERS; LAND DEVELOPMENT SERVICES; AND CONSTRUCTION SERVICES, NAMELY CONSTRUCTION OF HOMES AND RESIDENCES, RECREATIONAL FACILITIES, SOCIAL AND COMMUNITY FACILITIES AND COMMERCIAL BUILDINGS (U.S. CLS. 100, 103 AND 106).

FIRST USE 3-22-2000; IN COMMERCE 4-23-2000.

CLASS 37—(Continued).

SN 76-080,304. FORD MOTOR COMPANY, DEARBORN, MI. FILED 6-29-2000.

MEROPE

FOR EMERGENCY ROADSIDE ASSISTANCE SERVICES; AUTOMOTIVE REPAIR AND MAINTENANCE SERVICES (U.S. CLS. 100, 103 AND 106).

SN 76-081,016. AVISYS, INC., PLEASANTON, CA. FILED 6-29-2000.

AVISYS

FOR MAINTENANCE AND REPAIR OF AIRCRAFT (U.S. CLS. 100, 103 AND 106).

SN 76-106,106. CARBURETOR SHOP INC., THE, COSTA MESA, CA. FILED 8-10-2000.

THECARBSHOP.COM

SEC. 2(F).
FOR REBUILDING CARBURETORS TO THE ORDER AND SPECIFICATION OF OTHERS (U.S. CLS. 100, 103 AND 106).
FIRST USE 0-0-1966; IN COMMERCE 0-0-1966.

SN 76-110,072. B. ANDREWS & CO., INC., BEL AIR, MD. FILED 8-16-2000.



THE MARK CONSISTS OF A RECTANGLE SURROUNDING DARK BACKGROUND SURROUNDING LETTERS "BAC".
FOR CUSTOM CONSTRUCTION OF NEW RESIDENTIAL HOUSES (U.S. CLS. 100, 103 AND 106).
FIRST USE 2-22-1988; IN COMMERCE 2-22-1988.

CLASS 37—(Continued).

SN 76-139,829. GENERAL ROOFING SERVICES, INC., FT. LAUDERDALE, FL. FILED 10-3-2000.



OWNER OF U.S. REG. NOS. 2,236,757 AND 2,350,706.
NO CLAIM IS MADE TO THE EXCLUSIVE RIGHT TO USE "ROOF CARE, BY" AND "ROOFING", APART FROM THE MARK AS SHOWN.

FOR CONSTRUCTION SERVICES, NAMELY, COMMERCIAL AND RESIDENTIAL ROOF CONSTRUCTION, RENOVATION AND REPAIR (U.S. CLS. 100, 103 AND 106).

SN 76-156,024. CHRISTY REFRACTORIES COMPANY, L.L.C, ST LOUIS, MO. FILED 10-30-2000.



FOR INSTALLATION AND REPAIR SERVICES IN THE FIELD OF REFRACTORIES (U.S. CLS. 100, 103 AND 106).

SN 76-179,776. BG PRODUCTS, INC., WICHITA, KS. FILED 12-12-2000.

MAP

FOR AUTOMOBILE REPAIR AND MAINTENANCE FOR ENHANCING THE AWARENESS OF A VEHICLE'S CONDITION (U.S. CLS. 100, 103 AND 106).

SN 76-226,661. HOUSEKARE SERVICES, INC., BROOKLYN, NY. FILED 3-16-2001.



NO CLAIM IS MADE TO THE EXCLUSIVE RIGHT TO USE "HOUSEKARE", APART FROM THE MARK AS SHOWN.

FOR HOME IMPROVEMENT SERVICES, NAMELY, HOME MAINTENANCE SERVICES, HOME REMODELING SERVICES, HOME REPAIR SERVICES, AND HOME CLEANING SERVICES (U.S. CLS. 100, 103 AND 106).

CLASS 37—(Continued).

SN 76-233,119. CAROLINA DOOR CONTROLS, INC., DURHAM, NC. FILED 4-2-2001.

UNITED DOOR SERVICE

NO CLAIM IS MADE TO THE EXCLUSIVE RIGHT TO USE "DOOR SERVICE", APART FROM THE MARK AS SHOWN.

FOR INSTALLATION, REPAIR AND MAINTENANCE OF DOOR AND DOOR OPENING AND CLOSING EQUIPMENT FOR SWINGING DOORS, SLIDING DOORS AND OTHER AUTOMATICALLY OPENING AND CLOSING DOORS AND COMPONENTS THEREFOR, IN BUILDINGS AND STRUCTURES (U.S. CLS. 100, 103 AND 106).

FIRST USE 7-0-1998; IN COMMERCE 7-0-1998.

SN 76-234,752. TODAY'S AUTOBODY, INC., CHELSEA, MA. FILED 4-4-2001.

TODAY'S COLLISION REPAIR CENTER

NO CLAIM IS MADE TO THE EXCLUSIVE RIGHT TO USE "COLLISION REPAIR CENTER", APART FROM THE MARK AS SHOWN.

FOR AUTOMOTIVE COLLISION REPAIR AND AUTOMOTIVE DETAILING (U.S. CLS. 100, 103 AND 106).

FIRST USE 11-30-1998; IN COMMERCE 2-28-1999.

SN 76-236,177. GENERAL DYNAMICS AVIATION SERVICES CORPORATION, SAVANNAH, GA. FILED 4-5-2001.

GENERAL DYNAMICS AVIATION SERVICES

NO CLAIM IS MADE TO THE EXCLUSIVE RIGHT TO USE "AVIATION SERVICES", APART FROM THE MARK AS SHOWN.

FOR AIRCRAFT REPAIR, REFURBISHMENT AND MAINTENANCE SERVICES (U.S. CLS. 100, 103 AND 106).

FIRST USE 2-16-2001; IN COMMERCE 2-16-2001.

SN 76-248,451. SCOTT, ALIEN, DBA A S DENT SHOP, LUBBOCK, TX. FILED 5-1-2001.

Got A Dent? Get It Out!!!

FOR AUTOMOBILE BODY REPAIR FOR OTHERS (U.S. CLS. 100, 103 AND 106).

FIRST USE 3-0-1995; IN COMMERCE 6-0-1995.

CLASS 37—(Continued).

SN 76-251,729. NORTH ATLANTIC COMMUNICATION SYSTEMS CONSTRUCTION CORPORATION, BOHEMIA, NY. FILED 5-4-2001.

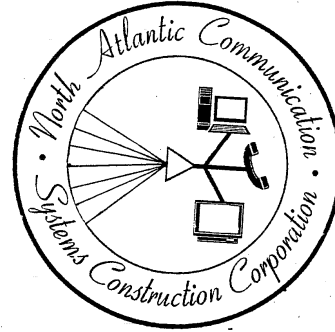

NO CLAIM IS MADE TO THE EXCLUSIVE RIGHT TO USE "COMMUNICATION SYSTEMS CONSTRUCTION COMPANY", APART FROM THE MARK AS SHOWN.

COLOR IS CLAIMED AS FEATURE OF THE MARK. THE MARK CONSISTS OF THE WORDS "NORTH ATLANTIC COMMUNICATION SYSTEMS CONSTRUCTION CORPORATION"; FANCIFUL DESIGNS OF COMPUTER COMPONENTS AND TELEPHONE; AND A SPECTRUM OF LIGHT EMANATING FROM THE SIDE OF THE TRIANGLE WITH COLORS ARRANGED FROM TOP TO BOTTOM AS FOLLOWS: RED, ORANGE, YELLOW, GREEN, BLUE, DARK BLUE/PURPLE. COLOR IS CLAIMED AS A FEATURE OF THE MARK.

FOR CONSTRUCTION SERVICES, NAMELY, INSTALLING CABLES FOR COMPUTER DATA AND VIDEO ON OVERHEAD POLES AND IN EXISTING UNDERGROUND CONDUIT SYSTEMS FOR USE IN OUTSIDE NETWORKS (U.S. CLS. 100, 103 AND 106).

FIRST USE 0-0-1984; IN COMMERCE 0-0-1984.

SN 76-271,728. EXTENDED HOME LIVING SERVICES, INC., WHEELING, IL. FILED 6-15-2001.

CASPAR

FOR CONSTRUCTION SERVICES FOR OLDER ADULTS AND INDIVIDUALS WITH DISABILITIES (U.S. CLS. 100, 103 AND 106).

FIRST USE 4-0-2001; IN COMMERCE 4-0-2001.

CLASS 37—(Continued).

SN 76-276,128. GREEN STREET ENVIRONMENTAL CONSTRUCTION, INC., NEW YORK, NY. FILED 6-22-2001.



THE LOGO ABOVE AND TO THE LEFT OF THE WORDS IS GREEN.

FOR BUILDING CONSTRUCTION AND REPAIR; INSTALLATION OF SOLAR HEATING AND SOLAR ELECTRICITY-GENERATING SYSTEMS; CONSTRUCTION CONTRACTING (U.S. CLS. 100, 103 AND 106).
FIRST USE 2-28-1999; IN COMMERCE 2-28-1999.

SN 76-278,821. THOMAS, PHILLBERT R., FONTANA, CA. AND THOMAS, BETTY M., FONTANA, CA. FILED 6-29-2001.

1-800-FLOODED

FOR RESIDENTIAL AND COMMERCIAL WATER DAMAGE REPAIR AND RESTORATION SERVICES (U.S. CLS. 100, 103 AND 106).
FIRST USE 1-1-1976; IN COMMERCE 1-1-1976.

SN 76-292,360. GARAGE BEYOND, INC., THE, WEST CHICAGO, IL. FILED 8-1-2001.

THE GARAGE BEYOND

NO CLAIM IS MADE TO THE EXCLUSIVE RIGHT TO USE "GARAGE", APART FROM THE MARK AS SHOWN.

FOR INSTALLATION OF GARAGE STORAGE SYSTEMS, NAMELY, SLAT WALL, CABINETS AND SHELVING (U.S. CLS. 100, 103 AND 106).

SN 78-015,132. W.W. GRAINGER, INC., LAKE FOREST, IL. FILED 6-30-2000.



OWNER OF U.S. REG. NOS. 1,559,199, 2,442,470 AND OTHERS.

FOR PROVIDING AN ON-LINE COMPUTER DATABASE IN THE FIELD OF INFORMATION RELATING TO INDUSTRIAL, INSTITUTIONAL, COMMERCIAL AND JANITORIAL EQUIPMENT AND SUPPLIES AND PROVIDING RELEVANT INFORMATION, CONSULTING, AND PROMOTIONAL SERVICES IN CONNECTION THEREWITH (U.S. CLS. 100, 103 AND 106).
FIRST USE 7-17-1998; IN COMMERCE 7-17-1998.

CLASS 37—(Continued).

SN 78-036,123. KARPf, H. SCOTT, OMAHA, NE. FILED 11-21-2000.

"I CAN FIX ANYTHING BUT A BROKEN HEART"

FOR HOME REPAIRS SERVICE (U.S. CLS. 100, 103 AND 106).
FIRST USE 3-1-1991; IN COMMERCE 3-1-1991.

SN 78-068,949. NORTHSTAR HOLDINGS, INC, BOYNTON BEACH, FL. FILED 6-13-2001.

CASCADE ISLES

FOR REAL ESTATE DEVELOPMENT AND CONSTRUCTION OF REAL ESTATE COMMUNITIES (U.S. CLS. 100, 103 AND 106).

SN 78-080,001. PROCTOR ENGINEERING GROUP, LTD., SAN RAFAEL, CA. FILED 8-19-2001.

WE DO THAT

FOR HEATING, VENTILATING, AND AIR CONDITIONING CONTRACTOR SERVICES (U.S. CLS. 100, 103 AND 106).

SN 78-080,474. INSITE REAL ESTATE DEVELOPMENT, L.L.C., OAK BROOK, IL. FILED 8-22-2001.

RESULTS ARE THE ONLY MEASURE OF SUCCESS

FOR COMMERCIAL REAL ESTATE DEVELOPMENT SERVICES (U.S. CLS. 100, 103 AND 106).
FIRST USE 1-1-2000; IN COMMERCE 1-1-2000.

CLASS 37—(Continued).

SN 78-081,352. MURFCO INVESTMENTS, LLC, BIRMINGHAM, AL. FILED 8-28-2001.



NO CLAIM IS MADE TO THE EXCLUSIVE RIGHT TO USE "BUILD AMERICA HOMES LLC", APART FROM THE MARK AS SHOWN.

FOR RESIDENTIAL CONSTRUCTION SERVICES; CUSTOM CONSTRUCTION AND REPAIR OF HOMES (U.S. CLS. 100, 103 AND 106).

FIRST USE 4-1-2001; IN COMMERCE 4-1-2001.

CLASS 38—COMMUNICATION

SN 75-650,817. LCS PAGING, LAMAR, MO. FILED 2-26-1999.

thepagingstore.com



NO CLAIM IS MADE TO THE EXCLUSIVE RIGHT TO USE "THE PAGINGSTORE", APART FROM THE MARK AS SHOWN.

THE DESIGN IS AN IMAGE OF A PAGER IN MOTION WITH THE TRAILING SHADED AREA INDICATION MOTION.

FOR COMMUNICATIONS SERVICES, NAMELY PAGING (U.S. CLS. 100, 101 AND 104).

SN 75-797,496. PENA, MARTIN R., CHAROLLETTE, NC. FILED 9-13-1999.

VISUAL GRAM EXPRESS

NO CLAIM IS MADE TO THE EXCLUSIVE RIGHT TO USE "VISUAL", APART FROM THE MARK AS SHOWN.

FOR TELECOMMUNICATION SERVICES, NAMELY, PROVIDING GLOBAL TELECOMMUNICATION CONNECTIONS TO A COMPUTER NETWORK OF SUBSCRIBERS; PROVIDING COMPUTER AIDED TRANSMISSION OF DATA, IMAGES AND DOCUMENTS ELECTRONICALLY AND THROUGH VIDEO TELECONFERENCING AND REMOTE ACCESS COMPUTING AND VIDEO ON DEMAND TRANSMISSION; PROVIDING COMPUTER AIDED TRANSMISSION OF DATA, IMAGES AND DOCUMENTS ELECTRONICALLY AND THROUGH VIDEO TELECONFERENCING AND REMOTE ACCESS COMPUTING AND VIDEO ON DEMAND TRANSMISSION AS EACH RELATES ALONE OR IN COMBINATION TO THE VISUAL CONFIRMATION OF MONEY TRANSFERS BETWEEN REMOTE PARTIES; AND PROVIDING FRAME RELAY CONNECTIVITY SERVICES (U.S. CLS. 100, 101 AND 104).

CLASS 38—(Continued).

SN 75-828,358. AMERICA ONLINE, INC., DULLES, VA. FILED 10-21-1999.

PLAYLIST2GO

FOR ELECTRONIC TRANSMISSION OF DATA, DOCUMENTS, AND MUSIC OVER GLOBAL COMPUTER NETWORK (U.S. CLS. 100, 101 AND 104).

SN 75-830,560. PHOENIXNET LIMITED, HONG KONG, HONG KONG, FILED 11-13-1999.

SPEEDCAST

FOR PROVIDING MULTIPLE USER ACCESS TO A GLOBAL COMPUTER INFORMATION NETWORK VIA SATELLITE-ENABLED BROADBAND SERVICES (U.S. CLS. 100, 101 AND 104).

SN 75-856,357. BANCO BILBAO VIZCAYA ARGENTARIA S.A., 48005 BILBAO, SPAIN, BY MERGER, BY CHANGE OF NAME BANCO BILBAO VIZCAYA, S.A., 48005 BILBAO, SPAIN, FILED 11-23-1999.

BBVA

PRIORITY CLAIMED UNDER SEC. 44(D) ON SPAIN APPLICATION NO. 2.264.654, FILED 10-19-1999, REG. NO. 2264654-X, DATED 3-7-2000, EXPIRES 3-7-2010.

FOR TELECOMMUNICATION SERVICES, NAMELY ELECTRONIC TRANSMISSION OF MESSAGES AND DATA VIA COMPUTER TERMINALS (U.S. CLS. 100, 101 AND 104).

SN 75-859,565. WWL-TV, INC., NEW ORLEANS, LA. FILED 11-29-1999.

DIGITAL GUMBO

NO CLAIM IS MADE TO THE EXCLUSIVE RIGHT TO USE "DIGITAL", APART FROM THE MARK AS SHOWN.

FOR TELEVISION BROADCASTING (U.S. CLS. 100, 101 AND 104).

FIRST USE 9-13-1999; IN COMMERCE 9-13-1999.

CLASS 38—(Continued).

SN 75-864,132. AMERICATEL CORPORATION, MIAMI, FL. FILED 12-6-1999.

AMERICATEL, SIEMPRE AL SERVICIO DE LOS SALVADOREÑOS

OWNER OF U.S. REG. NOS. 1,892,369, 2,314,651 AND OTHERS.

THE ENGLISH TRANSLATION OF THE WORD "AMERICATEL, SIEMPRE AL SERVICIO DE LOS SALVADOREÑOS" IN THE MARK IS "AMERICATEL, ALWAYS AT THE SERVICE OF THE SALVADORIANS".

FOR ALL TELECOMMUNICATIONS SERVICES, NAMELY, LOCAL, LONG DISTANCE, AND INTERNATIONAL VOICE, TEXT, FACSIMILE, VIDEO, IMAGE, DATA AND WIRELESS TRANSMISSION, VIA SATELLITE, TERRESTRIAL AND UNDERSEA COMMUNICATIONS LINKS; AND PROVIDING CONNECTIONS TO A GLOBAL COMMUNICATIONS NETWORK (U.S. CLS. 100, 101 AND 104).

FIRST USE 11-17-1999; IN COMMERCE 11-17-1999.

SN 75-881,693. TIMECRUISER COMPUTING CORP., FAIRFIELD, NJ. FILED 12-27-1999.

CAMPUSCRUISER

FOR COMPUTER SERVICES, NAMELY PROVIDING ON-LINE CALENDARING SERVICES BY MEANS OF THE INTERNET, ELECTRONIC MAIL SERVICES, PROVIDING ON-LINE ELECTRONIC BULLETIN BOARDS FOR TRANSMISSION OF MESSAGES AMONG COMPUTER USERS CONCERNING ACADEMIC INSTITUTIONS AND COMMUNITIES, CAMPUS LIFE AND CAMPUS EXPERIENCES, PROVIDING ON-LINE CHAT ROOMS FOR TRANSMISSION OF MESSAGES AMONG COMPUTER USERS CONCERNING ACADEMIC INSTITUTIONS AND COMMUNITIES, CAMPUS LIFE AND CAMPUS EXPERIENCES (U.S. CLS. 100, 101 AND 104).

FIRST USE 5-27-1998; IN COMMERCE 5-27-1998.

SN 75-905,974. BANCO BILBAO VIZCAYA ARGENTARIA, S.A., 48005 BILBAO, SPAIN, BY MERGER, BY CHANGE OF NAME BANCO BILBAO VIZCAYA, S.A., 48005 BILBAO, SPAIN, FILED 1-28-2000.



PRIORITY CLAIMED UNDER SEC. 44(D) ON SPAIN APPLICATION NO. 2,282,266, FILED 1-11-2000, REG. NO. 2282266-6, DATED 5-18-2000, EXPIRES 5-18-2010.

THE LINING SHOWN IN THE DRAWING REPRESENTS THE COLOR BLUE WHICH IS A FEATURE OF THE MARK.

THE MARK CONSISTS OF "BBVA" IN COLOR, NAMELY, PANTENE REFLEXIVE BLUE.

FOR TELECOMMUNICATION SERVICES, NAMELY ELECTRONIC TRANSMISSION OF MESSAGES AND DATA VIA COMPUTER TERMINALS (U.S. CLS. 100, 101 AND 104).

CLASS 38—(Continued).

SN 75-912,593. INTELLIBRIDGE CORPORATION, WASHINGTON, DC. BY CHANGE OF NAME NEWMARKET COMPANY, INC., THE, WASHINGTON, DC. FILED 2-9-2000.

INTELLIMEMO

FOR PROVIDING VIRTUAL ROUTING SERVICES, NAMELY THE ELECTRONIC TRANSMISSION OF DOCUMENTS VIA COMPUTER TERMINALS WHICH PERMITS INTERNAL CIRCULATION OF EXTERNALLY-PRODUCED REPORTS WITH COMMENTS (U.S. CLS. 100, 101 AND 104).

SN 76-030,543. PREFERRED VOICE, INC., DALLAS, TX. FILED 4-20-2000.

PREFERRED VOICE

NO CLAIM IS MADE TO THE EXCLUSIVE RIGHT TO USE "VOICE", APART FROM THE MARK AS SHOWN.

FOR TELECOMMUNICATIONS SERVICES, NAMELY, ELECTRONIC TRANSMISSION OF VOICE AND DATA (U.S. CLS. 100, 101 AND 104).

FIRST USE 4-0-1998; IN COMMERCE 4-0-1998.

SN 76-030,545. PREFERRED VOICE, INC., DALLAS, TX. FILED 4-20-2000.

SAFETY*TALK

NO CLAIM IS MADE TO THE EXCLUSIVE RIGHT TO USE "TALK", APART FROM THE MARK AS SHOWN.

FOR TELECOMMUNICATIONS SERVICES, NAMELY, ELECTRONIC TRANSMISSION OF VOICE AND DATA (U.S. CLS. 100, 101 AND 104).

FIRST USE 4-0-1998; IN COMMERCE 4-0-1998.

SN 76-053,890. LIGHTRADE, INC., WASHINGTON, DC. FILED 5-23-2000.

LIGHTRADE

FOR PROVIDING A TELECOMMUNICATIONS BANDWIDTH SWITCHING SERVICE FOR CARRIERS OR BANDWIDTH SERVICE PROVIDERS (U.S. CLS. 100, 101 AND 104).

CLASS 38—(Continued).

SN 76-054,709. FACELINK.COM, SAN JOSE, CA. FILED 5-22-2000.



FOR ELECTRONIC MAIL SERVICES (U.S. CLS. 100, 101 AND 104).

SN 76-061,556. QUICKFLICKS.COM, INC., MARINA DEL REY, CA. FILED 6-2-2000.

STREAMEXCHANGE

FOR ELECTRONIC TRANSMISSION OF VIDEOS VIA A GLOBAL COMPUTER NETWORK (U.S. CLS. 100, 101 AND 104).

SN 76-066,216. NEW TECHNOLOGY HOLDINGS, INC., NEW YORK, NY. FILED 6-8-2000.

PRESSPLAY.COM

FOR ON-DEMAND VIDEO TRANSMISSION SERVICES OF AMATEUR AND HOME VIDEOS VIA A GLOBAL COMPUTER NETWORK (U.S. CLS. 100, 101 AND 104).

SN 76-066,455. GOSHOPWIRELESS.COM, INC., PIEDMONT PINES, CA. FILED 6-8-2000.

VAPORAIR

FOR WIRELESS DIGITAL MESSAGING SERVICES, NAMELY, WIRELESS TRANSFER OF INFORMATION IN THE FORM OF DIGITAL DATA TO A PROVIDER OF ACCESS TO A GLOBAL COMMUNICATION NETWORK (U.S. CLS. 100, 101 AND 104).

SN 76-067,408. GTE SERVICE CORPORATION, DBA VERIZON SERVICES GROUP, IRVING, NY. FILED 6-9-2000.

CYBERVON

FOR TELEPHONE COMMUNICATION SERVICES (U.S. CLS. 100, 101 AND 104).

CLASS 38—(Continued).

SN 76-080,305. FORD MOTOR COMPANY, DEARBORN, MI. FILED 6-29-2000.

MEROPE

FOR PROVIDING MULTI-USER ACCESS TO THE INTERNET; TELECOMMUNICATION SERVICES, NAMELY, TELEPHONE COMMUNICATION SERVICES, ELECTRONIC MAIL SERVICES, PAGING SERVICES, VOICE RECOGNITION SERVICES, TRANSMISSION OF DATA AND MESSAGES VIA SATELLITE RADIO (U.S. CLS. 100, 101 AND 104).

SN 76-080,868. FORD MOTOR COMPANY, DEARBORN, MI. FILED 6-30-2000.

FREEWING

FOR EMERGENCY ROADSIDE ASSISTANCE SERVICES; AUTOMOTIVE REPAIR AND MAINTENANCE SERVICES (U.S. CLS. 100, 101 AND 104).

SN 76-092,344. VERESTAR NETWORKS, INC., SANTA MONICA, CA. BY CHANGE OF NAME INTERPACKET NETWORKS, INC., SANTA MONICA, CA. FILED 7-12-2000.

ESPRESSO VOICE

OWNER OF U.S. REG. NOS. 2,287,919 AND 2,289,101. NO CLAIM IS MADE TO THE EXCLUSIVE RIGHT TO USE "VOICE", APART FROM THE MARK AS SHOWN. FOR PROVIDING MULTIPLE USER ACCESS TO GLOBAL COMPUTER NETWORK AND TELEPHONE SERVICE VIA SATELLITE (U.S. CLS. 100, 101 AND 104). FIRST USE 1-1-2000; IN COMMERCE 1-1-2000.

SN 76-092,639. NEWPATH HOLDINGS, INC., DES MOINES, IA. FILED 7-19-2000.

NEWPATH TELECOM

NO CLAIM IS MADE TO THE EXCLUSIVE RIGHT TO USE "TELECOM", APART FROM THE MARK AS SHOWN. FOR TELECOMMUNICATION SERVICES, NAMELY, DIGITAL SUBSCRIBER LINE SERVICES THAT ARE USED FOR HIGH SPEED DATA TRANSFER FOR GLOBAL COMPUTER NETWORK ACCESS, PRIVATE VIRTUAL CIRCUITS, WEB HOSTING, WEB SOFTWARE SERVERS, LOCAL AREA NETWORKS, WIDE AREA NETWORKS, PRIVATE BRANCH EXCHANGE EXTENSIONS, AND TELECONFERENCING; LOCAL AND TOLL TELEPHONE SERVICES; AND CABLE TELEVISION TRANSMISSION SERVICES (U.S. CLS. 100, 101 AND 104).

CLASS 38—(Continued).

SN 76-102,422. 4.NET, L.L.C., TOWSON, MD. FILED 8-3-2000.

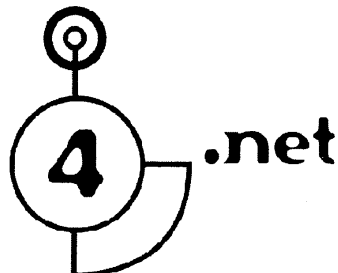

NO CLAIM IS MADE TO THE EXCLUSIVE RIGHT TO USE "NET", APART FROM THE MARK AS SHOWN.

FOR PROVIDING MULTIPLE USER ACCESS TO A GLOBAL COMPUTER NETWORK FOR THE TRANSFER AND DISSEMINATION OF A WIDE RANGE OF INFORMATION IN THE FORM OF TEXT, ELECTRONIC DOCUMENTS, DATABASES, GRAPHICS, AND AUDIOVISUAL INFORMATION, PROVIDING MULTIPLE USER ACCESS TO A GLOBAL COMPUTER NETWORK FOR THE BROWSING, SEARCHING, RETRIEVAL, AND STORAGE OF A WIDE RANGE OF INFORMATION IN THE FORM OF TEXT, ELECTRONIC DOCUMENTS, DATABASES, GRAPHICS AND AUDIOVISUAL INFORMATION (U.S. CLS. 100, 101 AND 104).

FIRST USE 11-8-2000; IN COMMERCE 11-8-2000.

SN 76-111,047. SORENSON MEDIA, INC., SALT LAKE CITY, UT. FILED 8-17-2000.

ONE STOP

FOR STREAMING TRANSMISSION OF LIVE AND ON-DEMAND AUDIO AND VIDEO CONTENT OVER A GLOBAL COMPUTER NETWORK (U.S. CLS. 100, 101 AND 104).

SN 76-118,171. GEMTEK TECHNOLOGY CO., LTD., HSINCHU, TAIWAN, FILED 8-25-2000.

SPARKLAN

FOR ELECTRONIC TRANSMISSION OF MESSAGES AND DATA INFORMATION VIA A TELECOMMUNICATIONS NETWORK; PROVIDING INFORMATION IN THE FIELD OF ELECTRONIC TRANSMISSIONS AND COMMUNICATIONS; PROVIDING AN ON-LINE ELECTRONIC DATABASE ON GLOBAL COMPUTER NETWORKS IN THE FIELD OF ELECTRONIC TRANSMISSIONS; AND ELECTRONIC MAIL SERVICES (U.S. CLS. 100, 101 AND 104).

CLASS 38—(Continued).

SN 76-136,080. ONENAME CORPORATION, SEATTLE, WA. FILED 9-26-2000.

XNS

FOR ELECTRONIC TRANSMISSION OF DATA VIA COMPUTER TERMINALS, NAMELY, DATA COMMUNICATIONS SERVICES WHICH PROVIDE AUTOMATED NAMING, ADDRESSING, NEGOTIATED INTERCHANGE, LINKING AND SYNCHRONIZATION OF DATA VIA AUTOMATED COMMUNICATIONS NETWORKS IN THE NATURE OF THE GLOBAL INTERNET, CORPORATE INTRANETS, WIRELESS TELEPHONE NETWORKS AND OTHER PRIVATE AND PUBLIC COMPUTER NETWORKS (U.S. CLS. 100, 101 AND 104).

SN 76-137,204. NEXTEL COMMUNICATIONS, INC., RESTON, VA. FILED 9-28-2000.

**MORE WAYS THAN ANYONE
TO COMMUNICATE WITH
EVERYONE**

FOR TELECOMMUNICATIONS SERVICES, NAMELY TWO-WAY RADIO DISPATCHING SERVICES, ELECTRONIC TRANSMISSION OF DATA BY MEANS OF TWO-WAY RADIOS, PAGING SERVICES, MOBILE TELEPHONE COMMUNICATION SERVICES; ELECTRONIC TRANSMISSION OF DATA, TEXT, FACSIMILE, VOICE AND VIDEO COMMUNICATION, IMAGES, AND DOCUMENTS VIA TELECOMMUNICATION NETWORKS AND GLOBAL COMPUTER NETWORKS; VIRTUAL NETWORK TELECOMMUNICATIONS SERVICES, NAMELY PROVIDING WIRELESS TELECOMMUNICATIONS CONNECTIONS TO A GLOBAL COMPUTER NETWORK; ELECTRONIC MAIL SERVICES, VOICE MAIL SERVICES AND TELEPHONE VOICE MESSAGING SERVICES; COMPUTER-AIDED TRANSMISSION OF MESSAGES AND IMAGES; AUDIO AND VIDEO TELECONFERENCING SERVICES; PROVIDING TELECOMMUNICATIONS CONNECTIONS TO A GLOBAL COMPUTER NETWORK (U.S. CLS. 100, 101 AND 104).

SN 76-148,883. NETWORK TELEPHONE CORPORATION, PENSACOLA, FL. FILED 10-18-2000.

POWER BROKER

FOR TELECOMMUNICATIONS SERVICES, NAMELY, ELECTRONIC TRANSMISSION OF DATA AND DOCUMENTS VIA COMPUTER TERMINALS, DATA AND VOICE TELECOMMUNICATIONS, DELIVERY OF MESSAGES BY ELECTRONIC TRANSMISSION; ELECTRONIC MAIL SERVICES, ELECTRONIC TRANSMISSION OF FACSIMILE COMMUNICATIONS, PROVIDING MULTI-USER ACCESS TO A GLOBAL COMPUTER INFORMATION NETWORK, AND TELECOMMUNICATIONS SERVICES, NAMELY, ISDN SERVICES, TELECOMMUNICATIONS SERVICES, NAMELY, PERSONAL COMMUNICATIONS, TELEPHONE COMMUNICATIONS SERVICES (U.S. CLS. 100, 101 AND 104).

FIRST USE 10-1-2000; IN COMMERCE 10-1-2000.

CLASS 38—(Continued).

SN 76-156,073. TRAVEL ASSISTANT S.A., PARIS, FRANCE,
FILED 10-30-2000.

GROOMMY

FOR ELECTRONIC MAIL SERVICES AND TRANSMISSION OF INFORMATIONAL DATA AND DOCUMENTS TO THE HOTEL INDUSTRY VIA THE INTERNET, INTERACTIVE TERMINALS AND WEB SERVERS (U.S. CLS. 100, 101 AND 104).

SN 76-171,442. MEGA COMMUNICATIONS L.L.C, SILVER SPRING, MD. FILED 11-28-2000.

LA BUYA

THE ENGLISH TRANSLATION OF "LA BUYA" IS PUERTO RICAN SPANISH SLANG FOR "THE BUZZ OF CONVERSATION".

FOR SPANISH LANGUAGE RADIO BROADCASTING (U.S. CLS. 100, 101 AND 104).

FIRST USE 7-27-2000; IN COMMERCE 7-27-2000.

SN 76-178,328. NETVENTURE, INC., CINCINNATI, OH.
FILED 12-8-2000.

swap@lease.com

FOR COMPUTER SERVICES, NAMELY, PROVIDING AN ON-LINE BULLETIN BOARD OVER A GLOBAL COMPUTER NETWORK FOR THE POSTING OF INFORMATION CONCERNING LEASED AUTOMOTIVE VEHICLES OF OTHERS TO FACILITATE THE TRANSFER OF SUCH LEASES (U.S. CLS. 100, 101 AND 104).

FIRST USE 9-21-2000; IN COMMERCE 9-21-2000.

SN 76-178,329. NETVENTURE, INC., CINCINNATI, OH.
FILED 12-8-2000.

SWAPALEASE

FOR COMPUTER SERVICES, NAMELY, PROVIDING AN ON-LINE BULLETIN BOARD OVER A GLOBAL COMPUTER NETWORK FOR THE POSTING OF INFORMATION CONCERNING LEASED AUTOMOTIVE VEHICLES OF OTHERS TO FACILITATE THE TRANSFER OF SUCH LEASES (U.S. CLS. 100, 101 AND 104).

FIRST USE 9-21-2000; IN COMMERCE 9-21-2000.

CLASS 38—(Continued).

SN 76-231,388. BELO COMPANY, THE, WILMINGTON, DE.
FILED 3-26-2001.

IT'S TIME TO CHOOSE 11 NEWS

NO CLAIM IS MADE TO THE EXCLUSIVE RIGHT TO USE "NEWS", APART FROM THE MARK AS SHOWN.

FOR TELEVISION BROADCASTING SERVICES (U.S. CLS. 100, 101 AND 104).

FIRST USE 8-0-2000; IN COMMERCE 8-0-2000.

SN 76-239,349. INTERNATIONAL TELECOMMUNICATIONS SATELLITE ORGANIZATION, WASHINGTON, DC. FILED 4-12-2001.

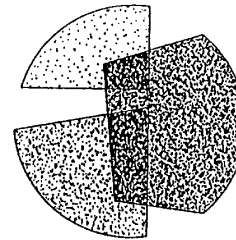

THE STIPPLING IS FOR SHADING PURPOSES ONLY AND DOES NOT INDICATE COLOR.

FOR COMMUNICATIONS SERVICES, NAMELY, TRANSMISSION OF AUDIO, VIDEO, VOICE, IMAGES, AND DATA, VIA SATELLITE (U.S. CLS. 100, 101 AND 104).

FIRST USE 4-11-2001; IN COMMERCE 4-11-2001.

SN 76-239,791. INTERNATIONAL TELECOMMUNICATIONS SATELLITE ORGANIZATION, WASHINGTON, DC. FILED 4-12-2001.

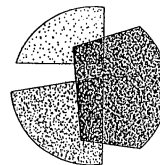

Intelsat

OWNER OF U.S. REG. NO. 1,376,293 AND OTHERS. THE STIPPLING IS FOR SHADING PURPOSES ONLY AND DOES NOT INDICATE COLOR.

FOR COMMUNICATIONS SERVICES, NAMELY, TRANSMISSION OF AUDIO, VIDEO, VOICE, IMAGES, AND DATA, VIA SATELLITE (U.S. CLS. 100, 101 AND 104).

FIRST USE 4-11-2001; IN COMMERCE 4-11-2001.

CLASS 38—(Continued).

SN 76-257,365. O2 HOLDINGS, LLC, NEW YORK, NY. FILED 5-14-2001.

LOUDER THAN WORDS

FOR PROVIDING ON-LINE INTERACTIVE COMMUNITY FORUMS, ON-LINE ELECTRONIC BULLETIN BOARDS, ON-LINE CHAT ROOMS AND E-MAIL ACCESS FOR TRANSMISSION OF MESSAGES AMONG COMPUTER USERS CONCERNING INFORMATION RELATING TO A MULTI-MEDIA AND GRASSROOTS CAMPAIGN TO INCREASE THE NUMBER OF WOMEN SERVING IN LEADERSHIP POSITIONS AT COMMUNITY, LOCAL, STATE AND NATIONAL LEVELS (U.S. CLS. 100, 101 AND 104).

SN 78-018,707. SNAPTEXT.COM INC., MINNEAPOLIS, MN. FILED 7-27-2000.

SNAPTEXT.COM

FOR ELECTRONIC TRANSMISSION OF DATA AND DOCUMENTS VIA COMPUTER TERMINALS, NAMELY ELECTRONIC TEXTS FOR BUSINESS (U.S. CLS. 100, 101 AND 104).

SN 78-035,219. SHOWTIME NETWORKS INC., NEW YORK, NY. FILED 11-14-2000.

SHO WOMEN

OWNER OF U.S. REG. NOS. 1,075,211, 2,180,434 AND OTHERS.

NO CLAIM IS MADE TO THE EXCLUSIVE RIGHT TO USE "WOMEN", APART FROM THE MARK AS SHOWN.

FOR TELECOMMUNICATION SERVICES, NAMELY, CABLE, CABLE RADIO AND SATELLITE TRANSMISSION SERVICES RENDERED THROUGH THE MEDIUMS OF TELEVISION, CABLE TELEVISION AND SATELLITE DELIVERED SYSTEMS IN THE HIGH-DEFINITION FORMAT (U.S. CLS. 100, 101 AND 104).

SN 78-056,636. NOS COMMUNICATIONS, INC., LAS VEGAS, NV. FILED 4-3-2001.

CIERRACOM SYSTEMS

NO CLAIM IS MADE TO THE EXCLUSIVE RIGHT TO USE "SYSTEMS", APART FROM THE MARK AS SHOWN.

FOR TELECOMMUNICATIONS SERVICES, NAMELY, THE ELECTRONIC TRANSMISSION OF VOICE, DATA, FACSIMILE, VIDEO AND INFORMATION (U.S. CLS. 100, 101 AND 104).

CLASS 38—(Continued).

SN 78-057,839. SHOWTIME NETWORKS INC., NEW YORK, NY. FILED 4-11-2001.

CLOTHES ENCOUNTERS

FOR TELECOMMUNICATION SERVICES, NAMELY, CABLE TELEVISION, CABLE RADIO AND SATELLITE TRANSMISSION SERVICES RENDERED THROUGH THE MEDIUMS OF TELEVISION, CABLE TELEVISION AND SATELLITE DELIVERED SYSTEMS IN THE HIGH-DEFINITION FORMAT (U.S. CLS. 100, 101 AND 104).

SN 78-062,467. AT&T CORP., NEW YORK, NY. FILED 5-8-2001.

ATT

OWNER OF U.S. REG. NOS. 1,293,305, 1,970,579 AND 2,110,288.

FOR TELECOMMUNICATIONS SERVICES, NAMELY, LOCAL, LONG DISTANCE, AND INTERNATIONAL VOICE, TEXT, FACSIMILE, VIDEO AND DATA TELECOMMUNICATION SERVICES; FRAME RELAY TELECOMMUNICATIONS SERVICES; VIRTUAL NETWORK TELECOMMUNICATIONS SERVICES; ELECTRONIC MAIL AND VOICE MAIL AND MESSAGING SERVICES; ELECTRONIC DATA TRANSMISSION PACKET SERVICES; COMPUTER AIDED TRANSMISSION OF MESSAGES AND IMAGES; AUDIO AND VIDEO TELECONFERENCING SERVICES; PRIVATE LINE VOICE, TEXT, FACSIMILE, VIDEO AND DATA TELECOMMUNICATIONS SERVICES; INTEGRATED SERVICES DIGITAL NETWORK (ISDN) TELECOMMUNICATIONS SERVICES; TRANSMISSION OF VOICE, TEXT, FACSIMILE, VIDEO AND DATA VIA SATELLITE, TERRESTRIAL AND UNDERSEA TELECOMMUNICATIONS LINKS; TELEVISION TRANSMISSION SERVICES; 800 TELECOMMUNICATIONS SERVICES; 900 TELECOMMUNICATIONS SERVICES; SWITCHED VOICE, DATA, VIDEO AND MULTIMEDIA SERVICES; LOCATION INDEPENDENT PERSONAL COMMUNICATIONS SERVICES COMPRISING MOBILE VOICE, DATA AND FACSIMILE SERVICES; DIGITAL SUBSCRIBER LINE (DSL) TELECOMMUNICATIONS SERVICES; PROVIDING TELECOMMUNICATIONS CONNECTIONS TO WORLDWIDE GLOBAL COMPUTER NETWORKS, OTHER COMPUTER NETWORKS, ON-LINE SERVICES AND BULLETIN BOARDS; PROVIDING BACK BONE TELECOMMUNICATIONS NETWORK SERVICES TO OTHERS TO ENABLE THEM TO DISPLAY CONTENT ON WORLDWIDE GLOBAL COMPUTER NETWORKS AND OTHER COMPUTER NETWORKS, ON-LINE SERVICES AND BULLETIN BOARDS; PROVIDING TELECOMMUNICATIONS CONNECTIONS TO ON-LINE INFORMATION SERVICES; THE TRANSMISSION OVER CABLE OF ENTERTAINMENT SERVICES AND VOICE, VIDEO, DATA AND FACSIMILE TELEPHONE SERVICES; WIRELESS TELECOMMUNICATIONS SERVICES, NAMELY, WIRELESS CELLULAR TELEPHONE SERVICES, WIRELESS DIGITAL MESSAGING SERVICES AND WIRELESS FACSIMILE MAIL SERVICES; PROVIDING AND FACILITATING CONNECTIONS TO TELECOMMUNICATIONS SERVICES, NAMELY, PROVIDING TELECOMMUNICATIONS CONNECTIONS TO LOCAL AND LONG DISTANCE TELEPHONE SERVICES OF OTHERS BY ELECTRONIC MEANS, NAMELY, PROVIDING ACCESS TO AN ELECTRONIC DATA BASE THROUGH A GLOBAL COMPUTER NETWORK; PROVIDING ON-LINE CHAT ROOMS FOR TRANSMISSION OF MESSAGES AMONG COMPUTER USERS CONCERNING A WIDE VARIETY OF TOPICS (U.S. CLS. 100, 101 AND 104).

CLASS 38—(Continued).

SN 78-065,611. SHOWTIME NETWORKS INC., NEW YORK, NY. FILED 5-24-2001.

SHOWTIME BOXING: THE NEW GENERATION

OWNER OF U.S. REG. NOS. 1,075,211, 2,180,434 AND OTHERS.

NO CLAIM IS MADE TO THE EXCLUSIVE RIGHT TO USE "BOXING", APART FROM THE MARK AS SHOWN.

FOR TELECOMMUNICATION SERVICES, NAMELY, CABLE TELEVISION, CABLE RADIO AND SATELLITE TRANSMISSION SERVICES RENDERED THROUGH THE MEDIUMS OF TELEVISION, CABLE TELEVISION AND SATELLITE DELIVERED SYSTEMS IN THE HIGH-DEFINITION FORMAT (U.S. CLS. 100, 101 AND 104).

SN 78-074,660. CLEAR RATE COMMUNICATIONS, OAK PARK, MI. FILED 7-19-2001.

CLEAR RATE

FOR TELECOMMUNICATION SERVICES, NAMELY, TRANSMISSION OF VOICE, MESSAGES, AND DATA (U.S. CLS. 100, 101 AND 104).

FIRST USE 7-1-2001; IN COMMERCE 7-10-2001.

SN 78-080,480. BELL SOUTH INTELLECTUAL PROPERTY CORPORATION, WILMINGTON, DE. FILED 8-22-2001.

STATE TALK ADVANTAGE

OWNER OF U.S. REG. NO. 2,279,666. NO CLAIM IS MADE TO THE EXCLUSIVE RIGHT TO USE "TALK", APART FROM THE MARK AS SHOWN.

FOR LONG DISTANCE COMMUNICATION SERVICES (U.S. CLS. 100, 101 AND 104).

CLASS 39—TRANSPORTATION AND STORAGE

SN 75-354,375. GLOBALIA CORPORATION EMPRESARIAL, S.A., MALLORCA, SPAIN, BY CHANGE OF NAME; BY ASSIGNMENT AIR ESPANA, S.A., 07009 PALMA DE MALLORCA, SPAIN, FILED 9-10-1997.

air europa

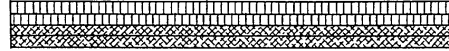

NO CLAIM IS MADE TO THE EXCLUSIVE RIGHT TO USE "AIR EUROPA", APART FROM THE MARK AS SHOWN.

THE BANDS BELOW THE WORDS "AIR EUROPA" REPRESENT FOUR DISTINCT COLORS IN THE RED TO ORANGE PART OF THE SPECTRUM, WITH THE TWO UPPERMOST BANDS BEING SHADES OF RED AND THE TWO LOWERMOST BANDS BEING SHADES OF ORANGE.

THE ENGLISH TRANSLATION OF "AIR EUROPA" IS "AIR EUROPE".

FOR AIR TRANSPORT SERVICES OF PEOPLE AND GOODS (U.S. CLS. 100 AND 105).

SN 75-560,060. AIRNOMICS, INC., TORONTO, ONTARIO M5J-257, CANADA, FILED 12-12-1997.

BRANIFF

FOR TRANSPORTATION OF PERSONS, PROPERTY AND MAIL BY AIR (U.S. CLS. 100 AND 105).

SN 75-832,492. CUNARD LINE LIMITED, MIAMI, FL. FILED 10-27-1999.

SEABOURN SPIRIT

OWNER OF U.S. REG. NOS. 2,147,466 AND 2,167,162. SEC. 2(F) AS TO "SEABOURN".

FOR CRUISE SHIP SERVICES EXCLUDING HARBOR AND WHALE WATCH CRUISES (U.S. CLS. 100 AND 105).

FIRST USE 11-0-1989; IN COMMERCE 11-0-1989.

CLASS 39—(Continued).

SN 75-917,162. DEMOPOULOS, ANDREW, HICKSVILLE, NY. FILED 2-11-2000.



NO CLAIM IS MADE TO THE EXCLUSIVE RIGHT TO USE "ADVANCED DATA SERVICES", APART FROM THE MARK AS SHOWN.

FOR LETTER SHOP AND FULFILLMENT SERVICES, NAMELY, POSTAL SERVICES, NAMELY, PACKAGING ARTICLES FOR TRANSPORTATION, PARCEL DELIVERY, AND RENTALS OF MAILBOXES (U.S. CLS. 100 AND 105).

SN 76-009,447. COSTCO WHOLESALE MEMBERSHIP, INC., ISSAQUAH, WA. BY ASSIGNMENT PRICE COMPANY, THE, ISSAQUAH, WA. FILED 3-24-2000.

GOLD STAR

OWNER OF U.S. REG. NOS. 1,405,770, 2,045,634 AND 2,066,457.

FOR TRAVEL AGENCY SERVICES, NAMELY, MAKING RESERVATIONS AND BOOKINGS FOR TRANSPORTATION; ARRANGING TRAVEL TOURS; TRAVEL BOOKINGS AGENCIES (U.S. CLS. 100 AND 105).
FIRST USE 12-20-1985; IN COMMERCE 12-20-1985.

SN 76-016,869. NEOPOST INC., HAYWARD, CA. FILED 4-4-2000.

PCMAIL

FOR SHIPPING SERVICES, NAMELY, PROVIDING INFORMATION ABOUT ALL OF THE FOLLOWING - HOW TO PACKAGE GOODS FOR SAFE SHIPMENT, SHIPPING PROCESS MECHANICS, COMPARATIVE POSTAGE AND SHIPPING RATE INFORMATION, ZIP CODE INFORMATION, PROVISION OF SHIPPING DOCUMENTATION, ADDRESSING AND TRACKING OF SHIPMENT DELIVERY CONFIRMATION TO SENDER AND DELIVERY NOTIFICATION TO RECIPIENT, ACCEPTING PACKAGES FOR SHIPMENT BY COMMON CARRIER, VERIFICATION OF SHIPPING PARTICULARS (WEIGHT, SIZE, ADDRESSEES, ETC), UTILIZING GLOBAL COMPUTER NETWORKS (U.S. CLS. 100 AND 105).

CLASS 39—(Continued).

SN 76-027,451. MCCOLLUM, ROBERT W., JOHNSON CITY, TN. FILED 4-13-2000.



NO CLAIM IS MADE TO THE EXCLUSIVE RIGHT TO USE "WATERPROFESSIONAL.COM", APART FROM THE MARK AS SHOWN.

FOR BOTTLED WATER DELIVERY SERVICES FOR RESIDENTIAL AND COMMERCIAL ESTABLISHMENTS (U.S. CLS. 100 AND 105).
FIRST USE 2-28-2000; IN COMMERCE 2-28-2000.

SN 76-060,256. PARK AND COMPANY MARKETING COMMUNICATIONS, INC., PHOENIX, AZ. FILED 5-31-2000.

WATER USE IT WISELY

FOR PROMOTION PUBLIC AWARENESS OF THE NEED FOR CONSERVATION IN WATER DISTRIBUTION AND USE (U.S. CLS. 100 AND 105).
FIRST USE 10-1-1998; IN COMMERCE 10-1-1998.

SN 76-069,447. STANFIELD HOSPITALITY CONSULTANTS, LLC, HENDERSONVILLE, TN. FILED S.R. 6-15-2000; AM. P.R. 8-29-2001.



NO CLAIM IS MADE TO THE EXCLUSIVE RIGHT TO USE "HOSPITALITY CONSULTANTS, LLC", APART FROM THE MARK AS SHOWN.

FOR CONSULTING SERVICES TO THE TRAVEL INDUSTRY (U.S. CLS. 100 AND 105).
FIRST USE 1-4-1999; IN COMMERCE 1-4-1999.

SN 76-075,282. RENT-A-TIRE, INC., FORT WORTH, TX. FILED 6-21-2000.



OWNER OF U.S. REG. NO. 2,130,062.
NO CLAIM IS MADE TO THE EXCLUSIVE RIGHT TO USE "RENT A TIRE" AND "NEW TIRES RIMS PAY WEEKLY", APART FROM THE MARK AS SHOWN.
FOR RENTAL OF VEHICLE WHEELS AND TIRES (U.S. CLS. 100 AND 105).
FIRST USE 3-23-2000; IN COMMERCE 3-23-2000.

CLASS 39—(Continued).

SN 76-079,565. LTA GROUP, INC., THE, JAMESBURG, NJ. FILED 6-28-2000.

PASSPORT LOGISTICS

NO CLAIM IS MADE TO THE EXCLUSIVE RIGHT TO USE "LOGISTICS", APART FROM THE MARK AS SHOWN. FOR CONTAINER FREIGHT STATION SERVICES, NAMELY, PROVIDING A FACILITY FOR RECEIVING OCEAN CONTAINERS WITH CARGO FOR MULTIPLE CONSIGNEES AND SEGREGATING THE CARGO ACCORDING TO CONSIGNEE; BONDED WAREHOUSE STORAGE SERVICES; EXPORT CONSOLIDATION SERVICES, NAMELY, CONSOLIDATION OF MULTIPLE SHIPMENTS OF CARGO INTO OCEAN CONTAINERS FOR OVERSEAS SHIPMENT; TRANSPORTATION OF FREIGHT BY TRUCK (U.S. CLS. 100 AND 105).

SN 76-086,109. REVOLUTION REPLACEMENT RENTALS INCORPORATED, WORCESTER, MA. FILED 7-10-2000.



NO CLAIM IS MADE TO THE EXCLUSIVE RIGHT TO USE "RENT-A-CAR", APART FROM THE MARK AS SHOWN. FOR AUTOMOBILE RENTAL SERVICE (U.S. CLS. 100 AND 105). FIRST USE 10-13-1998; IN COMMERCE 9-10-1999.

SN 76-100,405. CORTRANS LOGISTICS, LLC, NORCROSS, GA. FILED 7-31-2000.



NO CLAIM IS MADE TO THE EXCLUSIVE RIGHT TO USE "LOGISTICS, LLC", APART FROM THE MARK AS SHOWN. FOR FREIGHT TRANSPORTATION BY TRUCK AND AIR (U.S. CLS. 100 AND 105). FIRST USE 2-8-1999; IN COMMERCE 3-1-1999.

CLASS 39—(Continued).

SN 76-113,107. AAA AIR EXPRESS OF MIAMI, LTD., NEW HYDE PARK, NY. FILED 8-21-2000.

AAA AIR EXPRESS

NO CLAIM IS MADE TO THE EXCLUSIVE RIGHT TO USE "AIR EXPRESS", APART FROM THE MARK AS SHOWN.

FOR TRANSPORTATION SERVICES NAMELY OF TRANSPORTATION OF FREIGHT BY AIR AND TRUCK (U.S. CLS. 100 AND 105).

FIRST USE 3-1-1974; IN COMMERCE 3-1-1974.

SN 76-167,735. FORBES, DAVID C., AUSTIN, TX. FILED 11-16-2000.

PIZZA BEAR

NO CLAIM IS MADE TO THE EXCLUSIVE RIGHT TO USE "PIZZA", APART FROM THE MARK AS SHOWN. FOR PIZZA DELIVERY BUSINESS (U.S. CLS. 100 AND 105).

SN 76-168,647. FEDEX CUSTOM CRITICAL, INC., AKRON, OH. FILED 11-20-2000.

PASSPORT TRANSPORT

NO CLAIM IS MADE TO THE EXCLUSIVE RIGHT TO USE "TRANSPORT", APART FROM THE MARK AS SHOWN.

FOR FREIGHT TRANSPORTATION SERVICES THAT FEATURE THE TRANSPORT OF AUTOMOBILES BY TRUCK (U.S. CLS. 100 AND 105).

FIRST USE 1-1-1970; IN COMMERCE 1-1-1970.

SN 76-185,952. 3735231 CANADA INC., MONTREAL, QUEBEC, CANADA, FILED 12-22-2000.

YOU-PICKUP

FOR PROVIDING ONLINE SERVICES WHICH AFFORD CUSTOMERS THE ABILITY TO SELECT A DISTRIBUTION POINT FOR GOODS PURCHASED ON THE INTERNET, VIA A GLOBAL COMMUNICATIONS NETWORK (U.S. CLS. 100 AND 105).

SN 76-185,956. 3735231 CANADA INC., MONTREAL, QUEBEC H3B 4G7, CANADA, FILED 12-22-2000.

U-PICKUP

FOR PROVIDING ONLINE SERVICES WHICH AFFORD CUSTOMERS THE ABILITY TO SELECT A DISTRIBUTION POINT FOR GOODS PURCHASED ON THE INTERNET, VIA A GLOBAL COMMUNICATIONS NETWORK (U.S. CLS. 100 AND 105).

CLASS 39—(Continued).

SN 76-189,659. BURKY, WERNER G, CHARLESTON, SC. FILED 1-5-2001.

TURKY'S

FOR TOWING AND STORAGE OF DISABLED AND WRECKED VEHICLES; TRANSPORTATION OF DISABLED AND WRECKED VEHICLES BY TRUCK (U.S. CLS. 100 AND 105).
FIRST USE 8-1-1976; IN COMMERCE 8-1-1976.

CLASS 39—(Continued).

SN 76-230,595. COLONIAL PARKING, INC., WASHINGTON, DC. FILED 3-26-2001.



OWNER OF U.S. REG. NO. 2,417,432.
NO CLAIM IS MADE TO THE EXCLUSIVE RIGHT TO USE "PARKING", APART FROM THE MARK AS SHOWN.
FOR PARKING LOT SERVICES (U.S. CLS. 100 AND 105).
FIRST USE 0-0-1990; IN COMMERCE 0-0-1990.

SN 76-213,371. MID-AMERICA OVERSEAS, INC., ITASCA, IL. FILED 2-21-2001.

TRAC-PRO

FOR PROVIDING TRANSPORTATION INFORMATION VIA A GLOBAL COMPUTER NETWORK, NAMELY, PROVIDING CURRENT AND HISTORICAL SHIPMENT INFORMATION TO CUSTOMERS OF FREIGHT FORWARDERS REGARDING SHIPMENTS ARRANGED BY FREIGHT FORWARDERS (U.S. CLS. 100 AND 105).
FIRST USE 2-1-2000; IN COMMERCE 2-1-2000.

SN 76-256,177. LEFKOWITZ, YISROEL, BROOKLYN, NY. FILED 5-11-2001.

DUTY FREE VACATIONS

FOR TRAVEL AGENCY SERVICES, NAMELY, MAKING RESERVATIONS AND BOOKINGS FOR TRANSPORTATION (U.S. CLS. 100 AND 105).

SN 76-216,761. MANAGEDSTORAGE INTERNATIONAL, INC., WESTMINSTER, CO. FILED 2-27-2001.

GRIDBAK

FOR ELECTRONIC DATA STORAGE SERVICES (U.S. CLS. 100 AND 105).

SN 76-272,784. SUNTORY WATER GROUP, INC., ATLANTA, GA. FILED 6-18-2001.

SN 76-220,278. CITY EXPRESS, INC., BOSTON, MA. FILED 3-5-2001.

EXECUTIVE POUCH

FOR OVERNIGHT COURIER AND DELIVERY BY LAND AND AIR OF DOCUMENTS, PACKAGES AND PARCELS OF OTHERS (U.S. CLS. 100 AND 105).

DELIVERING GOOD HEALTH DIRECT TO YOUR DOOR

FOR HOME DELIVERY OF BOTTLED DRINKING WATER (U.S. CLS. 100 AND 105).

CLASS 39—(Continued).

SN 76-285,391. FIRST GENETIC TRUST, INC., DEERFIELD, IL. FILED 7-13-2001.



NO CLAIM IS MADE TO THE EXCLUSIVE RIGHT TO USE "GENETIC", APART FROM THE MARK AS SHOWN. FOR GENETIC BANKING SERVICES, NAMELY, STORAGE OF DNA MATERIAL, BLOOD AND OTHER TISSUES FOR MEDICAL DIAGNOSTICS, IDENTITY TESTING, AND DNA EXTRACTION AND ANALYSIS (U.S. CLS. 100 AND 105).

SN 78-012,625. EINTERCONNECT CENTERS, INC., IRVING, TX. FILED 6-14-2000.

EINTERCONNECT CENTERS

NO CLAIM IS MADE TO THE EXCLUSIVE RIGHT TO USE "CENTERS", APART FROM THE MARK AS SHOWN. FOR STORAGE OF, AND RENTAL OF STORAGE SPACE FOR, TELECOMMUNICATIONS EQUIPMENT, INCLUDING PROVIDING CLIMATE CONTROL AND AN UNINTERRUPTED POWER SUPPLY FOR SUCH EQUIPMENT (U.S. CLS. 100 AND 105).

SN 78-018,406. EZ2PLAN, MANHATTAN BEACH, CA. FILED 7-26-2000.

EZ2PLAN

FOR TRAVEL INFORMATION SERVICE, NAMELY, MATCHING CUSTOMERS WITH TRAVEL AGENCIES FOR BOOKING TRAVEL PLANS OVER THE INTERNET (U.S. CLS. 100 AND 105).
FIRST USE 11-29-1999; IN COMMERCE 7-6-2000.

SN 78-055,743. AMERICAN AUTOMOBILE ASSOCIATION, INC., HEATHROW, FL. FILED 3-29-2001.

TRIPTIK

OWNER OF U.S. REG. NOS. 652,420 AND 656,930.
FOR PROVIDING TRAVEL INFORMATION IN THE NATURE OF ROUTING DIRECTIONS AND CUSTOMIZED STRIP MAP IMAGES VIA AN ELECTRONIC COMMUNICATIONS NETWORK (U.S. CLS. 100 AND 105).

CLASS 39—(Continued).

SN 78-077,008. RAMEY-JOHNSON, CATHY, N., FAIR LAWN, NJ. FILED 8-2-2001.

**THE EYES OF A TOURIST
AND THE HEART OF A
NATIVE**

FOR ARRANGING TRAVEL TOURS, TRAVEL GUIDES SERVICES AND TRAVEL BOOKINGS (U.S. CLS. 100 AND 105).
FIRST USE 5-18-2001; IN COMMERCE 5-18-2001.

SN 78-078,007. MANAGEDSTORAGE INTERNATIONAL, INC., WESTMINSTER, CO. FILED 8-7-2001.

GRIDCONTROL

FOR ELECTRONIC DATA STORAGE SERVICES (U.S. CLS. 100 AND 105).

CLASS 40—MATERIAL TREATMENT

SN 75-833,598. M. COHEN AND SONS, INC., BROOMALL, PA. FILED 10-28-1999.

IRON SHOP CUSTOM

OWNER OF U.S. REG. NO. 2,391,386.
NO CLAIM IS MADE TO THE EXCLUSIVE RIGHT TO USE "CUSTOM", APART FROM THE MARK AS SHOWN. SEC. 2(F).
FOR CUSTOM MANUFACTURE OF METAL AND WOODEN STAIRCASES (U.S. CLS. 100, 103 AND 106).
FIRST USE 9-13-1999; IN COMMERCE 9-13-1999.

SN 76-009,446. COSTCO WHOLESALE MEMBERSHIP, INC., ISSAQUAH, WA. BY ASSIGNMENT PRICE COMPANY, THE, ISSAQUAH, WA. FILED 3-24-2000.

GOLD STAR

OWNER OF U.S. REG. NOS. 1,405,770, 2,045,634 AND 2,066,457.
FOR PHOTOGRAPHIC FILM DEVELOPING; GRINDING AND TINTING OPTICAL LENSES; CUSTOM MANUFACTURE OF RUBBER STAMPS (U.S. CLS. 100, 103 AND 106).
FIRST USE 5-3-1985; IN COMMERCE 5-3-1985.

CLASS 40—(Continued).

SN 76-032,680. EMOTION, INC., VIENNA, VA. FILED 4-25-2000.

Powering Productivity

FOR ELECTRONIC IMAGING, SCANNING, DIGITIZING, ALTERATION AND/OR RETOUCHING OF STOCK PHOTOGRAPHY, FOOTAGE AND TEXT (U.S. CLS. 100, 103 AND 106).

FIRST USE 2-0-2000; IN COMMERCE 3-0-2000.

SN 76-034,025. VAN GELDER, IAN J., CARSON CITY, NV. FILED 4-25-2000.

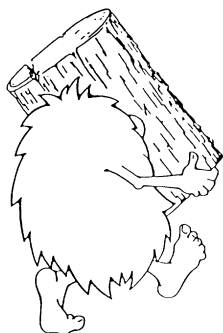

FOR CUSTOM MANUFACTURING OF WOODS SPLITTERS, CONVEYORS, AND WASTE COMPACTORS TO THE ORDER AND/OR SPECIFICATION OF OTHERS (U.S. CLS. 100, 103 AND 106).

FIRST USE 12-31-1986; IN COMMERCE 12-31-1986.

SN 76-118,775. METROGEN LLC, POTOMAC, MD. FILED 8-29-2000.

METROGEN LLC

NO CLAIM IS MADE TO THE EXCLUSIVE RIGHT TO USE "LLC", APART FROM THE MARK AS SHOWN.

FOR PRODUCTION OF ELECTRICITY (U.S. CLS. 100, 103 AND 106).

FIRST USE 11-0-2000; IN COMMERCE 11-0-2000.

CLASS 40—(Continued).

SN 76-150,086. ENGINEERED MATERIALS SOLUTIONS, INC., ATTLEBORO, MA. FILED 10-19-2000.

ENGINEERED MATERIALS SOLUTIONS, INC.

NO CLAIM IS MADE TO THE EXCLUSIVE RIGHT TO USE "ENGINEERED MATERIALS" AND "INC.", APART FROM THE MARK AS SHOWN.

FOR CUSTOM MANUFACTURE OF CLAD METALS AND BIMETAL STRIPS AND SHEETS FOR USE IN MANUFACTURE OF FINISHED PRODUCTS; CUSTOM MANUFACTURE OF ELECTRICAL CONTACTS (U.S. CLS. 100, 103 AND 106).

SN 76-159,546. OFF THE WALL PRODUCTIONS LTD., REGINA, SASKATCHEWAN, CANADA, FILED 11-3-2000.

OFF THE WALL PRODUCTIONS LTD.

NO CLAIM IS MADE TO THE EXCLUSIVE RIGHT TO USE "PRODUCTIONS LTD.", APART FROM THE MARK AS SHOWN.

FOR CUSTOM MANUFACTURE OF PROPS, BACK-GROUNDS, ACCESSORIES, AND SYSTEMS FOR THE CREATION OF A PORTABLE SCENIC ENVIRONMENT (U.S. CLS. 100, 103 AND 106).

FIRST USE 6-1-1993; IN COMMERCE 6-1-1994.

SN 76-160,841. SKYCROSS, INC., MAITLAND, FL. FILED 11-8-2000.

SKYCROSS

FOR MANUFACTURE OF GENERAL PRODUCT LINES IN THE FIELD OF ANTENNAS FOR MOBILE AND FIXED COMMUNICATION DEVICES TO THE ORDER AND SPECIFICATION OF OTHERS (U.S. CLS. 100, 103 AND 106).

FIRST USE 8-15-2000; IN COMMERCE 8-15-2000.

SN 76-189,754. ENGINEERED MATERIALS SOLUTIONS, INC., ATTLEBORO, MA. FILED 1-4-2001.



Engineered Materials Solutions

NO CLAIM IS MADE TO THE EXCLUSIVE RIGHT TO USE "ENGINEERED MATERIALS", APART FROM THE MARK AS SHOWN.

FOR CUSTOM MANUFACTURE OF CLAD METALS AND BIMETAL STRIPS AND SHEETS FOR USE IN MANUFACTURE OF FINISHED PRODUCTS; CUSTOM MANUFACTURE OF ELECTRICAL CONTACTS (U.S. CLS. 100, 103 AND 106).

CLASS 40—(Continued).

SN 76-190,445. SOLIDSFLOW, INC., FORT MILL, SC. FILED 1-8-2001.



FOR MANUFACTURE OF GENERAL PRODUCT LINES IN THE FIELD OF VIBRATORY FEEDERS, SCREW FEEDERS, WEIGHBELT FEEDERS, AND MATERIAL HANDLING EQUIPMENT FOR THE DRY BULK SOLIDS INDUSTRY TO THE ORDER AND SPECIFICATIONS OF OTHERS (U.S. CLS. 100, 103 AND 106).

FIRST USE 1-1-1997; IN COMMERCE 1-1-1997.



SN 76-219,598. ALIEN TECHNOLOGY CORPORATION, HAYWARD, CA. FILED 3-5-2001.

ALIEN TECHNOLOGY

NO CLAIM IS MADE TO THE EXCLUSIVE RIGHT TO USE "TECHNOLOGY", APART FROM THE MARK AS SHOWN.

FOR CUSTOM MANUFACTURING FOR OTHERS OF CIRCUITS, MICRO-ELECTRO-MECHANICAL-MACHINES (MEMS), ELECTRONIC SENSORS, PHOTONIC DEVICES, ELECTRO-OPTICAL DEVICES, IMAGE PROCESSING DEVICES; ELECTRONIC AND RADIO FREQUENCY TRANSMITTERS, RECEIVERS AND SIGNAL PROCESSORS; AND RADIO FREQUENCY IDENTIFICATION AND INVENTORY TAGS (U.S. CLS. 100, 103 AND 106).



SN 76-256,198. PIXEL DITTIS LLC, DENVER, CO. FILED 5-11-2001.

PIXEL DITTIS

NO CLAIM IS MADE TO THE EXCLUSIVE RIGHT TO USE "PIXEL", APART FROM THE MARK AS SHOWN.

FOR DIGITAL IMAGING SERVICES (U.S. CLS. 100, 103 AND 106).



SN 76-308,929. LION APPAREL, INC., DAYTON, OH. FILED 9-5-2001.

TOTALCARE

FOR CUSTOM MANUFACTURE OF FIREFIGHTERS' PROTECTIVE CLOTHING AND HELMETS (U.S. CLS. 100, 103 AND 106).

CLASS 40—(Continued).

SN 78-002,687. HAN-YEI, INC., ZANESVILLE, OH. FILED 4-5-2000.



HAN-YEI, INC.

NO CLAIM IS MADE TO THE EXCLUSIVE RIGHT TO USE "INC." AND THE PICTORIAL REPRESENTATION OF THE GLOBE, APART FROM THE MARK AS SHOWN.

THE ENGLISH TRANSLATION OF "HAN-YEI" IS "GROWING BIGGER".

FOR CUSTOM MANUFACTURING OF COATING MATERIALS FOR USE IN THE AUTOMOBILE INDUSTRY ON THE WINDOW SEALS (U.S. CLS. 100, 103 AND 106).



SN 78-043,697. VOODOO CHOPPERS, LLC, SHELBY TOWNSHIP, MI. FILED 1-18-2001.



NO CLAIM IS MADE TO THE EXCLUSIVE RIGHT TO USE "CHOPPERS", APART FROM THE MARK AS SHOWN. THE MARK CONSISTS OF A TAILPIPE WITH FLAMES EXTENDING THROUGH THE WORD "VOODOO".

FOR MANUFACTURE OF MOTORCYCLES AND MOTORCYCLE ACCESSORIES TO ORDER AND/OR SPECIFICATION OF OTHERS (U.S. CLS. 100, 103 AND 106).



SN 78-069,407. VIRTUAL REMODEL, INC., DALLAS, TX. FILED 6-15-2001.

VIRTUAL REMODEL

NO CLAIM IS MADE TO THE EXCLUSIVE RIGHT TO USE "VIRTUAL", APART FROM THE MARK AS SHOWN.

FOR DIGITAL RESTORATION AND/OR ENHANCEMENT OF PHOTOGRAPHS (U.S. CLS. 100, 103 AND 106).

CLASS 41—EDUCATION AND ENTERTAINMENT

SN 75-518,430. AMERICA ONLINE, INC., DULLES, VA. BY ASSIGNMENT SPINNER NETWORKS INCORPORATED, BURLINGAME, CA. FILED 7-14-1998.

SPINNER

FOR ENTERTAINMENT SERVICES IN THE NATURE OF ON-LINE MUSIC SERVICES, NAMELY, PROVIDING MUSIC OVER COMPUTER NETWORKS AND PROVIDING NEWS AND INFORMATION ABOUT MUSIC OVER COMPUTER NETWORKS (U.S. CLS. 100, 101 AND 107).
FIRST USE 4-1-1996; IN COMMERCE 4-1-1996.

SN 75-742,086. PLAMONDON, LUC, AUSTIN (QUEBEC) G0B 1B0, CANADA, FILED 7-1-1999.

STARMANIA

PRIORITY CLAIMED UNDER SEC. 44(D) ON CANADA APPLICATION NO. 1011970, FILED 4-16-1999.
FOR ENTERTAINMENT SERVICES, NAMELY, THE PRODUCTION OF DRAMATIC SHOWS AND PLAYS ON STAGE, MUSICAL SHOWS AND PLAYS, RECORDS AND VIDEO TAPES (U.S. CLS. 100, 101 AND 107).

SN 75-794,689. TREMENDOUS ENTERTAINMENT, INC., MINNEAPOLIS, MN. FILED 9-8-1999.

K-9 TO 5

FOR ENTERTAINMENT SERVICES IN THE NATURE OF A TELEVISION SERIES FEATURING WORKING DOGS (U.S. CLS. 100, 101 AND 107).
FIRST USE 10-2-1999; IN COMMERCE 10-2-1999.

SN 75-817,286. GLOBAL GROOVE, INC., ELMONT, NY. FILED 10-7-1999.

GLOBAL GROOVE

FOR STUDIO MUSICIAN SERVICES, NAMELY, PERFORMING LIVE IN STUDIO OR VIA ELECTRONIC TRANSMISSION ON OTHER PERFORMERS' MUSICAL SOUND RECORDINGS (U.S. CLS. 100, 101 AND 107).
FIRST USE 4-0-1997; IN COMMERCE 4-0-1997.

SN 75-837,189. PAUL H. YOUNG CHAPTER, TROUT UNLIMITED, SOUTHFIELD, MI. FILED 10-28-1999.

SPORTING FLIES

NO CLAIM IS MADE TO THE EXCLUSIVE RIGHT TO USE "FLIES", APART FROM THE MARK AS SHOWN.
FOR ENTERTAINMENT IN THE NATURE OF FLY CASTING TOURNAMENTS (U.S. CLS. 100, 101 AND 107).
FIRST USE 2-1-1994; IN COMMERCE 2-1-1994.

CLASS 41—(Continued).

SN 75-840,126. NORTHERN ARIZONA UNIVERSITY, FLAG-STAFF, AZ. FILED 11-19-1999.

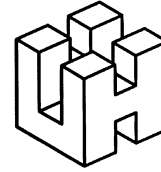

Universityhouse

FOR EDUCATIONAL SERVICES, NAMELY PROVIDING COURSES OF INSTRUCTION VIA SATELLITE FOR K-12, UNIVERSITY, AND COMMUNITY COLLEGE FOR STUDENTS IN THE FIELDS OF MATH, SCIENCE, ARTS AND HUMANITIES, FOREIGN LANGUAGES, HISTORY, BUSINESS, AND DISTRIBUTING COURSE MATERIALS IN CONNECTION THEREWITH (U.S. CLS. 100, 101 AND 107).

SN 75-868,480. OLAM, LOS ANGELES, CA. FILED 12-10-1999.

CAFE OLAM

FOR EDUCATIONAL SERVICES, NAMELY, LECTURES, MEETINGS AND DISCUSSIONS PERTAINING TO THE TORAH AND JUDAISM; PLANNING, ARRANGING AND CONDUCTING CULTURAL AND SOCIAL EVENTS PERTAINING TO THE TORAH AND JUDAISM (U.S. CLS. 100, 101 AND 107).

SN 75-873,607. DEL WEBB CORPORATION, PHOENIX, AZ. FILED 12-16-1999.



THE LINCOLN HILLS CLUB

by Del Webb

OWNER OF U.S. REG. NO. 2,347,715.
NO CLAIM IS MADE TO THE EXCLUSIVE RIGHT TO USE "CLUB", APART FROM THE MARK AS SHOWN.
THE NAME "DEL WEBB" DOES NOT IDENTIFY A LIVING INDIVIDUAL.
FOR GOLF CLUB SERVICES; PROVIDING TENNIS COURT AND SWIMMING FACILITIES; PROVIDING FITNESS EXERCISE FACILITIES; RECREATIONAL SERVICES IN THE NATURE OF BOWLING, BOUCE BALL, GOLF, WALKING TRAILS, BIKING, ARTS AND CRAFTS, SHUFFLEBOARD, POOL, SPORT AND FITNESS, AND LAWN BOWLING; AND PROVIDING RECREATIONAL FACILITIES (U.S. CLS. 100, 101 AND 107).
FIRST USE 11-0-1999; IN COMMERCE 11-0-1999.

CLASS 41—(Continued).

SN 75-881,911. TELEVISION FOOD NETWORK, G.P., NEW YORK, NY. FILED 12-28-1999.

BILL BOGGS' CORNER TABLE

FOR TELEVISION ENTERTAINMENT SERVICES, NAMELY, AN ON-GOING TELEVISION PROGRAM IN THE FIELDS OF CELEBRITY INTERVIEWS, FOOD, COOKING, RECIPES, RESTAURANTS, ENTERTAINING AND THE CULINARY ARTS (U.S. CLS. 100, 101 AND 107).

FIRST USE 12-1-1996; IN COMMERCE 12-1-1996.

SN 75-885,644. JAIN, VINISH, SCARSDALE, NY. FILED 1-3-2000.

VINISH

THE NAME "VINISH" IDENTIFIES A LIVING INDIVIDUAL WHOSE CONSENT IS OF RECORD.

FOR EDUCATIONAL SERVICES, NAMELY, CONDUCTING CLASSES, SEMINARS AND WORKSHOPS IN THE FIELDS OF PHILOSOPHY, SPIRITUALITY AND MEDITATION; AUDIO AND VIDEO RECORDING AND PRODUCTION SERVICES (U.S. CLS. 100, 101 AND 107).

FIRST USE 10-0-1998; IN COMMERCE 10-0-1998.

SN 75-895,708. @RADICAL.MEDIA, INC., NEW YORK, NY. FILED 1-12-2000.

@RADICAL

OWNER OF U.S. REG. NO. 2,299,053.

FOR ENTERTAINMENT SERVICES, NAMELY PRODUCTION OF TELEVISION SHOWS; MOTION PICTURE FILM PRODUCTION (U.S. CLS. 100, 101 AND 107).

SN 75-896,093. YO NETWORK, LLC, NEW YORK, NY. FILED 1-13-2000.

YO BOSTON

NO CLAIM IS MADE TO THE EXCLUSIVE RIGHT TO USE "BOSTON ", APART FROM THE MARK AS SHOWN.

FOR PROVIDING INFORMATION ABOUT ACTIVITIES AND EVENTS IN BOSTON, NAMELY, MOVIES, THEATERS, RECREATIONAL, EDUCATIONAL AND ENTERTAINMENT RELATED ACTIVITIES VIA A GLOBAL COMMUNICATIONS NETWORK (U.S. CLS. 100, 101 AND 107).

FIRST USE 11-30-1999; IN COMMERCE 11-30-1999.

CLASS 41—(Continued).

SN 75-927,462. PAN-AMERICAN LIFE INSURANCE COMPANY, NEW ORLEANS, LA. FILED 2-24-2000.

EDUCATION4U

FOR PROVIDING INSTRUCTION IN THE FIELDS OF INVESTMENT, INSURANCE AND FINANCIAL PLANNING AND DISTRIBUTING COURSE MATERIALS IN CONNECTION THEREWITH (U.S. CLS. 100, 101 AND 107).

SN 75-929,436. PASKOWITZ, ISRAEL, SAN CLEMENTE, CA. FILED 2-25-2000.

PASKOWITZ SURF CAMP

NO CLAIM IS MADE TO THE EXCLUSIVE RIGHT TO USE "SURF CAMP", APART FROM THE MARK AS SHOWN.

SEC. 2(F).

FOR SPORT CAMPS, SUMMER CAMPS, RECREATIONAL CAMPS, AND EDUCATIONAL SERVICES, NAMELY, CONDUCTING LESSONS, CLASSES, LECTURES IN THE FIELD OF SURFING (U.S. CLS. 100, 101 AND 107).

FIRST USE 6-1-1972; IN COMMERCE 6-1-1972.

SN 75-980,389. DREAMLIFE, INC., NEW YORK, NY. BY CHANGE OF NAME GHS, INC., NEW YORK, NY. FILED 10-25-1999.

DREAMLIFE

FOR PROGRAMMING ON A GLOBAL COMPUTER NETWORK, EDUCATIONAL SERVICES, NAMELY CONDUCTING ON-LINE CLASSES AND SEMINARS IN THE FIELD OF PERSONAL AND PROFESSIONAL DEVELOPMENT (U.S. CLS. 100, 101 AND 107).

FIRST USE 12-0-1999; IN COMMERCE 12-0-1999.

SN 76-009,599. COSMOS BROADCASTING CORPORATION, GREENVILLE, SC. FILED 3-27-2000.



FOR ENTERTAINMENT IN THE NATURE OF ON-GOING TELEVISION VIGNETTE IN THE FIELD OF TEENAGE INTERESTS AND TEENAGE SUBJECT MATTER (U.S. CLS. 100, 101 AND 107).

FIRST USE 7-20-1999; IN COMMERCE 7-20-1999.

CLASS 41—(Continued).

SN 76-010,590. COSMOS BROADCASTING CORPORATION, GREENVILLE, SC. FILED 3-27-2000.

IT'S YOUR LIFE

FOR ENTERTAINMENT IN THE NATURE OF ONGOING TELEVISION VIGNETTE IN THE FIELD OF TEENAGE INTERESTS AND TEENAGE SUBJECT MATTER (U.S. CLS. 100, 101 AND 107).

FIRST USE 7-20-1999; IN COMMERCE 7-20-1999.

SN 76-010,855. BARBARA PERRINS & ASSOCIATES, RICHMOND, VA. FILED 3-28-2000.

CULTURAL IMMERSION TRAVEL

NO CLAIM IS MADE TO THE EXCLUSIVE RIGHT TO USE "CULTURAL" AND "TRAVEL", APART FROM THE MARK AS SHOWN.

FOR EDUCATIONAL SERVICES, NAMELY, CONDUCTING LECTURES, SEMINARS AND WORKSHOPS IN THE FIELDS OF ANTHROPOLOGY, RELIGION AND CULTURAL STUDIES, INCLUDING DISTRIBUTING COURSE MATERIALS IN CONNECTION THEREWITH (U.S. CLS. 100, 101 AND 107).

FIRST USE 10-15-1999; IN COMMERCE 10-15-1999.

SN 76-019,835. WORD OF LIFE FELLOWSHIP, INC., SCHROON LAKE, NY. FILED 4-6-2000.



OWNER OF U.S. REG. NOS. 1,577,466 AND 1,587,517. NO CLAIM IS MADE TO THE EXCLUSIVE RIGHT TO USE "BIBLE INSTITUTE", "INTERNATIONAL", "REPRESENTATIONS OF A BIBLE AND CROSS" AND "PHIL 2:16", APART FROM THE MARK AS SHOWN.

FOR EDUCATIONAL CONSULTING SERVICES IN THE FIELD OF ESTABLISHING AND CONDUCTING YOUTH ACTIVITIES; ENTERTAINMENT SERVICES IN THE NATURE OF RELIGIOUS RADIO AND TELEVISION PROGRAMS, YOUTH RALLIES, CONCERTS AND MUSICAL DRAMAS; EDUCATIONAL SERVICES, NAMELY CONDUCTING CLASSES AND SEMINARS IN THE FIELD OF BIBLE STUDY (U.S. CLS. 100, 101 AND 107).

FIRST USE 0-0-1971; IN COMMERCE 0-0-1971.

CLASS 41—(Continued).

SN 76-027,651. SELECT INVESTMENT AND MANAGEMENT CO., MERIDIAN, ID. FILED 4-14-2000.

BOONDOCKS FUN CENTER

NO CLAIM IS MADE TO THE EXCLUSIVE RIGHT TO USE "FUN CENTER", APART FROM THE MARK AS SHOWN.

FOR RECREATIONAL SERVICES IN THE NATURE OF GO-KART TRACKS, LASER TAG, BUMPER BOATS, BATTING CAGES, ARCADE GAMES, MINIATURE GOLF COURSES, AND GOLF PRACTICE CENTERS (U.S. CLS. 100, 101 AND 107).

FIRST USE 12-0-1997; IN COMMERCE 3-10-1998.

SN 76-030,892. TOTHAM, S.A., IBIZA (BALEARES), SPAIN, FILED 4-20-2000.

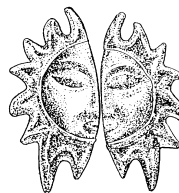

El Divino

COLOR IS CLAIMED AS A FEATURE OF THE MARK. THE WORDS EL DIVINO ARE IN PURPLE. THE CRESCENT MOON SHAPE ABOVE THE FIRST LETTER "I" IS GREEN, AND THE STAR SHAPE ABOVE THE SAME LETTER "I" IS LIGHT YELLOW. THE HEART SHAPE ABOVE THE SECOND LETTER "I" IS RED. THE SUN ABOVE THE WORDS EL DIVINO IS DIVIDED INTO TWO FACE-LIKE HALVES. THE FACE ON THE RIGHT HALF AND ITS BORDER ARE GOLD, AND THE FACE ON THE LEFT HALF IS SILVER WITH A GOLD BORDER.

THE ENGLISH TRANSLATION OF "EL DIVINO" IS "THE DIVINE ONE".

FOR ENTERTAINMENT, NAMELY, LIVE STAGE SHOWS FEATURING MUSIC, DANCE, AND COMEDY, PERFORMED IN BARS, DISCOTHEQUES, AND PARTY FACILITIES (U.S. CLS. 100, 101 AND 107).

SN 76-032,238. QD ENTERPRISES, LLC, SHARON, MA. FILED 4-24-2000.

THE ANSWER PAGE

NO CLAIM IS MADE TO THE EXCLUSIVE RIGHT TO USE "ANSWER", APART FROM THE MARK AS SHOWN.

FOR EDUCATION SERVICES, NAMELY, CONDUCTING DAILY TRAINING SESSIONS FOR MEDICAL PROFESSIONALS OVER GLOBAL COMPUTER NETWORKS (U.S. CLS. 100, 101 AND 107).

FIRST USE 3-28-1998; IN COMMERCE 3-28-1998.

CLASS 41—(Continued).

SN 76-048,798. ADVANCED INSTITUTE OF PEST TECHNOLOGY, ANAHEIM, CA. FILED 5-15-2000.



NO CLAIM IS MADE TO THE EXCLUSIVE RIGHT TO USE "ADVANCED INSTITUTE OF PEST TECHNOLOGY", APART FROM THE MARK AS SHOWN.

FOR VOCATIONAL EDUCATION IN THE FIELD OF STRUCTURAL AND AGRICULTURAL PEST CONTROL (U.S. CLS. 100, 101 AND 107).

FIRST USE 10-0-1990; IN COMMERCE 6-0-1991.

SN 76-050,625. ARIS CORPORATION, BELLEVUE, WA. FILED 5-17-2000.

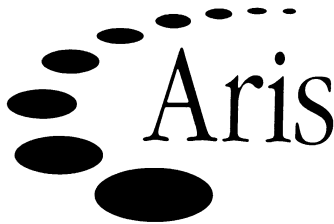

FOR EDUCATIONAL SERVICES, NAMELY, CONDUCTING CLASSES, SEMINARS, AND WORKSHOPS IN THE FIELD OF COMPUTER HARDWARE AND SOFTWARE, ONLINE SERVICES, INFORMATION TECHNOLOGY, BUSINESS AND PROFESSIONAL SKILLS, BUSINESS AND PROFESSIONAL CERTIFICATION, AND COMPUTER SOFTWARE PROGRAMMING, VIA THE GLOBAL COMPUTER NETWORK (U.S. CLS. 100, 101 AND 107).

FIRST USE 4-3-2000; IN COMMERCE 4-3-2000.

SN 76-052,518. THINKBOX MEDIA, INC., HOLLYWOOD, CA. FILED 5-19-2000.

MYBOOKCLUB

FOR ENTERTAINMENT SERVICES, NAMELY, MOTION PICTURE FILM AND VIDEO PRODUCTION; ENTERTAINMENT IN THE NATURE OF AN ONGOING TELEVISION SERIES IN THE FIELD OF ANIMATED AND LIVE ACTION COMEDY-DRAMA, ACTION-ADVENTURE, AND EDUCATIONAL PROGRAMMING; MOTION PICTURE, RADIO PROGRAMMING AND TELEVISION PROGRAM DISSEMINATION FOR OTHERS; PRODUCTION OF EDUCATIONAL AND ENTERTAINMENT VIDEO PROGRAMMING INTENDED FOR ON-LINE DISSEMINATION BY MEANS OF A GLOBAL COMPUTER NETWORK; PRODUCTION OF TELEVISION BROADCAST PROGRAMS AND INTERACTIVE TELEVISION PROGRAMS INTENDED FOR ONLINE DISSEMINATION VIA A GLOBAL COMPUTER NETWORK AND FOR DISSEMINATION VIA CABLE, SATELLITE, WIRELESS AND TRADITIONAL TELEVISION IN THE FIELDS OF EDUCATION AND ENTERTAINMENT (U.S. CLS. 100, 101 AND 107).

CLASS 41—(Continued).

SN 76-054,524. SIRIUS ENTERTAINMENT, INC., LOS ANGELES, CA. FILED 5-19-2000.

PUBLICSTUDIOS.COM

FOR PROVIDING AN ON-LINE PUBLIC PRODUCTION AND ENTERTAINMENT SERVICE, THE ENTERTAINMENT SERVICE SPECIFICALLY COMPRISING PROVIDING AN ON-LINE SYSTEM ALLOWING USERS TO VOTE ON MOVIE PRODUCTION DECISIONS IN A MOVIE PRODUCTION SUCH AS PLOTS, CHARACTERS, AND ACTORS (U.S. CLS. 100, 101 AND 107).

FIRST USE 4-14-2000; IN COMMERCE 4-14-2000.

SN 76-055,406. H. S. DENT FOUNDATION, BURLINGTON, VT. FILED 5-24-2000.

THE SPENDING WAVE

SEC. 2(F).

FOR EDUCATIONAL SEMINARS IN THE FIELD OF SECURITIES, FINANCE, AND INVESTMENTS (U.S. CLS. 100, 101 AND 107).

FIRST USE 9-0-1988; IN COMMERCE 9-0-1988.

SN 76-056,343. SPORTSTROVE, INC., CHICAGO, IL. FILED 5-24-2000.

SPORTSTROVE ROAD SHOW

NO CLAIM IS MADE TO THE EXCLUSIVE RIGHT TO USE "ROAD SHOW", APART FROM THE MARK AS SHOWN.

FOR PRODUCTION OF RADIO, TELEVISION, SATELLITE TELEVISION AND CABLE TELEVISION PROGRAMS, VIDEOTAPES AND FILMS IN THE FIELD OF SPORTS, SPORTS ENTERTAINMENT, SPORTS COLLECTIBLES AND SPORTS MEMORABILIA (U.S. CLS. 100, 101 AND 107).

SN 76-061,532. GREENE, ADRIENNE W., CINCINNATI, OH. FILED 6-2-2000.

PURITY POINTS

FOR EDUCATIONAL SERVICES, NAMELY, CONDUCTING CLASSES AND SEMINARS AND PROVIDING INFORMATION ON THE TOPIC OF SEXUAL ABSTINENCE (U.S. CLS. 100, 101 AND 107).

FIRST USE 8-0-1996; IN COMMERCE 8-0-1996.

CLASS 41—(Continued).

SN 76-068,869. LINE PUBLICATIONS, LLC, LOS ANGELES, CA. FILED 6-12-2000.

HOLLYWOOD STYLE AWARDS

NO CLAIM IS MADE TO THE EXCLUSIVE RIGHT TO USE "HOLLYWOOD" AND "AWARDS", APART FROM THE MARK AS SHOWN.

FOR ENTERTAINMENT SERVICES IN THE NATURE OF AN AWARDS SHOW FOR FASHION AND BEAUTY (U.S. CLS. 100, 101 AND 107).

SN 76-074,618. LUTTERMOSER, KURT, LAKELAND, FL. FILED 6-21-2000.

ADRENALINE GAMES

NO CLAIM IS MADE TO THE EXCLUSIVE RIGHT TO USE "GAMES", APART FROM THE MARK AS SHOWN.

FOR ENTERTAINMENT SERVICES IN THE NATURE OF A LIVE SPORTING EVENT FEATURING AGGRESSIVE IN-LINE SKATING, SKATEBOARDING, SKY-DIVING, MOTOR CROSS RACING, BAREFOOT WATER SKIING, WAKEBOARDING, WAVE RUNNER RACING AND MOUNTAIN BIKING (U.S. CLS. 100, 101 AND 107).

SN 76-075,458. VIACOM INTERNATIONAL INC., NEW YORK, NY. FILED 6-22-2000.

MTV NEW SENSATION

OWNER OF U.S. REG. NOS. 1,373,948, 1,985,017 AND OTHERS.

FOR ENTERTAINMENT SERVICES IN THE NATURE OF A TELEVISION SERIES WHICH HIGHLIGHTS KEY EVENTS OR NEW STARS-OF-THE-MOMENT (U.S. CLS. 100, 101 AND 107).

FIRST USE 1-22-2000; IN COMMERCE 1-22-2000.

SN 76-075,809. QWEST COMMUNICATIONS INTERNATIONAL INC., DENVER, CO. BY MERGER U S WEST, INC., DENVER, CO. FILED 6-22-2000.

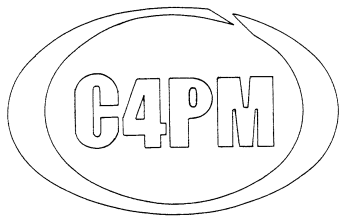

FOR EDUCATIONAL SERVICES, NAMELY PROVIDING GRADUATE LEVEL TRAINING IN THE FIELD OF BUSINESS-RELATED PROGRAM MANAGEMENT (U.S. CLS. 100, 101 AND 107).

CLASS 41—(Continued).

SN 76-077,299. RWB TOURNAMENTS, LLC, VIRGINIA BEACH, VA. FILED 6-26-2000.

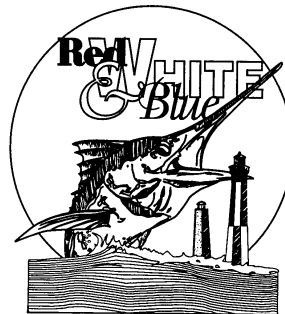

THE LINING SHOWN IN THE DRAWING IS A FEATURE OF THE MARK AND IS TO INTENDED TO INDICATE COLOR.

FOR ENTERTAINMENT SERVICES, NAMELY ARRANGING FOR AND CONDUCTING FISHING TOURNAMENTS (U.S. CLS. 100, 101 AND 107).

FIRST USE 12-0-1999; IN COMMERCE 1-0-2000.

SN 76-079,498. TWENTIETH CENTURY FOX FILM CORPORATION, LOS ANGELES, CA. FILED 6-27-2000.

FOX SPORTS RADIO NETWORK

NO CLAIM IS MADE TO THE EXCLUSIVE RIGHT TO USE "SPORTS RADIO NETWORK", APART FROM THE MARK AS SHOWN.

FOR PRODUCTION OF RADIO PROGRAMMING; DISTRIBUTION OF RADIO PROGRAMMING FOR OTHERS (U.S. CLS. 100, 101 AND 107).

SN 76-081,238. STARTECH EARLY VENTURES, LLC, RICHARDSON, TX. BY CHANGE OF NAME STARTECH BUSINESS DEVELOPMENT, LLC, RICHARDSON, TX. FILED 6-30-2000.



FOR CONDUCTING WORKSHOPS AND SEMINARS IN THE FIELD OF ENTREPRENEURSHIP, BUSINESS START-UPS AND HI-TECH BUSINESS VENTURES (U.S. CLS. 100, 101 AND 107).

FIRST USE 12-0-1999; IN COMMERCE 12-0-1999.

CLASS 41—(Continued).

SN 76-086,830. MEDALIST GROUP, LLC, THE, FLAGSHIP WARF, MA. FILED 7-11-2000.



NO CLAIM IS MADE TO THE EXCLUSIVE RIGHT TO USE "WOMEN'S SENIOR GOLF TOUR", APART FROM THE MARK AS SHOWN.

FOR ORGANIZING, SPONSORING AND CONDUCTING GOLF TOURNAMENTS (U.S. CLS. 100, 101 AND 107).

FIRST USE 2-12-1999; IN COMMERCE 2-12-1999.

SN 76-089,832. JOINT COMMISSION RESOURCES, INC., OAKBROOK TERRACE, IL. FILED 7-14-2000.

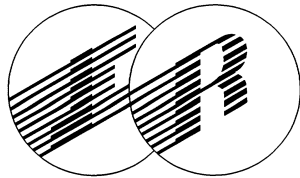

THE LINING SHOWN ON THE DRAWING IS A FEATURE OF THE MARK AND IS NOT INTENDED TO INDICATE COLOR.

FOR EDUCATIONAL SERVICES; NAMELY, CONDUCTING SEMINARS, CLASSES, WORKSHOPS AND SYMPOSIA IN THE FIELD OF HEALTHCARE (U.S. CLS. 100, 101 AND 107).

FIRST USE 2-1-2000; IN COMMERCE 2-1-2000.

SN 76-091,870. BLOUNT, INC., MONTGOMERY, AL. FILED 7-17-2000.



OWNER OF U.S. REG. NO. 1,183,501. NO CLAIM IS MADE TO THE EXCLUSIVE RIGHT TO USE "THE ORIGINAL" AND "LOADER CHAMPIONSHIP", APART FROM THE MARK AS SHOWN.

FOR ENTERTAINMENT SERVICES IN THE NATURE OF LOG LOADING CONTESTS (U.S. CLS. 100, 101 AND 107).

FIRST USE 12-31-1972; IN COMMERCE 12-31-1972.

CLASS 41—(Continued).

SN 76-098,393. ATWORK!, ISSAQUAH, WA. FILED 7-28-2000.



FOR JOB TRAINING SERVICES FOR THE DISABLED (U.S. CLS. 100, 101 AND 107).

FIRST USE 10-0-1998; IN COMMERCE 10-0-1998.

SN 76-099,516. MILOSAVLJEVIC, NADA, LIBERTYVILLE, IL. FILED 7-31-2000.

PLANETMED

FOR PUBLICATION OF BOOKS AND MAGAZINES (U.S. CLS. 100, 101 AND 107).

SN 76-106,649. IRS, INC., SAN DIEGO, CA. FILED 8-10-2000.

PGTAA

OWNER OF U.S. REG. NO. 2,477,993. FOR EDUCATIONAL SERVICES, NAMELY, CONDUCTING CLASSES AND SEMINARS IN THE FIELD OF GOLF INSTRUCTION (U.S. CLS. 100, 101 AND 107).

FIRST USE 9-6-1997; IN COMMERCE 9-6-1997.

SN 76-110,343. MERCK-MEDCO MANAGED CARE, L.L.C., FRANKLIN LAKES, NJ. FILED 8-17-2000.

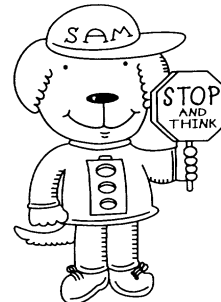

FOR EDUCATIONAL SERVICES, NAMELY CONDUCTING CLASSES IN THE FIELD OF SAFETY AND POISON PREVENTION AND DISTRIBUTING COURSE MATERIAL IN CONNECTION THEREWITH (U.S. CLS. 100, 101 AND 107).

FIRST USE 1-0-2001; IN COMMERCE 1-0-2001.

CLASS 41—(Continued).

SN 76-119,196. CARTOON NETWORK LP, LLLP, THE, ATLANTA, GA. FILED 8-30-2000.

EVIL CON CARNE

THE ENGLISH TRANSLATION OF "EVIL CON CARNE" IS "EVIL WITH MEAT".

FOR ENTERTAINMENT AND EDUCATION SERVICES IN THE NATURE OF A CONTINUING PROGRAM SERIES AND MOTION PICTURE FILMS DIRECTED TOWARD CHILDREN AND YOUNG ADULTS, PROVIDED THROUGH CABLE TELEVISION, BROADCAST TELEVISION, BROADCAST RADIO AND THE GLOBAL COMPUTER INFORMATION NETWORK (U.S. CLS. 100, 101 AND 107).

SN 76-125,980. XO COMMUNICATIONS, INC., RESTON, VA. BY CHANGE OF NAME NEXTLINK COMMUNICATIONS, INC, MCLEAN, VA. FILED 9-8-2000.

XOPTIONS

FOR EDUCATION AND TRAINING SERVICES, NAMELY, CLASSES, WORKSHOPS, AND TRAINING SEMINARS RELATING TO THE ELECTRONIC TRANSMISSION OF VOICE, DATA, INFORMATION, VIDEO, DATABASES, AND THE INTERNET; ARRANGING, CONDUCTING, AND ORGANIZING SEMINARS AND EDUCATIONAL, RECREATIONAL, AND INSTRUCTIONAL CONVENTIONS, CONFERENCES, CONGRESS, EXHIBITIONS, AND DEMONSTRATIONS REGARDING TELECOMMUNICATIONS AND INTERNET TECHNOLOGY; PROVIDING INFORMATION ONLINE FROM COMPUTER DATABASES, WEB SITES, AND THE INTERNET RELATING TO EDUCATION, TRAINING, NEWS, AND PUBLISHING; AND PUBLICATION OF BOOKS, DIRECTORIES, GUIDES, MAPS, MAGAZINES, MANUALS, AND PRINTED MATTER RELATING TO TELECOMMUNICATIONS, COMPUTERS, AND THE INTERNET (U.S. CLS. 100, 101 AND 107).

SN 76-127,939. LIVING OUR REAL DREAMS PRODUCTIONS, CANOGA PARK, CA. FILED 9-14-2000.

THE BEAUTIFUL WORLD

FOR ENTERTAINMENT, NAMELY, PROVIDING A CONTINUING LIVE TELEVISION PROGRAM AND LIVE THEATRICAL PERFORMANCES, GEARED TO CHILDREN FOR THE PURPOSE OF CHARACTER DEVELOPMENT (U.S. CLS. 100, 101 AND 107).

SN 76-128,319. PET FILES, LAGUNA HILLS, CA. FILED 9-15-2000.

PET FILES TV

NO CLAIM IS MADE TO THE EXCLUSIVE RIGHT TO USE "PET" AND "TV", APART FROM THE MARK AS SHOWN.

FOR TELEVISION SERIALS REGARDING PETS AND PET CARE (U.S. CLS. 100, 101 AND 107).

FIRST USE 1-11-2000; IN COMMERCE 1-11-2000.

CLASS 41—(Continued).

SN 76-128,651. CORPORATE VISIONS INCORPORATED, INCLINE VILLAGE, NV. FILED 9-15-2000.

POWER POSITIONING FOR THE ENTERPRISE

FOR EDUCATIONAL SERVICES, NAMELY, WORKSHOPS AND SEMINARS IN THE FIELDS OF MARKETING AND SALES (U.S. CLS. 100, 101 AND 107).
FIRST USE 6-6-1999; IN COMMERCE 6-6-1999.

SN 76-133,956. CHICAGO WHITE SOX, LTD., CHICAGO, IL. FILED 9-22-2000.



OWNER OF U.S. REG. NOS. 855,319, 1,770,152 AND OTHERS.

THE MARK IS USED ON ADVERTISEMENTS AND PROMOTIONAL MATERIALS RELATED TO THE SERVICES, AND IN OTHER WAYS CUSTOMARY TO THE TRADE.

FOR ENTERTAINMENT AND EDUCATION SERVICES, NAMELY, BASEBALL GAMES, COMPETITIONS AND EXHIBITIONS RENDERED LIVE, THROUGH BROADCAST MEDIA INCLUDING TELEVISION AND RADIO AND VIA A GLOBAL COMPUTER NETWORK OR A COMMERCIAL ON-LINE SERVICE; PROVIDING INFORMATION IN THE FIELD OF SPORTS, ENTERTAINMENT AND RELATED TOPICS AND PROVIDING FOR INFORMATIONAL MESSAGES RELATING THERETO; PROVIDING MULTI-USER INTERACTIVE COMPUTER GAMES ALL VIA A GLOBAL COMPUTER NETWORK OR A COMMERCIAL ON-LINE SERVICE (U.S. CLS. 100, 101 AND 107).

FIRST USE 4-22-1949; IN COMMERCE 4-22-1949.

CLASS 41—(Continued).

SN 76-136,933. UKEILEY, STEPHEN L., LONG BEACH, NY.
FILED 8-25-2000.



NO CLAIM IS MADE TO THE EXCLUSIVE RIGHT TO USE "TALK RADIO", APART FROM THE MARK AS SHOWN.

FOR ENTERTAINMENT SERVICES, NAMELY, AN ON-GOING RADIO TALK SHOW (U.S. CLS. 100, 101 AND 107).

FIRST USE 8-23-2000; IN COMMERCE 8-23-2000.

SN 76-143,070. LEARNING TECHNIQS, INC., SALT LAKE CITY, UT. FILED 10-10-2000.

IQ EXPRESS/ACCELERATING CHILD DEVELOPMENT

NO CLAIM IS MADE TO THE EXCLUSIVE RIGHT TO USE "ACCELERATING CHILD DEVELOPMENT", APART FROM THE MARK AS SHOWN.

FOR EDUCATIONAL SERVICES, NAMELY, CONDUCTING TUTORING, CLASSES, SEMINARS, CONFERENCES AND WORKSHOPS FOR THE PURPOSE OF ASSISTING STUDENTS TO PERCEIVE AND PROCESS INFORMATION CORRECTLY TO IMPROVE LEARNING ABILITIES, INCLUDING THE DISTRIBUTION OF COURSE MATERIALS IN CONNECTION THEREWITH (U.S. CLS. 100, 101 AND 107).

FIRST USE 6-30-2000; IN COMMERCE 6-30-2000.

SN 76-146,151. SEATUCK ENVIRONMENTAL ASSOCIATION, INC., ISLIP, NY. FILED 10-6-2000.

WILDTREK

FOR EDUCATIONAL SERVICES, NAMELY, CONDUCTING COURSES, SEMINARS, WORKSHOPS, CLASSES AND CONFERENCES IN THE FIELD OF MIGRATORY ANIMAL SPECIES AND PROVIDING AN ON-LINE COMPUTER DATABASE RELATING TO THE FIELD OF MIGRATORY ANIMAL SPECIES (U.S. CLS. 100, 101 AND 107).

FIRST USE 3-3-1999; IN COMMERCE 3-3-1999.

CLASS 41—(Continued).

SN 76-152,853. B.F.C. INTERNATIONAL, INC., EL PASO, TX.
FILED 10-24-2000.

I.P.O.S.

FOR EDUCATIONAL SERVICES, NAMELY, PROVIDING SEMINARS, LECTURES, AND CONFERENCES IN THE FIELD OF LEADERSHIP TRAINING (U.S. CLS. 100, 101 AND 107).

SN 76-152,963. B.F.C. INTERNATIONAL, INC., EL PASO, TX.
FILED 10-24-2000.

LEAD BY DESIGN

FOR EDUCATIONAL SERVICES, NAMELY, PROVIDING SEMINARS, LECTURES, AND CONFERENCES IN THE FIELD OF LEADERSHIP TRAINING (U.S. CLS. 100, 101 AND 107).

SN 76-153,042. B.F.C. INTERNATIONAL, INC., EL PASO, TX.
FILED 10-24-2000.

PEOPLE FACTOR TECHNOLOGY

NO CLAIM IS MADE TO THE EXCLUSIVE RIGHT TO USE "PEOPLE" AND "TECHNOLOGY", APART FROM THE MARK AS SHOWN.

FOR EDUCATIONAL SERVICES, NAMELY, PROVIDING SEMINARS, LECTURES, AND CONFERENCES IN THE FIELD OF LEADERSHIP TRAINING (U.S. CLS. 100, 101 AND 107).

SN 76-156,704. FETISH FACTORY, INC., FORT LAUDERDALE, FL. FILED 10-31-2000.

TRANSFORM YOURSELF

FOR ENTERTAINMENT IN THE NATURE OF CONDUCTING THEME PARTIES (U.S. CLS. 100, 101 AND 107).

FIRST USE 3-15-1997; IN COMMERCE 3-15-1997.

SN 76-164,838. SELDES, DARIN, ATLANTA, GA. FILED 11-13-2000.

ROLL

FOR ENTERTAINMENT SERVICES IN THE NATURE OF MUSICAL PRODUCTIONS, NAMELY, MUSICAL PLAYS AND LIVE PERFORMANCES BY A MUSICAL BAND (U.S. CLS. 100, 101 AND 107).

FIRST USE 11-2-2000; IN COMMERCE 11-2-2000.

CLASS 41—(Continued).

SN 76-168,003. BUSHELL, BARRY, MIAMI, FL. FILED 11-20-2000.

KING DAVID II

FOR ENTERTAINMENT SERVICES IN THE NATURE OF LIVE VOCAL PERFORMANCES (U.S. CLS. 100, 101 AND 107).

FIRST USE 7-1-1990; IN COMMERCE 7-1-1990.

CLASS 41—(Continued).

SN 76-188,168. MOTTO CITIZENS, LLC, DENMARK, ME. FILED 12-24-2000.

(W)HOLE

FOR EDUCATION SERVICES IN THE FIELD OF CONTEMPLATIVE, PHILOSOPHICAL AND MEDITATIVE STUDIES (U.S. CLS. 100, 101 AND 107).

FIRST USE 12-1-1999; IN COMMERCE 12-1-1999.

SN 76-177,337. UNIVISION COMMUNICATIONS INC., LOS ANGELES, CA. FILED 12-7-2000.

AMOR BANDIDO

THE ENGLISH TRANSLATION OF "AMOR BANDIDO" IS "BANDIT LOVE".

FOR ENTERTAINMENT SERVICES, NAMELY, A CONTINUING TELEVISION DRAMA PROGRAM (U.S. CLS. 100, 101 AND 107).

SN 76-177,339. UNIVISION COMMUNICATIONS INC., LOS ANGELES, CA. FILED 12-7-2000.

A MILLON

"A MILLON" IS A SLANG PHRASE IN SPANISH THAT TRANSLATES ROUGHLY TO ENGLISH AS: "AT A FAST PACE" OR "IN THE FAST LANE".

FOR ENTERTAINMENT SERVICES, NAMELY, A RECURRING TELEVISION GAME SHOW (U.S. CLS. 100, 101 AND 107).

SN 76-181,395. BAYRAKDAR, MOHAMED YESSER, LAS VEGAS, NV. FILED 12-15-2000.

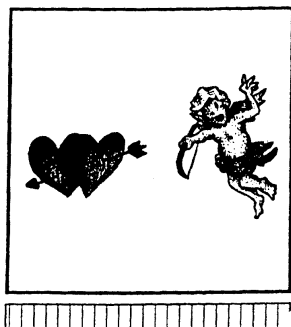

FOR EDUCATIONAL AND ENTERTAINMENT SERVICES, NAMELY, RELATIONSHIPS IMPROVEMENT, SELF-AWARENESS AND SELF-IMPROVEMENT SEMINARS, CLASSES, CONFERENCES, IN AN ENTERTAINING WAY BY USING CHINESE ANIMAL SIGNS (U.S. CLS. 100, 101 AND 107).

SN 76-190,414. SQUARE CO., LTD., MEGURO-KU, TOKYO, JAPAN, FILED 1-2-2001.

FINAL FANTASY

OWNER OF U.S. REG. NOS. 1,733,280, 2,288,318 AND OTHERS.

FOR PROVIDING COMPUTER GAMES THROUGH A GLOBAL COMMUNICATION NETWORK; PROVIDING INFORMATION ON COMPUTER GAME STRATEGY THROUGH A GLOBAL COMMUNICATION NETWORK; PROVIDING INFORMATION ON ENTERTAINMENT; PROVIDING INFORMATION ON SPORTS; PROVIDING ON-LINE COMICS AND ANIMATION THROUGH A GLOBAL COMMUNICATION NETWORK (U.S. CLS. 100, 101 AND 107).

SN 76-191,059. KENT STATE UNIVERSITY, KENT, OH. FILED 1-5-2001.

PATHWAYS

FOR EDUCATIONAL SERVICES, NAMELY, A UNIVERSITY LEVEL PROGRAM DESIGNED TO ASSIST STUDENTS IN THE TRANSITION FROM HIGH SCHOOL TO COLLEGE EDUCATION, BY PARTICIPATION IN A PROGRAM THAT PROVIDES A PROGRAM RESIDENCE HALL, EXERCISE PROGRAM, HEALTH AND PHYSICAL ASSESSMENT SERVICES, AN ASSISTANTSHIP WITHIN A DEPARTMENT, AND INTERACTION WITH BUSINESS AND EDUCATIONAL LEADERS (U.S. CLS. 100, 101 AND 107).

FIRST USE 2-0-1999; IN COMMERCE 2-0-1999.

SN 76-191,109. ALLIANCELEARN, LLC, ARDEN, NC. FILED 1-8-2001.

AllianceLearn

FOR EDUCATIONAL SERVICES, NAMELY, PROVIDING COURSES OF INSTRUCTION AT THE PROFESSIONAL CONTINUING EDUCATION LEVEL VIA A GLOBAL COMPUTER NETWORK, AND DISTRIBUTING COURSE MATERIAL IN CONNECTION THEREWITH (U.S. CLS. 100, 101 AND 107).

CLASS 41—(Continued).

SN 76-191,542. FIGHTERS WITH COURAGE AND POWER, INC., ST. LOUIS, MO. FILED 1-9-2001.

FIGHTERS WITH COURAGE AND POWER

NO CLAIM IS MADE TO THE EXCLUSIVE RIGHT TO USE "FIGHTERS", APART FROM THE MARK AS SHOWN. FOR PROVIDING KAJUKENBO INSTRUCTION FOR STUDENTS WITH CEREBRAL PALSY (U.S. CLS. 100, 101 AND 107).

FIRST USE 10-26-2000; IN COMMERCE 10-26-2000.

SN 76-192,341. GRAPHIC ARTS TECHNICAL FOUNDATION, SEWICKLEY, PA. FILED 1-10-2001.

INTERTECH

FOR COMPETITIONS IN THE FIELD OF GRAPHIC COMMUNICATIONS, NAMELY, SPONSORING AND CONDUCTING A COMPETITION TO SELECT AN AWARD WINNER IN THE DEVELOPMENT OF NEW TECHNOLOGY IN THE GRAPHIC COMMUNICATIONS INDUSTRIES (U.S. CLS. 100, 101 AND 107).

FIRST USE 12-0-1978; IN COMMERCE 12-0-1978.

SN 76-196,436. BRAIN BOLUS MEDICAL EDUCATION FOUNDATION, ARLINGTON, TX. FILED 1-22-2001.

BRAIN BOLUS

FOR EDUCATIONAL SERVICES, NAMELY, PROVIDING CONTINUING MEDICAL EDUCATION TO DOCTORS, NURSES AND OTHER HEALTH CARE PROFESSIONALS (U.S. CLS. 100, 101 AND 107).

FIRST USE 8-1-2000; IN COMMERCE 8-1-2000.

SN 76-201,186. BOIS FORTE BAND OF CHIPPEWA INDIANS, DBA FORTUNE BAY RESORT CASINO, TOWER, MN. FILED 1-29-2001.

WINTER BLAST

NO CLAIM IS MADE TO THE EXCLUSIVE RIGHT TO USE "WINTER", APART FROM THE MARK AS SHOWN. FOR ENTERTAINMENT SERVICES IN THE NATURE OF AN ANNUAL SNOWMOBILE RALLY EVENT (U.S. CLS. 100, 101 AND 107).

FIRST USE 10-11-1999; IN COMMERCE 1-1-2000.

CLASS 41—(Continued).

SN 76-210,975. RHODES COLLEGE, MEMPHIS, TN. FILED 2-16-2001.

RHODES

SEC. 2(F).

FOR EDUCATIONAL SERVICES, NAMELY, PROVIDING AND ADMINISTERING COURSES OF INSTRUCTION AT THE COLLEGE AND CONTINUING STUDIES LEVELS; ARRANGING AND CONDUCTING EDUCATIONAL CONFERENCES AND LECTURES IN THE FIELDS OF LIBERAL ARTS; AND ENTERTAINMENT SERVICES, NAMELY, ORGANIZING AND CONDUCTING INTERCOLLEGIATE-LEVEL AND INTRAMURAL SPORTS COMPETITIONS, ATHLETIC EVENTS, SPORTS TOURNAMENTS, LIVE MUSICAL CONCERTS, LIVE MUSICAL PERFORMANCES, AND THEATER PRODUCTIONS (U.S. CLS. 100, 101 AND 107).

FIRST USE 6-20-1984; IN COMMERCE 6-25-1984.

SN 76-211,474. RHODES COLLEGE, MEMPHIS, TN. FILED 2-16-2001.

RHODES COLLEGE

NO CLAIM IS MADE TO THE EXCLUSIVE RIGHT TO USE "COLLEGE", APART FROM THE MARK AS SHOWN. SEC. 2(F).

FOR EDUCATIONAL SERVICES, NAMELY, PROVIDING AND ADMINISTERING COURSES OF INSTRUCTION AT THE COLLEGE AND CONTINUING STUDIES LEVELS; ARRANGING AND CONDUCTING EDUCATIONAL CONFERENCES AND LECTURES IN THE FIELDS OF LIBERAL ARTS; AND ENTERTAINMENT SERVICES, NAMELY, ORGANIZING AND CONDUCTING INTERCOLLEGIATE-LEVEL AND INTRAMURAL SPORTS COMPETITIONS, ATHLETIC EVENTS, SPORTS TOURNAMENTS, LIVE MUSICAL CONCERTS, LIVE MUSICAL PERFORMANCES, AND THEATER PRODUCTIONS (U.S. CLS. 100, 101 AND 107).

FIRST USE 6-20-1984; IN COMMERCE 6-25-1984.

SN 76-211,768. LEADERSHIP ONE, INC., ROLLING HILLS ESTATES, CA. FILED 2-20-2001.

LEADERSHIP ONE

NO CLAIM IS MADE TO THE EXCLUSIVE RIGHT TO USE "LEADERSHIP", APART FROM THE MARK AS SHOWN.

FOR BUSINESS CONSULTATION SERVICES IN THE NATURE OF ASSISTING COMPANIES TO BUILD SUCCESSFUL PERFORMANCE TEAMS BY ASSESSING AND EVALUATING PROCEDURES, CUSTOMS, AND PRACTICES AS WELL AS DEVELOPING AND IMPLEMENTING IMPROVED PROCEDURES, CUSTOMS, AND PRACTICES TO OPTIMIZE PERFORMANCE, PRODUCTIVITY, AND PROFITABILITY (U.S. CLS. 100, 101 AND 107).

FIRST USE 4-1-2001; IN COMMERCE 4-1-2001.

CLASS 41—(Continued).

SN 76-222,704. LAZARUS, LORY, BLOOMFIELD, NJ. FILED 3-9-2001.

LAZOO

FOR ENTERTAINMENT SERVICES, NAMELY PROVIDING LIVE VOCAL AND MUSICAL PERFORMANCES (U.S. CLS. 100, 101 AND 107).
FIRST USE 9-5-1978; IN COMMERCE 9-5-1978.

SN 76-224,130. DOMINION VIDEO SATELLITE, INC., NAPLES, FL. FILED 3-14-2001.

WORRY FREE TV

NO CLAIM IS MADE TO THE EXCLUSIVE RIGHT TO USE "TV", APART FROM THE MARK AS SHOWN.
FOR SUBSCRIPTION TELEVISION BROADCASTING, TELEVISION BROADCASTING, VIDEO BROADCASTING, AUDIO BROADCASTING, RADIO BROADCASTING, DATA AND VOICE TELECOMMUNICATIONS, NAMELY, ELECTRONIC TRANSMISSION OF DATA AND VOICE SIGNALS BY MEANS OF SATELLITE (U.S. CLS. 100, 101 AND 107).
FIRST USE 0-0-1998; IN COMMERCE 0-0-1998.

SN 76-225,177. INTERNATIONAL COMMUNICATIONS INDUSTRIES ASSOCIATION, INC., FAIRFAX, VA. FILED 3-16-2001.

AUDIO ENCOUNTER

OWNER OF U.S. REG. NO. 2,366,073.
NO CLAIM IS MADE TO THE EXCLUSIVE RIGHT TO USE "AUDIO", APART FROM THE MARK AS SHOWN.
FOR EDUCATIONAL SERVICES, NAMELY, CONDUCTING PRESENTATIONS IN THE FIELD OF COMMUNICATIONS FEATURING EXHIBITS OF SELECTED ASPECTS OF AUDIO TECHNOLOGY (U.S. CLS. 100, 101 AND 107).
FIRST USE 6-15-2000; IN COMMERCE 6-15-2000.

SN 76-225,975. LAURENCE, EMMA, WASHINGTON, DC. FILED 3-19-2001.

THE IMPROVISED LIFE

FOR EDUCATIONAL SERVICES, NAMELY, CONDUCTING WORKSHOPS, SEMINARS, AND COACHING IN THE FIELD OF PERSONAL GROWTH AND SPIRITUAL DEVELOPMENT (U.S. CLS. 100, 101 AND 107).
FIRST USE 1-17-2001; IN COMMERCE 2-4-2001.

CLASS 41—(Continued).

SN 76-227,182. PROMOTION CO., INC. THE, INDIANAPOLIS, IN. FILED 3-21-2001.

INDIANAPOLIS AT HOME

NO CLAIM IS MADE TO THE EXCLUSIVE RIGHT TO USE "INDIANAPOLIS", APART FROM THE MARK AS SHOWN.

FOR CONDUCTING ENTERTAINMENT EXHIBITIONS IN THE NATURE OF HOME DECORATING SHOWS FEATURING FURNITURE RETAILERS, INTERIOR DESIGNERS AND SPECIAL FEATURES BUILT AROUND THE HOME-DECORATING THEME (U.S. CLS. 100, 101 AND 107).
FIRST USE 11-18-1999; IN COMMERCE 11-18-1999.

SN 76-229,882. BRADY, THOMAS MICHAEL FITZGERALD, TOLEDO, OH. FILED 3-26-2001.

ALL OR NUTHIN' RECORDS

NO CLAIM IS MADE TO THE EXCLUSIVE RIGHT TO USE "RECORDS", APART FROM THE MARK AS SHOWN.
FOR AUDIO RECORDING AND PRODUCTION; MUSIC PUBLISHING SERVICES (U.S. CLS. 100, 101 AND 107).
FIRST USE 1-0-1998; IN COMMERCE 1-0-1998.

SN 76-233,702. FOUNTAINHEAD ENTERTAINMENT, INC., MESQUITE, TX. FILED 3-30-2001.

GAMERS

FOR PRODUCTION AND DISTRIBUTION OF A SERIES OF DOCUMENTARY MOTION PICTURE FILMS AND TELEVISION SERIES, RELATING TO AN ANALYSIS OF COMPUTER SOFTWARE GAME PLAYERS, FOR DISTRIBUTION VIA THEATRICAL RELEASE, TELEVISION RELEASE, INTERNET, VIDEO OR DVD (U.S. CLS. 100, 101 AND 107).
FIRST USE 3-0-2000; IN COMMERCE 3-0-2000.

SN 76-237,415. TAYLOR, JARED LEE, PHILADELPHIA, PA. FILED 4-10-2001.

GRAND AGENT

FOR AUDIO RECORDING AND PRODUCTION FOR THE PURPOSES OF RECORD PRODUCTION AND RECORD MASTER PRODUCTION; MUSIC PUBLISHING SERVICES, PUBLICATION OF PLAYS, SCREENPLAYS AND BOOKS; ENTERTAINMENT IN THE NATURE OF VISUAL AND AUDIO PERFORMANCES, NAMELY, MUSICAL BAND, ROCK GROUP, AND PLAYS (U.S. CLS. 100, 101 AND 107).
FIRST USE 2-13-1998; IN COMMERCE 9-1-1998.

CLASS 41—(Continued).

SN 76-239,562. KSTP-AM, LLC, ST. PAUL, MN. FILED 4-12-2001.

MINNESOTA'S MR. RIGHT

NO CLAIM IS MADE TO THE EXCLUSIVE RIGHT TO USE "MINNESOTA'S", APART FROM THE MARK AS SHOWN.

FOR ENTERTAINMENT SERVICES, NAMELY, A CONTINUING TALK RADIO SHOW (U.S. CLS. 100, 101 AND 107).

FIRST USE 11-0-1998; IN COMMERCE 11-0-1998.

SN 76-240,650. INNRCITY TENNIS FOUNDATION, WAY-ZATA, MN. FILED 4-13-2001.

A Game That Begins With Love!



...And Builds Character!!

INNER CITY TENNIS

OWNER OF U.S. REG. NO. 1,885,370.
NO CLAIM IS MADE TO THE EXCLUSIVE RIGHT TO USE "INNER CITY TENNIS", APART FROM THE MARK AS SHOWN.

FOR TENNIS INSTRUCTION AND ENTERTAINMENT IN THE NATURE OF TENNIS TOURNAMENTS (U.S. CLS. 100, 101 AND 107).

FIRST USE 0-0-1993; IN COMMERCE 0-0-1993.

SN 76-244,075. SCHALKLE, BARRY L., WOODBURY, MN. FILED 4-20-2001.

ONE SHOT CAN CHANGE YOUR LIFE

FOR PROMOTING THE SPORT OF GOLF THROUGH ENTERTAINMENT IN THE NATURE OF GOLF TOURNAMENTS AND GOLF EXHIBITIONS AND GOLF CLASSES (U.S. CLS. 100, 101 AND 107).

CLASS 41—(Continued).

SN 76-250,206. NATIONAL HOCKEY LEAGUE, NEW YORK, NY. FILED 5-2-2001.

HOCKEY RULES

FOR ENTERTAINMENT SERVICES IN THE NATURE OF PROFESSIONAL ICE HOCKEY EXHIBITIONS, PROVIDING SPORTS AND ENTERTAINMENT SERVICES ON-LINE, NAMELY, HOCKEY INFORMATION VIA A GLOBAL COMPUTER NETWORK, EXCLUDING INFORMATION RELATING TO THE RULES OF HOCKEY; ARRANGING AND ORGANIZING OF SPORTS EVENTS (U.S. CLS. 100, 101 AND 107).

SN 76-251,887. MCNASTY, FILTHY, HOLLYWOOD, CA. FILED 5-4-2001.

FILTHY MCNASTY

OWNER OF U.S. REG. NO. 1,166,829.
THE NAME "FILTHY MCNASTY" IDENTIFIES A LIVING INDIVIDUAL WHOSE CONSENT IS OF RECORD.
FOR ENTERTAINMENT SERVICES; NAMELY LIVE MUSICAL PERFORMANCES BY AN INDIVIDUAL (U.S. CLS. 100, 101 AND 107).
FIRST USE 9-1-1971; IN COMMERCE 9-1-1971.

SN 76-257,372. 02 HOLDINGS, LLC, NEW YORK, NY. FILED 5-14-2001.

LOUDER THAN WORDS

FOR EDUCATIONAL AND ENTERTAINMENT SERVICES IN THE NATURE OF PROVIDING INFORMATION RELATING TO A MULTI-MEDIA AND GRASSROOTS CAMPAIGN TO INCREASE THE NUMBER OF WOMEN SERVING IN LEADERSHIP POSITIONS AT COMMUNITY, LOCAL, STATE AND NATIONAL LEVELS PROVIDED BY MEANS OF SEMINARS AND CONFERENCES; SPECIAL EVENT PLANNING RELATING TO A MULTI-MEDIA AND GRASSROOTS CAMPAIGN TO INCREASE THE NUMBER OF WOMEN SERVING IN LEADERSHIP POSITIONS AT COMMUNITY, LOCAL, STATE AND NATIONAL LEVELS; ENTERTAINMENT, NAMELY A CONTINUING NEWS SHOW RELATING TO A MULTI-MEDIA AND GRASSROOTS CAMPAIGN TO INCREASE THE NUMBER OF WOMEN SERVING IN LEADERSHIP POSITIONS AT COMMUNITY, LOCAL, STATE AND NATIONAL LEVELS DISTRIBUTED OVER TELEVISION, SATELLITE, AUDIO, AND VIDEO MEDIA (U.S. CLS. 100, 101 AND 107).

CLASS 41—(Continued).

SN 76-258,426. DOUGLAS, MICHAEL, UNIVERSAL CITY, CA. FILED 5-17-2001.

MICHAEL DOUGLAS

THE NAME IN THE MARK IDENTIFIES A LIVING INDIVIDUAL WHOSE CONSENT IS OF RECORD.

FOR PROVIDING ENTERTAINMENT AND FILM INFORMATION VIA A WEBSITE ON THE INTERNET; ACTING SERVICES, NAMELY, LIVE PERSONAL APPEARANCES AND APPEARANCES IN FILMS (U.S. CLS. 100, 101 AND 107).

FIRST USE 10-0-1999; IN COMMERCE 10-0-1999.

CLASS 41—(Continued).

SN 76-272,424. TELESTRATEGIES, INC., MCLEAN, VA. FILED 6-18-2001.

BILLING WORLD

OWNER OF U.S. REG. NOS. 1,973,779 AND 1,976,135. NO CLAIM IS MADE TO THE EXCLUSIVE RIGHT TO USE "BILLING", APART FROM THE MARK AS SHOWN. FOR EDUCATIONAL SERVICES, NAMELY, CONDUCTING SEMINARS IN THE FIELD OF BILLING (U.S. CLS. 100, 101 AND 107).

FIRST USE 6-28-2000; IN COMMERCE 6-28-2000.

SN 76-261,785. NATIONAL HOCKEY LEAGUE, NEW YORK, NY. FILED 5-23-2001.

NHL HOCKEY RULES

FOR ENTERTAINMENT SERVICES IN THE NATURE OF PROFESSIONAL ICE HOCKEY EXHIBITIONS, PROVIDING SPORTS AND ENTERTAINMENT SERVICES ON-LINE, NAMELY, HOCKEY INFORMATION VIA A GLOBAL COMPUTER NETWORK, EXCLUDING INFORMATION RELATING TO THE RULES OF HOCKEY; ARRANGING AND ORGANIZING OR SPORTS EVENTS (U.S. CLS. 100, 101 AND 107).

SN 76-270,073. PARTNERSHIP MINISTRIES, INC., DUBLIN, OH. FILED 6-11-2001.

**LIFELINE NATIONAL
BASKETBALL
INVITATIONAL**

NO CLAIM IS MADE TO THE EXCLUSIVE RIGHT TO USE "NATIONAL BASKETBALL INVITATIONAL", APART FROM THE MARK AS SHOWN.

FOR ENTERTAINMENT SERVICES IN THE NATURE OF ARRANGING AND CONDUCTING CHRISTIAN BASKETBALL TOURNAMENTS (U.S. CLS. 100, 101 AND 107).

SN 76-270,228. ESSAR COMPANY, INC., WICKHAMS CAY, BR. VIRGIN ISLANDS, FILED 6-12-2001.

GINO THE DOG

FOR PRODUCTION OF CHILDREN'S TELEVISION PROGRAMS, MOTION PICTURES, DVDS, VIDEOCASSETTES AND OTHER PRE-RECORDED AUDIOVISUAL FORMATS (U.S. CLS. 100, 101 AND 107).

SN 76-273,588. GADSDEN, PATRICIA L., HARRISBURG, PA. FILED 6-20-2001.

LIFE ESTEEM

FOR COORDINATING EDUCATIONAL WORKSHOPS IN THE FIELDS OF INTERPERSONAL COMMUNICATION, HEALTH, SELF-ESTEEM AND WELL-BEING, DRUG PREVENTION, PROBLEM-SOLVING, LIFE TRANSITION ADJUSTMENT, DIVERSITY, AND THE LIKE; ENTERTAINMENT SERVICES, NAMELY, TELEVISION PROGRAMS IN THE NATURE OF AN ONGOING VARIETY TALK SHOW (U.S. CLS. 100, 101 AND 107).

FIRST USE 9-1-1989; IN COMMERCE 10-15-1990.

SN 76-280,966. TIME/DESIGN, INC., AGAWAM, MA. FILED 7-5-2001.

MANAGING FOCUS

NO CLAIM IS MADE TO THE EXCLUSIVE RIGHT TO USE "MANAGING", APART FROM THE MARK AS SHOWN.

FOR EDUCATIONAL SERVICES, NAMELY, CONDUCTING SEMINARS IN THE FIELD OF TIME SKILLS (U.S. CLS. 100, 101 AND 107).

SN 76-280,967. TIME/DESIGN, INC., AGAWAM, MA. FILED 7-5-2001.

FOCUS MANAGEMENT

NO CLAIM IS MADE TO THE EXCLUSIVE RIGHT TO USE "MANAGEMENT", APART FROM THE MARK AS SHOWN.

FOR EDUCATIONAL SERVICES, NAMELY, CONDUCTING SEMINARS IN THE FIELD OF TIME USAGE SKILLS (U.S. CLS. 100, 101 AND 107).

CLASS 41—(Continued).

SN 76-285,410. CITY CHURCH, THE, KIRKLAND, WA. FILED 7-16-2001.

GENERATIONINTERNS

FOR EDUCATIONAL AND VOCATIONAL TRAINING, NAMELY LEADERSHIP TRAINING FOR POST-HIGH SCHOOL AGE ADULTS IN BIBLICAL INSTRUCTION, AND MENTORING IN CHURCH ACTIVITIES, NAMELY ADMINISTRATION, CHILDRENS' BIBLE CLASSES, EVANGELISTIC OUTREACH, INTERNATIONAL OUTREACH, PREACHING AND MISSIONARY ENDEAVORS (U.S. CLS. 100, 101 AND 107).

FIRST USE 9-15-1995; IN COMMERCE 9-15-1995.

SN 76-287,692. BUSCH ENTERTAINMENT CORPORATION, ST. LOUIS, MO. FILED 7-19-2001.

JACK IS BACK

FOR ENTERTAINMENT SERVICES IN THE NATURE OF AN AMUSEMENT PARK ATTRACTION (U.S. CLS. 100, 101 AND 107).

SN 76-289,664. BREEDERS' CUP LIMITED, LEXINGTON, KY. FILED 7-24-2001.



OWNER OF U.S. REG. NOS. 1,330,152 AND 2,071,416. NO CLAIM IS MADE TO THE EXCLUSIVE RIGHT TO USE "WORLD THOROUGHBRED CHAMPIONSHIPS", APART FROM THE MARK AS SHOWN.

FOR ENTERTAINMENT SERVICES, NAMELY, CONDUCTING THOROUGHBRED HORSE RACES (U.S. CLS. 100, 101 AND 107).

CLASS 41—(Continued).

SN 76-289,667. BREEDERS' CUP LIMITED, LEXINGTON, KY. FILED 7-24-2001.



OWNER OF U.S. REG. NOS. 1,330,152 AND 2,071,416. NO CLAIM IS MADE TO THE EXCLUSIVE RIGHT TO USE "WORLD THOROUGHBRED CHAMPIONSHIPS", APART FROM THE MARK AS SHOWN.

FOR ENTERTAINMENT SERVICES, NAMELY, CONDUCTING THOROUGHBRED HORSE RACES (U.S. CLS. 100, 101 AND 107).

SN 76-290,142. BILL GLASS MINISTRIES, DALLAS, TX. FILED 7-26-2001.

WEEKEND WITH CHAMPIONS

OWNER OF U.S. REG. NO. 2,048,847. FOR ENTERTAINMENT IN THE NATURE OF ONGOING RADIO PROGRAMS IN THE FIELDS OF EVANGELISM, MOTIVATION AND SELF-IMPROVEMENT (U.S. CLS. 100, 101 AND 107).

FIRST USE 11-0-2000; IN COMMERCE 1-0-2001.

SN 76-290,891. AMERICAN INSTITUTE OF PHYSICS, COLLEGE PARK, MD. FILED 7-30-2001.

INFORMATION THAT MATTERS

FOR PUBLICATION OF BOOKS, MAGAZINES AND NEWSLETTERS IN THE FIELDS OF PHYSICS, PHYSICAL SCIENCES AND ENGINEERING; AND EDUCATIONAL SERVICES, NAMELY, DEVELOPMENT AND DISSEMINATION OF EDUCATIONAL MATERIALS IN THE FIELDS OF PHYSICS, PHYSICAL SCIENCES AND ENGINEERING; AND EDUCATIONAL SERVICES, NAMELY, CONDUCTING CLASSES, SEMINARS, CONFERENCES AND WORKSHOPS IN THE FIELDS OF PHYSICS, PHYSICAL SCIENCES AND ENGINEERING (U.S. CLS. 100, 101 AND 107).

CLASS 41—(Continued).

SN 76-294,047. GODAL, VICKI, BAINBRIDGE ISLAND, WA. AND GODAL, STIG, BAINBRIDGE ISLAND, WA. FILED 8-2-2001.

STINKALOTAMUS TV

NO CLAIM IS MADE TO THE EXCLUSIVE RIGHT TO USE "TV", APART FROM THE MARK AS SHOWN.
 FOR ENTERTAINMENT SERVICES, IN THE NATURE OF AN ON-GOING TELEVISION PROGRAM IN THE FIELD OF CHILDREN'S EDUCATIONAL COMEDY, WITH AN INTERACTIVE COMPONENT ACCESSED VIA THE INTERNET (U.S. CLS. 100, 101 AND 107).

SN 76-297,443. IRI GOLF MANAGEMENT, L.P., ROCKWALL, TX. FILED 8-9-2001.

OLD WEST TRAIL

FOR SERVICES, NAMELY, GOLF COURSE OPERATIONS (U.S. CLS. 100, 101 AND 107).

SN 76-299,982. EARL REALTY INC., LANCASTER, PA. FILED 8-16-2001.

DISCOVER LANCASTER COUNTY HISTORICAL MUSEUM

OWNER OF U.S. REG. NO. 1,967,484.
 NO CLAIM IS MADE TO THE EXCLUSIVE RIGHT TO USE "LANCASTER COUNTY HISTORICAL MUSEUM", APART FROM THE MARK AS SHOWN.
 FOR PROVIDING THE SERVICES OF OPERATING A HISTORICAL MUSEUM (U.S. CLS. 100, 101 AND 107).
 FIRST USE 1-1-1999; IN COMMERCE 1-1-1999.

SN 76-302,209. MATCHBOX TWENTY, LLC, WEST HOLLYWOOD, CA. FILED 8-21-2001.

MATCHBOX TWENTY

FOR ENTERTAINMENT, NAMELY, LIVE PERFORMANCES BY A MUSICAL BAND (U.S. CLS. 100, 101 AND 107).
 FIRST USE 5-16-2000; IN COMMERCE 5-16-2000.

CLASS 41—(Continued).

SN 76-310,441. SKYSHAPERS FITNESS FOUNDATION, INC., NEW YORK, NY. FILED 9-10-2001.

SKY U

FOR EDUCATIONAL/ENTERTAINMENT SERVICES (IE; SEMINARS, CLASSES, ETC) ON GOING CHILDREN'S EDUCATIONAL COURSE SEMINARS FEATURING TOPICS DESIGNED TO MOTIVATE AND EMPOWER CHILDREN IN ORGANIZATION, PERSONAL DEVELOPMENT, AND THE REALIZATION OF THEIR GOALS, FEATURING STORIES, CARTOONS, GAMES, MUSIC, AND RELATED ACTIVITIES AND EXERCISES (U.S. CLS. 100, 101 AND 107).
 FIRST USE 11-13-1999; IN COMMERCE 11-13-1999.

SN 76-310,690. CRANKSHAFT, HOLLYWOOD, CA. FILED 9-10-2001.

CRANKSHAFT

FOR ENTERTAINMENT SERVICES IN THE NATURE OF A LIVE MUSICAL GROUP (U.S. CLS. 100, 101 AND 107).
 FIRST USE 6-1-1997; IN COMMERCE 6-1-1997.

SN 76-315,353. THOMPSON, E. JEAN, MITCHELLEVILLE, MD. FILED 9-21-2001.

CHOSEN CHAMPIONS

FOR EDUCATIONAL SERVICES, NAMELY ARRANGING AND CONDUCTING CLASSES, SEMINARS, CONFERENCES AND WORKSHOPS IN THE AREA OF SELF AWARENESS/SELF-IMPROVEMENT; DISTRIBUTING COURSE MATERIALS IN CONNECTION THEREWITH AS WELL AS PUBLICATION OF BOOKS, PAMPHLETS AND MAGAZINES (U.S. CLS. 100, 101 AND 107).

SN 76-315,354. THOMPSON, E. JEAN, MITCHELLEVILLE, MD. FILED 9-21-2001.

3RD JOHN 2

FOR EDUCATIONAL SERVICES, NAMELY ARRANGING AND CONDUCTING CLASSES, SEMINARS, CONFERENCES AND WORKSHOPS IN THE AREA OF SELF AWARENESS/SELF-IMPROVEMENT; DISTRIBUTING COURSE MATERIALS IN CONNECTION THEREWITH AS WELL AS PUBLICATION OF BOOKS, PAMPHLETS AND MAGAZINES (U.S. CLS. 100, 101 AND 107).

CLASS 41—(Continued).

SN 76-315,355. THOMPSON, E. JEAN, MITCHELLEVILLE, MD. FILED 9-21-2001.

CLASS 41—(Continued).

SN 76-315,360. THOMPSON, E. JEAN, MITCHELLEVILLE, MD. FILED 9-21-2001.

END TIME ESTHERS

FOR ARRANGING AND CONDUCTING CLASSES, SEMINARS, CONFERENCES AND WORKSHOPS IN THE AREA OF SELF AWARENESS/SELF-IMPROVEMENT; DISTRIBUTING COURSE MATERIALS IN CONNECTION THEREWITH AS WELL AS PUBLICATION OF BOOKS, PAMPHLETS AND MAGAZINES (U.S. CLS. 100, 101 AND 107).

WISDOM LIFE

FOR ARRANGING AND CONDUCTING CLASSES, SEMINARS, CONFERENCES AND WORKSHOPS IN THE AREA OF SELF AWARENESS/SELF-IMPROVEMENT; DISTRIBUTING COURSE MATERIALS IN CONNECTION THEREWITH AS WELL AS PUBLICATION OF BOOKS, PAMPHLETS AND MAGAZINES (U.S. CLS. 100, 101 AND 107).

SN 76-315,357. THOMPSON, E. JEAN, MITCHELLEVILLE, MD. FILED 9-21-2001.

SN 76-315,771. XM SATELLITE RADIO INC., WASHINGTON, DC. FILED 9-21-2001.

CHOSEN VESSELS

FOR ARRANGING AND CONDUCTING CLASSES, SEMINARS, CONFERENCES AND WORKSHOPS IN THE AREA OF SELF AWARENESS/SELF-IMPROVEMENT; DISTRIBUTING COURSE MATERIALS IN CONNECTION THEREWITH AS WELL AS PUBLICATION OF BOOKS, PAMPHLETS AND MAGAZINES (U.S. CLS. 100, 101 AND 107).

U-POP

FOR ENTERTAINMENT SERVICES, NAMELY, PROVIDING AUDIO PROGRAMS FEATURING MUSIC, SPORTS, TALK, NEWS AND DATA VIA SATELLITE AND VIA A GLOBAL COMMUNICATION NETWORK (U.S. CLS. 100, 101 AND 107).

SN 76-315,358. THOMPSON, E. JEAN, MITCHELLEVILLE, MD. FILED 9-21-2001.

SN 78-001,863. WALBURG, AARON, OAKLAND, CA. FILED 3-30-2000.

HELPERS OF THE LORD

FOR EDUCATIONAL SERVICES, NAMELY ARRANGING AND CONDUCTING CLASSES, SEMINARS, CONFERENCES AND WORKSHOPS IN THE AREA OF SELF AWARENESS/SELF-IMPROVEMENT; DISTRIBUTING COURSE MATERIALS IN CONNECTION THEREWITH AS WELL AS PUBLICATION OF BOOKS, PAMPHLETS AND MAGAZINES (U.S. CLS. 100, 101 AND 107).



FOR PROVIDING AN ONLINE INTERACTIVE WEBSITE IN THE FIELD OF GOLF INFORMATION (U.S. CLS. 100, 101 AND 107).
FIRST USE 5-11-2000; IN COMMERCE 5-11-2000.

SN 76-315,359. THOMPSON, E. JEAN, MITCHELLEVILLE, MD. FILED 9-21-2001.

SN 78-001,965. IN THE MIDST, SEVERN, MD. FILED 3-31-2000.

WISDOM SUCCESS

FOR EDUCATIONAL SERVICES, NAMELY ARRANGING AND CONDUCTING CLASSES, SEMINARS, CONFERENCES AND WORKSHOPS IN THE AREA OF SELF AWARENESS/SELF IMPROVEMENT; DISTRIBUTING COURSE MATERIALS IN CONNECTION THEREWITH AS WELL AS PUBLICATION OF BOOKS, PAMPHLETS AND MAGAZINES (U.S. CLS. 100, 101 AND 107).

IN THE MIDST, INC.

NO CLAIM IS MADE TO THE EXCLUSIVE RIGHT TO USE "INC.", APART FROM THE MARK AS SHOWN.
FOR AUDIO RECORDING AND PRODUCTION; RECORD PRODUCTION (U.S. CLS. 100, 101 AND 107).

CLASS 41—(Continued).

SN 78-012,155. KEN FLETCHER, BEVERLY FARMS, MA. FILED 6-12-2000.

CAPITALVENUE

FOR ARRANGING SEMINARS AND CONFERENCES IN THE FIELD OF VENTURE CAPITAL (U.S. CLS. 100, 101 AND 107).



SN 78-013,217. GHETTO-BORN PRODUCTIONS, INC., BEVERLY HILLS, CA. FILED 6-18-2000.

GHETTO-BORN PRODUCTIONS, INC.

NO CLAIM IS MADE TO THE EXCLUSIVE RIGHT TO USE "PRODUCTIONS, INC.", APART FROM THE MARK AS SHOWN.

FOR ENTERTAINMENT, NAMELY PRODUCTION OF MUSIC, PLAYS, TELEVISION SHOWS, FEATURE FILMS, AND RADIO PROGRAMS (U.S. CLS. 100, 101 AND 107).



SN 78-017,322. FOX FAMILY PROPERTIES, INC., LOS ANGELES, CA. FILED 7-18-2000.

RACE AROUND THE WORLD

FOR ENTERTAINMENT SERVICES IN THE NATURE OF A LIVE-ACTION TELEVISION SERIES; PROVIDING A WEBSITE ON THE GLOBAL COMPUTER NETWORK FEATURING INFORMATION RELATING TO THE TELEVISION PROGRAM; AND ENTERTAINMENT SERVICES IN THE NATURE OF AN ON-LINE COMPUTER GAME (U.S. CLS. 100, 101 AND 107).



SN 78-017,324. FOX FAMILY PROPERTIES, INC., LOS ANGELES, CA. FILED 7-18-2000.

BOOT CAMP

FOR ENTERTAINMENT SERVICES IN THE NATURE OF A LIVE-ACTION TELEVISION SERIES; PROVIDING A WEBSITE ON THE GLOBAL COMPUTER NETWORK FEATURING INFORMATION RELATING TO THE TELEVISION PROGRAM; AND ENTERTAINMENT SERVICES IN THE NATURE OF AN ON-LINE COMPUTER GAME (U.S. CLS. 100, 101 AND 107).

CLASS 41—(Continued).

SN 78-018,681. KRELL RECORDS PTY LTD., PORT VILLA, VANUATU, FILED 7-27-2000.

D.R.E.E.M. TEENZ

FOR ENTERTAINMENT SERVICES, NAMELY, PRODUCTION OF TELEVISION AND RADIO PROGRAMS, ANIMATED AND LIVE ACTION TELEVISION SERIES, AND THEATRICAL PRODUCTION; AUDIO RECORDING AND PRODUCTION; VIDEO RECORDING AND PRODUCTION; MOTION PICTURE FILM PRODUCTION; MUSIC VIDEO PRODUCTION; AND LIVE PERFORMANCE BY A MUSICAL GROUP (U.S. CLS. 100, 101 AND 107).



SN 78-019,911. CRAZY HAT MAN MUSIC, DBA CURRENTLY NAMELESS, MONTPELIER, VT. FILED 8-7-2000.

CURRENTLY NAMELESS

FOR ENTERTAINMENT, NAMELY, LIVE PERFORMANCES BY A MUSICAL BAND (U.S. CLS. 100, 101 AND 107).

FIRST USE 10-30-1995; IN COMMERCE 10-30-1995.



SN 78-020,495. TRAINING & DEVELOPMENT CORPORATION, BUCKSPORT, ME. FILED 8-10-2000.

INSTITUTES OF THE ATLANTIC

NO CLAIM IS MADE TO THE EXCLUSIVE RIGHT TO USE "INSTITUTES", APART FROM THE MARK AS SHOWN.

FOR EDUCATIONAL SERVICES, NAMELY, CONDUCTING EDUCATION PROGRAMS, COURSES, WORKSHOPS, AND CONFERENCES IN THE FIELD OF PROFESSIONAL EMPLOYMENT, CAREER RESEARCH, CAREER PLANNING, CAREER DEVELOPMENT, AND CAREER MANAGEMENT (U.S. CLS. 100, 101 AND 107).

CLASS 41—(Continued).

SN 78-021,665. MAGIX COMPUTER PRODUCTS INTERNATIONAL CORP. SANTA MONICA, CA. FILED 8-17-2000.

CREATIVE ENTERTAINMENT

NO CLAIM IS MADE TO THE EXCLUSIVE RIGHT TO USE "ENTERTAINMENT", APART FROM THE MARK AS SHOWN.

FOR ENTERTAINMENT SERVICES, NAMELY, PROVIDING A WEBSITE FEATURING MUSICAL PERFORMANCES, MUSICAL VIDEOS, RELATED FILM CLIPS, PHOTOGRAPHS AND OTHER MULTIMEDIA MATERIAL; PROVIDING AN ON-LINE COMPUTER DATABASE IN THE FIELD OF ENTERTAINMENT AND MUSIC; PROVIDING, ARRANGING, ORGANIZING, CONDUCTING AND PRESENTING LIVE MUSICAL PERFORMANCES; ENTERTAINMENT IN THE NATURE OF COMPETITIONS IN THE FIELD OF VISUAL AND AUDIO PERFORMANCES, NAMELY MUSICAL BANDS AND DISK JOCKEYS (U.S. CLS. 100, 101 AND 107).
FIRST USE 7-15-2000; IN COMMERCE 7-15-2000.

SN 78-022,083. DALLAS BASKETBALL LIMITED, DALLAS, TX. FILED 8-21-2000.



OWNER OF U.S. REG. NOS. 1,235,457, 2,001,223 AND OTHERS.

SEC. 2(F) AS TO "DALLAS".

FOR ENTERTAINMENT AND EDUCATIONAL SERVICES IN THE NATURE OF ONGOING TELEVISION AND RADIO PROGRAMS IN THE FIELD OF BASKETBALL AND RENDERING LIVE BASKETBALL GAMES AND BASKETBALL EXHIBITIONS; THE PRODUCTION AND DISTRIBUTION OF RADIO AND TELEVISION BROADCASTS OF BASKETBALL GAMES, BASKETBALL EVENTS AND PROGRAMS IN THE FIELD OF BASKETBALL; CONDUCTING AND ARRANGING BASKETBALL CLINICS AND COACHES CLINICS AND BASKETBALL EVENTS; ENTERTAINMENT SERVICES, NAMELY PROVIDING A WEBSITE FEATURING TELEVISION HIGHLIGHTS, INTERACTIVE TELEVISION HIGHLIGHTS, VIDEO RECORDINGS, VIDEO STREAM RECORDINGS, INTERACTIVE VIDEO HIGHLIGHT SELECTIONS, RADIO PROGRAMS, RADIO HIGHLIGHTS, AND AUDIO RECORDINGS IN THE FIELD OF BASKETBALL; ENTERTAINMENT AND EDUCATIONAL SERVICES, NAMELY PROVIDING A WEBSITE FEATURING INFORMATION ABOUT BASKETBALL IN THE NATURE OF BASKETBALL NEWS, BASKETBALL STATISTICS, AND PUBLIC OPINION ABOUT BASKETBALL; ENTERTAINMENT SERVICES, NAMELY PROVIDING A WEBSITE FEATURING ON-LINE COMPUTER GAMES, VIDEO GAMES, INTERACTIVE VIDEO GAMES, ACTION SKILL GAMES, ARCADE GAMES, ADULTS' AND CHILDREN'S PARTY GAMES, BOARD GAMES, TRIVIA GAMES, TRIVIA GAMES, AND COLORING BOOKS (U.S. CLS. 100, 101 AND 107).

CLASS 41—(Continued).

SN 78-024,017. BNC PRODUCTIONS, INC., LARGO, FL. FILED 9-1-2000.

DO GIRLS

NO CLAIM IS MADE TO THE EXCLUSIVE RIGHT TO USE "GIRLS", APART FROM THE MARK AS SHOWN.

FOR ENTERTAINMENT SERVICES NAMELY, PROVIDING A LIVE WEBCAST OF FEMALE MODELS (U.S. CLS. 100, 101 AND 107).

SN 78-026,500. AZMYTH ENTERTAINMENT, PITTSBURGH, PA. FILED 9-18-2000.

AZMYTH ENTERTAINMENT

NO CLAIM IS MADE TO THE EXCLUSIVE RIGHT TO USE "ENTERTAINMENT", APART FROM THE MARK AS SHOWN.

FOR ENTERTAINMENT SERVICES, NAMELY, THE PRODUCTION AND DISTRIBUTION OF MOTION PICTURES (U.S. CLS. 100, 101 AND 107).

SN 78-029,221. WOEGER, ADAM, COLORADO SPRINGS, CO. FILED 10-5-2000.

DEEP WORSHIP

NO CLAIM IS MADE TO THE EXCLUSIVE RIGHT TO USE "WORSHIP", APART FROM THE MARK AS SHOWN.

FOR MUSIC PUBLISHING SERVICES; EDUCATIONAL SERVICES, NAMELY CONDUCTING CLASSES OF INSTRUCTION AND SEMINARS IN THE FIELD OF RELIGION; ENTERTAINMENT SERVICES, NAMELY, PROVIDING LIVE RELIGIOUS AND INSTRUMENTAL MUSICAL PERFORMANCES, CONCERT BOOKING SERVICES, SONG WRITING SERVICES AND COMPOSING MUSIC FOR USE BY OTHERS (U.S. CLS. 100, 101 AND 107).
FIRST USE 7-14-2000; IN COMMERCE 7-14-2000.

SN 78-030,205. FERREIRA, DANIEL GRANT, HAYWARD, CA. FILED 10-11-2000.



FOR MATHEMATICAL SPORTS RATING SERVICES, NAMELY, RATING, RANKING, AND PROVIDING STATISTICAL INFORMATION OF SPORTS HANDICAPPING PROFESSIONALS BY SPORT CATEGORY (U.S. CLS. 100, 101 AND 107).

CLASS 41—(Continued).

SN 78-030,833. WISCONSIN PUBLIC BROADCASTING FOUNDATION, INC., MADISON, WI. FILED 10-16-2000.

WISKID

FOR ANNUAL AWARD PROGRAM TO ENCOURAGE EXCELLENCE IN THE FIELD OF MOTION PICTURE FILMS BY PRESENTATION OF AWARDS TO THE WINNING SELECTIONS OF AN INTERNATIONAL FILM FESTIVAL HELD IN WISCONSIN (U.S. CLS. 100, 101 AND 107).

SN 78-032,827. DAWSON, JANA Z., FENTRESS, TX. FILED 10-29-2000.



FOR EDUCATIONAL SERVICES, NAMELY HORSE-BACK RIDING LESSONS FOR BEGINNING STUDENTS WHICH FEATURES EXERCISES TO ENABLE THE STUDENT TO DEVELOP A SAFE AND BALANCED SEAT (U.S. CLS. 100, 101 AND 107).

SN 78-033,450. SASSARIS, TAKI, RIVERVALE, NJ. FILED 11-2-2000.

EVE TO ADAM.

FOR ENTERTAINMENT SERVICES NAMELY LIVE PERFORMANCES BY A MUSICAL GROUP (U.S. CLS. 100, 101 AND 107).
FIRST USE 8-1-1997; IN COMMERCE 11-1-1997.

SN 78-034,153. ASSOCIATED GENERAL CONTRACTORS OF OHIO, COLUMBUS, OH. FILED 11-7-2000.

BUILD OHIO

NO CLAIM IS MADE TO THE EXCLUSIVE RIGHT TO USE "OHIO", APART FROM THE MARK AS SHOWN.
FOR ORGANIZING AND CONDUCTING AN ANNUAL AWARDS PRESENTATION FOR COMMERCIAL CONTRACTORS TO RECOGNIZE EXCELLENCE IN THE CONSTRUCTION OF A PARTICULAR PROJECT (U.S. CLS. 100, 101 AND 107).

CLASS 41—(Continued).

SN 78-036,600. CURTIS, ANDREW, F, VERSAILLES, KY. FILED 11-27-2000.

FARK

FOR PROVIDING ENTERTAINMENT NEWS AND INFORMATION, NAMELY, PROVIDING COMEDIC CAPTIONS AND PICTURES ABOUT CURRENT EVENTS AND NEWS STORIES, AND PROVIDING ON-LINE LINKS TO WEBSITES OF OTHERS IN CONNECTION THEREWITH (U.S. CLS. 100, 101 AND 107).

SN 78-037,112. EVENTSTYLE, INC., NEW YORK, NY. FILED 11-29-2000.

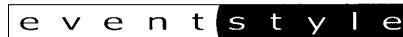

NO CLAIM IS MADE TO THE EXCLUSIVE RIGHT TO USE "EVENT", APART FROM THE MARK AS SHOWN.
FOR CORPORATE, PRIVATE AND PUBLIC EVENT PLANNING AND PRODUCTION SERVICES (U.S. CLS. 100, 101 AND 107).
FIRST USE 0-0-1999; IN COMMERCE 3-0-2000.

SN 78-037,221. INSTITUTO DE COMPUTACION Y METODOS, SA: DE CV, COLONIA JUAREZ, MEXICO, FILED 11-30-2000.

ICM.COM

OWNER OF MEXICO REG. NO. 620022, DATED 6-16-1999, EXPIRES 6-16-2009.
OWNER OF U.S. REG. NO. 2,418,870.
FOR PROVIDING TEACHING, TRAINING AND INSTRUCTION IN THE FIELD OF COMPUTERS, INFORMATION TECHNOLOGY AND DATA PROCESSING (U.S. CLS. 100, 101 AND 107).

SN 78-037,432. CYA CREATIONS, LLC, CHARLOTTE, NC. FILED 12-1-2000.

COMPACT BROADWAY

NO CLAIM IS MADE TO THE EXCLUSIVE RIGHT TO USE "BROADWAY", APART FROM THE MARK AS SHOWN.
FOR ENTERTAINMENT SERVICES, NAMELY, ONGOING RADIO SHOWS IN THE FIELD OF BROADWAY MUSIC AND FEATURING BROADCASTS OF PRERECORDED BROADWAY-STYLE MUSICALS (U.S. CLS. 100, 101 AND 107).

CLASS 41—(Continued).

SN 78-037,628. VIACOM INTERNATIONAL INC., NEW YORK, NY. FILED 12-4-2000.

MTV SPYDER GAMES

OWNER OF U.S. REG. NOS. 1,955,606 AND 1,985,017.
NO CLAIM IS MADE TO THE EXCLUSIVE RIGHT TO USE "GAMES", APART FROM THE MARK AS SHOWN.
FOR ENTERTAINMENT SERVICES IN THE NATURE OF A TELEVISION SERIES FEATURING LIVE ACTION AND DRAMA; PROVIDING INFORMATION IN THE FIELD OF ENTERTAINMENT FEATURING LIVE ACTION AND DRAMA RENDERED VIA A GLOBAL COMPUTER NETWORK (U.S. CLS. 100, 101 AND 107).

SN 78-037,673. TURNER ENTERTAINMENT CO., ATLANTA, GA. FILED 12-4-2000.

RUBY SLIPPERS

FOR ENTERTAINMENT SERVICES IN THE NATURE OF LIVE-ACTION, COMEDY, DRAMA AND ANIMATED ON-GOING TELEVISION PROGRAMS; PRODUCTION OF LIVE-ACTION, COMEDY, DRAMA AND/OR ANIMATED TELEVISION PROGRAMS; ENTERTAINMENT SERVICES IN THE NATURE OF DISTRIBUTION OF LIVE-ACTION, COMEDY, DRAMA AND ANIMATED MOTION PICTURE THEATRICAL FILMS; PRODUCTION OF LIVE-ACTION, COMEDY, DRAMA AND ANIMATED MOTION PICTURE THEATRICAL FILMS; THEATRICAL PERFORMANCES BOTH ANIMATED AND LIVE ACTION; AND PROVIDING AN ON-LINE COMPUTER DATABASE IN THE FIELD OF GENERAL INTEREST NEWS, ENTERTAINMENT AND EDUCATIONAL INFORMATION VIA A GLOBAL COMPUTER NETWORK (U.S. CLS. 100, 101 AND 107).

SN 78-038,663. FOUNDATION FOR THE ADVANCEMENT OF MONETARY EDUCATION, LTD, NEW YORK, NY. FILED 12-11-2000.

GLOBAL CURRENCY INITIATIVE

NO CLAIM IS MADE TO THE EXCLUSIVE RIGHT TO USE "GLOBAL CURRENCY", APART FROM THE MARK AS SHOWN.
FOR EDUCATIONAL SERVICES, NAMELY CONDUCTING SEMINARS AND CONFERENCES IN THE FIELD OF CURRENCY STANDARDS AND DEFINITIONS (U.S. CLS. 100, 101 AND 107).

CLASS 41—(Continued).

SN 78-039,032. SEATTLE SHAKESPEARE FESTIVAL, THE, DBA SEATTLE SHAKESPEARE COMPANY, SEATTLE, WA. FILED 12-12-2000.



NO CLAIM IS MADE TO THE EXCLUSIVE RIGHT TO USE "SEATTLE SHAKESPEARE COMPANY", APART FROM THE MARK AS SHOWN.

FOR ENTERTAINMENT SERVICES IN THE NATURE OF CLASSIC THEATRE PRODUCTIONS FEATURING WORKS BY SHAKESPEARE; EDUCATIONAL SERVICES, NAMELY CONDUCTING EDUCATIONAL CLASSES AND WORKSHOPS IN THE FIELD OF ACTING AND LIVE THEATRE PRODUCTIONS; PUBLICATION OF BOOKS, NEWSLETTERS AND OTHER EDUCATIONAL MATERIALS RELATED TO PERFORMING ARTS (U.S. CLS. 100, 101 AND 107).

FIRST USE 6-13-2000; IN COMMERCE 10-21-2000.

SN 78-042,038. MCCULLOUGH, TODD M., SOMERSET, NJ. FILED 1-7-2001.

HOLY GOATS

FOR ENTERTAINMENT SERVICES, NAMELY, LIVE PERFORMANCES BY A MUSICAL BAND (U.S. CLS. 100, 101 AND 107).

FIRST USE 11-13-1999; IN COMMERCE 5-8-2000.

SN 78-044,146. KESSLER, JUSTIN A., MALVERNE, NY. FILED 1-20-2001.

GAS FOOD & LODGING

FOR ENTERTAINMENT NAMELY, LIVE PERFORMANCES BY A MUSICAL BAND (U.S. CLS. 100, 101 AND 107).

CLASS 41—(Continued).

SN 78-046,231. MILLSTEIN, MITCHELL A., ST. CHARLES, MO. FILED 2-2-2001.

VISUAL VELOCITY

OWNER OF U.S. REG. NOS. 2,412,085 AND 2,412,087.
NO CLAIM IS MADE TO THE EXCLUSIVE RIGHT TO USE "VISUAL", APART FROM THE MARK AS SHOWN.
FOR EDUCATIONAL SERVICES, NAMELY CONDUCTING WORKSHOPS AND SEMINARS IN THE FIELD OF IMPROVING VISUAL CONTROL AND WORKPLACE ORGANIZATION OF OPERATIONS FACILITIES. (U.S. CLS. 100, 101 AND 107).
FIRST USE 10-31-2000; IN COMMERCE 10-31-2000.

SN 78-049,807. FORSTER, TONI, SCOTTSDALE, AZ. AND HIGGINS, JOANNE, LOS ANGELES, CA. FILED 2-22-2001.

THESAURUS REX

FOR ENTERTAINMENT, NAMELY, A CONTINUING CHILDREN'S SHOW DISTRIBUTED OVER TELEVISION, SATELLITE, AUDIO AND VIDEO MEDIA (U.S. CLS. 100, 101 AND 107).

SN 78-051,253. ASHEN, ROY, M., BURBANK, CA. FILED 3-3-2001.

THE CRASH POETS

FOR ENTERTAINMENT NAMELY, LIVE PERFORMANCE BY A MUSICAL BAND (U.S. CLS. 100, 101 AND 107).
FIRST USE 0-0-1998; IN COMMERCE 0-0-1999.

SN 78-053,950. NEW PLAINSMEN QUARTET, INC., THE, CHICKASHA, OK. FILED 3-20-2001.

**THE NEW PLAINSMEN
QUARTET**

NO CLAIM IS MADE TO THE EXCLUSIVE RIGHT TO USE "QUARTET", APART FROM THE MARK AS SHOWN.
FOR ENTERTAINMENT SERVICES, NAMELY, LIVE PERFORMANCES BY A VOCAL-INSTRUMENTAL GROUP (U.S. CLS. 100, 101 AND 107).
FIRST USE 11-24-1999; IN COMMERCE 11-24-1999.

CLASS 41—(Continued).

SN 78-054,792. TWENTIETH CENTURY FOX FILM CORPORATION, LOS ANGELES, CA. FILED 3-23-2001.



OWNER OF U.S. REG. NOS. 2,077,628, 2,417,795 AND OTHERS.

NO CLAIM IS MADE TO THE EXCLUSIVE RIGHT TO USE "KIDS CUP", APART FROM THE MARK AS SHOWN.
FOR ENTERTAINMENT SERVICES IN THE NATURE OF SOCCER TOURNAMENTS (U.S. CLS. 100, 101 AND 107).

FIRST USE 7-5-2000; IN COMMERCE 7-5-2000.

SN 78-057,190. TERRILL, THOMAS, E., PALO ALTO, CA. FILED 4-6-2001.

SHATTERED KINGDOMS

FOR ENTERTAINMENT SERVICES, NAMELY, PROVIDING AN ON-LINE COMPUTER GAME (U.S. CLS. 100, 101 AND 107).
FIRST USE 5-0-1995; IN COMMERCE 1-0-1996.

SN 78-061,515. SELLINGER, ARTHUR B., SOUTHLAKE, TX. FILED 5-2-2001.

**WORLD LONG DRIVE
CHAMPIONSHIP**

NO CLAIM IS MADE TO THE EXCLUSIVE RIGHT TO USE "LONG DRIVE CHAMPIONSHIP", APART FROM THE MARK AS SHOWN.
FOR ENTERTAINMENT IN THE NATURE OF GOLF TOURNAMENTS (U.S. CLS. 100, 101 AND 107).

CLASS 41—(Continued).

SN 78-061,692. HARRIS, CARL L., JR., CHICAGO, IL. FILED 5-2-2001.

PHAT GROOV RECORDINGS

NO CLAIM IS MADE TO THE EXCLUSIVE RIGHT TO USE "RECORDINGS", APART FROM THE MARK AS SHOWN.

FOR ENTERTAINMENT SERVICES, NAMELY, PROVIDING A WEBSITE FEATURING MUSICAL PERFORMANCES, MUSICAL VIDEOS, RELATED FILM CLIPS, PHOTOGRAPHS, AND OTHER MULTIMEDIA MATERIALS; PRODUCTION OF MUSICAL SOUND RECORDINGS AND AUDIO VISUAL SOUND RECORDINGS; RECORDING STUDIO SERVICES (U.S. CLS. 100, 101 AND 107).

FIRST USE 11-1-1999; IN COMMERCE 1-25-2001.

SN 78-065,231. HOLLAND, DANIEL S., BOWIE, MD. FILED 5-23-2001.

ANIMAL

FOR LIVE MUSICAL PERFORMANCES BY AN INDIVIDUAL (U.S. CLS. 100, 101 AND 107).

SN 78-065,346. DARMONTE ENTERPRISES, INC., WEST PALM BEACH, FL. FILED 5-23-2001.



NO CLAIM IS MADE TO THE EXCLUSIVE RIGHT TO USE "PARKINSON'S DISEASE", APART FROM THE MARK AS SHOWN.

THE LINING SHOWN IN THE DRAWING IS A FEATURE OF THE MARK AND NOT INTENDED TO INDICATE COLOR. THE STIPPLING SHOWN IN THE DRAWING IS A FEATURE OF THE MARK AND NOT INTENDED TO INDICATE COLOR.

FOR ARRANGING AND CONDUCTING ATHLETIC COMPETITIONS, NAMELY A FOOTRACE, FOR THE PURPOSE OF RAISING FUNDS TO FIND A CURE FOR PARKINSON'S DISEASE (U.S. CLS. 100, 101 AND 107).

CLASS 41—(Continued).

SN 78-067,071. BELTRAN, ALBERTO, SAN DIEGO, CA. FILED 6-3-2001.

HIJOS DE SANCHO

THE TRANSLATION OF "HIJOS DE SANCHO" IS SPANISH FOR "SONS OF SANCHO" OR "CHILDREN OF SANCHO".

FOR ENTERTAINMENT, NAMELY, LIVE MUSIC PERFORMANCES BY A BAND (U.S. CLS. 100, 101 AND 107).

SN 78-072,470. SCHNELL, DONALD, B., NAPLES, FL. FILED 7-5-2001.

ENLIGHTENMENT 101

FOR PROVIDING EDUCATIONAL SERVICES, NAMELY LECTURES, COURSES, SEMINARS AND OTHER PROGRAMS FOR SPIRITUAL DEVELOPMENT AND THE GOOD HEALTH (U.S. CLS. 100, 101 AND 107). FIRST USE 2-4-2001; IN COMMERCE 3-1-2001.

SN 78-074,211. DELEON, KENNETH, JACK, BOCA RATON, FL. FILED 7-16-2001.

SELFPROCLAIMEDGENIUS

FOR EDUCATIONAL SERVICES, NAMELY, PROVIDING LECTURES AND CONDUCTING CLASSES, SEMINARS, CONFERENCES, AND WORKSHOPS IN THE FIELDS OF PHILOSOPHY, PSYCHOLOGY, SELF-AWARENESS, AND PERSONAL GROWTH (U.S. CLS. 100, 101 AND 107).

SN 78-079,192. RITZ-CARLTON HOTEL COMPANY, L.L.C., THE, BETHESDA, MD. FILED 8-14-2001.

THE RITZ-CARLTON SPA

OWNER OF U.S. REG. NOS. 1,094,823, 2,386,118 AND OTHERS.

NO CLAIM IS MADE TO THE EXCLUSIVE RIGHT TO USE "SPA", APART FROM THE MARK AS SHOWN.

FOR PHYSICAL FITNESS INSTRUCTION SERVICES; HEALTH CLUB SERVICES (U.S. CLS. 100, 101 AND 107).

SN 78-083,811. DON SHAW, INC., ATLANTA, GA. FILED 9-13-2001.

YOU CAN MAKE A DIFFERENCE

FOR DEVELOPMENT AND DISSEMINATION OF EDUCATIONAL MATERIALS TO COSMETOLOGISTS FOR DETECTION OF MELANOMA (U.S. CLS. 100, 101 AND 107).

CLASS 41—(Continued).

SN 78-084,164. PHILLIPS, DORETHA B., DBA KIDZQWEST TECHNOLOGY LEARNING CENTER, LIBERTY HILL, TX. FILED 9-17-2001.

KidzQWEST

FOR COMPUTER EDUCATION TRAINING SERVICES (U.S. CLS. 100, 101 AND 107).

CLASS 42—SCIENTIFIC, COMPUTER AND LEGAL SERVICES

SN 75-425,833, 768458 ALBERTA LTD., EDMONTON, ALBERTA, CANADA. BY ASSIGNMENT MAD JACK HOLDINGS, LTD., EDMONTON, ALBERTA, T5N 4A3, CANADA, FILED 1-29-1998.

STACCATO'S

OWNER OF CANADA REG. NO. TMA509958, DATED 3-25-1999, EXPIRES 3-25-2014.
FOR TAKE-OUT FOOD AND BEVERAGE RESTAURANT SERVICES (U.S. CLS. 100 AND 101).

SN 75-556,798. BASS PRO TRADEMARKS, L.L.C., SPRINGFIELD, MO. BY CHANGE OF NAME BASS PRO TRADEMARKS, L.P., SPRINGFIELD, MO. FILED 9-22-1998.

OUTDOOR WORLD

OWNER OF U.S. REG. NOS. 1,950,067, 2,207,865 AND OTHERS.
FOR SERVICES NAMELY HOTEL SERVICES (U.S. CLS. 100 AND 101).

SN 75-612,505. SURVEILLANCE DATA, INC., PLYMOUTH MEETING, PA. FILED 12-28-1998.

AAN ALLERGY ACTIVITY NOTIFICATION PROGRAM

FOR RESEARCH IN THE FIELD OF DISEASES (U.S. CLS. 100 AND 101).
FIRST USE 0-0-1989; IN COMMERCE 0-0-1989.

CLASS 42—(Continued).

SN 75-688,166. ITECH, LLC, NORTH CHARLESTON, SC. FILED 4-26-1999.

MANTEK

FOR CONSULTATION SERVICES IN THE FIELD OF TRAINING AND DEVELOPMENT IN USING COMPUTER MULTI-MEDIA APPLICATIONS, APPLICATION SOFTWARE AND NETWORKING; ELECTRONIC PUBLISHING SERVICES, NAMELY, DEVELOPMENT AND PUBLICATION FOR OTHERS OF TECHNICAL MANUALS FOR USE OF COMPUTER HARDWARE AND SOFTWARE (U.S. CLS. 100 AND 101).
FIRST USE 12-31-1990; IN COMMERCE 12-31-1990.

SN 75-691,786. MALL4U INC., MONTCLAIR, NJ. FILED 4-26-1999.

MALL4U

FOR COMPUTER SERVICES, NAMELY DESIGN, CREATION AND MAINTENANCE OF WEB SITES FOR OTHERS; HOSTING OF WEB SITES FOR OTHERS ON A COMPUTER SERVER FOR A GLOBAL COMPUTER NETWORK; CONSULTING AND TECHNICAL ASSISTANCE IN THE FIELD OF DESIGN, CREATION, HOSTING, AND MAINTENANCE OF ONLINE FACILITIES FOR REAL-TIME INTERACTION WITH OTHER COMPUTER USERS (U.S. CLS. 100 AND 101).

SN 75-700,865. XILINX, INC., SAN JOSE, CA. FILED 5-7-1999.

SILICON XPRESSO

NO CLAIM IS MADE TO THE EXCLUSIVE RIGHT TO USE "SILICON", APART FROM THE MARK AS SHOWN.
FOR PROVIDING AND EXCHANGING INFORMATION IN THE FIELD OF PROGRAMMABLE LOGIC DEVICE TECHNOLOGY VIA GLOBAL COMMUNICATIONS NETWORK; PROVIDING AND EVALUATING PROGRAMMABLE LOGIC DEVICE TECHNOLOGY VIA GLOBAL COMMUNICATION NETWORK; ONLINE INFORMATION SERVICES IN THE FIELD OF PROGRAMMABLE LOGIC DEVICE TECHNOLOGY; INFORMATION AND CONSULTING SERVICES, NAMELY, PROVIDING TEMPORARY USE OF NON-DOWNLOADABLE INTERACTIVE COMPUTER SOFTWARE FOR USE IN DESIGNING AND EVALUATING PROGRAMMABLE LOGIC DEVICES AND PROVIDING PROPRIETARY PROGRAMMABLE LOGIC DEVICE TECHNOLOGY, TECHNICAL DESCRIPTIONS AND SOLUTIONS RELATING TO PROGRAMMABLE LOGIC DEVICE AND ARCHITECTURE, AND IMPLEMENTATION INSTRUCTIONS AND INFORMATION TO FACILITATE RECONFIGURING PROGRAMMABLE LOGIC DEVICES (U.S. CLS. 100 AND 101).
FIRST USE 9-9-1998; IN COMMERCE 9-9-1998.

CLASS 42—(Continued).

SN 75-717,132. LIVE365 INC., FOSTER CITY, CA. BY CHANGE OF NAME NANOCOSM, INC., FOSTER CITY, CA. FILED 5-28-1999.

LIVE365

FOR COMPUTER SERVICES, NAMELY HOSTING WEB PAGES AND AUDIO PROGRAMS FOR OTHERS ON A COMPUTER SERVER FOR A GLOBAL COMPUTER NETWORK; APPLICATION SERVICE PROVIDER (ASP) FEATURING COMPUTER SOFTWARE FOR CREATING AND BROADCASTING AUDIO CONTENTS VIA ELECTRONIC OR OPTICAL COMMUNICATION NETWORKS (U.S. CLS. 100 AND 101).

SN 75-745,197. ALMEN LABORATORIES INCORPORATED, ESCONDIDO, CA. FILED 7-30-1999.

DATA COMPANION

NO CLAIM IS MADE TO THE EXCLUSIVE RIGHT TO USE "DATA", APART FROM THE MARK AS SHOWN.

FOR ON-LINE COMPUTER SERVICES, NAMELY, PROVIDING INFORMATION MANIPULATION VIA A GLOBAL COMPUTER NETWORK; STATISTICAL ANALYSIS; DATA MINING (U.S. CLS. 100 AND 101).

FIRST USE 10-7-1997; IN COMMERCE 8-9-1998.

SN 75-765,791. RONALD L. PACKARD, INC., SALEM, NH. FILED 8-2-1999.

DR. PLAY

FOR CUSTOM DESIGNING OF PLAYGROUND AND RECREATIONAL AREA EQUIPMENT FOR OTHERS (U.S. CLS. 100 AND 101).

FIRST USE 6-10-1987; IN COMMERCE 6-10-1987.

SN 75-784,700. GLOBAL MUSIC OUTLET, LLC, PACIFIC PALISADES, CA. FILED 8-26-1999.

SONG CENTRAL

NO CLAIM IS MADE TO THE EXCLUSIVE RIGHT TO USE "SONG", APART FROM THE MARK AS SHOWN.

FOR ON-LINE SEARCH ENGINE, NAMELY, PROVIDING TEMPORARY USE OF ON-LINE NON-DOWNLOADABLE SOFTWARE FOR SPECIALIZED SONG AND LYRIC SEARCH, NAMELY, SEARCHING SONGS AND LYRICS BY SONG OR LYRIC FRAGMENT, ARTIST, TITLE, AND BY AESTHETIC CRITERIA, NAMELY, TEMPO, VOCALS, VIBE, INSTRUMENTS, ORIGIN, ERA, AND SUBJECTS; AND COMPATIBLE WITH VARIOUS DIRECTORY PLATFORMS (U.S. CLS. 100 AND 101).

CLASS 42—(Continued).

SN 75-791,755. CELEBRATION GIFT BASKETS, INC., BELLEVUE, WA. FILED 9-1-1999.

CELEBRATION

FOR PREPARATION OF ALL OCCASION GIFT BASKETS AND HOUSEHOLD CONTAINERS CONTAINING ASSORTED PRODUCTS OF OTHERS (U.S. CLS. 100 AND 101).

FIRST USE 3-0-1987; IN COMMERCE 10-5-1988.

SN 75-794,190. HARRODS LIMITED, LONDON SW1X 7XL, ENGLAND, FILED 9-8-1999.

HARRODS

OWNER OF UNITED KINGDOM REG. NO. 1305593, DATED 3-31-1987, EXPIRES 3-31-2008.

SEC. 2(F).

FOR CAFES, CAFETERIAS, CANTEENS, CATERING, DRESS RENTAL, FASHION CONSULTATION SERVICES, PHOTOGRAPHY, PRINTING, LITHOGRAPHIC PRINTING, ROOM RENTAL OR LEASING, BEAUTY SALONS AND HAIRDRESSING SALONS (U.S. CLS. 100 AND 101).

SN 75-794,573. TELETECH HOLDINGS, INC., DENVER, CO. FILED 9-8-1999.

SMARTSEARCH

FOR PROVIDING TELEPHONE AND E-MAIL RESPONSES TO INCOMING CUSTOMERS' COMPUTER-RELATED INQUIRIES, COMMUNICATIONS, AND SUPPORT REQUESTS AT CUSTOMER SERVICE CALL CENTERS OF OTHERS; COMPUTER CONSULTATION SERVICES, NAMELY, DESIGNING CUSTOMER SERVICE WEB SITES FOR OTHERS AND CUSTOMER SERVICE SOFTWARE DESIGN FOR OTHERS; AND PROVIDING TELEPHONE AND E-MAIL RESPONSES TO INCOMING CUSTOMERS' COMPUTER-RELATED INQUIRIES, COMMUNICATIONS, AND SUPPORT REQUESTS AT CUSTOMER SERVICE CALL CENTERS OF OTHERS (U.S. CLS. 100 AND 101).

SN 75-797,788. NATIONAL GRID COMPANY PLC, THE, COVENTRY CV4 8JY, UNITED KINGDOM, FILED 9-13-1999.

NATIONAL GRID

SEC. 2(F).

FOR CONSULTATION SERVICES RELATING TO THE GENERATION, SUPPLY AND DISTRIBUTION OF ELECTRICITY AND TO COMMUNICATIONS APPARATUS AND INSTALLATIONS (U.S. CLS. 100 AND 101).

CLASS 42—(Continued).

SN 75-798,368. PERI, MICHAEL, BERNARDSVILLE, NJ. FILED 9-13-1999.

EPOINTMENTS.COM

FOR PROVIDING APPOINTMENT SCHEDULING SERVICES FOR OTHERS VIA A GLOBAL ELECTRONIC NETWORK (U.S. CLS. 100 AND 101).

CLASS 42—(Continued).

SN 75-821,632. UGO NETWORKS, INC., NEW YORK, NY. FILED 10-13-1999.

UGO

FOR PROVIDING INFORMATION ON TECHNOLOGY VIA A GLOBAL COMPUTER NETWORK; HOSTING WEB SITES OF OTHERS ON A COMPUTER SERVER FOR A GLOBAL COMPUTER NETWORK; DESIGNING AND IMPLEMENTING NETWORK WEB PAGES FOR OTHERS (U.S. CLS. 100 AND 101).
FIRST USE 12-0-1996; IN COMMERCE 12-0-1996.

SN 75-806,076. SPACE HARDWARE OPTIMIZATION TECHNOLOGY, INC., DBA SHOT, INC., FLOYD KNOBS, IN. FILED 9-22-1999.



NO CLAIM IS MADE TO THE EXCLUSIVE RIGHT TO USE "SPACE HARDWARE OPTIMIZATION TECHNOLOGY, INC.", APART FROM THE MARK AS SHOWN.

FOR ENGINEERING RESEARCH, DEVELOPMENT, TESTING, VERIFYING, AND INTEGRATING AND CUSTOM DESIGN FOR OTHERS OF METAL AND PLASTIC MACHINE TOOLS, INSTRUMENTS, AND COMPONENTS, FLIGHT HARDWARE, PHARMACEUTICAL, MEDICAL, CHEMICAL, AND BIOLOGICAL PROCESSING EQUIPMENT, AND COMPUTER SOFTWARE AND HARDWARE FOR BIOLOGICAL, PHARMACEUTICAL, MEDICAL, ELECTRICAL, AND CHEMICAL SYSTEMS FOR EARTH AND SPACE APPLICATIONS, INCLUDING DRAFTING SPECIFICATIONS FOR MANUFACTURE, AND CONSULTING SERVICES TO NASA REGARDING SAME (U.S. CLS. 100 AND 101).
FIRST USE 11-0-1988; IN COMMERCE 11-0-1988.

SN 75-829,374. AD-TECH MEDICAL INSTRUMENT CORPORATION, RACINE, WI. FILED 10-22-1999.

**THE PATIENT IS OUR
THOUGHT IN DEVICE
DESIGN THROUGH DEVICE
USE**

FOR CUSTOM DESIGNING AND DEVELOPING OF NEUROSURGICAL ELECTRODES, CONNECTORS, AND RELATED PARTS TO THE ORDER AND SPECIFICATION OF OTHERS AND RELATED CONSULTING SERVICES (U.S. CLS. 100 AND 101).
FIRST USE 8-1-1999; IN COMMERCE 8-1-1999.

SN 75-830,988. TELEMONITOR, INC., COLUMBIA, MD. FILED 10-25-1999.

SMARTBOATS

FOR MONITORING OPERATIONAL AND SECURITY SYSTEMS OF REMOTE OBJECTS, NAMELY VEHICLES, VEHICLE STORAGE FACILITIES AND RESIDENCES VIA A GLOBAL COMMUNICATIONS NETWORK (U.S. CLS. 100 AND 101).
FIRST USE 12-7-1998; IN COMMERCE 12-7-1998.

SN 75-820,189. NEMIROFF, ROBERT JAY, HOUGHTON, MI. FILED 10-31-1999.

**ASTRONOMY PICTURE OF
THE DAY**

SEC. 2(F).
FOR PROVIDING A WEBSITE ON GLOBAL COMPUTER NETWORKS FEATURING INFORMATION, PICTURES, AND LINKS TO WEB SITES OF OTHERS ALL IN THE FIELD OF ASTRONOMY (U.S. CLS. 100 AND 101).
FIRST USE 6-16-1995; IN COMMERCE 6-16-1995.

SN 75-831,034. GRACE-MAYER INSURANCE AGENCY, INC., OMAHA, NE. FILED 10-26-1999.

GRACE/MAYER

FOR CONSULTATION SERVICES IN THE FIELD OF SAFETY IN BUSINESS, INDUSTRY AND NONPROFIT ORGANIZATIONS ON THE PREVENTION OF INJURIES TO PEOPLE AND PROPERTY (U.S. CLS. 100 AND 101).
FIRST USE 7-1-1982; IN COMMERCE 7-1-1982.

CLASS 42—(Continued).

SN 75-835,178. MATTEL, INC., EL SEGUNDO, CA. FILED 11-15-1999.

ITSSWELL.COM

FOR COMPUTER SERVICES, NAMELY, PROVIDING NEWS DATABASES, ON-LINE MAGAZINES, FACTS AND DATA REGARDING CONTEMPORARY POP CULTURE RELATING TO TOYS VIA A WEBSITE ON THE GLOBAL COMPUTER NETWORK (U.S. CLS. 100 AND 101).

SN 75-843,304. YACHT WATCHMAN INTERNATIONAL, INC., POWAY, CA. BY ASSIGNMENT; BY ASSIGNMENT JAMES KNOSKA INDUSTRIES, LTD., LAKE FOREST, IL. FILED 11-8-1999.

DOCKMASTER PLAN

NO CLAIM IS MADE TO THE EXCLUSIVE RIGHT TO USE "PLAN", APART FROM THE MARK AS SHOWN.

FOR YACHT AND MARINE SYSTEMS MONITORING SERVICES, NAMELY, VISUAL INSPECTION AT THE DOCK OR MOORING OF EXTERIOR LINES, EXTERIOR ELECTRICAL CONNECTIONS, EXTERIOR ENTRY AREAS, EXTERIOR COVERINGS, GROUND TACKLE, INTERIOR ELECTRICAL COMPONENTS, BILGES, ENGINE ROOM AND THROUGH HULL FITTINGS OF YACHTS AND OTHER MARINE VESSELS, AND COMPUTERIZED REPORTING OF RESULTS (U.S. CLS. 100 AND 101).

SN 75-854,065. CYBER-CARE, INC., BOYNTON BEACH, FL. FILED 11-19-1999.

CYBER-CARE

FOR PROVIDING MEDICAL INFORMATION AND SERVICES OVER THE GLOBAL COMPUTER INFORMATION NETWORK (U.S. CLS. 100 AND 101).

FIRST USE 8-0-1999; IN COMMERCE 8-0-1999.

SN 75-862,597. INTRINSIC TECHNOLOGIES, L.L.C., LISLE, IL. FILED 12-2-1999.

SWIMAGE

FOR CONSULTING SERVICES IN THE FIELD OF COMPUTERIZED INFORMATION PROCESSING SYSTEMS, NAMELY, WORKSTATION DEPLOYMENT, MIGRATION SERVICES, NETWORK CARE, LAN/WAN SERVICES AND GLOBAL AND IN-HOUSE COMPUTER NETWORK SERVICES (U.S. CLS. 100 AND 101).

FIRST USE 7-1-1997; IN COMMERCE 7-1-1997.

CLASS 42—(Continued).

SN 75-909,865. HEINTZE, SIEGFRIED, BOULDER, CO. FILED 2-4-2000.



FOR COMPUTER SERVICES, NAMELY, PROVIDING COMPUTER CONSULTING SERVICES; COMPUTER SOFTWARE DEVELOPMENT AND DESIGN SERVICES; AND DESIGNING AND IMPLEMENTING WEB SITES FOR OTHERS (U.S. CLS. 100 AND 101).

SN 75-912,786. FLAGSHIPNET.COM, INC., ATLANTA, GA. FILED 2-8-2000.

BIGCLIX.COM

FOR DESIGNING AND HOSTING WEB SITES FOR OTHERS ON A GLOBAL COMPUTER NETWORK (U.S. CLS. 100 AND 101).

SN 75-912,983. SAHLGREN, MYLES R., TALLAHASSEE, FL. FILED 2-7-2000.

VEGETARIAN WORLD

OWNER OF U.S. REG. NOS. 1,939,748 AND 1,939,789. NO CLAIM IS MADE TO THE EXCLUSIVE RIGHT TO USE "VEGETARIAN", APART FROM THE MARK AS SHOWN.

FOR RESTAURANTS FEATURING VEGETARIAN CUISINE (U.S. CLS. 100 AND 101).

SN 75-922,894. USER TELECOMMUNICATIONS & TECHNOLOGIES, INC., MANASSAS, VA. FILED 2-18-2000.

UT&T

FOR COMPUTER SOFTWARE DESIGN FOR OTHERS; COMPUTER SERVICES, NAMELY DESIGNING AND IMPLEMENTING NETWORK WEB PAGES FOR OTHERS; COMPUTER SOFTWARE MAINTENANCE (U.S. CLS. 100 AND 101).

FIRST USE 3-1-1999; IN COMMERCE 3-1-1999.

CLASS 42—(Continued).

SN 75-923,488. AGING EXCELLENCE, INC., PORTLAND, ME. FILED 2-18-2000.

**AGING
EXCELLENCE**



Seniors On The Go

NO CLAIM IS MADE TO THE EXCLUSIVE RIGHT TO USE "AGING EXCELLENCE", APART FROM THE MARK AS SHOWN.

THE MARK CONSISTS OF FIGURES IN THE DRAWING LINED, LEFT TO RIGHT, FOR THE COLORS GREEN, BLUE, FUCHSIA, RED, ORANGE AND YELLOW.

FOR PROVIDING SUPPORT SERVICES FOR SENIOR CITIZENS TO ASSIST INDIVIDUALS TO REMAIN ACTIVE AND INDEPENDENT, NAMELY, SENIOR DAY CARE AND COMPANIONSHIP, AND PERSONAL SHOPPING SERVICES (U.S. CLS. 100 AND 101).

SN 75-925,559. OKURA, ALBERT R., SAN BERNARDINO, CA. FILED 2-10-2000.

JUAN POLLO

NO CLAIM IS MADE TO THE EXCLUSIVE RIGHT TO USE "POLLO", APART FROM THE MARK AS SHOWN.

FOR RESTAURANTS, NAMELY, FAST FOOD ROTISSERIE CHICKEN RESTAURANTS (U.S. CLS. 100 AND 101).

SN 75-929,154. MASSHOST.COM, LLC, EAST WEYMOUTH, MA. FILED 2-25-2000.

MASSHOST

FOR HOSTING OF WEB SITES OF OTHERS ON A COMPUTER SERVER FOR A GLOBAL COMPUTER NETWORK (U.S. CLS. 100 AND 101).

FIRST USE 1-0-2000; IN COMMERCE 1-0-2000.

SN 75-930,037. IN PHASE INTERNATIONAL, INC., TEMPE, AZ. FILED 2-11-2000.

LINKUSADOCTOR

FOR PROVIDING MEDICAL INFORMATION VIA THE INTERNET (U.S. CLS. 100 AND 101).

FIRST USE 8-1-1999; IN COMMERCE 8-1-1999.

CLASS 42—(Continued).

SN 75-930,307. MULTIMEDIA EDV-SOFTWARE UND VERLAG GMBH, VIENNA, AUSTRIA, FILED 2-13-2000.

WHOIX

FOR COMPUTER SERVICES, NAMELY, PROVIDING SEARCH ENGINES WHICH ORGANIZE AND ALLOW USERS TO ACCESS A WIDE VARIETY OF INFORMATION ON A GLOBAL COMPUTER NETWORK (U.S. CLS. 100 AND 101).

FIRST USE 2-2-2000; IN COMMERCE 2-2-2000.

SN 75-930,386. IN PHASE INTERNATIONAL, INC., TEMPE, AZ. FILED 2-14-2000.

LINKUSALAWYER

FOR PROVIDING MEDICAL INFORMATION VIA THE INTERNET (U.S. CLS. 100 AND 101).

FIRST USE 8-1-1999; IN COMMERCE 8-1-1999.

SN 75-930,388. IN PHASE INTERNATIONAL, INC., TEMPE, AZ. FILED 2-14-2000.

**WE ARE IN THE BUSINESS
OF LINKING GLOBAL
HEALTHCARE.**

FOR PROVIDING MEDICAL INFORMATION VIA THE INTERNET (U.S. CLS. 100 AND 101).

FIRST USE 8-1-1999; IN COMMERCE 8-1-1999.

SN 75-934,561. BAKERY, CONFECTIONERY, TOBACCO WORKERS AND GRAIN MILLERS INTERNATIONAL UNION, KENSINGTON, MD. FILED 3-4-2000.

**FROM THE WORKPLACE TO
THE MARKETPLACE**

FOR LABOR UNION SERVICES (U.S. CLS. 100 AND 101).

FIRST USE 7-0-1994; IN COMMERCE 7-0-1994.

CLASS 42—(Continued).

SN 75-934,565. BAKERY, CONFECTIONERY, TOBACCO WORKERS AND GRAIN MILLERS INTERNATIONAL UNION, KENSINGTON, MD. FILED 3-4-2000.

**SU MEMBRECIA EN BCTGM
LE DA PODER**

THE ENGLISH TRANSLATION OF "SU MEMBRECIA EN BCTGM LE DA PODER" IS "YOUR MEMBERSHIP IN THE BCTGM GIVES YOU POWER".

FOR LABOR UNION SERVICES (U.S. CLS. 100 AND 101).

FIRST USE 7-0-1994; IN COMMERCE 7-0-1994.

SN 75-934,975. VETERANS CREMATION SOCIETY, INC., HARRISBURG, PA. FILED 3-3-2000.

**VETERANS CREMATION
SOCIETY**

SEC. 2(F).
FOR SERVICES FOR THE CREMATION OF HUMAN REMAINS (U.S. CLS. 100 AND 101).
FIRST USE 2-1-1999; IN COMMERCE 2-1-1999.

SN 75-937,854. BEACON TECHNOLOGIES, INC., GREENSBORO, NC. FILED 3-7-2000.

**IT'S TIME TO SEE THE
LIGHT**

FOR COMPUTER CONSULTING SERVICES, NAMELY, DEVELOPING, DESIGNING, AND IMPLEMENTING ELECTRONIC COMMERCE SYSTEMS FOR OTHERS (U.S. CLS. 100 AND 101).

CLASS 42—(Continued).

SN 75-942,281. WEBINTELLECTS, INC., VISTA, CA. FILED 3-13-2000.



THE STIPPLING SHOWN IN THE DRAWING IS A FEATURE OF THE MARK AND NOT INTENDED TO INDICATE COLOR. IT IS FOR SHADING PURPOSES ONLY.

FOR HOSTING THE WEB SITES OF OTHERS ON A COMPUTER SERVER FOR A GLOBAL COMPUTER NETWORK; COMPUTER SERVICES, NAMELY, DESIGNING AND IMPLEMENTING WEB SITES FOR OTHERS; COMPUTER ELECTRONIC COMPUTER SERVICES, NAMELY, DESIGN AND MAINTENANCE OF WEB SITES FOR OTHERS, VIA A GLOBAL COMPUTER NETWORK, AND PROVIDING ON-LINE TRANSACTION THIRD PARTY DEBIT ACCOUNT SERVICES VIA A GLOBAL COMPUTER INFORMATION NETWORK; PROVIDING COMPUTER DIAL-UP SERVICES AND INFORMATION TO SUBSCRIBERS IN THE FIELD OF SMALL BUSINESS AND PERSONAL USE (U.S. CLS. 100 AND 101).

FIRST USE 7-1-1999; IN COMMERCE 8-1-1999.

SN 75-943,682. CONSOLIDATED GRAPHICS, INC., HOUSTON, TX. FILED 3-14-2000.

CONSOLIDATED GRAPHICS

NO CLAIM IS MADE TO THE EXCLUSIVE RIGHT TO USE "GRAPHICS", APART FROM THE MARK AS SHOWN. FOR PRINTING (U.S. CLS. 100 AND 101).
FIRST USE 6-0-1994; IN COMMERCE 6-0-1994.

SN 75-978,731. MATERIALS INNOVATION, INC., WEST LEBANON, NH. FILED 2-25-1998.



NO CLAIM IS MADE TO THE EXCLUSIVE RIGHT TO USE "MATERIALS" OR "INC.", APART FROM THE MARK AS SHOWN.

THE MARK IS LINED FOR COLOR GREEN. FOR DESIGN AND TESTING FOR NEW PRODUCT DEVELOPMENT; PRODUCT DEVELOPMENT FOR OTHERS (U.S. CLS. 100 AND 101).

FIRST USE 7-0-1994; IN COMMERCE 7-0-1994.

CLASS 42—(Continued).

SN 76-003,225. MEGASPIDER.COM INC., LEWES, DE. FILED 3-17-2000.

MEGASPIDER

FOR COMPUTER SERVICES, NAMELY, CREATING INDICES OF INFORMATION, SITES AND OTHER RESOURCES AVAILABLE ON A GLOBAL COMPUTER NETWORK FOR OTHERS; SEARCHING AND RETRIEVING INFORMATION, SITES AND OTHER RESOURCES AVAILABLE ON A GLOBAL COMPUTER NETWORK; PROVIDING SEARCH ENGINES FOR OBTAINING DATA ON A GLOBAL COMPUTER NETWORK; PROVIDING CUSTOMIZED ONLINE WEB PAGES FEATURING USER-DEFINED INFORMATION, WHICH INCLUDES SEARCH ENGINES AND ONLINE WEB LINKS TO OTHER WEB SITES (U.S. CLS. 100 AND 101).
FIRST USE 2-24-1999; IN COMMERCE 2-24-1999.

SN 76-003,343. BIZTONE.COM, INC., SAN JOSE, CA. FILED 3-17-2000.

B.POWERED

FOR PROVIDING TEMPORARY USE OF ON-LINE NON-DOWNLOADABLE SOFTWARE FOR BUSINESS ENTERPRISE RESOURCE MANAGEMENT APPLICATIONS, NAMELY APPLICATIONS FOR ACCOUNTING, FINANCIAL, INVENTORY, PROCUREMENT, MATERIALS, PLANNING, HUMAN RESOURCES, DISTRIBUTION, AND SALES MANAGEMENT FUNCTIONS (U.S. CLS. 100 AND 101).

SN 76-004,271. INTERNATIONAL PAPER COMPANY, PURCHASE, NY. FILED 3-20-2000.

HOUSE COLLECTION

FOR TECHNICAL CONSULTING SERVICES RELATING TO PAPER SELECTION TO ASSIST CLIENTS IN SELECTING PAPER APPROPRIATE FOR PARTICULAR PURPOSES (U.S. CLS. 100 AND 101).

SN 76-023,409. REED ELSEVIER INC., NEWTON, MA. FILED 4-12-2000.

NEWS@2DIRECT

FOR COMPUTER SERVICES, NAMELY, PROVIDING ON-LINE NEWSLETTER IN THE FIELD OF COMMUNICATIONS DELIVERED VIA EMAIL (U.S. CLS. 100 AND 101).
FIRST USE 5-1-2000; IN COMMERCE 5-1-2000.

CLASS 42—(Continued).

SN 76-026,274. FOGO DE CHAO CHURRASCARIA LTDA., CEP 04702-002 SAO PAULO, BRAZIL, FILED 4-13-2000.

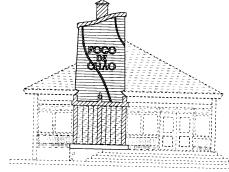

THE PORTUGUESE PHASE "FOGO DE CHAO" MAY BE TRANSLATED IN ENGLISH TO MEAN "CAMPFIRE".
FOR RESTAURANT SERVICES (U.S. CLS. 100 AND 101).

FIRST USE 8-15-1997; IN COMMERCE 8-15-1997.

SN 76-027,902. LOMBARD, KAREN, WENATCHEE, WA. FILED 4-18-2000.

KAMELEONS

FOR CUSTOM ART DESIGN AND GRAPHIC DESIGN FOR GIFTS, GREETING CARDS AND STATIONERY (U.S. CLS. 100 AND 101).

SN 76-032,231. STARMARK, INC., SIOUX FALLS, SD. FILED 4-24-2000.

KITCHEN & BATH IDEAS

OWNER OF U.S. REG. NOS. 2,072,305 AND 2,144,891.
NO CLAIM IS MADE TO THE EXCLUSIVE RIGHT TO USE "KITCHEN & BATH", APART FROM THE MARK AS SHOWN.

FOR DESIGN FOR OTHERS IN THE FIELD OF CABINETS (U.S. CLS. 100 AND 101).
FIRST USE 1-0-1995; IN COMMERCE 1-0-1995.

SN 76-032,403. WIRING HARNESS MANUFACTURERS ASSOCIATION, ARLINGTON HEIGHTS, IL. FILED 4-24-2000.

**WIRING HARNESS
MANUFACTURERS
ASSOCIATION**

OWNER OF U.S. REG. NO. 2,159,778.
NO CLAIM IS MADE TO THE EXCLUSIVE RIGHT TO USE "ASSOCIATION", APART FROM THE MARK AS SHOWN.

SEC. 2(F).
FOR ASSOCIATION SERVICES - NAMELY, PROMOTING THE INTERESTS OF THE WIRING HARNESS MANUFACTURING INDUSTRY (U.S. CLS. 100 AND 101).

FIRST USE 9-28-1993; IN COMMERCE 1-0-1994.

CLASS 42—(Continued).

SN 76-032,727. MEDAREX, INC., PRINCETON, NJ. FILED 4-24-2000.

GENPHARM

FOR BIOCHEMICAL AND MEDICAL RESEARCH AND DEVELOPMENT SERVICES UTILIZING TRANSGENIC ANIMAL TECHNOLOGY IN THE DEVELOPMENT OF HUMAN ANTIBODY PRODUCTS FOR THERAPEUTIC USES (U.S. CLS. 100 AND 101).
FIRST USE 4-11-1991; IN COMMERCE 4-11-1991.

SN 76-035,377. MASTERWORKS PROJECT SOLUTIONS, INC., WAKEFIELD, MA. FILED 4-26-2000.

INFRONT SOLUTIONS

NO CLAIM IS MADE TO THE EXCLUSIVE RIGHT TO USE "SOLUTIONS", APART FROM THE MARK AS SHOWN.

FOR COMPUTER SOFTWARE DESIGN FOR OTHERS (U.S. CLS. 100 AND 101).

SN 76-037,396. COMMERX, INC., CHICAGO, IL. FILED 5-1-2000.

E-VOLVED INDUSTRIAL AND MARKETPLACE SOLUTIONS

NO CLAIM IS MADE TO THE EXCLUSIVE RIGHT TO USE "INDUSTRIAL MARKETPLACE SOLUTIONS", APART FROM THE MARK AS SHOWN.

FOR COMPUTER SERVICES, NAMELY, CREATING AND MAINTAINING A SPECIALIZED WEBSITE IN THE NATURE OF AN ELECTRONIC MARKETPLACE FOR OTHERS FEATURING WEBSITE LINKS FOR BUSINESS TO BUSINESS E-COMMERCE TRANSACTION THAT ENABLE BUYERS AND SELLERS IN INDUSTRIAL PROCESSING MARKETS TO TRANSACT BUSINESS, FIND SOLUTIONS, AND EXCHANGE INFORMATION VIA AN INTERACTIVE GLOBAL COMPUTER NETWORK (U.S. CLS. 100 AND 101).
FIRST USE 1-29-2000; IN COMMERCE 1-29-2000.

CLASS 42—(Continued).

SN 76-037,579. AMERICAN COMMUNITY PARTNERSHIPS, INC., WASHINGTON, DC. BY CHANGE OF NAME AMERICA WORKS PARTNERSHIP, INC., WASHINGTON, DC. FILED 5-1-2000.

AMERICAN COMMUNITY PARTNERSHIPS

NO CLAIM IS MADE TO THE EXCLUSIVE RIGHT TO USE "AMERICAN" OR "PARTNERSHIP", APART FROM THE MARK AS SHOWN.

FOR NON-PROFIT SERVICES FOR REBUILDING INDIVIDUAL LIVES AND COMMUNITIES THROUGH THE CREATION OF COLLABORATIONS THAT PROVIDE AND FACILITATE JOB SKILLS TRAINING, LIFE SKILLS TRAINING, APPRENTICESHIPS, JOB PLACEMENT AND EMPLOYMENT, AFFORDABLE HOUSING AND FINANCING, ECONOMIC INVESTMENT AND COMMUNITY DEVELOPMENT (U.S. CLS. 100 AND 101).

SN 76-038,140. MERCURY INTERACTIVE CORPORATION, SUNNYVALE, CA. FILED 5-1-2000.

ACTIVETEST

FOR COMPUTER CONSULTATION SERVICES IN THE NATURE OF EVALUATING WEB-SITE PERFORMANCE AND LOAD CAPACITY PROVIDED VIA A GLOBAL COMPUTER NETWORK (U.S. CLS. 100 AND 101).

SN 76-038,398. MYGAIT LLC, HOUSTON, TX. FILED 5-2-2000.

MYGAIT

FOR LEASING AND RENTING OF COMPUTERS AND COMPUTER EQUIPMENT; INSTALLATION OF COMPUTER SOFTWARE; UPDATING OF COMPUTER SOFTWARE FOR OTHERS (U.S. CLS. 100 AND 101).

SN 76-038,573. BOEING MANAGEMENT COMPANY, SEAL BEACH, CA. FILED 4-27-2000.

FOREVER NEW FRONTIERS

FOR TECHNICAL CONSULTATION AND RESEARCH IN THE FIELD OF DESIGN, MANUFACTURE, CERTIFICATION, OPERATION, MAINTENANCE, REPAIR, OVERHAUL AND MODIFICATION OF AIRCRAFT AND AIRCRAFT PARTS; TECHNICAL WRITING FOR OTHERS; DESIGN AND TESTING OF NEW PRODUCTS FOR OTHERS; COMPUTER SERVICES, NAMELY, PROVIDING ON-LINE BOOKS, MAGAZINES, MANUALS, TRAINING MANUALS, GUIDES AND TRAINING GUIDES IN THE FIELDS OF AIRCRAFT, AIRCRAFT PARTS, AVIONICS, AND MAINTENANCE, OPERATION AND REPAIR OF AIRCRAFT, AEROSPACE PRODUCTS, AND THE PARTS AND SUPPORT EQUIPMENT THEREOF; TRAVEL AGENCY SERVICES, NAMELY, MAKING RESERVATIONS AND BOOKINGS FOR TEMPORARY LODGING (U.S. CLS. 100 AND 101).

CLASS 42—(Continued).

SN 76-044,415. LEVENFELD PEARLSTEIN GLASSBERG TUCHMAN BRIGHT GOLDSTEIN & SCHWARTZ, LLC, CHICAGO, IL. FILED 5-10-2000.

YOUR LEGAL LINK

NO CLAIM IS MADE TO THE EXCLUSIVE RIGHT TO USE "LEGAL", APART FROM THE MARK AS SHOWN. FOR PROFESSIONAL LEGAL SERVICES BY LICENSED ATTORNEYS (U.S. CLS. 100 AND 101). FIRST USE 3-7-2000; IN COMMERCE 3-7-2000.

SN 76-053,950. ARONHEIM, R. ELLIOTT, WATERBURY, CT. FILED 5-22-2000.

DOOGIE'S

FOR CARRY-OUT RESTAURANTS; RESTAURANTS FEATURING HOME DELIVERY (U.S. CLS. 100 AND 101).

SN 76-053,952. ARONHEIM, R. ELLIOTT, WATERBURY, CT. FILED 5-22-2000.

WHERE ONLY THE FOOD IS TAKEN SERIOUSLY

FOR CARRY-OUT RESTAURANTS; RESTAURANTS FEATURING HOME DELIVERY (U.S. CLS. 100 AND 101).

SN 76-055,290. YAVITZ, EDWARD Q., ROCKFORD, IL. FILED 5-24-2000.

LUXURY LASIK

NO CLAIM IS MADE TO THE EXCLUSIVE RIGHT TO USE "LASIK", APART FROM THE MARK AS SHOWN. FOR OPHTHALMOLOGY SERVICES (U.S. CLS. 100 AND 101).

CLASS 42—(Continued).

SN 76-056,318. WORD OF MOUTH PLANET.COM, L.L.C., PHOENIX, AZ. FILED 5-24-2000.

THE SOURCE FOR WORD OF MOUTH TECHNOLOGY

FOR COMPUTER CONSULTATION TO ASSIST OTHERS IN CREATING AND MAINTAINING A DATABASE OF INFORMATION UTILIZING USER COMMENTS, RATINGS AND OPINIONS ABOUT A WIDE VARIETY OF PRODUCTS, SERVICES AND TOPICS; APPLICATION SERVICE PROVIDER SERVICES, NAMELY, PROVIDING, CREATING, MAINTAINING AND/OR HOSTING A SUITE OF SOFTWARE APPLICATIONS THAT ALLOWS USERS TO ENTER COMMENTS, RATINGS AND OPINIONS ABOUT A WIDE VARIETY OF PRODUCTS, SERVICES AND TOPICS; AND COMPUTER SERVICES, NAMELY, HOSTING THE WEBSITES AND HOME PAGES OF OTHERS ON A COMPUTER SERVER FOR A GLOBAL COMPUTER NETWORK (U.S. CLS. 100 AND 101).

SN 76-060,375. ASSOCIATED CARDIOVASCULAR CONSULTANTS, P.A., HADDONFIELD, NJ. FILED 5-31-2000.

CONCERT

FOR CARDIOVASCULAR RISK MANAGEMENT SERVICE, NAMELY PROVIDING A THOROUGH MEDICAL HISTORY, PHYSICAL EXAMINATION, AN OVERALL HEALTH ASSESSMENT, ELECTROCARDIOGRAM, EXERCISE STRESS TEST, NUTRITIONAL EVALUATION, CHOLESTEROL SCREENING, AND AN ANALYSIS OF CARDIOVASCULAR RISK FACTORS (U.S. CLS. 100 AND 101).

SN 76-064,216. BPI COMMUNICATIONS INC., NEW YORK, NY. FILED 6-6-2000.

AMUSEMENT BUSINESS.COM

OWNER OF U.S. REG. NOS. 1,933,236 AND 2,016,849. NO CLAIM IS MADE TO THE EXCLUSIVE RIGHT TO USE "BUSINESS.COM", APART FROM THE MARK AS SHOWN. FOR COMPUTER SERVICES, NAMELY, PROVIDING ON-LINE MAGAZINES IN THE FIELD OF ENTERTAINMENT (U.S. CLS. 100 AND 101). FIRST USE 10-0-1999; IN COMMERCE 10-0-1999.

SN 76-064,810. ASPEN YOUTH SERVICES, INC., CERRITOS, CA. FILED 6-6-2000.

SUWS

FOR INPATIENT AND OUTPATIENT TREATMENT AND COUNSELING FOR ABUSED, NEGLECTED, AND AT-RISK CHILDREN, YOUNG ADULTS, AND THEIR PARENTS IN THE NATURE OF PSYCHOLOGICAL AND SOCIOLOGICAL SERVICES (U.S. CLS. 100 AND 101). FIRST USE 6-0-1981; IN COMMERCE 6-0-1981.

CLASS 42—(Continued).

SN 76-064,811. ASPEN EDUCATION GROUP, INC., CERRITOS, CA. BY CHANGE OF NAME ASPEN YOUTH SERVICES, INC., CERRITOS, CA. FILED 6-6-2000.

ASPEN RANCH

NO CLAIM IS MADE TO THE EXCLUSIVE RIGHT TO USE "RANCH", APART FROM THE MARK AS SHOWN.

FOR INPATIENT AND OUTPATIENT TREATMENT AND COUNSELING FOR ABUSED, NEGLECTED, AND AT-RISK CHILDREN, YOUNG ADULTS, AND THEIR PARENTS IN THE NATURE OF PSYCHOLOGICAL AND SOCIOLOGICAL SERVICES (U.S. CLS. 100 AND 101).

FIRST USE 7-0-1995; IN COMMERCE 7-0-1995.

SN 76-064,814. ASPEN YOUTH SERVICES, INC., CERRITOS, CA. FILED 6-6-2000.

**ASPEN ACHIEVEMENT
ACADEMY**

NO CLAIM IS MADE TO THE EXCLUSIVE RIGHT TO USE "ACADEMY", APART FROM THE MARK AS SHOWN.

FOR INPATIENT AND OUTPATIENT TREATMENT AND COUNSELING FOR ABUSED, NEGLECTED, AND AT-RISK CHILDREN, YOUNG ADULTS, AND THEIR PARENTS IN THE NATURE OF PSYCHOLOGICAL AND SOCIOLOGICAL SERVICES (U.S. CLS. 100 AND 101).

FIRST USE 4-0-1990; IN COMMERCE 4-0-1990.

SN 76-064,815. ASPEN EDUCATION GROUP, INC., CERRITOS, CA. BY CHANGE OF NAME ASPEN YOUTH SERVICES, INC., CERRITOS, CA. FILED 6-6-2000.

ASPEN YOUTH SERVICES

NO CLAIM IS MADE TO THE EXCLUSIVE RIGHT TO USE "YOUTH SERVICES", APART FROM THE MARK AS SHOWN.

FOR INPATIENT AND OUTPATIENT TREATMENT AND COUNSELING FOR ABUSED, NEGLECTED, AND AT-RISK CHILDREN, YOUNG ADULTS, AND THEIR PARENTS IN THE NATURE OF PSYCHOLOGICAL AND SOCIOLOGICAL SERVICES (U.S. CLS. 100 AND 101).

FIRST USE 5-0-1998; IN COMMERCE 5-0-1998.

CLASS 42—(Continued).

SN 76-065,199. PICANTE, THE REAL TACO, INC., CHANTILLY, VA. FILED 6-6-2000.



NO CLAIM IS MADE TO THE EXCLUSIVE RIGHT TO USE "TACO", APART FROM THE MARK AS SHOWN.

THE LINING IS A FEATURE OF THE MARK AND DOES NOT INDICATE COLOR.

THE ENGLISH TRANSLATION OF THE SPANISH WORD "PICANTE" IS "PIQUANT; MORDANT; HOT, HIGHLY SEASONED".

FOR RESTAURANT, BAR AND CATERING SERVICES (U.S. CLS. 100 AND 101).

FIRST USE 5-0-1995; IN COMMERCE 5-0-1995.

SN 76-066,194. NETNEARU CORPORATION, BRYAN, TX. FILED 6-8-2000.

ADTRACKOS

FOR PROVIDING TEMPORARY USE OF ON-LINE NON-DOWNLOADABLE SOFTWARE FOR PLACING, MONITORING AND MANAGING ADVERTISING OVER A GLOBAL COMMUNICATIONS NETWORK (U.S. CLS. 100 AND 101).

FIRST USE 2-16-2000; IN COMMERCE 2-16-2000.

SN 76-074,800. BOXES2BOXES.COM, INCORPORATED, AURORA, IL. FILED 6-20-2000.

NETBOXES

FOR DESIGN OF PACKING, PACKAGING AND BOXES FOR OTHERS (U.S. CLS. 100 AND 101).

CLASS 42—(Continued).

SN 76-076,085. INTERNATIONAL PARTNERSHIP FOR HEALTH, NFP, CHICAGO, IL. FILED 6-23-2000.

INTERNATIONAL PARTNERSHIP FOR HEALTH

NO CLAIM IS MADE TO THE EXCLUSIVE RIGHT TO USE "INTERNATIONAL" AND "FOR HEALTH", APART FROM THE MARK AS SHOWN.
 FOR PROVIDING HEALTH INFORMATION VIA A GLOBAL COMPUTER INFORMATION NETWORK THAT ALLOWS PATIENTS AND PROVIDERS TO SHARE INFORMATION ACROSS BARRIERS OR LANGUAGE, GEOGRAPHY AND SPECIALIZATION (U.S. CLS. 100 AND 101).

SN 76-079,942. SENSCOM, INC., SAN DIEGO, CA. FILED 6-28-2000.

YOUR WIRELESS WINDOW TO THE FINANCIAL WORLD

FOR COMPUTER SOFTWARE DESIGN FOR OTHERS TO ENABLE CUSTOMERS TO CONDUCT TRANSACTIONS VIA LAND-LINE AND WIRELESS ELECTRONIC DEVICES ON-LINE AND OFF-LINE VIA A GLOBAL COMMUNICATION NETWORK; LEASING COMPUTER FACILITIES; SUPPORT SERVICES, NAMELY, TROUBLESHOOTING OF COMPUTER HARDWARE AND SOFTWARE PROBLEMS VIA E-MAIL COMMUNICATIONS AND IN PERSON ON-SITE VISITATIONS; AND HOSTING WEB SITES OF OTHERS ON A COMPUTER SERVER FOR A GLOBAL COMPUTER NETWORK TO ENABLE CUSTOMERS TO CONDUCT TRANSACTIONS VIA LAND-LINE AND WIRELESS ELECTRONIC DEVICES ON-LINE AND OFF-LINE VIA A GLOBAL COMMUNICATION NETWORK (U.S. CLS. 100 AND 101).

SN 76-080,315. FORD MOTOR COMPANY, DEARBORN, MI. FILED 6-29-2000.

KIDS REVVIN' WITH FORD

OWNER OF U.S. REG. NOS. 74,530, 1,874,207 AND OTHERS.
 FOR ELEEMOSYNARY SERVICES IN THE AREA OF DONATIONS OF FOOD, CLOTHING, OR MEDICINE (U.S. CLS. 100 AND 101).

CLASS 42—(Continued).

SN 76-080,319. FORD MOTOR COMPANY, DEARBORN, MI. FILED 6-29-2000.



OWNER OF U.S. REG. NOS. 74,530, 1,874,207 AND OTHERS.
 FOR ELEEMOSYNARY SERVICES IN THE AREA OF DONATIONS OF FOOD, CLOTHING, OR MEDICINE (U.S. CLS. 100 AND 101).

SN 76-086,829. MEDALIST GROUP, LLC, THE, FLAGSHIP WARF, MA. FILED 7-11-2000.



NO CLAIM IS MADE TO THE EXCLUSIVE RIGHT TO USE "WOMEN'S SENIOR GOLF ASSOCIATION", APART FROM THE MARK AS SHOWN.
 FOR ASSOCIATION SERVICES, NAMELY, PROMOTING THE INTERESTS OF SENIOR WOMEN GOLFERS (U.S. CLS. 100 AND 101).
 FIRST USE 4-10-2000; IN COMMERCE 4-10-2000.

SN 76-087,575. MUSIC EDUCATORS NATIONAL CONFERENCE (MENC), RESTON, VA. FILED 7-13-2000.

MUSIC PASS IT ON!

NO CLAIM IS MADE TO THE EXCLUSIVE RIGHT TO USE "MUSIC", APART FROM THE MARK AS SHOWN.
 FOR ASSOCIATION SERVICES, NAMELY, PROMOTING MUSIC EDUCATION IN PUBLIC SCHOOLS THROUGH CONCERTS, MUSIC CLASSES, AND MUSIC PROGRAMS AND OTHER SIMILAR ACTIVITIES (U.S. CLS. 100 AND 101).
 FIRST USE 6-1-2000; IN COMMERCE 6-1-2000.

CLASS 42—(Continued).

SN 76-088,212. HAN JOO RESTAURANT, INC., FLUSHING, NY. FILED 7-14-2000.

한주취냉면

NO CLAIM IS MADE TO THE EXCLUSIVE RIGHT TO USE KOREAN IDEOGRAMS TRANSLATED AS "ARROW-ROOT COLD NOODLE", APART FROM THE MARK AS SHOWN.

THE MARK IS TRANSLATED AS "HAN JOO ARROW-ROOT COLD NOODLE". THE MARK IS TRANSLITERATED AS "HAN JOO CHIG NAENG MYUN".

FOR KOREAN RESTAURANT SERVICES (U.S. CLS. 100 AND 101).

FIRST USE 4-25-1999; IN COMMERCE 4-25-1999.

SN 76-088,655. ORIGINAL SAN FRANCISCO ROOMMATE REFERRAL SERVICE, INC., THE, DBA THE MEETING GAME, ALBANY, CA. FILED 7-13-2000.

10-MINUTE DATING

NO CLAIM IS MADE TO THE EXCLUSIVE RIGHT TO USE "DATING", APART FROM THE MARK AS SHOWN.

FOR DATING SERVICES, NAMELY, PERSONAL INTRODUCTION AND SOCIAL GATHERING SERVICES (U.S. CLS. 100 AND 101).

SN 76-089,360. CONFLUENT NETWORKS, INC., LOUISVILLE, KY. FILED 7-14-2000.

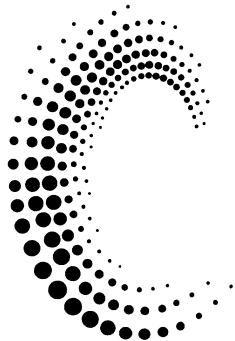

THE MARK CONSISTS OF SEVERAL ROWS OF DOTS FORMING THE LETTER "C".

FOR COMPUTER SERVICES, NAMELY APPLICATIONS SERVICE PROVIDER SERVICES IN THE NATURE OF LEASING ACCESS VIA THE GLOBAL COMPUTER NETWORK TO BOTH THIRD PARTY AND PROPRIETARY SOFTWARE APPLICATIONS AND HARDWARE (U.S. CLS. 100 AND 101).

FIRST USE 3-1-2000; IN COMMERCE 3-1-2000.

CLASS 42—(Continued).

SN 76-089,948. AGUA CALIENTE BAND OF CAHUILLA INDIANS, PALM SPRINGS, CA. FILED 7-13-2000.

 SpaResort&Casino

NO CLAIM IS MADE TO THE EXCLUSIVE RIGHT TO USE "SPARESORT&CASINO", APART FROM THE MARK AS SHOWN.

FOR PROVIDING HOTEL AND CASINO SERVICES (U.S. CLS. 100 AND 101).

SN 76-090,845. GOLF LODGING, L.L.C., ENGLEWOOD, CO. FILED 7-18-2000.

 Golf Lodging

NO CLAIM IS MADE TO THE EXCLUSIVE RIGHT TO USE "GOLF LODGING", APART FROM THE MARK AS SHOWN.

THE MARK CONSISTS OF A SHADED-IN CIRCLE AND THE LETTER "G" FORMING A DEPICTION OF A HOUSE. FOR HOTEL SERVICES (U.S. CLS. 100 AND 101).

SN 76-092,297. SALIENCE ASSOCIATES, INC., ANDOVER, MA. FILED 7-18-2000.

SALIENCE

FOR COMPUTER SERVICES, NAMELY, COMPUTER SYSTEM DESIGN AND INTEGRATION IN THE FIELD OF SALES FORCE AUTOMATION AND CONSULTING RELATED THERETO (U.S. CLS. 100 AND 101).

FIRST USE 10-0-1999; IN COMMERCE 10-0-1999.

CLASS 42—(Continued).

SN 76-094,482. E-DOCS.COM INC., BUTTE, MT. FILED 7-24-2000.

records • net

NO CLAIM IS MADE TO THE EXCLUSIVE RIGHT TO USE "RECORDS" AND "NET", APART FROM THE MARK AS SHOWN.

FOR COMPUTER CONSULTATION SERVICES, NAMELY, RECORDS AND DOCUMENT MANAGEMENT SERVICES (RDMS) PROVIDED TO ANY SINGLE OR MULTIPLE INTERNAL OR EXTERNAL NETWORKING SYSTEMS USER, NAMELY, CUSTOMIZATION OF COMPUTER APPLICATION INTERFACE SCREENS FOR THE INTEGRATION OF THE DATA INTO EACH USERS DAY-TO-DAY BUSINESS PROCESSES, DATABASE ARCHITECTURES TO MEET EACH USERS DAY-TO-DAY BUSINESS PROCESSES, VIRTUAL SYSTEMS COMPRISED OF COMPUTER HARDWARE AND SOFTWARE THAT ARE GEOGRAPHICALLY DISPERSED, ADMINISTRATION AND MAINTENANCE; IMPLEMENTATION OF COMPUTER SECURITY AND SOFTWARE ENCRYPTION SERVICES; COMPUTER CONSULTING, NAMELY, CENTRALIZED COMPUTER DATA BACKUP AND DISASTER RECOVERY PROTOCOLS, LONG TERM VIRTUAL TECHNICAL SUPPORT, NAMELY, TROUBLESHOOTING OF COMPUTER HARDWARE AND SOFTWARE PROBLEMS AND COMPUTER ENGINEERING SERVICES (U.S. CLS. 100 AND 101).

SN 76-100,131. STORABILITY, INC., SOUTHBOROUGH, MA. FILED 7-31-2000.

STORAGE ASSURANCE FOR THE GLOBAL ENTERPRISE

NO CLAIM IS MADE TO THE EXCLUSIVE RIGHT TO USE "STORAGE", APART FROM THE MARK AS SHOWN.

FOR COMPUTER CONSULTING AND DESIGN SERVICES, NAMELY, ANALYZING THE COMPUTER DATA STORAGE REQUIREMENTS OF OTHERS AND PROVIDING RECOMMENDATIONS FOR SUITABLE COMPUTER DATA STORAGE FOR OTHERS; DESIGNING, DEPLOYING, MANAGING AND OPERATING OF STORAGE INFORMATION TECHNOLOGY SOFTWARE AND HARDWARE INFRASTRUCTURE FOR OTHERS AND CONVERTING OR ASSISTING OTHERS IN THE CONVERSION FROM ONE COMPUTER DATA STORAGE SYSTEM TO ANOTHER COMPUTER DATA STORAGE SYSTEM; TECHNICAL SUPPORT SERVICES, NAMELY, TROUBLESHOOTING OF COMPUTER HARDWARE AND SOFTWARE PROBLEMS VIA TELEPHONE AND INTERNET; RETRIEVING AND RESTORING INACCESSIBLE DATA IN USABLE FORM FROM DATA STORAGE DEVICES, SUCH AS HARD DISC DRIVES OR TAPES, AND PROVIDING DATA BACK UP SERVICES FOR OTHERS (U.S. CLS. 100 AND 101).

CLASS 42—(Continued).

SN 76-100,135. STORABILITY, INC., SOUTHBOROUGH, MA. FILED 7-31-2000.

STORAGE ASSURANCE

NO CLAIM IS MADE TO THE EXCLUSIVE RIGHT TO USE "STORAGE", APART FROM THE MARK AS SHOWN.

FOR COMPUTER CONSULTING AND DESIGN SERVICES, NAMELY, ANALYZING THE COMPUTER DATA STORAGE REQUIREMENTS OF OTHERS AND PROVIDING RECOMMENDATIONS FOR SUITABLE COMPUTER DATA STORAGE FOR OTHERS; DESIGNING, DEPLOYING, MANAGING AND OPERATING OF STORAGE INFORMATION TECHNOLOGY SOFTWARE AND HARDWARE INFRASTRUCTURE FOR OTHERS AND CONVERTING OR ASSISTING OTHERS IN THE CONVERSION FROM ONE COMPUTER DATA STORAGE SYSTEM TO ANOTHER COMPUTER DATA STORAGE SYSTEM; TECHNICAL SUPPORT SERVICES, NAMELY, TROUBLESHOOTING OF COMPUTER HARDWARE AND SOFTWARE PROBLEMS VIA TELEPHONE AND INTERNET; RETRIEVING AND RESTORING INACCESSIBLE DATA IN USABLE FORM FROM DATA STORAGE DEVICES, SUCH AS HARD DISC DRIVES OR TAPES, AND PROVIDING DATA BACK UP SERVICES FOR OTHERS (U.S. CLS. 100 AND 101).

SN 76-104,718. AMERICAN CALCAR, INC., WILMINGTON, DE. FILED 1-31-2000.

NEXTWEB

FOR COMPUTER CONSULTATION; LEASING OF COMPUTER FACILITIES; COMPUTER PROGRAMMING FOR OTHERS; COMPUTER SERVICES, NAMELY, CREATING, DESIGNING, IMPLEMENTING AND MAINTAINING WEB SITES FOR OTHERS; COMPUTER SERVICES, NAMELY, DESIGNING AND IMPLEMENTING NETWORK WEB PAGES FOR OTHERS; COMPUTER SERVICES, NAMELY, PROVIDING DATABASES FEATURING GENERAL AND LOCAL NEWS, AND INFORMATION OF INTEREST TO AUTOMOBILE PURCHASERS OR PROSPECTIVE PURCHASERS; COMPUTER SERVICES, NAMELY PROVIDING ON-LINE MANUALS, GUIDES, NEWSLETTERS, NEWS BULLETINS, AND MAGAZINES, IN THE AUTOMOTIVE FIELD; HOSTING THE WEB SITES OF OTHERS ON A COMPUTER SERVER FOR A GLOBAL COMPUTER NETWORK; PREPARING AND PROVIDING ON-LINE CONTENT IN THE AUTOMOTIVE INDUSTRY; PRODUCT RESEARCH AND DEVELOPMENT CONSULTATION; RESEARCH, DESIGN AND TESTING OF NEW PRODUCTS FOR OTHERS; RESEARCH, DESIGN AND TESTING FOR NEW PRODUCT DEVELOPMENT; CONSULTATION AND RESEARCH IN THE AUTOMOTIVE INDUSTRY, AUTOMOBILE CLUBS; DATABASE DEVELOPMENT SERVICES; TECHNICAL WRITING FOR OTHERS (U.S. CLS. 100 AND 101).

SN 76-104,906. FUTURE PROPERTY MANAGEMENT, INC., WILMINGTON, DE. FILED 8-8-2000.

OUR TOWN CAFE

NO CLAIM IS MADE TO THE EXCLUSIVE RIGHT TO USE "CAFE", APART FROM THE MARK AS SHOWN.

FOR RESTAURANT, CAFE AND DINER SERVICES (U.S. CLS. 100 AND 101).

CLASS 42—(Continued).

SN 76-105,453. RINCON, HECTOR J., DBA GUAPO'S, WASHINGTON, DC. FILED 8-8-2000.



NO CLAIM IS MADE TO THE EXCLUSIVE RIGHT TO USE "MEXICAN CUISINE", APART FROM THE MARK AS SHOWN.

THE ENGLISH TRANSLATION OF "GUAPO" IS SPANISH FOR "HANDSOME", "GOODLOOKING", "HAVING GUTS", "SHOWY".

FOR RESTAURANT SERVICES (U.S. CLS. 100 AND 101).

FIRST USE 11-15-1991; IN COMMERCE 11-15-1991.

SN 76-107,032. N.V. ORGANON, 5349 AB OSS, NETHERLANDS, FILED 8-10-2000.

GLAND

FOR CONDUCT OF CLINICAL TRIALS IN THE AREA OF MEDICAL SCIENCE (U.S. CLS. 100 AND 101).

SN 76-109,539. FISHER & PHILLIPS LLP, ATLANTA, GA. FILED 8-16-2000.

SOLUTIONS AT WORK

NO CLAIM IS MADE TO THE EXCLUSIVE RIGHT TO USE "SOLUTIONS", APART FROM THE MARK AS SHOWN.

FOR LEGAL SERVICES REPRESENTING EMPLOYERS IN LABOR AND EMPLOYMENT LAW MATTERS (U.S. CLS. 100 AND 101).

FIRST USE 3-1-1999; IN COMMERCE 3-1-1999.

SN 76-110,644. INTERNET WIRE, INC., LOS ANGELES, CA. FILED 8-16-2000.

DISCLOSURE WIRE

NO CLAIM IS MADE TO THE EXCLUSIVE RIGHT TO USE "WIRE", APART FROM THE MARK AS SHOWN.

FOR PROVIDING NEWS INFORMATION AND PRESS RELEASES THROUGH A GLOBAL COMPUTER NETWORK (U.S. CLS. 100 AND 101).

FIRST USE 5-1-2000; IN COMMERCE 5-1-2000.

CLASS 42—(Continued).

SN 76-116,518. BIG BEAR BIO, INC., SAN MATEO, CA. FILED 8-25-2000.

BIG BEAR BIO

NO CLAIM IS MADE TO THE EXCLUSIVE RIGHT TO USE "BIO", APART FROM THE MARK AS SHOWN.

FOR CONSULTING SERVICES, SPECIFICALLY IN THE PHARMACEUTICAL AND BIOTECHNOLOGY INDUSTRIES (U.S. CLS. 100 AND 101).

FIRST USE 4-1-1992; IN COMMERCE 4-1-1992.

SN 76-116,692. BIG BEAR BIO, INC., SAN MATEO, CA. FILED 8-25-2000.

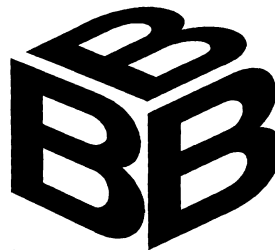

FOR CONSULTING SERVICES, SPECIFICALLY IN THE PHARMACEUTICAL AND BIOTECHNOLOGY INDUSTRIES (U.S. CLS. 100 AND 101).

FIRST USE 4-1-1992; IN COMMERCE 4-1-1992.

SN 76-117,640. WHITTEN, GREGORY F., MEDINA, WA. BY ASSIGNMENT; BY ASSIGNMENT NORTHERN LIGHT TECHNOLOGY, INC, CAMBRIDGE, MA. FILED 8-28-2000.

RECRUITINGSHARK

FOR COMPUTER SERVICES, NAMELY, PROVIDING SEARCH ENGINES FOR OBTAINING DATA ON A GLOBAL COMPUTER NETWORK, NAMELY, PROVIDING SEARCH ENGINES THAT PERMIT SUBSCRIBERS TO IDENTIFY MANAGEMENT CONTACTS IN ORGANIZATIONS BY SUPPORTING SEARCHES USING ANY PROPER NAME, TITLE, ORGANIZATION NAME, AND KEYWORD COMBINATION, FOR ORGANIZING AND SORTING RESULTING CONTACTS BY THESE IDENTIFIERS, AND FOR PROVIDING LINKS TO ARTICLES AND WEB PAGES THAT REFERENCE THESE CONTACTS (U.S. CLS. 100 AND 101).

CLASS 42—(Continued).

SN 76-118,257. INTERNATIONAL SYSTEMS GROUP, INC., NEW YORK, NY. FILED 8-29-2000.

E²AI

NO CLAIM IS MADE TO THE EXCLUSIVE RIGHT TO USE "EAI", APART FROM THE MARK AS SHOWN.
FOR COMPUTER CONSULTATION; INTEGRATION OF COMPUTER SOFTWARE APPLICATIONS (U.S. CLS. 100 AND 101).

SN 76-118,348. ITALIAN COFFEE S.A. DE C.V., 72400 PUEBLA, PUE., MEXICO, FILED 8-29-2000.



NO CLAIM IS MADE TO THE EXCLUSIVE RIGHT TO USE "THE ITALIAN COFFEE COMPANY", APART FROM THE MARK AS SHOWN.
FOR RESTAURANTS FEATURING ITALIAN-STYLE COFFEE, TEA AND RELATED COFFEE AND TEA BASED BEVERAGES, SOFT DRINKS, ITALIAN-STYLE SANDWICHES AND PASTRIES (U.S. CLS. 100 AND 101).

SN 76-118,800. IN BALI, INC., MIAMI, FL. FILED 8-30-2000.

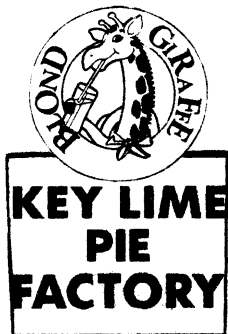

NO CLAIM IS MADE TO THE EXCLUSIVE RIGHT TO USE "KEY LIME PIE", APART FROM THE MARK AS SHOWN.
FOR RESTAURANTS SERVICES (U.S. CLS. 100 AND 101).

CLASS 42—(Continued).

SN 76-118,809. CONVIO, INC., AUSTIN, TX. FILED 8-28-2000.

THE ONLINE PARTNER FOR NONPROFITS

NO CLAIM IS MADE TO THE EXCLUSIVE RIGHT TO USE "ONLINE" OR "NONPROFIT", APART FROM THE MARK AS SHOWN.

FOR PROVIDING TEMPORARY USE OF ON-LINE NON-DOWNLOADABLE SOFTWARE FOR USE BY NONPROFIT ORGANIZATIONS FOR CREATING AND MANAGING RELATIONSHIPS WITH DONORS AND PROSPECTIVE DONORS, NAMELY, FOR PUBLISHING AND UPDATING ON-LINE INFORMATION, CONDUCTING TARGETED FUNDRAISING, MEMBERSHIP AND ADVOCACY CAMPAIGNS, AND FOR MANAGING EVENTS AND TRACKING COMMUNICATIONS WITH DONORS AND PROSPECTIVE DONORS; COMPUTER CONSULTATION SERVICES, NAMELY, DESIGNING AND IMPLEMENTING WEB SITES FOR OTHERS AND CUSTOM SOFTWARE APPLICATION DEVELOPMENT SERVICES FOR OTHERS (U.S. CLS. 100 AND 101).

SN 76-119,601. CROSSVUE, INC., SAN JOSE, CA. BY CHANGE OF NAME RECEIPTCITY.COM, INC., SAN JOSE, CA. FILED 8-29-2000.

MYRECEIPTS

FOR PROVIDING TEMPORARY USE OF ONLINE NON-DOWNLOADABLE SOFTWARE TO RETAILERS ALLOWING THEM TO OFFER PURCHASE INFORMATION TO CUSTOMERS VIA A GLOBAL COMPUTER NETWORK (U.S. CLS. 100 AND 101).

SN 76-119,619. MYMEDED, INC., KANSAS CITY, MO. FILED 8-22-2000.

MYMEDED

FOR PROVIDING AN ONLINE LEARNING MANAGEMENT SYSTEM COMPRISED PRIMARILY OF NON-DOWNLOADABLE SOFTWARE FOR TEMPORARY USE FOR PROFESSIONALS IN THE HEALTHCARE INDUSTRY TO MANAGE CONTINUING EDUCATION AND TRAINING REQUIREMENTS (U.S. CLS. 100 AND 101).

FIRST USE 2-18-2000; IN COMMERCE 4-18-2000.

SN 76-122,168. CENTRAL DESIGN SYSTEMS, INC., SAN JOSE, CA. FILED 9-5-2000.

GO BIG OR STAY HOME

FOR DESIGN AND IMPLEMENTATION FOR OTHERS OF EBUSINESS INFRASTRUCTURES, NAMELY, COMPUTERS, NETWORK EQUIPMENT AND SOFTWARE; MAINTENANCE OF COMPUTER SOFTWARE (U.S. CLS. 100 AND 101).

FIRST USE 7-27-2000; IN COMMERCE 7-27-2000.

CLASS 42—(Continued).

SN 76-125,007. ONE BIG EVENT, INC., WELLESLEY, MA.
FILED 9-8-2000.

ONE BIG EVENT

NO CLAIM IS MADE TO THE EXCLUSIVE RIGHT TO USE "BIG EVENT", APART FROM THE MARK AS SHOWN.
FOR PARTY PLANNING CONSULTATION FOR INDIVIDUALS AND ORGANIZATIONS; TRAVEL AGENCY SERVICES, NAMELY MAKING RESERVATIONS AND BOOKING FOR TEMPORARY LODGING; RESTAURANT SERVICES (U.S. CLS. 100 AND 101).

SN 76-125,008. ONE BIG EVENT, INC., WELLESLEY, MA.
FILED 9-8-2000.



NO CLAIM IS MADE TO THE EXCLUSIVE RIGHT TO USE "BIG EVENT", APART FROM THE MARK AS SHOWN.
THE LETTER "O" IS RED, THE STAR OVERLAYING THE LETTER "O" AND THE LETTERS "NE BIG EVENT" ARE BLUE, AND THE STREAMING STARS EMANATING FROM THE LETTER "V" ARE BLUE AND RED.

THE MARK CONSISTS OF THE WORDING "ONE BIG EVENT", WHERE THE LETTER "O" IS A SOLID SPHERE OVERLAID BY A SOLID FIVE POINT STAR, THE POINTS OF WHICH STAR EXTEND BEYOND THE EDGE OF THE "O"; AN EXPLOSION OF STREAMING STARS EMANATE FROM THE TOP OF THE LETTER "V".

FOR PARTY PLANNING CONSULTATION FOR INDIVIDUALS AND ORGANIZATIONS; TRAVEL AGENCY SERVICES, NAMELY MAKING RESERVATIONS AND BOOKING FOR TEMPORARY LODGING; RESTAURANT SERVICES (U.S. CLS. 100 AND 101).

SN 76-125,101. FRI-ADMIN CORPORATION, IRVINE, CA.
FILED 9-7-2000.

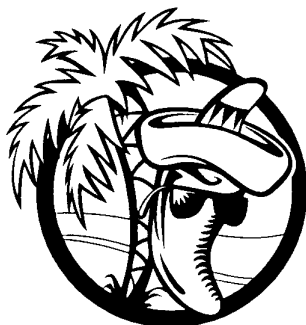

FOR RESTAURANT SERVICES (U.S. CLS. 100 AND 101).

CLASS 42—(Continued).

SN 76-125,832. NLP IP COMPANY, WILMINGTON, DE.
FILED 9-11-2000.

**AMERICAN LAWYER MEDIA
EXPERT WITNESSES &
CONSULTANTS NETWORK**

OWNER OF U.S. REG. NOS. 1,149,321, 2,424,448 AND OTHERS.

NO CLAIM IS MADE TO THE EXCLUSIVE RIGHT TO USE "EXPERT WITNESSES & CONSULTANTS NETWORK", APART FROM THE MARK AS SHOWN.

SEC. 2(F) AS TO "AMERICAN LAWYER MEDIA".
FOR COMPUTER SERVICES, NAMELY, PROVIDING AN ONLINE SERIES OF DIRECTORIES PERTAINING TO THE LEGAL FIELD (U.S. CLS. 100 AND 101).
FIRST USE 8-1-2000; IN COMMERCE 9-20-2000.

SN 76-128,226. LIFETOUCH INC., EDEN PRAIRIE, MN.
FILED 9-14-2000.

**LIFETOUCH CHURCH
DIRECTORIES AND
PORTRAITS**

OWNER OF U.S. REG. NOS. 1,323,226, 2,271,437 AND OTHERS.

NO CLAIM IS MADE TO THE EXCLUSIVE RIGHT TO USE "CHURCH DIRECTORIES AND PORTRAITS", APART FROM THE MARK AS SHOWN.

FOR PORTRAIT PHOTOGRAPHY SERVICES (U.S. CLS. 100 AND 101).
FIRST USE 3-24-2000; IN COMMERCE 3-24-2000.

SN 76-131,138. POSSIBILITIES FOUNDATION, INC., NORTH MIAMI, FL. FILED 9-19-2000.

BEYOND ADVERSITY TV

NO CLAIM IS MADE TO THE EXCLUSIVE RIGHT TO USE "TV", APART FROM THE MARK AS SHOWN.
FOR PROMOTING PUBLIC AWARENESS OF THE NEEDS OF THE DISABLED (U.S. CLS. 100 AND 101).

CLASS 42—(Continued).

SN 76-133,078. SPECIALTY LABORATORIES, SANTA MONICA, CA. FILED 9-22-2000.



OWNER OF U.S. REG. NO. 2,320,939.
NO CLAIM IS MADE TO THE EXCLUSIVE RIGHT TO USE "SPECIALTY" AND "LABORATORIES", APART FROM THE MARK AS SHOWN.
FOR MEDICAL TESTING, NAMELY, CONDUCTING CLINICAL TRIALS (U.S. CLS. 100 AND 101).
FIRST USE 4-17-2000; IN COMMERCE 4-17-2000.

SN 76-133,163. RICHARD, CLAUDE, ST-MATHIEU-DU-PARC, QUEBEC, FILED 9-21-2000.

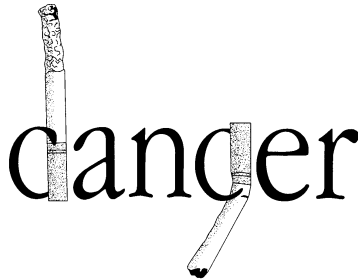

NO CLAIM IS MADE TO THE EXCLUSIVE RIGHT TO USE "CANCER", APART FROM THE MARK AS SHOWN.
THE MARK IS LINED FOR THE COLORS BROWN AND TAN.
FOR PROMOTING PUBLIC AWARENESS OF THE DANGER OF CONSUMPTION OF TOBACCO PRODUCTS DISSEMINATED BY ADVERTISING, BILLBOARDS, SIGNS, INSERTS, ADVERTISING LEAFLETS AND PROMOTIONAL MESSAGES ON TELEVISION (U.S. CLS. 100 AND 101).

SN 76-133,687. KELLY REGISTRATION SYSTEMS, INC., COVINGTON, GA. FILED 9-21-2000.

KSTREAMS

FOR PROVIDING AN ON-LINE ELECTRONIC DATABASE IN THE FIELD OF AGRICULTURAL REGULATORY COMPLIANCE; REGISTRATION SERVICES, NAMELY, REGISTRATIONS AND RENEWALS OF REGULATED AGRICULTURAL PRODUCTS WITH STATES; INDUSTRIAL TESTING SERVICES FOR STATES TO MONITOR COMPLIANCE WITH AGRICULTURAL LAWS AND REGULATIONS; AND PROVIDING A WEBSITE FEATURING AGRICULTURAL INFORMATION (U.S. CLS. 100 AND 101).

CLASS 42—(Continued).

SN 76-133,688. KELLY REGISTRATION SYSTEMS, INC., COVINGTON, GA. FILED 9-21-2000.

KELLYSOLUTIONS

FOR PROVIDING AN ON-LINE ELECTRONIC DATABASE IN THE FIELD OF PESTICIDES; REGISTRATION SERVICES, NAMELY, FACILITATING THE SUBMISSION TO GOVERNMENT AGENCIES OF AGRICULTURAL PRODUCT REGISTRATIONS, RENEWALS, LICENSES, REPORTS AND CERTIFICATIONS; AND TESTING SERVICES TO ENSURE COMPLIANCE WITH LAWS AND REGULATIONS RELATING TO PESTICIDES AND PROCESSES FOR THE MANUFACTURE OF PESTICIDES (U.S. CLS. 100 AND 101).

SN 76-135,852. MUSCULOSKELETAL TRANSPLANT FOUNDATION, EDISON, NJ. FILED 9-22-2000.

STATLINE

FOR MEDICAL SERVICES IN THE FIELD OF HUMAN TISSUE, CELLS, BONE AND ORGAN DONATIONS, NAMELY, OBTAINING DONOR CONSENT AND HUMAN DONOR REFERRALS, CONDUCTING DONOR SCREENING SURVEYS, COLLECTING DONOR MEDICAL DATA, COORDINATING DONOR RECOVERIES WITH OUTSIDE ENTITIES, AND PROVIDING STATISTICAL DONOR DATA TO OTHERS ALL VIA TELEPHONE CALL CENTERS (U.S. CLS. 100 AND 101).
FIRST USE 6-0-1996; IN COMMERCE 6-0-1996.

SN 76-135,979. MUSCULOSKELETAL TRANSPLANT FOUNDATION, EDISON, NJ. FILED 9-22-2000.

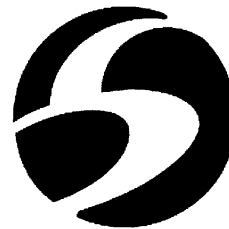

FOR MEDICAL SERVICES IN THE FIELD OF HUMAN TISSUE, CELLS, BONE AND ORGAN DONATIONS, NAMELY, OBTAINING DONOR CONSENT AND HUMAN DONOR REFERRALS, CONDUCTING DONOR SCREENING SURVEYS, COLLECTING DONOR MEDICAL DATA, COORDINATING DONOR RECOVERIES WITH OUTSIDE ENTITIES, AND PROVIDING STATISTICAL DONOR DATA TO OTHERS ALL VIA TELEPHONE CALL CENTERS (U.S. CLS. 100 AND 101).
FIRST USE 6-0-1996; IN COMMERCE 6-0-1996.

CLASS 42—(Continued).

SN 76-136,470. INSTAFOTOS, INC., SAN CARLOS, CA. FILED 9-27-2000.

INSTAFOTOS

FOR PHOTOGRAPHIC COMPOSITION FOR OTHERS (U.S. CLS. 100 AND 101).



SN 76-138,227. RESOURCE RENEWAL INSTITUTE, SAN FRANCISCO, CA. FILED 10-2-2000.



NO CLAIM IS MADE TO THE EXCLUSIVE RIGHT TO USE THE REPRESENTATION OF A LEAF DESIGN, APART FROM THE MARK AS SHOWN.

FOR PROMOTING THE PUBLIC AWARENESS OF THE NEED FOR IMPROVING ENVIRONMENTAL POLICIES AT THE LOCAL, NATIONAL AND INTERNATIONAL LEVELS (U.S. CLS. 100 AND 101).



SN 76-138,729. TREVISE BEHAVIOR MODIFICATION PROGRAM, INC., HULMEVILLE, PA. FILED 10-2-2000.

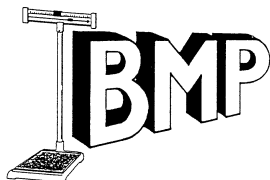

NO CLAIM IS MADE TO THE EXCLUSIVE RIGHT TO USE "BMP", APART FROM THE MARK AS SHOWN.

FOR BEHAVIOR MODIFICATION SERVICES, NAMELY PROVIDING WEIGHT REDUCTION DIET PLANNING AND SUPERVISION (U.S. CLS. 100 AND 101).

FIRST USE 1-0-1971; IN COMMERCE 1-0-1971.

CLASS 42—(Continued).

SN 76-143,808. INGRAM, LINDA A., DBA THE RAGING CAJUN, ROCHESTER, NY. FILED 10-10-2000.



THE STIPPLING IN THE DRAWING IS TO DENOTE THE COLOR RED, NAMELY, ON THE BOTTLE EXCLUDING THE LABEL, THE DROPS FROM THE BOTTLE, THE CHARACTER'S TONGUE AND PORTIONS OF HIS SHIRT AND PART OF THE UPPER PEPPER BORNE BY THE CHARACTER.

FOR RESTAURANT SERVICES FEATURING SHRIMP CREOLE, SEAFOOD GUMBO, CAJUN STEAK SANDWICHES, CAJUN SHRIMP ON A STICK, MASHED POTATOES WITH TOPPINGS, AND FRIED SHRIMP (U.S. CLS. 100 AND 101).



SN 76-146,788. SAN DIEGO EYE BANK, SAN DIEGO, CA. FILED 10-16-2000.

WORLD EYE BANK

NO CLAIM IS MADE TO THE EXCLUSIVE RIGHT TO USE "EYE BANK", APART FROM THE MARK AS SHOWN.

FOR RECOVERING, PROCESSING, AND PROVIDING DONOR EYE TISSUE FOR EYE SURGERIES AND EYE RESEARCH STUDIES, AND PROVIDING INFORMATION AND PROMOTING PUBLIC AWARENESS PERTAINING TO THE DONATION OF EYE TISSUE (U.S. CLS. 100 AND 101).

CLASS 42—(Continued).

SN 76-147,043. ANAYA, CASSANDRA D., SAN DIEGO, CA. FILED 10-16-2000.



FOR PSYCHIC INFORMATION, ADVICE AND READING SERVICES (U.S. CLS. 100 AND 101).
FIRST USE 8-14-1989; IN COMMERCE 8-14-1989.

SN 76-158,226. SYSTEM SPEC AUDIO VIDEO ENGINEERS, LLC., PLACENTIA, CA. FILED 11-3-2000.



NO CLAIM IS MADE TO THE EXCLUSIVE RIGHT TO USE "AUDIO VIDEO ENGINEERS", APART FROM THE MARK AS SHOWN.
FOR ENGINEERING SERVICES IN THE FIELD OF AUDIO AND VIDEO EQUIPMENT (U.S. CLS. 100 AND 101).

SN 76-160,770. TELENISUS CORPORATION, ROLLING MEADOWS, IL. FILED 11-7-2000.



FOR DESIGNING AND PROVIDING BUSINESS-TO-BUSINESS INTERNET SERVICES FOR THE WORLD WIDE COMPUTER NETWORK, NAMELY, SECURITY CONSULTING SERVICES, MANAGED FIREWALL SERVICES, STRATEGY AND DESIGN OF CUSTOM SECURITY; VIRTUAL PRIVATE NETWORK SERVICES; APPLICATION HOSTING; WEB HOSTING; AND TURN KEY E-COMMERCE SERVICES (U.S. CLS. 100 AND 101).

CLASS 42—(Continued).

SN 76-162,847. SUNRISE ASSISTED LIVING, INC., MCLEAN, VA. FILED 11-9-2000.

SUNRISE

OWNER OF U.S. REG. NOS. 2,047,454 AND 2,313,763.
FOR PROVIDING NON-MEDICAL IN-HOME ASSISTED LIVING SERVICES IN THE NATURE OF MONITORING, REMINDER AND CHECK-IN SERVICES, NAMELY TELEPHONE COMMUNICATION WITH IN-HOME CARE CLIENTS REGARDING THEIR HEALTH, SAFETY, AND MEDICATION; PROVIDING NON-MEDICAL IN-HOME ASSISTED LIVING CARE SERVICES, NAMELY, ARRANGING AND COORDINATING HOUSEKEEPING, HOME MAINTENANCE, MEAL PREPARATION, MEAL DELIVERY, SHOPPING, NURSING AND MEDICAL SERVICES, TRANSPORTATION, DELIVERY OF PHARMACEUTICALS, LAWN SERVICE AND SNOW REMOVAL, GROCERY DELIVERY, AND BILL PAYING; AND NURSING AND MEDICAL CARE SERVICES (U.S. CLS. 100 AND 101).

SN 76-165,456. ZEBORG, INC., NEW YORK, NY. FILED 11-14-2000.

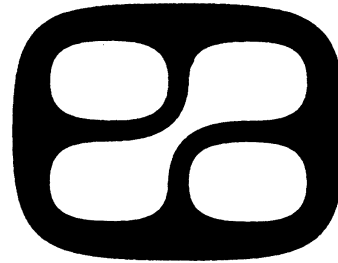

FOR INSTALLATION, MAINTENANCE, AND DEVELOPMENT OF SOFTWARE FOR OTHERS FOR FACILITATING EVALUATION AND PROCUREMENT OF INDIRECT GOODS AND SERVICES (U.S. CLS. 100 AND 101).

SN 76-165,630. FRICKER'S PROGRESSIVE CONCEPTS, INC., DAYTON, OH. FILED 11-15-2000.

MAYBE THE BEST CHICKEN BREASTS IN TOWN, BUT DEFINITELY THE BEST WINGS

FOR RESTAURANT SERVICES (U.S. CLS. 100 AND 101).
FIRST USE 0-0-1996; IN COMMERCE 0-0-1996.

CLASS 42—(Continued).

SN 76-166,491. NETWORK AFFILIATES INCORPORATED, LAKEWOOD, CO. FILED 11-14-2000.



FOR SURGERY, NAMELY EYE SURGERY (U.S. CLS. 100 AND 101).

SN 76-167,400. EXPERIENCE LEARNING COMMUNITY, SEATTLE, WA. BY ASSIGNMENT VULCAN NORTHWEST INC., BELLEVUE, WA. FILED 11-17-2000.

ASAAT

FOR PROVIDING AN ON-LINE ELECTRONIC DATABASE ON THE INTERNET, WIDE-AREA NETWORKS, AND LOCAL AREA-NETWORKS, IN THE FIELDS OF THE ARTS, APPLIED SCIENCE AND TECHNOLOGY, COMPUTER PROGRAMMING AND MULTIMEDIA PROGRAMMING; COMPUTER PROGRAMMING FOR OTHERS; MULTIMEDIA COMPUTER SOFTWARE DESIGN FOR OTHERS; PROVIDING WEBSITES ON THE INTERNET FEATURING INFORMATION IN THE FIELDS OF THE ARTS, APPLIED SCIENCE AND TECHNOLOGY, COMPUTER PROGRAMMING AND MULTIMEDIA PROGRAMMING; WEB-HOSTING SERVICES FOR OTHERS; COMPUTER SOFTWARE DEVELOPMENT SERVICES FOR OTHERS; PROVIDING PRODUCT RESEARCH AND DEVELOPMENT FOR OTHERS; PROVIDING SCIENTIFIC RESEARCH (U.S. CLS. 100 AND 101).

SN 76-170,508. WEB-SEARCH.COM, INC., YARMOUTH, ME. FILED 11-22-2000.

MRFILES

FOR COMPUTER SERVICES, NAMELY, PROVIDING A WEBSITE THAT ALLOWS USERS TO CREATE ON-LINE SEARCH ENGINES RENDERED BY MEANS OF A GLOBAL COMPUTER NETWORK (U.S. CLS. 100 AND 101).

FIRST USE 6-7-2000; IN COMMERCE 11-6-2000.

CLASS 42—(Continued).

SN 76-170,749. SLEEPWORKS, INC., MARIETTA, GA. FILED 11-27-2000.



NO CLAIM IS MADE TO THE EXCLUSIVE RIGHT TO USE "SLEEP", "INC.", OR "NETWORK OF SLEEP DISORDER CENTERS", APART FROM THE MARK AS SHOWN.

FOR MEDICAL SERVICES RELATING TO SLEEP DISORDERS, INCLUDING TESTING AND EVALUATING PERSONS WITH SLEEP DISORDERS AND PROVIDING SLEEP MEDICINE PROGRAMS (U.S. CLS. 100 AND 101).

FIRST USE 2-27-1998; IN COMMERCE 2-27-1998.

SN 76-172,220. GONZALEZ, BEATRICE, MIAMI, FL. FILED 11-28-2000.



NO CLAIM IS MADE TO THE EXCLUSIVE RIGHT TO USE "DESIGN STUDIO", APART FROM THE MARK AS SHOWN.

FOR DESIGN FOR OTHERS IN THE FIELD OF FURNITURE (U.S. CLS. 100 AND 101).

FIRST USE 8-1-1999; IN COMMERCE 8-1-1999.

SN 76-172,843. BOYD GAMING CORPORATION, LAS VEGAS, NV. FILED 11-27-2000.



NO CLAIM IS MADE TO THE EXCLUSIVE RIGHT TO USE "BUFFET", APART FROM THE MARK AS SHOWN.

FOR RESTAURANT SERVICES (U.S. CLS. 100 AND 101).

FIRST USE 11-17-2000; IN COMMERCE 11-17-2000.

CLASS 42—(Continued).

SN 76-176,218. QUICKSTREAM SOFTWARE, INC., COLORADO SPRINGS, CO. FILED 12-5-2000.

QUICKSTREAM.COM

OWNER OF U.S. REG. NO. 2,242,010.
 FOR COMPUTER SERVICES, NAMELY, PROVIDING COMPUTER SYSTEMS INTEGRATION, COMPUTER SOFTWARE UPGRADE AND COMPUTER CONSULTATION SERVICES FOR THE PURPOSE OF DEPLOYING SYSTEMS THAT IMPROVE BUSINESS EFFICIENCY AND INFORMATION TECHNOLOGY EFFICIENCY USING GLOBAL AND LOCAL COMPUTER NETWORKS; TEMPORARY USE OF ON-LINE NON-DOWNLOADABLE SOFTWARE FOR IMPROVING BUSINESS EFFICIENCY AND INFORMATION TECHNOLOGY EFFICIENCY USING GLOBAL AND LOCAL COMPUTER NETWORKS; HOSTING WEB SITES OF OTHERS ON A COMPUTER SERVER FOR A GLOBAL COMPUTER NETWORK (U.S. CLS. 100 AND 101).

SN 76-176,250. CLARENT HOSPITAL CORPORATION, HOUSTON, TX. FILED 12-6-2000.

CLARENT

FOR HOSPITAL SERVICES (U.S. CLS. 100 AND 101).

SN 76-176,813. OCEANS RESORTS, DAYTONA BEACH, FL. FILED 12-7-2000.

1ST SUNRISE 2000 A.D.

NO CLAIM IS MADE TO THE EXCLUSIVE RIGHT TO USE "2000 A.D.", APART FROM THE MARK AS SHOWN.
 FOR BAR SERVICES AND NIGHT CLUB SERVICES CELEBRATING NEW YEAR'S EVE (U.S. CLS. 100 AND 101).
 FIRST USE 9-22-2000; IN COMMERCE 9-22-2000.

SN 76-178,563. FLEMING, DAVID C., FAIRFAX, VA. FILED 12-7-2000.

DOCKETALERT

FOR PROVIDING INFORMATION VIA THE INTERNET REGARDING DOCKETED PROCEEDINGS (U.S. CLS. 100 AND 101).
 FIRST USE 9-1-2000; IN COMMERCE 12-1-2000.

CLASS 42—(Continued).

SN 76-178,941. BLEU22 STUDIOS, INC., ENCINO, CA. FILED 12-11-2000.

BLEU22 STUDIOS

NO CLAIM IS MADE TO THE EXCLUSIVE RIGHT TO USE "STUDIOS", APART FROM THE MARK AS SHOWN.
 FOR COMPUTER SERVICES, NAMELY, DESIGNING WEB SITES FOR OTHERS; DESIGN FOR OTHERS IN THE FIELD OF PRINT MATERIALS (U.S. CLS. 100 AND 101).
 FIRST USE 1-1-1998; IN COMMERCE 1-1-1998.

SN 76-180,957. AVENUE DE L'INVESTISSEMENT INC./ INVEST AVENUE INC., MONTREAL, QUEBEC H2Y 3X7, CANADA, FILED 12-14-2000.

INVEST AVENUE

NO CLAIM IS MADE TO THE EXCLUSIVE RIGHT TO USE "INVEST", APART FROM THE MARK AS SHOWN.
 FOR COMPUTER SERVICES, NAMELY, PROVIDING ON-LINE MAGAZINE IN THE FIELD OF FINANCE AND BUSINESS ECONOMICS (U.S. CLS. 100 AND 101).
 FIRST USE 10-1-2000; IN COMMERCE 10-1-2000.

SN 76-184,047. ALTSHULER, SHEPARD, FORT LEE, NJ. FILED 12-20-2000.

CHARLA CAFE

NO CLAIM IS MADE TO THE EXCLUSIVE RIGHT TO USE "CAFE", APART FROM THE MARK AS SHOWN.
 FOR COFFEE HOUSE AND RESTAURANT (U.S. CLS. 100 AND 101).

SN 76-184,802. PURE LASER HAIR REMOVAL & TREATMENT CLINICS, INC., BETHESDA, MD. FILED 12-20-2000.

pure

LASER HAIR REMOVAL & TREATMENT CLINICS

NO CLAIM IS MADE TO THE EXCLUSIVE RIGHT TO USE "LASER HAIR REMOVAL & TREATMENT CLINICS", APART FROM THE MARK AS SHOWN.
 FOR HAIR REMOVAL SERVICES (U.S. CLS. 100 AND 101).
 FIRST USE 2-0-2000; IN COMMERCE 2-0-2000.

CLASS 42—(Continued).

SN 76-184,865. EDOFF, JUDITH, WOODSTOCK, NY. FILED 12-20-2000.

DR. FOUR PAWS

NO CLAIM IS MADE TO THE EXCLUSIVE RIGHT TO USE "DR.", APART FROM THE MARK AS SHOWN.

FOR VETERINARY SERVICES, NAMELY, VETERINARY THERAPY AND CONSULTING SERVICES IN BOTH CONVENTIONAL AND HOLISTIC MODALITIES (U.S. CLS. 100 AND 101).

FIRST USE 12-4-1999; IN COMMERCE 12-4-1999.

SN 76-185,376. ON LINE ENTERPRISES & SERVICES LLC, MIAMI, FL. FILED 12-21-2000.



The logo for eSpresso features the word "eSpresso" in a stylized, lowercase font. The letter "e" is lowercase and has a unique shape with a small loop at the bottom. The "S" is uppercase and has a decorative flourish. The "presso" part is in a clean, sans-serif font.

FOR RENTAL OF FOOD SERVICE EQUIPMENT, NAMELY, COFFEE MACHINES (U.S. CLS. 100 AND 101).

SN 76-193,738. N.D.Y. INC., FORT MYERS, FL. FILED 1-12-2001.



The logo for Wynstar INN SUITES features the word "Wynstar" in a bold, serif font with a stylized starburst above the "n". Below it, "INN SUITES" is written in a bold, sans-serif font with a horizontal line above and below the text.

NO CLAIM IS MADE TO THE EXCLUSIVE RIGHT TO USE "INN" AND "SUITES", APART FROM THE MARK AS SHOWN.

FOR HOTEL AND INN SERVICES (U.S. CLS. 100 AND 101).

SN 76-195,154. HAMBURGER MARY'S INTERNATIONAL, LLC, CORONA DEL MAR, CA. FILED 1-12-2001.

HAMBURGER MARY'S

OWNER OF U.S. REG. NOS. 1,224,441, 1,241,566 AND 1,265,868.

NO CLAIM IS MADE TO THE EXCLUSIVE RIGHT TO USE "HAMBURGER", APART FROM THE MARK AS SHOWN.

FOR BAR AND RESTAURANT SERVICES (U.S. CLS. 100 AND 101).

FIRST USE 10-15-1979; IN COMMERCE 10-15-1979.

CLASS 42—(Continued).

SN 76-197,400. BATTELLE & BECHTEL, DBA THE NATIONAL RENEWABLE ENERGY LABORATORY, GOLDEN, CO. FILED 1-22-2001.



The logo for Building AMERICA features the word "Building" in a script font above the word "AMERICA" in a bold, sans-serif font. To the right of the text is a stylized American flag with stars and stripes.

NO CLAIM IS MADE TO THE EXCLUSIVE RIGHT TO USE "AMERICA", APART FROM THE MARK AS SHOWN.

THE MARK CONSISTS, IN PART, OF A DEPICTION OF A STYLIZED "AMERICAN" FLAG AND DEPICTION OF STARS ABOVE THE TERM "BUILDING".

FOR ENGINEERING SERVICES, NAMELY, ENGINEERING IN THE FIELD OR RESIDENTIAL CONSTRUCTION FOR THE DEVELOPMENT AND ADOPTION OF ADVANCED BUILDING ENERGY IN NEW RESIDENTIAL BUILDINGS (U.S. CLS. 100 AND 101).

FIRST USE 2-0-1998; IN COMMERCE 2-0-1998.

SN 76-199,457. COSMOS EUROPEAN TRAVELS, AKTIENGESELLSCHAFT, VADUZ, LIECHTENSTEIN, FILED 1-23-2001.

TAPESTRY TRAVELS

NO CLAIM IS MADE TO THE EXCLUSIVE RIGHT TO USE "TRAVELS", APART FROM THE MARK AS SHOWN.

FOR TRAVEL AGENCY SERVICES, NAMELY, MAKING RESERVATIONS AND BOOKING FOR TEMPORARY LODGING; AND ARRANGING FOR RESTAURANT RESERVATIONS (U.S. CLS. 100 AND 101).

SN 76-210,033. CABANA CAY, L.L.C., FREEPORT, FL. FILED 2-14-2001.

CABANA CAY

NO CLAIM IS MADE TO THE EXCLUSIVE RIGHT TO USE "CAY", APART FROM THE MARK AS SHOWN.

FOR RESORT SERVICES, FEATURING CONDOMINIUM RESORTS (U.S. CLS. 100 AND 101).

FIRST USE 9-12-2000; IN COMMERCE 9-12-2000.

SN 76-211,696. MR. NEAT'S TUX SHOP OF COLORADO, INC., LOVELAND, CO. FILED 2-16-2001.



The logo for MISTER NEAT'S FORMALWEAR features a small illustration of a man in a tuxedo and top hat to the left of the text "MISTER NEAT'S FORMALWEAR" in a bold, serif font.

NO CLAIM IS MADE TO THE EXCLUSIVE RIGHT TO USE "FORMALWEAR", APART FROM THE MARK AS SHOWN.

FOR RENTAL OF MEN'S, WOMEN'S, AND BOY'S FORMAL WEAR (U.S. CLS. 100 AND 101).

FIRST USE 9-0-1985; IN COMMERCE 9-0-1985.

CLASS 42—(Continued).

SN 76-212,895. INDIANA MILLS & MANUFACTURING, INC., WESTFIELD, IN. FILED 2-16-2001.



NO CLAIM IS MADE TO THE EXCLUSIVE RIGHT TO USE "CENTER FOR ADVANCED PRODUCT EVALUATION" OR "THE WORLD'S FOREMOST VEHICLE TEST CENTER", APART FROM THE MARK AS SHOWN.

FOR THE SERVICE OF TESTING VEHICLES INCLUDING RESTRAINTS SYSTEMS BY BARRIER TESTING, SLED TESTING, ROLL OVER IMPACT TESTING, AND STATIC PULL TESTING (U.S. CLS. 100 AND 101).
FIRST USE 11-0-1999; IN COMMERCE 11-0-1999.

SN 76-215,629. TEK INTERACTIVE GROUP, INC., FORT WAYNE, IN. FILED 2-23-2001.

WEB2RETAIL

FOR COMPUTER SERVICES, NAMELY PROVIDING ACCESS TO NON-DOWNLOADABLE COMPUTER SOFTWARE FOR CREATING AND MAINTAINING A WEB SITE VIA A GLOBAL INFORMATION NETWORK; COMPUTER SOFTWARE CONSULTATION (U.S. CLS. 100 AND 101).

SN 76-216,527. NATIONAL SHOOTING SPORTS FOUNDATION, INC, NEWTOWN, CT. FILED 2-27-2001.

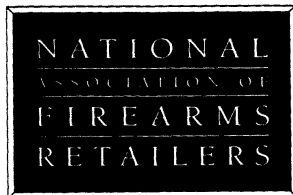

NO CLAIM IS MADE TO THE EXCLUSIVE RIGHT TO USE "NATIONAL ASSOCIATION OF FIREARMS RETAILERS", APART FROM THE MARK AS SHOWN.

FOR ASSOCIATION SERVICES, NAMELY, PROMOTING THE LEGAL, LEGISLATIVE AND POLITICAL INTERESTS OF RETAIL STORES SELLING FIREARMS (U.S. CLS. 100 AND 101).
FIRST USE 12-0-2000; IN COMMERCE 12-0-2000.

CLASS 42—(Continued).

SN 76-224,167. ACADEMY GRAPHIC COMMUNICATION, INC., CLEVELAND, OH. FILED 3-14-2001.



FOR PRINTING SERVICES (U.S. CLS. 100 AND 101).
FIRST USE 7-1-1991; IN COMMERCE 7-1-1991.

SN 76-225,624. CARRCHEM INC., BRONX, NY. FILED 3-19-2001.



NO CLAIM IS MADE TO THE EXCLUSIVE RIGHT TO USE "INC. ENGINEERING EXCELLENCE", APART FROM THE MARK AS SHOWN.

FOR ENERGY USAGE MANAGEMENT; ENGINEERING; SANITATION CONSULTATION ENGINEERING; COMPUTER SOFTWARE DESIGN FOR OTHERS; COMPUTER CONSULTATION (U.S. CLS. 100 AND 101).
FIRST USE 9-5-2000; IN COMMERCE 9-5-2000.

SN 76-229,454. DENTAL COMFORT ZONE P.C., THE, BENSALEM, PA. FILED 3-23-2001.



NO CLAIM IS MADE TO THE EXCLUSIVE RIGHT TO USE "DENTAL", APART FROM THE MARK AS SHOWN.
FOR DENTAL SERVICES (U.S. CLS. 100 AND 101).
FIRST USE 1-1-1997; IN COMMERCE 1-1-1997.

CLASS 42—(Continued).

SN 76-230,219. STARWOOD HOTELS & RESORTS WORLD-WIDE, INC., WHITE PLAINS, NY. FILED 3-23-2001.

LAST MINUTE WEEKEND RATES

NO CLAIM IS MADE TO THE EXCLUSIVE RIGHT TO USE "WEEKEND RATES", APART FROM THE MARK AS SHOWN.

FOR HOTEL SERVICES FEATURING A FREQUENT GUEST AWARD PROGRAM (U.S. CLS. 100 AND 101).
FIRST USE 10-0-2000; IN COMMERCE 10-0-2000.

SN 76-230,637. STARWOOD HOTELS & RESORTS WORLD-WIDE, INC., WHITE PLAINS, NY. FILED 3-23-2001.

LAST MINUTE WEEKENDS

NO CLAIM IS MADE TO THE EXCLUSIVE RIGHT TO USE "WEEKENDS", APART FROM THE MARK AS SHOWN.

FOR HOTEL SERVICES FEATURING A FREQUENT GUEST AWARD PROGRAM (U.S. CLS. 100 AND 101).

SN 76-232,154. TERAX COMMUNICATION TECHNOLOGIES INC., HSINCHU, TAIWAN, FILED 3-28-2001.

TERAX

FOR DESIGNING COMMUNICATION SYSTEMS FOR OTHERS, NAMELY, INTEGRATED CIRCUITS, WIRELESS COMMUNICATION SYSTEMS, RADIO FREQUENCY COMMUNICATIONS SYSTEMS, AND BASEBAND COMMUNICATION SYSTEMS; DESIGNING COMPUTER SOFTWARE AND FIRMWARE FOR OTHERS (U.S. CLS. 100 AND 101).

SN 76-233,454. CYLARK DEVELOPMENT LLC, BERKELEY, CA. FILED 3-29-2001.

CYLARK

FOR RESEARCH AND DEVELOPMENT SERVICES IN THE FIELD OF CONSUMER ELECTRONICS PRODUCTS (U.S. CLS. 100 AND 101).

SN 76-236,103. CREATING-THE-BALANCE, L.L.C., OAK RIDGE, NJ. FILED 4-6-2001.

SHELBY & SHELDON

FOR PROMOTING PUBLIC AWARENESS ABOUT HEALTH CONCEPTS AND DISSEMINATING INFORMATION REGARDING HEALTH AWARENESS CONCEPTS THROUGH THE INTERNET AND PRINTED MATERIALS (U.S. CLS. 100 AND 101).

CLASS 42—(Continued).

SN 76-236,847. ADP & ASSOCIATES, BROOKSVILLE, FL. FILED 4-9-2001.



FOR HOME INSPECTIONS (U.S. CLS. 100 AND 101).

SN 76-238,712. INTERNATIONAL UNION, SECURITY, POLICE AND FIRE PROFESSIONALS OF AMERICA (SPFPA), ROSEVILLE, MI. FILED 4-4-2001.

INTERNATIONAL UNION, SECURITY, POLICE AND FIRE PROFESSIONALS OF AMERICA (SPFPA)

NO CLAIM IS MADE TO THE EXCLUSIVE RIGHT TO USE "INTERNATIONAL UNION, SECURITY, POLICE AND FIRE PROFESSIONALS OF AMERICA", APART FROM THE MARK AS SHOWN.

FOR LABOR UNION (U.S. CLS. 100 AND 101).
FIRST USE 5-18-2000; IN COMMERCE 5-18-2000.

SN 76-239,747. BOSTON CONCESSIONS GROUP, INC., CAMBRIDGE, MA. FILED 4-12-2001.

BC GEAR

FOR CATERING SERVICES (U.S. CLS. 100 AND 101).

CLASS 42—(Continued).

SN 76-240,973. AMERICAN ACADEMY OF AUDIOLOGY, MCLEAN, VA. FILED 4-13-2001.



NO CLAIM IS MADE TO THE EXCLUSIVE RIGHT TO USE "AMERICAN BOARD OF AUDIOLOGY", APART FROM THE MARK AS SHOWN.

FOR ASSOCIATION SERVICES, NAMELY, PROMOTING THE INTERESTS OF QUALITY PROFESSIONALS IN THE FIELD OF AUDIOLOGY BY ANALYZING AND EVALUATING INDIVIDUALS FOR PURPOSES OF CERTIFICATION IN THE FIELD OF AUDIOLOGY (U.S. CLS. 100 AND 101).

FIRST USE 3-15-2001; IN COMMERCE 3-15-2001.

SN 76-240,974. AMERICAN ACADEMY OF AUDIOLOGY, MCLEAN, VA. FILED 4-13-2001.



NO CLAIM IS MADE TO THE EXCLUSIVE RIGHT TO USE "AMERICAN BOARD OF AUDIOLOGY BOARD CERTIFIED IN AUDIOLOGY", APART FROM THE MARK AS SHOWN.

FOR ASSOCIATION SERVICES, NAMELY, PROMOTING THE INTERESTS OF QUALITY PROFESSIONALS IN THE FIELD OF AUDIOLOGY BY ANALYZING AND EVALUATING INDIVIDUALS FOR PURPOSES OF CERTIFICATION IN THE FIELD OF AUDIOLOGY (U.S. CLS. 100 AND 101).

FIRST USE 3-15-2001; IN COMMERCE 3-15-2001.

SN 76-243,855. CIGNA INTELLECTUAL PROPERTY, INC., WILMINGTON, DE. FILED 4-20-2001.

CIGNA'S COMPLIANCE ADVISORY SERVICES

OWNER OF U.S. REG. NOS. 1,270,224 AND 1,926,164. NO CLAIM IS MADE TO THE EXCLUSIVE RIGHT TO USE "COMPLIANCE ADVISORY SERVICES", APART FROM THE MARK AS SHOWN.

FOR PROVIDING SPONSORS OF RETIREMENT INVESTMENT PLANS WITH CONSULTATION AND ADVISORY SERVICES REGARDING REGULATORY AND COMPLIANCE ISSUES (U.S. CLS. 100 AND 101).

CLASS 42—(Continued).

SN 76-246,019. LAYOOESH CENTER, INC., KIRKLAND, WA. FILED 4-26-2001.

LAYOOESH

FOR PROVIDING HEALTH INFORMATION; HEALING SERVICES, NAMELY HEALING WITH LIGHT, SOUND AND COLOR VIBRATIONS (U.S. CLS. 100 AND 101).

SN 76-246,852. RIEDY, MARIAN K., WASHINGTON, DC. FILED 4-27-2001.

PILL PILOT

NO CLAIM IS MADE TO THE EXCLUSIVE RIGHT TO USE "PILL", APART FROM THE MARK AS SHOWN.

FOR PROVIDING AN ELECTRONIC MEDICATION SCHEDULE VIA THE INTERNET FOR MONITORING MEDICATION COMPLIANCE (U.S. CLS. 100 AND 101).

SN 76-247,447. CHRISTIAN MEDICAL AND DENTAL SOCIETY, BRISTOL, TN. FILED 4-20-2001.

CHANGING HEARTS IN HEALTHCARE

FOR ASSOCIATION SERVICES, NAMELY PROMOTING THE INTERESTS, GOALS AND OBJECTIVES OF CHRISTIAN PHYSICIANS AND DENTISTS (U.S. CLS. 100 AND 101).

FIRST USE 6-8-2000; IN COMMERCE 6-8-2000.

SN 76-254,441. BOSTON BEER CORPORATION, BOSTON, MA. FILED 5-9-2001.

SAM ADAMS CELEBRATES

OWNER OF U.S. REG. NOS. 1,987,061, 2,288,190 AND OTHERS.

THE NAME "SAM ADAMS" DOES NOT IDENTIFY A LIVING INDIVIDUAL.

FOR BREWHOUSES, NAMELY, BAR AND RESTAURANT SERVICES (U.S. CLS. 100 AND 101).

SN 76-254,773. COURSEN, SHANE, PAHRUMP, NV. FILED 5-9-2001.

IN THE WILD

FOR CONSULTING AND RESEARCH SERVICES IN THE FIELDS OF COMPUTER AND DATA SECURITY AND COMPUTER VIRUS DETECTION AND REMOVAL (U.S. CLS. 100 AND 101).

FIRST USE 1-6-1991; IN COMMERCE 12-0-1993.

CLASS 42—(Continued).

SN 76-257,373. O2 HOLDINGS, LLC, NEW YORK, NY. FILED 5-14-2001.

LOUDER THAN WORDS

FOR COMPUTER SERVICES, NAMELY PROVIDING AN INTERACTIVE WEB-SITE ON THE INTERNET PROVIDING INFORMATION RELATING TO A MULTI-MEDIA AND GRASSROOTS CAMPAIGN TO INCREASE THE NUMBER OF WOMEN SERVING IN LEADERSHIP POSITIONS AT COMMUNITY, LOCAL, STATE AND NATIONAL LEVELS (U.S. CLS. 100 AND 101).

SN 76-260,913. SOUTH CAROLINA DEFENSE TRIAL ATTORNEYS' ASSOCIATION, COLUMBIA, SC. FILED 5-24-2001.



NO CLAIM IS MADE TO THE EXCLUSIVE RIGHT TO USE "SOUTH CAROLINA DEFENSE TRIAL ATTORNEYS' ASSOCIATION", APART FROM THE MARK AS SHOWN.

FOR ASSOCIATION SERVICES, NAMELY, PROMOTING THE INTERESTS OF TRIAL ATTORNEYS (U.S. CLS. 100 AND 101).

FIRST USE 1-0-2001; IN COMMERCE 1-0-2001.

SN 76-264,951. HOFFMANN-LA ROCHE INC., NUTLEY, NJ. FILED 5-29-2001.



OWNER OF U.S. REG. NO. 1,903,846. THE LINING IS A FEATURE OF THE MARK AND DOES NOT INDICATE COLOR.

FOR PROVIDING HEALTH INFORMATION BY TELEPHONE; NAMELY, INFORMATION ON HEALTH INSURANCE REIMBURSEMENT FOR PHARMACEUTICAL PREPARATIONS (U.S. CLS. 100 AND 101).

FIRST USE 6-0-1992; IN COMMERCE 6-0-1992.

CLASS 42—(Continued).

SN 76-265,150. NORTH COUNTRY ACADEMY EXECUTIVE, L.L.C., SARATOGA SPRINGS, NY. FILED 6-1-2001.

NORTH COUNTRY ACADEMY

NO CLAIM IS MADE TO THE EXCLUSIVE RIGHT TO USE "ACADEMY", APART FROM THE MARK AS SHOWN. FOR CHILD CARE SERVICE (U.S. CLS. 100 AND 101). FIRST USE 4-13-1998; IN COMMERCE 4-13-1998.

SN 76-265,736. AMGEN INC., THOUSAND OAKS, CA. FILED 6-1-2001.



Successful Outcomes
in Anemia Research

NO CLAIM IS MADE TO THE EXCLUSIVE RIGHT TO USE "ANEMIA RESEARCH", APART FROM THE MARK AS SHOWN.

FOR CONDUCTING CLINICAL TRIALS, MEDICAL RESEARCH AND DEVELOPMENT IN THE FIELD OF ANEMIA RESEARCH AND PHARMACEUTICAL PRODUCTS (U.S. CLS. 100 AND 101).

SN 76-266,985. LIGHTING PRACTICE, INC., THE, PHILADELPHIA, PA. FILED 6-6-2001.

The Lighting Practice

NO CLAIM IS MADE TO THE EXCLUSIVE RIGHT TO USE "LIGHTING", APART FROM THE MARK AS SHOWN. FOR DESIGN FOR OTHERS IN THE FIELD OF LIGHTING (U.S. CLS. 100 AND 101).

FIRST USE 12-21-1992; IN COMMERCE 12-21-1992.

SN 76-267,042. NUTECH SOLUTIONS, INC., CHARLOTTE, NC. FILED 6-5-2001.

INFERNO SEARCH

NO CLAIM IS MADE TO THE EXCLUSIVE RIGHT TO USE "SEARCH", APART FROM THE MARK AS SHOWN.

FOR COMPUTER SERVICES, NAMELY, PROVIDING SEARCH ENGINES FOR OBTAINING DATA ON A GLOBAL COMPUTER NETWORK (U.S. CLS. 100 AND 101).

FIRST USE 1-5-2000; IN COMMERCE 2-1-2000.

CLASS 42—(Continued).

SN 76-267,505. ALEXANDER, HOOVER H., JR., AUSTIN, TX. FILED 6-4-2001.

"THE 'GOOD TASTE' PLACE"

FOR RESTAURANT SERVICES (U.S. CLS. 100 AND 101).
FIRST USE 10-16-1998; IN COMMERCE 10-16-1998.

SN 76-270,894. CITY OF LOS ANGELES, LOS ANGELES, CA. FILED 6-13-2001.



NO CLAIM IS MADE TO THE EXCLUSIVE RIGHT TO USE "CITY OF LOS ANGELES, FOUNDED 1781" AND "ONLINE.ORG", APART FROM THE MARK AS SHOWN.
FOR PROVIDING INFORMATION IN THE FIELDS OF LAW ENFORCEMENT AND SERVICES PROVIDED BY LAW ENFORCEMENT OFFICERS TO THE COMMUNITY VIA A WEB SITE OFFERED ON A GLOBAL COMPUTER NETWORK (U.S. CLS. 100 AND 101).
FIRST USE 8-21-1998; IN COMMERCE 8-21-1998.

SN 76-278,793. GURFEIN, IRA, SAG HARBOR, NY, AND GURFEIN, PERRIE, SAG HARBOR, NY. FILED 6-29-2001.

STYLE BAR

FOR DAY SPA SERVICES, NAMELY, TANNING, MASSAGE, AND SKIN CARE SERVICES (U.S. CLS. 100 AND 101).
FIRST USE 5-25-2000; IN COMMERCE 5-25-2000.

SN 76-281,466. TM ACQUISITION CORP., PHOENIX, AZ. FILED 7-6-2001.

WE'RE EXPECTING YOU

FOR HOTEL, MOTEL AND RESTAURANT SERVICES; MAKING TEMPORARY LODGING RESERVATIONS FOR OTHERS (U.S. CLS. 100 AND 101).
FIRST USE 5-14-2001; IN COMMERCE 5-14-2001.

CLASS 42—(Continued).

SN 76-281,578. UNWIRED EXPRESS, INC., COLUMBIA, MD. FILED 7-6-2001.



FOR PROVIDING TEMPORARY USE OF NON-DOWNLOADABLE COMPUTER SOFTWARE OFFERED IN AN ASP MODEL FOR THE DEVELOPMENT AND DEPLOYMENT OF CONTEXT DRIVEN MOBILE ENABLEMENT APPLICATIONS, WIRELESS COMMUNICATION AND WIRELESS TRANSMISSION OF DATA (U.S. CLS. 100 AND 101).

SN 76-281,774. TRUMP TAJ MAHAL ASSOCIATES, ATLANTIC CITY, NJ. FILED 7-6-2001.

MARK ANTHONY'S RISTORANTE

NO CLAIM IS MADE TO THE EXCLUSIVE RIGHT TO USE "RISTORANTE", APART FROM THE MARK AS SHOWN.
THE ENGLISH TRANSLATION OF "RISTORANTE" IS "RESTAURANT".
FOR RESTAURANT SERVICES (U.S. CLS. 100 AND 101).

SN 76-285,225. BRINKER RESTAURANT CORPORATION, DALLAS, TX. FILED 6-19-2001.



OWNER OF U.S. REG. NO. 2,134,706.
NO CLAIM IS MADE TO THE EXCLUSIVE RIGHT TO USE "GRILL", APART FROM THE MARK AS SHOWN.
FOR RESTAURANT SERVICES (U.S. CLS. 100 AND 101).
FIRST USE 2-0-1998; IN COMMERCE 2-0-1998.

SN 76-285,337. HARDWICK, DEBORAH, NEW YORK, NY. FILED 7-16-2001.

BUFFFLEXOLOGY

FOR DAY SPA SERVICES, NAMELY, MASSAGE AND REFLEXOLOGY, (U.S. CLS. 100 AND 101).
FIRST USE 11-0-2000; IN COMMERCE 11-0-2000.

CLASS 42—(Continued).

SN 76-285,392. FIRST GENETIC TRUST, INC., DEERFIELD, IL. FILED 7-13-2001.



NO CLAIM IS MADE TO THE EXCLUSIVE RIGHT TO USE "GENETIC", APART FROM THE MARK AS SHOWN.
FOR GENETIC BANKING SERVICES, NAMELY, MAINTAINING PERSONAL GENETIC AND PHENOTYPIC RECORDS AND FILES; DNA GENOTYPING AND ANALYSIS; MEDICAL COUNSELING, NAMELY COUNSELING IN THE FIELD OF GENETICS; GENETIC RESEARCH; AND COMPUTER SERVICES, NAMELY PROVIDING SECURE ONLINE ACCESS TO SOFTWARE FOR THE STORAGE, MANAGEMENT AND ANALYSIS OF GENETIC INFORMATION (U.S. CLS. 100 AND 101).

SN 76-291,439. STRATOSPHERE CORPORATION, LAS VEGAS, NV. FILED 7-27-2001.



NO CLAIM IS MADE TO THE EXCLUSIVE RIGHT TO USE "CAFE", APART FROM THE MARK AS SHOWN.
FOR RESTAURANT, BAR AND LOUNGE SERVICES (U.S. CLS. 100 AND 101).

SN 76-298,339. NATIONAL ENVIRONMENTAL TRUST, WASHINGTON, DC. FILED 8-13-2001.



NO CLAIM IS MADE TO THE EXCLUSIVE RIGHT TO USE "NATIONAL ENVIRONMENTAL TRUST", APART FROM THE MARK AS SHOWN.

THE MARK IS LINED FOR THE COLORS GREEN AND BLUE.

FOR RESEARCH IN THE FIELD OF ENVIRONMENTAL CONSERVATION; PROVIDING INFORMATION VIA A WEBSITE IN THE FIELD OF ENVIRONMENTAL CONSERVATION; PROMOTING PUBLIC AND POLICY MAKERS' AWARENESS OF THE NEED FOR ENVIRONMENTAL CONSERVATION THROUGH PUBLICATION OF NEWSLETTERS, BROCHURES, FACT SHEETS AND OTHER SIMILAR DOCUMENTS (U.S. CLS. 100 AND 101).

FIRST USE 6-30-1999; IN COMMERCE 6-30-1999.

CLASS 42—(Continued).

SN 76-298,340. NATIONAL ENVIRONMENTAL TRUST ACTION FUND, WASHINGTON, DC. FILED 8-13-2001.



NO CLAIM IS MADE TO THE EXCLUSIVE RIGHT TO USE NO CLAIM IS MADE TO THE EXCLUSIVE RIGHT TO USE "ACTION FUND" APART FROM THE MARKS AS SHOWN., APART FROM THE MARK AS SHOWN.
THE MARK IS LINED FOR THE COLORS GREEN AND BLUE.

FOR RESEARCH IN THE FIELD OF ENVIRONMENTAL CONSERVATION; PROMOTING PUBLIC AND POLICY MAKERS' AWARENESS OF THE NEED FOR ENVIRONMENTAL CONSERVATION THROUGH PUBLICATION OF NEWSLETTERS, BROCHURES, FACT SHEETS AND OTHER SIMILAR DOCUMENTS (U.S. CLS. 100 AND 101).

SN 76-299,737. YTC CORPORATION LIMITED, SINGAPORE, FILED 8-15-2001.



FOR HOTEL AND MOTEL SERVICES; RESTAURANT AND CATERING SERVICES; PROVISION OF CONVENTION SPACE AND FACILITIES FOR GENERAL MEETINGS, CONFERENCES AND EXHIBITIONS; RESERVATION SERVICES FOR HOTEL ACCOMMODATIONS (U.S. CLS. 100 AND 101).

SN 76-299,853. GENAISSANCE PHARMACEUTICALS, NEW HAVEN, CT. FILED 8-13-2001.

MEDNOSTICS

FOR RESEARCH, CONSULTING AND PRODUCT DEVELOPMENT SERVICES RENDERED TO PHARMACEUTICAL AND HEALTHCARE COMPANIES IN THE FIELDS OF GENOMICS, DRUG RESPONSE AND CLINICAL DEVELOPMENT; CONSULTING SERVICES RENDERED TO MEDICAL DEVICE COMPANIES IN THE AREA OF DIAGNOSTICS (U.S. CLS. 100 AND 101).

CLASS 42—(Continued).

SN 76-300,187. HOLIDAY INN - WEST CHESTER, WEST CHESTER, PA. FILED 8-15-2001.

TURKS HEAD RESTAURANT & LOUNGE

NO CLAIM IS MADE TO THE EXCLUSIVE RIGHT TO USE "RESTAURANT & LOUNGE", APART FROM THE MARK AS SHOWN.
FOR FOOD AND BEVERAGE SERVICES IN A HOTEL RESTAURANT (U.S. CLS. 100 AND 101).

SN 76-303,123. ENCOMPASS GROUP, LLC, MCDONOUGH, GA. FILED 8-23-2001.

WORLD OF WELCOME

FOR MOTEL AND HOTEL SERVICES, (U.S. CLS. 100 AND 101).

SN 76-306,753. SMALL PLATES LLC, NOVI, MI. FILED 8-29-2001.

SMALL PLATES

FOR RESTAURANT SERVICES (U.S. CLS. 100 AND 101).

SN 76-307,346. XYBERNAUT CORPORATION, FAIRFAX, VA. FILED 8-30-2001.

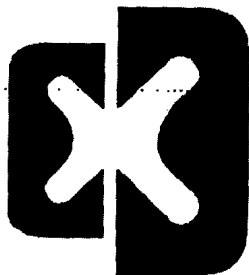

FOR CONSULTING SERVICES IN THE FIELD OF HANDS FREE WEARABLE COMPUTERS AND RELATED SOFTWARE (U.S. CLS. 100 AND 101).
FIRST USE 8-27-2001; IN COMMERCE 8-27-2001.

CLASS 42—(Continued).

SN 76-307,433. REPIN-SKEES, INC., CHANDLER, AZ. FILED 8-30-2001.



FOR RESTAURANT SERVICES (U.S. CLS. 100 AND 101).

SN 76-308,753. ALL PETS CREMATORY & FUNERAL SERVICE, LLC, STAMFORD, CT. FILED 9-4-2001.



NO CLAIM IS MADE TO THE EXCLUSIVE RIGHT TO USE "ALL PETS" AND "CREMATORY & FUNERAL SERVICE", APART FROM THE MARK AS SHOWN.
FOR PET CREMATION, FUNERAL, AND MORTUARY SERVICES (U.S. CLS. 100 AND 101).

SN 76-310,768. COLON & RECTAL CARE, INC., INDIANAPOLIS, IN. FILED 9-10-2001.

AMERISCOPE

FOR MEDICAL SERVICES - NAMELY-COLON CANCER PREVENTION PROCEDURES (U.S. CLS. 100 AND 101).

CLASS 42—(Continued).

SN 76-311,703. ARCINA, LLC, STATE COLLEGE, PA. FILED 9-14-2001.

ARCINA

FOR TECHNICAL CONSULTATION AND RESEARCH IN THE FIELD OF METALS, CHEMISTRY, AUTOMOTIVE MATERIALS, AND INJECTION MOLDING (U.S. CLS. 100 AND 101).

SN 76-313,455. HALLIBURTON ENERGY SERVICES, INC., CARROLLTON, TX. FILED 9-18-2001.

WELLIFE

FOR OIL AND GAS WELL SERVICES, NAMELY, PROVIDING CONSULTING AND DESIGN ANALYSIS FOR CEMENTING OPERATIONS (U.S. CLS. 100 AND 101).

SN 76-313,683. ROCKRESORTS LLC, DALLAS, TX. FILED 9-14-2001.

AVANYU

FOR SPA SERVICES, NAMELY, PROVIDING FACIALS, MASSAGES, SWEDISH MASSAGES, MANICURES, PEDICURES, BEAUTY TREATMENTS, SAUNA FACILITIES, AROMATHERAPY, HERBAL TREATMENTS, SEAWEED WRAPS, SALT SEA RUBS, ACUPUNCTURE THERAPY, HOT STONE THERAPY, WET TREATMENTS, SALON SERVICES, NAMELY HAIR CUTS, HAIR TREATMENTS, STYLING, PERMANENTS, COLORING (U.S. CLS. 100 AND 101).

FIRST USE 7-0-1999; IN COMMERCE 7-0-1999.

SN 76-313,688. ROCKRESORTS LLC, DALLAS, TX. FILED 9-14-2001.



FOR SPA SERVICES, NAMELY, PROVIDING FACIALS, MASSAGES, SWEDISH MASSAGES, MANICURES, PEDICURES, BEAUTY TREATMENTS, SAUNA FACILITIES, AROMATHERAPY, HERBAL TREATMENTS, SEAWEED WRAPS, SALT SEA RUBS, ACUPUNCTURE THERAPY, HOT STONE THERAPY, WET TREATMENTS, SALON SERVICES, NAMELY HAIR CUTS, HAIR TREATMENTS, STYLING, PERMANENTS, AND COLORING (U.S. CLS. 100 AND 101).

FIRST USE 7-0-1999; IN COMMERCE 7-0-1999.

CLASS 42—(Continued).

SN 78-006,734. NETPROSPECTOR, LLC, JAMESTOWN, NY. FILED 5-4-2000.

NETPROSPECTOR

FOR COMPUTER SERVICES, NAMELY, PROVIDING SEARCH ENGINES FOR OBTAINING DATA ON GLOBAL AND LOCAL COMPUTER NETWORKS (U.S. CLS. 100 AND 101).

SN 78-014,152. WOODLAND CREEK RANCH CORPORATION, DALLAS, TX. FILED 6-23-2000.

WOODLAND CREEK RANCH CORPORATION

NO CLAIM IS MADE TO THE EXCLUSIVE RIGHT TO USE "RANCH CORPORATION", APART FROM THE MARK AS SHOWN.

FOR FARMING, RANCHING AND CATTLE RAISING OPERATION (U.S. CLS. 100 AND 101).

SN 78-014,156. APTUS GENOMICS, INC., BETHESDA, MD. FILED 6-23-2000.

APTUS GENOMICS

NO CLAIM IS MADE TO THE EXCLUSIVE RIGHT TO USE "GENOMICS", APART FROM THE MARK AS SHOWN.

FOR DESIGN FOR OTHERS OF GENETIC AND DRUG RESEARCH TOOLS AND SYSTEMS IN THE FIELD OF FUNCTIONAL GENOMICS, NAMELY, PROVIDING FUNCTIONAL GENES AND USING SUCH GENES IN HIGH-THROUGHPUT RESEARCH AND DEVELOPMENT SYSTEMS, DEVELOPING A TECHNOLOGY PLATFORM USED TO DISCOVER, QUALIFY AND UTILIZE IMPORTANT FAMILIES OF HUMAN GENES FOR PHARMACEUTICAL RESEARCH, AND TO DETERMINE THE FUNCTIONS AND ROLES OF SUCH GENES IN AFFECTING THE HUMAN CONDITION (U.S. CLS. 100 AND 101).

SN 78-015,029. ELLSWORTH CORPORATION, GERMANTOWN, WI. FILED 6-29-2000.

GLUE DOCTOR

NO CLAIM IS MADE TO THE EXCLUSIVE RIGHT TO USE "GLUE", APART FROM THE MARK AS SHOWN.

FOR RESEARCH AND TECHNICAL CONSULTING IN THE FIELD OF CONSUMER AND INDUSTRIAL GLUE AND ADHESIVE APPLICATIONS (U.S. CLS. 100 AND 101).

FIRST USE 3-0-1999; IN COMMERCE 7-0-1999.

CLASS 42—(Continued).

SN 78-015,388. 126 BAKE CORPORATION, NEW YORK, NY. FILED 7-4-2000.

TASTY CAFE

NO CLAIM IS MADE TO THE EXCLUSIVE RIGHT TO USE "CAFE", APART FROM THE MARK AS SHOWN.
FOR RESTAURANT SERVICES (U.S. CLS. 100 AND 101).

SN 78-017,596. ENERGY E-COMM.COM, INC., CABIN JOHN, MD. FILED 7-20-2000.

INTELLIALERT

FOR COMPUTER SERVICES, NAMELY THE TRACKING OF CHANGES IN WEB PAGES RETRIEVED FROM A GLOBAL COMPUTER NETWORK AND THE ELECTRONIC NOTIFICATION OF THE CUSTOMER OF SUCH CHANGES (U.S. CLS. 100 AND 101).

SN 78-017,598. ENERGY E-COMM.COM, INC., CABIN JOHN, MD. FILED 7-20-2000.

INTELLILOG

FOR COMPUTER SERVICES, NAMELY THE TRACKING, MAINTAINING AND MANAGING OF THE HISTORY OF CHANGES IN WEB PAGES RETRIEVED FROM A GLOBAL COMPUTER NETWORK (U.S. CLS. 100 AND 101).

SN 78-018,784. LOCKHART, GARY, AUSTIN, TX. FILED 7-28-2000.

BLIMP PHOTO & VIDEO SERVICES

NO CLAIM IS MADE TO THE EXCLUSIVE RIGHT TO USE "PHOTO & VIDEO SERVICE", APART FROM THE MARK AS SHOWN.
FOR CLOSE-RANGE AERIAL IMAGING SERVICES, NAMELY VIDEO, PHOTOGRAPHY, INFRARED AND REMOTE SENSING IMAGING (U.S. CLS. 100 AND 101).
FIRST USE 12-30-1991; IN COMMERCE 1-15-1992.

CLASS 42—(Continued).

SN 78-018,787. LOCKHART, GARY, AUSTIN, TX. FILED 7-28-2000.

BLIMP PHOTO

NO CLAIM IS MADE TO THE EXCLUSIVE RIGHT TO USE "PHOTO", APART FROM THE MARK AS SHOWN.
FOR CLOSE-RANGE AERIAL IMAGING SERVICES, NAMELY VIDEO, PHOTOGRAPHY, INFRARED AND REMOTE SENSING IMAGING (U.S. CLS. 100 AND 101).
FIRST USE 12-30-1991; IN COMMERCE 1-15-1992.

SN 78-019,106. MORROW, JOANNE, LEBANON, ME. FILED 8-1-2000.

FOR SIMPLICITY SAKE

FOR INTERIOR DECORATION CONSULTATION (U.S. CLS. 100 AND 101).
FIRST USE 1-1-2000; IN COMMERCE 1-1-2000.

SN 78-019,946. PRESIDENTCHOICE.COM, WALNUT CREEK, CA. FILED 8-7-2000.

WWW.PRESIDENTCHOICE.COM

FOR DESIGN FOR OTHERS IN THE FIELD OF EMBROIDERY ON CLOTHING; WEB PAGE DESIGN FOR OTHERS (U.S. CLS. 100 AND 101).
FIRST USE 1-4-2000; IN COMMERCE 1-4-2000.

SN 78-021,614. JONES, GREGORY THOMAS, MARSHALL, NC. FILED 8-17-2000.

ELF-IMPROVEMENT CHRISTMAS DESIGNS

NO CLAIM IS MADE TO THE EXCLUSIVE RIGHT TO USE "CHRISTMAS DESIGNS", APART FROM THE MARK AS SHOWN.
FOR INTERIOR AND EXTERIOR DECORATING FOR HOMES AND BUSINESS; INTERIOR AND EXTERIOR DECORATING CONSULTATION FOR HOMES AND BUSINESS (U.S. CLS. 100 AND 101).
FIRST USE 8-12-2000; IN COMMERCE 8-12-2000.

CLASS 42—(Continued).

SN 78-023,039. FRIENDFINDER, INC., PALO ALTO, CA. FILED 8-25-2000.

HOTMATCH

FOR COMPUTER DATING SERVICES, COMPUTER SERVICES, NAMELY, PROVIDING DATABASES FEATURING GENERAL AND LOCAL NEWS, AND INFORMATION OF INTEREST TO SPECIFIC GEOGRAPHIC AREAS; PROVIDING AN ON-LINE ELECTRONIC DATABASE ON GLOBAL COMPUTER NETWORKS IN THE FIELD OF ON-LINE COMPUTER DATING (U.S. CLS. 100 AND 101).

SN 78-023,122. CIERANT CORPORATION, NEW MILFORD, CT. FILED 8-26-2000.

CIERANT

FOR COMPUTER SERVICES, NAMELY CREATING AND MAINTAINING WEB SITES FOR OTHERS; MAINTENANCE OF COMPUTER SOFTWARE (U.S. CLS. 100 AND 101).

SN 78-023,298. BYRD, SCOTT R., SAN ANTONIO, TX. FILED 8-28-2000.

MEDALARM

FOR ELECTRONIC INTERACTIVE MEDICATION COMPLIANCE MONITORING SERVICE, NAMELY, UTILIZING COMPUTER SYSTEMS TO MONITOR PATIENTS BY MEDICATION DATA COLLECTION AND ELECTRONIC COMMUNICATION WITH PATIENTS (U.S. CLS. 100 AND 101).

SN 78-024,311. 270WEB, INC., TA 270NET.COM, FREDRICK, MD. BY ASSIGNMENT PERFORMANCE ENHANCEMENT PRODUCTS, INC., FREDERICK, MD. FILED 9-4-2000.

YOUR BEST ROUTE TO THE INTERNET

NO CLAIM IS MADE TO THE EXCLUSIVE RIGHT TO USE "INTERNET", APART FROM THE MARK AS SHOWN. FOR COMPUTER SERVICES, NAMELY, DESIGNING AND IMPLEMENTING WEB SITES FOR OTHERS; DATABASE DEVELOPMENT SERVICES, NAMELY, CREATING CUSTOM DATABASES FOR OTHERS; HOSTING THE WEB SITES OF OTHERS ON A COMPUTER SERVER FOR A GLOBAL COMPUTER NETWORK (U.S. CLS. 100 AND 101).
FIRST USE 6-13-2000; IN COMMERCE 6-28-2000.

CLASS 42—(Continued).

SN 78-025,929. ERM-EFFECTIVE REHABILITATION MANAGEMENT INC., PALATINE, IL. FILED 9-14-2000.



NO CLAIM IS MADE TO THE EXCLUSIVE RIGHT TO USE "INC", APART FROM THE MARK AS SHOWN. SEC. 2(F) AS TO "EFFECTIVE REHABILITATION MANAGEMENT".

FOR PROVIDING DISABILITY MANAGEMENT OF INJURED WORKERS MEDICAL REMEDIES, AND VOCATIONAL REMEDIES, NAMELY, REVIEWING STANDARDS AND PRACTICES TO ASSURE COMPLIANCE WITH WORKER'S COMPENSATION LAWS AND REGULATIONS; TELEPHONE HOT LINE COUNSELING, NAMELY OFFERING ADVICE REGARDING WORKMAN'S COMPENSATION AND DISABILITY MANAGEMENT (U.S. CLS. 100 AND 101).

FIRST USE 3-8-1985; IN COMMERCE 3-8-1985.

SN 78-026,598. MILK SOURCE, LLC., KAUKAUNA, WI. FILED 9-19-2000.

CALFSOURCE

FOR AGRICULTURAL SERVICES-ANIMAL RAISING SERVICES (U.S. CLS. 100 AND 101).
FIRST USE 1-1-1998; IN COMMERCE 1-1-1998.

SN 78-029,681. BOOGIE TV, LLC, MONTCLAIR, NJ. FILED 10-9-2000.

LAP.TV

FOR COMPUTER SERVICES, NAMELY, PROVIDING SEARCH ENGINES THAT INDEX LINKS TO ADULT ENTERTAINMENT WEBSITES, BROADCASTS, SCHEDULES AND TELEVISION PROGRAMS ON A GLOBAL COMPUTER NETWORK; PROVIDING A DISCRIMINATING SEARCH ENGINE FOR OBTAINING INFORMATION AND DATA IN THE FIELD OF ADULT ENTERTAINMENT (U.S. CLS. 100 AND 101).

CLASS 42—(Continued).

SN 78-031,039. EDGILENT CORP., ROLLING MEADOWS, IL. FILED 10-17-2000.

UNITEDEGE

FOR COMPUTER SERVICES IN THE FIELD OF BUSINESS-TO-BUSINESS E-COMMERCE IN THE OFFICE PRODUCTS INDUSTRY, NAMELY SERVICES TO HELP OFFICE PRODUCT DEALERS CREATE AND MANAGE ON-LINE OFFICE PRODUCT FILES AND CATALOGS, PUBLISH CONTRACT-SPECIFIC CATALOGS TO E-PROCUREMENT NETWORKS AND E-MARKETPLACES, MANAGE BUSINESS DOCUMENT FLOW TO AND FROM TRADING PARTNERS, INTEGRATE DATA FROM E-COMMERCE TRANSACTIONS WITH BUSINESS CONTROL SYSTEMS, FIND NEW SOURCES OF DEMAND, AND KEEP ABREAST OF KEY E-PROCUREMENT TRENDS AND DEVELOPMENTS (U.S. CLS. 100 AND 101).

FIRST USE 2-1-2001; IN COMMERCE 2-1-2001.

SN 78-031,826. KESSLER, KEVIN EUGENE, FLORISSANT, MO. FILED 10-22-2000.

CAMP CARPE DIEM

NO CLAIM IS MADE TO THE EXCLUSIVE RIGHT TO USE "CAMP", APART FROM THE MARK AS SHOWN.

THE LATIN TERM "CARPE DIEM" HAS AN ENGLISH TRANSLATION OF "SEIZE (THE) DAY". THEREFORE THE TRADEMARK TRANSLATION WOULD BE "CAMP SEIZE THE DAY".

FOR PSYCHOLOGICAL AND COUNSELING SERVICES AS WELL AS SOCIAL WORK, MOST OFTEN CONDUCTED, BUT NOT LIMITED TO, DURING A "SUMMER CAMP" OR "RETREAT" ENVIRONMENT (U.S. CLS. 100 AND 101).

SN 78-032,575. AMOR MINISTRIES, INC., SAN DIEGO, CA. FILED 10-26-2000.

COME BUILD HOPE

FOR EVANGELISTIC AND MINISTERIAL SERVICES TO PROMOTE THE MINISTRY (U.S. CLS. 100 AND 101).

SN 78-032,779. ANDERSON, JARED C., DBA TNT ADVERTISING AND PUBLISHING, FORT MYERS, FL. FILED 10-27-2000.



FOR COMPUTER SERVICES, NAMELY PROVIDING AN ON-LINE NEWSLETTER IN THE FIELD OF MISCELLANEOUS SUBJECT MATTER CONTAINING FUN FACTS, INTERESTING STORIES AND TRIVIA (U.S. CLS. 100 AND 101).

FIRST USE 12-1-1997; IN COMMERCE 8-1-2000.

CLASS 42—(Continued).

SN 78-033,725. AMERICAN CULINARY CONCEPTS, INC., SMITHTOWN, NY. FILED 11-3-2000.



NO CLAIM IS MADE TO THE EXCLUSIVE RIGHT TO USE "FAST FOOD THAT'S LITE", APART FROM THE MARK AS SHOWN.

FOR RESTAURANTS FEATURING FOOD AND BEVERAGE (U.S. CLS. 100 AND 101).

SN 78-034,359. ICHANCE, INC., LAS VEGAS, NV. FILED 11-8-2000.



FOR COMPUTER SERVICES, NAMELY, DESIGNING, CREATING, IMPLEMENTING AND MAINTAINING WEB SITES FOR OTHERS IN THE FIELD OF GAMING (U.S. CLS. 100 AND 101).

FIRST USE 3-30-2000; IN COMMERCE 3-30-2000.

SN 78-037,258. FORECOMM, LLC, CANTON, MI. FILED 11-30-2000.



NO CLAIM IS MADE TO THE EXCLUSIVE RIGHT TO USE "TELECOMMUNICATIONS SIMPLIFIED", APART FROM THE MARK AS SHOWN.

FOR CONSULTING SERVICES IN THE FIELD OF TELECOMMUNICATIONS, HOSTING THE WEB SITES OF OTHERS ON A COMPUTER SERVER FOR A GLOBAL COMPUTER NETWORK (U.S. CLS. 100 AND 101).

CLASS 42—(Continued).

SN 78-038,323. PAEDIA CORPORATION, SAN FRANCISCO, CA. FILED 12-7-2000.

PAEDIA

OWNER OF U.S. REG. NOS. 1,550,801 AND 1,551,714.
FOR CONSULTING AND INFORMATION SERVICES IN THE FIELDS OF ENGINEERING, PHYSICS, AND COMPUTER PROGRAMMING AND UTILIZATION; SCIENTIFIC RESEARCH; COMPUTERIZED, WEB-BASED, AND MANUAL RESEARCH SERVICES IN THE FIELDS OF ENGINEERING, PHYSICS AND COMPUTER PROGRAMMING (U.S. CLS. 100 AND 101).
FIRST USE 6-24-1988; IN COMMERCE 6-24-1988.

SN 78-038,824. PETS NEED NANNIES TOO, INC., PLANO, TX. FILED 12-11-2000.



NO CLAIM IS MADE TO THE EXCLUSIVE RIGHT TO USE "INC.", APART FROM THE MARK AS SHOWN.
THE LINING IS A FEATURE OF THE MARK AND DOES NOT INDICATE COLOR.
FOR IN HOME PET SITTING (U.S. CLS. 100 AND 101).
FIRST USE 12-7-2000; IN COMMERCE 12-7-2000.

SN 78-039,304. YOUTH DEVELOPMENT OF COLLIER COUNTY, INC., NAPLES, FL. FILED 12-14-2000.

PAT'S KIDS CLUB

NO CLAIM IS MADE TO THE EXCLUSIVE RIGHT TO USE "KID'S CLUB", APART FROM THE MARK AS SHOWN.
FOR CHARITABLE SERVICES, NAMELY CHILD CARE SERVICES, AND BEFORE AND AFTER SCHOOL EXTENDED DAY CARE SERVICES (U.S. CLS. 100 AND 101).
FIRST USE 9-0-1991; IN COMMERCE 9-0-1991.

CLASS 42—(Continued).

SN 78-040,999. AUSTIN, KENNETH R., DBA VIDEOSYNERGY STUDIO II, HONOLULU, HI. FILED 12-29-2000.

VIDEOSYNERGY

FOR MENTAL HEALTH SERVICES, NAMELY VIDEO FEEDBACK PSYCHOTHERAPY SESSIONS FOR INDIVIDUALS, COUPLES, FAMILIES AND GROUPS (U.S. CLS. 100 AND 101).
FIRST USE 9-22-2000; IN COMMERCE 11-27-2000.

SN 78-041,100. EMERALD ISLAND TECHNOLOGY, INC., KEIZER, OR. FILED 12-29-2000.

DIGITAL WITNESS

NO CLAIM IS MADE TO THE EXCLUSIVE RIGHT TO USE "DIGITAL", APART FROM THE MARK AS SHOWN.
FOR PROVIDE THIRD PARTY VERIFICATION OF THE SOURCE, AUTHENTICITY, COMPLETENESS AND INTEGRITY OF DIGITALLY TRANSMITTED DOCUMENTS (U.S. CLS. 100 AND 101).

SN 78-043,236. QUEST DIAGNOSTICS INCORPORATED, TETERBORO, NJ. FILED 1-15-2001.

CAGT

FOR PROVIDING CLINICAL LABORATORY TESTING SERVICES, NAMELY, PHARMACOGENETIC TESTS, PREDICTIVE MEDICAL TESTS, PERSONALIZED MEDICAL TESTS, GENE SEQUENCING-BASED TESTS AND GENOTYPING (U.S. CLS. 100 AND 101).

SN 78-043,775. FIRSHEIN, RICHARD, N. (D.O.), NEW YORK, NY. FILED 1-18-2001.

DR FIRSHEIN'S BREATH FOR LIFE PROGRAM

NO CLAIM IS MADE TO THE EXCLUSIVE RIGHT TO USE "PROGRAM", APART FROM THE MARK AS SHOWN.
THE NAME "DR FIRSHEIN" IDENTIFIES A LIVING INDIVIDUAL WHOSE CONSENT IS OF RECORD.
FOR MEDICAL SERVICES, NAMELY PROVIDING A COMPREHENSIVE MEDICAL PROGRAM FOR TREATING ASTHMA COMBINING DIET, SUPPLEMENTS, BREATHING EXERCISES, RELAXATION TECHNIQUES AND ENVIRONMENTAL MODIFICATION FOR ALL AGE GROUPS (U.S. CLS. 100 AND 101).

CLASS 42—(Continued).

SN 78-045,660. INSTITUTE FOR STRATEGIC CHANGE, SAN DIEGO, CA. FILED 1-30-2001.

**PRETTY WOMAN
SYNDROME PROJECT**

NO CLAIM IS MADE TO THE EXCLUSIVE RIGHT TO USE "PROJECT", APART FROM THE MARK AS SHOWN. FOR MENTAL HEALTH SERVICES (U.S. CLS. 100 AND 101).

SN 78-047,646. NORTH'S RESTAURANTS INC., MEDFORD, OR. FILED 2-9-2001.

JJ NORTH'S

OWNER OF U.S. REG. NO. 1,444,561. SEC. 2(F). FOR RESTAURANT SERVICES (U.S. CLS. 100 AND 101). FIRST USE 2-0-1986; IN COMMERCE 2-0-1986.

SN 78-049,028. MALUEG, KURT, F., DENVER, CO. FILED 2-19-2001.

**TRIPSTREAM
PRODUCTIONS**

NO CLAIM IS MADE TO THE EXCLUSIVE RIGHT TO USE "PRODUCTIONS", APART FROM THE MARK AS SHOWN.

FOR COMPUTER SERVICES, NAMELY, CREATING DIGITAL AUDIO AND VIDEO FILES FOR OTHERS FOR BROADCASTING VIA THE INTERNET (U.S. CLS. 100 AND 101).

SN 78-049,411. GAUPP, PETER, M., ROCKFORD, MN. AND GAUPP, CYNTHIA L., ROCKFORD, MN. FILED 2-20-2001.

**HAPPY DAYS DOGGIE
CAMP**

NO CLAIM IS MADE TO THE EXCLUSIVE RIGHT TO USE "DOGGIE", APART FROM THE MARK AS SHOWN.

FOR BOARDING OF DOGS ON A SHORT TERM BASES (U.S. CLS. 100 AND 101).

SN 78-049,741. THOMPSON, SHAWN, A, HARRISONBURG, VA. FILED 2-22-2001.

CORALWEB

FOR INTERNET CONSULTING (U.S. CLS. 100 AND 101). FIRST USE 10-15-1995; IN COMMERCE 10-15-1995.

CLASS 42—(Continued).

SN 78-053,426. HARTER, ELIZABETH R., ATHENS, GA. FILED 3-15-2001.

WRITENOW!

FOR WRITING AND EDITING SERVICES, NAMELY, WRITING AND EDITING OF SPEECHES, BUSINESS COMMUNICATIONS, ANNUAL REPORTS, MARKETING COPY, BROCHURES, BUSINESS PLANS, WEBSITE CONTENT, NEWSLETTERS, EDITORIALS, ARTICLES, PRESS RELEASES (U.S. CLS. 100 AND 101).

SN 78-055,567. COLLINS & AIKMAN PRODUCTS CO., TROY, MI. FILED 3-28-2001.

OPTIMASS

FOR TECHNICAL CONSULTATION AND RESEARCH IN THE FIELD OF OPTIMIZING THE ACOUSTICS WITHIN MOTOR VEHICLES; DESIGN OF STRUCTURAL PARTS AND ACCESSORIES FOR IMPROVING THE ACOUSTICS WITHIN MOTOR VEHICLES (U.S. CLS. 100 AND 101).

SN 78-056,159. CAMPBELL MITHUN ESTY, L.L.C., MINNEAPOLIS, MN. FILED 4-1-2001.

YELLO COMMUNICATIONS

NO CLAIM IS MADE TO THE EXCLUSIVE RIGHT TO USE "COMMUNICATIONS", APART FROM THE MARK AS SHOWN.

FOR GRAPHIC ART DESIGN SERVICES (U.S. CLS. 100 AND 101).

SN 78-056,570. DIAGNOSTIC ULTRASOUND CORPORATION, BOTHELL, WA. FILED 4-3-2001.

webDxU

FOR MEDICAL DIAGNOSTIC SERVICES, PROVIDED BY MEANS OF A SUPPLIED APPARATUS FOR USE BY MEDICAL PROFESSIONALS IN OBTAINING ULTRASOUND INFORMATION CONCERNING A SELECTED PORTION OF THE BODY AND IN TRANSMITTING SAID ULTRASOUND INFORMATION OVER A GLOBAL COMPUTER NETWORK TO A REMOTE LOCATION AND THEN PROCESSING SAID INFORMATION AT THE REMOTE LOCATION FOR PURPOSES OF DIAGNOSIS OF THE MEDICAL CONDITION OF THE SELECTED BODY PORTION (U.S. CLS. 100 AND 101).

CLASS 42—(Continued).

SN 78-057,943. WERNER, DONNA MARIE, NEW YORK, NY. FILED 4-11-2001.

DREAMS FULFILLED

FOR CHARITABLE SERVICES FOR TERMINALLY ILL ADULTS IN THE NATURE OF ARRANGING ACTIVITIES AND PROVIDING DONATIONS OF GOODS AND SERVICES FOR THE ADULTS BASED ON THEIR EXPRESSED REQUESTS (U.S. CLS. 100 AND 101).

SN 78-061,063. ST. LOUIS SPORTS BAR & GRILL, INC., BALLWIN, MO. FILED 4-30-2001.

ST. LOUIS SPORTS ZONE

NO CLAIM IS MADE TO THE EXCLUSIVE RIGHT TO USE "ST. LOUIS SPORTS", APART FROM THE MARK AS SHOWN.

FOR RESTAURANT AND BAR SERVICES (U.S. CLS. 100 AND 101).

SN 78-063,073. CANNONBALL ENTERPRISES, INC., WYOMING, NY. FILED 5-11-2001.

**THE CANNONBALL RUN
PUB**

NO CLAIM IS MADE TO THE EXCLUSIVE RIGHT TO USE "PUB", APART FROM THE MARK AS SHOWN.

FOR RESTAURANT AND BAR SERVICES (U.S. CLS. 100 AND 101).

FIRST USE 4-1-1990; IN COMMERCE 4-1-1990.

SN 78-063,193. INTEX MANAGEMENT COMPANY, LTD., PLANO, TX. FILED 5-11-2001.

**INTEXNET.NET
WEBHOSTING FOR THE
WORLD**

FOR HOSTING THE WEB SITES OF OTHERS, WEB SITE DESIGN, AND CONSULTING IN THE FIELD OF INTERNET SERVICES (U.S. CLS. 100 AND 101).

FIRST USE 9-1-2000; IN COMMERCE 9-1-2000.

SN 78-063,822. MERIDIANLINK INC., FOUNTAIN VALLEY, CA. FILED 5-16-2001.

MERIDIANLINK

FOR APPLICATION SERVICES PROVIDER (ASP), NAMELY, HOSTING COMPUTER SOFTWARE APPLICATIONS FOR OTHERS (U.S. CLS. 100 AND 101).

FIRST USE 5-1-1998; IN COMMERCE 6-1-2001.

CLASS 42—(Continued).

SN 78-065,395. NOSKOWARE, LLC, GERMANTOWN, MD. FILED 5-23-2001.

CLINIGY

FOR PROVIDING TEMPORARY USE OF ON-LINE NON-DOWNLOADABLE DATABASE MANAGEMENT SOFTWARE FOR OPERATING AND MANAGING MEDICAL AND DENTAL OFFICES AND CLINICS (U.S. CLS. 100 AND 101).

SN 78-067,858. TRAVTECH.COM, FAIRFAX, VA. FILED 6-7-2001.

TRAVTECH.COM

FOR COMPUTER SOFTWARE DESIGN FOR OTHERS (U.S. CLS. 100 AND 101).

SN 78-071,459. PSYCHOGENICS, INC., HAWTHORNE, NY. FILED 6-28-2001.

PSYCHOGENICS

FOR SCIENTIFIC AND MEDICAL RESEARCH; MEDICAL TESTING; TECHNICAL CONSULTATION IN THE FIELDS OF BIOTECHNOLOGY AND PHARMACOLOGY (U.S. CLS. 100 AND 101).

FIRST USE 5-28-1998; IN COMMERCE 5-28-1998.

SN 78-074,005. CAROLINA MULCH PLUS, INC., PISGAH FOREST, NC. FILED 7-16-2001.

CAROLINA MULCH PLUS

NO CLAIM IS MADE TO THE EXCLUSIVE RIGHT TO USE "CAROLINA MULCH", APART FROM THE MARK AS SHOWN.

FOR LANDSCAPING SERVICES (U.S. CLS. 100 AND 101).

FIRST USE 2-0-2000; IN COMMERCE 2-0-2000.

SN 78-074,264. YOU-EYE INC., BROOKLYN, NY. FILED 7-17-2001.

**TAKING THE NOISE OUT OF
INFORMATION**

FOR INFORMATION TECHNOLOGY CONSULTATION; COMPUTER SOFTWARE CONSULTATION FOR OTHERS; TECHNICAL SUPPORT SERVICES, NAMELY, TROUBLESHOOTING OF COMPUTER SOFTWARE PROBLEMS; COMPUTER SERVICES, NAMELY, DESIGN AND INSTALLATION OF WEBSITES AND SOFTWARE FOR OTHERS (U.S. CLS. 100 AND 101).

JANUARY 29, 2002

U.S. PATENT AND TRADEMARK OFFICE

TM 445

CLASS 42—(Continued).

SN 78-075,534. SALAMA, AHMED A, BRANSON, MO. FILED
7-25-2001.

**I'M A STRANGER IN MY
OWN LAND**

FOR CUSTOM IMPRINTING OF CLOTHING WITH
DECORATIVE DESIGNS (U.S. CLS. 100 AND 101).

CLASS 42—(Continued).

SN 78-083,962. SODEXHO OPERATIONS, LLC, GAITHERS-
BURG, MD. FILED 9-14-2001.

BAGUETTE EXPRESSIONS

NO CLAIM IS MADE TO THE EXCLUSIVE RIGHT TO
USE "BAGUETTE", APART FROM THE MARK AS SHOWN.
FOR CONTRACT FOOD SERVICES; PREPARING AND
SERVING FOODS IN INSTITUTIONAL DINING FACIL-
ITIES (U.S. CLS. 100 AND 101).

* * * * *

SECTION 4.—PRIOR UNITED STATES CLASSIFICATION

APPLICATION IN ONE CLASS

COLLECTIVE MEMBERSHIP MARKS

CLASS 200—COLLECTIVE MEMBERSHIP
SN 76-124,118. INTERNATIONAL BASEBALL FEDERATION, 1000 LAUSANNE 5, SWITZERLAND, FILED 9-7-2000.



OWNER OF U.S. REG. NO. 1,759,024.
THE LINING SHOWN IN THE DRAWING IS A FEATURE OF THE MARK AND IS NOT INTENDED TO INDICATE COLOR.

FOR INDICATING MEMBERSHIP IN AN ORGANIZATION CONCERNED WITH THE PROMOTION, DEVELOPMENT AND CONTROL OF BASEBALL WORLDWIDE.

FIRST USE 11-2-1999; IN COMMERCE 11-2-1999.

CERTIFICATION MARKS

CLASS A—GOODS

SN 76-084,461. UNITED BROTHERHOOD OF CARPENTERS AND JOINERS OF AMERICA, WASHINGTON, DC. FILED 7-7-2000.



NO CLAIM IS MADE TO THE EXCLUSIVE RIGHT TO USE "CARPENTERS AND JOINERS OF AMERICA", "UNION MADE", "ORGANIZED 1881", "REGISTERED 1900", "ISSUED BY", AND "AUTHORITY OF", APART FROM THE MARK AS SHOWN.

THE ENGLISH TRANSLATION OF "LABOR OMNIA VINCIT" IS "LABOR CONQUERS ALL".

THE CERTIFICATION MARK, AS USED (OR, IF FILING UNDER 15 U.S.C. 1051(B), INTENDED TO BE USED) BY AUTHORIZED PERSONS, CERTIFIES (OR, IF FINING UNDER 15 U.S.C. 1051(B), IS INTENDED TO CERTIFY); THAT WORK OR LABOR ON THE GOODS WAS PERFORMED BY MEMBERS OF THE APPLICANT, AND/OR EMPLOYEES REPRESENTED BY THE APPLICANT.

FOR BANK, BAR, STORE AND OFFICE FURNITURE; POOL, BILLIARD AND SNOOKER TABLES AND BOWLING ALLEYS; SASH, DOORS, FRAMES, LUMBER MOULDINGS, SHINGLES AND OTHER BUILDING TRIM; BOTTLE CASES AND CONTAINERS, INCLUDING PARTS THEREOF; HOUSEHOLD FURNITURE, KITCHEN CABINETS AND MUSICAL INSTRUMENTS; AND OTHER WOOD PRODUCTS OR PRODUCTS FABRICATED FROM MAN-MADE MATERIALS WHICH HAVE REPLACED WOOD.

FIRST USE 2-0-1900; IN COMMERCE 2-0-1900.

SN 76-166,443. SNELL MEMORIAL FOUNDATION, INC., NORTH HIGHLANDS, CA. FILED 11-16-2000.

K98

THE CERTIFICATION MARK, AS USED BY PERSONS AUTHORIZED BY THE APPLICANT/CERTIFIER, CERTIFIES THE EXTENT OF ANATOMICAL PROTECTION AFFORDED BY THE HEADGEAR DESIGN, RESISTANCE TO PENETRATION, SHOCK ABSORPTION CHARACTERISTICS AND THE ADEQUACY OF CHIN STRAP HARNESES.

FOR PROTECTIVE HEADGEAR.
FIRST USE 11-1-1998; IN COMMERCE 11-1-1998.

SN 76-166,445. SNELL MEMORIAL FOUNDATION, INC., NORTH HIGHLANDS, CA. FILED 11-16-2000.

RS98

THE CERTIFICATION MARK, AS USED BY PERSONS AUTHORIZED BY THE APPLICANT/CERTIFIER, CERTIFIES THE EXTENT OF ANATOMICAL PROTECTION AFFORDED BY THE HEADGEAR DESIGN, RESISTANCE TO PENETRATION, SHOCK ABSORPTION CHARACTERISTICS AND THE ADEQUACY OF CHIN STRAP HARNESES.

FOR PROTECTIVE HEADGEAR.
FIRST USE 10-1-1998; IN COMMERCE 10-1-1998.

SN 76-166,446. SNELL MEMORIAL FOUNDATION, INC., NORTH HIGHLANDS, CA. FILED 11-16-2000.

SN 76-260,737. TEA ASSOCIATION OF THE U.S.A., INC., NEW YORK, NY. FILED 5-22-2001.

SA2000

THE CERTIFICATION MARK, AS USED BY PERSONS AUTHORIZED BY THE APPLICANT/CERTIFIER, CERTIFIES THE EXTENT OF ANATOMICAL PROTECTION AFFORDED BY THE HEADGEAR DESIGN, RESISTANCE TO PENETRATION, SHOCK ABSORPTION CHARACTERISTICS AND THE ADEQUACY OF CHIN STRAP HARNESSSES.

FOR PROTECTIVE HEADGEAR.
FIRST USE 6-23-2000; IN COMMERCE 6-23-2000.



NO CLAIM IS MADE TO THE EXCLUSIVE RIGHT TO USE "TEA", APART FROM THE MARK AS SHOWN.

THE LINING IS A FEATURE OF THE MARK AND DOES NOT INDICATE COLOR.

THE CERTIFICATION MARK, AS INTENDED TO BE USED BY AUTHORIZED PERSONS, IS INTENDED TO CERTIFY THAT THE GOODS ARE PRODUCED BY ENTITIES IN COMPLIANCE WITH EDUCATIONAL, BUSINESS, TRAINING, LABELING, PACKAGING, MANUFACTURING, DECAFFEINATION, CHEMICAL TREATMENT, AND QUALITY CONTROL GUIDELINES PROMULGATED BY THE CERTIFIER.

FOR TEA.

SN 76-260,691. TEA ASSOCIATION OF THE U.S.A., INC., NEW YORK, NY. FILED 5-22-2001.



CLASS B—SERVICES

SN 75-652,301. ALLEN LUND COMPANY, INC., LA CANADA, CA. FILED 3-2-1999.

NO CLAIM IS MADE TO THE EXCLUSIVE RIGHT TO USE "TEA ASSOCIATION", APART FROM THE MARK AS SHOWN.

THE CERTIFICATION MARK, AS INTENDED TO BE USED BY AUTHORIZED PERSONS, IS INTENDED TO CERTIFY THAT THE GOODS ARE PRODUCED BY ENTITIES IN COMPLIANCE WITH EDUCATIONAL, BUSINESS, TRAINING, LABELING, PACKAGING, MANUFACTURING, DECAFFEINATION, CHEMICAL TREATMENT, AND QUALITY CONTROL GUIDELINES PROMULGATED BY THE CERTIFIER.

FOR TEA.

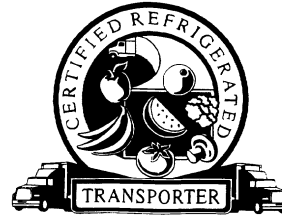

NO CLAIM IS MADE TO THE EXCLUSIVE RIGHT TO USE "CERTIFIED REFRIGERATED TRANSPORTER", APART FROM THE MARK AS SHOWN.

THE CERTIFICATION MARK, USED BY AUTHORIZED PERSONS, CERTIFIES THAT A COURSE OF INSTRUCTION WAS COMPLETED AND THAT THE USER USES SPECIFIED EQUIPMENT AND COMPLIES WITH CERTAIN REFRIGERATED GOODS TRANSPORTATION PRACTICES.

FOR CERTIFYING PERISHABLE GOODS REFRIGERATED TRANSPORTER SERVICES.

FIRST USE 5-29-1998; IN COMMERCE 5-29-1998.

SN 76-260,692. TEA ASSOCIATION OF THE U.S.A., INC., NEW YORK, NY. FILED 5-22-2001.

SPECIALTY TEA REGISTRY **STAR**

NO CLAIM IS MADE TO THE EXCLUSIVE RIGHT TO USE "SPECIALTY TEA", APART FROM THE MARK AS SHOWN.

THE CERTIFICATION MARK, AS INTENDED TO BE USED BY AUTHORIZED PERSONS, IS INTENDED TO CERTIFY THAT THE GOODS ARE PRODUCED BY ENTITIES IN COMPLIANCE WITH EDUCATIONAL, BUSINESS, TRAINING, LABELING, PACKAGING, MANUFACTURING, DECAFFEINATION, CHEMICAL TREATMENT, AND QUALITY CONTROL GUIDELINES PROMULGATED BY THE CERTIFIER.

FOR TEA.

SN 75-887,535. INTERNATIONAL ASSOCIATION OF ADMINISTRATIVE PROFESSIONALS, KANSAS CITY, MO. FILED 1-5-2000.

CAP

THE CERTIFICATION MARK, AS INTENDED TO BE USED BY AUTHORIZED PERSONS, IS INTENDED TO CERTIFY THAT SUCH PERSONS MEET THE CERTIFIER'S STANDARDS AS TO QUALITY AND PROFICIENCY IN PROVIDING ADMINISTRATIVE SUPPORT, SECRETARIAL AND CLERICAL SERVICES AS REFLECTED BY THE SUCCESSFUL COMPLETION OF A WRITTEN EXAMINATION AND MEETING MINIMUM REQUIREMENTS OF EXPERIENCE IN PROVIDING THE ADMINISTRATIVE SUPPORT, SECRETARIAL AND CLERICAL SERVICES.
 FOR ADMINISTRATIVE SUPPORT, SECRETARIAL AND CLERICAL SERVICES.

SN 75-892,628. ASSOCIATION OF ENERGY ENGINEERS, ATLANTA, GA. FILED 1-7-2000.



THE CERTIFICATION MARK, AS USED BY PERSONS AUTHORIZED BY APPLICANT, CERTIFIES THAT THE SERVICES ARE PERFORMED IN ACCORDANCE WITH THE STANDARDS SET BY APPLICANT.
 FOR POWER QUALITY SERVICES.
 FIRST USE 3-0-1997; IN COMMERCE 3-0-1997.

SN 75-920,846. RESEARCH CHEFS ASSOCIATION, SPRINGFIELD, MO. FILED 2-16-2000.



NO CLAIM IS MADE TO THE EXCLUSIVE RIGHT TO USE "CERTIFIED RESEARCH CHEF", APART FROM THE MARK AS SHOWN.
 THE CERTIFICATION MARK, AS USED BY PERSONS AUTHORIZED BY THE CERTIFIER, CERTIFIES THAT THE SERVICES WERE PERFORMED BY MEMBERS OF THE CERTIFIER ORGANIZATION AND THAT THE INDIVIDUAL PERFORMING THE SERVICES IS QUALIFIED FOR USE OF THE MARK BY EVIDENCING SATISFACTORY EDUCATION, EXPERIENCE AND SKILL AS A CHEF

INVOLVED IN ACADEMIA, IN THE DEVELOPMENT OF CULINARY ARTS, OF NEW FOOD PRODUCTS, AND OF MENU ITEMS FOR RESTAURANTS, CORPORATIONS AND OTHER ORGANIZATIONS RESPONSIBLE FOR THE MARKETING, PREPARATION AND SERVING OF CUISINE AND OF PREPARED AND PROCESSED FOODS, ACCORDING TO THE STANDARDS SET FORTH BY THE CERTIFIER ORGANIZATION AND BY SUBSCRIBING TO, AND OBSERVING THE CODE OF CONDUCT PROMULGATED BY THE CERTIFIER ORGANIZATION
 FOR CULINARY SERVICES, NAMELY, FOOD PREPARATION, DEVELOPING CULINARY ARTS, NEW FOOD PRODUCTS AND MENU ITEMS FOR RESTAURANTS, CORPORATIONS, AND OTHER ORGANIZATIONS RESPONSIBLE FOR THE MARKETING AND SERVING OF CUISINE AND OF PREPARED AND PROCESSED FOODS AND PROVIDING CULINARY, TECHNICAL AND NUTRITIONAL INFORMATION.

SN 76-049,777. REXAIR, INC., TROY, MI. FILED 5-12-2000.

STAR SUMMIT

THE CERTIFICATION MARK, AS USED BY THE CERTIFIER, CERTIFIES THAT DISTRIBUTORS IN THE SALE OF VACUUM CLEANERS MANUFACTURED BY REXAIR, INC. HAVE MADE A SPECIFIED NUMBER OF SALES IN A GIVEN PERIOD OF TIME AS THE TOP SALESPERSONS.
 FOR CERTIFYING THAT DISTRIBUTORS IN THE SALE OF VACUUM CLEANERS MANUFACTURED BY REXAIR, INC. HAVE MADE A SPECIFIED NUMBER OF SALES IN A GIVEN PERIOD OF TIME AS THE TOP SALESPERSONS .
 FIRST USE 11-1-1997; IN COMMERCE 11-1-1997.

SN 76-288,171. AMERICAN AUTOMOBILE ASSOCIATION, INC., HEATHROW, FL. FILED 7-20-2001.



OWNER OF U.S. REG. NO. 2,325,355.
 NO CLAIM IS MADE TO THE EXCLUSIVE RIGHT TO USE "AWARD", APART FROM THE MARK AS SHOWN.
 THE MARK WILL CERTIFY THAT THE SERVICES MEET STANDARDS OF CLEANLINESS, STAFF PROFESSIONALISM, PROMPTNESS, COURTESY, FOOD QUALITY, AND RESERVATION CAPABILITIES. THE MARK IS ALSO USED IN CONNECTION WITH THE SALE AND ADVERTISING OF SUCH SERVICES AND BY DISPLAYING THE CERTIFICATION MARK ON OR IN ASSOCIATION WITH THE PLACE OF BUSINESS WHERE SUCH SERVICES ARE RENDERED.
 FOR SERVICES PROVIDED BY HOTELS, MOTELS, RESORTS, AND RESTAURANTS.
 FIRST USE 5-0-1997; IN COMMERCE 5-0-1997.

TRADEMARK REGISTRATIONS ISSUED

PRINCIPAL REGISTER

SECTION 1.— INTERNATIONAL CLASSIFICATION

The short titles associated below with the international class numbers are terms designed merely for quick identification and are not an official part of the international classification. The full names of international classes are given in section 6.1 of the trademark rules of practice.

The designation "U.S. Cl." appearing in this section refers to the U.S. class in effect prior to Sep. 1, 1973 rather than the international class which applies to applications filed on or after that date. For adoption of international classification see notice in the OFFICIAL GAZETTE of Jun. 26, 1973 (911 O.G. TM 210).

CLASS 1—CHEMICALS

- 2,533,218. **INUCOR**. RAFFINERIE TIRLEMONTAISE S.A., EN NEERLANDAIS TIENSE SUIKERRAFFINADERIJ N.V., (U.S. CLS. 1, 5, 6, 10, 26 AND 46). SN 75-487,081. PUB. 11-6-2001. FILED 5-18-1998.
- 2,533,228. **PREMIX AND DESIGN**. R.D.C. SRL, (U.S. CLS. 1, 5, 6, 10, 26 AND 46). SN 75-543,026. PUB. 6-6-2000. FILED 8-26-1998.
- 2,533,235. **LIBIOL**. LIBIOL, BY CHANGE OF NAME LABORATOIRE INDUSTRIEL DE BIOLOGIE, (U.S. CLS. 1, 5, 6, 10, 26 AND 46). SN 75-556,212. PUB. 11-6-2001. FILED 9-21-1998.
- 2,533,255. **PHC**. PLANT HEALTH CARE, INC., (U.S. CLS. 1, 5, 6, 10, 26 AND 46). SN 75-609,754. PUB. 11-6-2001. FILED 12-21-1998.
- 2,533,256. **COMPETE**. PLANT HEALTH CARE, INC., (U.S. CLS. 1, 5, 6, 10, 26 AND 46). SN 75-609,756. PUB. 11-6-2001. FILED 12-21-1998.
- 2,533,258. **PROMOCHEM AND DESIGN**. PROMOCHEM GMBH, MULTIPLE CLASS, (INT. CLS. 1 AND 9), (U.S. CLS. 1, 5, 6, 10, 21, 23, 26, 36, 38 AND 46). SN 75-616,015. PUB. 11-6-2001. FILED 10-19-1999.
- 2,533,283. **APT**. GIESECKE & DEVRIENT GMBH, MULTIPLE CLASS, (INT. CLS. 1, 9 AND 16), (U.S. CLS. 1, 2, 5, 6, 10, 21, 22, 23, 26, 29, 36, 37, 38, 46 AND 50). SN 75-671,425. PUB. 11-6-2001. FILED 3-29-1999.
- 2,533,286. **ODOR OUT**. RENEW SYSTEMS, INC., (U.S. CLS. 1, 5, 6, 10, 26 AND 46). SN 75-679,683. PUB. 11-6-2001. FILED 4-9-1999.
- 2,533,291. **SENSISSCRIPT**. QIAGEN GMBH, MULTIPLE CLASS, (INT. CLS. 1 AND 5), (U.S. CLS. 1, 5, 6, 10, 18, 26, 44, 46, 51 AND 52). SN 75-698,067. PUB. 11-6-2001. FILED 5-5-1999.
- 2,533,297. **SAPPI**. SAPPI LIMITED, (U.S. CLS. 1, 5, 6, 10, 26 AND 46). SN 75-708,778. PUB. 11-6-2001. FILED 5-18-1999.
- 2,533,320. **JUVANTIA PHARMA AND DESIGN**. OY JUVANTIA PHARMA LTD., MULTIPLE CLASS, (INT. CLS. 1, 5 AND 42), (U.S. CLS. 1, 5, 6, 10, 18, 26, 44, 46, 51, 52, 100 AND 101). SN 75-740,610. PUB. 11-6-2001. FILED 6-30-1999.
- 2,533,483. **HOUSEHOLD FARM AND DESIGN**. HUMCO HOLDING GROUP, INC., MULTIPLE CLASS, (INT. CLS. 1, 3 AND 5), (U.S. CLS. 1, 4, 5, 6, 10, 18, 26, 44, 46, 50, 51 AND 52). SN 75-906,134. PUB. 11-6-2001. FILED 1-31-2000.
- 2,533,551. **FOAMSTAR**. COGNIS DEUTSCHLAND GMBH, (U.S. CLS. 1, 5, 6, 10, 26 AND 46). SN 75-938,621. PUB. 11-6-2001. FILED 3-8-2000.
- 2,533,586. **IMMUNEASY**. QIAGEN GMBH, MULTIPLE CLASS, (INT. CLS. 1 AND 5), (U.S. CLS. 1, 5, 6, 10, 18, 26, 44, 46, 51 AND 52). SN 76-011,156. PUB. 11-6-2001. FILED 3-28-2000.
- 2,533,613. **FLAVORSHURE**. BALCHEM CORPORATION, (U.S. CLS. 1, 5, 6, 10, 26 AND 46). SN 76-023,353. PUB. 11-6-2001. FILED 4-11-2000.
- 2,533,636. **INNOVATIVE POLYMERS (STYLIZED)**. INNOVATIVE POLYMERS, INC., (U.S. CLS. 1, 5, 6, 10, 26 AND 46). SN 76-031,646. PUB. 11-6-2001. FILED 4-20-2000.
- 2,533,638. **NO-CHLOR**. AQUA CLEAR INDUSTRIES, LLC, (U.S. CLS. 1, 5, 6, 10, 26 AND 46). SN 76-032,138. PUB. 11-6-2001. FILED 4-21-2000.
- 2,533,691. **ESTANE AND DESIGN**. B.F.GOODRICH COMPANY, THE, (U.S. CLS. 1, 5, 6, 10, 26 AND 46). SN 76-047,707. PUB. 11-6-2001. FILED 5-15-2000.
- 2,533,726. **JUST IN TIME. ALL THE TIME..** INTERNATIONAL RAW MATERIALS LTD., MULTIPLE CLASS, (INT. CLS. 1 AND 35), (U.S. CLS. 1, 5, 6, 10, 26, 46, 100, 101 AND 102). SN 76-060,244. PUB. 11-6-2001. FILED 5-31-2000.
- 2,533,728. **MAXGUARD**. OMS INVESTMENTS, INC., (U.S. CLS. 1, 5, 6, 10, 26 AND 46). SN 76-061,412. PUB. 11-6-2001. FILED 6-1-2000.
- 2,533,735. **MISCELLANEOUS DESIGN**. FRESH START MARKETING, INC., (U.S. CLS. 1, 5, 6, 10, 26 AND 46). SN 76-062,075. PUB. 11-6-2001. FILED 6-2-2000.
- 2,533,745. **AQUACOIR**. OMS INVESTMENTS, INC., (U.S. CLS. 1, 5, 6, 10, 26 AND 46). SN 76-067,562. PUB. 11-6-2001. FILED 6-9-2000.
- 2,533,751. **MISCELLANEOUS DESIGN**. BERRYMAN PRODUCTS, INC., MULTIPLE CLASS, (INT. CLS. 1, 16 AND 25), (U.S. CLS. 1, 2, 5, 6, 10, 22, 23, 26, 29, 37, 38, 39, 46 AND 50). SN 76-069,917. PUB. 11-6-2001. FILED 6-14-2000.
- 2,533,760. **NA-CHURS ALPINE AND DESIGN**. NA-CHURS PLANT FOOD COMPANY, (U.S. CLS. 1, 5, 6, 10, 26 AND 46). SN 76-072,499. PUB. 11-6-2001. FILED 6-16-2000.
- 2,533,775. **GUARD & PROTECT AND DESIGN**. AMREP, INC., (U.S. CLS. 1, 5, 6, 10, 26 AND 46). SN 76-078,047. PUB. 11-6-2001. FILED 6-26-2000.
- 2,533,815. **NEEDLELOK**. CERADYNE, INC., (U.S. CLS. 1, 5, 6, 10, 26 AND 46). SN 76-094,336. PUB. 11-6-2001. FILED 7-24-2000.
- 2,533,816. **PINENE S (STYLIZED)**. SURFMARK L.L.C., (U.S. CLS. 1, 5, 6, 10, 26 AND 46). SN 76-095,628. PUB. 10-9-2001. FILED 7-25-2000.
- 2,533,819. **UNITRAY**. PEL-FREEZ CLINICAL SYSTEMS, LLC, (U.S. CLS. 1, 5, 6, 10, 26 AND 46). SN 76-097,355. PUB. 11-6-2001. FILED 7-26-2000.
- 2,533,866. **CRAB STOPPER**. ANDERSONS AGRISERVICES, INC., THE, (U.S. CLS. 1, 5, 6, 10, 26 AND 46). SN 76-128,643. PUB. 11-6-2001. FILED 9-14-2000.
- 2,533,884. **MIRACLE SWEEP**. ORISON MARKETNG, L.L.C., (U.S. CLS. 1, 5, 6, 10, 26 AND 46). SN 76-134,789. PUB. 11-6-2001. FILED 9-26-2000.
- 2,534,004. **EVERCOAT**. ILLINOIS TOOL WORKS INC., (U.S. CLS. 1, 5, 6, 10, 26 AND 46). SN 76-181,200. PUB. 11-6-2001. FILED 12-15-2000.
- 2,534,050. **LEKUTHERM**. RHEIN CHEMIE RHEINAU GMBH, (U.S. CLS. 1, 5, 6, 10, 26 AND 46). SN 76-193,754. PUB. 11-6-2001. FILED 1-12-2001.
- 2,534,057. **GREEN C MATERIAL**. LC GREEN, INC., (U.S. CLS. 1, 5, 6, 10, 26 AND 46). SN 76-197,001. PUB. 11-6-2001. FILED 1-22-2001.
- 2,534,079. **PLASTIFOAM THE FUN STARTS HERE!** SYNDICATE SALES, INC., (U.S. CLS. 1, 5, 6, 10, 26 AND 46). SN 76-199,907. PUB. 11-6-2001. FILED 1-25-2001.
- 2,534,101. **C. MOORE GREEN AND DESIGN**. ENVIRONMENTAL TEST SYSTEMS, INC., (U.S. CLS. 1, 5, 6, 10, 26 AND 46). SN 76-205,016. PUB. 11-6-2001. FILED 2-2-2001.
- 2,534,125. **NITRO**. CORN PRODUCTS INTERNATIONAL, INC., (U.S. CLS. 1, 5, 6, 10, 26 AND 46). SN 76-211,366. PUB. 11-6-2001. FILED 2-15-2001.
- 2,534,283. **ADEPT**. SOUTHERN STATES COOPERATIVE

INCORPORATED, (U.S. CLS. 1, 5, 6, 10, 26 AND 46). SN 76-293,007. PUB. 11-6-2001. FILED 8-2-2001.
2,534,284. **RELIABLE**. SOUTHERN STATES COOPERATIVE INCORPORATED, (U.S. CLS. 1, 5, 6, 10, 26 AND 46). SN 76-293,008. PUB. 11-6-2001. FILED 8-2-2001.

CLASS 2—PAINTS

2,533,259. **SIERRA**. SIERRA CORPORATION, (U.S. CLS. 6, 11 AND 16). SN 75-618,447. PUB. 11-6-2001. FILED 1-11-1999.
2,533,300. **WEATHER BARRIER**. WEATHER BARRIER, INC., (U.S. CLS. 6, 11 AND 16). SN 75-709,341. PUB. 11-6-2001. FILED 5-19-1999.
2,533,325. **TONEJET**. TONEJET CORPORATION PTY LTD, (U.S. CLS. 6, 11 AND 16). SN 75-751,907. PUB. 11-6-2001. FILED 7-13-1999.
2,533,583. **RAINPEL**. WRIGHT CHEMICAL CORPORATION, (U.S. CLS. 6, 11 AND 16). SN 76-007,250. PUB. 11-6-2001. FILED 3-22-2000.
2,533,602. **PERRY AUSTEN**. BRUNSWICK BOWLING & BILLIARDS CORPORATION, MULTIPLE CLASS, (INT. CLS. 2, 3, 9, 21 AND 28), (U.S. CLS. 1, 2, 4, 6, 11, 13, 16, 21, 22, 23, 26, 29, 30, 33, 36, 38, 40, 50, 51 AND 52). SN 76-019,454. PUB. 11-6-2001. FILED 4-6-2000.
2,533,624. **LFI TITANIUMPLUS**. LUMBER FINISHERS INCORPORATED, (U.S. CLS. 6, 11 AND 16). SN 76-027,757. PUB. 11-6-2001. FILED 4-17-2000.
2,533,657. **VISOR**. BECKER-UNDERWOOD, INC., (U.S. CLS. 6, 11 AND 16). SN 76-038,278. PUB. 11-6-2001. FILED 4-28-2000.
2,533,705. **DUST FREE**. CAL-WEST SPECIALTY COATINGS, INC., (U.S. CLS. 6, 11 AND 16). SN 76-053,251. PUB. 11-6-2001. FILED 5-22-2000.
2,533,862. **RAABE AND DESIGN**. RAABE CORPORATION, (U.S. CLS. 6, 11 AND 16). SN 76-125,642. PUB. 11-6-2001. FILED 9-11-2000.
2,533,936. **QUICK CRAFT**. NAUTEX, INC., (U.S. CLS. 6, 11 AND 16). SN 76-156,687. PUB. 11-6-2001. FILED 10-31-2000.
2,533,941. **SCRUBTOUGH**. MASTER COATING TECHNOLOGIES, INC., (U.S. CLS. 6, 11 AND 16). SN 76-157,701. PUB. 11-6-2001. FILED 10-31-2000.
2,534,038. **DECKTECHS**. DECK TECHS, INC., MULTIPLE CLASS, (INT. CLS. 2, 3 AND 37), (U.S. CLS. 1, 4, 6, 11, 16, 50, 51, 52, 100, 103 AND 106). SN 76-190,315. PUB. 11-6-2001. FILED 1-4-2001.
2,534,054. **TONER ZONE**. TONERZONE.COM INC., (U.S. CLS. 6, 11 AND 16). SN 76-195,872. PUB. 11-6-2001. FILED 1-19-2001.
2,534,109. **RAABE AND DESIGN**. RAABE CORPORATION, (U.S. CLS. 6, 11 AND 16). SN 76-207,420. PUB. 11-6-2001. FILED 9-11-2000.
2,534,341. **EVERWEAR**. IOWA PAINT MANUFACTURING COMPANY, INC., (U.S. CLS. 6, 11 AND 16). SN 78-069,886. PUB. 11-6-2001. FILED 6-19-2001.

CLASS 3—COSMETICS AND CLEANING PREPARATIONS

2,533,219. **CESARE PACIOTTI**. CESPA - S.R.L., (U.S. CLS. 1, 4, 6, 50, 51 AND 52). SN 75-493,079. PUB. 4-27-1999. FILED 5-29-1998.
2,533,314. **SEROYAL AND DESIGN**. SEROYAL U.S.A., INC., MULTIPLE CLASS, (INT. CLS. 3 AND 5), (U.S. CLS. 1, 4, 6, 18, 44, 46, 50, 51 AND 52). SN 75-733,561. PUB. 11-6-2001. FILED 6-21-1999.
2,533,350. **AROMA DO CAMPO AND DESIGN**. IMS COMERCIAL E INDUSTRIAL LTDA., (U.S. CLS. 1, 4, 6, 50, 51 AND 52). SN 75-791,119. PUB. 10-10-2000. FILED 9-2-1999.
2,533,397. **MA MISS ASHIDA (STYLIZED)**. JUN ASHIDA CO., LTD., MULTIPLE CLASS, (INT. CLS. 3, 14, 18, 24 AND 25), (U.S. CLS. 1, 2, 3, 4, 6, 22, 27, 28, 39, 41, 42, 50, 51 AND 52). SN 75-857,517. PUB. 10-9-2001. FILED 11-24-1999.
2,533,475. **FOR TOTALLY FRIED HAIR**. LUXO LABORA-

TORIES LIMITED, (U.S. CLS. 1, 4, 6, 50, 51 AND 52). SN 75-902,967. PUB. 11-6-2001. FILED 4-16-1998.
2,533,483 (*See Class 1 for this trademark*).
2,533,602 (*See Class 2 for this trademark*).
2,533,608. **NU-GRIP**. WALSH, EVAN S., (U.S. CLS. 1, 4, 6, 50, 51 AND 52). SN 76-021,737. PUB. 11-6-2001. FILED 4-10-2000.
2,533,620. **CITRA-CLEAR**. CITRA-SOLV LLC, BY ASSIGNMENT SHADOW LAKE, INC., (U.S. CLS. 1, 4, 6, 50, 51 AND 52). SN 76-027,112. PUB. 11-6-2001. FILED 4-17-2000.
2,533,801. **CLEANTHROUGH**. KAO KABUSHIKI KAISHA, TA KAO CORPORATION, (U.S. CLS. 1, 4, 6, 50, 51 AND 52). SN 76-089,633. PUB. 11-6-2001. FILED 7-14-2000.
2,533,879. **PLASTIC SURGEON IN A BOTTLE**. SG LICENSING CORPORATION, THE, (U.S. CLS. 1, 4, 6, 50, 51 AND 52). SN 76-132,020. PUB. 11-6-2001. FILED 9-19-2000.
2,534,008. **AFTER-STRIP**. DYNACRAFT INDUSTRIES INC., (U.S. CLS. 1, 4, 6, 50, 51 AND 52). SN 76-182,310. PUB. 11-6-2001. FILED 12-18-2000.
2,534,038 (*See Class 2 for this trademark*).
2,534,123. **NUTRIUM**. CHESEBROUGH-POND'S INC., (U.S. CLS. 1, 4, 6, 50, 51 AND 52). SN 76-209,374. PUB. 11-6-2001. FILED 2-13-2001.
2,534,129. **BRIGHT SKY**. CHESEBROUGH-POND'S INC., (U.S. CLS. 1, 4, 6, 50, 51 AND 52). SN 76-212,548. PUB. 11-6-2001. FILED 2-20-2001.
2,534,130. **SPRING BURST**. CHESEBROUGH-POND'S INC., (U.S. CLS. 1, 4, 6, 50, 51 AND 52). SN 76-212,558. PUB. 11-6-2001. FILED 2-20-2001.
2,534,209. **SENSODYNE (STYLIZED)**. DENTCO, INC., (U.S. CLS. 1, 4, 6, 50, 51 AND 52). SN 76-268,951. PUB. 11-6-2001. FILED 6-8-2001.
2,534,236. **DOVE**. CHESEBROUGH-POND'S INC., (U.S. CLS. 1, 4, 6, 50, 51 AND 52). SN 76-280,777. PUB. 11-6-2001. FILED 7-5-2001.
2,534,285. **COLORLAB**. COLORLAB COSMETICS, INC., (U.S. CLS. 1, 4, 6, 50, 51 AND 52). SN 76-293,543. PUB. 11-6-2001. FILED 8-1-2001.
2,534,286. **INTIMATE WHISPER**. C.B. FLEET INVESTMENT CORPORATION, (U.S. CLS. 1, 4, 6, 50, 51 AND 52). SN 76-293,650. PUB. 11-6-2001. FILED 8-1-2001.

CLASS 4—LUBRICANTS AND FUELS

2,533,205. **COYOTE FOUND CANDLES AND DESIGN**. WATANGAA, INC., DBA COYOTE FOUND CANDLES, (U.S. CLS. 1, 6 AND 15). SN 75-420,209. PUB. 11-6-2001. FILED 1-20-1998.
2,533,214. **BARBEQUE TIME**. TOPCO ASSOCIATES, INC., BY ASSIGNMENT ALBERTSON'S, INC., (U.S. CLS. 1, 6 AND 15). SN 75-464,153. PUB. 11-6-2001. FILED 4-7-1998.
2,533,230. **WITH MICROLENE SUPREME OUR HIGHEST OCTANE AND DESIGN**. IRVING OIL CORPORATION, (U.S. CLS. 1, 6 AND 15). SN 75-544,639. PUB. 11-6-2001. FILED 8-28-1998.
2,533,238. **"ONE-MATCH" BRIQUETS**. GW, INC., BY CHANGE OF NAME; BY MERGER GULF LITE & WIZARD, INC., (U.S. CLS. 1, 6 AND 15). SN 75-569,123. PUB. 11-6-2001. FILED 10-13-1998.
2,533,261. **SYNPRO**. FINAMARK, INC., (U.S. CLS. 1, 6 AND 15). SN 75-623,744. PUB. 11-6-2001. FILED 1-20-1999.
2,533,263. **UPG UNITED PROPANE GAS (STYLIZED)**. UNITED PROPANE GAS COMPANIES, INC., MULTIPLE CLASS, (INT. CLS. 4, 35 AND 39), (U.S. CLS. 1, 6, 15, 100, 101, 102 AND 105). SN 75-637,101. PUB. 11-6-2001. FILED 2-10-1999.
2,533,307. **CHRISTY'S COUNTRY CANDLES**. CHRISTY'S COUNTRY CANDLES, INC., MULTIPLE CLASS, (INT. CLS. 4 AND 35), (U.S. CLS. 1, 6, 15, 100, 101 AND 102). SN 75-726,062. PUB. 11-6-2001. FILED 6-10-1999.
2,533,363. **OLD WILLIAMSBURGH CANDLE CORP. AND DESIGN**. OLD WILLIAMSBURGH CANDLE CORP., (U.S. CLS. 1, 6 AND 15). SN 75-816,462. PUB. 11-6-2001. FILED 10-6-1999.
2,533,473. **MISCELLANEOUS DESIGN**. MOBIL OIL CORPORATION, (U.S. CLS. 1, 6 AND 15). SN 75-902,212. PUB. 11-6-2001. FILED 1-27-2000.

- 2,533,573. **CHEMLUBE**. ULTRACHEM, INC., (U.S. CLS. 1, 6 AND 15). SN 76-001,247. PUB. 11-6-2001. FILED 3-15-2000.
- 2,533,642. **PATIO AND DESIGN**. EMPIRE CANDLE MANUFACTURING, LLC, (U.S. CLS. 1, 6 AND 15). SN 76-033,295. PUB. 11-6-2001. FILED 4-24-2000.
- 2,533,744. **FUGO**. TU, JUDY, (U.S. CLS. 1, 6 AND 15). SN 76-066,940. PUB. 11-6-2001. FILED 6-12-2000.
- 2,533,780. **WOCO WALLOVER OIL COMPANY AND DESIGN**. WALLOVER OIL COMPANY INCORPORATED, MULTIPLE CLASS, (INT. CLS. 4 AND 42), (U.S. CLS. 1, 6, 15, 100 AND 101). SN 76-080,818. PUB. 11-6-2001. FILED 6-29-2000.
- 2,534,010. **ST. JOHNSBURY CANDLES & POTPOURRI**. ST. JOHNSBURY CANDLES, INC., MULTIPLE CLASS, (INT. CLS. 4, 21 AND 35), (U.S. CLS. 1, 2, 6, 13, 15, 23, 29, 30, 33, 40, 50, 100, 101 AND 102). SN 76-183,084. PUB. 11-6-2001. FILED 12-19-2000.
- 2,534,029. **THE ONE MATCH CHARCOAL STARTER**. ROYAL OAK SALES, INC., (U.S. CLS. 1, 6 AND 15). SN 76-186,768. PUB. 11-6-2001. FILED 12-27-2000.
- 2,534,047. **ZENIBEE**. ZENITECH LLC, (U.S. CLS. 1, 6 AND 15). SN 76-192,763. PUB. 11-6-2001. FILED 1-8-2001.
- 2,534,327. **HONEYBEE NATURAL**. HONEYBEE NATURAL, LLC, (U.S. CLS. 1, 6 AND 15). SN 78-055,007. PUB. 11-6-2001. FILED 3-26-2001.

CLASS 5—PHARMACEUTICALS

- 2,533,193. **BFIT**. BALLY TOTAL FITNESS HOLDING CORPORATION, (U.S. CLS. 6, 18, 44, 46, 51 AND 52). SN 75-179,827. PUB. 11-6-2001. FILED 10-9-1996.
- 2,533,194. **NATRAGEST**. BROADMOORE LABS, INC., (U.S. CLS. 6, 18, 44, 46, 51 AND 52). SN 75-217,421. PUB. 11-6-2001. FILED 12-23-1996.
- 2,533,209. **PEAK AMINO ACIDS**. GREAT EARTH COMPANIES, INC., (U.S. CLS. 6, 18, 44, 46, 51 AND 52). SN 75-447,226. PUB. 11-6-2001. FILED 3-9-1998.
- 2,533,240. **S AND DESIGN**. SHIRE INTERNATIONAL LICENSING B.V., MULTIPLE CLASS, (INT. CLS. 5 AND 42), (U.S. CLS. 6, 18, 44, 46, 51, 52, 100 AND 101). SN 75-574,605. PUB. 11-6-2001. FILED 10-21-1998.
- 2,533,243. **DYNO VITES**. NATURAL ORGANICS INC., (U.S. CLS. 6, 18, 44, 46, 51 AND 52). SN 75-583,036. PUB. 11-6-2001. FILED 11-4-1998.
- 2,533,247. **FORTITECH THE WORLD LEADER IN NUTRIENT SYSTEMS**. FORTITECH, INC., (U.S. CLS. 6, 18, 44, 46, 51 AND 52). SN 75-592,730. PUB. 11-6-2001. FILED 11-20-1998.
- 2,533,252. **SLA AND DESIGN**. INSTITUT STRAUMANN AG, MULTIPLE CLASS, (INT. CLS. 5 AND 10), (U.S. CLS. 6, 18, 26, 39, 44, 46, 51 AND 52). SN 75-602,065. PUB. 11-6-2001. FILED 12-9-1998.
- 2,533,268. **MINIPRESS**. ESPE DENTAL AG, MULTIPLE CLASS, (INT. CLS. 5 AND 10), (U.S. CLS. 6, 18, 26, 39, 44, 46, 51 AND 52). SN 75-643,701. PUB. 11-6-2001. FILED 2-19-1999.
- 2,533,289. **PREMIER PLATINUM HPSA**. MERIDIAN DIAGNOSTICS, INC., (U.S. CLS. 6, 18, 44, 46, 51 AND 52). SN 75-692,761. PUB. 11-6-2001. FILED 4-28-1999.
- 2,533,291 (*See Class 1 for this trademark*).
- 2,533,296. **MOUNTAIN NATURALS**. FOODSCIENCE CORPORATION, (U.S. CLS. 6, 18, 44, 46, 51 AND 52). SN 75-708,566. PUB. 11-6-2001. FILED 5-18-1999.
- 2,533,302. **L-EMENTAL**. GALAGEN INC., (U.S. CLS. 6, 18, 44, 46, 51 AND 52). SN 75-716,783. PUB. 11-6-2001. FILED 5-28-1999.
- 2,533,311. **ISO-PLEX**. JONES, ALAN L., (U.S. CLS. 6, 18, 44, 46, 51 AND 52). SN 75-730,482. PUB. 11-6-2001. FILED 7-14-1999.
- 2,533,314 (*See Class 3 for this trademark*).
- 2,533,320 (*See Class 1 for this trademark*).
- 2,533,340. **EVERCLR**. HERPES RELIEF, LTD, (U.S. CLS. 6, 18, 44, 46, 51 AND 52). SN 75-777,732. PUB. 11-6-2001. FILED 8-16-1999.
- 2,533,359. **UNIQUE LIFE AND DESIGN**. UNIQUELIFE, INC., (U.S. CLS. 6, 18, 44, 46, 51 AND 52). SN 75-808,923. PUB. 11-6-2001. FILED 10-30-1999.
- 2,533,360. **RECENTIN**. ZENECA LIMITED, (U.S. CLS. 6, 18, 44, 46, 51 AND 52). SN 75-809,663. PUB. 11-6-2001. FILED 9-27-1999.
- 2,533,385. **GOLDLINE NATURALS AND DESIGN**. ZENITH GOLDLINE PHARMACEUTICALS, INC., (U.S. CLS. 6, 18, 44, 46, 51 AND 52). SN 75-846,748. PUB. 11-6-2001. FILED 11-12-1999.
- 2,533,391. **O'MY**. MAULHARDT, ANDREAS, DBA O'MY PRODUCTS, AND UNCYK, MURRAY, DBA O'MY PRODUCTS, (U.S. CLS. 6, 18, 44, 46, 51 AND 52). SN 75-850,850. PUB. 11-6-2001. FILED 11-16-1999.
- 2,533,400. **ECHAQUINE**. BELLEZZA, ANTHONY P, AND BELLEZZA, MARY L, MULTIPLE CLASS, (INT. CLS. 5, 30 AND 31), (U.S. CLS. 1, 6, 18, 44, 46, 51 AND 52). SN 75-860,879. PUB. 11-6-2001. FILED 12-1-1999.
- 2,533,442. **MISCELLANEOUS DESIGN**. THISTLE COMPANY OF CALEDONIA LIMITED, THE, (U.S. CLS. 6, 18, 44, 46, 51 AND 52). SN 75-885,785. PUB. 11-6-2001. FILED 12-23-1999.
- 2,533,456. **MAK**. I.D.M. IMMUNO-DESIGNED MOLECULES, MULTIPLE CLASS, (INT. CLS. 5 AND 10), (U.S. CLS. 6, 18, 26, 39, 44, 46, 51 AND 52). SN 75-893,426. PUB. 11-6-2001. FILED 1-7-2000.
- 2,533,462. **DIAMOND V AND DESIGN**. DIAMOND V MILLS, INC., (U.S. CLS. 6, 18, 44, 46, 51 AND 52). SN 75-895,977. PUB. 11-6-2001. FILED 1-12-2000.
- 2,533,483 (*See Class 1 for this trademark*).
- 2,533,509. **NATURE'S VALUE AND DESIGN**. UNITED DELTA, INC., (U.S. CLS. 6, 18, 44, 46, 51 AND 52). SN 75-921,475. PUB. 11-6-2001. FILED 2-17-2000.
- 2,533,515. **API 20 E**. BIOMERIEUX, INC., (U.S. CLS. 6, 18, 44, 46, 51 AND 52). SN 75-926,888. PUB. 11-6-2001. FILED 2-23-2000.
- 2,533,517. **ULTRA ISOFLAVONE 100**. NATURAL ORGANICS INC., (U.S. CLS. 6, 18, 44, 46, 51 AND 52). SN 75-927,419. PUB. 11-6-2001. FILED 2-25-2000.
- 2,533,518. **ULTRA GLUCOSAMINE 600**. NATURAL ORGANICS INC., (U.S. CLS. 6, 18, 44, 46, 51 AND 52). SN 75-927,420. PUB. 11-6-2001. FILED 2-25-2000.
- 2,533,520. **ULTRA CRANBERRY 1000**. NATURAL ORGANICS INC., (U.S. CLS. 6, 18, 44, 46, 51 AND 52). SN 75-927,423. PUB. 11-6-2001. FILED 2-25-2000.
- 2,533,521. **ULTRA CHONDROITIN 600**. NATURAL ORGANICS INC., (U.S. CLS. 6, 18, 44, 46, 51 AND 52). SN 75-927,424. PUB. 11-6-2001. FILED 2-25-2000.
- 2,533,545. **LIFESPORT**. NEWAYS, INC., (U.S. CLS. 6, 18, 44, 46, 51 AND 52). SN 75-936,093. PUB. 11-6-2001. FILED 3-4-2000.
- 2,533,571. **VONS**. VONS COMPANIES, INC., THE, (U.S. CLS. 6, 18, 44, 46, 51 AND 52). SN 76-000,740. PUB. 11-6-2001. FILED 3-2-2000.
- 2,533,586 (*See Class 1 for this trademark*).
- 2,533,588. **REASHURE**. BALCHEM CORPORATION, (U.S. CLS. 6, 18, 44, 46, 51 AND 52). SN 76-011,302. PUB. 11-6-2001. FILED 3-28-2000.
- 2,533,645. **3 AND DESIGN**. WASATCH PHARMACEUTICAL INC., (U.S. CLS. 6, 18, 44, 46, 51 AND 52). SN 76-035,889. PUB. 11-6-2001. FILED 4-27-2000.
- 2,533,646. **2 AND DESIGN**. WASATCH PHARMACEUTICAL INC., (U.S. CLS. 6, 18, 44, 46, 51 AND 52). SN 76-035,890. PUB. 11-6-2001. FILED 4-27-2000.
- 2,533,648. **4 AND DESIGN**. WASATCH PHARMACEUTICAL INC., (U.S. CLS. 6, 18, 44, 46, 51 AND 52). SN 76-036,497. PUB. 11-6-2001. FILED 4-27-2000.
- 2,533,649. **1 AND DESIGN**. WASATCH PHARMACEUTICAL INC., (U.S. CLS. 6, 18, 44, 46, 51 AND 52). SN 76-036,498. PUB. 11-6-2001. FILED 4-27-2000.
- 2,533,650. **MISCELLANEOUS DESIGN**. WASATCH PHARMACEUTICAL INC., MULTIPLE CLASS, (INT. CLS. 5 AND 42), (U.S. CLS. 6, 18, 44, 46, 51, 52, 100 AND 101). SN 76-036,499. PUB. 11-6-2001. FILED 4-27-2000.
- 2,533,747. **SAFETY REMEDY AND DESIGN**. SAFETY REMEDY, INC., MULTIPLE CLASS, (INT. CLS. 5 AND 41), (U.S. CLS. 6, 18, 44, 46, 51, 52, 100, 101 AND 107). SN 76-068,764. PUB. 11-6-2001. FILED 6-12-2000.
- 2,533,761. **ORAVESCENT**. CIMA LABS, INC., (U.S. CLS. 6, 18, 44, 46, 51 AND 52). SN 76-072,639. PUB. 11-6-2001. FILED 6-19-2000.
- 2,533,762. **GLYSTONE**. C&M PHARMACAL, INC., (U.S. CLS. 6, 18, 44, 46, 51 AND 52). SN 76-072,844. PUB. 11-6-2001. FILED

6-19-2000.
 2,533,764. **ZIZHU**. CHUN, ZHANG, (U.S. CLS. 6, 18, 44, 46, 51 AND 52). SN 76-073,423. PUB. 11-6-2001. FILED 6-19-2000.
 2,533,793. **NEW RUALS**. BERDICHEVSKY, RUAL, MULTIPLE CLASS, (INT. CLS. 5 AND 25), (U.S. CLS. 6, 18, 22, 39, 44, 46, 51 AND 52). SN 76-086,218. PUB. 11-6-2001. FILED 7-10-2000.
 2,533,808. **HERBAL AIDE AND DESIGN**. HERBAL AIDE, INC., (U.S. CLS. 6, 18, 44, 46, 51 AND 52). SN 76-092,594. PUB. 11-6-2001. FILED 7-20-2000.
 2,533,830. **AUDISPRAY**. DIEPHARMEX, (U.S. CLS. 6, 18, 44, 46, 51 AND 52). SN 76-106,495. PUB. 11-6-2001. FILED 8-9-2000.
 2,533,844. **KANGAROO KIDS**. IMPROVITA, INC., (U.S. CLS. 6, 18, 44, 46, 51 AND 52). SN 76-116,315. PUB. 11-6-2001. FILED 8-24-2000.
 2,533,875. **FREEDOM**. J.T. INDUSTRIES, (U.S. CLS. 6, 18, 44, 46, 51 AND 52). SN 76-131,379. PUB. 11-6-2001. FILED 9-15-2000.
 2,533,911. **MAXVITA AND DESIGN**. NORTHERN CALIFORNIA IMAGE LABORATORY INC, (U.S. CLS. 6, 18, 44, 46, 51 AND 52). SN 76-147,450. PUB. 11-6-2001. FILED 10-16-2000.
 2,533,934. **OSTEOBOOST**. ORAFI NORTH AMERICA, INC., (U.S. CLS. 6, 18, 44, 46, 51 AND 52). SN 76-156,404. PUB. 11-6-2001. FILED 10-31-2000.
 2,533,959. **CAL FAST CALVING GEL**. UNIVERSAL COOPERATIVES, INC., (U.S. CLS. 6, 18, 44, 46, 51 AND 52). SN 76-164,248. PUB. 11-6-2001. FILED 11-13-2000.
 2,533,960. **SNORE STOP**. GREEN PHARMACEUTICALS, INC., (U.S. CLS. 6, 18, 44, 46, 51 AND 52). SN 76-164,295. PUB. 11-6-2001. FILED 11-7-2000.
 2,533,967. **MICROSCAN**. DADE MICROSCAN INC., MULTIPLE CLASS, (INT. CLS. 5, 9, 10 AND 16), (U.S. CLS. 2, 5, 6, 18, 21, 22, 23, 26, 29, 36, 37, 38, 39, 44, 46, 50, 51 AND 52). SN 76-166,850. PUB. 11-6-2001. FILED 11-17-2000.
 2,533,976. **OMEGA SPORTS BAR AND DESIGN**. FRIENDLY NUTRITIONALS, L.L.C, (U.S. CLS. 6, 18, 44, 46, 51 AND 52). SN 76-170,551. PUB. 11-6-2001. FILED 11-27-2000.
 2,533,982. **ACNOTEX**. GENESIS PHARMACEUTICAL, INC., (U.S. CLS. 6, 18, 44, 46, 51 AND 52). SN 76-172,686. PUB. 11-6-2001. FILED 11-30-2000.
 2,533,983. **MIRA**. COLTENE AG, (U.S. CLS. 6, 18, 44, 46, 51 AND 52). SN 76-172,738. PUB. 11-6-2001. FILED 11-29-2000.
 2,533,987. **JS 685 (STYLIZED)**. STUTTON CORPORATION, (U.S. CLS. 6, 18, 44, 46, 51 AND 52). SN 76-173,674. PUB. 11-6-2001. FILED 11-30-2000.
 2,533,995. **FORLAX**. SOCIETE DE CONSEILS DE RECHERCHES ET D'APPLICATIONS SCIENTIFIQUES (S.C.R.A.S.), (U.S. CLS. 6, 18, 44, 46, 51 AND 52). SN 76-178,301. PUB. 11-6-2001. FILED 12-8-2000.
 2,534,003. **GARDEN OF LIFE AND DESIGN**. GARDEN OF LIFE, INC., (U.S. CLS. 6, 18, 44, 46, 51 AND 52). SN 76-180,672. PUB. 11-6-2001. FILED 12-14-2000.
 2,534,039. **PINEGREEN**. T.C. HIGH TECH HERB, INC., (U.S. CLS. 6, 18, 44, 46, 51 AND 52). SN 76-190,649. PUB. 11-6-2001. FILED 1-8-2001.
 2,534,040. **ENDUROFLEX**. ANGELI, DARLENE B., (U.S. CLS. 6, 18, 44, 46, 51 AND 52). SN 76-191,050. PUB. 11-6-2001. FILED 1-2-2001.
 2,534,078. **POWERFUL N'ICE**. INSIGHT PHARMACEUTICALS CORPORATION, (U.S. CLS. 6, 18, 44, 46, 51 AND 52). SN 76-199,688. PUB. 11-6-2001. FILED 1-25-2001.
 2,534,094. **AGREE**. THERMO TRILOGY CORPORATION, (U.S. CLS. 6, 18, 44, 46, 51 AND 52). SN 76-203,657. PUB. 11-6-2001. FILED 2-1-2001.
 2,534,117. **MALPOTANE**. HEALTH PRODUCTS CORPORATION, (U.S. CLS. 6, 18, 44, 46, 51 AND 52). SN 76-208,243. PUB. 11-6-2001. FILED 2-9-2001.
 2,534,124. **BARR**. BARR LABORATORIES, INC., (U.S. CLS. 6, 18, 44, 46, 51 AND 52). SN 76-211,082. PUB. 11-6-2001. FILED 2-16-2001.
 2,534,152. **GOLDEN GLOW AND DESIGN**. NUTRITECH, INC., (U.S. CLS. 6, 18, 44, 46, 51 AND 52). SN 76-224,734. PUB. 11-6-2001. FILED 3-15-2001.
 2,534,205. **CLEARMIND (STYLIZED)**. AMERIDEN INTERNATIONAL, LLC, (U.S. CLS. 6, 18, 44, 46, 51 AND 52). SN 76-266,292. PUB. 11-6-2001. FILED 5-30-2000.
 2,534,263. **EQUIDRINE**. OXYGEN TECH, INC., (U.S. CLS. 6,

18, 44, 46, 51 AND 52). SN 76-287,131. PUB. 11-6-2001. FILED 7-19-2001.
 2,534,294. **SYSSTAR AND DESIGN**. REGAL CHEMICAL COMPANY, (U.S. CLS. 6, 18, 44, 46, 51 AND 52). SN 76-295,729. PUB. 11-6-2001. FILED 8-6-2001.
 2,534,296. **CHLOROSTAR AND DESIGN**. REGAL CHEMICAL COMPANY, (U.S. CLS. 6, 18, 44, 46, 51 AND 52). SN 76-295,885. PUB. 11-6-2001. FILED 8-6-2001.
 2,534,330. **VITAL VELVET**. MAINE NUTRITIONALS, INC., (U.S. CLS. 6, 18, 44, 46, 51 AND 52). SN 78-063,142. PUB. 11-6-2001. FILED 5-11-2001.

CLASS 6—METAL GOODS

2,533,274. **G GSI AND DESIGN**. GARITECH SYSTEMS INC., (U.S. CLS. 2, 12, 13, 14, 23, 25 AND 50). SN 75-659,094. PUB. 11-6-2001. FILED 3-12-1999.
 2,533,305. **CHICAGO WHITE METAL CASTING**. CHICAGO WHITE METAL CASTING, INC., MULTIPLE CLASS, (INT. CLS. 6 AND 40), (U.S. CLS. 2, 12, 13, 14, 23, 25, 50, 100, 103 AND 106). SN 75-719,247. PUB. 11-6-2001. FILED 10-30-1999.
 2,533,353. **GREENSTAR AND DESIGN**. LUCA, VALENTIN, (U.S. CLS. 2, 12, 13, 14, 23, 25 AND 50). SN 75-796,149. PUB. 11-6-2001. FILED 9-9-1999.
 2,533,587. **OMB AND DESIGN**. OMB S.P.A., (U.S. CLS. 2, 12, 13, 14, 23, 25 AND 50). SN 76-011,251. PUB. 11-6-2001. FILED 3-27-2000.
 2,533,817. **LUMIREFLEC**. BEELE ENGINEERING B.V., MULTIPLE CLASS, (INT. CLS. 6, 9, 17, 19 AND 42), (U.S. CLS. 1, 2, 5, 12, 13, 14, 21, 23, 25, 26, 33, 35, 36, 38, 50, 100 AND 101). SN 76-095,838. PUB. 11-6-2001. FILED 7-25-2000.
 2,533,839. **BRONZE ELITE ELEGANT GARDEN SCULPTURE HENRI STUDIO AND DESIGN**. HENRI STUDIO INC., MULTIPLE CLASS, (INT. CLS. 6 AND 11), (U.S. CLS. 2, 12, 13, 14, 21, 23, 25, 31, 34 AND 50). SN 76-113,899. PUB. 11-6-2001. FILED 8-22-2000.

CLASS 7—MACHINERY

2,533,221. **CITROEN SLIM LINE (STYLIZED)**. AUTOMOBILES CITROEN, MULTIPLE CLASS, (INT. CLS. 7 AND 12), (U.S. CLS. 13, 19, 21, 23, 31, 34, 35 AND 44). SN 75-502,115. PUB. 11-6-2001. FILED 6-10-1998.
 2,533,257. **TOLERANS INGOL AND DESIGN**. TOLERANS INGOL, (U.S. CLS. 13, 19, 21, 23, 31, 34 AND 35). SN 75-614,476. PUB. 11-6-2001. FILED 12-31-1998.
 2,533,271. **KING KUTTER II ALL GEAR DRIVEN INCORPORATED AND DESIGN**. KING KUTTER II INCORPORATED, (U.S. CLS. 13, 19, 21, 23, 31, 34 AND 35). SN 75-650,499. PUB. 11-6-2001. FILED 2-26-1999.
 2,533,299. **PAPERLINK**. KOERBER PAPERLINK-GMBH, (U.S. CLS. 13, 19, 21, 23, 31, 34 AND 35). SN 75-709,051. PUB. 11-6-2001. FILED 5-19-1999.
 2,533,326. **ALBERTI AND DESIGN**. ALBERTI, (U.S. CLS. 13, 19, 21, 23, 31, 34 AND 35). SN 75-752,317. PUB. 11-6-2001. FILED 7-15-1999.
 2,533,331. **BUNN AND DESIGN**. BUNN-O-MATIC CORPORATION, MULTIPLE CLASS, (INT. CLS. 7, 11, 35 AND 37), (U.S. CLS. 13, 19, 21, 23, 31, 34, 35, 100, 101, 102, 103 AND 106). SN 75-764,087. PUB. 11-6-2001. FILED 7-30-1999.
 2,533,454. **POWER BY RODI AND DESIGN**. RODI POWER SYSTEMS, INC., (U.S. CLS. 13, 19, 21, 23, 31, 34 AND 35). SN 75-892,739. PUB. 11-6-2001. FILED 1-10-2000.
 2,533,539. **PACTOR**. GERTEIS, PAUL, (U.S. CLS. 13, 19, 21, 23, 31, 34 AND 35). SN 75-934,297. PUB. 11-6-2001. FILED 3-2-2000.
 2,533,680. **SELEX**. WOJIN MACHINERY CO., LTD., (U.S. CLS. 13, 19, 21, 23, 31, 34 AND 35). SN 76-043,941. PUB. 11-6-2001. FILED 5-8-2000.
 2,533,695. **MISCELLANEOUS DESIGN**. CORNWELL QUALITY TOOL COMPANY, THE, MULTIPLE CLASS, (INT. CLS. 7, 8, 9 AND 35), (U.S. CLS. 13, 19, 21, 23, 26, 28, 31, 34, 35, 36, 38, 44, 100, 101 AND 102). SN 76-050,086. PUB. 11-6-

2001. FILED 5-17-2000.
- 2,533,763. **WEBEX**. WEBEX, INC., (U.S. CLS. 13, 19, 21, 23, 31, 34 AND 35). SN 76-073,263. PUB. 11-6-2001. FILED 6-20-2000.
- 2,533,800. **BAUSCH + STROEBEL**. ALPHACOS SA, MULTIPLE CLASS, (INT. CLS. 7 AND 42), (U.S. CLS. 13, 19, 21, 23, 31, 34, 35, 100 AND 101). SN 76-089,254. PUB. 11-6-2001. FILED 7-14-2000.
- 2,533,802. **SWIRKLEAN**. COLLINS PRODUCTS COMPANY, (U.S. CLS. 13, 19, 21, 23, 31, 34 AND 35). SN 76-089,684. PUB. 11-6-2001. FILED 7-13-2000.
- 2,533,831. **INVERTER GRADE**. EMERSON ELECTRIC CO., (U.S. CLS. 13, 19, 21, 23, 31, 34 AND 35). SN 76-106,589. PUB. 11-6-2001. FILED 8-9-2000.
- 2,533,853. **PITBULL**. CHICAGO INDUSTRIAL PUMP CO., (U.S. CLS. 13, 19, 21, 23, 31, 34 AND 35). SN 76-119,625. PUB. 11-6-2001. FILED 8-31-2000.
- 2,533,946. **YOUR ENGINEERING SOLUTIONS**. VIRGINIA INDUSTRIES, INC., (U.S. CLS. 13, 19, 21, 23, 31, 34 AND 35). SN 76-159,137. PUB. 11-6-2001. FILED 11-3-2000.
- 2,534,165. **WAFER**. GLEASON CUTTING TOOLS CORPORATION, (U.S. CLS. 13, 19, 21, 23, 31, 34 AND 35). SN 76-228,373. PUB. 11-6-2001. FILED 3-9-2001.
- 2,534,196. **PULL - DOG**. COOKIE INDUSTRIES, INC., (U.S. CLS. 13, 19, 21, 23, 31, 34 AND 35). SN 76-252,227. PUB. 11-6-2001. FILED 4-27-2001.
- 2,534,197. **ETC EXPRESS**. ELECTRIC TRANSPORTATION COMPANY, LLC, THE, (U.S. CLS. 13, 19, 21, 23, 31, 34 AND 35). SN 76-256,206. PUB. 11-6-2001. FILED 5-10-2001.
- 2,534,261. **SOLAR-SHIELD**. GOODYEAR TIRE & RUBBER COMPANY, THE, (U.S. CLS. 13, 19, 21, 23, 31, 34 AND 35). SN 76-285,916. PUB. 11-6-2001. FILED 7-18-2001.
- INC., MULTIPLE CLASS, (INT. CLS. 9 AND 41), (U.S. CLS. 21, 23, 26, 36, 38, 100, 101 AND 107). SN 75-507,862. PUB. 11-6-2001. FILED 6-24-1998.
- 2,533,234. **SPEEDPRO**. LEK TECHNOLOGIES, INC., (U.S. CLS. 21, 23, 26, 36 AND 38). SN 75-552,328. PUB. 11-6-2001. FILED 9-14-1998.
- 2,533,251. **FAST EDDIE**. PARKER, EDDIE, MULTIPLE CLASS, (INT. CLS. 9 AND 41), (U.S. CLS. 21, 23, 26, 36, 38, 100, 101 AND 107). SN 75-601,407. PUB. 11-6-2001. FILED 12-8-1998.
- 2,533,253. **BIG WHEEL OF GOLD**. ANCHOR COIN, (U.S. CLS. 21, 23, 26, 36 AND 38). SN 75-606,195. PUB. 3-27-2001. FILED 12-11-1998.
- 2,533,258 (*See Class 1 for this trademark*).
- 2,533,260. **PURPLE NITRILE**. SAFESKIN CORPORATION, MULTIPLE CLASS, (INT. CLS. 9 AND 10), (U.S. CLS. 21, 23, 26, 36, 38, 39 AND 44). SN 75-621,307. PUB. 11-6-2001. FILED 1-15-1999.
- 2,533,283 (*See Class 1 for this trademark*).
- 2,533,306. **TICKETS2000**. INTERTICKET INC., (U.S. CLS. 21, 23, 26, 36 AND 38). SN 75-725,291. PUB. 11-6-2001. FILED 7-6-1999.
- 2,533,333. **MATCHMOVER AND DESIGN**. REALVIZ, (U.S. CLS. 21, 23, 26, 36 AND 38). SN 75-768,628. PUB. 11-6-2001. FILED 8-5-1999.
- 2,533,354. **REGBUILDER**. DATALODE INC., (U.S. CLS. 21, 23, 26, 36 AND 38). SN 75-796,727. PUB. 11-6-2001. FILED 9-10-1999.
- 2,533,355. **SIDON**. SUNDANCE DIGITAL INC., (U.S. CLS. 21, 23, 26, 36 AND 38). SN 75-797,276. PUB. 11-6-2001. FILED 9-13-1999.
- 2,533,358. **SYNTEGRATECH AND DESIGN**. SYNTEGRATECH, INC., (U.S. CLS. 21, 23, 26, 36 AND 38). SN 75-807,011. PUB. 11-6-2001. FILED 9-24-1999.
- 2,533,361. **DOTMED.COM**. DOTMED.COM, INC., MULTIPLE CLASS, (INT. CLS. 9, 10, 35 AND 38), (U.S. CLS. 21, 23, 26, 36, 38, 39, 44, 100, 101, 102 AND 104). SN 75-813,207. PUB. 11-6-2001. FILED 10-1-1999.
- 2,533,362. **SOUNDBOMBING**. RAWKUS ENTERTAINMENT LLC, (U.S. CLS. 21, 23, 26, 36 AND 38). SN 75-813,805. PUB. 11-6-2001. FILED 10-4-1999.
- 2,533,367. **APPLICATIONXPRESS**. TENFOLD CORP., (U.S. CLS. 21, 23, 26, 36 AND 38). SN 75-822,857. PUB. 11-6-2001. FILED 10-14-1999.
- 2,533,370. **NOCTURNUS AND DESIGN**. NOCTURNUS, MULTIPLE CLASS, (INT. CLS. 9 AND 41), (U.S. CLS. 21, 23, 26, 36, 38, 100, 101 AND 107). SN 75-831,775. PUB. 11-6-2001. FILED 10-26-1999.
- 2,533,371. **VIDEOTRONIC**. VIDEOTRONIC INTERNATIONAL GMBH, MULTIPLE CLASS, (INT. CLS. 9, 35, 37 AND 41), (U.S. CLS. 21, 23, 26, 36, 38, 100, 101, 102, 103, 106 AND 107). SN 75-832,434. PUB. 11-6-2001. FILED 10-26-1999.
- 2,533,377. **FORGE**. STUDIO PON, (U.S. CLS. 21, 23, 26, 36 AND 38). SN 75-836,920. PUB. 11-6-2001. FILED 11-2-1999.
- 2,533,390. **DEL MAR AVIONICS**. DEL MAR AVIONICS, (U.S. CLS. 21, 23, 26, 36 AND 38). SN 75-850,588. PUB. 11-6-2001. FILED 12-8-1999.
- 2,533,392. **START AMERICA COLORING**. COHEN, JEFFREY ROBERT, (U.S. CLS. 21, 23, 26, 36 AND 38). SN 75-853,087. PUB. 11-6-2001. FILED 11-19-1999.
- 2,533,395. **SCISPY**. RESEARCH SYSTEMS, INC., BY ASSIGNMENT; BY ASSIGNMENT FORTNER SOFTWARE, L.L.C., (U.S. CLS. 21, 23, 26, 36 AND 38). SN 75-856,431. PUB. 11-6-2001. FILED 11-25-1999.
- 2,533,396. **LIKEGLUE.COM AND DESIGN**. LIKEGLUE.COM, L.L.C., (U.S. CLS. 21, 23, 26, 36 AND 38). SN 75-856,613. PUB. 11-6-2001. FILED 11-24-1999.
- 2,533,398. **GAMMA DENTAL SOFTWARE AND DESIGN**. GAMMA MEDIZINISCH-WISSENSCHAFTLICHE FORTBILDUNGSGESELLSCHAFT M.B.H., MULTIPLE CLASS, (INT. CLS. 9 AND 42), (U.S. CLS. 21, 23, 26, 36, 38, 100 AND 101). SN 75-859,416. PUB. 11-6-2001. FILED 11-29-1999.
- 2,533,408. **BABY VAN GOGH AND DESIGN**. BABY EINSTEIN COMPANY, LLC, THE, (U.S. CLS. 21, 23, 26, 36 AND 38). SN 75-866,483. PUB. 11-6-2001. FILED 12-7-1999.
- 2,533,447. **HOT DIGGITY DOG**. ARISTOCRAT TECHNOLOGIES AUSTRALIA PTY. LIMITED, BY CHANGE OF

CLASS 8—HAND TOOLS

- 2,533,196. **4-IN-ONE (STYLIZED)**. FUTZ FILE & TOOL CO., (U.S. CLS. 23, 28 AND 44). SN 75-262,663. PUB. 11-6-2001. FILED 3-24-1997.
- 2,533,560. **MAGNA-CLAMP**. LEON, RAYMOND, (U.S. CLS. 23, 28 AND 44). SN 75-942,086. PUB. 11-6-2001. FILED 3-11-2000.
- 2,533,601. **HAYCO**. HAYCO MANUFACTURING LIMITED, (U.S. CLS. 23, 28 AND 44). SN 76-018,968. PUB. 11-6-2001. FILED 4-6-2000.
- 2,533,651. **DURO**. NLC, INC., (U.S. CLS. 23, 28 AND 44). SN 76-036,659. PUB. 11-6-2001. FILED 4-28-2000.
- 2,533,695 (*See Class 7 for this trademark*).
- 2,534,121. **ROLOX**. ROLOX CORPORATION, THE, (U.S. CLS. 23, 28 AND 44). SN 76-209,129. PUB. 11-6-2001. FILED 2-12-2001.

CLASS 9—ELECTRICAL AND SCIENTIFIC APPARATUS

- 2,533,203. **DANCEHALL XPLOSION**. JAMDOWN RECORDS, (U.S. CLS. 21, 23, 26, 36 AND 38). SN 75-385,967. PUB. 11-6-2001. FILED 11-6-1997.
- 2,533,206. **L3 COMMUNICATIONS AND DESIGN**. L-3 COMMUNICATIONS CORPORATION, (U.S. CLS. 21, 23, 26, 36 AND 38). SN 75-421,290. PUB. 11-6-2001. FILED 1-21-1998.
- 2,533,208. **WCW WORLD WAR 3**. WORLD CHAMPIONSHIP WRESTLING, INC., (U.S. CLS. 21, 23, 26, 36 AND 38). SN 75-446,174. PUB. 11-6-2001. FILED 3-6-1998.
- 2,533,210. **MC2 (STYLIZED)**. TRILOGY COMMUNICATIONS, INC., (U.S. CLS. 21, 23, 26, 36 AND 38). SN 75-454,326. PUB. 11-6-2001. FILED 3-20-1998.
- 2,533,211. **ETAS**. ROBERT BOSCH GMBH, MULTIPLE CLASS, (INT. CLS. 9 AND 41), (U.S. CLS. 21, 23, 26, 36, 38, 100, 101 AND 107). SN 75-455,278. PUB. 11-6-2001. FILED 3-23-1998.
- 2,533,212. **AHA AND DESIGN**. ADVANCED HARDWARE ARCHITECTURES, INC., (U.S. CLS. 21, 23, 26, 36 AND 38). SN 75-456,000. PUB. 11-6-2001. FILED 3-23-1998.
- 2,533,225. **MOE**. (STYLIZED). FATBOY PRODUCTIONS,

- NAME ARISTOCRAT LEISURE INDUSTRIES PTY LTD, (U.S. CLS. 21, 23, 26, 36 AND 38). SN 75-888,746. PUB. 11-6-2001. FILED 1-6-2000.
- 2,533,465. **WELNAV**. WELLBORE NAVIGATION, INC., MULTIPLE CLASS, (INT. CLS. 9, 37, 40 AND 42), (U.S. CLS. 21, 23, 26, 36, 38, 100, 101, 103 AND 106). SN 75-899,069. PUB. 11-6-2001. FILED 1-18-2000.
- 2,533,469. **VECOM**. PEEK TRAFFIC B.V., (U.S. CLS. 21, 23, 26, 36 AND 38). SN 75-901,787. PUB. 11-6-2001. FILED 1-24-2000.
- 2,533,471. **ESI**. VIRTUAL SILICON TECHNOLOGY, INC., (U.S. CLS. 21, 23, 26, 36 AND 38). SN 75-902,027. PUB. 11-6-2001. FILED 1-24-2000.
- 2,533,472. **INNOV@T (STYLIZED)**. INNOTEK TECHNOLOGY INC., (U.S. CLS. 21, 23, 26, 36 AND 38). SN 75-902,063. PUB. 11-6-2001. FILED 1-24-2000.
- 2,533,501. **AUDILAB**. GROUPE PP HOLDING SA, MULTIPLE CLASS, (INT. CLS. 9, 10 AND 42), (U.S. CLS. 21, 23, 26, 36, 38, 39, 44, 100 AND 101). SN 75-918,548. PUB. 11-6-2001. FILED 2-15-2000.
- 2,533,505. **MARKETFORCE**. SOFTWARE OF THE FUTURE, INC., (U.S. CLS. 21, 23, 26, 36 AND 38). SN 75-920,649. PUB. 11-6-2001. FILED 2-14-2000.
- 2,533,522. **SAFLINK AND DESIGN**. SAFLINK CORPORATION, (U.S. CLS. 21, 23, 26, 36 AND 38). SN 75-927,714. PUB. 11-6-2001. FILED 2-24-2000.
- 2,533,528. **SAF2000 AND DESIGN**. SAFLINK CORPORATION, (U.S. CLS. 21, 23, 26, 36 AND 38). SN 75-930,750. PUB. 11-6-2001. FILED 2-28-2000.
- 2,533,552. **ALUMITEC**. TECART INDUSTRIES, INC., (U.S. CLS. 21, 23, 26, 36 AND 38). SN 75-939,014. PUB. 11-6-2001. FILED 3-8-2000.
- 2,533,553. **TECNEON**. TECART INDUSTRIES, INC., (U.S. CLS. 21, 23, 26, 36 AND 38). SN 75-939,015. PUB. 11-6-2001. FILED 3-8-2000.
- 2,533,564. **MISSOURI EMPLOYERS MUTUAL INSURANCE & DESIGN AND DESIGN**. MISSOURI EMPLOYERS MUTUAL INSURANCE, (U.S. CLS. 21, 23, 26, 36 AND 38). SN 75-943,546. PUB. 11-6-2001. FILED 3-14-2000.
- 2,533,575. **ZI IMAGING AND DESIGN**. Z/I IMAGING CORPORATION, (U.S. CLS. 21, 23, 26, 36 AND 38). SN 76-001,922. PUB. 11-6-2001. FILED 3-16-2000.
- 2,533,578. **T-COM**. SMITHS INDUSTRIES AEROSPACE & DEFENSE SYSTEMS, INC., (U.S. CLS. 21, 23, 26, 36 AND 38). SN 76-005,753. PUB. 11-6-2001. FILED 3-21-2000.
- 2,533,582. **I AND DESIGN**. INCENTECH, INC., (U.S. CLS. 21, 23, 26, 36 AND 38). SN 76-006,724. PUB. 11-6-2001. FILED 3-22-2000.
- 2,533,597. **CADES COVE**. ROSENFELD, RICHARD, AND ROSENFELD, GARY, (U.S. CLS. 21, 23, 26, 36 AND 38). SN 76-016,900. PUB. 11-6-2001. FILED 4-3-2000.
- 2,533,602 (*See Class 2 for this trademark*).
- 2,533,607. **QPAK**. MILLIPORE INVESTMENT HOLDINGS LIMITED, (U.S. CLS. 21, 23, 26, 36 AND 38). SN 76-021,620. PUB. 11-6-2001. FILED 4-7-2000.
- 2,533,615. **DIGGIN' IN DREAMLAND**. REES, JON, MULTIPLE CLASS, (INT. CLS. 9 AND 41), (U.S. CLS. 21, 23, 26, 36, 38, 100, 101 AND 107). SN 76-024,525. PUB. 11-6-2001. FILED 4-13-2000.
- 2,533,626. **AVID**. SWANSON, MARY CATHERINE, (U.S. CLS. 21, 23, 26, 36 AND 38). SN 76-028,447. PUB. 11-6-2001. FILED 4-10-2000.
- 2,533,660. **M AND DESIGN**. MARS, INCORPORATED, (U.S. CLS. 21, 23, 26, 36 AND 38). SN 76-039,377. PUB. 11-6-2001. FILED 5-2-2000.
- 2,533,682. **CONGRAV**. BRABENDER TECHNOLOGIE KG, (U.S. CLS. 21, 23, 26, 36 AND 38). SN 76-045,009. PUB. 11-6-2001. FILED 5-5-1999.
- 2,533,695 (*See Class 7 for this trademark*).
- 2,533,779. **PRDP'S CAUSE CODE TOOL**. PUBLIC RISK DATABASE PROJECT, (U.S. CLS. 21, 23, 26, 36 AND 38). SN 76-080,546. PUB. 11-6-2001. FILED 6-29-2000.
- 2,533,781. **REACTIVE NETWORKING**. REACTIVE NETWORKING, INC., MULTIPLE CLASS, (INT. CLS. 9 AND 42), (U.S. CLS. 21, 23, 26, 36, 38, 100 AND 101). SN 76-080,973. PUB. 11-6-2001. FILED 6-30-2000.
- 2,533,792. **YOUR COMPLIANCE ADVOCATE**. LIGHTHOUSE COMPLIANCE, INC., (U.S. CLS. 21, 23, 26, 36 AND 38). SN 76-086,040. PUB. 11-6-2001. FILED 7-3-2000.
- 2,533,817 (*See Class 6 for this trademark*).
- 2,533,876. **MODULARIS**. MODULARS, INC., MULTIPLE CLASS, (INT. CLS. 9 AND 42), (U.S. CLS. 21, 23, 26, 36, 38, 100 AND 101). SN 76-131,664. PUB. 11-6-2001. FILED 9-20-2000.
- 2,533,877. **BOSTONPROBES (STYLIZED)**. BOSTON PROBES, INC., (U.S. CLS. 21, 23, 26, 36 AND 38). SN 76-131,936. PUB. 11-6-2001. FILED 9-20-2000.
- 2,533,899. **MISCELLANEOUS DESIGN**. CHAINTECH COMPUTER CO., LTD., (U.S. CLS. 21, 23, 26, 36 AND 38). SN 76-142,180. PUB. 11-6-2001. FILED 10-5-2000.
- 2,533,900. **CHAINTECH**. CHAINTECH COMPUTER CO., LTD., (U.S. CLS. 21, 23, 26, 36 AND 38). SN 76-142,181. PUB. 11-6-2001. FILED 10-5-2000.
- 2,533,907. **ANABOLIC DIGITAL**. ANABOLIC VIDEO PRODUCTIONS, INC., (U.S. CLS. 21, 23, 26, 36 AND 38). SN 76-145,300. PUB. 11-6-2001. FILED 10-13-2000.
- 2,533,924. **MICRO GENERAL**. GEM OFFICE PRODUCTS CO., LLC, (U.S. CLS. 21, 23, 26, 36 AND 38). SN 76-153,198. PUB. 11-6-2001. FILED 10-24-2000.
- 2,533,930. **FORMMAGICIAN**. MACRO INTERNATIONAL INC., (U.S. CLS. 21, 23, 26, 36 AND 38). SN 76-155,302. PUB. 11-6-2001. FILED 10-30-2000.
- 2,533,939. **PROFORM AND DESIGN**. REGIONAL ECONOMIC RESEARCH, INC., (U.S. CLS. 21, 23, 26, 36 AND 38). SN 76-157,406. PUB. 11-6-2001. FILED 11-2-2000.
- 2,533,967 (*See Class 5 for this trademark*).
- 2,533,975. **INTEROSAMAIL**. INTEROSA, INC., (U.S. CLS. 21, 23, 26, 36 AND 38). SN 76-170,420. PUB. 11-6-2001. FILED 11-22-2000.
- 2,534,002. **MR. CLICK AND DESIGN**. MONK, ELMER, W., (U.S. CLS. 21, 23, 26, 36 AND 38). SN 76-180,506. PUB. 11-6-2001. FILED 12-14-2000.
- 2,534,015. **LOUISVILLE SLUGGER FIELD**. HILLERICH & BRADSBY CO., (U.S. CLS. 21, 23, 26, 36 AND 38). SN 76-183,896. PUB. 11-6-2001. FILED 12-19-2000.
- 2,534,049. **USE BEFORE YOU BURN! (STYLIZED)**. CRACKLE CREATIONS, INC., (U.S. CLS. 21, 23, 26, 36 AND 38). SN 76-193,676. PUB. 11-6-2001. FILED 1-16-2001.
- 2,534,065. **ACCUFACTS**. FACTS MANAGEMENT CO., (U.S. CLS. 21, 23, 26, 36 AND 38). SN 76-197,482. PUB. 11-6-2001. FILED 1-16-2001.
- 2,534,082. **HAMPSTERDANCE**. ABATIS INTERNATIONAL, LLC, MULTIPLE CLASS, (INT. CLS. 9 AND 41), (U.S. CLS. 21, 23, 26, 36, 38, 100, 101 AND 107). SN 76-200,963. PUB. 11-6-2001. FILED 1-26-2001.
- 2,534,085. **E AND DESIGN**. EKO SYSTEMS, INC., (U.S. CLS. 21, 23, 26, 36 AND 38). SN 76-202,395. PUB. 11-6-2001. FILED 1-29-2001.
- 2,534,086. **EKO SYSTEMS INCORPORATED**. EKO SYSTEMS, INC., (U.S. CLS. 21, 23, 26, 36 AND 38). SN 76-202,397. PUB. 11-6-2001. FILED 1-29-2001.
- 2,534,090. **BONDEZE**. PHELPS DODGE INDUSTRIES, INC., (U.S. CLS. 21, 23, 26, 36 AND 38). SN 76-203,085. PUB. 11-6-2001. FILED 1-31-2001.
- 2,534,092. **TOTEBOOK**. ICU ACCESSORIES INC., (U.S. CLS. 21, 23, 26, 36 AND 38). SN 76-203,337. PUB. 11-6-2001. FILED 1-19-2001.
- 2,534,119. **EYEMAIL (STYLIZED)**. EYEWONDER, INC., (U.S. CLS. 21, 23, 26, 36 AND 38). SN 76-208,841. PUB. 11-6-2001. FILED 2-13-2001.
- 2,534,162. **CENTRAXICE**. CYBERSAFE CORPORATION, (U.S. CLS. 21, 23, 26, 36 AND 38). SN 76-227,066. PUB. 11-6-2001. FILED 3-16-2001.
- 2,534,166. **ROBOT/SPACE**. HELP/SYSTEMS INCORPORATED, (U.S. CLS. 21, 23, 26, 36 AND 38). SN 76-229,137. PUB. 11-6-2001. FILED 3-21-2001.
- 2,534,212. **ORCHESTRATE**. TORRENT SYSTEMS, INC., (U.S. CLS. 21, 23, 26, 36 AND 38). SN 76-271,147. PUB. 11-6-2001. FILED 6-13-2001.
- 2,534,216. **SLINKY**. JAMES INDUSTRIES, INC., (U.S. CLS. 21, 23, 26, 36 AND 38). SN 76-273,369. PUB. 11-6-2001. FILED 6-19-2001.
- 2,534,224. **V-STIX**. MUSICPLAYGROUND INC., (U.S. CLS. 21, 23, 26, 36 AND 38). SN 76-276,795. PUB. 11-6-2001. FILED 6-26-2001.
- 2,534,228. **PI CIRCULAR**. PRECISION INTERCONNECT CORPORATION, (U.S. CLS. 21, 23, 26, 36 AND 38). SN 76-

278,913. PUB. 11-6-2001. FILED 7-2-2001.
 2,534,229. **MISCELLANEOUS DESIGN**. SANDISK CORPORATION, (U.S. CLS. 21, 23, 26, 36 AND 38). SN 76-279,563. PUB. 11-6-2001. FILED 7-3-2001.
 2,534,230. **MISCELLANEOUS DESIGN**. SANDISK CORPORATION, (U.S. CLS. 21, 23, 26, 36 AND 38). SN 76-279,567. PUB. 11-6-2001. FILED 7-3-2001.
 2,534,237. **HULA HULA**. IGT, (U.S. CLS. 21, 23, 26, 36 AND 38). SN 76-281,099. PUB. 11-6-2001. FILED 7-6-2001.
 2,534,250. **T-WARMER**. IVFONLINE.COM, LLC, (U.S. CLS. 21, 23, 26, 36 AND 38). SN 76-283,777. PUB. 11-6-2001. FILED 7-13-2001.
 2,534,253. **TRIGGERFISH**. HARRIS CORPORATION, (U.S. CLS. 21, 23, 26, 36 AND 38). SN 76-284,647. PUB. 11-6-2001. FILED 7-13-2001.
 2,534,257. **SALERIOEZE**. 110 LIMITED, (U.S. CLS. 21, 23, 26, 36 AND 38). SN 76-285,758. PUB. 11-6-2001. FILED 7-16-2001.
 2,534,262. **MISCELLANEOUS DESIGN**. WERLEIN, KENNETH, (U.S. CLS. 21, 23, 26, 36 AND 38). SN 76-286,663. PUB. 11-6-2001. FILED 7-17-2001.
 2,534,267. **ON YOUR OWN**. W SOLUTIONS, INCORPORATED, (U.S. CLS. 21, 23, 26, 36 AND 38). SN 76-288,357. PUB. 11-6-2001. FILED 7-20-2001.
 2,534,269. **CHAINSAWS AND TOASTERS**. IGT, (U.S. CLS. 21, 23, 26, 36 AND 38). SN 76-289,995. PUB. 11-6-2001. FILED 7-25-2001.
 2,534,300. **EMAILXTENDER**. OTG SOFTWARE, INC., (U.S. CLS. 21, 23, 26, 36 AND 38). SN 78-005,076. PUB. 11-6-2001. FILED 4-21-2000.
 2,534,310. **JELT**. JELT SOFTWARE EXPRESS, INC., MULTIPLE CLASS, (INT. CLS. 9 AND 42), (U.S. CLS. 21, 23, 26, 36, 38, 100 AND 101). SN 78-017,581. PUB. 11-6-2001. FILED 7-20-2000.
 2,534,318. **CARBUG**. CARBUG, INC., (U.S. CLS. 21, 23, 26, 36 AND 38). SN 78-035,276. PUB. 11-6-2001. FILED 11-14-2000.
 2,534,322. **QUICKCROP**. MCGUIRE, PAUL, A., (U.S. CLS. 21, 23, 26, 36 AND 38). SN 78-044,392. PUB. 11-6-2001. FILED 1-22-2001.
 2,534,340. **TESTSIGHT**. DEMILLE RESEARCH, INC., MULTIPLE CLASS, (INT. CLS. 9 AND 42), (U.S. CLS. 21, 23, 26, 36, 38, 100 AND 101). SN 78-069,673. PUB. 11-6-2001. FILED 6-18-2001.

CLASS 10—MEDICAL APPARATUS

2,533,204. **CENTURY**. AMERICAN STERILIZER COMPANY, MULTIPLE CLASS, (INT. CLS. 10 AND 11), (U.S. CLS. 13, 21, 23, 26, 31, 34, 39 AND 44). SN 75-396,874. PUB. 11-6-2001. FILED 11-26-1997.
 2,533,207. **AUDIOZOOM**. PHONAK HOLDING AG, MULTIPLE CLASS, (INT. CLS. 10 AND 42), (U.S. CLS. 26, 39, 44, 100 AND 101). SN 75-442,367. PUB. 11-6-2001. FILED 3-2-1998.
 2,533,252 (*See Class 5 for this trademark*).
 2,533,260 (*See Class 9 for this trademark*).
 2,533,268 (*See Class 5 for this trademark*).
 2,533,361 (*See Class 9 for this trademark*).
 2,533,374. **DISCOVERY**. CARDGUARD U.S.A., INC., (U.S. CLS. 26, 39 AND 44). SN 75-834,312. PUB. 11-6-2001. FILED 10-28-1999.
 2,533,379. **NEOX AND DESIGN**. TAI SHENG ELECTRICAL MACHINERY CO., LTD., (U.S. CLS. 26, 39 AND 44). SN 75-839,323. PUB. 11-6-2001. FILED 11-4-1999.
 2,533,417. **MISCELLANEOUS DESIGN**. INNOTHERA TOPIC INTERNATIONAL, (U.S. CLS. 26, 39 AND 44). SN 75-872,856. PUB. 11-6-2001. FILED 12-16-1999.
 2,533,418. **MISCELLANEOUS DESIGN**. INNOTHERA TOPIC INTERNATIONAL, (U.S. CLS. 26, 39 AND 44). SN 75-873,683. PUB. 11-6-2001. FILED 12-16-1999.
 2,533,419. **VARISMA AND DESIGN**. INNOTHERA TOPIC INTERNATIONAL, (U.S. CLS. 26, 39 AND 44). SN 75-873,699. PUB. 11-6-2001. FILED 12-16-1999.
 2,533,450. **VIP**. BAXTER INTERNATIONAL INC., (U.S. CLS. 26, 39 AND 44). SN 75-890,913. PUB. 11-6-2001. FILED 1-7-2000.
 2,533,456 (*See Class 5 for this trademark*).

2,533,459. **AKITA**. INSTITUT FUR AEROSOL-MEDIZIN IN-AMED GMBH, (U.S. CLS. 26, 39 AND 44). SN 75-894,600. PUB. 11-6-2001. FILED 1-11-2000.
 2,533,478. **SABRE**. CONMED CORPORATION, (U.S. CLS. 26, 39 AND 44). SN 75-903,650. PUB. 11-6-2001. FILED 1-26-2000.
 2,533,499. **THE SEVEN PEARLS OF THE ORIENT**. LES PRODUITS ASSOCIES LPA-BROXO S.A., (U.S. CLS. 26, 39 AND 44). SN 75-917,834. PUB. 11-6-2001. FILED 2-14-2000.
 2,533,501 (*See Class 9 for this trademark*).
 2,533,519. **ULTRA COQ10 100**. NATURAL ORGANICS INC., (U.S. CLS. 26, 39 AND 44). SN 75-927,422. PUB. 11-6-2001. FILED 2-25-2000.
 2,533,550. **TORSOS' PORT**. HEINZE, FRANK D., MULTIPLE CLASS, (INT. CLS. 10 AND 28), (U.S. CLS. 22, 23, 26, 38, 39, 44 AND 50). SN 75-938,508. PUB. 11-6-2001. FILED 3-8-2000.
 2,533,554. **ROLL-A-BOUNCE**. ACCETTA, RODERICK W., (U.S. CLS. 26, 39 AND 44). SN 75-939,281. PUB. 11-6-2001. FILED 3-9-2000.
 2,533,561. **PHYSIODYNAMICS, INC. AND DESIGN**. PHYSIODYNAMICS, INC., (U.S. CLS. 26, 39 AND 44). SN 75-942,659. PUB. 11-6-2001. FILED 3-13-2000.
 2,533,621. **SQUIRT**. MERIT MEDICAL SYSTEMS, INC., (U.S. CLS. 26, 39 AND 44). SN 76-027,389. PUB. 11-6-2001. FILED 4-17-2000.
 2,533,708. **PAVIS AND DESIGN**. PAVIS VARESE S.R.L., (U.S. CLS. 26, 39 AND 44). SN 76-054,405. PUB. 11-6-2001. FILED 5-22-2000.
 2,533,715. **EVACU-AID**. WAHLER, BRYAN R., (U.S. CLS. 26, 39 AND 44). SN 76-056,220. PUB. 11-6-2001. FILED 5-24-2000.
 2,533,749. **TROJAN PLEASURE MESH**. CARTER-WALLACE, INC., (U.S. CLS. 26, 39 AND 44). SN 76-069,250. PUB. 11-6-2001. FILED 6-13-2000.
 2,533,783. **SELECTIVE ESTHETICS**. SONAGE, INC., (U.S. CLS. 26, 39 AND 44). SN 76-083,297. PUB. 11-6-2001. FILED 7-5-2000.
 2,533,821. **RF 2000**. RADIO THERAPEUTICS CORPORATION, (U.S. CLS. 26, 39 AND 44). SN 76-098,915. PUB. 11-6-2001. FILED 7-27-2000.
 2,533,859. **DELWA STAR IN SWITZERLAND AND WORLD-WIDE AND DESIGN**. ZEW, INC., (U.S. CLS. 26, 39 AND 44). SN 76-124,475. PUB. 11-6-2001. FILED 9-8-2000.
 2,533,890. **MCRI AND DESIGN**. MEDICAL CARBON RESEARCH INSTITUTE, LLC, (U.S. CLS. 26, 39 AND 44). SN 76-136,790. PUB. 11-6-2001. FILED 9-28-2000.
 2,533,933. **CANDO**. GOLDBERG ELLIOTT, MULTIPLE CLASS, (INT. CLS. 10 AND 28), (U.S. CLS. 22, 23, 26, 38, 39, 44 AND 50). SN 76-156,173. PUB. 11-6-2001. FILED 10-26-2000.
 2,533,945. **HEMOSCALPEL**. ELLMAN INTERNATIONAL, INC., (U.S. CLS. 26, 39 AND 44). SN 76-158,923. PUB. 11-6-2001. FILED 11-3-2000.
 2,533,967 (*See Class 5 for this trademark*).
 2,533,974. **DC I**. MASIMO CORPORATION, (U.S. CLS. 26, 39 AND 44). SN 76-169,985. PUB. 11-6-2001. FILED 11-22-2000.
 2,533,999. **TUG AHOY AND DESIGN**. HAUGHEY, JAMES A., (U.S. CLS. 26, 39 AND 44). SN 76-179,684. PUB. 11-6-2001. FILED 12-11-2000.
 2,534,059. **EUROLINE**. DENTSPLY INTERNATIONAL INC., (U.S. CLS. 26, 39 AND 44). SN 76-197,091. PUB. 11-6-2001. FILED 1-22-2001.
 2,534,070. **ULTRA SOFTHOTIC**. FOOT LEVELERS, INC., (U.S. CLS. 26, 39 AND 44). SN 76-198,969. PUB. 11-6-2001. FILED 1-24-2001.
 2,534,233. **VTX**. HORIZON MEDICAL PRODUCTS, INC., (U.S. CLS. 26, 39 AND 44). SN 76-280,164. PUB. 11-6-2001. FILED 7-3-2001.
 2,534,266. **TURNER SAV-A-LINE**. TURNER, DEBORAH A., (U.S. CLS. 26, 39 AND 44). SN 76-288,301. PUB. 11-6-2001. FILED 7-23-2001.

CLASS 11—ENVIRONMENTAL CONTROL APPARATUS

2,533,204 (*See Class 10 for this trademark*).
 2,533,308. **LIQUID CORE**. PREMARK WB HOLDINGS, INC., (U.S. CLS. 13, 21, 23, 31 AND 34). SN 75-726,259. PUB. 11-6-

2001. FILED 6-10-1999.
 2,533,331 (*See Class 7 for this trademark*).
 2,533,574. **FILTERMAX**. AB PH. NEDERMAN & CO., (U.S. CLS. 13, 21, 23, 31 AND 34). SN 76-001,375. PUB. 11-6-2001. FILED 3-15-2000.
 2,533,596. **MILLENNIA**. DISTINCTIVE APPLIANCES, INC., DBA DACOR, (U.S. CLS. 13, 21, 23, 31 AND 34). SN 76-016,470. PUB. 11-6-2001. FILED 4-3-2000.
 2,533,643. **TIMBERLINE**. CFM MAJESTIC INC., (U.S. CLS. 13, 21, 23, 31 AND 34). SN 76-034,167. PUB. 11-6-2001. FILED 4-25-2000.
 2,533,839 (*See Class 6 for this trademark*).
 2,533,935. **RADICOLOR**. LITEGLOW INDUSTRIES, INC., (U.S. CLS. 13, 21, 23, 31 AND 34). SN 76-156,541. PUB. 11-6-2001. FILED 11-1-2000.
 2,534,013. **BIOBIDET**. UCL, INC., (U.S. CLS. 13, 21, 23, 31 AND 34). SN 76-183,675. PUB. 11-6-2001. FILED 12-19-2000.
 2,534,147. **OMNI GRILL**. LYNRUS ALUMINUM PRODUCTS, L.L.C., (U.S. CLS. 13, 21, 23, 31 AND 34). SN 76-222,994. PUB. 11-6-2001. FILED 3-12-2001.
 2,534,195. **RANCH**. WEBER-STEPHEN PRODUCTS CO., (U.S. CLS. 13, 21, 23, 31 AND 34). SN 76-252,167. PUB. 11-6-2001. FILED 5-4-2001.
 2,534,260. **WATERBETTER AND DESIGN**. HARMSCO, INC., (U.S. CLS. 13, 21, 23, 31 AND 34). SN 76-285,906. PUB. 11-6-2001. FILED 7-17-2001.
 2,534,342. **SPECIFIC SYSTEMS AND DESIGN**. SPECIFIC SYSTEMS, LTD., (U.S. CLS. 13, 21, 23, 31 AND 34). SN 78-071,077. PUB. 11-6-2001. FILED 6-26-2001.

CLASS 12—VEHICLES

- 2,533,221 (*See Class 7 for this trademark*).
 2,533,265. **MISCELLANEOUS DESIGN**. AEOLUS TECHNOLOGY LLC, (U.S. CLS. 19, 21, 23, 31, 35 AND 44). SN 75-640,879. PUB. 11-6-2001. FILED 2-8-1999.
 2,533,267. **MILLENNIUM**. TRANSPORTATION COMPONENTS, INC., (U.S. CLS. 19, 21, 23, 31, 35 AND 44). SN 75-642,994. PUB. 11-6-2001. FILED 2-17-1999.
 2,533,276. **HITCHING POST**. INDUSTRI AB THULE, (U.S. CLS. 19, 21, 23, 31, 35 AND 44). SN 75-665,417. PUB. 11-6-2001. FILED 3-22-1999.
 2,533,324. **MEKAM**. GEBR. OTTO KG, MULTIPLE CLASS, (INT. CLS. 12 AND 21), (U.S. CLS. 2, 13, 19, 21, 23, 29, 30, 31, 33, 35, 40, 44 AND 50). SN 75-747,481. PUB. 11-6-2001. FILED 6-29-1999.
 2,533,332. **CORBEIL LES ENTREPRISES MICHEL CORBEIL INC. LAURENIDES QUEBEC CANADA AND DESIGN. LES ENTREPRISES MICHEL CORBEIL INC.**, (U.S. CLS. 19, 21, 23, 31, 35 AND 44). SN 75-767,976. PUB. 8-22-2000. FILED 8-4-1999.
 2,533,627. **SPRAY MATE**. FLEET ENGINEERS, INC., (U.S. CLS. 19, 21, 23, 31, 35 AND 44). SN 76-028,723. PUB. 11-6-2001. FILED 4-17-2000.
 2,533,641. **WOLF WHISTLE**. SPEEDWAY MOTORS, INC., (U.S. CLS. 19, 21, 23, 31, 35 AND 44). SN 76-033,017. PUB. 11-6-2001. FILED 4-24-2000.
 2,533,659. **NRS**. NUCAP INDUSTRIES INC., (U.S. CLS. 19, 21, 23, 31, 35 AND 44). SN 76-038,962. PUB. 11-6-2001. FILED 5-2-2000.
 2,533,759. **NATIONAL EQUIPMENT AND DESIGN**. NATIONAL EQUIPMENT DISTRIBUTORS, INC., (U.S. CLS. 19, 21, 23, 31, 35 AND 44). SN 76-072,471. PUB. 11-6-2001. FILED 6-19-2000.
 2,534,302. **S8**. AUDI A.G., (U.S. CLS. 19, 21, 23, 31, 35 AND 44). SN 78-008,664. PUB. 11-6-2001. FILED 5-18-2000.

CLASS 13—FIREARMS

- 2,533,971. **KIRST CARTRIDGE KONVERTER**. KIRST COMPANY, (U.S. CLS. 2 AND 9). SN 76-168,637. PUB. 11-6-2001. FILED 11-20-2000.
 2,534,113. **TOP BRASS**. SCHARCH MFG., INC., (U.S. CLS. 2

AND 9). SN 76-207,770. PUB. 11-6-2001. FILED 2-7-2001.

CLASS 14—JEWELRY

- 2,533,236. **BRINSON**. BRINSON PARTNERS, INC., BY ASSIGNMENT UBS AG, MULTIPLE CLASS, (INT. CLS. 14, 35, 36 AND 38), (U.S. CLS. 2, 27, 28, 50, 100, 101, 102 AND 104). SN 75-558,845. PUB. 11-6-2001. FILED 9-24-1998.
 2,533,368. **S DRAKE (STYLIZED)**. DRAKE DESIGNS, INC., (U.S. CLS. 2, 27, 28 AND 50). SN 75-825,952. PUB. 11-6-2001. FILED 10-19-1999.
 2,533,397 (*See Class 3 for this trademark*).
 2,533,494. **ORT**. AMERICAN ORT, INC., MULTIPLE CLASS, (INT. CLS. 14, 16, 25, 36 AND 41), (U.S. CLS. 2, 5, 22, 23, 27, 28, 29, 37, 38, 39, 50, 100, 101, 102 AND 107). SN 75-916,258. PUB. 11-6-2001. FILED 2-10-2000.
 2,533,720. **TIVOL**. TIVOL PLAZA, INC., (U.S. CLS. 2, 27, 28 AND 50). SN 76-057,527. PUB. 11-6-2001. FILED 4-21-2000.
 2,533,769. **GUIBAO AND DESIGN**. BEIJING GUI ZHI BAO ECONOMIC AND TRADE DEVELOPMENT CO., LTD., (U.S. CLS. 2, 27, 28 AND 50). SN 76-076,924. PUB. 11-6-2001. FILED 6-27-2000.

CLASS 15—MUSICAL INSTRUMENTS

- 2,533,878. **THE PLAYER'S CHOICE**. J. D'ADDARIO & COMPANY, INC., (U.S. CLS. 2, 21 AND 36). SN 76-131,980. PUB. 11-6-2001. FILED 9-20-2000.
 2,534,131. **VH AND DESIGN**. E.L.V.H., INC., (U.S. CLS. 2, 21 AND 36). SN 76-213,907. PUB. 11-6-2001. FILED 2-20-2001.
 2,534,268. **NORMANDY**. G. LEBLANC CORPORATION, (U.S. CLS. 2, 21 AND 36). SN 76-289,405. PUB. 11-6-2001. FILED 7-24-2001.

CLASS 16—PAPER GOODS AND PRINTED MATTER

- 2,533,191. **MILLENNIUM COMPUTER TECHNOLOGY**. AUTOMATED SOLUTIONS, INC., DBA MILLENNIUM COMPUTER TECHNOLOGY, (U.S. CLS. 2, 5, 22, 23, 29, 37, 38 AND 50). SN 74-619,071. PUB. 10-24-1995. FILED 1-9-1995.
 2,533,283 (*See Class 1 for this trademark*).
 2,533,285. **STAMPSAMERICA AND DESIGN**. ROYAL PACIFIC INDUSTRIES LLC, (U.S. CLS. 2, 5, 22, 23, 29, 37, 38 AND 50). SN 75-674,994. PUB. 11-6-2001. FILED 4-7-1999.
 2,533,287. **CALIFORNIA REAL ESTATE INSPECTION ASSOCIATION AND DESIGN**. CALIFORNIA REAL ESTATE INSPECTION ASSOCIATION, (U.S. CLS. 2, 5, 22, 23, 29, 37, 38 AND 50). SN 75-681,502. PUB. 11-6-2001. FILED 4-12-1999.
 2,533,344. **OVERCOMING OBSTACLES AND DESIGN**. COMMUNITY FOR EDUCATION FOUNDATION, MULTIPLE CLASS, (INT. CLS. 16, 36 AND 41), (U.S. CLS. 2, 5, 22, 23, 29, 37, 38, 50, 100, 101, 102 AND 107). SN 75-783,165. PUB. 8-8-2000. FILED 8-24-1999.
 2,533,346. **MISCELLANEOUS DESIGN**. BUCK, L.L.C., DBA BUCK WILDER ADVENTURES, (U.S. CLS. 2, 5, 22, 23, 29, 37, 38 AND 50). SN 75-784,575. PUB. 11-6-2001. FILED 8-25-1999.
 2,533,399. **NHSI**. NIELSEN MEDIA RESEARCH, INC. (U.S. CLS. 2, 5, 22, 23, 29, 37, 38 AND 50). SN 75-860,646. PUB. 11-6-2001. FILED 11-30-1999.
 2,533,421. **PIDDLE PADS**. FOSTER & SMITH, INC., (U.S. CLS. 2, 5, 22, 23, 29, 37, 38 AND 50). SN 75-873,769. PUB. 11-6-2001. FILED 12-17-1999.
 2,533,494 (*See Class 14 for this trademark*).
 2,533,533. **SALON SUCCESS AND DESIGN**. SALON SUCCESS LIMITED, MULTIPLE CLASS, (INT. CLS. 16 AND 35), (U.S. CLS. 2, 5, 22, 23, 29, 37, 38, 50, 100, 101 AND 102). SN 75-932,554. PUB. 11-6-2001. FILED 3-1-2000.
 2,533,544. **ESTATES WEST**. ELLIOT, CONRAD, DBA ESTATES WEST, AND PETERSON, MARK, DBA ESTATES

- WEST, (U.S. CLS. 2, 5, 22, 23, 29, 37, 38 AND 50). SN 75-936,043. PUB. 11-6-2001. FILED 2-23-2000.
- 2,533,546. **SIGNIA FINE PAPERS AND DESIGN**. HAHN, SOPHIE, DBA SIGNIA FINE PAPERS, AND BIRKHAHN, CHRISTIENNE DE TOUMAY, DBA SIGNIA FINE PAPERS, (U.S. CLS. 2, 5, 22, 23, 29, 37, 38 AND 50). SN 75-936,289. PUB. 11-6-2001. FILED 3-6-2000.
- 2,533,562. **APPLE SEED**. MARKET DAY CORPORATION, (U.S. CLS. 2, 5, 22, 23, 29, 37, 38 AND 50). SN 75-942,904. PUB. 10-31-2000. FILED 3-13-2000.
- 2,533,585. **SUCCESSFUL EQUITY MANAGEMENT SEMINAR**. SUCCESSFUL MONEY MANAGEMENT SEMINARS, INC., MULTIPLE CLASS, (INT. CLS. 16 AND 41), (U.S. CLS. 2, 5, 22, 23, 29, 37, 38, 50, 100, 101 AND 107). SN 76-009,774. PUB. 11-6-2001. FILED 3-27-2000.
- 2,533,589. **PAULIST PRESS**. PAULIST PRESS, (U.S. CLS. 2, 5, 22, 23, 29, 37, 38 AND 50). SN 76-011,915. PUB. 11-6-2001. FILED 3-29-2000.
- 2,533,600. **I ORLANDO AND DESIGN**. CENTRAL FLORIDA INVESTMENTS, INC., (U.S. CLS. 2, 5, 22, 23, 29, 37, 38 AND 50). SN 76-018,475. PUB. 11-6-2001. FILED 4-6-2000.
- 2,533,609. **T2-3D TERMINATOR 2 (STYLIZED)**. CANAL + D.A., (U.S. CLS. 2, 5, 22, 23, 29, 37, 38 AND 50). SN 76-022,130. PUB. 11-6-2001. FILED 4-10-2000.
- 2,533,654. **HR NEWS AND DESIGN**. SOCIETY FOR HUMAN RESOURCE MANAGEMENT, (U.S. CLS. 2, 5, 22, 23, 29, 37, 38 AND 50). SN 76-037,264. PUB. 11-6-2001. FILED 4-28-2000.
- 2,533,684. **MMM AND DESIGN**. MARS, INCORPORATED, (U.S. CLS. 2, 5, 22, 23, 29, 37, 38 AND 50). SN 76-046,101. PUB. 11-6-2001. FILED 5-11-2000.
- 2,533,709. **FREEDOM COMMUNICATIONS, INC. AND DESIGN**. FREEDOM COMMUNICATIONS, INC., MULTIPLE CLASS, (INT. CLS. 16, 38 AND 41), (U.S. CLS. 2, 5, 22, 23, 29, 37, 38, 50, 100, 101, 104 AND 107). SN 76-054,660. PUB. 11-6-2001. FILED 5-23-2000.
- 2,533,714. **RIGBY**. REED ELSEVIER INC., (U.S. CLS. 2, 5, 22, 23, 29, 37, 38 AND 50). SN 76-056,192. PUB. 11-6-2001. FILED 5-25-2000.
- 2,533,722. **POSITIVE APPROACHES**. MERCK-MEDCO MANAGED CARE, L.L.C., (U.S. CLS. 2, 5, 22, 23, 29, 37, 38 AND 50). SN 76-058,310. PUB. 2-13-2001. FILED 5-30-2000.
- 2,533,751 (*See Class 1 for this trademark*).
- 2,533,804. **JINGLE-NET.COM**. JINGLE-NET.COM, INC., (U.S. CLS. 2, 5, 22, 23, 29, 37, 38 AND 50). SN 76-090,724. PUB. 11-6-2001. FILED 7-17-2000.
- 2,533,813. **THE BOSTON BOOK REVIEW**. ALEXANDROV, STEFAN, KIRIL, (U.S. CLS. 2, 5, 22, 23, 29, 37, 38 AND 50). SN 76-094,275. PUB. 11-6-2001. FILED 7-19-2000.
- 2,533,897. **SEA RAY LIVING**. BRUNSWICK CORPORATION, (U.S. CLS. 2, 5, 22, 23, 29, 37, 38 AND 50). SN 76-140,845. PUB. 11-6-2001. FILED 10-4-2000.
- 2,533,967 (*See Class 5 for this trademark*).
- 2,534,005. **HOME GROWN. WORLD WISE.** OWENSBORO MESSENGER-INQUIRER, INC., (U.S. CLS. 2, 5, 22, 23, 29, 37, 38 AND 50). SN 76-181,618. PUB. 11-6-2001. FILED 12-15-2000.
- 2,534,091. **STATION MATE**. NEW PRODUCT SPECIALTIES GROUP, (U.S. CLS. 2, 5, 22, 23, 29, 37, 38 AND 50). SN 76-203,334. PUB. 11-6-2001. FILED 1-24-2001.
- 2,534,199. **AT HOME WITH YOUR SPECIAL CHILD AND DESIGN**. COALITION OF SOUTHERN NEW JERSEY PRIVATE SPECIAL EDUCATION SCHOOLS, INC., THE, (U.S. CLS. 2, 5, 22, 23, 29, 37, 38 AND 50). SN 76-259,084. PUB. 11-6-2001. FILED 5-18-2001.
- 2,534,202. **MINKUS AND DESIGN**. KRAUSE PUBLICATIONS, INC., (U.S. CLS. 2, 5, 22, 23, 29, 37, 38 AND 50). SN 76-263,454. PUB. 11-6-2001. FILED 5-25-2001.
- 2,534,235. **DRIVERGEAR**. VOLKSWAGEN OF AMERICA, INC., (U.S. CLS. 2, 5, 22, 23, 29, 37, 38 AND 50). SN 76-280,434. PUB. 11-6-2001. FILED 7-5-2001.
- 2,534,243. **ROLLING OUT**. STEED MEDIA GROUP, (U.S. CLS. 2, 5, 22, 23, 29, 37, 38 AND 50). SN 76-282,558. PUB. 11-6-2001. FILED 7-9-2001.
- 2,534,244. **RO**. STEED MEDIA GROUP, (U.S. CLS. 2, 5, 22, 23, 29, 37, 38 AND 50). SN 76-282,559. PUB. 11-6-2001. FILED 7-9-2001.
- 2,534,245. **YOU BETTER BE ROLLING OUT**. STEED MEDIA GROUP, (U.S. CLS. 2, 5, 22, 23, 29, 37, 38 AND 50). SN 76-282,560. PUB. 11-6-2001. FILED 7-9-2001.
- 2,534,249. **TRIBUTARIES AND DESIGN**. SOUTH CAROLINA AQUARIUM, (U.S. CLS. 2, 5, 22, 23, 29, 37, 38 AND 50). SN 76-282,779. PUB. 11-6-2001. FILED 7-11-2001.
- 2,534,275. **MACON KNIGHTS AND DESIGN**. AF2 ENTERPRISES LLC, MULTIPLE CLASS, (INT. CLS. 16, 25 AND 41), (U.S. CLS. 2, 5, 22, 23, 29, 37, 38, 39, 50, 100, 101 AND 107). SN 76-291,748. PUB. 11-13-2001. FILED 7-30-2001.
- 2,534,280. **GALACTIC GLADIATORS**. INFINITE ENTERTAINMENT GROUP CORPORATION, (U.S. CLS. 2, 5, 22, 23, 29, 37, 38 AND 50). SN 76-292,680. PUB. 11-6-2001. FILED 7-30-2001.
- 2,534,287. **GL**. GIRLS LIFE, INC., (U.S. CLS. 2, 5, 22, 23, 29, 37, 38 AND 50). SN 76-293,661. PUB. 11-6-2001. FILED 8-1-2001.
- 2,534,288. **DBIA**. DESIGN-BUILD INSTITUTE OF AMERICA, MULTIPLE CLASS, (INT. CLS. 16, 41 AND 42), (U.S. CLS. 2, 5, 22, 23, 29, 37, 38, 50, 100, 101 AND 107). SN 76-293,673. PUB. 11-6-2001. FILED 8-1-2001.
- 2,534,289. **MISCELLANEOUS DESIGN**. DESIGN-BUILD INSTITUTE OF AMERICA, MULTIPLE CLASS, (INT. CLS. 16, 41 AND 42), (U.S. CLS. 2, 5, 22, 23, 29, 37, 38, 50, 100, 101 AND 107). SN 76-293,674. PUB. 11-6-2001. FILED 8-1-2001.
- 2,534,291. **SPEEDYLOAD**. CENTURY MARKETING CORPORATION, (U.S. CLS. 2, 5, 22, 23, 29, 37, 38 AND 50). SN 76-294,367. PUB. 11-6-2001. FILED 8-2-2001.
- 2,534,293. **MISCELLANEOUS DESIGN**. AVALON PUBLISHING GROUP, INC., MULTIPLE CLASS, (INT. CLS. 16 AND 41), (U.S. CLS. 2, 5, 22, 23, 29, 37, 38, 50, 100, 101 AND 107). SN 76-295,491. PUB. 11-6-2001. FILED 8-2-2001.
- 2,534,312. **THE AMITYVILLE HORROR**. GEORGE LEE LUTZ, (U.S. CLS. 2, 5, 22, 23, 29, 37, 38 AND 50). SN 78-021,172. PUB. 11-6-2001. FILED 8-14-2000.
-
- CLASS 17—RUBBER GOODS**
- 2,533,304. **EVER-END**. JAMES DAWSON ENTERPRISES LTD., (U.S. CLS. 1, 5, 12, 13, 35 AND 50). SN 75-719,133. PUB. 11-6-2001. FILED 6-1-1999.
- 2,533,568. **SOURCELINE**. NIEDNER LIMITED, (U.S. CLS. 1, 5, 12, 13, 35 AND 50). SN 75-960,297. PUB. 11-6-2001. FILED 3-15-2000.
- 2,533,817 (*See Class 6 for this trademark*).
- 2,533,818. **CLEAN AND DESIGN**. NEW PENDULUM CORP., (U.S. CLS. 1, 5, 12, 13, 35 AND 50). SN 76-096,705. PUB. 11-6-2001. FILED 7-26-2000.
- 2,533,835. **KEEPSAFE GLASS AND DESIGN**. SOLUTIA INC., MULTIPLE CLASS, (INT. CLS. 17 AND 19), (U.S. CLS. 1, 5, 12, 13, 33, 35 AND 50). SN 76-109,769. PUB. 11-6-2001. FILED 8-14-2000.
- 2,534,151. **EASYFIT**. JOHNS MANVILLE INTERNATIONAL, INC., (U.S. CLS. 1, 5, 12, 13, 35 AND 50). SN 76-224,538. PUB. 11-6-2001. FILED 3-12-2001.
-
- CLASS 18—LEATHER GOODS**
- 2,533,397 (*See Class 3 for this trademark*).
- 2,533,729. **BEATRICE VON TRESCKOW (STYLIZED)**. BEATRICE VON TRESCKOW DESIGNS LTD., MULTIPLE CLASS, (INT. CLS. 18 AND 25), (U.S. CLS. 1, 2, 3, 22, 39 AND 41). SN 76-061,721. PUB. 11-6-2001. FILED 6-2-2000.
- 2,534,169. **BONSPEED**. BONNEVILLE WORLDWIDE, INC., (U.S. CLS. 1, 2, 3, 22 AND 41). SN 76-229,959. PUB. 11-6-2001. FILED 3-26-2001.
- 2,534,339. **CAMPUS ORGANIZER PLUS**. L. L. BEAN, INC., (U.S. CLS. 1, 2, 3, 22 AND 41). SN 78-069,600. PUB. 11-6-2001. FILED 6-18-2001.
-
- CLASS 19—NON-METALLIC BUILDING MATERIALS**
- 2,533,279. **ICE GLASS**. THERMOSEAL GLASS CORPORA-

- TION LLC, (U.S. CLS. 1, 12, 33 AND 50). SN 75-667,008. PUB. 11-6-2001. FILED 10-30-1999.
- 2,533,491. **TINSEL-LITE**. PLASPACK U.S.A., INC., MULTIPLE CLASS, (INT. CLS. 19 AND 22), (U.S. CLS. 1, 2, 7, 12, 19, 22, 33, 42 AND 50). SN 75-914,827. PUB. 11-6-2001. FILED 2-10-2000.
- 2,533,510. **VARIOBOARD AND DESIGN**. VARIOBOARD GMBH, MULTIPLE CLASS, (INT. CLS. 19 AND 20), (U.S. CLS. 1, 2, 12, 13, 22, 25, 32, 33 AND 50). SN 75-921,630. PUB. 11-6-2001. FILED 2-17-2000.
- 2,533,604. **PORTADAM AND DESIGN**. PORTADAM, INC., (U.S. CLS. 1, 12, 33 AND 50). SN 76-020,368. PUB. 11-6-2001. FILED 4-7-2000.
- 2,533,611. **PORTADAM**. PORTADAM, INC., (U.S. CLS. 1, 12, 33 AND 50). SN 76-022,428. PUB. 11-6-2001. FILED 4-7-2000.
- 2,533,817 (*See Class 6 for this trademark*).
- 2,533,835 (*See Class 17 for this trademark*).
- 2,533,873. **POOL SITTER**. POOL SITTER, INC., (U.S. CLS. 1, 12, 33 AND 50). SN 76-130,892. PUB. 11-6-2001. FILED 9-19-2000.
- 2,533,955. **LOWEX**. SOCIETE EUROPEENNE DES PRODUITS REFRACTAIRES, (U.S. CLS. 1, 12, 33 AND 50). SN 76-162,897. PUB. 11-6-2001. FILED 11-9-2000.
- 2,534,135. **POOLTITE**. C.L. INDUSTRIES, INC., (U.S. CLS. 1, 12, 33 AND 50). SN 76-214,622. PUB. 11-6-2001. FILED 2-23-2001.
- 2,534,137. **FLEXLOCK**. CERCORP INITIATIVES INC., (U.S. CLS. 1, 12, 33 AND 50). SN 76-215,817. PUB. 11-6-2001. FILED 2-27-2001.
- 2,534,238. **GROUND FLOOR**. PURCELL, DAVID L., (U.S. CLS. 1, 12, 33 AND 50). SN 76-281,333. PUB. 11-6-2001. FILED 7-6-2001.

CLASS 20—FURNITURE AND ARTICLES NOT OTHERWISE CLASSIFIED

- 2,533,277. **ICE CREAM CONTAINER WITH COVER AND DESIGN**. SEALRIGHT COMPANY, INC., (U.S. CLS. 2, 13, 22, 25, 32 AND 50). SN 75-665,761. PUB. 11-6-2001. FILED 3-22-1999.
- 2,533,278. **MISCELLANEOUS DESIGN**. SEALRIGHT COMPANY, INC., (U.S. CLS. 2, 13, 22, 25, 32 AND 50). SN 75-665,763. PUB. 11-6-2001. FILED 3-22-1999.
- 2,533,451. **ARROW**. CANADIAN ATLAS FURNITURE CORPORATION, (U.S. CLS. 2, 13, 22, 25, 32 AND 50). SN 75-891,342. PUB. 11-6-2001. FILED 1-7-2000.
- 2,533,457. **LOLANNA IGUANA**. HERBAL ANIMALS, INC., MULTIPLE CLASS, (INT. CLS. 20 AND 28), (U.S. CLS. 2, 13, 22, 23, 25, 32, 38 AND 50). SN 75-893,804. PUB. 11-6-2001. FILED 1-8-2000.
- 2,533,464. **JEAN GESTAS (STYLIZED)**. JEAN GESTAS S-A., (U.S. CLS. 2, 13, 22, 25, 32 AND 50). SN 75-898,364. PUB. 11-6-2001. FILED 1-13-2000.
- 2,533,510 (*See Class 19 for this trademark*).
- 2,533,741. **FLEXIPAK**. NYCOMED, INC., (U.S. CLS. 2, 13, 22, 25, 32 AND 50). SN 76-065,838. PUB. 11-6-2001. FILED 6-9-2000.
- 2,533,770. **PEERLESS**. PEERLESS DESIGNS LIMITED, (U.S. CLS. 2, 13, 22, 25, 32 AND 50). SN 76-077,004. PUB. 11-6-2001. FILED 6-21-2000.
- 2,533,860. **ATTITUDES**. ATTITUDES, INC., (U.S. CLS. 2, 13, 22, 25, 32 AND 50). SN 76-124,541. PUB. 11-6-2001. FILED 9-11-2000.
- 2,533,940. **CUBICON**. CUBICON CORPORATION, (U.S. CLS. 2, 13, 22, 25, 32 AND 50). SN 76-157,670. PUB. 11-6-2001. FILED 11-1-2000.
- 2,534,014. **LOUISVILLE SLUGGER FIELD**. HILLERICH & BRADSBY CO., (U.S. CLS. 2, 13, 22, 25, 32 AND 50). SN 76-183,892. PUB. 11-6-2001. FILED 12-19-2000.
- 2,534,071. **MEMORY PAC**. APOTHECARY PRODUCTS, INC., (U.S. CLS. 2, 13, 22, 25, 32 AND 50). SN 76-198,995. PUB. 11-6-2001. FILED 1-25-2001.
- 2,534,093. **ARMOR BOX CO.** ARMOR BOX COMPANY, (U.S. CLS. 2, 13, 22, 25, 32 AND 50). SN 76-203,590. PUB. 11-6-2001. FILED 2-1-2001.
- 2,534,096. **EPIC**. STRYKER MEDICAL, (U.S. CLS. 2, 13, 22, 25,

- 32 AND 50). SN 76-203,918. PUB. 11-6-2001. FILED 2-1-2001.
- 2,534,175. **VAMPIRELLA**. HARRIS PUBLICATIONS, INC., (U.S. CLS. 2, 13, 22, 25, 32 AND 50). SN 76-232,598. PUB. 11-6-2001. FILED 3-23-2001.

CLASS 21—HOUSEWARES AND GLASS

- 2,533,324 (*See Class 12 for this trademark*).
- 2,533,334. **MAMISON AND DESIGN**. MAMISON CO., LTD., (U.S. CLS. 2, 13, 23, 29, 30, 33, 40 AND 50). SN 75-769,745. PUB. 11-6-2001. FILED 8-6-1999.
- 2,533,474. **POCKET PALS**. WADE CERAMICS LIMITED, (U.S. CLS. 2, 13, 23, 29, 30, 33, 40 AND 50). SN 75-902,706. PUB. 11-6-2001. FILED 1-26-2000.
- 2,533,538. **DENISE CHAPLIN N.Y.C.** CHAPLIN, DENISE, (U.S. CLS. 2, 13, 23, 29, 30, 33, 40 AND 50). SN 75-932,940. PUB. 11-6-2001. FILED 3-2-2000.
- 2,533,602 (*See Class 2 for this trademark*).
- 2,533,665. **M AND DESIGN**. MARS, INCORPORATED, (U.S. CLS. 2, 13, 23, 29, 30, 33, 40 AND 50). SN 76-040,008. PUB. 11-6-2001. FILED 5-3-2000.
- 2,533,666. **M AND DESIGN**. MARS, INCORPORATED, (U.S. CLS. 2, 13, 23, 29, 30, 33, 40 AND 50). SN 76-040,009. PUB. 11-6-2001. FILED 5-3-2000.
- 2,533,667. **M AND DESIGN**. MARS, INCORPORATED, (U.S. CLS. 2, 13, 23, 29, 30, 33, 40 AND 50). SN 76-040,010. PUB. 11-6-2001. FILED 5-3-2000.
- 2,533,668. **M AND DESIGN**. MARS, INCORPORATED, (U.S. CLS. 2, 13, 23, 29, 30, 33, 40 AND 50). SN 76-040,013. PUB. 11-6-2001. FILED 5-3-2000.
- 2,533,678. **HI*DENSITY (STYLIZED)**. WHIRLPOOL PROPERTIES, INC., (U.S. CLS. 2, 13, 23, 29, 30, 33, 40 AND 50). SN 76-043,255. PUB. 11-6-2001. FILED 5-8-2000.
- 2,533,683. **M AND DESIGN**. MARS, INCORPORATED, (U.S. CLS. 2, 13, 23, 29, 30, 33, 40 AND 50). SN 76-045,306. PUB. 11-6-2001. FILED 5-10-2000.
- 2,533,685. **M AND DESIGN**. MARS, INCORPORATED, (U.S. CLS. 2, 13, 23, 29, 30, 33, 40 AND 50). SN 76-046,102. PUB. 11-6-2001. FILED 5-11-2000.
- 2,533,686. **M AND DESIGN**. MARS, INCORPORATED, (U.S. CLS. 2, 13, 23, 29, 30, 33, 40 AND 50). SN 76-046,103. PUB. 11-6-2001. FILED 5-11-2000.
- 2,533,687. **M AND DESIGN**. MARS, INCORPORATED, (U.S. CLS. 2, 13, 23, 29, 30, 33, 40 AND 50). SN 76-046,104. PUB. 11-6-2001. FILED 5-11-2000.
- 2,533,688. **M AND DESIGN**. MARS, INCORPORATED, (U.S. CLS. 2, 13, 23, 29, 30, 33, 40 AND 50). SN 76-046,105. PUB. 11-6-2001. FILED 5-11-2000.
- 2,533,689. **M AND DESIGN**. MARS, INCORPORATED, (U.S. CLS. 2, 13, 23, 29, 30, 33, 40 AND 50). SN 76-046,106. PUB. 11-6-2001. FILED 5-11-2000.
- 2,533,771. **TEALUXE**. TEALUXE, INC., MULTIPLE CLASS, (INT. CLS. 21, 30, 35 AND 42), (U.S. CLS. 2, 13, 23, 29, 30, 33, 40, 46, 50, 100, 101 AND 102). SN 76-077,664. PUB. 11-6-2001. FILED 6-22-2000.
- 2,533,794. **QUEENWOOD AND DESIGN**. QUEENWOOD DEVELOPMENT INC., (U.S. CLS. 2, 13, 23, 29, 30, 33, 40 AND 50). SN 76-086,967. PUB. 11-6-2001. FILED 7-12-2000.
- 2,533,807. **BIONDA BRUNA HANDMADE IN ITALY WWW.BIONDA-BRUNA.COM AND DESIGN**. BIONDA-BRUNA, LLC, (U.S. CLS. 2, 13, 23, 29, 30, 33, 40 AND 50). SN 76-092,272. PUB. 11-6-2001. FILED 7-20-2000.
- 2,533,868. **FLOSSTRAW (STYLIZED)**. KAMINSKI, BASIA, (U.S. CLS. 2, 13, 23, 29, 30, 33, 40 AND 50). SN 76-129,091. PUB. 11-6-2001. FILED 9-18-2000.
- 2,533,896. **LC AND DESIGN**. LA COSTA COMPANY LP, THE, (U.S. CLS. 2, 13, 23, 29, 30, 33, 40 AND 50). SN 76-140,007. PUB. 11-6-2001. FILED 10-3-2000.
- 2,534,010 (*See Class 4 for this trademark*).
- 2,534,026. **THE BAIT HOUSE AND DESIGN**. GREEN, WILLIAM F., (U.S. CLS. 2, 13, 23, 29, 30, 33, 40 AND 50). SN 76-185,909. PUB. 11-6-2001. FILED 12-21-2000.
- 2,534,136. **TIMELESS MESSAGE AND DESIGN**. TROTT, MICHAEL W., (U.S. CLS. 2, 13, 23, 29, 30, 33, 40 AND 50). SN 76-214,959. PUB. 11-6-2001. FILED 2-23-2001.
- 2,534,142. **PROPIZIO**. INNOVA INC., (U.S. CLS. 2, 13, 23, 29,

30, 33, 40 AND 50). SN 76-220,495. PUB. 11-6-2001. FILED 3-6-2001.
 2,534,145. **PROPIZIO GOLD**. INNOVA INC., (U.S. CLS. 2, 13, 23, 29, 30, 33, 40 AND 50). SN 76-220,583. PUB. 11-6-2001. FILED 3-6-2001.
 2,534,153. **FRIENDSHIP ROSE DINNERWARE**. HERITAGE MINT, LTD., (U.S. CLS. 2, 13, 23, 29, 30, 33, 40 AND 50). SN 76-224,836. PUB. 11-6-2001. FILED 3-15-2001.
 2,534,158. **SMART SCOOP AND DESIGN**. BRADSHAW INTERNATIONAL, INC., (U.S. CLS. 2, 13, 23, 29, 30, 33, 40 AND 50). SN 76-226,466. PUB. 11-6-2001. FILED 3-16-2001.
 2,534,193. **MAGNALITE CLASSIC**. WKI HOLDING COMPANY, INC., (U.S. CLS. 2, 13, 23, 29, 30, 33, 40 AND 50). SN 76-241,185. PUB. 11-6-2001. FILED 4-16-2001.

CLASS 22—CORDAGE AND FIBERS

2,533,491 (*See Class 19 for this trademark*).
 2,533,927. **CURB-TOP**. CURB-TOP CO., (U.S. CLS. 1, 2, 7, 19, 22, 42 AND 50). SN 76-154,736. PUB. 11-6-2001. FILED 10-30-2000.

CLASS 24—FABRICS

2,533,309. **FUN REPUBLIC**. FARCA, EDUARDO COHEN, AND KAMAJI, ELIAS COHEN, MULTIPLE CLASS, (INT. CLS. 24 AND 25), (U.S. CLS. 22, 39, 42 AND 50). SN 75-726,645. PUB. 11-6-2001. FILED 6-11-1999.
 2,533,322. **MANERS CLUB**. FARCA, EDUARDO COHEN, AND KAMAJI, ELIAS COHEN, MULTIPLE CLASS, (INT. CLS. 24 AND 25), (U.S. CLS. 22, 39, 42 AND 50). SN 75-745,784. PUB. 11-6-2001. FILED 7-8-1999.
 2,533,397 (*See Class 3 for this trademark*).
 2,533,694. **ULTRAMESH**. ULTRAFLEX SYSTEMS, INC., (U.S. CLS. 42 AND 50). SN 76-049,090. PUB. 11-6-2001. FILED 5-16-2000.
 2,533,738. **COUNTLESS COLORS**. RAYLON CORPORATION, THE, (U.S. CLS. 42 AND 50). SN 76-063,583. PUB. 11-6-2001. FILED 6-5-2000.
 2,534,174. **MISCELLANEOUS DESIGN**. CONSOLTEX INC., (U.S. CLS. 42 AND 50). SN 76-232,262. PUB. 11-6-2001. FILED 3-28-2001.
 2,534,214. **INFINITY**. HIGHLAND INDUSTRIES, INC., (U.S. CLS. 42 AND 50). SN 76-272,353. PUB. 11-6-2001. FILED 6-16-2001.

CLASS 25—CLOTHING

2,533,213. **JOB RATED AND DESIGN**. KODIAK GROUP INC., BY ASSIGNMENT GREB INTERNATIONAL AND COMPANY, (U.S. CLS. 22 AND 39). SN 75-458,769. PUB. 11-6-2001. FILED 3-30-1998.
 2,533,270. **THE REFEREE'S CALL AND DESIGN**. REFEREE'S CALL, THE, MULTIPLE CLASS, (INT. CLS. 25 AND 28), (U.S. CLS. 22, 23, 38, 39 AND 50). SN 75-646,969. PUB. 11-6-2001. FILED 2-23-1999.
 2,533,292. **MISCELLANEOUS DESIGN**. THRONEBURG, JAMES L., (U.S. CLS. 22 AND 39). SN 75-700,942. PUB. 11-6-2001. FILED 5-7-1999.
 2,533,309 (*See Class 24 for this trademark*).
 2,533,321. **L'ADYS SPORTS WEAR AND DESIGN**. ARMOUR, TYRONE, (U.S. CLS. 22 AND 39). SN 75-742,681. PUB. 11-6-2001. FILED 7-1-1999.
 2,533,322 (*See Class 24 for this trademark*).
 2,533,338. **3 3RD COAST VOLLEYBALL CHAMPIONSHIPS AND DESIGN**. JUNIOR VOLLEYBALL ASSOCIATION OF AUSTIN, (U.S. CLS. 22 AND 39). SN 75-775,805. PUB. 11-6-2001. FILED 8-6-1999.
 2,533,347. **CATHOLIC UNIVERSITY AND DESIGN**. CATHOLIC UNIVERSITY OF AMERICA, THE, (U.S. CLS. 22 AND 39). SN 75-786,133. PUB. 11-6-2001. FILED 8-27-1999.

2,533,397 (*See Class 3 for this trademark*).
 2,533,485. **BETTY'S AND DESIGN**. DALLAPE, DONALD A., BY CHANGE OF NAME LAGUNA APPAREL, INC., (U.S. CLS. 22 AND 39). SN 75-907,374. PUB. 11-6-2001. FILED 2-1-2000.
 2,533,494 (*See Class 14 for this trademark*).
 2,533,701. **DRYZ INTELLITEMP**. H.H. BROWN SHOE TECHNOLOGIES, INC., (U.S. CLS. 22 AND 39). SN 76-051,993. PUB. 11-6-2001. FILED 5-10-2000.
 2,533,729 (*See Class 18 for this trademark*).
 2,533,751 (*See Class 1 for this trademark*).
 2,533,773. **&**. NORTHPORT APPAREL, INC., (U.S. CLS. 22 AND 39). SN 76-077,678. PUB. 3-6-2001. FILED 6-26-2000.
 2,533,793 (*See Class 5 for this trademark*).
 2,533,952. **FIESTA DEL MERCADO**. FIESTAS MARKET SQUARE, INC., (U.S. CLS. 22 AND 39). SN 76-161,645. PUB. 11-6-2001. FILED 11-8-2000.
 2,533,984. **ESPN GREAT OUTDOOR GAMES AND DESIGN**. ESPN, INC., (U.S. CLS. 22 AND 39). SN 76-173,454. PUB. 11-6-2001. FILED 11-30-2000.
 2,533,985. **ESPN GREAT OUTDOOR GAMES**. ESPN, INC., (U.S. CLS. 22 AND 39). SN 76-173,455. PUB. 11-6-2001. FILED 11-30-2000.
 2,534,088. **DIGITAL DOMAIN**. DIGITAL DOMAIN, INC., (U.S. CLS. 22 AND 39). SN 76-202,547. PUB. 11-6-2001. FILED 1-19-2001.
 2,534,100. **DIGITAL DOMAIN AND DESIGN**. DIGITAL DOMAIN, INC., (U.S. CLS. 22 AND 39). SN 76-204,882. PUB. 11-6-2001. FILED 1-22-2001.
 2,534,134. **SNIBBIE**. HEARD, GREG, (U.S. CLS. 22 AND 39). SN 76-214,282. PUB. 11-6-2001. FILED 2-23-2001.
 2,534,171. **DREAM DANCE DANCE TO THE RHYTHM OF YOUR SOUL AND DESIGN**. LINE ART, INC., (U.S. CLS. 22 AND 39). SN 76-231,106. PUB. 11-6-2001. FILED 3-26-2001.
 2,534,188. **CLASSIC GIRL**. AMERICAN APPAREL, LLC, (U.S. CLS. 22 AND 39). SN 76-238,625. PUB. 11-6-2001. FILED 4-9-2001.
 2,534,189. **CLASSIC BABY**. AMERICAN APPAREL, LLC, (U.S. CLS. 22 AND 39). SN 76-238,648. PUB. 11-6-2001. FILED 4-9-2001.
 2,534,190. **STANDARD AMERICAN**. AMERICAN APPAREL, LLC, (U.S. CLS. 22 AND 39). SN 76-238,649. PUB. 11-6-2001. FILED 4-9-2001.
 2,534,210. **VOLCOM**. STONE BOARDWEAR, INC., (U.S. CLS. 22 AND 39). SN 76-269,086. PUB. 11-6-2001. FILED 6-8-2001.
 2,534,275 (*See Class 16 for this trademark*).
 2,534,309. **MISCELLANEOUS DESIGN**. THOROUGHNBRED CLASSICS, LLC, (U.S. CLS. 22 AND 39). SN 78-017,273. PUB. 11-6-2001. FILED 7-18-2000.
 2,534,337. **UVP ULTRAVIOLET PROTECTION AND DESIGN**. SPORTIF USA, INC., (U.S. CLS. 22 AND 39). SN 78-067,948. PUB. 11-6-2001. FILED 6-7-2001.
 2,534,338. **DAVID SHEFFIELD**. SHEFFIELD, DAVID A., (U.S. CLS. 22 AND 39). SN 78-069,530. PUB. 11-6-2001. FILED 6-17-2001.

CLASS 26—FANCY GOODS

2,533,789. **DISTINCTIVE DESIGNS**. DISTINCTIVE DESIGNS INTERNATIONAL, INC., MULTIPLE CLASS, (INT. CLS. 26 AND 31), (U.S. CLS. 1, 37, 39, 40, 42, 46 AND 50). SN 76-085,179. PUB. 9-25-2001. FILED 7-7-2000.
 2,533,981. **S T X**. SRITEX (HONG KONG) LIMITED, (U.S. CLS. 37, 39, 40, 42 AND 50). SN 76-172,644. PUB. 11-6-2001. FILED 11-29-2000.

CLASS 28—TOYS AND SPORTING GOODS

2,533,270 (*See Class 25 for this trademark*).
 2,533,386. **ROLLING 21**. SILVA, THOMAS, (U.S. CLS. 22, 23, 38 AND 50). SN 75-848,143. PUB. 11-6-2001. FILED 11-15-1999.
 2,533,457 (*See Class 20 for this trademark*).
 2,533,550 (*See Class 10 for this trademark*).

- 2,533,602 (*See Class 2 for this trademark*).
 2,533,612. **THE ROBBIE DEAN COLLECTIBLES**. HAYES-SCOTT, FAIRY C., (U.S. CLS. 22, 23, 38 AND 50). SN 76-022,460. PUB. 11-6-2001. FILED 4-4-2000.
 2,533,756. **MASTER PLAN TURNKEY FITNESS PROGRAMS AND DESIGN**. BODY MASTERS SPORTS INDUSTRIES, INC., MULTIPLE CLASS, (INT. CLS. 28 AND 41), (U.S. CLS. 22, 23, 38, 50, 100, 101 AND 107). SN 76-071,348. PUB. 11-6-2001. FILED 6-12-2000.
 2,533,861. **XTREME RIDERZ AND DESIGN**. XTREME RIDERZ, (U.S. CLS. 22, 23, 38 AND 50). SN 76-124,776. PUB. 11-6-2001. FILED 9-11-2000.
 2,533,886. **ZOOM**. ROLLERBLADE, INC., (U.S. CLS. 22, 23, 38 AND 50). SN 76-135,983. PUB. 11-6-2001. FILED 9-22-2000.
 2,533,933 (*See Class 10 for this trademark*).
 2,534,036. **GL3**. G. LOOMIS, INC., (U.S. CLS. 22, 23, 38 AND 50). SN 76-189,742. PUB. 11-6-2001. FILED 1-4-2001.
 2,534,138. **RICE OWLS AND DESIGN**. WILLIAM MARSH RICE UNIVERSITY, (U.S. CLS. 22, 23, 38 AND 50). SN 76-216,250. PUB. 11-6-2001. FILED 2-26-2001.
 2,534,220. **WINDANSEA**. FLYNN, JIM, AND FLYNN, JACK, (U.S. CLS. 22, 23, 38 AND 50). SN 76-275,179. PUB. 11-6-2001. FILED 6-25-2001.
 2,534,278. **SCENTHEAD**. CRAFTY'S FEATHERWORKS, INC., (U.S. CLS. 22, 23, 38 AND 50). SN 76-292,277. PUB. 11-6-2001. FILED 7-30-2001.
 2,534,344. **MILK-BONE AND DESIGN**. NABISCO BRANDS COMPANY, (U.S. CLS. 22, 23, 38 AND 50). SN 78-072,491. PUB. 11-6-2001. FILED 7-5-2001.

CLASS 29—MEATS AND PROCESSED FOODS

- 2,533,202. **QUEEN'S GATE**. BASCOM CORPORATION, MULTIPLE CLASS, (INT. CLS. 29 AND 30), (U.S. CL. 46). SN 75-375,408. PUB. 11-6-2001. FILED 10-22-1997.
 2,533,237. **REDNECK RINDS**. REDNECK FOODS, INC., (U.S. CL. 46). SN 75-562,817. PUB. 11-6-2001. FILED 10-1-1998.
 2,533,412. **TAPIOCAEXPRESS AND DESIGN**. QUICKLY U.S.A. SNACK BAR, INC., MULTIPLE CLASS, (INT. CLS. 29 AND 32), (U.S. CLS. 45, 46 AND 48). SN 75-867,669. PUB. 11-6-2001. FILED 12-9-1999.
 2,533,507. **UNCLE LEM'S AND DESIGN**. RACHELS, LEM, DBA UNCLE LEM'S, (U.S. CL. 46). SN 75-920,821. PUB. 11-6-2001. FILED 2-16-2000.
 2,533,540. **GOTTA HAVE CHICKEN TERIYAKI**. PILLSBURY COMPANY, THE, (U.S. CL. 46). SN 75-935,220. PUB. 11-6-2001. FILED 2-16-2000.
 2,533,577. **MILLIE'S**. GARAN ENTERPRISES, INC., DBA MILLIE'S PIEROGI, MULTIPLE CLASS, (INT. CLS. 29 AND 30), (U.S. CL. 46). SN 76-005,520. PUB. 11-6-2001. FILED 3-20-2000.
 2,533,614. **LOWER FOODS**. LOWER PACKING CO., INC., (U.S. CL. 46). SN 76-023,782. PUB. 11-6-2001. FILED 4-11-2000.
 2,533,703. **GERMAN GOURMET AND DESIGN**. LOMNITZ, FEDERICO B., (U.S. CL. 46). SN 76-052,886. PUB. 11-6-2001. FILED 5-22-2000.
 2,533,718. **AUSTRALIAN MACADAMIAS AND DESIGN**. AUSTRALIAN MACADAMIA SOCIETY LIMITED, (U.S. CL. 46). SN 76-057,254. PUB. 11-6-2001. FILED 5-18-2000.
 2,533,723. **BENTO ICHIBAN**. AZUMA FOODS INTERNATIONAL, INC. U.S.A., (U.S. CL. 46). SN 76-059,155. PUB. 11-6-2001. FILED 5-30-2000.
 2,533,766. **RISHON GLATT KOSHER**. SARAMAR, L.L.C., (U.S. CL. 46). SN 76-075,462. PUB. 11-6-2001. FILED 6-22-2000.
 2,533,812. **MISCELLANEOUS DESIGN**. MR. CONTAINER, (U.S. CL. 46). SN 76-093,992. PUB. 11-6-2001. FILED 7-21-2000.
 2,533,849. **MISCELLANEOUS DESIGN**. DANNON COMPANY, INC., THE, (U.S. CL. 46). SN 76-118,739. PUB. 11-6-2001. FILED 8-28-2000.
 2,533,850. **MISCELLANEOUS DESIGN**. DANNON COMPANY, INC., THE, (U.S. CL. 46). SN 76-118,740. PUB. 11-6-2001. FILED 8-28-2000.
 2,533,851. **MISCELLANEOUS DESIGN**. DANNON COM-

- PANY, INC., THE, (U.S. CL. 46). SN 76-118,741. PUB. 11-6-2001. FILED 8-28-2000.
 2,533,921. **BLENDERS BEST AND DESIGN**. DE FRANCESCO & SONS, INC., (U.S. CL. 46). SN 76-152,044. PUB. 11-6-2001. FILED 10-23-2000.
 2,534,018. **HORS D'OEUVRES UNLIMITED**. HORS D'OEUVRES UNLIMITED, (U.S. CL. 46). SN 76-184,358. PUB. 11-6-2001. FILED 12-20-2000.
 2,534,025. **CROQ'PLAT (STYLIZED)**. LIDL STIFTUNG & CO. KG, (U.S. CL. 46). SN 76-185,876. PUB. 11-6-2001. FILED 12-22-2000.
 2,534,030. **BUTTERMILK BUDS**. CUMBERLAND PACKING CORP., (U.S. CL. 46). SN 76-186,968. PUB. 11-6-2001. FILED 12-27-2000.
 2,534,068. **JAVADELIC**. P.J. BEAN CO., INC., MULTIPLE CLASS, (INT. CLS. 29, 30 AND 32), (U.S. CLS. 45, 46 AND 48). SN 76-198,123. PUB. 11-6-2001. FILED 1-22-2001.
 2,534,069. **mitsutoyo**. MITSUTOYO CO., LTD., (U.S. CL. 46). SN 76-198,192. PUB. 11-6-2001. FILED 1-17-2001.
 2,534,132. **SQUIRE MOUNTAIN**. MESERVE, PAUL J., (U.S. CL. 46). SN 76-213,959. PUB. 11-6-2001. FILED 2-21-2001.
 2,534,155. **ZAPPERS STUFFED JALAPENOS (STYLIZED)**. MILLENNIUM CUSTOM FOODS, INC., (U.S. CL. 46). SN 76-225,085. PUB. 11-6-2001. FILED 3-15-2001.
 2,534,173. **SUNWIN JUMBO! AND DESIGN**. BRAYWOOD LIMITED, (U.S. CL. 46). SN 76-231,975. PUB. 11-6-2001. FILED 3-28-2001.
 2,534,177. **OVEN FAVORITES**. GENERAL MILLS, INC., (U.S. CL. 46). SN 76-234,230. PUB. 11-6-2001. FILED 4-3-2001.
 2,534,218. **MISCELLANEOUS DESIGN**. RHEE BROS., INC., (U.S. CL. 46). SN 76-275,103. PUB. 11-6-2001. FILED 6-22-2001.
 2,534,256. **TRU-FILET**. PERDUE HOLDINGS, INC., (U.S. CL. 46). SN 76-284,923. PUB. 11-6-2001. FILED 7-12-2001.
 2,534,323. **SMILE! YOU'VE GOT FRENCH'S**. RECKITT BENCKISER INC., MULTIPLE CLASS, (INT. CLS. 29 AND 30), (U.S. CL. 46). SN 78-047,292. PUB. 11-6-2001. FILED 2-8-2001.

CLASS 30—STAPLE FOODS

- 2,533,192. **PINK THING**. SIX FLAGS THEME PARKS INC., (U.S. CL. 46). SN 75-012,286. PUB. 11-6-2001. FILED 10-30-1995.
 2,533,197. **BRANTREATS**. YZ ENTERPRISES, INC., (U.S. CL. 46). SN 75-262,976. PUB. 11-6-2001. FILED 3-24-1997.
 2,533,202 (*See Class 29 for this trademark*).
 2,533,294. **THE ROYAL HEALTH TREATMENT**. NONU INC., (U.S. CL. 46). SN 75-703,094. PUB. 11-6-2001. FILED 5-11-1999.
 2,533,313. **HUNGRY? ORDER ONLINE PIZZAINN.COM AND DESIGN**. PIZZA INN, INC., MULTIPLE CLASS, (INT. CLS. 30, 35 AND 42), (U.S. CLS. 46, 100, 101 AND 102). SN 75-733,406. PUB. 11-6-2001. FILED 6-11-1999.
 2,533,329. **SPX AND DESIGN**. HOLDER, FRANCIS, MULTIPLE CLASS, (INT. CLS. 30 AND 42), (U.S. CLS. 46, 100 AND 101). SN 75-761,225. PUB. 11-6-2001. FILED 7-26-1999.
 2,533,342. **MISCELLANEOUS DESIGN**. DONSUEMOR, INC., (U.S. CL. 46). SN 75-781,255. PUB. 11-6-2001. FILED 8-20-1999.
 2,533,400 (*See Class 5 for this trademark*).
 2,533,401. **ALASKA'S OWN**. ALASKA PRIDE BAKERY COMPANY LLC, (U.S. CL. 46). SN 75-862,199. PUB. 11-6-2001. FILED 12-1-1999.
 2,533,460. **SCHMOJOE**. SCHMOJOE, INC., BY ASSIGNMENT HEBERT, JAMES P., DBA "SCHMOJOE", (U.S. CL. 46). SN 75-894,901. PUB. 11-6-2001. FILED 1-13-2000.
 2,533,479. **UN MOT EN CHOCOLAT**. SONAFI S.A., (U.S. CL. 46). SN 75-904,330. PUB. 11-6-2001. FILED 1-27-2000.
 2,533,500. **AFRICANA**. DIAZ, RAFAEL, (U.S. CL. 46). SN 75-918,092. PUB. 11-6-2001. FILED 2-5-2000.
 2,533,541. **GIMME GIMME GARLIC CHICKEN PASTA**. PILLSBURY COMPANY, THE, (U.S. CL. 46). SN 75-935,227. PUB. 11-6-2001. FILED 2-16-2000.
 2,533,542. **PLEASE PASS THE CHICKEN ALFREDO**. PILLSBURY COMPANY, THE, (U.S. CL. 46). SN 75-935,231. PUB.

- 11-6-2001. FILED 2-16-2000.
- 2,533,572. **VONS**. VONS COMPANIES, INC., THE, (U.S. CL. 46). SN 76-000,741. PUB. 11-6-2001. FILED 3-2-2000.
- 2,533,577 (*See Class 29 for this trademark*).
- 2,533,579. **TFC AND DESIGN**. THOMPSON, ERNEST J., DBA THOMPSON FOOD COMPANY, (U.S. CL. 46). SN 76-006,048. PUB. 11-6-2001. FILED 3-21-2000.
- 2,533,581. **CHEF-ASSIST FLAVOR COMPLIMENTS AND DESIGN**. FLAVOR DYNAMICS, INC., (U.S. CL. 46). SN 76-006,489. PUB. 11-6-2001. FILED 3-22-2000.
- 2,533,584. **MUHLBROT AND DESIGN**. EURO-AMERICAN BRANDS, LLC, (U.S. CL. 46). SN 76-007,429. PUB. 11-6-2001. FILED 3-22-2000.
- 2,533,644. **JENSEN'S ORCHARD**. SNAK KING CORP., (U.S. CL. 46). SN 76-035,620. PUB. 11-6-2001. FILED 4-26-2000.
- 2,533,719. **ARCTIC CLASSIC**. ALLIED MARKETING, INC., (U.S. CL. 46). SN 76-057,420. PUB. 5-15-2001. FILED 5-26-2000.
- 2,533,727. **STAR CONCEPT**. U L CANADA INC., (U.S. CL. 46). SN 76-061,301. PUB. 11-6-2001. FILED 6-1-2000.
- 2,533,730. **MISCELLANEOUS DESIGN**. INCLAN ENTERPRISES, INC., DBA BOURBON COUNTRY, INC., (U.S. CL. 46). SN 76-061,819. PUB. 11-6-2001. FILED 6-2-2000.
- 2,533,732. **MAINE BLACK BEAR**. GIFFORD'S DAIRY, INC., (U.S. CL. 46). SN 76-061,955. PUB. 11-6-2001. FILED 6-2-2000.
- 2,533,733. **GIFFORD'S**. GIFFORD'S DAIRY, INC., (U.S. CL. 46). SN 76-061,956. PUB. 11-6-2001. FILED 6-2-2000.
- 2,533,771 (*See Class 21 for this trademark*).
- 2,533,825. **MASSA**. ME AND GIA, INC., MULTIPLE CLASS, (INT. CLS. 30 AND 42), (U.S. CLS. 46, 100 AND 101). SN 76-102,665. PUB. 11-6-2001. FILED 8-3-2000.
- 2,533,827. **COUNTER CULTURE COFFEE**. COUNTER CULTURE COFFEE, INC., (U.S. CL. 46). SN 76-103,968. PUB. 11-6-2001. FILED 8-7-2000.
- 2,533,842. **MISCELLANEOUS DESIGN**. HAIN CELESTIAL GROUP, INC., THE, (U.S. CL. 46). SN 76-115,039. PUB. 11-6-2001. FILED 8-23-2000.
- 2,533,898. **SHULA'S SPECIAL NO. 347 STEAK SAUCE**. S/Y ASSOCIATES, LTD., (U.S. CL. 46). SN 76-141,567. PUB. 11-6-2001. FILED 10-6-2000.
- 2,533,901. **CC'S COFFEE AND DESIGN**. COMMUNITY COFFEE COMPANY, L.L.C., (U.S. CL. 46). SN 76-142,277. PUB. 11-6-2001. FILED 10-6-2000.
- 2,533,906. **RICHARDSON AND DESIGN**. RICHARDSON BRANDS COMPANY, (U.S. CL. 46). SN 76-145,208. PUB. 11-6-2001. FILED 10-12-2000.
- 2,533,918. **L.J. SAMPSON'S PLEASING PASTRIES & GOURMET GIFT BASKETS**. L.J. SAMPSON'S PLEASING PASTRIES & GOURMET GIFT BASKETS, INC., MULTIPLE CLASS, (INT. CLS. 30 AND 35), (U.S. CLS. 46, 100, 101 AND 102). SN 76-150,046. PUB. 11-6-2001. FILED 10-19-2000.
- 2,533,954. **JUDY'S HANDMADE THE OLD FASHION WAY AND DESIGN**. JUDY'S CANDY COMPANY, (U.S. CL. 46). SN 76-162,857. PUB. 11-6-2001. FILED 11-10-2000.
- 2,533,970. **DELUCA AND DESIGN**. PERDUE HOLDINGS, INC., (U.S. CL. 46). SN 76-168,527. PUB. 11-6-2001. FILED 11-20-2000.
- 2,533,972. **BAMAPIE HERITAGE COLLECTION**. BAMA COMPANIES, INC., THE, MULTIPLE CLASS, (INT. CLS. 30 AND 35), (U.S. CLS. 46, 100, 101 AND 102). SN 76-168,965. PUB. 11-6-2001. FILED 11-2-2000.
- 2,533,980. **UVVW DECAF**. COFFEE PROCESS TECHNOLOGY CORPORATION, (U.S. CL. 46). SN 76-172,120. PUB. 11-6-2001. FILED 11-28-2000.
- 2,533,991. **THE BAMAPIE KITCHEN**. BAMA COMPANIES, INC., THE, MULTIPLE CLASS, (INT. CLS. 30, 35 AND 41), (U.S. CLS. 46, 100, 101, 102 AND 107). SN 76-175,487. PUB. 11-6-2001. FILED 12-5-2000.
- 2,534,043. **MISCELLANEOUS DESIGN**. MOMONOYA HONPO, CO., LTD., (U.S. CL. 46). SN 76-191,860. PUB. 11-6-2001. FILED 1-9-2001.
- 2,534,053. **YOHAY BAKING COMPANY AND DESIGN**. YOHAY BAKING COMPANY INC., (U.S. CL. 46). SN 76-194,075. PUB. 11-6-2001. FILED 1-12-2001.
- 2,534,068 (*See Class 29 for this trademark*).
- 2,534,074. **DON'T STRIKE OUT, GET A LITTLE SLUGGER**. MAJOR MARKETING, INC., (U.S. CL. 46). SN 76-199,150. PUB. 11-6-2001. FILED 1-25-2001.
- 2,534,081. **GOURMET CINNAMON ROLLS MADE WITH REAL CREAM CHEESE TOPPING KAFE HOUSE LIFE'S ULTIMATE CINNAMON SWEET TREAT AND DESIGN**. WILLIS MARKETING, DBA KAFE FOODS, INC., (U.S. CL. 46). SN 76-200,865. PUB. 11-6-2001. FILED 1-25-2001.
- 2,534,083. **WE RISE. EVERYBODY SHINES.** BURNS PHILP FOOD INC., (U.S. CL. 46). SN 76-202,141. PUB. 11-6-2001. FILED 1-30-2001.
- 2,534,103. **FIRESIDE COFFEE AND DESIGN**. FIRESIDE COFFEE COMPANY, INC., (U.S. CL. 46). SN 76-205,590. PUB. 11-6-2001. FILED 2-6-2001.
- 2,534,104. **KID CHIP**. SARAH SMITH'S OLD FASHIONED COOKIES, INC., (U.S. CL. 46). SN 76-206,969. PUB. 11-6-2001. FILED 2-8-2001.
- 2,534,105. **PAR FOUR**. SARAH SMITH'S OLD FASHIONED COOKIES, INC., (U.S. CL. 46). SN 76-206,970. PUB. 11-6-2001. FILED 2-8-2001.
- 2,534,128. **CARLS SINCE 1937 AND DESIGN**. CARLS COCKTAIL LOUNGE SUPPLIES, INC., (U.S. CL. 46). SN 76-212,496. PUB. 11-6-2001. FILED 2-20-2001.
- 2,534,143. **FAT MAN & LITTLE BOY**. HODGES, JESSE T., AND BAKARICH, PETER A., AND BAKARICH, ALEXANDRA C., (U.S. CL. 46). SN 76-220,513. PUB. 11-6-2001. FILED 3-5-2001.
- 2,534,148. **BEE AND DESIGN**. QUEEN BEE GARDENS, LTD., (U.S. CL. 46). SN 76-223,018. PUB. 11-6-2001. FILED 3-12-2001.
- 2,534,149. **BIG BOOMIN' POPS**. KELLOGG COMPANY, (U.S. CL. 46). SN 76-223,357. PUB. 11-6-2001. FILED 3-12-2001.
- 2,534,159. **ALLGOODE ORGANICS AND DESIGN**. ALLGOODE NATURAL FOOD & BEVERAGES, INC., (U.S. CL. 46). SN 76-226,564. PUB. 11-6-2001. FILED 3-16-2001.
- 2,534,164. **PROUD TO BE FARMER OWNED**. FARMLAND INDUSTRIES, INC., (U.S. CL. 46). SN 76-228,307. PUB. 11-6-2001. FILED 3-21-2001.
- 2,534,186. **TRUFFLE HOUND**. AGROHANS, INC., (U.S. CL. 46). SN 76-237,658. PUB. 11-6-2001. FILED 4-6-2001.
- 2,534,247. **BUNNYETTES**. R.M. PALMER COMPANY, (U.S. CL. 46). SN 76-282,752. PUB. 11-6-2001. FILED 7-9-2001.
- 2,534,248. **LA MONITA**. GRUMA CORPORATION, (U.S. CL. 46). SN 76-282,768. PUB. 11-6-2001. FILED 7-9-2001.
- 2,534,251. **HANKA**. HFP ACQUISITION CORPORATION, (U.S. CL. 46). SN 76-283,995. PUB. 11-6-2001. FILED 7-12-2001.
- 2,534,255. **MAKE-IT-EASY**. RIVIANA FOODS INC., (U.S. CL. 46). SN 76-284,882. PUB. 11-6-2001. FILED 7-13-2001.
- 2,534,276. **BURRIZZA**. LUIGI'S PIZZA FACTORY, LTD, (U.S. CL. 46). SN 76-291,821. PUB. 11-6-2001. FILED 7-30-2001.
- 2,534,323 (*See Class 29 for this trademark*).

CLASS 31—NATURAL AGRICULTURAL PRODUCTS

- 2,533,281. **DITTOLYNX**. DITTO, FRANK ROBERT, (U.S. CLS. 1 AND 46). SN 75-667,777. PUB. 11-6-2001. FILED 3-25-1999.
- 2,533,400 (*See Class 5 for this trademark*).
- 2,533,452. **NADAL DE ANECOOP NADAL OF ANECOOP**. ANECOOP S. COOP., (U.S. CLS. 1 AND 46). SN 75-891,577. PUB. 11-6-2001. FILED 1-7-2000.
- 2,533,671. **ZEAGERMULCH**. ZEAGER BROTHERS, INC., (U.S. CLS. 1 AND 46). SN 76-041,792. PUB. 11-6-2001. FILED 5-8-2000.
- 2,533,789 (*See Class 26 for this trademark*).
- 2,533,828. **PURR**. PROMARK INTERNATIONAL, INC., (U.S. CLS. 1 AND 46). SN 76-105,110. PUB. 11-6-2001. FILED 8-9-2000.
- 2,533,840. **BE WISE RANCH**. BE WISE RANCH, (U.S. CLS. 1 AND 46). SN 76-114,160. PUB. 11-6-2001. FILED 8-21-2000.
- 2,533,882. **BENCHMARK GROWERS AND DESIGN**. QUEENS FLOWERS, INC., THE, (U.S. CLS. 1 AND 46). SN 76-133,923. PUB. 11-6-2001. FILED 9-22-2000.
- 2,533,964. **MISCELLANEOUS DESIGN**. BOYER, CATHERINE L, (U.S. CLS. 1 AND 46). SN 76-164,887. PUB. 11-6-2001. FILED 11-13-2000.
- 2,534,042. **CHIX PACK**. BLUE GRANITE CORPORATION,

- AKA BGC PET FOODS, (U.S. CLS. 1 AND 46). SN 76-191,853. PUB. 11-6-2001. FILED 12-27-2000.
- 2,534,073. **SECOND NATURE AND DESIGN**. CENTRAL FIBER CORPORATION, (U.S. CLS. 1 AND 46). SN 76-199,023. PUB. 11-6-2001. FILED 1-24-2001.
- 2,534,163. **SUNGRAZER**. FIFIELD LAND COMPANY, (U.S. CLS. 1 AND 46). SN 76-227,632. PUB. 11-6-2001. FILED 3-20-2001.
- 2,534,191. **COBRA AND DESIGN**. SANTA ROSA TROPICALS, (U.S. CLS. 1 AND 46). SN 76-239,042. PUB. 11-6-2001. FILED 4-12-2001.
- 2,534,270. **WESTERN SUNSETS**. COLOR STAR GROWERS, INC., (U.S. CLS. 1 AND 46). SN 76-290,039. PUB. 11-6-2001. FILED 7-25-2001.

CLASS 32—LIGHT BEVERAGES

- 2,533,190. **RICKARD'S RED RR DRAUGHT E.A. RICKARD AND DESIGN**. MOLSON BREWERIES, (U.S. CL. 48). SN 74-373,279. PUB. 2-22-1994. FILED 3-30-1993.
- 2,533,298. **MANGO MAMA**. FRESH SAMANTHA, INC., (U.S. CLS. 45, 46 AND 48). SN 75-708,859. PUB. 11-6-2001. FILED 5-17-1999.
- 2,533,412 (*See Class 29 for this trademark*).
- 2,533,416. **AVALON AND DESIGN**. AVALON BEVERAGE COMPANY, (U.S. CLS. 45, 46 AND 48). SN 75-872,806. PUB. 11-6-2001. FILED 12-17-1999.
- 2,533,420. **MICHIGAN BREWING COMPANY**. MICHIGAN BREWING COMPANY, INC., (U.S. CLS. 45, 46 AND 48). SN 75-873,760. PUB. 11-6-2001. FILED 12-17-1999.
- 2,533,434. **SIRACUSE**. COMERS, (U.S. CLS. 45, 46 AND 48). SN 75-884,777. PUB. 11-6-2001. FILED 12-30-1999.
- 2,533,482. **NICE RACK AND DESIGN**. MOOSEHEAD BREWERIES LIMITED, (U.S. CLS. 45, 46 AND 48). SN 75-904,907. PUB. 11-6-2001. FILED 2-1-2000.
- 2,533,616. **MAKE LIFE JUICIER**. INDUSTRIES LASSONDE INC., MULTIPLE CLASS, (INT. CLS. 32 AND 35), (U.S. CLS. 45, 46, 48, 100, 101 AND 102). SN 76-024,530. PUB. 11-6-2001. FILED 4-13-2000.
- 2,533,822. **KINJI BY SPA AND DESIGN**. S.A. SPA MONOPOLE, COMPAGNIE FERMIERE DE SPA, (U.S. CLS. 45, 46 AND 48). SN 76-099,008. PUB. 11-6-2001. FILED 7-28-2000.
- 2,533,865. **GINSENG X AND DESIGN**. P.S.W. INC., (U.S. CLS. 45, 46 AND 48). SN 76-128,313. PUB. 11-6-2001. FILED 9-15-2000.
- 2,533,923. **CLAIRE BAIE**. OAK CREEK WATER AND SEWER UTILITY, (U.S. CLS. 45, 46 AND 48). SN 76-152,283. PUB. 11-6-2001. FILED 10-24-2000.
- 2,533,961. **CATAMOUNT ENJOY VERMONT AND DESIGN**. MBBC VERMONT, LLC, (U.S. CLS. 45, 46 AND 48). SN 76-164,304. PUB. 11-6-2001. FILED 11-13-2000.
- 2,534,067. **FRANK JONES**. JONES, DONALD K., (U.S. CLS. 45, 46 AND 48). SN 76-197,854. PUB. 11-6-2001. FILED 1-22-2001.
- 2,534,068 (*See Class 29 for this trademark*).
- 2,534,077. **QUICKICK**. Q K CORPORATION, (U.S. CLS. 45, 46 AND 48). SN 76-199,359. PUB. 11-6-2001. FILED 1-25-2001.
- 2,534,252. **MOUNTAIN DEW CODE RED AND DESIGN**. PEPSICO, INC., (U.S. CLS. 45, 46 AND 48). SN 76-284,048. PUB. 11-6-2001. FILED 7-12-2001.

CLASS 33—WINES AND SPIRITS

- 2,533,423. **MEDITERRANEAN CANTINA DEL LOCOROTONDO AND DESIGN**. CANTINA SOCIALE COOPERATIVA DI LOCOROTONDO SOCIETA COOPERATIVA A RESPONSABILITA LIMITATA, (U.S. CLS. 47 AND 49). SN 75-876,710. PUB. 11-6-2001. FILED 12-22-1999.
- 2,533,435. **REINDEER ANTLER VODKA**. POLARTRUST LTD OY, (U.S. CLS. 47 AND 49). SN 75-884,831. PUB. 11-6-2001. FILED 12-29-1999.
- 2,533,490. **JUNIPER CANYON**. CHALONE WINE GROUP, LTD., THE, (U.S. CLS. 47 AND 49). SN 75-914,026. PUB. 11-6-2001. FILED 2-9-2000.

- 2,533,511. **GAUDIUM MARQUES DE CACERES**. UNION VITINICOLA, S.A. VINEDOS EN CENICERO, (U.S. CLS. 47 AND 49). SN 75-923,856. PUB. 11-6-2001. FILED 2-22-2000.
- 2,533,512. **VINA TURZABALLA**. BODEGAS RAMON BILBAO, SA., (U.S. CLS. 47 AND 49). SN 75-923,879. PUB. 11-6-2001. FILED 2-22-2000.
- 2,533,618. **TWO ACRES**. OFFICER, KENDAL H., AND OFFICER, MICHAEL R., (U.S. CLS. 47 AND 49). SN 76-025,524. PUB. 11-6-2001. FILED 4-13-2000.
- 2,533,838. **ROYAL EXPORT AND DESIGN**. BRYGGERI-GRUPPEN A/S, (U.S. CLS. 47 AND 49). SN 76-111,648. PUB. 11-6-2001. FILED 8-18-2000.
- 2,534,114. **A AND DESIGN**. KIDPEO INVESTMENTS, PTY LTD, (U.S. CLS. 47 AND 49). SN 76-208,099. PUB. 11-6-2001. FILED 2-12-2001.
- 2,534,150. **ABSINTHE REFINED**. ROUX, MICHEL P., (U.S. CLS. 47 AND 49). SN 76-223,945. PUB. 11-6-2001. FILED 3-13-2001.
- 2,534,281. **USHER'S**. GUINNESS UNITED DISTILLERS & VINTNERS B.V., (U.S. CLS. 47 AND 49). SN 76-292,980. PUB. 11-6-2001. FILED 7-31-2001.
- 2,534,317. **MARTI (STYLIZED)**. GFY BEVERAGES COMPANY, (U.S. CLS. 47 AND 49). SN 78-034,985. PUB. 11-6-2001. FILED 11-13-2000.

CLASS 34—SMOKERS' ARTICLES

- 2,533,217. **GOLDEN GATE**. REEMTSMA CIGARETTENFABRIKEN GMBH, (U.S. CLS. 2, 8, 9 AND 17). SN 75-475,079. PUB. 11-6-2001. FILED 4-27-1998.
- 2,533,310. **HERITAGE HUMIDORS**. HERITAGE HUMIDORS INC., (U.S. CLS. 2, 8, 9 AND 17). SN 75-727,876. PUB. 11-6-2001. FILED 6-14-1999.
- 2,533,323. **LA HOJA SELECTA AND DESIGN**. INTERMATCH SWEDEN AB, BY ASSIGNMENT TABACALERA EL CREDITO, INC., (U.S. CLS. 2, 8, 9 AND 17). SN 75-747,278. PUB. 11-6-2001. FILED 7-8-1999.
- 2,533,375. **LARK AND DESIGN**. TRADEMARKS LLC, (U.S. CLS. 2, 8, 9 AND 17). SN 75-834,623. PUB. 11-6-2001. FILED 10-29-1999.
- 2,533,548. **CAPSTAN**. IMPERIAL TOBACCO LIMITED, (U.S. CLS. 2, 8, 9 AND 17). SN 75-938,006. PUB. 11-6-2001. FILED 3-8-2000.
- 2,533,854. **LA HABANERA**. LA TABACALERA, C. POR A., (U.S. CLS. 2, 8, 9 AND 17). SN 76-121,118. PUB. 11-6-2001. FILED 9-1-2000.
- 2,533,893. **PALL MALL FAMOUS AMERICAN CIGARETTES AND DESIGN**. BROWN & WILLIAMSON TOBACCO CORPORATION, (U.S. CLS. 2, 8, 9 AND 17). SN 76-137,848. PUB. 11-6-2001. FILED 9-29-2000.
- 2,534,012. **CHRONIC WRAP**. ROYAL BLUNTS, INC., (U.S. CLS. 2, 8, 9 AND 17). SN 76-183,513. PUB. 11-6-2001. FILED 12-21-2000.

SERVICE MARKS

CLASS 35—ADVERTISING AND BUSINESS

- 2,533,198. **CONCENTRIX**. CONCENTRIX CORPORATION, BY CHANGE OF NAME MATRICS CORPORATION, MULTIPLE CLASS, (INT. CLS. 35 AND 40), (U.S. CLS. 100, 101, 102, 103 AND 106). SN 75-263,049. PUB. 11-6-2001. FILED 3-24-1997.
- 2,533,199. **IES**. INSTITUTE OF EUROPEAN STUDIES, (U.S. CLS. 100, 101 AND 102). SN 75-273,383. PUB. 11-6-2001. FILED 4-11-1997.
- 2,533,200. **JRI JAMES RICHARDSON INTERNATIONAL AND DESIGN**. JAMES RICHARDSON INTERNATIONAL LIMITED/JAMES RICHARDSON INTERNATIONAL LIMITED, MULTIPLE CLASS, (INT. CLS. 35 AND 39), (U.S. CLS. 100, 101, 102 AND 105). SN 75-303,259. PUB. 11-6-2001. FILED 6-4-1997.

- 2,533,223. **MISCELLANEOUS DESIGN**. CROSSPOINT CORPORATION, MULTIPLE CLASS, (INT. CLS. 35, 36 AND 42), (U.S. CLS. 100, 101 AND 102). SN 75-504,726. PUB. 11-6-2001. FILED 6-18-1998.
- 2,533,227. **CELLSTAR AND DESIGN**. CELLSTAR, LTD., MULTIPLE CLASS, (INT. CLS. 35, 36, 37, 38 AND 42), (U.S. CLS. 100, 101, 102, 103, 104 AND 106). SN 75-534,071. PUB. 11-6-2001. FILED 8-10-1998.
- 2,533,229. **FINNEX**. FINNEX AGENCIES LTD., MULTIPLE CLASS, (INT. CLS. 35 AND 37), (U.S. CLS. 100, 101, 102, 103 AND 106). SN 75-543,332. PUB. 11-6-2001. FILED 8-26-1998.
- 2,533,231. **MISCELLANEOUS DESIGN**. TSGL HOLDING, INC., MULTIPLE CLASS, (INT. CLS. 35, 39 AND 42), (U.S. CLS. 100, 101, 102 AND 105). SN 75-546,131. PUB. 11-6-2001. FILED 9-1-1998.
- 2,533,236 (*See Class 14 for this trademark*).
- 2,533,241. **BLOCKBUSTER PREVIEWED AND DESIGN**. BLOCKBUSTER INC., (U.S. CLS. 100, 101 AND 102). SN 75-574,673. PUB. 11-6-2001. FILED 10-21-1998.
- 2,533,242. **ZERO COMMISSION REAL ESTATE**. WILSON, RAVINELL, (U.S. CLS. 100, 101 AND 102). SN 75-575,782. PUB. 11-6-2001. FILED 11-2-1998.
- 2,533,246. **TECCOM AND DESIGN**. TECDOC INFORMATIONS SYSTEM GMBH, MULTIPLE CLASS, (INT. CLS. 35, 38 AND 42), (U.S. CLS. 100, 101, 102 AND 104). SN 75-585,290. PUB. 11-6-2001. FILED 11-11-1998.
- 2,533,250. **DRAXIS PHARMA**. DRAXIS PHARMA INC., MULTIPLE CLASS, (INT. CLS. 35, 39, 40 AND 42), (U.S. CLS. 100, 101, 102, 103, 105 AND 106). SN 75-599,438. PUB. 11-6-2001. FILED 11-30-1998.
- 2,533,263 (*See Class 4 for this trademark*).
- 2,533,275. **HIGHWAYS**. TOSHIBA AMERICA INFORMATION SYSTEMS, INC., (U.S. CLS. 100, 101 AND 102). SN 75-662,564. PUB. 11-6-2001. FILED 3-17-1999.
- 2,533,282. **SPORTSWATCHER**. SPORTSWATCHER, LLC, (U.S. CLS. 100, 101 AND 102). SN 75-669,478. PUB. 11-6-2001. FILED 3-28-1999.
- 2,533,303. **HOLIDECOR**. TUCKER FARMS, INC., (U.S. CLS. 100, 101 AND 102). SN 75-718,555. PUB. 11-6-2001. FILED 6-1-1999.
- 2,533,307 (*See Class 4 for this trademark*).
- 2,533,313 (*See Class 30 for this trademark*).
- 2,533,316. **QUAIL LODGE RESORT & GOLF CLUB AND DESIGN**. PENINSULA INTERNATIONAL LIMITED, MULTIPLE CLASS, (INT. CLS. 35, 41 AND 42), (U.S. CLS. 100, 101, 102 AND 107). SN 75-738,250. PUB. 11-6-2001. FILED 4-23-1999.
- 2,533,317. **POINT-AND-CLICK JOB REQUISITION**. COM-WORKER.COM, INC., (U.S. CLS. 100, 101 AND 102). SN 75-739,246. PUB. 11-6-2001. FILED 6-17-1999.
- 2,533,318. **BILLHEARD.COM**. BILL HEARD ENTERPRISES, INC., (U.S. CLS. 100, 101 AND 102). SN 75-739,496. PUB. 11-6-2001. FILED 6-29-1999.
- 2,533,330. **STAR DIRECT**. CYPRESS MEDIA, LLC, (U.S. CLS. 100, 101 AND 102). SN 75-761,871. PUB. 11-6-2001. FILED 7-27-1999.
- 2,533,331 (*See Class 7 for this trademark*).
- 2,533,336. **FRIENDSHIP AMBASSADORS FOUNDATION**. FRIENDSHIP AMBASSADORS FOUNDATION, MULTIPLE CLASS, (INT. CLS. 35 AND 41), (U.S. CLS. 100, 101, 102 AND 107). SN 75-773,761. PUB. 11-6-2001. FILED 8-12-1999.
- 2,533,349. **IGOURMET (STYLIZED)**. IGOURMET, LLC, (U.S. CLS. 100, 101 AND 102). SN 75-791,019. PUB. 11-6-2001. FILED 9-2-1999.
- 2,533,357. **MUSIC MEETING**. RADIO & RECORDS, INC., (U.S. CLS. 100, 101 AND 102). SN 75-799,077. PUB. 9-4-2001. FILED 9-14-1999.
- 2,533,361 (*See Class 9 for this trademark*).
- 2,533,369. **WEBUILDERS AND DESIGN (STYLIZED)**. WEBUILDERS CORPORATION, (U.S. CLS. 100, 101 AND 102). SN 75-831,040. PUB. 11-6-2001. FILED 10-30-1999.
- 2,533,371 (*See Class 9 for this trademark*).
- 2,533,376. **IT GLOBAL QUEST AND DESIGN**. IT GLOBAL QUEST, (U.S. CLS. 100, 101 AND 102). SN 75-835,565. PUB. 6-5-2001. FILED 11-18-1999.
- 2,533,382. **AUTO GROUP AMERICA**. PROFIT DEVELOPMENT GROUP, INC., (U.S. CLS. 100, 101 AND 102). SN 75-842,497. PUB. 11-6-2001. FILED 11-6-1999.
- 2,533,383. **THE DOUGHBOY STORE AND DESIGN**. PILLSBURY COMPANY, THE, (U.S. CLS. 100, 101 AND 102). SN 75-842,671. PUB. 11-6-2001. FILED 11-8-1999.
- 2,533,393. **M.MESSENGER AND DESIGN**. PANHANDLE EASTERN PIPE LINE COMPANY, (U.S. CLS. 100, 101 AND 102). SN 75-854,479. PUB. 11-6-2001. FILED 11-22-1999.
- 2,533,403. **ABAGO**. COLLECTOR TECHNOLOGIES, INC., (U.S. CLS. 100, 101 AND 102). SN 75-862,908. PUB. 11-6-2001. FILED 12-2-1999.
- 2,533,404. **MY WEALTHLIBRARY**. WEALTHKNOWLEDGE.COM, (U.S. CLS. 100, 101 AND 102). SN 75-863,025. PUB. 11-6-2001. FILED 12-3-1999.
- 2,533,405. **WEALTHKNOWLEDGE.COM**. WEALTHKNOWLEDGE.COM, INC., (U.S. CLS. 100, 101 AND 102). SN 75-863,026. PUB. 11-6-2001. FILED 12-3-1999.
- 2,533,407. **SOLUTIONS POINT INFORMATION TECHNOLOGY SERVICES**. SP MANAGEMENT, INC., (U.S. CLS. 100, 101 AND 102). SN 75-864,659. PUB. 11-6-2001. FILED 12-6-1999.
- 2,533,410. **PHH INTERACTIVE PLATINUM (STYLIZED)**. PHH VEHICLE MANAGEMENT SERVICES, LLC, (U.S. CLS. 100, 101 AND 102). SN 75-867,281. PUB. 11-6-2001. FILED 12-9-1999.
- 2,533,411. **PRC COMPUTER AND DESIGN**. PUERTO RICO COMPUTER SERVICES CORPORATION, MULTIPLE CLASS, (INT. CLS. 35 AND 37), (U.S. CLS. 100, 101, 102, 103 AND 106). SN 75-867,560. PUB. 11-6-2001. FILED 12-10-1999.
- 2,533,413. **PERSONAL ADVANTAGE**. PERSONAL MARKETING COMPANY, THE, (U.S. CLS. 100, 101 AND 102). SN 75-868,289. PUB. 11-6-2001. FILED 12-10-1999.
- 2,533,415. **CREATING A WORLD OF COLOR**. SUN VALLEY FLORAL FARMS, LLC, BY ASSIGNMENT SUN VALLEY FLORAL FARMS, MULTIPLE CLASS, (INT. CLS. 35 AND 36), (U.S. CLS. 100, 101 AND 102). SN 75-870,976. PUB. 11-6-2001. FILED 12-13-1999.
- 2,533,429. **SAVVI**. SAVVI INTERNATIONAL MARKETING, (U.S. CLS. 100, 101 AND 102). SN 75-882,731. PUB. 11-6-2001. FILED 12-28-1999.
- 2,533,432. **GLOBALBIZ DIRECTORY.COM AND DESIGN**. GLOBAL BIZ DIRECTORY.COM, INC., MULTIPLE CLASS, (INT. CLS. 35 AND 42), (U.S. CLS. 100, 101 AND 102). SN 75-883,598. PUB. 11-6-2001. FILED S.R. 12-27-1999; AM. P.R. 12-27-1999.
- 2,533,436. **B AND DESIGN**. COMMUNITY CONNECT INC., MULTIPLE CLASS, (INT. CLS. 35, 38 AND 42), (U.S. CLS. 100, 101, 102 AND 104). SN 75-884,943. PUB. 11-6-2001. FILED 12-30-1999.
- 2,533,445. **WAV AND DESIGN**. WAV, INC., (U.S. CLS. 100, 101 AND 102). SN 75-887,730. PUB. 11-6-2001. FILED 1-5-2000.
- 2,533,466. **SWORDSTORE.COM NOSYUIAIDO CUSTOM CRAFTED JAPANESE SWORDS AND DESIGN**. POLLAND, RICK, (U.S. CLS. 100, 101 AND 102). SN 75-900,023. PUB. 11-6-2001. FILED 1-16-2000.
- 2,533,470. **INNOVATION SYSTEMS ARCHITECTURE**. DUNDON, ELAINE, (U.S. CLS. 100, 101 AND 102). SN 75-901,931. PUB. 11-6-2001. FILED 1-22-2000.
- 2,533,480. **NOMADIS FORESTRY PARTS AND ACCESSORIES AND DESIGN**. DENHARCO INC., (U.S. CLS. 100, 101 AND 102). SN 75-904,510. PUB. 11-6-2001. FILED 1-26-2000.
- 2,533,484. **W AND DESIGN**. WING ON INTERNATIONAL HOLDINGS LIMITED, (U.S. CLS. 100, 101 AND 102). SN 75-907,221. PUB. 11-6-2001. FILED 2-2-2000.
- 2,533,496. **MISCELLANEOUS DESIGN**. SKILLSVILLAGE, INC., (U.S. CLS. 100, 101 AND 102). SN 75-916,865. PUB. 11-6-2001. FILED 2-10-2000.
- 2,533,504. **B MAUNA LOA TRUE BLUE REWARDS AND DESIGN**. MAUNA LOA MACADAMIA NUT CORPORATION, (U.S. CLS. 100, 101 AND 102). SN 75-919,963. PUB. 11-6-2001. FILED 2-16-2000.
- 2,533,516. **FOODSPOT.COM (STYLIZED)**. CLOSE, WILLIAM, MULTIPLE CLASS, (INT. CLS. 35 AND 42), (U.S. CLS. 100, 101 AND 102). SN 75-927,309. PUB. 11-6-2001. FILED 2-24-2000.
- 2,533,529. **HOLIDAYCHANNEL.COM**. HOLIDAY CHANNEL, INC., (U.S. CLS. 100, 101 AND 102). SN 75-930,961. PUB. 11-6-2001. FILED 2-29-2000.

- 2,533,530. **MA'S CHRISTMAS GALLERY BY THE SEA.** CAUCCI, CHARLES, AND CAUCCI, ROSEMARIE. (U.S. CLS. 100, 101 AND 102). SN 75-931,380. PUB. 11-6-2001. FILED 2-29-2000.
- 2,533,533 (*See Class 16 for this trademark.*).
- 2,533,534. **WILL ONE THING.** PHILIP LAW INCORPORATED, MULTIPLE CLASS, (INT. CLS. 35 AND 41), (U.S. CLS. 100, 101, 102 AND 107). SN 75-932,588. PUB. 11-6-2001. FILED 3-1-2000.
- 2,533,537. **HEALTHCARE AMERICA.** WALSH DISTRIBUTION, INC., MULTIPLE CLASS, (INT. CLS. 35 AND 42), (U.S. CLS. 100, 101 AND 102). SN 75-932,856. PUB. 11-6-2001. FILED 3-1-2000.
- 2,533,555. **VIRIDIEN.** VIRIDIEN TECHNOLOGIES, INC., (U.S. CLS. 100, 101 AND 102). SN 75-940,751. PUB. 11-6-2001. FILED 3-9-2000.
- 2,533,556. **SMARTIPO REPORT.** SMARTPORTFOLIO.COM, INC., BY ASSIGNMENT; BY CHANGE OF NAME SMARTPORTFOLIO.COM, INC., (U.S. CLS. 100, 101 AND 102). SN 75-941,286. PUB. 11-6-2001. FILED 3-10-2000.
- 2,533,557. **SMARTSPLITS REPORT.** SMARTPORTFOLIO.COM, INC., BY ASSIGNMENT; BY CHANGE OF NAME SMARTPORTFOLIO.COM, INC., (U.S. CLS. 100, 101 AND 102). SN 75-941,583. PUB. 11-6-2001. FILED 3-10-2000.
- 2,533,558. **PRO-TINT.** PRO-TINT, INC., MULTIPLE CLASS, (INT. CLS. 35 AND 37), (U.S. CLS. 100, 101, 102, 103 AND 106). SN 75-941,617. PUB. 11-6-2001. FILED 3-10-2000.
- 2,533,565. **MISSOURI EMPLOYERS MUTUAL INSURANCE & DESIGN AND DESIGN.** MISSOURI EMPLOYERS MUTUAL INSURANCE, (U.S. CLS. 100, 101 AND 102). SN 75-943,547. PUB. 11-6-2001. FILED 3-14-2000.
- 2,533,566. **THE EGATEWAY TO MARITIME BUSINESS.** WALLEY RESOURCES, INC., (U.S. CLS. 100, 101 AND 102). SN 75-945,571. PUB. 11-6-2001. FILED 2-26-2000.
- 2,533,567. **COOLOLDSTUFF.** FERGUSON, LINDA J., (U.S. CLS. 100, 101 AND 102). SN 75-960,218. PUB. 11-6-2001. FILED 3-14-2000.
- 2,533,569. **DIGITALEPC.COM.** DIGITALEPC.COM, INC., (U.S. CLS. 100, 101 AND 102). SN 76-000,547. PUB. 11-6-2001. FILED 3-15-2000.
- 2,533,580. **FLORIDA TOMATOES RIPEN NATURALLY NEVER REFRIGERATE AND DESIGN.** FLORIDA TOMATO COMMITTEE, (U.S. CLS. 100, 101 AND 102). SN 76-006,068. PUB. 11-6-2001. FILED 3-21-2000.
- 2,533,595. **ISC.** INVENTION SUBMISSION CORPORATION, (U.S. CLS. 100, 101 AND 102). SN 76-016,144. PUB. 11-6-2001. FILED 4-3-2000.
- 2,533,598. **DOLLAR PARADISE (STYLIZED).** DOLLAR PARADISE, INC., (U.S. CLS. 100, 101 AND 102). SN 76-017,335. PUB. 11-6-2001. FILED 3-27-2000.
- 2,533,599. **MADE IN CREATION AND DESIGN.** RAISON PURE INTERNATIONAL, LLC., MULTIPLE CLASS, (INT. CLS. 35 AND 42), (U.S. CLS. 100, 101 AND 102). SN 76-017,922. PUB. 11-6-2001. FILED 4-5-2000.
- 2,533,605. **CORE INDUSTRIES.** MARTUCCI, THOMAS V., (U.S. CLS. 100, 101 AND 102). SN 76-021,357. PUB. 11-6-2001. FILED 4-10-2000.
- 2,533,616 (*See Class 32 for this trademark.*).
- 2,533,619. **"STAINLESS IS FOREVER".** SPEEDWAY MOTORS, INC., (U.S. CLS. 100, 101 AND 102). SN 76-025,718. PUB. 11-6-2001. FILED 4-14-2000.
- 2,533,625. **MEDIASMITH.** MEDIASMITH, INC., MULTIPLE CLASS, (INT. CLS. 35 AND 42), (U.S. CLS. 100, 101 AND 102). SN 76-028,010. PUB. 11-6-2001. FILED 4-17-2000.
- 2,533,628. **DCHAIN.** COLLATECH, INC., DBA DCHAIN COMMERCE, (U.S. CLS. 100, 101 AND 102). SN 76-029,275. PUB. 11-6-2001. FILED 4-18-2000.
- 2,533,629. **ROPA.** ROPA GROUP CORPORATION, THE, (U.S. CLS. 100, 101 AND 102). SN 76-029,476. PUB. 11-6-2001. FILED 4-19-2000.
- 2,533,630. **ROPA GROUP.** ROPA GROUP CORPORATION, THE, (U.S. CLS. 100, 101 AND 102). SN 76-029,477. PUB. 11-6-2001. FILED 4-19-2000.
- 2,533,632. **DCHAIN COMMERCE.** COLLATECH, INC., DBA DCHAIN COMMERCE, (U.S. CLS. 100, 101 AND 102). SN 76-029,642. PUB. 11-6-2001. FILED 4-18-2000.
- 2,533,652. **ROBIN'S EGG BLUE AND DESIGN.** ROBIN'S EGG BLUE, INC., (U.S. CLS. 100, 101 AND 102). SN 76-036,765. PUB. 11-6-2001. FILED 4-28-2000.
- 2,533,653. **THE WORLD WANTS YOUR BUSINESS..** ADERO, INC., MULTIPLE CLASS, (INT. CLS. 35 AND 42), (U.S. CLS. 100, 101 AND 102). SN 76-036,866. PUB. 11-6-2001. FILED 4-28-2000.
- 2,533,658. **EPLANGOLF.COM THE ULTIMATE GOLF TOURNAMENT SOURCE! AND DESIGN.** GOLF COURSE, INC., THE, DBA EPLANGOLF.COM, (U.S. CLS. 100, 101 AND 102). SN 76-038,691. PUB. 11-6-2001. FILED 5-1-2000.
- 2,533,662. **EZRESUME.** SHAH, CHETAN, AND SHAH, SONAL, (U.S. CLS. 100, 101 AND 102). SN 76-039,740. PUB. 11-6-2001. FILED 5-2-2000.
- 2,533,664. **E-COMART.** INTERNET GOLDEN MARKET, (U.S. CLS. 100, 101 AND 102). SN 76-040,006. PUB. 11-6-2001. FILED 5-3-2000.
- 2,533,673. **ONSITE MEDIA (STYLIZED).** ON-SITE MEDIA, INC., (U.S. CLS. 100, 101 AND 102). SN 76-042,426. PUB. 11-6-2001. FILED 5-5-2000.
- 2,533,674. **ONSITE MEDIA.** ON-SITE MEDIA, INC., (U.S. CLS. 100, 101 AND 102). SN 76-042,499. PUB. 11-6-2001. FILED 5-5-2000.
- 2,533,690. **NICKEL TOUR.** TURNER, JEFFREY G., (U.S. CLS. 100, 101 AND 102). SN 76-046,228. PUB. 11-6-2001. FILED 5-8-2000.
- 2,533,692. **BIZJOURNALS.COM AND DESIGN.** BIZJOURNALS.COM, INC., (U.S. CLS. 100, 101 AND 102). SN 76-048,020. PUB. 11-6-2001. FILED 5-15-2000.
- 2,533,695 (*See Class 7 for this trademark.*).
- 2,533,697. **FINE SWINE AND DESIGN.** INTERNATIONAL BROADBAND INC, (U.S. CLS. 100, 101 AND 102). SN 76-050,381. PUB. 11-6-2001. FILED 5-12-2000.
- 2,533,700. **THE COLONY COMPANIES AND DESIGN.** COLONY COMPANIES, INC., THE, (U.S. CLS. 100, 101 AND 102). SN 76-051,744. PUB. 11-6-2001. FILED 5-19-2000.
- 2,533,702. **HEALTH VITALS.** PEARCE, JAMES T., (U.S. CLS. 100, 101 AND 102). SN 76-052,834. PUB. 11-6-2001. FILED 5-22-2000.
- 2,533,704. **OI PARTNERS.** OI PARTNERS, INC., (U.S. CLS. 100, 101 AND 102). SN 76-052,976. PUB. 11-6-2001. FILED 5-22-2000.
- 2,533,724. **QUICKSWITCH.** CIGNA INTELLECTUAL PROPERTY, INC., BY ASSIGNMENT CIGNA CORPORATION, (U.S. CLS. 100, 101 AND 102). SN 76-059,197. PUB. 11-6-2001. FILED 5-30-2000.
- 2,533,726 (*See Class 1 for this trademark.*).
- 2,533,731. **MISCELLANEOUS DESIGN.** INCLAN ENTERPRISES, INC., DBA BOURBON COUNTRY, INC., (U.S. CLS. 100, 101 AND 102). SN 76-061,820. PUB. 11-6-2001. FILED 6-2-2000.
- 2,533,736. **THE CLEANING STORE AND DESIGN.** ROYAL CHEMICAL, INC., MULTIPLE CLASS, (INT. CLS. 35, 37 AND 39), (U.S. CLS. 100, 101, 102, 103, 105 AND 106). SN 76-062,385. PUB. 11-6-2001. FILED 6-2-2000.
- 2,533,737. **COMSCIENCES.** COMSCIENCES, INC., MULTIPLE CLASS, (INT. CLS. 35 AND 42), (U.S. CLS. 100, 101 AND 102). SN 76-063,067. PUB. 11-6-2001. FILED 6-2-2000.
- 2,533,750. **A WORLD OF UNFORGETTABLE GIFTS.** NORM THOMPSON OUTFITTERS, INC., (U.S. CLS. 100, 101 AND 102). SN 76-069,582. PUB. 11-6-2001. FILED 6-13-2000.
- 2,533,768. **ARTZAPPER.** ARTZAPPER, LLC, (U.S. CLS. 100, 101 AND 102). SN 76-075,923. PUB. 11-6-2001. FILED 6-22-2000.
- 2,533,771 (*See Class 21 for this trademark.*).
- 2,533,772. **MYCULLIGAN.** CULLIGAN INTERNATIONAL COMPANY, (U.S. CLS. 100, 101 AND 102). SN 76-077,676. PUB. 11-6-2001. FILED 6-26-2000.
- 2,533,786. **J & R MUSIC WORLD COMPUTER WORLD WALK IN PHONE IN LOGIN AND DESIGN.** J&R ELECTRONICS, INC., DBA J&R MUSIC WORLD, (U.S. CLS. 100, 101 AND 102). SN 76-083,978. PUB. 11-6-2001. FILED 7-6-2000.
- 2,533,787. **MORRILTON SMALL CITY. NO LIMITS. AND DESIGN.** MORRILTON AREA CHAMBER OF COMMERCE, (U.S. CLS. 100, 101 AND 102). SN 76-084,445. PUB. 11-6-2001. FILED 7-10-2000.
- 2,533,790. **CAREERREWARDS.** CAREER REWARDS, INC., (U.S. CLS. 100, 101 AND 102). SN 76-085,320. PUB. 11-6-2001. FILED 7-10-2000.

- 2,533,798. **THE AFFILIATES (STYLIZED)**. ROBERT HALF INCORPORATED, (U.S. CLS. 100, 101 AND 102). SN 76-087,898. PUB. 11-6-2001. FILED 7-12-2000.
- 2,533,805. **VOICESTREAM WIRELESS AND DESIGN**. VOICESTREAM WIRELESS CORPORATION, (U.S. CLS. 100, 101 AND 102). SN 76-091,086. PUB. 11-6-2001. FILED 7-18-2000.
- 2,533,810. **FARM PROGRESS HAY EXPO**. FARM PROGRESS COMPANIES, INC., (U.S. CLS. 100, 101 AND 102). SN 76-093,234. PUB. 11-6-2001. FILED 7-21-2000.
- 2,533,811. **FACILISITE**. INTEGRATED OFFICE RESOURCES, L.L.C., (U.S. CLS. 100, 101 AND 102). SN 76-093,416. PUB. 11-6-2001. FILED 7-21-2000.
- 2,533,823. **CASEY JONES GRILL**. DEEMS, INC., (U.S. CLS. 100, 101 AND 102). SN 76-100,940. PUB. 11-6-2001. FILED 8-2-2000.
- 2,533,826. **M MODELS AND DESIGN**. M MODELS INC., (U.S. CLS. 100, 101 AND 102). SN 76-103,850. PUB. 11-6-2001. FILED 8-7-2000.
- 2,533,846. **GZP GROUND ZERO PHARMACEUTICALS, INC. AND DESIGN**. GROUND ZERO PHARMACEUTICALS, (U.S. CLS. 100, 101 AND 102). SN 76-117,130. PUB. 11-6-2001. FILED 8-28-2000.
- 2,533,852. **IMMEDIENT**. IMMEDIENT I INC., (U.S. CLS. 100, 101 AND 102). SN 76-118,751. PUB. 11-6-2001. FILED 8-29-2000.
- 2,533,863. **GET ONLINE OR GET LEFT BEHIND....** ELLIOTT, CRAIG, (U.S. CLS. 100, 101 AND 102). SN 76-126,722. PUB. 11-6-2001. FILED 9-11-2000.
- 2,533,864. **MARKETING RESEARCH SERVICES FOR THE 21ST CENTURY**. COMMON KNOWLEDGE, INC., (U.S. CLS. 100, 101 AND 102). SN 76-127,064. PUB. 11-6-2001. FILED 9-13-2000.
- 2,533,870. **CREATIVESOLUTIONS AND DESIGN**. CREATIVE SOLUTIONS INTERNATIONAL, INC., MULTIPLE CLASS, (INT. CLS. 35 AND 42), (U.S. CLS. 100, 101 AND 102). SN 76-129,983. PUB. 11-6-2001. FILED 9-18-2000.
- 2,533,887. **TEASERS ONLINE**. MONICA CECILE ANGULO, DBA TEASERS ONLINE, (U.S. CLS. 100, 101 AND 102). SN 76-136,111. PUB. 11-6-2001. FILED 9-27-2000.
- 2,533,891. **GOT JERKY?**. MELMAR CONCESSIONS, INC., (U.S. CLS. 100, 101 AND 102). SN 76-136,921. PUB. 11-6-2001. FILED 9-27-2000.
- 2,533,894. **FIRST JEWELRY**. INTERNET SHOPPING NETWORK, LLC, (U.S. CLS. 100, 101 AND 102). SN 76-138,581. PUB. 11-6-2001. FILED 9-29-2000.
- 2,533,895. **GUTENBERG**. GUTENBERG PRINTING PRESS COMPANY, (U.S. CLS. 100, 101 AND 102). SN 76-139,607. PUB. 11-6-2001. FILED 10-3-2000.
- 2,533,902. **OPINION METRICS**. OPINIONLAB, INC., MULTIPLE CLASS, (INT. CLS. 35 AND 42), (U.S. CLS. 100, 101 AND 102). SN 76-142,524. PUB. 11-6-2001. FILED 10-5-2000.
- 2,533,908. **WERNER CYCLE WORKS AND DESIGN**. WERNER MANAGEMENT, INC., BY ASSIGNMENT; BY ASSIGNMENT WERNER ENTERPRISES, INC., MULTIPLE CLASS, (INT. CLS. 35 AND 37), (U.S. CLS. 100, 101, 102, 103 AND 106). SN 76-146,989. PUB. 7-31-2001. FILED 10-16-2000.
- 2,533,912. **BY THE VINE**. BY THE VINE, INC., (U.S. CLS. 100, 101 AND 102). SN 76-147,461. PUB. 11-6-2001. FILED 10-16-2000.
- 2,533,918 (*See Class 30 for this trademark*).
- 2,533,929. **TOASK (STYLIZED)**. TAOSK, INC., (U.S. CLS. 100, 101 AND 102). SN 76-154,921. PUB. 11-6-2001. FILED 10-27-2000.
- 2,533,931. **HOUSE OF DOCS**. SUNDANCE INSTITUTE, MULTIPLE CLASS, (INT. CLS. 35 AND 41), (U.S. CLS. 100, 101, 102 AND 107). SN 76-155,518. PUB. 11-6-2001. FILED 10-30-2000.
- 2,533,944. **WINE INDUSTRY FINANCIAL SYMPOSIUM**. WINE INDUSTRY SYMPOSIUM GROUP LLC, (U.S. CLS. 100, 101 AND 102). SN 76-158,529. PUB. 11-6-2001. FILED 11-2-2000.
- 2,533,958. **FIRSTCHOICE**. FIRST CHOICE PET PRODUCTS, INC., (U.S. CLS. 100, 101 AND 102). SN 76-164,219. PUB. 11-6-2001. FILED 11-13-2000.
- 2,533,972 (*See Class 30 for this trademark*).
- 2,533,978. **COREINTELLECT**. COREINTELLECT, INC., (U.S. CLS. 100, 101 AND 102). SN 76-171,286. PUB. 11-6-2001. FILED 11-27-2000.
- 2,533,986. **CAVANAUGH SETTING A NEW STANDARD AND DESIGN**. CAVANAUGH MARKETING NETWORK, INC., (U.S. CLS. 100, 101 AND 102). SN 76-173,580. PUB. 11-6-2001. FILED 11-30-2000.
- 2,533,991 (*See Class 30 for this trademark*).
- 2,533,996. **FINLINSON PROPERITIES AND DESIGN**. FINLINSON, GARY, (U.S. CLS. 100, 101 AND 102). SN 76-179,045. PUB. 11-6-2001. FILED 12-11-2000.
- 2,533,997. **WORKFORCE WIZARD AND DESIGN**. GREATER RICHMOND CHAMBER OF COMMERCE, (U.S. CLS. 100, 101 AND 102). SN 76-179,091. PUB. 11-6-2001. FILED 12-11-2000.
- 2,534,006. **CAPITOL DRUGS**. CAPITOL DRUGS, INC., (U.S. CLS. 100, 101 AND 102). SN 76-181,856. PUB. 11-6-2001. FILED 12-18-2000.
- 2,534,007. **THE MAGIC OF MACY'S**. FEDERATED WESTERN PROPERTIES, INC., (U.S. CLS. 100, 101 AND 102). SN 76-182,188. PUB. 11-6-2001. FILED 12-18-2000.
- 2,534,010 (*See Class 4 for this trademark*).
- 2,534,019. **LOUISVILLE: THE PLACE TO LIVE, WORK AND PLAY**. CITY OF LOUISVILLE, KENTUCKY, (U.S. CLS. 100, 101 AND 102). SN 76-184,799. PUB. 11-6-2001. FILED 12-21-2000.
- 2,534,023. **PREPARING THE WORLD FOR BUSINESS**. CORPORATE EXPRESS, INC., (U.S. CLS. 100, 101 AND 102). SN 76-185,472. PUB. 11-6-2001. FILED 12-21-2000.
- 2,534,033. **GOALLAB**. INTERVENTURE, LLC, (U.S. CLS. 100, 101 AND 102). SN 76-188,343. PUB. 11-6-2001. FILED 12-28-2000.
- 2,534,034. **GAINLAB**. INTERVENTURE, LLC, (U.S. CLS. 100, 101 AND 102). SN 76-188,505. PUB. 11-6-2001. FILED 12-28-2000.
- 2,534,060. **CD&L AND DESIGN**. CD&L INC., MULTIPLE CLASS, (INT. CLS. 35 AND 39), (U.S. CLS. 100, 101, 102 AND 105). SN 76-197,425. PUB. 11-6-2001. FILED 1-22-2001.
- 2,534,061. **CD&L**. CD&L, INC., MULTIPLE CLASS, (INT. CLS. 35 AND 39), (U.S. CLS. 100, 101, 102 AND 105). SN 76-197,427. PUB. 11-6-2001. FILED 1-22-2001.
- 2,534,062. **BIG BOB'S CARPET AND DESIGN**. BIG BOB'S NEW & USED CARPET OF AMERICA, INC., (U.S. CLS. 100, 101 AND 102). SN 76-197,455. PUB. 11-6-2001. FILED 1-12-2001.
- 2,534,064. **MY FACTS ACCOUNT**. FACTS MANAGEMENT CO., (U.S. CLS. 100, 101 AND 102). SN 76-197,481. PUB. 11-6-2001. FILED 1-16-2001.
- 2,534,076. **SOCK-RA-TEASE**. C.M. INDUSTRIES, INC., (U.S. CLS. 100, 101 AND 102). SN 76-199,310. PUB. 11-6-2001. FILED 1-23-2001.
- 2,534,080. **CONSILIENCE GROUP**. CONSILIENCE GROUP, LLC, (U.S. CLS. 100, 101 AND 102). SN 76-200,252. PUB. 11-6-2001. FILED 1-29-2001.
- 2,534,084. **REQ2CHECK**. CDI CORPORATION, (U.S. CLS. 100, 101 AND 102). SN 76-202,229. PUB. 11-6-2001. FILED 1-31-2001.
- 2,534,097. **ILSMART.COM AND DESIGN**. INVENTORY LOCATOR SERVICE, INC., (U.S. CLS. 100, 101 AND 102). SN 76-204,408. PUB. 11-6-2001. FILED 2-2-2001.
- 2,534,099. **ILS PURCHASE ONLINE**. INVENTORY LOCATOR SERVICE, INC., (U.S. CLS. 100, 101 AND 102). SN 76-204,697. PUB. 11-6-2001. FILED 2-2-2001.
- 2,534,106. **SPARKLES PREMIUM INCENTIVES**. SPARKLES GROUP INC., THE, (U.S. CLS. 100, 101 AND 102). SN 76-206,982. PUB. 11-6-2001. FILED 2-6-2001.
- 2,534,111. **BALANCE YOUR DAY... AND DESIGN**. COMMEREX INTERNATIONAL, L.L.C., (U.S. CLS. 100, 101 AND 102). SN 76-207,522. PUB. 11-6-2001. FILED 2-8-2001.
- 2,534,156. **EXTENDRX**. MTI INFORMATION TECHNOLOGIES, LLC, (U.S. CLS. 100, 101 AND 102). SN 76-225,992. PUB. 11-6-2001. FILED 3-19-2001.
- 2,534,157. **MISCELLANEOUS DESIGN**. ONECHANNEL.NET, INC., (U.S. CLS. 100, 101 AND 102). SN 76-226,381. PUB. 11-6-2001. FILED 3-19-2001.
- 2,534,168. **SAN ANTONIO SPURS AND DESIGN**. SAN ANTONIO SPURS, L.L.C., (U.S. CLS. 100, 101 AND 102). SN 76-229,739. PUB. 11-6-2001. FILED 3-26-2001.
- 2,534,170. **DAY AT THE DOCKS**. MILLER, CATHERINE, DBA CATHERINE MILLER & ASSOCIATES, (U.S. CLS. 100, 101 AND 102). SN 76-230,593. PUB. 11-6-2001. FILED 3-

26-2001.
 2,534,179. **PROMAC**. PROMAC, INC., (U.S. CLS. 100, 101 AND 102). SN 76-235,606. PUB. 11-6-2001. FILED 3-30-2001.
 2,534,184. **NEW MIDDLE**. KENMARK OPTICAL COMPANY, (U.S. CLS. 100, 101 AND 102). SN 76-237,247. PUB. 11-6-2001. FILED 4-9-2001.
 2,534,201. **DIRECTNET**. SRDS, INC., (U.S. CLS. 100, 101 AND 102). SN 76-262,206. PUB. 11-6-2001. FILED 5-24-2001.
 2,534,203. **EVENTIVITY**. EVENTIVITY, INC., (U.S. CLS. 100, 101 AND 102). SN 76-264,099. PUB. 11-6-2001. FILED 5-29-2001.
 2,534,215. **PORTLAND FIRE AND DESIGN**. WNBA ENTERPRISES, LLC, (U.S. CLS. 100, 101 AND 102). SN 76-273,112. PUB. 11-6-2001. FILED 6-18-2001.
 2,534,223. **CARESCIENCE AND DESIGN**. CARESCIENCE, INC., MULTIPLE CLASS, (INT. CLS. 35, 41 AND 42), (U.S. CLS. 100, 101, 102 AND 107). SN 76-276,764. PUB. 11-6-2001. FILED 6-26-2001.
 2,534,246. **PREROGATIVE**. CALLAHAN CREEK, INC., (U.S. CLS. 100, 101 AND 102). SN 76-282,597. PUB. 11-6-2001. FILED 7-11-2001.
 2,534,326. **MISCELLANEOUS DESIGN**. GAMEDAY SPORTS SHOP, INC., (U.S. CLS. 100, 101 AND 102). SN 78-051,578. PUB. 11-6-2001. FILED 3-6-2001.
 2,534,328. **MERIDIAN LEGAL SEARCH**. STAYER, CANDICE WILSON DBA MERIDIAN LEGAL SEARCH, (U.S. CLS. 100, 101 AND 102). SN 78-057,016. PUB. 11-6-2001. FILED 4-5-2001.
 2,534,334. **NEWGROUND**. NEWGROUND RESOURCES, INC., (U.S. CLS. 100, 101 AND 102). SN 78-066,611. PUB. 11-6-2001. FILED 5-31-2001.

CLASS 36—INSURANCE AND FINANCIAL

2,533,216. **DELAWARE CAPITAL FORMATION, INC.**, DELAWARE CAPITAL FORMATION, INC., (U.S. CLS. 100, 101 AND 102). SN 75-472,247. PUB. 11-6-2001. FILED 4-22-1998.
 2,533,220. **1-800-YES-2000**. COMMERCE BANCORP, INC., (U.S. CLS. 100, 101 AND 102). SN 75-498,019. PUB. 11-6-2001. FILED 6-8-1998.
 2,533,223 (*See Class 35 for this trademark*).
 2,533,224. **LASALLE PC LINK AND DESIGN**. ABN AMRO NORTH AMERICA, INC., (U.S. CLS. 100, 101 AND 102). SN 75-507,270. PUB. 11-6-2001. FILED 6-23-1998.
 2,533,226. **LASALLE PC LINK**. ABN AMRO NORTH AMERICA, INC., (U.S. CLS. 100, 101 AND 102). SN 75-526,236. PUB. 11-6-2001. FILED 7-27-1998.
 2,533,227 (*See Class 35 for this trademark*).
 2,533,236 (*See Class 14 for this trademark*).
 2,533,273. **MISCELLANEOUS DESIGN**. CREDIT-BASED ASSET SERVICING AND SECURITIZATION LLC, (U.S. CLS. 100, 101 AND 102). SN 75-658,272. PUB. 11-6-2001. FILED 3-11-1999.
 2,533,288. **CORCORANS**. CORCORAN GROUP EAST SIDE, INC., (U.S. CLS. 100, 101 AND 102). SN 75-688,924. PUB. 11-6-2001. FILED 4-23-1999.
 2,533,344 (*See Class 16 for this trademark*).
 2,533,345. **WANGER ASSET MANAGEMENT**. LIBERTY WANGER ASSET MANAGEMENT L.P., (U.S. CLS. 100, 101 AND 102). SN 75-784,529. PUB. 11-6-2001. FILED 8-25-1999.
 2,533,364. **THE INVESTMENT PROFESSIONAL' S CHOICE**. ALLIANCE CAPITAL MANAGEMENT L.P., (U.S. CLS. 100, 101 AND 102). SN 75-816,720. PUB. 11-6-2001. FILED 10-6-1999.
 2,533,381. **CARGOCOVER.COM**. OCEANWIDE MARINE NETWORK INC., (U.S. CLS. 100, 101 AND 102). SN 75-841,150. PUB. 11-6-2001. FILED 11-4-1999.
 2,533,394. **OFFICIAL PAYMENTS CORP. AND DESIGN**. OFFICIAL PAYMENTS CORPORATION, (U.S. CLS. 100, 101 AND 102). SN 75-854,525. PUB. 11-6-2001. FILED 11-22-1999.
 2,533,415 (*See Class 35 for this trademark*).
 2,533,426. **INSURACTIVE**. INSURACTIVE, INC., BY ASSIGNMENT SENIOR MARKET SALES, INC., (U.S. CLS. 100, 101 AND 102). SN 75-880,045. PUB. 11-6-2001. FILED 1-4-2000.

2,533,430. **CM**. CARL MARKS & CO. INC., (U.S. CLS. 100, 101 AND 102). SN 75-883,116. PUB. 11-6-2001. FILED 12-29-1999.
 2,533,437. **PODIUM SPORTS MARKETING**. PODIUM SPORTS MARKETING, INC., (U.S. CLS. 100, 101 AND 102). SN 75-885,619. PUB. 11-6-2001. FILED 1-3-2000.
 2,533,441. **UNIVEST FINANCIAL SERVICES**. UNIVEST CORPORATION OF PENNSYLVANIA, (U.S. CLS. 100, 101 AND 102). SN 75-885,763. PUB. 11-6-2001. FILED 1-3-2000.
 2,533,443. **BPPR POPULAR ASSET MANAGEMENT AND DESIGN**. POPULAR, INC., (U.S. CLS. 100, 101 AND 102). SN 75-887,157. PUB. 11-6-2001. FILED 1-6-2000.
 2,533,476. **SIGMA FINANCE CORPORATION**. SIGMA FINANCE CORPORATION, (U.S. CLS. 100, 101 AND 102). SN 75-903,186. PUB. 11-6-2001. FILED 1-26-2000.
 2,533,487. **STREET SMART VEHICLE PROTECTION (STYLIZED)**. CREDITGUARD CORPORATION, (U.S. CLS. 100, 101 AND 102). SN 75-911,317. PUB. 11-6-2001. FILED 1-18-2000.
 2,533,492. **DANISH RE AND DESIGN**. DANISH RE (BERMUDA) LTD., (U.S. CLS. 100, 101 AND 102). SN 75-914,922. PUB. 10-31-2000. FILED 2-11-2000.
 2,533,494 (*See Class 14 for this trademark*).
 2,533,506. **IBRAT**. EVANS, SHANNON L., AND GALE, LAWRENCE E., MULTIPLE CLASS, (INT. CLS. 36 AND 42), (U.S. CLS. 100, 101 AND 102). SN 75-920,676. PUB. 11-6-2001. FILED 2-15-2000.
 2,533,559. **PRIME AND DESIGN**. PRIME CAPITAL CORP., (U.S. CLS. 100, 101 AND 102). SN 75-941,717. PUB. 11-6-2001. FILED 3-10-2000.
 2,533,570. **MISCELLANEOUS DESIGN**. SCIMUS INFORMATION SYSTEMS, LTD., MULTIPLE CLASS, (INT. CLS. 36 AND 42), (U.S. CLS. 100, 101 AND 102). SN 76-000,616. PUB. 11-6-2001. FILED 3-15-2000.
 2,533,576. **PEOPLELINK**. F.B.P. INSURANCE SERVICES, INC., (U.S. CLS. 100, 101 AND 102). SN 76-003,285. PUB. 11-6-2001. FILED 3-17-2000.
 2,533,639. **INVESTOR SERVICEDIRECT**. CHASEMELLON SHAREHOLDER SERVICES, L.L.C., (U.S. CLS. 100, 101 AND 102). SN 76-032,186. PUB. 11-6-2001. FILED 4-24-2000.
 2,533,661. **SETTLELINK.NET**. CHICOR INFORMATION MANAGEMENT, INC., (U.S. CLS. 100, 101 AND 102). SN 76-039,453. PUB. 11-6-2001. FILED 5-2-2000.
 2,533,672. **\$ AND DESIGN**. PEER PARTNERSHIPS, INC., DBA WORKING CAPITAL, (U.S. CLS. 100, 101 AND 102). SN 76-042,384. PUB. 11-6-2001. FILED 5-5-2000.
 2,533,699. **LIBERTY TRIANGLE DEVELOPMENT AND DESIGN**. MILLER, MARK D., (U.S. CLS. 100, 101 AND 102). SN 76-051,534. PUB. 11-6-2001. FILED 5-18-2000.
 2,533,707. **FREEDOM FACTOR**. MYPRIMETIME, INC., (U.S. CLS. 100, 101 AND 102). SN 76-054,085. PUB. 11-6-2001. FILED 5-23-2000.
 2,533,712. **FASHION WALK OF FAME**. FASHION CENTER DISTRICT MANAGEMENT ASSOCIATION, INC., (U.S. CLS. 100, 101 AND 102). SN 76-055,120. PUB. 11-6-2001. FILED 5-24-2000.
 2,533,740. **BANTERRA**. BANTERRA CORP., (U.S. CLS. 100, 101 AND 102). SN 76-065,464. PUB. 11-6-2001. FILED 6-6-2000.
 2,533,757. **MISCELLANEOUS DESIGN**. CARD EXPERTS, INC., (U.S. CLS. 100, 101 AND 102). SN 76-071,437. PUB. 11-6-2001. FILED 6-16-2000.
 2,533,765. **CHART WALKER**. WESTPORT FINANCIAL LLC, (U.S. CLS. 100, 101 AND 102). SN 76-074,271. PUB. 11-6-2001. FILED 6-20-2000.
 2,533,784. **MERCURY PRODUCT PROTECTION AND DESIGN**. BRUNSWICK CORPORATION, (U.S. CLS. 100, 101 AND 102). SN 76-083,405. PUB. 11-6-2001. FILED 7-6-2000.
 2,533,796. **MOSERS**. MISSOURI STATE EMPLOYEES' RETIREMENT SYSTEM, (U.S. CLS. 100, 101 AND 102). SN 76-087,309. PUB. 11-6-2001. FILED 7-12-2000.
 2,533,803. **ACCIDENT SECURE**. CONSECO, INC., (U.S. CLS. 100, 101 AND 102). SN 76-090,299. PUB. 11-6-2001. FILED 7-17-2000.
 2,533,855. **FIDUCIARYWORKS**. AMOS, MATTHEW P., (U.S. CLS. 100, 101 AND 102). SN 76-121,195. PUB. 11-6-2001. FILED 8-31-2000.
 2,533,885. **MARTHA A. GOTTFRIED, INC.**, MARTHA A. GOTTFRIED, INC., (U.S. CLS. 100, 101 AND 102). SN 76-

135,825. PUB. 11-6-2001. FILED 9-22-2000.

2,533,905. **KEEFE REAL ESTATE, INC. AND DESIGN.** KEEFE REAL ESTATE, INC., (U.S. CLS. 100, 101 AND 102). SN 76-143,681. PUB. 11-6-2001. FILED 10-10-2000.

2,533,948. **CAHEC COMMUNITY AFFORDABLE HOUSING EQUITY CORP. AND DESIGN.** COMMUNITY AFFORDABLE HOUSING EQUITY CORP., (U.S. CLS. 100, 101 AND 102). SN 76-159,862. PUB. 11-6-2001. FILED 11-6-2000.

2,533,949. **GROW GREENR.** ROBINSON HOXTON PUBLISHING, LLC, (U.S. CLS. 100, 101 AND 102). SN 76-160,154. PUB. 11-6-2001. FILED 11-2-2000.

2,533,950. **IBC BANK.** INTERNATIONAL BANCSHARES CORPORATION, (U.S. CLS. 100, 101 AND 102). SN 76-160,548. PUB. 11-6-2001. FILED 11-6-2000.

2,534,016. **MISCELLANEOUS DESIGN.** BREEN & COMPANY, (U.S. CLS. 100, 101 AND 102). SN 76-183,899. PUB. 11-6-2001. FILED 12-19-2000.

2,534,037. **COLUMBIA MALL.** MOUNTAIN DEVELOPMENT CORPORATION, (U.S. CLS. 100, 101 AND 102). SN 76-189,999. PUB. 11-6-2001. FILED 1-8-2001.

2,534,056. **MAINSAIL CAPITAL.** FLEETBOSTON FINANCIAL CORPORATION, (U.S. CLS. 100, 101 AND 102). SN 76-196,271. PUB. 11-6-2001. FILED 1-19-2001.

2,534,108. **CREDIT ANGEL.** BENNINGTON MOTOR CAR, INC., (U.S. CLS. 100, 101 AND 102). SN 76-207,372. PUB. 11-6-2001. FILED 2-8-2001.

2,534,112. **LIBERTY LIFE'S SPECTRUM UNIVERSAL LIFE.** LIBERTY LIFE ASSURANCE COMPANY OF BOSTON, (U.S. CLS. 100, 101 AND 102). SN 76-207,646. PUB. 11-6-2001. FILED 2-12-2001.

2,534,118. **STUDENT PERSONAL PROPERTY PROTECTOR PLUS.** CSI - CARR SERVICES, INC., (U.S. CLS. 100, 101 AND 102). SN 76-208,251. PUB. 11-6-2001. FILED 2-12-2001.

2,534,126. **BUILDING A BETTER BLOCK.** FEDERAL HOME LOAN MORTGAGE CORPORATION, (U.S. CLS. 100, 101 AND 102). SN 76-212,015. PUB. 11-6-2001. FILED 2-20-2001.

2,534,146. **MISCELLANEOUS DESIGN.** VILLAGE VENTURES, INC., (U.S. CLS. 100, 101 AND 102). SN 76-222,700. PUB. 11-6-2001. FILED 3-12-2001.

2,534,198. **WE PROMISE. WE DELIVER..** INDYMAC BANK, F.S.B., (U.S. CLS. 100, 101 AND 102). SN 76-257,181. PUB. 11-6-2001. FILED 5-15-2001.

2,534,204. **CODEX.** EKKO EIENDOM AS, (U.S. CLS. 100, 101 AND 102). SN 76-265,042. PUB. 11-6-2001. FILED 5-31-2001.

2,534,232. **NEXCOMM.** NEXCOMM CAPITAL PARTNERS, LLC, (U.S. CLS. 100, 101 AND 102). SN 76-280,004. PUB. 11-6-2001. FILED 7-6-2001.

2,534,240. **EDUCATION FOR A BRIGHTER FUTURE.** ARCHDIOCESE OF DETROIT, (U.S. CLS. 100, 101 AND 102). SN 76-281,822. PUB. 11-6-2001. FILED 7-10-2001.

2,534,241. **ATM ONE.** AUSTIN, BRIAN, DBA ATM ONE, (U.S. CLS. 100, 101 AND 102). SN 76-282,028. PUB. 11-6-2001. FILED 7-10-2001.

2,534,242. **PAYTRADING.** RESNICK, ERIC SHAWN, (U.S. CLS. 100, 101 AND 102). SN 76-282,531. PUB. 11-6-2001. FILED 7-9-2001.

2,534,298. **ETIME CAPITAL.** ETIME CAPTIAL, INC., (U.S. CLS. 100, 101 AND 102). SN 78-000,722. PUB. 11-6-2001. FILED 3-23-2000.

2,534,299. **FLEXWERX BENEFITS TO THE MAX AND DESIGN.** SCHLESINGER ASSOCIATES, INC., (U.S. CLS. 100, 101 AND 102). SN 78-004,980. PUB. 11-6-2001. FILED 4-20-2000.

2,534,303. **PMAWORKS.** PENNSYLVANIA MFR ASSOC INSURANCE COMPANY, (U.S. CLS. 100, 101 AND 102). SN 78-010,459. PUB. 11-6-2001. FILED 5-30-2000.

2,534,304. **PMA GLOBAL ENVOY.** PENNSYLVANIA MFR ASSOC INSURANCE COMPANY, (U.S. CLS. 100, 101 AND 102). SN 78-010,469. PUB. 11-6-2001. FILED 5-30-2000.

2,534,320. **AMERICAN RETIREMENT PLANNERS AND DESIGN.** AMERICAN RETIREMENT PLANNERS, (U.S. CLS. 100, 101 AND 102). SN 78-038,819. PUB. 11-6-2001. FILED 12-11-2000.

2,534,332. **NEIGHBORHOOD GOLD.** BUYER'S FUND, INC., THE, (U.S. CLS. 100, 101 AND 102). SN 78-065,904. PUB. 11-6-2001. FILED 5-25-2001.

CLASS 37—CONSTRUCTION AND REPAIR

2,533,188. **DENT-BUSTERS AND DESIGN.** KUBIK, TERRY, (U.S. CL. 103). SN 74-241,495. PUB. 8-3-1993. FILED 1-30-1992.

2,533,189. **DENTBUSTERS PAINTLESS DENT REPAIR AND DESIGN.** DENTBUSTERS, (U.S. CL. 103). SN 74-285,038. PUB. 6-20-2000. FILED 6-15-1992.

2,533,227 (*See Class 35 for this trademark*).

2,533,229 (*See Class 35 for this trademark*).

2,533,264. **ARBORCARE, INC. TREE SPECIALISTS AND DESIGN.** CLAIR, KEVIN P., (U.S. CLS. 100, 103 AND 106). SN 75-640,279. PUB. 11-6-2001. FILED 2-12-1999.

2,533,331 (*See Class 7 for this trademark*).

2,533,371 (*See Class 9 for this trademark*).

2,533,378. **TORNADO DRYER.** NEWPARK DRILLING FLUIDS, INC., MULTIPLE CLASS, (INT. CLS. 37 AND 40), (U.S. CLS. 100, 103 AND 106). SN 75-838,698. PUB. 11-6-2001. FILED 10-30-1999.

2,533,409. **SPECTRA SOLUTIONS.** COLLECTIVE TECHNOLOGIES, INC., MULTIPLE CLASS, (INT. CLS. 37 AND 42), (U.S. CLS. 100, 101, 103 AND 106). SN 75-866,622. PUB. 11-6-2001. FILED 12-7-1999.

2,533,411 (*See Class 35 for this trademark*).

2,533,465 (*See Class 9 for this trademark*).

2,533,486. **MISCELLANEOUS DESIGN.** MR. SPOUTING, INC., (U.S. CLS. 100, 103 AND 106). SN 75-910,650. PUB. 11-6-2001. FILED 2-3-2000.

2,533,493. **MISCELLANEOUS DESIGN.** DOMINION RESOURCES, INC., MULTIPLE CLASS, (INT. CLS. 37, 39, 40 AND 42), (U.S. CLS. 100, 101, 103, 105 AND 106). SN 75-915,730. PUB. 11-6-2001. FILED 2-10-2000.

2,533,495. **SACHS PROPERTIES.** SACHS PROPERTIES, INC., (U.S. CLS. 100, 103 AND 106). SN 75-916,634. PUB. 11-6-2001. FILED 2-11-2000.

2,533,497. **TRADITIONS OF AMERICA HOMES OF TIME-LESSVALUE AND DESIGN.** TRADITIONS OF AMERICA, (U.S. CLS. 100, 103 AND 106). SN 75-917,260. PUB. 11-6-2001. FILED 2-12-2000.

2,533,558 (*See Class 35 for this trademark*).

2,533,603. **ELECTRIC SMARTS.COM.** INDUSTRYSMARTS.COM, MULTIPLE CLASS, (INT. CLS. 37 AND 42), (U.S. CLS. 100, 101, 103 AND 106). SN 76-019,706. PUB. 11-6-2001. FILED 4-6-2000.

2,533,622. **THE SUNDT COMPANIES, INC. AND DESIGN.** SUNDT COMPANIES, INC., THE, (U.S. CLS. 100, 103 AND 106). SN 76-027,448. PUB. 11-6-2001. FILED 4-17-2000.

2,533,670. **COMPUTERPRO.** COMPUTER PRO, INC., (U.S. CLS. 100, 103 AND 106). SN 76-041,573. PUB. 11-6-2001. FILED 5-5-2000.

2,533,677. **THE MAN FOR THE JOB AND DESIGN.** MAN FOR THE JOB, THE, (U.S. CLS. 100, 103 AND 106). SN 76-043,242. PUB. 11-6-2001. FILED 5-4-2000.

2,533,710. **GOBOSH.** CENTRAL DESIGN SYSTEMS, INC., DBA GOBOSH, MULTIPLE CLASS, (INT. CLS. 37 AND 42), (U.S. CLS. 100, 101, 103 AND 106). SN 76-054,972. PUB. 11-6-2001. FILED 5-23-2000.

2,533,736 (*See Class 35 for this trademark*).

2,533,774. **SINGLE SOURCE BY COVERALL.** COVERALL NORTH AMERICA, INC., (U.S. CLS. 100, 103 AND 106). SN 76-077,870. PUB. 11-6-2001. FILED 6-28-2000.

2,533,806. **MISCELLANEOUS DESIGN.** BIOLOGIX SYSTEMS CORP., (U.S. CLS. 100, 103 AND 106). SN 76-091,772. PUB. 11-6-2001. FILED 7-17-2000.

2,533,832. **THE BODY SHOP ALTERNATIVE.** COLORTEC, INC., DBA FINISHZONE, (U.S. CLS. 100, 103 AND 106). SN 76-107,149. PUB. 11-6-2001. FILED 8-10-2000.

2,533,833. **FSM 2.** RUDOLPH/LIBBE INC., (U.S. CLS. 100, 103 AND 106). SN 76-109,054. PUB. 11-6-2001. FILED 8-14-2000.

2,533,834. **FSM 2-COM (STYLIZED).** RUDOLPH/LIBBE INC., (U.S. CLS. 100, 103 AND 106). SN 76-109,055. PUB. 11-6-2001. FILED 8-14-2000.

2,533,856. **MORTON REMODELING NEW LOOKS, OLD VALUES. AND DESIGN.** MORTON SIDING CO., INC., DBA MORTON REMODELING, (U.S. CLS. 100, 103 AND 106). SN 76-121,547. PUB. 11-6-2001. FILED 9-5-2000.

2,533,908 (*See Class 35 for this trademark*).

2,533,977. **CHICAGO MASONRY CONSTRUCTION, INC. AND DESIGN.** CHICAGO MASONRY CONSTRUCTION,

INC., (U.S. CLS. 100, 103 AND 106). SN 76-171,138. PUB. 11-6-2001. FILED 11-27-2000.
 2,534,038 (*See Class 2 for this trademark*).
 2,534,122. **POND CHAMPS**. SANCO CHEMICALS, INC., (U.S. CLS. 100, 103 AND 106). SN 76-209,130. PUB. 11-6-2001. FILED 2-12-2001.
 2,534,140. **BONDED LIGHTNING PROTECTION LIGHTNING ROD SYSTEMS SERVING THE SOUTHERN UNITED STATES SINCE 1950 AND DESIGN**. BONDED LIGHTNING PROTECTION SYSTEMS, LTD., (U.S. CLS. 100, 103 AND 106). SN 76-218,993. PUB. 11-6-2001. FILED 3-5-2001.
 2,534,264. **CORPOREX AND DESIGN**. CORPOREX COMPANIES, INC., (U.S. CLS. 100, 103 AND 106). SN 76-288,179. PUB. 11-6-2001. FILED 7-20-2001.
 2,534,292. **I AND DESIGN**. INDUSTRIAL WELDING (OF SWEDEN), INC., (U.S. CLS. 100, 103 AND 106). SN 76-294,433. PUB. 11-6-2001. FILED 8-3-2001.
 2,534,306. **SUPPLIERCONNECT**. W.W. GRAINGER, INC., (U.S. CLS. 100, 103 AND 106). SN 78-015,129. PUB. 11-6-2001. FILED 6-30-2000.
 2,534,315. **CHIPMASTERS, INC. AND DESIGN**. CHIPMASTERS, INC., (U.S. CLS. 100, 103 AND 106). SN 78-024,454. PUB. 11-6-2001. FILED 9-5-2000.
 2,534,321. **BATTERY SERVICE AND DESIGN**. CLUB ASSIST INTERNATIONAL INC., (U.S. CLS. 100, 103 AND 106). SN 78-038,993. PUB. 11-6-2001. FILED 12-12-2000.
 2,534,329. **THE DENT SHIELD**. ACUCOR, INC., (U.S. CLS. 100, 103 AND 106). SN 78-062,713. PUB. 11-6-2001. FILED 5-9-2001.

CLASS 38—COMMUNICATION

2,533,227 (*See Class 35 for this trademark*).
 2,533,233. **EZNET**. CENTRAL CITY ON-LINE, INC., (U.S. CLS. 100, 101 AND 104). SN 75-551,239. PUB. 11-6-2001. FILED 9-11-1998.
 2,533,236 (*See Class 14 for this trademark*).
 2,533,246 (*See Class 35 for this trademark*).
 2,533,248. **THE CHURCH CHANNEL AND DESIGN**. TRINITY CHRISTIAN CENTER OF SANTA ANA, INC., (U.S. CLS. 100, 101 AND 104). SN 75-596,966. PUB. 11-6-2001. FILED 11-30-1998.
 2,533,341. **MXP**. HNI ACQUISITION, INC., BY ASSIGNMENT HARVARDNET, INC., (U.S. CLS. 100, 101 AND 104). SN 75-777,863. PUB. 11-6-2001. FILED 8-17-1999.
 2,533,361 (*See Class 9 for this trademark*).
 2,533,380. **VOTE.COM AND DESIGN**. VOTE.COM, INC., MULTIPLE CLASS, (INT. CLS. 38 AND 42), (U.S. CLS. 100, 101 AND 104). SN 75-840,308. PUB. 11-6-2001. FILED 11-24-1999.
 2,533,436 (*See Class 35 for this trademark*).
 2,533,438. **FIBERFAX**. PENNWELL CORPORATION, (U.S. CLS. 100, 101 AND 104). SN 75-885,666. PUB. 11-6-2001. FILED 1-3-2000.
 2,533,455. **ROSE.NET EXPRESS**. CITY OF THOMASVILLE, GEORGIA, (U.S. CLS. 100, 101 AND 104). SN 75-893,398. PUB. 11-6-2001. FILED 1-7-2000.
 2,533,463. **THESTATUS**. PUBLIC KNOWLEDGE SYSTEMS, LLC, MULTIPLE CLASS, (INT. CLS. 38 AND 42), (U.S. CLS. 100, 101 AND 104). SN 75-897,041. PUB. 11-6-2001. FILED 1-14-2000.
 2,533,467. **DIRECTVIEW**. METROCALL, INC., (U.S. CLS. 100, 101 AND 104). SN 75-900,688. PUB. 11-6-2001. FILED 1-21-2000.
 2,533,513. **D.S.LYNX**. BUSINESS TELECOM, INC., (U.S. CLS. 100, 101 AND 104). SN 75-924,791. PUB. 11-6-2001. FILED 2-22-2000.
 2,533,524. **WORLD ACCESS COMMUNICATIONS (STYLIZED)**. SEMINAR RESOURCES, INC., MULTIPLE CLASS, (INT. CLS. 38 AND 42), (U.S. CLS. 100, 101 AND 104). SN 75-929,736. PUB. 11-6-2001. FILED 2-29-2000.
 2,533,549. **EDUSCORE**. CALSCIENCE ENGINEERING AND LABORATORIES INC., MULTIPLE CLASS, (INT. CLS. 38 AND 41), (U.S. CLS. 100, 101, 104 AND 107). SN 75-938,385. PUB. 11-6-2001. FILED 3-7-2000.
 2,533,631. **ECONFER (STYLIZED)**. CONFERENCE PLUS,

INC., (U.S. CLS. 100, 101 AND 104). SN 76-029,640. PUB. 11-6-2001. FILED 4-18-2000.
 2,533,709 (*See Class 16 for this trademark*).
 2,533,785. **VOICESTREAM WIRELESS AND DESIGN**. VOICESTREAM WIRELESS CORPORATION, (U.S. CLS. 100, 101 AND 104). SN 76-083,764. PUB. 11-6-2001. FILED 7-6-2000.
 2,533,788. **COMEDY CENTRAL AND DESIGN**. VIACOM HA! HOLDING COMPANY, MULTIPLE CLASS, (INT. CLS. 38 AND 41), (U.S. CLS. 100, 101, 104 AND 107). SN 76-085,055. PUB. 11-6-2001. FILED 7-7-2000.
 2,533,795. **UNIKIT**. CHU, GENE C., (U.S. CLS. 100, 101 AND 104). SN 76-087,248. PUB. 11-6-2001. FILED 7-12-2000.
 2,533,829. **SNAPMAIL**. KIM, YOUNGMI, (U.S. CLS. 100, 101 AND 104). SN 76-106,169. PUB. 11-6-2001. FILED 8-10-2000.
 2,533,888. **APPRISS**. APPRISS, INC., (U.S. CLS. 100, 101 AND 104). SN 76-136,787. PUB. 11-6-2001. FILED 9-28-2000.
 2,533,889. **INTELLIGENT COMMUNICATION SOLUTIONS**. APPRISS, INC., (U.S. CLS. 100, 101 AND 104). SN 76-136,788. PUB. 11-6-2001. FILED 9-28-2000.
 2,533,914. **ALTRIO COMMUNICATIONS INC. AND DESIGN**. ALTRIO COMMUNICATIONS, INC., (U.S. CLS. 100, 101 AND 104). SN 76-148,872. PUB. 11-6-2001. FILED 10-18-2000.
 2,533,915. **ALTRIO COMMUNICATIONS**. ALTRIO COMMUNICATIONS, INC., (U.S. CLS. 100, 101 AND 104). SN 76-148,873. PUB. 11-6-2001. FILED 10-18-2000.
 2,533,928. **MAXMEETING**. OMX, INC., (U.S. CLS. 100, 101 AND 104). SN 76-154,912. PUB. 11-6-2001. FILED 10-27-2000.
 2,533,988. **COM EASE.COM AND DESIGN**. COMEASE.COM, INC., (U.S. CLS. 100, 101 AND 104). SN 76-174,201. PUB. 11-6-2001. FILED 12-4-2000.
 2,534,031. **VALLEY TELECOM GROUP AND DESIGN**. VALLEY TELEPHONE COOPERATIVE, INC., (U.S. CLS. 100, 101 AND 104). SN 76-187,175. PUB. 11-6-2001. FILED 12-27-2000.
 2,534,200. **SUSCOM**. SUSQUEHANNA CABLE INVESTMENT CO., (U.S. CLS. 100, 101 AND 104). SN 76-259,220. PUB. 11-6-2001. FILED 5-21-2001.

CLASS 39—TRANSPORTATION AND STORAGE

2,533,200 (*See Class 35 for this trademark*).
 2,533,231 (*See Class 35 for this trademark*).
 2,533,250 (*See Class 35 for this trademark*).
 2,533,263 (*See Class 4 for this trademark*).
 2,533,266. **RAIN FOREST AERIAL TRAM**. CONSERVATION TOURISM, LTD., (U.S. CLS. 100 AND 105). SN 75-641,034. PUB. 11-6-2001. FILED 2-16-1999.
 2,533,284. **KING OF MARINAS**. PROPLAS HOLDINGS INC., (U.S. CLS. 100 AND 105). SN 75-672,013. PUB. 11-6-2001. FILED 3-30-1999.
 2,533,295. **ZENITH**. CELEBRITY CRUISES INC., (U.S. CLS. 100 AND 105). SN 75-707,942. PUB. 11-6-2001. FILED 5-18-1999.
 2,533,477. **CARLIE**. CARLIE MOBILE SELF STORE LLLC, (U.S. CLS. 100 AND 105). SN 75-903,563. PUB. 11-6-2001. FILED 1-26-2000.
 2,533,493 (*See Class 37 for this trademark*).
 2,533,532. **SJI INC.**, SJI, INC., (U.S. CLS. 100 AND 105). SN 75-932,254. PUB. 11-6-2001. FILED 3-1-2000.
 2,533,679. **FLEXI-FLEET**. CSX TRANSPORTATION, INC., (U.S. CLS. 100 AND 105). SN 76-043,270. PUB. 11-6-2001. FILED 5-8-2000.
 2,533,736 (*See Class 35 for this trademark*).
 2,533,739. **WOW TRANSPORT, INC.**, WOW TRANSPORT, INC., (U.S. CLS. 100 AND 105). SN 76-064,669. PUB. 11-6-2001. FILED 6-7-2000.
 2,533,752. **WHERE THE WORLD OF TRAVEL BEGINS**. FOX VALLEY TRAVEL AGENCY, INC., (U.S. CLS. 100 AND 105). SN 76-070,199. PUB. 11-6-2001. FILED 6-15-2000.
 2,533,797. **CARRIER POINT AND DESIGN**. CARRIERPOINT, INC., (U.S. CLS. 100 AND 105). SN 76-087,850. PUB. 11-6-2001. FILED 7-11-2000.
 2,533,869. **GOPHER ADVENTURES**. GOPHER ADVENTURES, LTD., MULTIPLE CLASS, (INT. CLS. 39 AND 41), (U.S. CLS. 100, 101, 105 AND 107). SN 76-129,877. PUB.

- 11-6-2001. FILED 9-15-2000.
 2,533,872. **KIDZ CAB CREATED BY MOMS FOR MOMS AND DESIGN.** KIDZ CAB, INC., (U.S. CLS. 100 AND 105). SN 76-130,192. PUB. 11-6-2001. FILED 9-19-2000.
 2,533,916. **BURLEE.** BURLEE NETWORKS, LLC, MULTIPLE CLASS, (INT. CLS. 39 AND 42), (U.S. CLS. 100, 101 AND 105). SN 76-149,996. PUB. 11-6-2001. FILED 10-19-2000.
 2,533,917. **:/B AND DESIGN.** BURLEE NETWORKS, LLC, MULTIPLE CLASS, (INT. CLS. 39 AND 42), (U.S. CLS. 100, 101 AND 105). SN 76-149,999. PUB. 11-6-2001. FILED 10-19-2000.
 2,533,963. **THE TRADITION CONTINUES.** CENTRAL FREIGHT LINES, INC., (U.S. CLS. 100 AND 105). SN 76-164,770. PUB. 11-6-2001. FILED S.R. 11-13-2000; AM. P.R. 2-6-2000.
 2,534,060 (*See Class 35 for this trademark*).
 2,534,061 (*See Class 35 for this trademark*).
 2,534,072. **SERVICE THAT NEVER STOPS.** CITY EXPRESS, INC., (U.S. CLS. 100 AND 105). SN 76-199,011. PUB. 11-6-2001. FILED 1-25-2001.
 2,534,185. **AIR ENHANCED.** DROP SHIP EXPRESS, INC., (U.S. CLS. 100 AND 105). SN 76-237,514. PUB. 11-6-2001. FILED 4-9-2001.
 2,534,277. **YOU'LL LIKE WHERE WE'RE GOING.** VANGUARD AIRLINES, INC., (U.S. CLS. 100 AND 105). SN 76-291,841. PUB. 11-6-2001. FILED 7-27-2001.
 POCHO PRODUCTION, AND ZAMORA, DEL, DBA POCHO PRODUCTION, (U.S. CLS. 100, 101 AND 107). SN 75-571,655. PUB. 11-6-2001. FILED 10-14-1998.
 2,533,251 (*See Class 9 for this trademark*).
 2,533,269. **ENERGENIUS.** PACIFIC GAS AND ELECTRIC COMPANY, (U.S. CLS. 100, 101 AND 107). SN 75-646,936. PUB. 11-6-2001. FILED 2-24-1999.
 2,533,316 (*See Class 35 for this trademark*).
 2,533,319. **FUTURE OF HEALTH TECHNOLOGY SUMMIT.** BUSHKO, RENATA, (U.S. CLS. 100, 101 AND 107). SN 75-740,061. PUB. 11-6-2001. FILED 7-22-1999.
 2,533,327. **DENTISTRY BY DESIGN AND DESIGN.** MASEK, RICHARD T., (U.S. CLS. 100, 101 AND 107). SN 75-753,506. PUB. 11-6-2001. FILED 7-19-1999.
 2,533,336 (*See Class 35 for this trademark*).
 2,533,339. **STAIRWAY TO HEALTH.** SHANNAN LEATHERMAN, TRUSTEE FOR THE MORDECAI TRUST, (U.S. CLS. 100, 101 AND 107). SN 75-776,200. PUB. 11-6-2001. FILED 8-16-1999.
 2,533,344 (*See Class 16 for this trademark*).
 2,533,356. **SD&M AND DESIGN.** SD&M SOFTWARE DESIGN & MANAGEMENT AG, MULTIPLE CLASS, (INT. CLS. 41 AND 42), (U.S. CLS. 100, 101 AND 107). SN 75-797,756. PUB. 11-6-2001. FILED 9-13-1999.
 2,533,366. **CREATIVITY ON FILM PROJECT AND DESIGN.** ARTISTS RIGHTS FOUNDATION, (U.S. CLS. 100, 101 AND 107). SN 75-819,641. PUB. 11-6-2001. FILED 10-13-1999.
 2,533,370 (*See Class 9 for this trademark*).
 2,533,371 (*See Class 9 for this trademark*).
 2,533,387. **CLICKSPIN AND DESIGN.** CLICKSPIN.COM LLC, BY ASSIGNMENT DEAN CHILDERS: JACK STRELIOFF AND RALPH PIEPLENBOS PARTNERSHIP, THE, (U.S. CLS. 100, 101 AND 107). SN 75-848,344. PUB. 10-30-2001. FILED 11-15-1999.
 2,533,414. **GLUE.** WILDBRAIN.COM, INC., (U.S. CLS. 100, 101 AND 107). SN 75-870,748. PUB. 11-6-2001. FILED 12-10-1999.
 2,533,425. **BJ THE CLOWN AND DESIGN.** SHAW, MIMI BISSONNETTE, (U.S. CLS. 100, 101 AND 107). SN 75-877,923. PUB. 11-6-2001. FILED 12-23-1999.
 2,533,428. **SUN DRAGON.** PINETTE, SUZANNE, (U.S. CLS. 100, 101 AND 107). SN 75-880,318. PUB. 11-6-2001. FILED 1-5-2000.
 2,533,433. **HACKERFEST.** DOX ELECTRONICS INC., (U.S. CLS. 100, 101 AND 107). SN 75-883,888. PUB. 11-6-2001. FILED 12-31-1999.
 2,533,444. **NANCY NELSON (STYLIZED).** TWD ENTERPRISES, INC., (U.S. CLS. 100, 101 AND 107). SN 75-887,647. PUB. 11-6-2001. FILED 1-5-2000.
 2,533,446. **THE TENDER IDOLS.** HOWES, DANIEL, AND WEBBER, IAN, (U.S. CLS. 100, 101 AND 107). SN 75-888,027. PUB. 11-6-2001. FILED 1-6-2000.
 2,533,448. **FREUDIAN FLICKS.** LAW, BONNIE E., (U.S. CLS. 100, 101 AND 107). SN 75-888,801. PUB. 11-6-2001. FILED 1-6-2000.
 2,533,461. **T.R.O.O., GAMERZ THE REAL OTHER OPTION.** T.R.O.O. GAMERZ, (U.S. CLS. 100, 101 AND 107). SN 75-895,906. PUB. 11-6-2001. FILED 12-30-1999.
 2,533,488. **THE CENTER FOR SALES STRATEGY.** CENTER FOR SALES STRATEGY, INC., THE, (U.S. CLS. 100, 101 AND 107). SN 75-912,097. PUB. 11-6-2001. FILED 2-7-2000.
 2,533,494 (*See Class 14 for this trademark*).
 2,533,503. **PW INTERCONFERENCE AND DESIGN.** PHYSICIANS WORLD COMMUNICATIONS GROUP, (U.S. CLS. 100, 101 AND 107). SN 75-919,741. PUB. 11-6-2001. FILED 2-16-2000.
 2,533,514. **TRIBECA PRODUCTIONS.** TRIBECA FILM CENTER, INC., (U.S. CLS. 100, 101 AND 107). SN 75-924,825. PUB. 11-6-2001. FILED 2-22-2000.
 2,533,525. **THE INNER MAGICIAN.** SANDELLA, DEBORAH, DR., (U.S. CLS. 100, 101 AND 107). SN 75-929,880. PUB. 11-6-2001. FILED 2-28-2000.
 2,533,531. **SINGLES SOURCE.** SINGLES SOURCE, INC., (U.S. CLS. 100, 101 AND 107). SN 75-931,950. PUB. 11-6-2001. FILED 2-29-2000.
 2,533,534 (*See Class 35 for this trademark*).
 2,533,535. **THE TOTAL DIVING SYSTEM.** CONCEPT SYSTEMS, INC., DBA SCUBA SCHOOLS INTERNATIONAL, INC., (U.S. CLS. 100, 101 AND 107). SN 75-932,591. PUB. 11-

CLASS 40—MATERIAL TREATMENT

- 2,533,198 (*See Class 35 for this trademark*).
 2,533,250 (*See Class 35 for this trademark*).
 2,533,293. **COLOR QUIZ.** FLINT INK CORPORATION, MULTIPLE CLASS, (INT. CLS. 40 AND 42), (U.S. CLS. 100, 101, 103 AND 106). SN 75-701,103. PUB. 11-6-2001. FILED 5-6-1999.
 2,533,305 (*See Class 6 for this trademark*).
 2,533,378 (*See Class 37 for this trademark*).
 2,533,384. **RTP AND DESIGN.** RUBBER TRIM PRODUCTS, INC., (U.S. CLS. 100, 103 AND 106). SN 75-846,665. PUB. 11-6-2001. FILED 11-12-1999.
 2,533,465 (*See Class 9 for this trademark*).
 2,533,481. **EAST BAY LASER & WATERJET.** CONTRERAS, ROBERT ANDREW, (U.S. CLS. 100, 103 AND 106). SN 75-904,843. PUB. 11-6-2001. FILED 1-28-2000.
 2,533,493 (*See Class 37 for this trademark*).
 2,533,547. **CLAIREMONT ELECTRONICS AND DESIGN AND DESIGN.** CLAIREMONT ELECTRONICS LIMITED, (U.S. CLS. 100, 103 AND 106). SN 75-936,959. PUB. 11-6-2001. FILED 3-6-2000.
 2,533,637. **PARASOL AND DESIGN.** FOLK, MICHAEL R., (U.S. CLS. 100, 103 AND 106). SN 76-032,041. PUB. 11-6-2001. FILED 4-20-2000.
 2,533,979. **CUSTOM CREATIONS.** R&M FABRICS, INC., (U.S. CLS. 100, 103 AND 106). SN 76-171,434. PUB. 11-6-2001. FILED 11-27-2000.
 2,534,311. **BASE-X EXPEDITION SHELTERS AND DESIGN.** BASE-X, INCORPORATED, (U.S. CLS. 100, 103 AND 106). SN 78-018,976. PUB. 11-6-2001. FILED 7-31-2000.

CLASS 41—EDUCATION AND ENTERTAINMENT

- 2,533,201. **COUNTRY RADIO SEMINAR.** COUNTRY RADIO BROADCASTERS, INC., (U.S. CLS. 100, 101 AND 107). SN 75-360,668. PUB. 11-6-2001. FILED 9-22-1997.
 2,533,211 (*See Class 9 for this trademark*).
 2,533,225 (*See Class 9 for this trademark*).
 2,533,232. **RWD TECHNOLOGIES.** RWD TECHNOLOGIES, INC., MULTIPLE CLASS, (INT. CLS. 41 AND 42), (U.S. CLS. 100, 101 AND 107). SN 75-550,655. PUB. 11-6-2001. FILED 9-10-1998.
 2,533,239. **POCHO NEWS NETWORK.** LOPEZ, EDUARDO, DBA POCHO PRODUCTION, AND ZUL, ESTEBAN, DBA

- 6-2001. FILED 3-1-2000.
 2,533,549 (*See Class 38 for this trademark*).
 2,533,585 (*See Class 16 for this trademark*).
 2,533,590. **WRESTLING WORLD CUP AND DESIGN**. BALTIMORE COMMITTEE FOR INTERNATIONAL WRESTLING, INC., (U.S. CLS. 100, 101 AND 107). SN 76-013,874. PUB. 11-6-2001. FILED 3-30-2000.
 2,533,591. **IN THE SPOTLIGHT LLC AND DESIGN**. IN THE SPOTLIGHT, LLC, (U.S. CLS. 100, 101 AND 107). SN 76-014,680. PUB. 11-6-2001. FILED 3-31-2000.
 2,533,592. **RSCHOOL**. RSCHOOL.COM INC., (U.S. CLS. 100, 101 AND 107). SN 76-015,628. PUB. 11-6-2001. FILED 4-3-2000.
 2,533,593. **PROFESSOR REDWORM AND DESIGN**. RODALE INSTITUTE, THE, MULTIPLE CLASS, (INT. CLS. 41 AND 42), (U.S. CLS. 100, 101 AND 107). SN 76-015,683. PUB. 11-6-2001. FILED 4-3-2000.
 2,533,594. **SUNDAY**. BETTER PLACE RECORDS, INC., (U.S. CLS. 100, 101 AND 107). SN 76-015,883. PUB. 11-6-2001. FILED 4-3-2000.
 2,533,606. **SMASHITS**. SMASHITS.COM, LLC., (U.S. CLS. 100, 101 AND 107). SN 76-021,554. PUB. 11-6-2001. FILED 4-7-2000.
 2,533,615 (*See Class 9 for this trademark*).
 2,533,617. **THE FUTURE IS ABOUT PEOPLE.** CHAMBERBENEFITS, INC., (U.S. CLS. 100, 101 AND 107). SN 76-025,109. PUB. 11-6-2001. FILED 4-13-2000.
 2,533,633. **PRETTIEST PAINTED PLACES IN AMERICA AND DESIGN**. ROHM AND HAAS COMPANY, MULTIPLE CLASS, (INT. CLS. 41 AND 42), (U.S. CLS. 100, 101 AND 107). SN 76-029,776. PUB. 11-6-2001. FILED 4-19-2000.
 2,533,647. **EBUS**. COMMUNITY COLLEGE FOUNDATION, (U.S. CLS. 100, 101 AND 107). SN 76-036,196. PUB. 11-6-2001. FILED 4-24-2000.
 2,533,663. **RADAR PICTURES AND DESIGN**. RADAR PICTURES, INC., (U.S. CLS. 100, 101 AND 107). SN 76-039,891. PUB. 11-6-2001. FILED 5-1-2000.
 2,533,669. **MATHSTORIES**. BANSAL, ASHOK, (U.S. CLS. 100, 101 AND 107). SN 76-041,539. PUB. 11-6-2001. FILED 5-5-2000.
 2,533,696. **CLAYTON COLLEGE OF NATURAL HEALTH AND DESIGN**. CLAYTON COLLEGE OF NATURAL HEALTH, INC., (U.S. CLS. 100, 101 AND 107). SN 76-050,176. PUB. 11-6-2001. FILED 5-16-2000.
 2,533,706. **PATHWAYS AND DESIGN**. PATHWAYS, INC., MULTIPLE CLASS, (INT. CLS. 41 AND 42), (U.S. CLS. 100, 101 AND 107). SN 76-053,692. PUB. 11-6-2001. FILED 5-22-2000.
 2,533,709 (*See Class 16 for this trademark*).
 2,533,742. **RENEW**. RENEW SYSTEMS, INC., (U.S. CLS. 100, 101 AND 107). SN 76-065,874. PUB. 11-6-2001. FILED 6-8-2000.
 2,533,747 (*See Class 5 for this trademark*).
 2,533,748. **THE PLAZA WAX MUSEUM AND DESIGN**. CLASSIC ATTRACTION, INC., (U.S. CLS. 100, 101 AND 107). SN 76-069,196. PUB. 11-6-2001. FILED 6-13-2000.
 2,533,754. **WARNING FILMSPEED BIG STREAM AND DESIGN**. AXE DIGITAL TELEVISION, INC., DBA FILMSPEED, (U.S. CLS. 100, 101 AND 107). SN 76-070,845. PUB. 11-6-2001. FILED 6-14-2000.
 2,533,755. **BOGGLE-GOGGLE AND DESIGN**. BOGGLE GOGGLE ENTERPRISES, LLC, (U.S. CLS. 100, 101 AND 107). SN 76-070,991. PUB. 11-6-2001. FILED 6-15-2000.
 2,533,756 (*See Class 28 for this trademark*).
 2,533,758. **CET CENTER FOR EMPLOYMENT TRAINING SKILL TRAINING*HUMAN DEVELOPMENT AND DESIGN**. CENTER FOR EMPLOYMENT TRAINING, (U.S. CLS. 100, 101 AND 107). SN 76-071,471. PUB. 11-6-2001. FILED 6-16-2000.
 2,533,767. **TURBO LUGE**. FOX FAMILY PROPERTIES, INC., (U.S. CLS. 100, 101 AND 107). SN 76-075,712. PUB. 11-6-2001. FILED 6-20-2000.
 2,533,776. **ADVENTURE BUCKS**. ADVENTURE GOLF & GAMES, INC., (U.S. CLS. 100, 101 AND 107). SN 76-078,335. PUB. 11-6-2001. FILED 6-19-2000.
 2,533,788 (*See Class 38 for this trademark*).
 2,533,791. **MISCELLANEOUS DESIGN**. WEHOCHURCH.-COM, (U.S. CLS. 100, 101 AND 107). SN 76-085,574. PUB. 10-9-2001. FILED 7-7-2000.
 2,533,814. **CARDEN METHOD**. CARDEN EDUCATIONAL FOUNDATION, INC., (U.S. CLS. 100, 101 AND 107). SN 76-094,276. PUB. 11-6-2001. FILED 7-20-2000.
 2,533,847. **USDLA UNITED STATES DISTANCE LEARNING ASSOCIATION AND DESIGN**. UNITED STATES DISTANCE LEARNING ASSOCIATION, MULTIPLE CLASS, (INT. CLS. 41 AND 42), (U.S. CLS. 100, 101 AND 107). SN 76-117,641. PUB. 11-6-2001. FILED 8-28-2000.
 2,533,857. **MAKE YOUR GAME**. FOREAMERICA, INC., (U.S. CLS. 100, 101 AND 107). SN 76-122,617. PUB. 11-6-2001. FILED 9-1-2000.
 2,533,869 (*See Class 39 for this trademark*).
 2,533,880. **NATIONAL SPORTS LAW INSTITUTE MARQUETTE UNIVERSITY LAW SCHOOL AND DESIGN**. MARQUETTE UNIVERSITY, (U.S. CLS. 100, 101 AND 107). SN 76-133,371. PUB. 11-6-2001. FILED 9-22-2000.
 2,533,883. **FREERIDE MOTO-X CHAMPIONSHIPS**. FREERIDE MOTOX, LLC, (U.S. CLS. 100, 101 AND 107). SN 76-134,181. PUB. 11-6-2001. FILED 9-25-2000.
 2,533,903. **REDS AND DESIGN**. CINCINNATI REDS, LLC, THE, (U.S. CLS. 100, 101 AND 107). SN 76-142,540. PUB. 11-6-2001. FILED 10-6-2000.
 2,533,904. **C (STYLIZED)**. CINCINNATI REDS, LLC, THE, (U.S. CLS. 100, 101 AND 107). SN 76-142,541. PUB. 11-6-2001. FILED 10-6-2000.
 2,533,909. **MISCELLANEOUS DESIGN**. REDVECTOR.COM, INC., (U.S. CLS. 100, 101 AND 107). SN 76-147,424. PUB. 11-6-2001. FILED 10-16-2000.
 2,533,910. **REDVECTOR.COM**. REDVECTOR.COM, INC., (U.S. CLS. 100, 101 AND 107). SN 76-147,439. PUB. 11-6-2001. FILED 10-16-2000.
 2,533,919. **ASIAN GTF**. FLORIDA GOLF SCHOOL, INC., THE, DBA UNITED STATES GOLF TEACHERS FEDERATION, MULTIPLE CLASS, (INT. CLS. 41 AND 42), (U.S. CLS. 100, 101 AND 107). SN 76-150,195. PUB. 11-6-2001. FILED 10-20-2000.
 2,533,922. **RUSSELL**. FRANK RUSSELL COMPANY, (U.S. CLS. 100, 101 AND 107). SN 76-152,177. PUB. 11-6-2001. FILED 10-23-2000.
 2,533,931 (*See Class 35 for this trademark*).
 2,533,932. **MERCURY BOY**. TERZI, NICHOLAS, (U.S. CLS. 100, 101 AND 107). SN 76-155,837. PUB. 11-6-2001. FILED 10-30-2000.
 2,533,937. **THE ISLAND SCHOOL**. CAPE ELEUTHERA ISLAND SCHOOL, (U.S. CLS. 100, 101 AND 107). SN 76-156,927. PUB. 11-6-2001. FILED 10-31-2000.
 2,533,938. **BABY OTTER SWIM SCHOOL**. BABY OTTER SWIM SCHOOL, INC., (U.S. CLS. 100, 101 AND 107). SN 76-157,084. PUB. 11-6-2001. FILED 11-1-2000.
 2,533,947. **INCLUSION FIRST**. INCLUSION FIRST L.L.C., (U.S. CLS. 100, 101 AND 107). SN 76-159,783. PUB. 11-6-2001. FILED 11-6-2000.
 2,533,951. **MAMA PASCUCCI'S RAVIOLI AND TAP DANCE LESSON**. RAVE REVIEWS, INC., (U.S. CLS. 100, 101 AND 107). SN 76-161,188. PUB. 11-6-2001. FILED 11-7-2000.
 2,533,953. **CULINARY HARVEST**. OLSON COMMUNICATIONS, INC., (U.S. CLS. 100, 101 AND 107). SN 76-162,240. PUB. 11-6-2001. FILED 11-8-2000.
 2,533,957. **BETWEEN THE LIONS AND DESIGN**. WGBH EDUCATIONAL FOUNDATION, (U.S. CLS. 100, 101 AND 107). SN 76-164,145. PUB. 11-6-2001. FILED 11-13-2000.
 2,533,965. **BUBBLE-MANIA**. CARLE, CASEY M, DBA K&C ENTERPRISES, (U.S. CLS. 100, 101 AND 107). SN 76-165,165. PUB. 11-6-2001. FILED 11-15-2000.
 2,533,990. **MCGREW.NET INC. AND DESIGN**. MCGREW.-NET INC., MULTIPLE CLASS, (INT. CLS. 41 AND 42), (U.S. CLS. 100, 101 AND 107). SN 76-175,439. PUB. 11-6-2001. FILED 12-5-2000.
 2,533,991 (*See Class 30 for this trademark*).
 2,533,992. **THE ACTION LEVEL**. APPLIED INDUSTRIAL HYGIENE, INC., (U.S. CLS. 100, 101 AND 107). SN 76-175,862. PUB. 11-6-2001. FILED 12-5-2000.
 2,533,998. **NYB NONE OF YOUR BUSINESS AND DESIGN**. POTENZA, JOHN J., (U.S. CLS. 100, 101 AND 107). SN 76-179,128. PUB. 11-6-2001. FILED 12-12-2000.
 2,534,011. **CE CE3000.COM (STYLIZED)**. CE3000.COM, (U.S. CLS. 100, 101 AND 107). SN 76-183,240. PUB. 11-6-2001.

- FILED 12-18-2000.
- 2,534,021. **ASHEVILLE NC'S CENTER FOR MASSAGE & NATURAL HEALTH.** PMG HEALTHCOM, INC., (U.S. CLS. 100, 101 AND 107). SN 76-185,293. PUB. 11-6-2001. FILED 12-21-2000.
- 2,534,024. **CENTER FOR ANTHROPOLOGY RESEARCH AND RENEWAL.** CENTER FOR ANTHROPOLOGY, (U.S. CLS. 100, 101 AND 107). SN 76-185,484. PUB. 11-6-2001. FILED 12-21-2000.
- 2,534,027. **CFNP.** FNS, INC., (U.S. CLS. 100, 101 AND 107). SN 76-186,340. PUB. 11-6-2001. FILED 12-27-2000.
- 2,534,052. **LOVE SOUP.** MIDWEST TELEVISION, INC., (U.S. CLS. 100, 101 AND 107). SN 76-194,011. PUB. 11-6-2001. FILED 1-11-2001.
- 2,534,055. **ACCESS MEXICO.** MEXICAN CULTURAL INSTITUTE OF HOUSTON, INC., (U.S. CLS. 100, 101 AND 107). SN 76-196,024. PUB. 11-6-2001. FILED 1-16-2001.
- 2,534,058. **1887 AND DESIGN.** CLARK UNIVERSITY, (U.S. CLS. 100, 101 AND 107). SN 76-197,074. PUB. 11-6-2001. FILED 1-19-2001.
- 2,534,063. **THE FOUR ACES.** FOUR ACES, THE, (U.S. CLS. 100, 101 AND 107). SN 76-197,475. PUB. 11-6-2001. FILED 1-22-2001.
- 2,534,082 (*See Class 9 for this trademark*).
- 2,534,087. **THE KING ON A STRING.** MOLLIKA, DAVID, (U.S. CLS. 100, 101 AND 107). SN 76-202,479. PUB. 11-6-2001. FILED 2-1-2001.
- 2,534,095. **TMP TRUSTEES MASTERS PROGRAM (STYLIZED).** INTERNATIONAL FOUNDATION OF EMPLOYEE BENEFIT PLANS, INC., (U.S. CLS. 100, 101 AND 107). SN 76-203,734. PUB. 11-6-2001. FILED 2-1-2001.
- 2,534,102. **BEAR ROCK JUNCTION STOP LOOK LISTEN RECREATION PARK AND DESIGN.** BEAR ROCK JUNCTION, INC., (U.S. CLS. 100, 101 AND 107). SN 76-205,170. PUB. 11-6-2001. FILED 2-5-2001.
- 2,534,115. **TRIDENT TECHNICAL COLLEGE AND DESIGN.** BERKELEY-CHARLESTON-DORCHESTER TECHNICAL EDUCATION CENTER, AKA TRIDENT TECHNICAL COLLEGE, (U.S. CLS. 100, 101 AND 107). SN 76-208,176. PUB. 11-6-2001. FILED 2-9-2001.
- 2,534,120. **SHOPPING SMART.** LEMPERS, PHILLIP, (U.S. CLS. 100, 101 AND 107). SN 76-208,982. PUB. 11-6-2001. FILED 2-12-2001.
- 2,534,133. **IMAGENIUS.COM INCORPORATED (STYLIZED).** IMAGENIUS.COM INC., (U.S. CLS. 100, 101 AND 107). SN 76-214,023. PUB. 11-6-2001. FILED 2-21-2001.
- 2,534,144. **MEDIAADDICT.** MEDIAADDICT, INC., (U.S. CLS. 100, 101 AND 107). SN 76-220,520. PUB. 11-6-2001. FILED 3-7-2001.
- 2,534,167. **PACIFICO.** CERVECERIA DEL PACIFICO, S.A. DE C.V., (U.S. CLS. 100, 101 AND 107). SN 76-229,562. PUB. 11-6-2001. FILED 3-26-2001.
- 2,534,172. **EVERYBODY LOVES AMELIA.** AMELIA ISLAND COMPANY, MULTIPLE CLASS, (INT. CLS. 41 AND 42), (U.S. CLS. 100, 101 AND 107). SN 76-231,962. PUB. 11-6-2001. FILED 3-29-2001.
- 2,534,178. **WEIGH OF WISDOM WORKSHOP.** WESTBROOK, GREG, (U.S. CLS. 100, 101 AND 107). SN 76-235,572. PUB. 11-6-2001. FILED 4-6-2001.
- 2,534,180. **MANYS (STYLIZED).** MOTORCYCLE ASSOCIATION OF NEW YORK STATE, INC., THE, (U.S. CLS. 100, 101 AND 107). SN 76-236,688. PUB. 11-6-2001. FILED 4-5-2001.
- 2,534,181. **MANYS.** MOTORCYCLE ASSOCIATION OF NEW YORK STATE, INC., THE, (U.S. CLS. 100, 101 AND 107). SN 76-236,689. PUB. 11-6-2001. FILED 4-5-2001.
- 2,534,182. **THE SAVVY TRAVELER.** MINNESOTA PUBLIC RADIO, (U.S. CLS. 100, 101 AND 107). SN 76-236,865. PUB. 11-6-2001. FILED 4-9-2001.
- 2,534,183. **MAINSTREET RADIO.** MINNESOTA PUBLIC RADIO, (U.S. CLS. 100, 101 AND 107). SN 76-236,873. PUB. 11-6-2001. FILED 4-9-2001.
- 2,534,192. **CHERRY TREE HILL YARN.** POTTER, CHERYL, (U.S. CLS. 100, 101 AND 107). SN 76-240,704. PUB. 11-6-2001. FILED 4-13-2001.
- 2,534,206. **RESTORING THE ART.** STARKEY & ASSOCIATES, INC., (U.S. CLS. 100, 101 AND 107). SN 76-267,418. PUB. 11-6-2001. FILED 6-5-2001.
- 2,534,222. **MIKE AND MIKE IN THE MORNING.** ESPN, INC., (U.S. CLS. 100, 101 AND 107). SN 76-276,533. PUB. 11-6-2001. FILED 6-25-2001.
- 2,534,223 (*See Class 35 for this trademark*).
- 2,534,227. **MGM.** METRO-GOLDWYN-MAYER LION CORP., (U.S. CLS. 100, 101 AND 107). SN 76-278,837. PUB. 11-6-2001. FILED 6-28-2001.
- 2,534,231. **MISCELLANEOUS DESIGN.** AF2 ENTERPRISES LLC, (U.S. CLS. 100, 101 AND 107). SN 76-279,674. PUB. 11-6-2001. FILED 7-2-2001.
- 2,534,239. **EVERY PERSON'S GATEWAY.** MILWAUKEE PUBLIC LIBRARY BOARD OF TRUSTEES, (U.S. CLS. 100, 101 AND 107). SN 76-281,786. PUB. 11-6-2001. FILED 7-9-2001.
- 2,534,258. **INTERNEXUS.** INTERNEXUS, INC., (U.S. CLS. 100, 101 AND 107). SN 76-285,760. PUB. 11-6-2001. FILED 7-16-2001.
- 2,534,259. **INTERNEXUS A GLOBAL EDUCATION NETWORK (STYLIZED).** INTERNEXUS, INC., (U.S. CLS. 100, 101 AND 107). SN 76-285,762. PUB. 11-6-2001. FILED 7-16-2001.
- 2,534,271. **POWDERBURN.** JENNINGS, KERRY A., (U.S. CLS. 100, 101 AND 107). SN 76-290,147. PUB. 11-6-2001. FILED 7-24-2001.
- 2,534,273. **ROCHESTER BRIGADE.** AF2 ENTERPRISES LLC, (U.S. CLS. 100, 101 AND 107). SN 76-291,744. PUB. 11-6-2001. FILED 7-30-2001.
- 2,534,274. **BATON ROUGE BLAZE.** AF2 ENTERPRISES LLC, (U.S. CLS. 100, 101 AND 107). SN 76-291,747. PUB. 11-6-2001. FILED 7-30-2001.
- 2,534,275 (*See Class 16 for this trademark*).
- 2,534,288 (*See Class 16 for this trademark*).
- 2,534,289 (*See Class 16 for this trademark*).
- 2,534,293 (*See Class 16 for this trademark*).
- 2,534,297. **PETER FRAMPTON.** FRAMPTON, PETER, (U.S. CLS. 100, 101 AND 107). SN 76-299,170. PUB. 11-6-2001. FILED 8-9-2001.
- 2,534,305. **PARALLAX PICTURES FEATURE & COMMERCIAL FILM & TELEVISION PRODUCTION P P I AU AND DESIGN.** PARALLAX PICTURES, (U.S. CLS. 100, 101 AND 107). SN 78-012,729. PUB. 11-6-2001. FILED 6-14-2000.
- 2,534,319. **MAGIC DIAMOND CASINOS AND DESIGN.** TOWN PUMP, INC., MULTIPLE CLASS, (INT. CLS. 41 AND 42), (U.S. CLS. 100, 101 AND 107). SN 78-037,196. PUB. 11-6-2001. FILED 11-30-2000.
- 2,534,324. **MUSIC FOR ALL...FOR LIFE!** ROCKY MOUNTAIN CENTER FOR MUSICAL ARTS, (U.S. CLS. 100, 101 AND 107). SN 78-047,360. PUB. 11-6-2001. FILED 2-8-2001.
- 2,534,333. **EMAILPSYCHIC.COM.** SMITH, TREVOR AUGUSTINE, (U.S. CLS. 100, 101 AND 107). SN 78-065,989. PUB. 11-6-2001. FILED 5-27-2001.
- 2,534,335. **NEWGROUND.** NEWGROUND RESOURCES, INC., (U.S. CLS. 100, 101 AND 107). SN 78-066,621. PUB. 11-6-2001. FILED 5-31-2001.
- 2,534,343. **BLOWFISH MUSIC TO DIE FOR.** BLOWFISH LLC, (U.S. CLS. 100, 101 AND 107). SN 78-071,304. PUB. 11-6-2001. FILED 6-27-2001.

CLASS 42—SCIENTIFIC, COMPUTER AND LEGAL SERVICES

- 2,533,195. **VETSELECT AND DESIGN.** NINE MILE ROAD VETERINARY CLINIC P.C., (U.S. CLS. 100 AND 101). SN 75-254,490. PUB. 11-6-2001. FILED 3-10-1997.
- 2,533,207 (*See Class 10 for this trademark*).
- 2,533,222. **WINDOW COMFORT.** BUILDING INSIGHT TECHNOLOGIES INC., (U.S. CLS. 100 AND 101). SN 75-504,260. PUB. 11-6-2001. FILED 6-18-1998.
- 2,533,223 (*See Class 35 for this trademark*).
- 2,533,227 (*See Class 35 for this trademark*).
- 2,533,231 (*See Class 35 for this trademark*).
- 2,533,232 (*See Class 41 for this trademark*).
- 2,533,240 (*See Class 5 for this trademark*).
- 2,533,244. **HIGHLANDS.** EASTGATE HEALTH CARE CENTER, INC., (U.S. CLS. 100 AND 101). SN 75-583,902. PUB. 11-6-2001. FILED 11-6-1998.

- 2,533,245. **CELESTIAL SHOWER**. KSL DESERT RESORTS, INC., (U.S. CLS. 100 AND 101). SN 75-584,675. PUB. 11-6-2001. FILED 11-6-1998.
- 2,533,246 (*See Class 35 for this trademark*).
- 2,533,249. **TARGET STATISTICAL ANALYSIS**. TARGET MARKETING, INC., (U.S. CLS. 100 AND 101). SN 75-599,265. PUB. 5-29-2001. FILED 12-3-1998.
- 2,533,250 (*See Class 35 for this trademark*).
- 2,533,262. **GIFTSURFER'S DIGEST AND DESIGN**. ROSENBERG, EVA, AND CORDELL, RICKY G., (U.S. CLS. 100 AND 101). SN 75-625,037. PUB. 11-6-2001. FILED 1-22-1999.
- 2,533,272. **PRIELA AND DESIGN**. PRIELA S.A., (U.S. CLS. 100 AND 101). SN 75-655,320. PUB. 11-6-2001. FILED 3-8-1999.
- 2,533,280. **DAVIS + HENDERSON AND DESIGN**. MDC CORPORATION INC., BY CHANGE OF NAME MDC COMMUNICATIONS CORPORATION, (U.S. CLS. 100 AND 101). SN 75-667,565. PUB. 11-6-2001. FILED 3-25-1999.
- 2,533,290. **THOR**. TRAVEL INDUSTRIES, INC., DBA THOR 24; THOR 24, INC.; AND THOR, INC. (U.S. CLS. 100 AND 101). SN 75-693,851. PUB. 11-6-2001. FILED 4-28-1999.
- 2,533,293 (*See Class 40 for this trademark*).
- 2,533,301. **TECHTRADER**. IMPERIAL BANK, (U.S. CLS. 100 AND 101). SN 75-712,262. PUB. 11-6-2001. FILED 5-24-1999.
- 2,533,312. **IVILLAGE AND DESIGN**. IVILLAGE INC., (U.S. CLS. 100 AND 101). SN 75-733,384. PUB. 11-6-2001. FILED 6-21-1999.
- 2,533,313 (*See Class 30 for this trademark*).
- 2,533,316 (*See Class 35 for this trademark*).
- 2,533,320 (*See Class 1 for this trademark*).
- 2,533,328. **X CA CONVERGENCE ARCHITECTURE AND DESIGN**. REFERENCE N.V., THE, (U.S. CLS. 100 AND 101). SN 75-757,667. PUB. 11-6-2001. FILED 7-22-1999.
- 2,533,329 (*See Class 30 for this trademark*).
- 2,533,335. **QUESTION IT AND DESIGN**. PARTNERSHIP FOR A HEALTHY MISSISSIPPI, (U.S. CLS. 100 AND 101). SN 75-770,975. PUB. 11-6-2001. FILED 8-9-1999.
- 2,533,337. **MISCELLANEOUS DESIGN**. OPERATIONS SECURITY INTERNATIONAL, INC., (U.S. CLS. 100 AND 101). SN 75-774,330. PUB. 11-6-2001. FILED 8-12-1999.
- 2,533,343. **DATABASE RX**. DATABASE SPECIALISTS, INC., (U.S. CLS. 100 AND 101). SN 75-781,574. PUB. 11-6-2001. FILED 8-23-1999.
- 2,533,348. **BUILDINGSNOW.COM ARCHITECTURE ON THE FASTTRACK**. BUILDINGSNOW.COM ARCHITECTURE ON THE FAST TRACK, (U.S. CLS. 100 AND 101). SN 75-790,454. PUB. 11-6-2001. FILED 9-28-1999.
- 2,533,351. **SOFT TOUCH**. SG COWEN SECURITIES CORPORATION, (U.S. CLS. 100 AND 101). SN 75-793,093. PUB. 11-6-2001. FILED 9-7-1999.
- 2,533,356 (*See Class 41 for this trademark*).
- 2,533,365. **JUMPWORDS**. PRODIGY COMMUNICATIONS CORPORATION, (U.S. CLS. 100 AND 101). SN 75-817,172. PUB. 11-6-2001. FILED 10-6-1999.
- 2,533,372. **INTEGRATING TOMORROW'S SOLUTIONS TODAY**. MAGIC SOFTWARE ENTERPRISES LTD., (U.S. CLS. 100 AND 101). SN 75-832,608. PUB. 11-6-2001. FILED 10-27-1999.
- 2,533,373. **TOWNTALK**. ARVIDA/JMB PARTNERS, (U.S. CLS. 100 AND 101). SN 75-833,642. PUB. 11-6-2001. FILED 10-27-1999.
- 2,533,380 (*See Class 38 for this trademark*).
- 2,533,388. **DTCPACK**. SRA INTERNATIONAL, INC., (U.S. CLS. 100 AND 101). SN 75-849,203. PUB. 11-6-2001. FILED 11-16-1999.
- 2,533,389. **CONVERGENCE AND DESIGN**. CONVERGENCE, INCORPORATED, (U.S. CLS. 100 AND 101). SN 75-850,338. PUB. 11-6-2001. FILED 12-6-1999.
- 2,533,398 (*See Class 9 for this trademark*).
- 2,533,402. **GRUNAU COMPANY**. GRUNAU COMPANY, (U.S. CLS. 100 AND 101). SN 75-862,824. PUB. 11-6-2001. FILED 12-2-1999.
- 2,533,406. **VANTEON**. VANTEON CORPORATION, BY CHANGE OF NAME METAMOR SOFTWARE SOLUTIONS, INC., (U.S. CLS. 100 AND 101). SN 75-864,507. PUB. 11-6-2001. FILED 12-6-1999.
- 2,533,409 (*See Class 37 for this trademark*).
- 2,533,422. **CODE MAVEN**. CODE MAVEN CORP., (U.S. CLS. 100 AND 101). SN 75-876,186. PUB. 11-6-2001. FILED 12-21-1999.
- 2,533,424. **P.J. WHELIHAN'S PUB**. P.J. WHELIHAN'S PUB, INC., (U.S. CLS. 100 AND 101). SN 75-877,145. PUB. 11-6-2001. FILED 12-20-1999.
- 2,533,427. **INSURACTIVE**. INSURACTIVE, INC., BY ASSIGNMENT SENIOR MARKET SALES, INC., (U.S. CLS. 100 AND 101). SN 75-880,046. PUB. 11-6-2001. FILED 1-4-2000.
- 2,533,431. **GODDESS**. 671 WASHINGTON AVENUE CORP., (U.S. CLS. 100 AND 101). SN 75-883,464. PUB. 11-6-2001. FILED 12-30-1999.
- 2,533,432 (*See Class 35 for this trademark*).
- 2,533,436 (*See Class 35 for this trademark*).
- 2,533,439. **GRACE, BEAUTY AND STYLE**. JOHN Q. COOK, (U.S. CLS. 100 AND 101). SN 75-885,677. PUB. 11-6-2001. FILED 1-4-2000.
- 2,533,440. **GOOD FORM IS ALWAYS A PLEASURE**. JOHN Q. COOK, (U.S. CLS. 100 AND 101). SN 75-885,678. PUB. 11-6-2001. FILED 1-4-2000.
- 2,533,449. **GIVEFIRST.COM**. WOODY DEVELOPMENT CORPORATION, (U.S. CLS. 100 AND 101). SN 75-890,122. PUB. 11-6-2001. FILED 1-8-2000.
- 2,533,453. **HEALTHCARE4U**. CAMPBELL, CHARLES B., III, (U.S. CLS. 100 AND 101). SN 75-891,671. PUB. 11-6-2001. FILED 1-7-2000.
- 2,533,458. **SECURECOLO**. SUNGARD NETWORK SOLUTIONS INC., (U.S. CLS. 100 AND 101). SN 75-893,916. PUB. 11-6-2001. FILED 1-11-2000.
- 2,533,463 (*See Class 38 for this trademark*).
- 2,533,465 (*See Class 9 for this trademark*).
- 2,533,468. **CITYSOFT**. CITYSOFT, INC., (U.S. CLS. 100 AND 101). SN 75-901,182. PUB. 11-6-2001. FILED 1-21-2000.
- 2,533,489. **IASYST**. CYNOCOM CORPORATION, (U.S. CLS. 100 AND 101). SN 75-913,204. PUB. 11-6-2001. FILED 2-7-2000.
- 2,533,493 (*See Class 37 for this trademark*).
- 2,533,498. **SCHMIDT AND DESIGN**. SCHMIDT, THOMAS M., (U.S. CLS. 100 AND 101). SN 75-917,431. PUB. 11-6-2001. FILED 2-12-2000.
- 2,533,501 (*See Class 9 for this trademark*).
- 2,533,502. **FRUITS.COM AND DESIGN**. DEL MONTE FRESH PRODUCE B.V, (U.S. CLS. 100 AND 101). SN 75-918,609. PUB. 11-6-2001. FILED 2-15-2000.
- 2,533,506 (*See Class 36 for this trademark*).
- 2,533,508. **WISE GUYS PIZZA**. WISE GUYS, INC., (U.S. CLS. 100 AND 101). SN 75-921,412. PUB. 11-6-2001. FILED 2-17-2000.
- 2,533,516 (*See Class 35 for this trademark*).
- 2,533,524 (*See Class 38 for this trademark*).
- 2,533,526. **SONNENSCHNEIN (STYLIZED)**. SONNENSCHNEIN NATH & ROSENTHAL, (U.S. CLS. 100 AND 101). SN 75-929,938. PUB. 11-6-2001. FILED 2-28-2000.
- 2,533,527. **SONNENSCHNEIN**. SONNENSCHNEIN NATH & ROSENTHAL, (U.S. CLS. 100 AND 101). SN 75-929,948. PUB. 11-6-2001. FILED 2-28-2000.
- 2,533,536. **PARDESHI**. PARDESHI.COM, INC., (U.S. CLS. 100 AND 101). SN 75-932,627. PUB. 11-6-2001. FILED 3-1-2000.
- 2,533,537 (*See Class 35 for this trademark*).
- 2,533,543. **CTR PAYROLL AND DESIGN**. CTR PAYROLL COMPANY, (U.S. CLS. 100 AND 101). SN 75-935,892. PUB. 11-6-2001. FILED 3-6-2000.
- 2,533,563. **CC AND DESIGN**. COHEN, SETH, (U.S. CLS. 100 AND 101). SN 75-943,470. PUB. 11-6-2001. FILED 3-14-2000.
- 2,533,570 (*See Class 36 for this trademark*).
- 2,533,593 (*See Class 41 for this trademark*).
- 2,533,599 (*See Class 35 for this trademark*).
- 2,533,603 (*See Class 37 for this trademark*).
- 2,533,610. **CENTER FOR WOMEN'S MINISTRIES**. CENTER FOR WOMEN'S MINISTRIES, INC., (U.S. CLS. 100 AND 101). SN 76-022,243. PUB. 11-6-2001. FILED 4-10-2000.
- 2,533,623. **RIVER NETWORK**. RIVER NETWORK, (U.S. CLS. 100 AND 101). SN 76-027,724. PUB. 11-6-2001. FILED 4-17-2000.
- 2,533,625 (*See Class 35 for this trademark*).
- 2,533,633 (*See Class 41 for this trademark*).
- 2,533,634. **DANZO INTERNATIONAL AND DESIGN**. REFRACTIVE EDGE, INC., THE, (U.S. CLS. 100 AND 101). SN 76-031,118. PUB. 11-6-2001. FILED 4-21-2000.
- 2,533,635. **MASTER REFRACTIVE SUCCESS**. REFRACTIVE

- EDGE, INC., THE, (U.S. CLS. 100 AND 101). SN 76-031,121. PUB. 11-6-2001. FILED 4-21-2000.
- 2,533,650 (*See Class 5 for this trademark.*)
- 2,533,653 (*See Class 35 for this trademark.*)
- 2,533,655. **BABYNAMER.COM**. OXYGEN MEDIA, LLC, (U.S. CLS. 100 AND 101). SN 76-037,815. PUB. 11-6-2001. FILED 4-28-2000.
- 2,533,656. **PROJECTGRID.COM**. RESOURCE INTERNATIONAL, INC., (U.S. CLS. 100 AND 101). SN 76-037,926. PUB. 11-6-2001. FILED 5-1-2000.
- 2,533,675. **KISSED BY AN ANGEL**. RAPELJE, STEVEN, (U.S. CLS. 100 AND 101). SN 76-042,563. PUB. 11-6-2001. FILED 5-8-2000.
- 2,533,676. **BIZPIE AND DESIGN**. ROH, JAE KYONG, (U.S. CLS. 100 AND 101). SN 76-042,761. PUB. 11-6-2001. FILED 5-8-2000.
- 2,533,681. **OUR PIZZA'S ARE RECTANGULAR BECAUSE WE WON'T CUT CORNERS**. ITALIAN INN PIZZA, INC., (U.S. CLS. 100 AND 101). SN 76-043,988. PUB. 11-6-2001. FILED 5-9-2000.
- 2,533,693. **DOMINION ENERGY INDEX**. DOMINION RESOURCES, INC., (U.S. CLS. 100 AND 101). SN 76-048,990. PUB. 11-6-2001. FILED 5-15-2000.
- 2,533,698. **MISCELLANEOUS DESIGN**. VOCALSOFT CORPORATION, (U.S. CLS. 100 AND 101). SN 76-051,510. PUB. 11-6-2001. FILED 5-18-2000.
- 2,533,706 (*See Class 41 for this trademark.*)
- 2,533,710 (*See Class 37 for this trademark.*)
- 2,533,711. **NOBLE**. NATIONAL ORGANIZATION OF BLACK LAW ENFORCEMENT EXECUTIVES, (U.S. CLS. 100 AND 101). SN 76-055,087. PUB. 11-6-2001. FILED 5-23-2000.
- 2,533,713. **INTERSWERV**. WILLIAMS, MARK THOMAS, (U.S. CLS. 100 AND 101). SN 76-055,211. PUB. 11-6-2001. FILED 5-24-2000.
- 2,533,716. **LOVE IS WANTING THE BEST FOR SOMEONE ELSE**. RAVN, PENNY L., (U.S. CLS. 100 AND 101). SN 76-056,704. PUB. 11-6-2001. FILED 5-26-2000.
- 2,533,717. **OSPREY**. BASS PUBLIC LIMITED COMPANY, (U.S. CLS. 100 AND 101). SN 76-057,013. PUB. 11-6-2001. FILED 5-25-2000.
- 2,533,721. **POSITIVE APPROACHES**. MERCK-MEDCO MANAGED CARE, L.L.C., (U.S. CLS. 100 AND 101). SN 76-058,309. PUB. 8-28-2001. FILED 5-30-2000.
- 2,533,725. **COPE**. IXL ENTERPRISES, INC., (U.S. CLS. 100 AND 101). SN 76-059,391. PUB. 11-6-2001. FILED 5-30-2000.
- 2,533,734. **MIREILLE'S INFLIGHT CATERING AND DESIGN**. MIREILLE'S INFLIGHT CATERING, (U.S. CLS. 100 AND 101). SN 76-062,044. PUB. 11-6-2001. FILED 6-5-2000.
- 2,533,737 (*See Class 35 for this trademark.*)
- 2,533,743. **R (STYLIZED)**. RECIPROCAL, INC., (U.S. CLS. 100 AND 101). SN 76-066,571. PUB. 11-6-2001. FILED 6-9-2000.
- 2,533,746. **IMPLEMENT.COM AND DESIGN**. IMPLEMENT.COM, L.L.C., (U.S. CLS. 100 AND 101). SN 76-067,573. PUB. 11-6-2001. FILED 6-7-2000.
- 2,533,753. **CAJUN EDGE**. CAJUN EDGE LLC, (U.S. CLS. 100 AND 101). SN 76-070,746. PUB. 11-6-2001. FILED 6-13-2000.
- 2,533,771 (*See Class 21 for this trademark.*)
- 2,533,777. **AMERICARES FREE CLINICS (STYLIZED)**. AMERICARES FOUNDATION, INC., (U.S. CLS. 100 AND 101). SN 76-079,532. PUB. 11-6-2001. FILED 6-28-2000.
- 2,533,778. **SUPPORTPLUS ONLINE**. BEST SOFTWARE, INC., (U.S. CLS. 100 AND 101). SN 76-079,683. PUB. 11-6-2001. FILED 6-28-2000.
- 2,533,780 (*See Class 4 for this trademark.*)
- 2,533,781 (*See Class 9 for this trademark.*)
- 2,533,782. **BACK ON TRACK CHIROPRACTIC & WELLNESS CENTER**. SCHERER, BETH, AND RIZZUTO, RICHARD, (U.S. CLS. 100 AND 101). SN 76-080,988. PUB. 11-6-2001. FILED 7-3-2000.
- 2,533,800 (*See Class 7 for this trademark.*)
- 2,533,809. **W WESTELCOM AND DESIGN**. WESTELCOM COMMUNICATIONS, INC., (U.S. CLS. 100 AND 101). SN 76-092,718. PUB. 11-6-2001. FILED 7-21-2000.
- 2,533,817 (*See Class 6 for this trademark.*)
- 2,533,820. **SIGNALFINDER**. AKKADIX CORPORATION, (U.S. CLS. 100 AND 101). SN 76-098,380. PUB. 6-5-2001. FILED 7-31-2000.
- 2,533,824. **TOTAL FITNESS SOLUTIONS**. BUSY BODY, INC., (U.S. CLS. 100 AND 101). SN 76-101,267. PUB. 11-6-2001. FILED 8-2-2000.
- 2,533,825 (*See Class 30 for this trademark.*)
- 2,533,836. **BRAUN**. RENTALMAX L.L.C., (U.S. CLS. 100 AND 101). SN 76-109,865. PUB. 11-6-2001. FILED 8-15-2000.
- 2,533,837. **THE GOVERNOR'S HOUSE HOTEL WASHINGTON, D. C. AND DESIGN**. 1615 - LLL, LIMITED PARTNERSHIP, (U.S. CLS. 100 AND 101). SN 76-111,171. PUB. 11-6-2001. FILED 8-11-2000.
- 2,533,841. **CONTENTFLY**. PALADIN COMPANIES, INC., (U.S. CLS. 100 AND 101). SN 76-114,747. PUB. 11-6-2001. FILED 8-22-2000.
- 2,533,843. **IDVERIFIED**. REMOTEPIPES, INC., (U.S. CLS. 100 AND 101). SN 76-116,274. PUB. 11-6-2001. FILED 8-24-2000.
- 2,533,845. **SMASH HIT SUBS AND DESIGN**. ORION FOOD SYSTEMS, INC., (U.S. CLS. 100 AND 101). SN 76-116,842. PUB. 11-6-2001. FILED 8-25-2000.
- 2,533,847 (*See Class 41 for this trademark.*)
- 2,533,848. **RELIABILITY ANALYSIS LABORATORY**. RAYTHEON COMPANY, (U.S. CLS. 100 AND 101). SN 76-118,140. PUB. 11-6-2001. FILED 8-28-2000.
- 2,533,858. **IHS THERAPY NETWORK (STYLIZED)**. INTEGRATED HEALTH SERVICES, INC., (U.S. CLS. 100 AND 101). SN 76-122,920. PUB. 11-6-2001. FILED 9-6-2000.
- 2,533,867. **CASEMONITOR AND DESIGN**. RECORD PRESS, INC., (U.S. CLS. 100 AND 101). SN 76-128,972. PUB. 11-6-2001. FILED 9-14-2000.
- 2,533,870 (*See Class 35 for this trademark.*)
- 2,533,871. **HOUSTON HEART CLINIC**. I.M. JAWDAT, M.D., P.A., (U.S. CLS. 100 AND 101). SN 76-130,187. PUB. 11-6-2001. FILED 9-19-2000.
- 2,533,876 (*See Class 9 for this trademark.*)
- 2,533,881. **SUITCASE**. THOMAS COOK HOLDINGS LTD., (U.S. CLS. 100 AND 101). SN 76-133,659. PUB. 11-6-2001. FILED 9-22-2000.
- 2,533,892. **TIMBER HILL (STYLIZED)**. TIMBER HILL RANCH, LLC, DBA TIMBER HILL, (U.S. CLS. 100 AND 101). SN 76-137,743. PUB. 11-6-2001. FILED 9-25-2000.
- 2,533,902 (*See Class 35 for this trademark.*)
- 2,533,913. **MISCELLANEOUS DESIGN**. BOOKS FOR KIDS FOUNDATION, THE, (U.S. CLS. 100 AND 101). SN 76-148,780. PUB. 11-6-2001. FILED 10-17-2000.
- 2,533,916 (*See Class 39 for this trademark.*)
- 2,533,917 (*See Class 39 for this trademark.*)
- 2,533,919 (*See Class 41 for this trademark.*)
- 2,533,920. **VIRANIM TECHNOLOGIES AND DESIGN**. VIRANIM TECHNOLOGIES, INC., (U.S. CLS. 100 AND 101). SN 76-150,227. PUB. 11-6-2001. FILED 10-19-2000.
- 2,533,925. **INTERNATIONAL ASSOCIATION OF ELECTRONICS RECYCLERS AND DESIGN**. INTERNATIONAL ASSOCIATION OF ELECTRONICS RECYCLERS, INC., (U.S. CLS. 100 AND 101). SN 76-153,651. PUB. 11-6-2001. FILED 10-26-2000.
- 2,533,926. **CHOICEONE**. ONLINE AND DESIGN. CHOICE ONE COMMUNICATIONS, INC., (U.S. CLS. 100 AND 101). SN 76-154,303. PUB. 11-6-2001. FILED 10-26-2000.
- 2,533,942. **WILD WEB SITES**. VANPRAAG, RAY, (U.S. CLS. 100 AND 101). SN 76-158,245. PUB. 11-6-2001. FILED 11-3-2000.
- 2,533,943. **PRIME INTERNET**. VANPRAAG, RAY, (U.S. CLS. 100 AND 101). SN 76-158,246. PUB. 11-6-2001. FILED 11-3-2000.
- 2,533,956. **THE HALLMARK OF INTEGRITY**. GEMOLOGICAL INSTITUTE OF AMERICA, INC., (U.S. CLS. 100 AND 101). SN 76-163,571. PUB. 11-6-2001. FILED 11-13-2000.
- 2,533,962. **FINISHING TOUCH**. ORTHODONTIC CENTERS OF AMERICA, (U.S. CLS. 100 AND 101). SN 76-164,640. PUB. 11-6-2001. FILED 11-14-2000.
- 2,533,966. **TRADEWINDS MARKETPLACE**. ISLE OF CAPRI CASINOS, INC., (U.S. CLS. 100 AND 101). SN 76-166,833. PUB. 11-6-2001. FILED 11-16-2000.
- 2,533,968. **CC AND DESIGN**. CARDINALCOMMERCE.COM, INC., (U.S. CLS. 100 AND 101). SN 76-167,419. PUB. 11-6-2001. FILED 11-17-2000.
- 2,533,969. **REALTIMESITES**. SKS.COM, LLC, (U.S. CLS. 100 AND 101). SN 76-167,534. PUB. 11-6-2001. FILED 11-17-2000.
- 2,533,973. **POSTHASTE**. MAIL SORT, INC., (U.S. CLS. 100 AND 101). SN 76-169,261. PUB. 11-6-2001. FILED 11-21-2000.

- 2,533,989. **VISION ENTERTAINMENT AND DESIGN**. VISION ENTERTAINMENT, INC., (U.S. CLS. 100 AND 101). SN 76-174,448. PUB. 11-6-2001. FILED 12-1-2000.
- 2,533,990 (*See Class 41 for this trademark*).
- 2,533,993. **WHERE ENGINEERS DEVELOP**. INTEVIS CORPORATION, (U.S. CLS. 100 AND 101). SN 76-176,839. PUB. 11-6-2001. FILED 12-4-2000.
- 2,533,994. **INSTANT PAGE BUILDER**. VELCERO, LLC, (U.S. CLS. 100 AND 101). SN 76-177,176. PUB. 11-6-2001. FILED 12-7-2000.
- 2,534,000. **JOSEPH STOREHOUSE**. REMNANT OF ISRAEL, INCORPORATED, (U.S. CLS. 100 AND 101). SN 76-179,850. PUB. 11-6-2001. FILED 12-12-2000.
- 2,534,001. **VISION FOR ISRAEL**. REMNANT OF ISRAEL, INCORPORATED, (U.S. CLS. 100 AND 101). SN 76-179,852. PUB. 11-6-2001. FILED 12-12-2000.
- 2,534,009. **BD AND DESIGN**. BECTON DICKINSON AND COMPANY, (U.S. CLS. 100 AND 101). SN 76-183,035. PUB. 11-6-2001. FILED 12-18-2000.
- 2,534,017. **HORS D'OEUVRES UNLIMITED**. HORS D'OEUVRES UNLIMITED, (U.S. CLS. 100 AND 101). SN 76-184,308. PUB. 11-6-2001. FILED 12-20-2000.
- 2,534,020. **MESA WEST MEDICAL**. MESA WEST MEDICAL, A PRIMARY CARE MEDICAL GROUP, INC., (U.S. CLS. 100 AND 101). SN 76-185,135. PUB. 11-6-2001. FILED 12-20-2000.
- 2,534,022. **ASHEVILLE NC'S CENTER FOR MASSAGE & NATURAL HEALTH**. PMG HEALTHCOM, INC., (U.S. CLS. 100 AND 101). SN 76-185,298. PUB. 11-6-2001. FILED 12-21-2000.
- 2,534,032. **NOVACARE REHABILITATION AND DESIGN**. SELECTMARK, INC., (U.S. CLS. 100 AND 101). SN 76-187,318. PUB. 11-6-2001. FILED 12-27-2000.
- 2,534,035. **MEGNAPOINT**. MEGNAPOINT CORPORATION, (U.S. CLS. 100 AND 101). SN 76-189,630. PUB. 11-6-2001. FILED 1-4-2001.
- 2,534,041. **VILLAGE OF SCHILLER PARK AND DESIGN**. VILLAGE OF SCHILLER PARK, (U.S. CLS. 100 AND 101). SN 76-191,663. PUB. 11-6-2001. FILED 1-9-2001.
- 2,534,045. **XML 101**. INTERNET.COM CORPORATION, (U.S. CLS. 100 AND 101). SN 76-192,527. PUB. 11-6-2001. FILED 1-10-2001.
- 2,534,046. **TOTAL WEB**. I INC., (U.S. CLS. 100 AND 101). SN 76-192,707. PUB. 11-6-2001. FILED 1-11-2001.
- 2,534,048. **KIDS' CART TUNE**. CHILDREN'S CANCER ASSOCIATION, (U.S. CLS. 100 AND 101). SN 76-193,059. PUB. 11-6-2001. FILED 1-10-2001.
- 2,534,051. **WE CAN'T MAKE THEM GOOD, BUT WE CAN MAKE THEM BETTER**. CLARIAN HEALTH PARTNERS, INC., (U.S. CLS. 100 AND 101). SN 76-193,893. PUB. 11-6-2001. FILED 1-16-2001.
- 2,534,066. **N NE S SW W NW EXPLORE WORKSHOP AND DESIGN**. EVANGELICAL ALLIANCE MISSION, THE, (U.S. CLS. 100 AND 101). SN 76-197,706. PUB. 11-6-2001. FILED 1-22-2001.
- 2,534,075. **MISCELLANEOUS DESIGN**. RUPP CO., LLC, DBA GROUND CONTROL, (U.S. CLS. 100 AND 101). SN 76-199,180. PUB. 11-6-2001. FILED 1-25-2001.
- 2,534,089. **THE IIG GROUP INC.**. IIG GROUP, INC., (U.S. CLS. 100 AND 101). SN 76-202,843. PUB. 11-6-2001. FILED 1-30-2001.
- 2,534,098. **LUCHAMOS POR TU BEBE**. MARCH OF DIMES BIRTH DEFECTS FOUNDATION, (U.S. CLS. 100 AND 101). SN 76-204,525. PUB. 11-6-2001. FILED 2-5-2001.
- 2,534,107. **RANDOM WALK COMPUTING**. RANDOM WALK COMPUTING, INC., (U.S. CLS. 100 AND 101). SN 76-207,183. PUB. 11-6-2001. FILED 2-8-2001.
- 2,534,110. **GET THE SCIENCE BEHIND THE CLAIMS**. FORTITECH, INC., (U.S. CLS. 100 AND 101). SN 76-207,447. PUB. 11-6-2001. FILED 2-9-2001.
- 2,534,116. **MISCELLANEOUS DESIGN**. BO'S PLACE, (U.S. CLS. 100 AND 101). SN 76-208,211. PUB. 11-6-2001. FILED 2-12-2001.
- 2,534,127. **AVANDIA AND DESIGN**. SB PHARMCO PUERTO RICO INC., (U.S. CLS. 100 AND 101). SN 76-212,060. PUB. 11-6-2001. FILED 2-16-2001.
- 2,534,139. **RED LION HOTELS & INNS AND DESIGN**. HILTON HOSPITALITY, INC., (U.S. CLS. 100 AND 101). SN 76-216,791. PUB. 11-6-2001. FILED 2-28-2001.
- 2,534,141. **CHIRALSELECT**. MEDICHEM RESEARCH, INC., (U.S. CLS. 100 AND 101). SN 76-219,861. PUB. 11-6-2001. FILED 3-5-2001.
- 2,534,154. **FACES OF SURVIVORS**. BLAKNEY, DENISE, (U.S. CLS. 100 AND 101). SN 76-224,892. PUB. 11-6-2001. FILED 3-13-2001.
- 2,534,160. **DON'T GET HURT TWICE**. MICHAEL G. HEILMANN P.C., (U.S. CLS. 100 AND 101). SN 76-226,621. PUB. 11-6-2001. FILED 3-20-2001.
- 2,534,161. **DIGITALEVE**. DIGITALEVE, (U.S. CLS. 100 AND 101). SN 76-226,897. PUB. 11-6-2001. FILED 3-15-2001.
- 2,534,172 (*See Class 41 for this trademark*).
- 2,534,176. **KENNEDY COVINGTON AND DESIGN**. KENNEDY COVINGTON LOBDELL & HICKMAN, L.L.P., (U.S. CLS. 100 AND 101). SN 76-233,711. PUB. 11-6-2001. FILED 3-30-2001.
- 2,534,187. **OVERFLOW COUNSEL**. OVERFLOW COUNSEL, LLC, (U.S. CLS. 100 AND 101). SN 76-237,672. PUB. 11-6-2001. FILED 4-9-2001.
- 2,534,194. **H HOPE COTTAGE PREGNANCY AND ADOPTION CENTER AND DESIGN**. HOPE COTTAGE, INC., (U.S. CLS. 100 AND 101). SN 76-241,462. PUB. 11-6-2001. FILED 4-16-2001.
- 2,534,207. **STRADLING YOCCA CARLSON & RAUTH AND DESIGN**. STRADLING YOCCA CARLSON & RAUTH, (U.S. CLS. 100 AND 101). SN 76-267,588. PUB. 11-6-2001. FILED 6-6-2001.
- 2,534,208. **STRADLING YOCCA CARLSON & RAUTH**. STRADLING YOCCA CARLSON & RAUTH, (U.S. CLS. 100 AND 101). SN 76-267,590. PUB. 11-6-2001. FILED 6-6-2001.
- 2,534,211. **STRUCTURAL INSIGHT**. STRUCTURAL BIOINFORMATICS INC., (U.S. CLS. 100 AND 101). SN 76-270,096. PUB. 11-6-2001. FILED 6-11-2001.
- 2,534,213. **THE AWAKENING HOUR**. BIBLE STUDY TIME, INC., (U.S. CLS. 100 AND 101). SN 76-271,693. PUB. 11-6-2001. FILED 6-15-2001.
- 2,534,217. **DECORLIGHTING**. OROZCO, SERGIO, (U.S. CLS. 100 AND 101). SN 76-273,987. PUB. 11-6-2001. FILED 6-20-2001.
- 2,534,219. **SECURE STEPS**. INTERNET SECURITY SYSTEMS, INC., (U.S. CLS. 100 AND 101). SN 76-275,134. PUB. 11-6-2001. FILED 6-22-2001.
- 2,534,221. **REI AND DESIGN**. HARBOR-UCLA RESEARCH & EDUCATION INSTITUTE, (U.S. CLS. 100 AND 101). SN 76-275,338. PUB. 11-6-2001. FILED 6-25-2001.
- 2,534,223 (*See Class 35 for this trademark*).
- 2,534,225. **TASTE EXPRESS**. CLOUGHERTY PACKING COMPANY, (U.S. CLS. 100 AND 101). SN 76-277,398. PUB. 11-6-2001. FILED 6-26-2001.
- 2,534,226. **GOULSTON & STORRS**. GOULSTON & STORRS, P.C., (U.S. CLS. 100 AND 101). SN 76-278,795. PUB. 11-6-2001. FILED 6-29-2001.
- 2,534,234. **STUMPY**. HERNDON, SUSEN A., (U.S. CLS. 100 AND 101). SN 76-280,307. PUB. 11-6-2001. FILED 7-3-2001.
- 2,534,254. **THE GAUCHO WAY OF PREPARING MEAT**. FOGO DE CHAO CHURRASCARIA (DALLAS) LLP, (U.S. CLS. 100 AND 101). SN 76-284,863. PUB. 11-6-2001. FILED 7-13-2001.
- 2,534,265. **CORPOREX AND DESIGN**. CORPOREX COMPANIES, INC., (U.S. CLS. 100 AND 101). SN 76-288,187. PUB. 11-6-2001. FILED 7-20-2001.
- 2,534,272. **STRAIGHT TO THE POINT**. MEDICAL BENEFITS ADMINISTRATORS, INC., (U.S. CLS. 100 AND 101). SN 76-291,211. PUB. 11-6-2001. FILED 7-26-2001.
- 2,534,279. **SOLUTIONPATH**. SOLUTION ARCHITECTS, INC., (U.S. CLS. 100 AND 101). SN 76-292,639. PUB. 11-6-2001. FILED 7-30-2001.
- 2,534,282. **SHARING OUR TRADITION OF TRUSTED ANSWERS**. MAYO FOUNDATION FOR MEDICAL EDUCATION AND RESEARCH, (U.S. CLS. 100 AND 101). SN 76-292,989. PUB. 11-6-2001. FILED 7-31-2001.
- 2,534,288 (*See Class 16 for this trademark*).
- 2,534,289 (*See Class 16 for this trademark*).
- 2,534,290. **SDI**. SURVEILLANCE DATA, INC., (U.S. CLS. 100 AND 101). SN 76-293,886. PUB. 11-6-2001. FILED 8-1-2001.
- 2,534,295. **TRUE BAJA**. RUBIO'S RESTAURANTS, INC., (U.S.

- CLS. 100 AND 101). SN 76-295,785. PUB. 11-6-2001. FILED 8-6-2001.
- 2,534,301. **EPS EXECUTIVE PORTRAIT SPECIALISTS AND DESIGN**. SILVER, JARED, NEIL, (U.S. CLS. 100 AND 101). SN 78-006,624. PUB. 11-6-2001. FILED 5-3-2000.
- 2,534,307. **HOTPORTAL**. COKER, BRYAN, WILLIAM, (U.S. CLS. 100 AND 101). SN 78-016,950. PUB. 11-6-2001. FILED 7-17-2000.
- 2,534,308. **NEW ORLEANS MISSION LAB "A CATALYST FORLIFE CHANGE" AND DESIGN**. NEW ORLEANS BAPTIST SEMINARY, (U.S. CLS. 100 AND 101). SN 78-016,967. PUB. 11-6-2001. FILED 7-17-2000.
- 2,534,310 (*See Class 9 for this trademark*).
- 2,534,313. **SYSTIME AND DESIGN**. VISHAL GROVER R, (U.S. CLS. 100 AND 101). SN 78-023,149. PUB. 11-6-2001. FILED 8-26-2000.
- 2,534,314. **GILBERT'S FAMILY RESTAURANT (STYLIZED)**. SAR-FAM, INC., DBA GILBERT'S FAMILY RESTAURANT, (U.S. CLS. 100 AND 101). SN 78-023,969. PUB. 11-6-2001. FILED 8-31-2000.
- 2,534,316. **MISCELLANEOUS DESIGN**. HEARTSHARE HUMAN SERVICES OF NEW YORK, ROMAN CATHOLIC DIOCESE OF BROOKLYN, (U.S. CLS. 100 AND 101). SN 78-027,742. PUB. 11-6-2001. FILED 9-26-2000.
- 2,534,319 (*See Class 41 for this trademark*).
- 2,534,325. **BJ'S RESTAURANT & BREWERY**. CHICAGO PIZZA & BREWERY, INC., (U.S. CLS. 100 AND 101). SN 78-048,175. PUB. 11-6-2001. FILED 2-13-2001.
- 2,534,331. **WE'RE KNOWN BY THE STANDARDS WE KEEP**. NATIONAL ASSOCIATION OF PERSONAL FINANCIAL ADVISORS, INC., (U.S. CLS. 100 AND 101). SN 78-065,320. PUB. 11-6-2001. FILED 5-23-2001.
- 2,534,336. **PRIVILEGESMART**. DIGITAL ONLINE TECHNOLOGIES, INC., (U.S. CLS. 100 AND 101). SN 78-067,863. PUB. 11-6-2001. FILED 6-7-2001.
- 2,534,340 (*See Class 9 for this trademark*).

* * * * *

SECTION 2.—PRIOR UNITED STATES CLASSIFICATION

COLLECTIVE MEMBERSHIP MARKS

CLASS 200—COLLECTIVE MEMBERSHIP

2,533,799. **LORDS OF LOYALTY.** LORDS OF LOYALTY MOTORCYCLE CLUB, SN 76-088,943. PUB. 11-6-2001. FILED 7-14-2000.

2,533,874. **WAYBACKS.** BEAULIEU, THOMAS J, SN 76-131,158. PUB. 11-6-2001. FILED 9-18-2000.

CERTIFICATION MARKS

CLASS B—SERVICES

2,533,352. **RPLU AND DESIGN.** PROFESSIONAL LIABILITY UNDERWRITING SOCIETY, SN 75-795,681. PUB. 11-6-2001. FILED 9-7-1999.

* * * * *

TRADEMARK REGISTRATIONS ISSUED UNDER SECTION 1(d)

The following marks have registered on the Principal Register pursuant to the intent-to-use provisions of Section 1(d) of the Trademark Act of 1946, as amended.

SECTION 1.— INTERNATIONAL CLASSIFICATION

The short titles associated below with the international class numbers are terms designed merely for quick identification and are not an official part of the international classification. The full names of international classes are given in section 6.1 of the trademark rules of practice.

The designation "U.S. Cl." appearing in this section refers to the U.S. class in effect prior to Sep. 1, 1973 rather than the international class which applies to applications filed on or after that date. For adoption of international classification see notice in the OFFICIAL GAZETTE of Jun. 26, 1973 (911 O.G. TM 210).

Application in more than one class

2,534,347. ATLANTA-FULTON COUNTY ZOO, INC.,
ATLANTA, GA. SN 74-641,823. PUB. 5-9-2000, FILED 3-
3-1995.

WILLIE B.

"WILLIE B." DOES NOT IDENTIFY A PARTICULAR
LIVING INDIVIDUAL.

CLASS 16—PAPER GOODS AND PRINTED MATTER

FOR EDUCATIONAL MATERIALS, NAMELY, NEWS-
LETTERS, MAGAZINES, BROCHURES, COLORING
BOOKS AND GUIDE BOOKS RELATED TO ZOO LIFE,
POST CARDS, POSTERS, BUMPER STICKERS, PAPER
PENNANTS AND MERCHANDISING BAGS, PENS, PEN-
CILS, DRAWING RULERS, AND SCHOOL SUPPLY
KITS, NAMELY, HOLDERS FOR RULERS AND PEN-
CILS, STAMP SETS, NAMELY, RUBBER STAMPS AND
STAMP PADS (U.S. CLS. 2, 5, 22, 23, 29, 37, 38 AND 50).
FIRST USE 8-0-1989; IN COMMERCE 8-0-1989.

CLASS 25—CLOTHING

FOR CLOTHING - NAMELY SHIRTS, T-SHIRTS,
SWEATSHIRTS, SHORTS, SHAWLS, JACKETS, BASE
BALL CAPS, CAPS, HATS, AND VISORS (U.S. CLS. 22
AND 39).
FIRST USE 3-0-1989; IN COMMERCE 3-0-1989.

CLASS 28—TOYS AND SPORTING GOODS

FOR TOYS, NAMELY JIGSAW PUZZLES, PHOTO-
GRAPH PUZZLES, CARD GAMES, BOARD GAMES,
CHRISTMAS TREE BELLS AND ORNAMENTS (U.S.
CLS. 22, 23, 38 AND 50).
FIRST USE 12-0-1994; IN COMMERCE 12-0-1994.

2,534,348. LES VETEMENTS S&P INC., GRANDBY, QUE-
BEC, CANADA. SN 74-656,146. PUB. 7-20-1999, FILED 4-
5-1995.

FLO KNIT

PRIORITY CLAIMED UNDER SEC. 44(D) ON CANADA
APPLICATION NO. 774929, FILED 2-9-1995, REG. NO.
490513, DATED 2-25-1998, EXPIRES 2-25-2013.

NO CLAIM IS MADE TO THE EXCLUSIVE RIGHT TO
USE "KNIT", APART FROM THE MARK AS SHOWN.

CLASS 24—FABRICS

FOR FABRICS FOR THE MANUFACTURE OF
SPORTS CLOTHING AND SPORTS EQUIPMENT (U.S.
CLS. 42 AND 50).
FIRST USE 3-27-1998; IN COMMERCE 3-27-1998.

CLASS 25—CLOTHING

FOR CLOTHING AND SPORTS CLOTHING APPAREL,
NAMELY, JERSEYS (U.S. CLS. 22 AND 39).
FIRST USE 3-27-1998; IN COMMERCE 3-27-1998.

2,534,351. LIP SERVICE COMMUNICATIONS, INCORPO-
RATED, TROY, MI. SN 75-031,392. PUB. 4-21-1998,
FILED 12-12-1995.

MAPKIN

CLASS 16—PAPER GOODS AND PRINTED MATTER

FOR PAPER NAPKINS (U.S. CLS. 2, 5, 22, 23, 29, 37, 38
AND 50).
FIRST USE 7-30-2001; IN COMMERCE 7-30-2001.

CLASS 24—FABRICS

FOR TEXTILE NAPKINS (U.S. CLS. 42 AND 50).
FIRST USE 7-30-2001; IN COMMERCE 7-30-2001.

2,534,352. BANK OF NOVA SCOTIA, THE, TORONTO, ONTARIO, CANADA. SN 75-036,048. PUB. 3-3-1998, FILED 12-22-1995.

2,534,363. BOB TIMBERLAKE COLLECTION, INC., THE, LEXINGTON, NC. SN 75-225,748. PUB. 6-16-1998, FILED 1-14-1997.

SCOTIABANK.COM

OWNER OF U.S. REG. NOS. 1,003,026 AND 1,427,782.



CLASS 35—ADVERTISING AND BUSINESS

FOR ON-LINE INFORMATION SERVICES IN THE FIELD OF ECONOMIC FORECASTING AND ANALYSIS; ON-LINE DISSEMINATION OF ADVERTISING INFORMATION FOR OTHERS IN THE FIELD OF BANKING SERVICES, SECURITIES SERVICES, TRUST AND FIDUCIARY SERVICES, AND INSURANCE SERVICES (U.S. CLS. 100, 101 AND 102).

FIRST USE 5-1-2001; IN COMMERCE 5-1-2001.

OWNER OF U.S. REG. NOS. 1,883,593, 2,003,830, AND OTHERS.

"BOB TIMBERLAKE" IDENTIFIES A LIVING INDIVIDUAL WHOSE CONSENT IS OF RECORD.

CLASS 36—INSURANCE AND FINANCIAL

FOR ON-LINE INFORMATION SERVICES IN THE FIELD OF BANKING SERVICES, TRUST AND FIDUCIARY SERVICES AND INSURANCE SERVICES; AND THE PROVIDING OF BANKING SERVICES, INCLUDING ON-LINE TRANSACTIONAL SERVICES, AGENCY SERVICES IN THE FIELD OF BONDS AND OTHER SECURITIES, AUTOMATED SECURITIES BROKERAGE, FINANCIAL INVESTMENT SERVICES IN THE FIELD OF SECURITIES, MORTGAGING OF SECURITIES FOR OTHERS, ESTATE TRUST MANAGEMENT SERVICES, FIDUCIARY REPRESENTATIVE SERVICES AND THE PROVIDING OF LIFE, ACCIDENT, AUTOMOBILE, FIRE, PROPERTY, MARINE AND MEDICAL INSURANCE (U.S. CLS. 100, 101 AND 102).

FIRST USE 5-1-2001; IN COMMERCE 5-1-2001.

CLASS 14—JEWELRY

FOR JEWELRY (U.S. CLS. 2, 27, 28 AND 50).
FIRST USE 9-18-1999; IN COMMERCE 9-18-1999.

CLASS 18—LEATHER GOODS

FOR WALLETS, LUGGAGE, KEY HOLDERS IN THE NATURE OF CASES, CREDIT CARD CASES, BRIEFCASES, AND BRIEFCASE-TYPE PORTFOLIOS (U.S. CLS. 1, 2, 3, 22 AND 41).

FIRST USE 7-29-1998; IN COMMERCE 7-29-1998.

CLASS 25—CLOTHING

FOR SWEATERS, SWEATSHIRTS, SHIRTS, T-SHIRTS, VESTS, PANTS, BELTS, CAPS, HATS, GLOVES, NECKWEAR, AND OUTERWEAR, NAMELY, COATS, JACKETS, RAINWEAR, LEATHER COATS (U.S. CLS. 22 AND 39).

FIRST USE 7-29-1998; IN COMMERCE 7-29-1998.

2,534,354. CHAYET COMMUNICATIONS GROUP, INC., BOSTON, MA. SN 75-115,348. PUB. 2-24-1998, FILED 6-6-1996.

HELP RADIO NETWORK

NO CLAIM IS MADE TO THE EXCLUSIVE RIGHT TO USE "RADIO NETWORK", APART FROM THE MARK AS SHOWN.

CLASS 38—COMMUNICATION

FOR RADIO AND TELEVISION BROADCASTING, CABLECASTING AND TRANSMISSION (U.S. CLS. 100, 101 AND 104).

FIRST USE 1-0-2000; IN COMMERCE 1-0-2000.

CLASS 41—EDUCATION AND ENTERTAINMENT

FOR SCHEDULING TELEVISION AND RADIO PROGRAMMING, AND PRODUCTION AND DISTRIBUTION OF RADIO AND TELEVISION PROGRAMS (U.S. CLS. 100, 101 AND 107).

FIRST USE 1-0-2000; IN COMMERCE 1-0-2000.

2,534,370. KNOWLEDGE KIDS ENTERPRISES, INC., LOS ANGELES, CA. SN 75-239,538. PUB. 4-25-2000, FILED 2-10-1997.

LEAPFROG

OWNER OF U.S. REG. NO. 1,306,993.

CLASS 9—ELECTRICAL AND SCIENTIFIC APPARATUS

FOR COMPUTER SOFTWARE FOR CHILDREN FEATURING EDUCATIONAL GAMES; COMPUTER GAME CARTRIDGES, CASSETTES, AND DISCS (U.S. CLS. 21, 23, 26, 36 AND 38).

FIRST USE 2-1-1998; IN COMMERCE 8-16-1999.

CLASS 28—TOYS AND SPORTING GOODS

FOR ELECTRONIC EDUCATIONAL GAME MACHINES FOR CHILDREN; HAND HELD UNITS FOR PLAYING ELECTRONIC GAMES (U.S. CLS. 22, 23, 38 AND 50).

FIRST USE 6-0-1998; IN COMMERCE 6-0-1998.

2,534,372. SANDLER, HECTOR ERNESTO, 1070 BUENOS AIRES, ARGENTINA. SN 75-247,640. PUB. 12-1-1998, FILED 2-25-1997.

2,534,380. LANCE MFG. LLC, CHARLOTTE, NC. SN 75-281,439. PUB. 12-16-1997, FILED 4-25-1997.

UTILISIMA

CLASS 16—PAPER GOODS AND PRINTED MATTER

FOR MAGAZINES, BOOKS, COLLECTIBLE AND NON COLLECTIBLE, INFORMATIVE BULLETINS AND BROCHURES FOR ALL WOMEN AND THE FAMILY DEALING WITH HOME DECORATING, ARTS AND CRAFTS, COOKING, CHILDCARE, BEAUTY CARE AND COSMETIC USE, HEALTH, CLOTHES MAKING, MEDICAL INFORMATION, AND EXERCISE AND FASHION (U.S. CLS. 2, 5, 22, 23, 29, 37, 38 AND 50).

FIRST USE 7-1-1993; IN COMMERCE 5-13-1994.

CLASS 41—EDUCATION AND ENTERTAINMENT

FOR ENTERTAINMENT AND EDUCATIONAL RADIO AND TV PROGRAMS FOR WOMEN AND FAMILY DEALING WITH HOME DECORATING, ARTS AND CRAFTS, COOKING, CHILDCARE, BEAUTY CARE AND COSMETIC USE, HEALTH, CLOTHES MAKING, MEDICAL INFORMATION, AND EXERCISE AND FASHION (U.S. CLS. 100, 101 AND 107).

FIRST USE 10-6-1984; IN COMMERCE 3-20-2000.

2,534,375. PROFESSOR NAZLI CHOUCRI AND WALLACE R. BAKER JOINT VENTURE, THE, CHESNUT HILL, MA. SN 75-253,476. PUB. 4-28-1998, FILED 3-7-1997.

GSSD

CLASS 9—ELECTRICAL AND SCIENTIFIC APPARATUS

FOR COMPUTER SOFTWARE FOR ANALYZING COMPLEX MULTI-DIMENSIONAL ASPECTS OF ENVIRONMENTAL PROBLEMS THAT MAY BE DOWNLOADED FROM A GLOBAL COMPUTER NETWORK (U.S. CLS. 21, 23, 26, 36 AND 38).

FIRST USE 1-0-1998; IN COMMERCE 1-0-1998.

CLASS 16—PAPER GOODS AND PRINTED MATTER

FOR PRINTED PUBLICATIONS, NAMELY, BOOKS, PAMPHLETS, MAGAZINES, AND JOURNALS IN THE FIELD OF SCIENCE AND ENVIRONMENTAL TECHNOLOGY (U.S. CLS. 2, 5, 22, 23, 29, 37, 38 AND 50).

FIRST USE 1-0-1995; IN COMMERCE 1-0-1995.

CLASS 41—EDUCATION AND ENTERTAINMENT

FOR EDUCATIONAL SERVICES, NAMELY, CONDUCTING CONFERENCES AND SEMINARS IN THE FIELD OF ENVIRONMENTAL ISSUES AND ENVIRONMENTAL TECHNOLOGY (U.S. CLS. 100, 101 AND 107).

FIRST USE 1-0-2000; IN COMMERCE 1-0-2000.

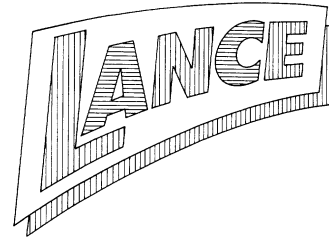

OWNER OF U.S. REG. NOS. 614,054, 1,693,515, AND OTHERS.

THE DRAWING IS LINED FOR THE COLORS BLUE AND RED, AND THE COLORS ARE CLAIMED AS A FEATURE OF THE MARK.

CLASS 29—MEATS AND PROCESSED FOODS

FOR SNACK FOODS, NAMELY, POTATO CHIPS, SHELLED, ROASTED OR OTHERWISE PROCESSED PEANUTS, ALMONDS AND CASHEWS, SMOKED AND DRIED BEEF, SAUSAGE AND CHEESE, AND FRIED PORK-SKIN SNACKS (U.S. CL. 46).

FIRST USE 1-15-1998; IN COMMERCE 1-15-1998.

CLASS 30—STAPLE FOODS

FOR SNACK FOODS, NAMELY, CRACKERS, AND CRACKER SANDWICHES, COOKIES, AND COOKIE SANDWICHES, CAKES, CAKE-LIKE PRODUCTS, COMPOSED OF A SWEET FILLING WITH A COOKIE-LIKE COVERING, CORN CHIPS, TORTILLA CHIPS, POPPED POPCORN, PRETZELS, BREAD STICKS, CANDY, CHEWING GUM, CANDY AND CHEESE FLAVORED PUFFED CORN SNACKS, NAMELY, CHEESE BALLS AND CHEESE TWISTS (U.S. CL. 46).

FIRST USE 1-15-1998; IN COMMERCE 1-15-1998.

2,534,381. FAGIEN, STEVEN, BOCA RATON, FL. SN 75-286,825. PUB. 9-15-1998, FILED 5-5-1997.

ABOUT FACE

CLASS 16—PAPER GOODS AND PRINTED MATTER

FOR JOURNALS AND MAGAZINES PROVIDING INFORMATION ABOUT PLASTIC SURGERY, COSMETIC SURGERY, FASHION, FASHION DESIGN, SALON TREATMENT, SKIN CARE, COSMETICS, HAIR CARE AND STYLING, NAIL CARE AND STYLING, SKIN CARE AND REJUVENATION, EYE CARE AND EYE WEAR AND PERSONAL GROOMING (U.S. CLS. 2, 5, 22, 23, 29, 37, 38 AND 50).

FIRST USE 12-0-1999; IN COMMERCE 12-0-1999.

CLASS 41—EDUCATION AND ENTERTAINMENT

FOR ENTERTAINMENT SERVICES, NAMELY, ONGOING RADIO AND TELEVISION SHOWS PROVIDING INFORMATION ABOUT AND DISCUSSING PLASTIC SURGERY, COSMETIC SURGERY, FASHION, FASHION DESIGN, SALON TREATMENT, SKIN CARE, COSMETICS, HAIR CARE AND STYLING, NAIL CARE AND STYLING, SKIN CARE AND REJUVENATION, EYE CARE AND EYE WEAR AND PERSONAL GROOMING (U.S. CLS. 100, 101 AND 107).

FIRST USE 4-0-1997; IN COMMERCE 4-0-1997.

2,534,388. NORTHERN RESEARCH AND ENGINEERING CORPORATION, WOBURN, MA. SN 75-329,670. PUB. 7-28-1998, FILED 7-24-1997.

POWERWORKS**CLASS 7—MACHINERY**

FOR COMBUSTION TURBINE-DRIVEN PRODUCTS, NAMELY, ENGINE MODULES, COMBUSTORS, BLOWERS, VACUUMS, PROPULSERS, PROPELLERS, MULTI-PURPOSE ELECTRICAL GENERATORS, MULTI-PURPOSE FLUID COMPRESSORS (U.S. CLS. 13, 19, 21, 23, 31, 34 AND 35).

FIRST USE 7-0-2000; IN COMMERCE 11-6-2000.

CLASS 11—ENVIRONMENTAL CONTROL APPARATUS

FOR COMBUSTION TURBINE-DRIVEN PRODUCTS, NAMELY, MULTI-PURPOSE CHILLERS AND FANS (U.S. CLS. 13, 21, 23, 31 AND 34).

FIRST USE 7-0-2000; IN COMMERCE 11-6-2000.

2,534,395. BIBB COMPANY, THE, ATLANTA, GA. SN 75-366,580. PUB. 9-14-1999, FILED 10-1-1997.

CASUAL KIDS

NO CLAIM IS MADE TO THE EXCLUSIVE RIGHT TO USE "KIDS", APART FROM THE MARK AS SHOWN.

CLASS 20—FURNITURE AND ARTICLES NOT OTHERWISE CLASSIFIED

FOR SLUMBER BAGS, HAND MIRRORS, FABRIC COVERED JEWELRY BOXES, FABRIC COVERED VANITY BENCHES, FABRIC COVERED HAMPERS, PILLOWS (U.S. CLS. 2, 13, 22, 25, 32 AND 50).

FIRST USE 0-0-1996; IN COMMERCE 0-0-1996.

CLASS 24—FABRICS

FOR SHEETS; PILLOWCASES; COMFORTERS; BEDSPREADS; BEDSKIRTS; TOWELS; FABRIC SHOWER CURTAINS; BLANKETS; WINDOW TREATMENTS, NAMELY, DRAPES, CURTAINS, SWAGS AND VALANCES; PILLOW SHAMS; BED AND CRIB CANOPIES; JACQUARD THROWS; DUVET (U.S. CLS. 42 AND 50).

FIRST USE 0-0-1996; IN COMMERCE 0-0-1996.

2,534,397. XULU ENTERTAINMENT INC., SAN JOSE, CA. SN 75-372,277. PUB. 8-4-1998, FILED 10-14-1997.

XULU ENTERTAINMENT

NO CLAIM IS MADE TO THE EXCLUSIVE RIGHT TO USE "ENTERTAINMENT", APART FROM THE MARK AS SHOWN.

CLASS 35—ADVERTISING AND BUSINESS

FOR RETAIL SERVICES, NAMELY, RETAIL STORE SERVICES, ON-LINE RETAIL SERVICES AND DIRECT MAIL RETAIL SERVICES, ALL FEATURING COMPUTER SOFTWARE AND HARDWARE; COMPUTER GAMES, VIDEO GAMES, BOOKS, COMIC BOOKS, MAGAZINES, TOYS, DECALS, STICKERS, TATTOOS, BACKPACKS, LUNCHBOXES, BICYCLES, COSTUMES, MASKS, WORKS OF ART, GLASSES, DISHES, SERVING TRAYS, POST CARDS, POSTERS, WATCHES, PINS, JEWELRY, SUNGLASSES, KEY CHAINS AND CLOTHING (U.S. CLS. 100, 101 AND 102).

FIRST USE 8-24-2001; IN COMMERCE 8-24-2001.

CLASS 42—SCIENTIFIC, COMPUTER AND LEGAL SERVICES

FOR RESTAURANT SERVICES (U.S. CLS. 100 AND 101).

FIRST USE 10-18-2001; IN COMMERCE 10-19-2001.

2,534,408. ANTIVIRALS INC., PORTLAND, OR. SN 75-409,264. PUB. 6-29-1999, FILED 12-22-1997.

AVICINE**CLASS 1—CHEMICALS**

FOR REAGENTS FOR SCIENTIFIC AND MEDICAL RESEARCH USE (U.S. CLS. 1, 5, 6, 10, 26 AND 46).

FIRST USE 5-5-1999; IN COMMERCE 5-5-1999.

CLASS 5—PHARMACEUTICALS

FOR REAGENTS FOR CLINICAL OR MEDICAL LABORATORY AND DIAGNOSTIC USE (U.S. CLS. 6, 18, 44, 46, 51 AND 52).

FIRST USE 5-5-1999; IN COMMERCE 5-5-1999.

2,534,416. UNISCRIBE PROFESSIONAL SERVICES, INC. NORWALK, CT. SN 75-440,321. PUB. 6-13-2000, FILED 2-25-1998.

UNISCRIBE**CLASS 35—ADVERTISING AND BUSINESS**

FOR PHOTOCOPIING; MAIL SORTING, HANDLING, AND RECEIVING; DOCUMENT AND RECORDS MANAGEMENT SERVICES, NAMELY, INDEXING AND FILING (U.S. CLS. 100, 101 AND 102).

FIRST USE 1-16-1998; IN COMMERCE 1-16-1998.

CLASS 38—COMMUNICATION

FOR FACSIMILE TRANSMISSION (U.S. CLS. 100, 101 AND 104).

FIRST USE 1-16-1998; IN COMMERCE 1-16-1998.

CLASS 39—TRANSPORTATION AND STORAGE

FOR MESSAGE DELIVERY SERVICES; DOCUMENT STORAGE (U.S. CLS. 100 AND 105).
FIRST USE 1-16-1998; IN COMMERCE 1-16-1998.

CLASS 40—MATERIAL TREATMENT

FOR DIGITAL IMAGING SERVICES (U.S. CLS. 100, 103 AND 106).
FIRST USE 1-16-1998; IN COMMERCE 1-16-1998.

CLASS 42—SCIENTIFIC, COMPUTER AND LEGAL SERVICES

FOR LITIGATION SUPPORT SERVICES; DIGITAL NETWORK PRINTING SERVICES (U.S. CLS. 100 AND 101).
FIRST USE 1-16-1998; IN COMMERCE 1-16-1998.

2,534,419. IMAGENE INC., SHREWSBURY, MA. SN 75-459,895. PUB. 12-7-1999, FILED 3-31-1998.

IMAGENE

CLASS 1—CHEMICALS

FOR NUCLEIC ACID PROBES CONSISTING OF DNA NUCLEIC ACID REAGENTS FOR LABORATORY OR RESEARCH USE; KITS COMPOSED OF REAGENTS FOR PROBING NUCLEIC ACID COMPONENTS OF CELLS AND TISSUES FOR LABORATORY OR RESEARCH USE (U.S. CLS. 1, 5, 6, 10, 26 AND 46).
FIRST USE 8-17-2001; IN COMMERCE 8-17-2001.

CLASS 9—ELECTRICAL AND SCIENTIFIC APPARATUS

FOR COMPUTER SOFTWARE FOR USE IN THE ACQUISITION AND ANALYSIS OF IMAGES OBTAINED BY MICROSCOPY (U.S. CLS. 21, 23, 26, 36 AND 38).
FIRST USE 8-17-2001; IN COMMERCE 8-17-2001.

2,534,421. KELLERMANN, GUIDO, 52062 AACHEN, FED REP GERMANY. SN 75-463,562. PUB. 9-12-2000, FILED 4-7-1998.

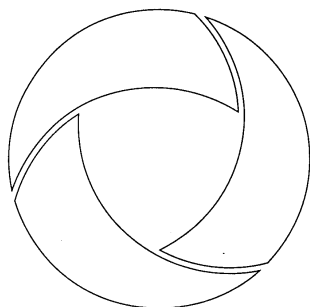

PRIORITY CLAIMED UNDER SEC. 44(D) ON FED REP GERMANY APPLICATION NO. 2902862, FILED 3-13-1995, REG. NO. 2902862, DATED 3-13-1995, EXPIRES 9-30-2004.

CLASS 12—VEHICLES

FOR MOTORCYCLE PARTS, NAMELY, DIRECTIONAL TURN SIGNALS, VIBRATION DAMPERS, CHAIN COVERS, COCKPITS (U.S. CLS. 19, 21, 23, 31, 35 AND 44).
FIRST USE 5-0-1998; IN COMMERCE 10-18-1998.

CLASS 42—SCIENTIFIC, COMPUTER AND LEGAL SERVICES

FOR TECHNICAL CONSULTING SERVICES RELATED TO CONSTRUCTION AND MANUFACTURE OF MOTORCYCLES (U.S. CLS. 100 AND 101).
FIRST USE 5-0-1998; IN COMMERCE 10-18-1998.

2,534,423. CIMA LABS, INC., EDEN PRAIRIE, MN. SN 75-465,291. PUB. 12-14-1999, FILED 4-9-1998.

PAKSOLV

CLASS 35—ADVERTISING AND BUSINESS

FOR PACKAGING MERCHANDISE FOR OTHERS, NAMELY, TABLETS AND CAPSULES, VITAMINS, FOOD SUPPLEMENTS AND ANIMAL VETERINARY TABLETS (U.S. CLS. 100, 101 AND 102).
FIRST USE 0-0-1996; IN COMMERCE 0-0-1996.

CLASS 42—SCIENTIFIC, COMPUTER AND LEGAL SERVICES

FOR CUSTOM PACKAGING DESIGN FOR OTHERS IN THE FIELD OF PHARMACEUTICAL TABLETS AND CAPSULES, VITAMINS, FOOD SUPPLEMENTS AND ANIMAL VETERINARY TABLETS (U.S. CLS. 100 AND 101).
FIRST USE 0-0-1996; IN COMMERCE 0-0-1996.

2,534,424. WILCOR INTERNATIONAL, INC., NAPLES, FL. SN 75-465,658. PUB. 6-8-1999, FILED 4-10-1998.

LIVING WITH STYLE

CLASS 35—ADVERTISING AND BUSINESS

FOR PRODUCTION OF TELEVISION ADVERTISEMENTS (U.S. CLS. 100, 101 AND 102).
FIRST USE 6-0-1998; IN COMMERCE 10-26-1998.

CLASS 41—EDUCATION AND ENTERTAINMENT

FOR PRODUCTIONS OF TELEVISION PROGRAMS, NAMELY, PROGRAMS RELATING TO HOME CONSTRUCTION, DESIGN AND DECORATING (U.S. CLS. 100, 101 AND 107).
FIRST USE 6-0-1998; IN COMMERCE 10-26-1998.

2,534,430. HENRY COOKE LIMITED, STAFFORDSHIRE, ST15 0SA, ENGLAND, BY CHANGE OF NAME BARLOW PAPER LIMITED, STONE, STAFFORDSHIRE, UNITED KINGDOM. SN 75-475,650. PUB. 11-30-1999, FILED 4-28-1998.

HYCONEER

OWNER OF UNITED KINGDOM REG. NO. 1158463, DATED 7-28-1981, EXPIRES 7-28-2002.

CLASS 16—PAPER GOODS AND PRINTED MATTER

FOR PAPER OR PAPER PRODUCTS PRIMARILY OF PAPER, NAMELY, UNPRINTED AND PRINTED PAPER, UNLAMINATED AND LAMINATED PAPER, ALL FOR SUBSEQUENT USE IN THE MANUFACTURE OF VENEERS; AND A LOW BASIS WEIGHT PAPER SUITABLE FOR PRINTING AND LAMINATING TO WOOD-BASED SUBSTRATES AS AN ALTERNATIVE TO GENUINE WOOD VENEERS (U.S. CLS. 2, 5, 22, 23, 29, 37, 38 AND 50).

FIRST USE 3-19-2001; IN COMMERCE 3-19-2001.

CLASS 19—NON-METALLIC BUILDING MATERIALS

FOR WOOD VENEERS; VENEERS FOR FLOORS; PAPER VENEERS AND LAMINATES, VENEERS AND LAMINATES PRIMARILY OF PAPER FOR USE ON OR IN RELATION TO VARIOUS TYPES OF FURNITURE AND FURNISHINGS, NAMELY, DOMESTIC AND OFFICE FURNITURE AND FURNISHINGS, KITCHEN FURNITURE AND FURNISHINGS, EDUCATIONAL FURNITURE AND FURNISHINGS, INTERIORS OF BUILDINGS, VEHICLES, CARAVANS AND FOR OFFICE EQUIPMENT (U.S. CLS. 1, 12, 33 AND 50).

FIRST USE 3-19-2001; IN COMMERCE 3-19-2001.

CLASS 35—ADVERTISING AND BUSINESS

FOR BUSINESS SERVICES, NAMELY, TELEPHONE MANAGEMENT AND ACCOUNTING REPORT SERVICES; COMPUTERIZED DATABASE MANAGEMENT SERVICES; MARKETING RESEARCH SERVICES; CONDUCTING MARKETING STUDIES; TELEMARKETING SERVICES; DATA PROCESSING SERVICES IN THE FIELDS OF INTERNAL TELECOMMUNICATION SYSTEMS AND INFORMATION MANAGEMENT SYSTEMS; BUSINESS CONSULTING SERVICES IN THE FIELDS OF INTERNAL COMMUNICATION SYSTEMS AND INFORMATION PROCESSING AND MANAGEMENT SYSTEMS; ACCOUNT MANAGEMENT SERVICES IN THE FIELDS OF INTERNAL TELECOMMUNICATION SYSTEMS; TELECOMMUNICATION BILLING; GENERATING REPORTS DETAILING CUSTOMER USAGE OF TELECOMMUNICATIONS EQUIPMENT; PROVIDING OUTSOURCED CUSTOMER SUPPORT SERVICES FOR OTHERS IN THE NATURE OF INFORMATION MANAGEMENT AND ANSWERING CUSTOMER INQUIRIES THROUGH TELEPHONIC, ELECTRONIC, AND WORLDWIDE COMPUTER NETWORK-BASED MEANS (U.S. CLS. 100, 101 AND 102).

FIRST USE 6-1-1998; IN COMMERCE 6-1-1998.

CLASS 38—COMMUNICATION

FOR COMPUTER SERVICES, NAMELY, E-MAIL RESPONSE SERVICES; TELECOMMUNICATION MESSAGE PROCESSING SERVICES PROVIDED BY MEANS OF A WORLD WIDE COMPUTER NETWORK; E-MAIL, VOICEMAIL, CELLULAR TELEPHONE, LONG-DISTANCE TELEPHONE, FACSIMILE TRANSMISSION; CELLULAR TELEPHONE COMMUNICATION SERVICES (U.S. CLS. 100, 101 AND 104).

FIRST USE 6-1-1998; IN COMMERCE 6-1-1998.

CLASS 42—SCIENTIFIC, COMPUTER AND LEGAL SERVICES

FOR CUSTOM COMPUTER SYSTEM ANALYSIS, DESIGN AND DEVELOPMENT; COMPUTER SOFTWARE DESIGN SERVICES AND CONSULTING SERVICES RELATING THERETO (U.S. CLS. 100 AND 101).

FIRST USE 6-1-1998; IN COMMERCE 6-1-1998.

2,534,431. CONVERGYS CORPORATION, CINCINNATI, OH. SN 75-477,825. PUB. 1-18-2000, FILED 5-1-1998.

CONVERGYS

2,534,432. EORIGINAL, INC., BALTIMORE, MD, BY ASSIGNMENT DOCUMENT AUTHENTICATION SYSTEMS, INC., BALTIMORE, MD. SN 75-483,578. PUB. 12-7-1999, FILED 5-12-1998.

the electronic original company

CLASS 9—ELECTRICAL AND SCIENTIFIC APPARATUS

FOR COMPUTER SOFTWARE PROGRAMS; NAMELY PROGRAMS FOR PRODUCING TELEPHONE SYSTEM REPORTS (U.S. CLS. 21, 23, 26, 36 AND 38).

FIRST USE 8-13-1998; IN COMMERCE 8-13-1998.

NO CLAIM IS MADE TO THE EXCLUSIVE RIGHT TO USE "ELECTRONIC ORIGINAL", APART FROM THE MARK AS SHOWN.

CLASS 9—ELECTRICAL AND SCIENTIFIC APPARATUS

FOR COMPUTER SOFTWARE AND HARDWARE FOR THE ELECTRONIC TRANSMISSION, STORAGE AND RETRIEVAL OF AUTHENTICATED ELECTRONIC DOCUMENTS USING SOPHISTICATED CRYPTOGRAPHIC TECHNOLOGY AND PROVIDING ACCESS, VERSION AND DISTRIBUTION CONTROLS TOGETHER WITH A SECURE ELECTRONIC STORAGE FACILITY, ALL FOR USE IN THE CONTROL OF DOCUMENTATION OR OTHER INFORMATION OBJECTS IN MORTGAGE, LEASING, PHARMACEUTICAL AND OTHER BUSINESS APPLICATIONS (U.S. CLS. 21, 23, 26, 36 AND 38).

FIRST USE 5-0-1998; IN COMMERCE 5-0-1998.

CLASS 38—COMMUNICATION

FOR ELECTRONIC TRANSMISSION OF AUTHENTICATED ELECTRONIC DOCUMENTS USING SOPHISTICATED CRYPTOGRAPHIC TECHNOLOGY AND PROVIDING ACCESS, VERSION AND DISTRIBUTION CONTROLS, ALL FOR USE IN THE CONTROL OF DOCUMENTATION OR OTHER INFORMATION OBJECTS IN MORTGAGE, LEASING, PHARMACEUTICAL AND OTHER BUSINESS APPLICATIONS (U.S. CLS. 100, 101 AND 104).

FIRST USE 5-0-1998; IN COMMERCE 5-0-1998.

CLASS 39—TRANSPORTATION AND STORAGE

FOR ELECTRONIC STORAGE OF AUTHENTICATED ELECTRONIC DOCUMENTS USING SOPHISTICATED CRYPTOGRAPHIC TECHNOLOGY AND PROVIDING A SECURE ELECTRONIC STORAGE FACILITY, ALL FOR USE IN THE CONTROL OF DOCUMENTATION OR OTHER INFORMATION OBJECTS IN MORTGAGE, LEASING, PHARMACEUTICAL AND OTHER BUSINESS APPLICATIONS (U.S. CLS. 100 AND 105).

FIRST USE 5-0-1998; IN COMMERCE 5-0-1998.

2,534,433. EORIGINAL, INC., BALTIMORE, MD, BY CHANGE OF NAME DOCUMENT AUTHENTICATION SYSTEMS, INC., BALTIMORE, MD. SN 75-483,579. PUB. 7-27-1999, FILED 5-12-1998.

E-ORIGINAL**CLASS 9—ELECTRICAL AND SCIENTIFIC APPARATUS**

FOR COMPUTER SOFTWARE AND HARDWARE FOR THE ELECTRONIC TRANSMISSION, STORAGE AND RETRIEVAL OF AUTHENTICATED ELECTRONIC DOCUMENTS USING SOPHISTICATED CRYPTOGRAPHIC TECHNOLOGY AND PROVIDING ACCESS, VERSION AND DISTRIBUTION CONTROLS TOGETHER WITH A SECURE ELECTRONIC STORAGE FACILITY, ALL FOR USE IN THE CONTROL OF DOCUMENTATION OR OTHER INFORMATION OBJECTS IN MORTGAGE, LEASING, PHARMACEUTICAL AND OTHER BUSINESS APPLICATIONS (U.S. CLS. 21, 23, 26, 36 AND 38).

FIRST USE 6-0-1999; IN COMMERCE 6-0-1999.

CLASS 38—COMMUNICATION

FOR ELECTRONIC TRANSMISSION OF AUTHENTICATED ELECTRONIC DOCUMENTS USING SOPHISTICATED CRYPTOGRAPHIC TECHNOLOGY AND PROVIDING ACCESS, VERSION AND DISTRIBUTION CONTROLS, ALL FOR USE IN THE CONTROL OF DOCUMENTATION OR INFORMATION OBJECTS IN MORTGAGE, LEASING, PHARMACEUTICAL AND OTHER BUSINESS APPLICATIONS (U.S. CLS. 100, 101 AND 104).

FIRST USE 6-0-1999; IN COMMERCE 6-0-1999.

CLASS 39—TRANSPORTATION AND STORAGE

FOR ELECTRONIC STORAGE OF AUTHENTICATED ELECTRONIC DOCUMENTS USING SOPHISTICATED CRYPTOGRAPHIC TECHNOLOGY AND PROVIDING A SECURE ELECTRONIC STORAGE FACILITY, ALL FOR USE IN THE CONTROL OF DOCUMENTATION OR OTHER INFORMATION OBJECTS IN MORTGAGE, LEASING, PHARMACEUTICAL AND OTHER BUSINESS APPLICATIONS (U.S. CLS. 100 AND 105).

FIRST USE 6-0-1999; IN COMMERCE 6-0-1999.

2,534,434. EORIGINAL, INC., BALTIMORE, MD, BY ASSIGNMENT DOCUMENT AUTHENTICATION SYSTEMS, INC., BALTIMORE, MD. SN 75-483,580. PUB. 12-7-1999, FILED 5-12-1998.

TRUSTED CUSTODIAL UTILITY

NO CLAIM IS MADE TO THE EXCLUSIVE RIGHT TO USE "UTILITY", APART FROM THE MARK AS SHOWN.

CLASS 9—ELECTRICAL AND SCIENTIFIC APPARATUS

FOR COMPUTER SOFTWARE AND HARDWARE FOR THE ELECTRONIC TRANSMISSION, STORAGE AND RETRIEVAL OF AUTHENTICATED ELECTRONIC DOCUMENTS USING SOPHISTICATED CRYPTOGRAPHIC TECHNOLOGY AND PROVIDING ACCESS, VERSION AND DISTRIBUTION CONTROLS TOGETHER WITH A SECURE ELECTRONIC STORAGE FACILITY, ALL FOR USE IN THE CONTROL OF DOCUMENTATION OR OTHER INFORMATION OBJECTS IN MORTGAGE, LEASING, PHARMACEUTICAL AND OTHER BUSINESS APPLICATIONS (U.S. CLS. 21, 23, 26, 36 AND 38).

FIRST USE 5-0-1998; IN COMMERCE 5-0-1998.

CLASS 38—COMMUNICATION

FOR ELECTRONIC TRANSMISSION OF AUTHENTICATED ELECTRONIC DOCUMENTS USING SOPHISTICATED CRYPTOGRAPHIC TECHNOLOGY AND PROVIDING ACCESS, VERSION AND DISTRIBUTION CONTROLS ALL FOR USE IN THE CONTROL OF DOCUMENTATION OR OTHER INFORMATION OBJECTS IN MORTGAGE, LEASING, PHARMACEUTICAL AND OTHER BUSINESS APPLICATIONS (U.S. CLS. 100, 101 AND 104).

FIRST USE 5-0-1998; IN COMMERCE 5-0-1998.

CLASS 39—TRANSPORTATION AND STORAGE

FOR ELECTRONIC STORAGE OF AUTHENTICATED ELECTRONIC DOCUMENTS USING SOPHISTICATED CRYPTOGRAPHIC TECHNOLOGY AND PROVIDING A SECURE ELECTRONIC STORAGE FACILITY, ALL FOR USE IN THE CONTROL OF DOCUMENTATION OR OTHER INFORMATION OBJECTS IN MORTGAGE, LEASING, PHARMACEUTICAL AND OTHER BUSINESS APPLICATIONS (U.S. CLS. 100 AND 105).

FIRST USE 5-0-1998; IN COMMERCE 5-0-1998.

2,534,436. PARADOCX VINEYARD, LTD., KEMBLESVILLE, PA. SN 75-487,649. PUB. 8-17-1999, FILED 5-19-1998.

2,534,441. NATIONAL CENTER ON EDUCATION AND THE ECONOMY, WASHINGTON, DC. SN 75-489,947. PUB. 1-9-2001, FILED 5-22-1998.

PARADOCX VINEYARD

NO CLAIM IS MADE TO THE EXCLUSIVE RIGHT TO USE "VINEYARD", APART FROM THE MARK AS SHOWN.

CLASS 29—MEATS AND PROCESSED FOODS

FOR AGRICULTURAL PRODUCTS, NAMELY, PROCESSED GRAPES (U.S. CL. 46).
FIRST USE 9-16-2000; IN COMMERCE 9-20-2000.

CLASS 31—NATURAL AGRICULTURAL PRODUCTS

FOR NATURAL AGRICULTURAL PRODUCTS, NAMELY, FRESH GRAPES (U.S. CLS. 1 AND 46).
FIRST USE 9-13-2000; IN COMMERCE 9-23-2000.

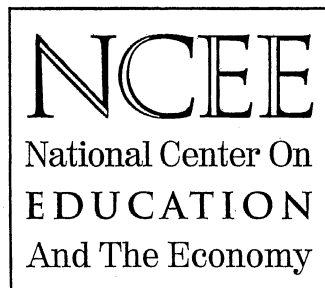

NO CLAIM IS MADE TO THE EXCLUSIVE RIGHT TO USE "EDUCATION", APART FROM THE MARK AS SHOWN.

SEC. 2(F) AS TO "NATIONAL CENTER ON EDUCATION AND THE ECONOMY".

CLASS 9—ELECTRICAL AND SCIENTIFIC APPARATUS

FOR PRE-RECORDED VIDEO TAPES, AUDIO TAPES, COMPACT DISCS AND VIDEO DISCS FOR TESTING, ASSESSMENT, CURRICULUM DEVELOPMENT, TEACHING, AND IMPLEMENTING EDUCATION AND EMPLOYMENT REFORMS, ALL IN THE FIELDS OF EDUCATION AND EMPLOYMENT; AND COMPUTER AND MULTIMEDIA SOFTWARE THAT ENABLE TESTING, ASSESSMENT, CURRICULUM DEVELOPMENT, TEACHING AND IMPLEMENTING EDUCATION AND EMPLOYMENT REFORMS, ALL IN THE FIELDS OF EDUCATION AND EMPLOYMENT (U.S. CLS. 21, 23, 26, 36 AND 38).

FIRST USE 2-0-1998; IN COMMERCE 2-0-1998.

CLASS 16—PAPER GOODS AND PRINTED MATTER

FOR BOOKS, BOOKLETS, BROCHURES, BULLETINS, INFORMATIONAL FLYERS, INFORMATIONAL LETTERS, LEAFLETS, NEWSLETTERS, AND QUESTIONNAIRES, ALL CONCERNING AND FOR USE IN CONNECTION WITH TESTING, ASSESSMENT, CURRICULUM, TEACHING, AND IMPLEMENTATION OF EDUCATION AND EMPLOYMENT REFORMS; COMPUTER PROGRAM MANUALS CONCERNING SOFTWARE FOR USE IN CONNECTION WITH TESTING, ASSESSMENT, CURRICULUM, TEACHING, AND IMPLEMENTATION OF EDUCATION AND EMPLOYMENT REFORMS; BINDERS, FILE FOLDERS, PAPER FILE JACKETS, PRINTED LECTURES, STATIONERY- TYPE PORTFOLIOS, AND STUDY GUIDES, ALL FOR USE IN CONNECTION WITH TESTING, ASSESSMENT, CURRICULUM, TEACHING, AND IMPLEMENTATION OF EDUCATION AND EMPLOYMENT REFORMS; WORK BOOKS DIRECTED TO AND FOR USE IN CONNECTION WITH TESTING, ASSESSMENT, CURRICULUM, TEACHING, AND IMPLEMENTATION OF EDUCATION AND EMPLOYMENT REFORMS; AND PRINTED TEACHING, TESTING AND ASSESSMENT MATERIALS FOR USE IN TESTING, ASSESSMENT, CURRICULUM DEVELOPMENT, TEACHING, AND IMPLEMENTATION OF EDUCATION AND EMPLOYMENT REFORMS (U.S. CLS. 2, 5, 22, 23, 29, 37, 38 AND 50).

FIRST USE 2-0-1998; IN COMMERCE 2-0-1998.

2,534,438. HARD ROCK HOTEL & CASINO, INC., LOS ANGELES, CA. SN 75-489,003. PUB. 6-8-1999, FILED 5-21-1998.



THE LINING AND STIPPLING ARE FOR SHADING PURPOSES ONLY AND ARE NOT INDICATE COLOR.

CLASS 41—EDUCATION AND ENTERTAINMENT

FOR CASINO SERVICES (U.S. CLS. 100, 101 AND 107).
FIRST USE 7-30-1998; IN COMMERCE 7-30-1998.

CLASS 42—SCIENTIFIC, COMPUTER AND LEGAL SERVICES

FOR HOTEL SERVICES (U.S. CLS. 100 AND 101).
FIRST USE 7-30-1998; IN COMMERCE 7-30-1998.

CLASS 41—EDUCATION AND ENTERTAINMENT

FOR EDUCATIONAL SERVICES, NAMELY, EDUCATIONAL TESTING AND ASSESSMENT SERVICES, CURRICULUM DEVELOPMENT, TEACHING, ASSISTING IN THE IMPLEMENTATION OF EDUCATION AND EMPLOYMENT REFORMS, AND CONSULTING SERVICES RELATED THERETO; TRAINING SERVICES IN THE NATURE OF WORKSHOPS, SEMINARS, AND CONFERENCES FOR OTHERS CONCERNING TESTING, ASSESSMENT, CURRICULUM DEVELOPMENT, TEACHING, AND IMPLEMENTATION OF EDUCATION AND EMPLOYMENT REFORMS; EDUCATIONAL RESEARCH SERVICES IN THE FIELDS OF ACADEMIC AND VOCATIONAL EDUCATION AND EMPLOYMENT TRAINING (U.S. CLS. 100, 101 AND 107).

FIRST USE 2-0-1998; IN COMMERCE 2-0-1998.

2,534,446. MICROBURST, INC., ROCKVILLE, MD. SN 75-509,037. PUB. 6-20-2000, FILED 6-25-1998.

MBURST**CLASS 41—EDUCATION AND ENTERTAINMENT**

FOR EDUCATIONAL SERVICES, NAMELY, PROVIDING CUSTOM TRAINING IN THE FIELD OF COMPUTER PROGRAMMING (U.S. CLS. 100, 101 AND 107).

FIRST USE 7-23-2000; IN COMMERCE 7-23-2000.

CLASS 42—SCIENTIFIC, COMPUTER AND LEGAL SERVICES

FOR COMPUTER PROGRAMMING FOR OTHERS IN THE FIELDS OF SOFTWARE APPLICATION DESIGN, CHARACTER-BASED PROGRAMMING, GRAPHICAL INTERFACE PROGRAMMING, INTERNATIONAL PORTING PLATFORM CONVERSION, WORD PROCESSING, SPREADSHEETS, CHARTING, DATA FILER AND REPORT WRITING PROGRAMMING, ELECTRONIC MESSAGE HANDLING AND WIRELESS COMMUNICATIONS PROGRAMMING (U.S. CLS. 100 AND 101).

FIRST USE 7-23-2000; IN COMMERCE 7-23-2000.

2,534,443. BLIMPIE INTERNATIONAL, INC., NEW YORK, NY. SN 75-496,764. PUB. 10-12-1999, FILED 6-5-1998.

IT'S TIME TO EAT

NO CLAIM IS MADE TO THE EXCLUSIVE RIGHT TO USE "EAT", APART FROM THE MARK AS SHOWN.

CLASS 29—MEATS AND PROCESSED FOODS

FOR BEEF; CHEESE; PARMESAN CHEESE; CHICKEN; FROZEN PREPARED AND PACKAGED ENTREES CONSISTING PRIMARILY OF MEAT; FROZEN, PREPARED AND PACKAGED ENTREES CONSISTING PRIMARILY OF POULTRY; FROZEN, PREPARED AND PACKAGED ENTREES, CONSISTING PRIMARILY OF VEGETABLES; FROZEN, PREPARED AND PACKAGED MEALS CONSISTING PRIMARILY OF MEAT; FROZEN, PREPARED AND PACKAGED MEALS CONSISTING PRIMARILY OF POULTRY; FROZEN, PREPARED AND PACKAGED MEALS CONSISTING PRIMARILY OF VEGETABLES; MEAT; MEAT BALLS; PROCESSED PEPPERS; POULTRY; SALADS EXCEPT MACARONI, RICE, AND PASTA SALADS; GARDEN SALADS; VEGETABLE SALADS; SAUSAGES; SOUPS (U.S. CL. 46).

FIRST USE 3-0-1999; IN COMMERCE 3-0-1999.

CLASS 30—STAPLE FOODS

FOR BREAD; BREAD STICKS; CAKES; CHEESE CAKE; CHEESE BREAD; COOKIES; COCOA; COFFEE; COFFEE BASED BEVERAGES; COCOA BASED BEVERAGES; COOKIES; DRESSINGS FOR USE WITH SANDWICHES; ESPRESSO; FOCACCIA BREAD, FOCACCIA STICKS; LASAGNA; MACARONI; MACARONI AND CHEESE; MACARONI SALAD; FROZEN, PREPARED AND PACKAGED ENTREES CONSISTING PRIMARILY OF PASTA; FROZEN, PREPARED AND PACKAGED MEALS CONSISTING PRIMARILY OF PASTA; PASTA; PASTA SALAD; PASTA SHELLS; PIES; PIZZA; PIZZA CRUST; PIZZA DOUGH; PIZZA ROLLS; PIZZA SAUCE; RAVIOLI; BREAD, NAMELY, ROLLS SANDWICHES; SPAGHETTI SAUCE; TOMATO SAUCE; SAUCES; PASTA SAUCES; PROCESSED SEMOLINA (U.S. CL. 46).

FIRST USE 3-0-1999; IN COMMERCE 3-0-1999.

CLASS 42—SCIENTIFIC, COMPUTER AND LEGAL SERVICES

FOR RESTAURANT AND CARRY OUT RESTAURANT SERVICES (U.S. CLS. 100 AND 101).

FIRST USE 3-0-1999; IN COMMERCE 3-0-1999.

2,534,454. STANLEY LOGISTICS, INC., NEW BRITAIN, CT. SN 75-525,260. PUB. 11-23-1999, FILED 7-23-1998.

STANLEY

OWNER OF U.S. REG. NOS. 178,322, 2,131,717, AND OTHERS.

CLASS 6—METAL GOODS

FOR METAL PATIO DOORS (U.S. CLS. 2, 12, 13, 14, 23, 25 AND 50).

FIRST USE 10-0-1981; IN COMMERCE 10-0-1981.

CLASS 8—HAND TOOLS

FOR HAND OPERATED GARDEN TOOLS, NAMELY PRUNERS, SHEARS, GARDEN AND UTILITY SCISSORS, LOPPERS, SAWS, TROWELS, TRANSPLANTERS, CULTIVATORS, HOES, RAKES, SPADES, BORDER FORKS AND DIGGING FORKS (U.S. CLS. 23, 28 AND 44).

FIRST USE 1-7-1999; IN COMMERCE 1-7-1999.

CLASS 19—NON-METALLIC BUILDING MATERIALS

FOR NON-METAL PATIO DOORS (U.S. CLS. 1, 12, 33 AND 50).

FIRST USE 0-0-1991; IN COMMERCE 0-0-1991.

2,534,469. WGBH EDUCATIONAL FOUNDATION, BOSTON, MA. SN 75-556,589. PUB. 1-30-2001, FILED 9-18-1998.



OWNER OF U.S. REG. NO. 988,819.
LINING IS A FEATURE OF THE MARK AND DOES NOT INDICATE COLOR.

CLASS 9—ELECTRICAL AND SCIENTIFIC APPARATUS

FOR COMPUTER, VIDEO, AND AUDIO RECORDINGS MADE ON DISCS, TAPES, CASSETTES, CARTRIDGES, AND CD-ROM BY LASER AND/OR ELECTRONIC MEANS FEATURING A CHILDREN'S EDUCATIONAL TELEVISION SERIES; COMPUTER GAME DISCS AND COMPUTER GAME CASSETTES; VIDEO GAME CARTRIDGES; TELEVISION, COMPUTER AND VIDEO GAME SOFTWARE (U.S. CLS. 21, 23, 26, 36 AND 38).

FIRST USE 6-1-1999; IN COMMERCE 6-1-1999.

CLASS 16—PAPER GOODS AND PRINTED MATTER

FOR PUBLICATIONS, NAMELY, BOOKS AND MAGAZINES FEATURING SUBJECT MATTER CONTAINED IN A CHILDREN'S EDUCATIONAL TELEVISION SERIES, NAMELY, ACTIVITIES, STORIES, COOKING, PUZZLES, RIDDLES, JOKES AND SCIENCE (U.S. CLS. 2, 5, 22, 23, 29, 37, 38 AND 50).

FIRST USE 9-1-1999; IN COMMERCE 9-1-1999.

2,534,480. TWO WHEELS, INC., FERNDALE, MI. SN 75-579,321. PUB. 12-28-1999, FILED 10-29-1998.



NO CLAIM IS MADE TO THE EXCLUSIVE RIGHT TO USE "BAR", APART FROM THE MARK AS SHOWN.

THE LINING IS A FEATURE OF THE MARK AND DOES NOT INDICATE COLOR. THE STIPPLING IS A FEATURE OF THE MARK AND DOES NOT INDICATE COLOR.

CLASS 25—CLOTHING

FOR CLOTHING, NAMELY, SHIRTS, CAPS, T-SHIRTS, JACKETS, SWEATERS, HATS, UNIFORMS, WIND RESISTANT JACKETS, AND SWEATSHIRTS (U.S. CLS. 22 AND 39).

FIRST USE 4-29-1999; IN COMMERCE 11-1-1998.

CLASS 42—SCIENTIFIC, COMPUTER AND LEGAL SERVICES

FOR RESTAURANT, BAR, NIGHTCLUB AND RESTAURANT TAKE OUT SERVICES (U.S. CLS. 100 AND 101).

FIRST USE 4-29-1999; IN COMMERCE 11-1-1998.

2,534,482. IMMERSENCE INC., MONTREAL, QUEBEC, CANADA. SN 75-585,823. PUB. 2-22-2000, FILED 11-10-1998.

EPHEMERE

THE ENGLISH TRANSLATION OF "EPHEMERE" IS "EPHEMERAL, PASSING OR FLEETING".

CLASS 9—ELECTRICAL AND SCIENTIFIC APPARATUS

FOR SOFTWARE FOR CREATING AND EXPERIENCING VIRTUAL REALITY ENVIRONMENTS; NAMELY, CD-ROMS AND COMPACT DISCS FEATURING MUSIC AND IMAGES RELATED TO NATURE, TIME AND SPACE, PRERECORDED AUDIO TAPES FEATURING MUSIC AND IMAGES RELATED TO NATURE, TIME AND SPACE, PRERECORDED VIDEO TAPES FEATURING MUSIC AND IMAGES RELATED TO NATURE, TIME AND SPACE (U.S. CLS. 21, 23, 26, 36 AND 38).

FIRST USE 6-26-1998; IN COMMERCE 6-26-1998.

CLASS 16—PAPER GOODS AND PRINTED MATTER

FOR PAINTINGS, ART AND LITHOGRAPH PRINTS, MOUNTED OR UNMOUNTED PHOTOGRAPHS AND HOLOGRAMS (U.S. CLS. 2, 5, 22, 23, 29, 37, 38 AND 50).

FIRST USE 6-26-1998; IN COMMERCE 6-26-1998.

2,534,499. MEDPERKS, INC., ALPHARETTA, GA. SN 75-613,367. PUB. 12-7-1999, FILED 12-29-1998.

GLOBALCARE CARD

NO CLAIM IS MADE TO THE EXCLUSIVE RIGHT TO USE "CARD", APART FROM THE MARK AS SHOWN.

CLASS 35—ADVERTISING AND BUSINESS

FOR HEALTH CARE REFERRAL SERVICES VIA WORLDWIDE COMPUTER NETWORKS (U.S. CLS. 100, 101 AND 102).

FIRST USE 11-1-1998; IN COMMERCE 11-1-1998.

CLASS 42—SCIENTIFIC, COMPUTER AND LEGAL SERVICES

FOR PROVIDING HEALTH CARE INFORMATION FEATURING MEDICAL TRIAGE PROTOCOLS VIA WORLDWIDE COMPUTER NETWORKS (U.S. CLS. 100 AND 101).

FIRST USE 11-1-1998; IN COMMERCE 11-1-1998.

2,534,501. BOONE, CARLA B., BROOKLYN, NY. SN 75-618,567. PUB. 2-1-2000, FILED 1-11-1999.

HOLLA'BACK RECORDS, ENTERTAINMENT & MANAGEMENT



NO CLAIM IS MADE TO THE EXCLUSIVE RIGHT TO USE "RECORDS, ENTERTAINMENT & MANAGEMENT", APART FROM THE MARK AS SHOWN.

CLASS 9—ELECTRICAL AND SCIENTIFIC APPARATUS

FOR PHONOGRAPH RECORDS, COMPACT DISKS, AND AUDIOCASSETTES FEATURING MUSIC (U.S. CLS. 21, 23, 26, 36 AND 38).

FIRST USE 8-0-1999; IN COMMERCE 8-0-1999.

CLASS 25—CLOTHING

FOR CLOTHING, NAMELY, SWEATSHIRTS, T-SHIRTS, SWEAT PANTS, HEADGEAR, NAMELY, HATS AND CAPS, AND JACKETS (U.S. CLS. 22 AND 39).

FIRST USE 8-0-1999; IN COMMERCE 8-0-1999.

CLASS 35—ADVERTISING AND BUSINESS

FOR MANAGEMENT OF PERFORMING ARTISTS, NAMELY, SINGERS, MODELS, AND/OR ACTORS (U.S. CLS. 100, 101 AND 102).

FIRST USE 8-0-1999; IN COMMERCE 8-0-1999.

2,534,503. CHRISTIAN UNIVERSITY GLOBALNET, LITTLETON, CO. SN 75-620,373. PUB. 8-1-2000, FILED 1-12-1999.

CHRISTIAN UNIVERSITY GLOBALNET

NO CLAIM IS MADE TO THE EXCLUSIVE RIGHT TO USE "CHRISTIAN UNIVERSITY", APART FROM THE MARK AS SHOWN.

CLASS 41—EDUCATION AND ENTERTAINMENT

FOR EDUCATIONAL SERVICES, NAMELY, PROVIDING DISTRIBUTED-LEARNING COURSES AND TRAINING IN THE FIELDS OF THE LIBERAL ARTS AND PROFESSIONAL STUDIES AT THE PERSONAL ENRICHMENT, GRADUATE, UNDERGRADUATE, AND POST-GRADUATE EDUCATION LEVELS, OFFERED ON AN ONLINE GLOBAL COMMUNICATIONS NETWORK, AND PRINTED MATERIALS OFFERED IN CONNECTION THEREWITH; PROVIDING A WEBSITE WHICH OFFERS INFORMATION IN THE FIELD OF EDUCATION; AND PUBLISHING IN THE FIELD OF EDUCATION (U.S. CLS. 100, 101 AND 107).

FIRST USE 7-15-1998; IN COMMERCE 7-15-1998.

CLASS 42—SCIENTIFIC, COMPUTER AND LEGAL SERVICES

FOR EDUCATIONAL CONSULTING SERVICES (U.S. CLS. 100 AND 101).

FIRST USE 7-15-1998; IN COMMERCE 7-15-1998.

2,534,505. ASIA CHEMICAL CORPORATION, TAIPEI, TAIWAN. SN 75-624,702. PUB. 7-4-2000, FILED 1-22-1999.

ACHEM

CLASS 9—ELECTRICAL AND SCIENTIFIC APPARATUS

FOR COOPER CLADDED LAMINATES FOR USE IN ELECTRONICS MANUFACTURING, NAMELY, THE MANUFACTURE OF PRINTED CIRCUIT BOARDS (U.S. CLS. 21, 23, 26, 36 AND 38).

FIRST USE 12-0-2000; IN COMMERCE 12-0-2000.

CLASS 16—PAPER GOODS AND PRINTED MATTER

FOR ADHESIVE TAPES, NAMELY, ADHESIVE TAPE FOR STATIONERY PURPOSES AND ADHESIVE TAPE DISPENSERS SOLD AS A UNIT (U.S. CLS. 2, 5, 22, 23, 29, 37, 38 AND 50).

FIRST USE 12-0-2000; IN COMMERCE 12-0-2000.

CLASS 17—RUBBER GOODS

FOR ADHESIVE TAPES, NAMELY, PACKAGING TAPES FOR INDUSTRIAL PURPOSES, ELECTRICAL TAPES FOR INDUSTRIAL PURPOSES, DOUBLE-SIDED TAPES FOR INDUSTRIAL PURPOSES, PROTECTIVE TAPES FOR INDUSTRIAL PURPOSES, PIPE JOINT TAPES AND ADHESIVE TAPE FOR INDUSTRIAL PURPOSES (U.S. CLS. 1, 5, 12, 13, 35 AND 50).

FIRST USE 12-0-2000; IN COMMERCE 12-0-2000.

2,534,511. MJP BOTANICALS, INC., TUCSON, AZ. SN 75-635,625. PUB. 10-31-2000, FILED 2-8-1999.

HERBAL FORTRESS

NO CLAIM IS MADE TO THE EXCLUSIVE RIGHT TO USE "HERBAL", APART FROM THE MARK AS SHOWN.

CLASS 5—PHARMACEUTICALS

FOR HERBAL NUTRITIONAL SUPPLEMENTS (U.S. CLS. 6, 18, 44, 46, 51 AND 52).

FIRST USE 5-27-1999; IN COMMERCE 5-27-1999.

CLASS 42—SCIENTIFIC, COMPUTER AND LEGAL SERVICES

FOR FOOD NUTRITION CONSULTATION AND COUNSELING (U.S. CLS. 100 AND 101).
FIRST USE 5-27-1999; IN COMMERCE 5-27-1999.

2,534,551. TRADER PUBLISHING COMPANY, NORFOLK, VA. SN 75-692,542. PUB. 4-25-2000, FILED 4-27-1999.

PAYLOAD**CLASS 35—ADVERTISING AND BUSINESS**

FOR ADVERTISING SERVICES, NAMELY PREPARING AND DISSEMINATING ADVERTISING FOR OTHERS VIA AN ONLINE ELECTRONIC COMMUNICATIONS NETWORK (U.S. CLS. 100, 101 AND 102).
FIRST USE 6-25-2001; IN COMMERCE 6-25-2001.

2,534,512. LIBERTY HARDWARE MFG. CORP., BOCA RATON, FL. SN 75-635,921. PUB. 1-16-2001, FILED 2-8-1999.

CLASS 42—SCIENTIFIC, COMPUTER AND LEGAL SERVICES

FOR COMPUTER SERVICES, NAMELY, PROVIDING AN ON-LINE ELECTRONIC DATABASE ON GLOBAL COMPUTER NETWORKS IN THE FIELD OF TRUCKS AND THE TRUCKING INDUSTRY (U.S. CLS. 100 AND 101).
FIRST USE 6-25-2001; IN COMMERCE 6-25-2001.

BRAINERD
MANUFACTURING CO.

NO CLAIM IS MADE TO THE EXCLUSIVE RIGHT TO USE "MANUFACTURING CO.", APART FROM THE MARK AS SHOWN.

CLASS 6—METAL GOODS

FOR METAL CABINET HARDWARE (U.S. CLS. 2, 12, 13, 14, 23, 25 AND 50).
FIRST USE 0-0-1998; IN COMMERCE 0-0-1998.

2,534,552. KABUSHIKI KAISHA RITTOR MUSIC, TA RITTOR MUSIC, INC., CHIYODA-KU, TOKYO, JAPAN. SN 75-693,096. PUB. 8-1-2000, FILED 4-28-1999.

CLASS 20—FURNITURE AND ARTICLES NOT OTHERWISE CLASSIFIED

FOR NON-METAL CABINET HARDWARE (U.S. CLS. 2, 13, 22, 25, 32 AND 50).
FIRST USE 0-0-1998; IN COMMERCE 0-0-1998.

RittorMusic

2,534,518. STAIRMASTER SPORTS/MEDICAL PRODUCTS, INC., KIRKLAND, WA. SN 75-644,331. PUB. 12-7-1999, FILED 2-18-1999.

STOMP

NO CLAIM IS MADE TO THE EXCLUSIVE RIGHT TO USE "MUSIC", APART FROM THE MARK AS SHOWN.

CLASS 9—ELECTRICAL AND SCIENTIFIC APPARATUS

FOR PRERECORDED VIDEO TAPES FEATURING INSTRUCTION IN EXERCISE, EXERCISE EQUIPMENT, FITNESS, AND HEALTH (U.S. CLS. 21, 23, 26, 36 AND 38).
FIRST USE 3-0-1999; IN COMMERCE 3-0-1999.

CLASS 9—ELECTRICAL AND SCIENTIFIC APPARATUS

FOR PRE-RECORDED VIDEOCASSETTES, VIDEO DISKS, CD-ROMS, VIDEO CDS, MDS, AND DVD FEATURING THE FIELD OF MUSIC (U.S. CLS. 21, 23, 26, 36 AND 38).
FIRST USE 4-10-1978; IN COMMERCE 9-0-1995.

CLASS 41—EDUCATION AND ENTERTAINMENT

FOR CONDUCTING SEMINARS, CLASSES, AND WORKSHOPS RELATING TO EXERCISE, EXERCISE EQUIPMENT, FITNESS, AND HEALTH (U.S. CLS. 100, 101 AND 107).
FIRST USE 3-0-1999; IN COMMERCE 3-0-1999.

CLASS 16—PAPER GOODS AND PRINTED MATTER

FOR PERIODICALS AND PUBLICATIONS, NAMELY, BOOKS, MAGAZINES, NEWSLETTERS, PAMPHLETS, AND BOOKS FEATURING THE FIELD OF MUSIC; PRINT MUSIC AND CATALOGS IN THE AREA OF MUSIC (U.S. CLS. 2, 5, 22, 23, 29, 37, 38 AND 50).
FIRST USE 4-10-1978; IN COMMERCE 9-0-1995.

2,534,560. DFG FOODS, L.L.C., OKLAHOMA CITY, OK. SN 75-701,056. PUB. 6-27-2000, FILED 5-7-1999.

FOR BLACK TIE. BLUE JEANS. OR IN BETWEEN.

CLASS 29—MEATS AND PROCESSED FOODS

FOR PREPARED, FROZEN AND NON-FROZEN PACKAGED APPETIZERS, HORS D'OEUVRES, SIDE DISHES AND DINNER ENTREES, ALL CONSISTING PRIMARILY OF MEAT, FISH, POULTRY, AND/OR FRUITS (U.S. CL. 46).
FIRST USE 1-19-1999; IN COMMERCE 1-19-1999.

CLASS 30—STAPLE FOODS

FOR PREPARED, FROZEN AND NON-FROZEN PACKAGED APPETIZERS, HORS D'OEUVRES, SIDE DISHES AND DINNER ENTREES, ALL CONSISTING PRIMARILY OF BREAD PRODUCTS, STUFFING, RICE, PASTRIES, DOUGHS, SAUCES AND/OR SPICES (U.S. CL. 46).
FIRST USE 1-19-1999; IN COMMERCE 1-19-1999.

2,534,561. DFG FOODS, L.L.C., OKLAHOMA CITY, OK. SN 75-701,057. PUB. 6-13-2000, FILED 5-7-1999.

WHEN YOUR REPUTATION DEPENDS ON IT

CLASS 29—MEATS AND PROCESSED FOODS

FOR PREPARED, FROZEN AND NON-FROZEN PACKAGED APPETIZERS, HORS D'OEUVRES, SIDE DISHES AND DINNER ENTREES, ALL CONSISTING PRIMARILY OF MEAT, FISH, POULTRY AND/OR FRUITS (U.S. CL. 46).
FIRST USE 9-22-1999; IN COMMERCE 9-22-1999.

CLASS 30—STAPLE FOODS

FOR PREPARED, FROZEN AND NON-FROZEN PACKAGED APPETIZERS, HORS D'OEUVRES, SIDE DISHES AND DINNER ENTREES, ALL CONSISTING PRIMARILY OF BREAD PRODUCTS, STUFFING, RICE, PASTRIES, DOUGHS, SAUCES AND/OR SPICES (U.S. CL. 46).
FIRST USE 9-22-1999; IN COMMERCE 9-22-1999.

2,534,566. HEROIC BARD, INC., THE, CHICAGO, IL. SN 75-707,978. PUB. 8-22-2000, FILED 10-30-1999.

HEROIC BARD

NO CLAIM IS MADE TO THE EXCLUSIVE RIGHT TO USE "BARD", APART FROM THE MARK AS SHOWN.

CLASS 9—ELECTRICAL AND SCIENTIFIC APPARATUS

FOR PRE-RECORDED COMPACT DISCS AND AUDIO TAPES FEATURING ENTERTAINMENT PRODUCTIONS, NAMELY, ORAL RECITATIONS ACCOMPANIED BY MUSIC (U.S. CLS. 21, 23, 26, 36 AND 38).
FIRST USE 8-31-1999; IN COMMERCE 1-5-2000.

CLASS 41—EDUCATION AND ENTERTAINMENT

FOR ENTERTAINMENT SERVICES IN THE NATURE OF LIVE ORAL RECITATIONS ACCOMPANIED BY MUSIC (U.S. CLS. 100, 101 AND 107).
FIRST USE 8-31-1999; IN COMMERCE 10-24-1999.

2,534,571. EPISCOPAL MINISTRIES TO THE AGING, INC., SYKESVILLE, MD. SN 75-711,840. PUB. 7-4-2000, FILED 5-21-1999.

EMA

CLASS 35—ADVERTISING AND BUSINESS

FOR SERVICES TO AGING PERSONS, NAMELY, OPERATION OF RETIREMENT COMMUNITIES, ASSISTED LIVING FACILITIES, NURSING FACILITIES, LONG-TERM CARE FACILITIES, AND SENIOR HOUSING; MANAGEMENT OF LONG-TERM CARE FACILITIES AND NURSING HOMES FOR OTHERS (U.S. CLS. 100, 101 AND 102).
FIRST USE 0-0-1999; IN COMMERCE 0-0-1999.

CLASS 42—SCIENTIFIC, COMPUTER AND LEGAL SERVICES

FOR HEALTHCARE SERVICES, NAMELY PROVIDING ASSISTED LIVING AND NURSING CARE SERVICES, AND RESEARCH IN THE FIELD OF ASSISTED LIVING, SENIOR HOUSING AND LONG-TERM CARE (U.S. CLS. 100 AND 101).
FIRST USE 0-0-1999; IN COMMERCE 0-0-1999.

2,534,572. UPPER ROOM, THE, NASHVILLE, TN. SN 75-714,646. PUB. 12-5-2000, FILED 5-27-1999.



OWNER OF U.S. REG. NO. 1,236,764.

CLASS 9—ELECTRICAL AND SCIENTIFIC APPARATUS

FOR PRE-RECORDED AUDIO AND VIDEO CASSETTES FEATURING RELIGIOUS, SOCIAL AND EDUCATIONAL TOPICS (U.S. CLS. 21, 23, 26, 36 AND 38).
FIRST USE 1-2-1999; IN COMMERCE 1-2-1999.

CLASS 16—PAPER GOODS AND PRINTED MATTER

FOR PRINTED MATERIALS AND PUBLICATIONS, NAMELY BOOKS; NEWSLETTERS; PAMPHLETS; MUSIC BOOKS; STATIONERY; BINDERS; STICKERS; DECALS; NOTE PADS; NOTE CARDS; AND TEACHING MANUALS AND MAIL ORDER CATALOGUES IN THE FIELDS OF RELIGIOUS, SOCIAL AND EDUCATIONAL TOPIC (U.S. CLS. 2, 5, 22, 23, 29, 37, 38 AND 50).
FIRST USE 1-2-1999; IN COMMERCE 1-2-1999.

CLASS 41—EDUCATION AND ENTERTAINMENT

FOR EDUCATIONAL SERVICES, NAMELY CONDUCTING SEMINARS, WORKSHOPS AND COURSES IN THE FIELD OF RELIGIOUS, SOCIAL AND EDUCATIONAL TOPICS (U.S. CLS. 100, 101 AND 107).

FIRST USE 1-2-1999; IN COMMERCE 1-2-1999.

CLASS 42—SCIENTIFIC, COMPUTER AND LEGAL SERVICES

FOR INFORMATION SERVICES, NAMELY, PROVIDING AND DISSEMINATING INFORMATION FEATURING RELIGION, SOCIAL, AND EDUCATIONAL TOPICS VIA A GLOBAL COMPUTER NETWORK (U.S. CLS. 100 AND 101).

FIRST USE 1-2-1999; IN COMMERCE 1-2-1999.

2,534,574. POWERS, MARGARET FISHBACK, COQUITLAM, BC, CANADA. SN 75-717,204. PUB. 8-1-2000, FILED 5-28-1999.

FOOTPRINTS**CLASS 14—JEWELRY**

FOR JEWELRY (U.S. CLS. 2, 27, 28 AND 50).
FIRST USE 4-5-1995; IN COMMERCE 12-1-1995.

CLASS 21—HOUSEWARES AND GLASS

FOR CERAMIC SCULPTURES AND DECORATIVE PLATES (U.S. CLS. 2, 13, 23, 29, 30, 33, 40 AND 50).
FIRST USE 5-12-1994; IN COMMERCE 9-24-1994.

2,534,573. HBH LIMITED PARTNERSHIP, CINCINNATI, OH. SN 75-714,684. PUB. 10-31-2000, FILED 5-27-1999.

THE HONEYBAKED HAM CO. AND CAFÉ

OWNER OF U.S. REG. NOS. 1,384,504, 2,126,500, AND OTHERS.

NO CLAIM IS MADE TO THE EXCLUSIVE RIGHT TO USE "HAM CO" AND "CAFÉ", APART FROM THE MARK AS SHOWN.

THE MARK IS PRESENTED WITHOUT ANY CLAIM AS TO SPECIAL FORM.

SEC. 2(F) AS TO THE WORDING "THE HONEYBAKED HAM CO."

CLASS 35—ADVERTISING AND BUSINESS

FOR RETAIL STORE SERVICES IN THE FIELD OF PROCESSED MEATS, NAMELY, POULTRY, NAMELY, CHICKEN AND TURKEY; BEEF, NAMELY, BEEF RIBS AND ROAST; PORK, NAMELY HAM, BACON, PORK LOINS, PORK RIBS AND CANADIAN BACON; VEGETABLE SALADS, NAMELY, POTATO SALAD, THREE-BEAN SALAD AND COLE SLAW; BAKED BEANS; SOUP MIXES; CONFECTIONERIES, NAMELY, CHEESECAKES AND FRUIT AND NUT PIES; CONDIMENTS, NAMELY HORSERADISH SAUCE, RELISHES AND MUSTARDS; SAUCES, NAMELY, BARBECUE SAUCE AND CHILI SAUCE; MACARONI SALAD; COFFEE AND TEA; AND PREPARED FOOD TRAYS COMPRISED OF PORK, POULTRY, BEEF AND VEGETABLE SANDWICHES; SLICED PORK, POULTRY AND BEEF; MEAT, VEGETABLE, FRUIT AND PASTA SALADS; CHEESES; FRESH VEGETABLES; FRESH FRUITS; BAKED BEANS; PICKLES; OLIVES; RELISHES; BREADS, COOKIES, CAKES AND PIES; AND CONDIMENTS (U.S. CLS. 100, 101 AND 102).

FIRST USE 10-0-1998; IN COMMERCE 1-23-2001.

CLASS 42—SCIENTIFIC, COMPUTER AND LEGAL SERVICES

FOR RESTAURANT SERVICES (U.S. CLS. 100 AND 101).

FIRST USE 10-0-1998; IN COMMERCE 1-23-2001.

2,534,587. TERRABROOK VISTA LAKES, L.P., DALLAS, TX. SN 75-732,814. PUB. 10-24-2000, FILED 6-17-1999.

**CLASS 36—INSURANCE AND FINANCIAL**

FOR REAL ESTATE SERVICES, NAMELY, REAL ESTATE AGENCIES, REAL ESTATE BROKERAGE, REAL ESTATE MANAGEMENT, REAL ESTATE BROKERAGE SERVICES CONCERNING THE PURCHASE AND SALE, LEASING, OF REAL PROPERTY, REAL ESTATE LISTING (U.S. CLS. 100, 101 AND 102).

FIRST USE 3-0-2000; IN COMMERCE 3-0-2000.

CLASS 37—CONSTRUCTION AND REPAIR

FOR LAND DEVELOPMENT, NAMELY, PLANNING AND LAYING OUT OF PLANNED COMMUNITIES, AS WELL AS RESIDENTIAL AND COMMERCIAL COMMUNITIES; REAL ESTATE SITE SELECTION; CONSTRUCTION SUPERVISION; CONSTRUCTION PLANNING; AND PROVIDING INFORMATION ABOUT PLANNED COMMUNITIES AND THE SALE AND RENTAL OF REAL ESTATE BY MEANS OF A MULTI-USER GLOBAL COMPUTER NETWORK (U.S. CLS. 100, 103 AND 106).

FIRST USE 3-0-2000; IN COMMERCE 3-0-2000.

2,534,613. BASEBALL ACQUISITION CORPORATION, PORTLAND, OR. SN 75-753,783. PUB. 1-18-2000, FILED 7-15-1999.

RINGOR**CLASS 18—LEATHER GOODS**

FOR ATHLETIC BAGS, DUFFEL BAGS, GYM BAGS, SPORTS EQUIPMENT BAGS, AND FANNY PACKS (U.S. CLS. 1, 2, 3, 22 AND 41).

FIRST USE 0-0-1985; IN COMMERCE 0-0-1985.

CLASS 21—HOUSEWARES AND GLASS

FOR WATER BOTTLES SOLD EMPTY (U.S. CLS. 2, 13, 23, 29, 30, 33, 40 AND 50).
FIRST USE 0-0-1987; IN COMMERCE 0-0-1987.

CLASS 25—CLOTHING

FOR ATHLETIC UNIFORMS, CAPS, HATS, UNDERGARMENTS, SOCKS, SHIRTS, PANTS, PADDED SLIDING PANTS WARM-UP JACKETS, WRIST BANDS, HEAD BANDS AND ATHLETIC FOOTWEAR (U.S. CLS. 22 AND 39).

FIRST USE 0-0-1984; IN COMMERCE 0-0-1984.

CLASS 28—TOYS AND SPORTING GOODS

FOR ELBOW, HAND AND SHOULDER PADS FOR ATHLETIC USE; BASEBALLS, SOFTBALLS, BASEBALL GLOVES, BATTING GLOVES, AND CATCHERS' MASKS (U.S. CLS. 22, 23, 38 AND 50).

FIRST USE 0-0-1994; IN COMMERCE 0-0-1994.

2,534,615. HURON CAPITAL PARTNERS LLC, DETROIT, MI. SN 75-754,362. PUB. 10-31-2000, FILED 7-19-1999.

HURON CAPITAL PARTNERS

NO CLAIM IS MADE TO THE EXCLUSIVE RIGHT TO USE "CAPITAL PARTNERS", APART FROM THE MARK AS SHOWN.

CLASS 35—ADVERTISING AND BUSINESS

FOR BUSINESS-EVALUATION SERVICES; BUSINESS-ACQUISITION CONSULTING SERVICES; AND BUSINESS-MANAGEMENT CONSULTING SERVICES (U.S. CLS. 100, 101 AND 102).

FIRST USE 8-1-1999; IN COMMERCE 8-1-1999.

CLASS 36—INSURANCE AND FINANCIAL

FOR INVESTMENT SERVICES, NAMELY INVESTING THE FUNDS OF OTHERS THROUGH SYNDICATED ENTITIES ORGANIZED TO PURCHASE EQUITY INTEREST IN BUSINESSES, AND MANAGING SYNDICATED INVESTMENT FUNDS (U.S. CLS. 100, 101 AND 102).

FIRST USE 8-1-1999; IN COMMERCE 8-1-1999.

2,534,621. DEPAUL UNIVERSITY, CHICAGO, IL. SN 75-769,216. PUB. 10-24-2000, FILED 8-6-1999.



OWNER OF U.S. REG. NOS. 1,156,721, 1,789,394, AND OTHERS.

CLASS 16—PAPER GOODS AND PRINTED MATTER

FOR STATIONERY ITEMS – NAMELY, PENS, NOTEBOOKS, RING BINDERS, AND DECALS (U.S. CLS. 2, 5, 22, 23, 29, 37, 38 AND 50).

FIRST USE 10-0-1999; IN COMMERCE 10-0-1999.

CLASS 24—FABRICS

FOR TOWELS (U.S. CLS. 42 AND 50).

FIRST USE 10-0-1999; IN COMMERCE 10-0-1999.

CLASS 25—CLOTHING

FOR CLOTHING ITEMS – NAMELY, T-SHIRTS, JACKETS, SWEATERS, HATS, GAME JERSEYS, SWEATSUITS, SHORTS, SHIRTS, SWEATPANTS AND SWEAT SHIRTS (U.S. CLS. 22 AND 39).

FIRST USE 10-0-1999; IN COMMERCE 10-0-1999.

CLASS 41—EDUCATION AND ENTERTAINMENT

FOR EDUCATIONAL SERVICES IN THE NATURE OF COURSES, SEMINARS, WORKSHOPS, PROGRAMS AND CONFERENCES AT THE UNIVERSITY LEVEL; ENTERTAINMENT SERVICES, NAMELY, CONDUCTING BASKETBALL, SOCCER, SOFTBALL AND VOLLEYBALL GAMES, AND TENNIS, TRACK AND FIELD, CROSS COUNTRY AND GOLF COMPETITIONS (U.S. CLS. 100, 101 AND 107).

FIRST USE 11-0-1999; IN COMMERCE 11-0-1999.

2,534,624. CEPHEID, SUNNYVALE, CA. SN 75-771,218. PUB. 4-10-2001, FILED 8-5-1999.

GENEXPERT

CLASS 9—ELECTRICAL AND SCIENTIFIC APPARATUS

FOR LABORATORY EQUIPMENT, NAMELY, A DEVICE FOR BIOANALYSIS INCORPORATING A CARTRIDGE FOR SAMPLE PREPARATION, NUCLEIC ACID PURIFICATION, NUCLEIC ACID AMPLIFICATION, AND OPTICAL DETECTION (U.S. CLS. 21, 23, 26, 36 AND 38).

FIRST USE 4-27-2001; IN COMMERCE 4-27-2001.

CLASS 10—MEDICAL APPARATUS

FOR MEDICAL EQUIPMENT, NAMELY, A DEVICE FOR BIOANALYSIS INCORPORATING A CARTRIDGE FOR SAMPLE PREPARATION, NUCLEIC ACID PURIFICATION, NUCLEIC ACID AMPLIFICATION, AND OPTICAL DETECTION (U.S. CLS. 26, 39 AND 44).

FIRST USE 4-27-2001; IN COMMERCE 4-27-2001.

2,534,627. CITY CANYONS PRODUCING & PUBLISHING CO., NEW YORK, NY. SN 75-773,103. PUB. 10-10-2000, FILED 8-11-1999.

CITY CANYONS

CLASS 9—ELECTRICAL AND SCIENTIFIC APPARATUS

FOR PHONOGRAPH RECORDS FEATURING MUSIC, COMPACT DISCS FEATURING MUSIC, BLANK MAGNETIC COMPUTER TAPES, DOWNLOADABLE MUSIC SOUND RECORDINGS (U.S. CLS. 21, 23, 26, 36 AND 38). FIRST USE 1-1-2000; IN COMMERCE 1-1-2000.

CLASS 25—CLOTHING

FOR CLOTHING, NAMELY T-SHIRTS, SHIRTS, SWEATSHIRTS, SHORTS, CAPS, HATS, TIES, SCARVES, JACKETS, WIND-RESISTANT JACKETS, RAIN RESISTANT JACKETS (U.S. CLS. 22 AND 39). FIRST USE 1-1-2000; IN COMMERCE 1-1-2000.

2,534,637. TRUE NORTH COMMUNICATIONS INC., CHICAGO, IL. SN 75-789,694. PUB. 6-6-2000, FILED 9-1-1999.



CLASS 35—ADVERTISING AND BUSINESS

FOR BUSINESS CONSULTATION IN THE FIELDS OF WEB SITE DESIGN, INTERACTIVE MEDIA, AND ON-LINE ADVERTISING; DISSEMINATION OF ADVERTISING FOR OTHERS VIA ON-LINE ELECTRONIC COMMUNICATIONS NETWORKS (U.S. CLS. 100, 101 AND 102). FIRST USE 1-3-2000; IN COMMERCE 1-3-2000.

CLASS 42—SCIENTIFIC, COMPUTER AND LEGAL SERVICES

FOR HOSTING THE WEB SITES OF OTHERS ON A COMPUTER SERVER FOR A GLOBAL COMPUTER NETWORK; DEVELOPING AND DESIGNING FOR OTHERS WEB SITES ON GLOBAL COMPUTER NETWORKS (U.S. CLS. 100 AND 101). FIRST USE 1-3-2000; IN COMMERCE 1-3-2000.

2,534,647. RADIOCENTRAL, INC., SAN FRANCISCO, CA. SN 75-799,591. PUB. 12-12-2000, FILED 9-15-1999.

RADIOCENTRAL

CLASS 35—ADVERTISING AND BUSINESS

FOR PREPARING ADVERTISING FOR OTHERS AND DISSEMINATING ADVERTISING FOR OTHERS THROUGH RADIO AND THROUGH RADIO-STYLE WEBCASTS ACCESSIBLE VIA AN ON-LINE ELECTRONIC COMMUNICATIONS NETWORK (U.S. CLS. 100, 101 AND 102). FIRST USE 11-30-2000; IN COMMERCE 11-30-2000.

CLASS 38—COMMUNICATION

FOR RADIO BROADCASTING FOR OTHERS; BROADCASTING PROGRAMS VIA A GLOBAL COMPUTER INFORMATION NETWORK (U.S. CLS. 100, 101 AND 104). FIRST USE 10-1-2000; IN COMMERCE 10-1-2000.

CLASS 41—EDUCATION AND ENTERTAINMENT

FOR PRODUCTION AND DISTRIBUTION OF RADIO PROGRAMS FOR OTHERS; PRODUCTION AND DISTRIBUTION OF RADIO PROGRAMS ACCESSIBLE FROM THE GLOBAL COMPUTER INFORMATION NETWORK FOR OTHERS (U.S. CLS. 100, 101 AND 107). FIRST USE 10-1-2000; IN COMMERCE 10-1-2000.

2,534,660. ELECTRONIC DATA SYSTEMS CORPORATION, PLANO, TX. SN 75-807,749. PUB. 11-28-2000, FILED 9-24-1999.



OWNER OF U.S. REG. NOS. 952,895, 1,696,716, AND 2,047,497.

CLASS 9—ELECTRICAL AND SCIENTIFIC APPARATUS

FOR DATA PROCESSING APPARATUS, NAMELY, DATA PROCESSORS, LOCAL AREA NETWORKS, COMPUTERS, COMPUTER NETWORK AND SATELLITES; COMPUTER SOFTWARE FOR USE IN DATABASE MANAGEMENT FOR OTHERS, FOR USE AS A SPREADSHEET, FOR WORD PROCESSING, FOR MANAGEMENT OF COMPUTERS AND COMPUTER NETWORKS FOR OTHERS, FOR USE IN ELECTRONIC COMMERCE FOR OTHERS, FOR DATA PROCESSING, FOR INFORMATION HANDLING FOR OTHERS, FOR INFORMATION MANAGEMENT FOR OTHERS, FOR ELECTRONIC TRANSMISSION AND RECEPTION OF MAIL, DOCUMENTS, NEWS, VIDEO, VOICE, AUDIO, FACSIMILE AND OTHER DATA, DOCUMENTS AND INFORMATION VIA COMPUTER, FOR ELECTRONIC DATA INTERCHANGE NETWORK SERVICES, FOR ANALYZING DATA, FOR CREATING REPORTS, FOR CREATING WEB PAGES AND MANAGING WEB PAGES FOR OTHERS, AND FOR USE IN MANAGING AND SUPPORTING INFORMATION TECHNOLOGY FOR OTHERS (U.S. CLS. 21, 23, 26, 36 AND 38). FIRST USE 1-30-2000; IN COMMERCE 1-30-2000.

CLASS 16—PAPER GOODS AND PRINTED MATTER

FOR PRINTED MATTER, NAMELY BOOKS, BOOKLETS, NEWSLETTERS, CATALOGS AND BROCHURES IN THE FIELDS OF INFORMATION MANAGEMENT AND INFORMATION TECHNOLOGY; INSTRUCTIONAL MATERIALS, MANUALS, USER GUIDES IN THE FIELDS OF INFORMATION MANAGEMENT AND INFORMATION TECHNOLOGY; POSTCARDS; POSTERS; DOCUMENTATION OFFERED IN CONNECTION WITH COMPUTER SOFTWARE, NAMELY, MANUALS AND COLLATERAL (U.S. CLS. 2, 5, 22, 23, 29, 37, 38 AND 50). FIRST USE 1-30-2000; IN COMMERCE 1-30-2000.

CLASS 35—ADVERTISING AND BUSINESS

FOR BUSINESS CONSULTING SERVICES AND STRATEGIC PLANNING OF INFORMATION MANAGEMENT AND INFORMATION TECHNOLOGY; BUSINESS CONSULTING SERVICES RELATING TO ELECTRONIC COMMERCE AND ELECTRONIC BUSINESS; DATA PROCESSING BY MEANS OF A COMPUTER (U.S. CLS. 100, 101 AND 102).

FIRST USE 1-30-2000; IN COMMERCE 1-30-2000.

CLASS 38—COMMUNICATION

FOR ELECTRONIC COMMERCE SERVICES, NAMELY, ELECTRONIC TRANSMISSION AND RECEPTION OF DATA DOCUMENTS AND INFORMATION VIA COMPUTER; ELECTRONIC DATA INTERCHANGE NETWORK SERVICES (U.S. CLS. 100, 101 AND 104).

FIRST USE 1-30-2000; IN COMMERCE 1-30-2000.

CLASS 41—EDUCATION AND ENTERTAINMENT

FOR EDUCATIONAL SERVICES, NAMELY, CONDUCTING TRAINING AND INSTRUCTIONAL COURSES RELATED TO COMPUTERS (U.S. CLS. 100, 101 AND 107).

FIRST USE 1-30-2000; IN COMMERCE 1-30-2000.

CLASS 42—SCIENTIFIC, COMPUTER AND LEGAL SERVICES

FOR COMPUTER SERVICES, NAMELY, COMPUTER HARDWARE AND SOFTWARE INTEGRATION; COMPUTER SYSTEM AND NETWORK MANAGEMENT; DATABASE DEVELOPMENT SERVICES; COMPUTER PROGRAMMING; AND DEVELOPING, HOSTING AND LINKING OF WEB SITES FOR OTHERS ON A GLOBAL INFORMATION NETWORK (U.S. CLS. 100 AND 101).

FIRST USE 1-30-2000; IN COMMERCE 1-30-2000.

2,534,662. RODALE INC., EMMAUS, PA. SN 75-813,527. PUB. 2-20-2001, FILED 10-4-1999.

BIKEZONE.COM**CLASS 35—ADVERTISING AND BUSINESS**

FOR ADVERTISING SERVICES, NAMELY, PROVIDING ADVERTISING SPACE VIA AN INTERACTIVE WEB SITE ON A MULTI-USER GLOBAL COMPUTER INFORMATION NETWORK (U.S. CLS. 100, 101 AND 102).

FIRST USE 1-1-2000; IN COMMERCE 1-1-2000.

CLASS 41—EDUCATION AND ENTERTAINMENT

FOR INSTRUCTIONAL SERVICES FEATURING BICYCLING; BICYCLE RACE AND BICYCLE EVENT INFORMATION SERVICES (U.S. CLS. 100, 101 AND 107).

FIRST USE 1-1-2000; IN COMMERCE 1-1-2000.

CLASS 42—SCIENTIFIC, COMPUTER AND LEGAL SERVICES

FOR COMPUTER SERVICES, NAMELY, PROVIDING ELECTRONIC MAGAZINES VIA AN INTERACTIVE WEB SITE ON A MULTI-USER GLOBAL COMPUTER INFORMATION NETWORK IN THE FIELDS OF HEALTH, FITNESS, DIET, EXERCISE AND LIFESTYLE; INFORMATION SERVICES IN THE FIELDS OF HEALTH, FITNESS, DIET, EXERCISE AND LIFESTYLE PROVIDED ELECTRONICALLY VIA AN INTERACTIVE WEB SITE ON A MULTI USER GLOBAL COMPUTER INFORMATION NETWORK (U.S. CLS. 100 AND 101).

FIRST USE 1-1-2000; IN COMMERCE 1-1-2000.

2,534,667. HICKS & RAGLAND ENGINEERING CO., INC., LUBBOCK, TX. SN 75-821,112. PUB. 5-30-2000, FILED 10-12-1999.



THE MARK CONSISTS OF THE TERMS "CHR SOLUTIONS" AND "SUCCESS, SIMPLIFIED" AND THREE OVERLAPPING, INCOMPLETE CIRCLES.

CLASS 35—ADVERTISING AND BUSINESS

FOR BUSINESS CONSULTING SERVICES IN THE FIELD OF TELECOMMUNICATIONS (U.S. CLS. 100, 101 AND 102).

FIRST USE 3-0-1999; IN COMMERCE 3-0-1999.

CLASS 42—SCIENTIFIC, COMPUTER AND LEGAL SERVICES

FOR TELECOMMUNICATIONS ENGINEERING SERVICES (U.S. CLS. 100 AND 101).

FIRST USE 3-0-1999; IN COMMERCE 3-0-1999.

2,534,669. PEROT SYSTEMS CORPORATION, DALLAS, TX. SN 75-822,578. PUB. 12-5-2000, FILED 10-13-1999.

BILLINGZONE**CLASS 35—ADVERTISING AND BUSINESS**

FOR BUSINESS CONSULTING SERVICES; COMPUTER SERVICES, NAMELY, PROVIDING ON-LINE CORPORATE PUBLICATIONS, NAMELY, NEWSLETTERS, IN THE FIELD OF BUSINESS CONSULTING AND BUSINESS MANAGEMENT; AUTOMATED BILL PRESENTMENT SERVICES TO AID BUSINESSES AND USERS IN THE CONDUCT OF COMMERCIAL TRANSACTIONS OVER A GLOBAL, WIDE AREA OR LOCAL NETWORK; CONSULTATION REGARDING COMPUTERIZED BILL PRESENTMENT (U.S. CLS. 100, 101 AND 102).

FIRST USE 9-26-2000; IN COMMERCE 9-26-2000.

CLASS 36—INSURANCE AND FINANCIAL

FOR AUTOMATED PAYMENT SERVICES TO AID BUSINESSES AND USERS IN THE CONDUCT OF COMMERCIAL TRANSACTIONS OVER A GLOBAL, WIDE AREA OR LOCAL NETWORK; CONSULTATION REGARDING COMPUTERIZED BILL PAYMENT (U.S. CLS. 100, 101 AND 102).

FIRST USE 9-26-2000; IN COMMERCE 9-26-2000.

CLASS 42—SCIENTIFIC, COMPUTER AND LEGAL SERVICES

FOR COMPUTER SERVICES, NAMELY, DESIGN, DEVELOPMENT, INTEGRATION AND IMPLEMENTATION OF COMPUTERS AND COMPUTER NETWORKS; COMPUTER SOFTWARE DEVELOPMENT AND IMPLEMENTATION FOR OTHERS; PROVIDING ON-LINE CORPORATE PUBLICATIONS, NAMELY, NEWSLETTERS IN THE FIELD OF ELECTRONIC COMMERCE, COMPUTERS AND RELATED INFORMATION TECHNOLOGY (U.S. CLS. 100 AND 101).

FIRST USE 9-26-2000; IN COMMERCE 9-26-2000.

2,534,675. SUMINOE TEXTILE CO., LTD., OSAKA, JAPAN.
SN 75-827,125. PUB. 1-23-2001, FILED 10-19-1999.

2,534,697. PURSELL TECHNOLOGIES, INC., SYLACAUGA,
AL. SN 75-840,881. PUB. 6-13-2000, FILED 11-4-1999.

TRIPLE FRESH

CLASS 24—FABRICS

FOR CURTAINS OF TEXTILE, CURTAIN CLOTH,
DRAPERY, DRAPERY CLOTH AND LACE CURTAIN
(U.S. CLS. 42 AND 50).

FIRST USE 8-0-1998; IN COMMERCE 6-0-2000.

CLASS 27—FLOOR COVERINGS

FOR FLOOR COVERINGS, NAMELY, DOOR MATS,
CARPETS, TILE CARPET, MATS; WALLPAPER (U.S.
CLS. 19, 20, 37, 42 AND 50).

FIRST USE 8-0-1998; IN COMMERCE 6-0-2000.

2,534,676. VISIONUNLIMITED.NET, INC., GEORGETOWN,
OH. SN 75-827,570. PUB. 5-16-2000, FILED 10-20-1999.

VISION UNLIMITED

CLASS 36—INSURANCE AND FINANCIAL

FOR CHARITABLE FUND RAISING (U.S. CLS. 100,
101 AND 102).

FIRST USE 3-24-2000; IN COMMERCE 3-24-2000.

CLASS 38—COMMUNICATION

FOR PROVIDING TELECOMMUNICATION CONNEC-
TION TO GLOBAL COMPUTER NETWORK (U.S. CLS.
100, 101 AND 104).

FIRST USE 3-24-2000; IN COMMERCE 3-24-2000.

2,534,691. LEISURETECH ELECTRONICS PTY LTD., NEW
SOUTH WALES, 2015, AUSTRIA. SN 75-837,847. PUB. 11-
28-2000, FILED 11-2-1999.

A-BUS

CLASS 9—ELECTRICAL AND SCIENTIFIC APPARATUS

FOR MULTI-ROOM AUDIO SYSTEM COMPRISED OF
APPARATUS FOR RECORDING, TRANSMITTING AND
REPRODUCING SOUND, NAMELY, WIRES, CABLES,
AND POWER MODULES (U.S. CLS. 21, 23, 26, 36 AND
38).

FIRST USE 9-21-2000; IN COMMERCE 9-21-2000.

CLASS 37—CONSTRUCTION AND REPAIR

FOR INSTALLATION, MAINTENANCE AND REPAIR
OF MULTI-ROOM AUDIO SYSTEMS (U.S. CLS. 100, 103
AND 106).

FIRST USE 9-21-2000; IN COMMERCE 9-21-2000.



OWNER OF U.S. REG. NO. 2,195,746.

CLASS 1—CHEMICALS

FOR FERTILIZERS AND COATED FERTILIZERS FOR
DOMESTIC, AGRICULTURAL, COMMERCIAL AND
PROFESSIONAL USE; CHEMICAL INGREDIENTS FOR
USE IN THE MANUFACTURE OF FERTILIZERS (U.S.
CLS. 1, 5, 6, 10, 26 AND 46).

FIRST USE 7-0-1997; IN COMMERCE 7-0-1997.

CLASS 40—MATERIAL TREATMENT

FOR CUSTOM MANUFACTURE OF FERTILIZER
AND FERTILIZER INGREDIENTS FOR OTHERS (U.S.
CLS. 100, 103 AND 106).

FIRST USE 7-0-1997; IN COMMERCE 7-0-1997.

2,534,701. ASSOCIATED WHOLESALE GROCERS, INC.,
KANSAS CITY, KS. SN 75-844,267. PUB. 7-18-2000, FILED
11-9-1999.

PICK FRESH

CLASS 29—MEATS AND PROCESSED FOODS

FOR PROCESSED FOODS, BUTTER BEANS, LIMA
BEANS, GREEN BEANS, SHELLED BEANS, KIDNEY
BEANS, BLACK BEANS, CHILI BEANS, PINTO BEANS,
PORK AND BEANS, PEAS, HOMINY, CANNED CORN,
MIXED VEGETABLES, STIR FRY VEGETABLES,
CANNED SPINACH, BREADED OKRA, CANNED
MUSHROOMS, TOMATO PASTE, CANNED TOMATOES,
SLICED BEETS, SLICED CARROTS, CANNED SAUERK-
RAUT, CANNED MUSTARD GREENS, CANNED TURN-
IP GREENS, CANNED COLLARD GREENS, CANNED
POTATOES, CANNED ASPARAGUS; AND, FROZEN
VEGETABLES, NAMELY, SPINACH, BROCCOLI AND
CORN (U.S. CL. 46).

FIRST USE 1-31-2001; IN COMMERCE 1-31-2001.

CLASS 30—STAPLE FOODS

FOR TOMATO SAUCE (U.S. CL. 46).

FIRST USE 1-31-2001; IN COMMERCE 1-31-2001.

2,534,715. SEALED AIR CORPORATION (US), SADDLE
BROOK, NJ. SN 75-864,258. PUB. 11-28-2000, FILED 12-6-
1999.

SEALED AIR

OWNER OF U.S. REG. NOS. 925,912, 1,113,176, AND
1,580,890.

CLASS 10—MEDICAL APPARATUS

FOR POLYMER FILM BAGS, POUCHES, TUBINGS AND CONNECTORS FOR DISPENSING MEDICAL SOLUTIONS (U.S. CLS. 26, 39 AND 44).
FIRST USE 6-1-1998; IN COMMERCE 6-1-1998.

2,534,783. FOUNDSTONE, INC., IRVINE, CA, BY ASSIGNMENT RAMPART SECURITY GROUP, LLC, PARSIPPANY, NJ. SN 75-932,289. PUB. 10-17-2000, FILED 3-1-2000.

FOUNDSTONE

CLASS 17—RUBBER GOODS

FOR FILMS FOR MANUFACTURING BAGS, POUCHES AND OVERWRAPPING FOR BAGS AND POUCHES USED FOR DISPENSING MEDICAL SOLUTIONS (U.S. CLS. 1, 5, 12, 13, 35 AND 50).
FIRST USE 6-1-1998; IN COMMERCE 6-1-1998.

CLASS 9—ELECTRICAL AND SCIENTIFIC APPARATUS

FOR COMPUTER SOFTWARE FOR MONITORING, EVALUATING, RECORDING AND TRAINING IN THE FIELD OF COMPUTER NETWORK SECURITY (U.S. CLS. 21, 23, 26, 36 AND 38).
FIRST USE 8-9-2000; IN COMMERCE 8-9-2000.

2,534,744. NOVASYS HEALTH NETWORK, LLC, LITTLE ROCK, AR. SN 75-893,206. PUB. 9-5-2000, FILED 1-7-2000.

CLASS 41—EDUCATION AND ENTERTAINMENT

FOR EDUCATIONAL AND TRAINING SERVICES, NAMELY, CONDUCTING ON-SITE TRAINING CLASSES RELATING TO COMPUTER SECURITY SYSTEMS AND POLICIES, AND EVALUATING AND SOLVING COMPUTER SECURITY PROBLEMS (U.S. CLS. 100, 101 AND 107).
FIRST USE 3-6-2000; IN COMMERCE 3-6-2000.



OWNER OF U.S. REG. NO. 2,152,138.
NO CLAIM IS MADE TO THE EXCLUSIVE RIGHT TO USE "PREFERRED", APART FROM THE MARK AS SHOWN.

CLASS 42—SCIENTIFIC, COMPUTER AND LEGAL SERVICES

FOR COMPUTER CONSULTING SERVICES IN THE FIELDS OF COMPUTER SECURITY, DETECTION OF COMPUTER TAMPERING, EVALUATION, ASSESSMENT AND REPORTING OF COMPUTER SECURITY SYSTEMS; DEVELOPMENT AND IMPLEMENTATION OF COMPUTER SECURITY SYSTEMS AND POLICIES; CUSTOM DESIGN OF COMPUTER NETWORK SECURITY SYSTEMS AND NETWORKS FOR OTHERS; COMPUTER FORENSICS INVESTIGATIONS (U.S. CLS. 100 AND 101).
FIRST USE 3-6-2000; IN COMMERCE 3-6-2000.

CLASS 35—ADVERTISING AND BUSINESS

FOR HEALTH CARE COST CONTAINMENT SERVICES (U.S. CLS. 100, 101 AND 102).
FIRST USE 1-31-2000; IN COMMERCE 1-31-2000.

CLASS 36—INSURANCE AND FINANCIAL

FOR ORGANIZING AND ADMINISTERING PREFERRED PROVIDER HEALTHCARE PLANS (U.S. CLS. 100, 101 AND 102).
FIRST USE 1-31-2000; IN COMMERCE 1-31-2000.

2,534,791. NEWPORT NEWS SHIPBUILDING AND DRY DOCK COMPANY, NEWPORT NEWS, VA. SN 75-939,468. PUB. 10-31-2000, FILED 3-9-2000.

NNS

2,534,754. COQUICO, INC., SPRINGFIELD, PA. SN 75-908,939. PUB. 8-29-2000, FILED 2-3-2000.

CLASS 37—CONSTRUCTION AND REPAIR

FOR NAVAL SHIPBUILDING (U.S. CLS. 100, 103 AND 106).
FIRST USE 12-0-1996; IN COMMERCE 12-0-1996.

DIGITAL BORINQUEÑO

THE ENGLISH SIGNIFICANCE OF "BORINQUENO" IS "NATIVE OF THE ISLAND".

CLASS 39—TRANSPORTATION AND STORAGE

FOR NAVAL SHIPYARD SERVICES (U.S. CLS. 100 AND 105).
FIRST USE 12-0-1996; IN COMMERCE 12-0-1996.

CLASS 25—CLOTHING

FOR A FULL LINE OF CLOTHING (U.S. CLS. 22 AND 39).
FIRST USE 3-1-2000; IN COMMERCE 6-10-2000.

2,534,799. PELLE PELLE, INC., AUBURN HILLS, MI. SN 75-980,088. PUB. 12-1-1998, FILED 7-22-1996.

PELLE PELLE

CLASS 28—TOYS AND SPORTING GOODS

FOR PLUSH TOYS (U.S. CLS. 22, 23, 38 AND 50).
FIRST USE 3-1-2000; IN COMMERCE 6-10-2000.

OWNER OF U.S. REG. NOS. 1,966,995, 2,013,073, AND OTHERS.

NO CLAIM IS MADE TO THE EXCLUSIVE RIGHT TO USE "PELLE", APART FROM THE MARK AS SHOWN. THE ENGLISH TRANSLATION OF "PELLE PELLE" IS "LEATHER LEATHER".
SEC. 2(F).

CLASS 6—METAL GOODS

FOR METAL KEY CHAINS (U.S. CLS. 2, 12, 13, 14, 23, 25 AND 50).
FIRST USE 3-1-1978; IN COMMERCE 3-1-1978.

CLASS 18—LEATHER GOODS

FOR LEATHER BRIEFCASES AND PURSES (U.S. CLS. 1, 2, 3, 22 AND 41).
FIRST USE 3-1-1978; IN COMMERCE 3-1-1978.

CLASS 20—FURNITURE AND ARTICLES NOT OTHERWISE CLASSIFIED

FOR NON METAL KEY CHAINS (U.S. CLS. 2, 13, 22, 25, 32 AND 50).
FIRST USE 3-1-1978; IN COMMERCE 3-1-1978.

CLASS 25—CLOTHING

FOR MEN'S AND BOY'S WEARING APPAREL, NAMELY, LEATHER AND CANVAS SHOES, COTTON, WOOL AND RAYON SOCKS, AND LEATHER AND COTTON CLOTHING BELTS; AND WOMEN'S AND GIRL'S WEARING APPAREL, NAMELY, COTTON RAYON AND WOOL SOCKS, AND LEATHER AND COTTON CLOTHING BELTS; WOOL, NYLON, RAYON AND POLYESTER SPORTSWEAR, NAMELY, SKI WEAR, SWIMMING WEAR, TENNIS WEAR, GOLF WEAR, BASKETBALL WEAR, BASEBALL WEAR (U.S. CLS. 22 AND 39).
FIRST USE 3-1-1978; IN COMMERCE 3-1-1978.

2,534,800. MARI TELECOM, CO. LTD., SAN JOSE, CA. SN 75-980,878. PUB. 8-15-2000, FILED 6-29-1999.

ARCHMAGE

CLASS 25—CLOTHING

FOR T-SHIRTS AND HATS (U.S. CLS. 22 AND 39).
FIRST USE 5-1-1998; IN COMMERCE 10-1-1998.

CLASS 41—EDUCATION AND ENTERTAINMENT

FOR ENTERTAINMENT SERVICES, NAMELY, PROVIDING AN ON-LINE COMPUTER GAME (U.S. CLS. 100, 101 AND 107).
FIRST USE 5-1-1998; IN COMMERCE 10-1-1998.

2,534,804. LAGOS, INC., PHILADELPHIA, PA. SN 75-981,136. PUB. 1-4-2000, FILED 4-7-1999.

LAGOS

OWNER OF U.S. REG. NO. 1,648,793.

CLASS 14—JEWELRY

FOR PRECIOUS METAL KEY CHAINS AND PRECIOUS METAL MONEY CLIPS (U.S. CLS. 2, 27, 28 AND 50).
FIRST USE 7-1-2000; IN COMMERCE 7-1-2000.

CLASS 20—FURNITURE AND ARTICLES NOT OTHERWISE CLASSIFIED

FOR PICTURE FRAMES, JEWELRY CASES NOT OF PRECIOUS METAL, NON-METAL KEY CHAINS AND NON-METAL MONEY CLIPS (U.S. CLS. 2, 13, 22, 25, 32 AND 50).
FIRST USE 7-1-2000; IN COMMERCE 7-1-2000.

CLASS 21—HOUSEWARES AND GLASS

FOR DINNERWARE, HOUSEHOLD UTENSILS AND SERVING PIECES, NAMELY BABY SPOONS, SALAD TONGS, CAKE SERVERS, GRAVY BOATS, GRAVY LADLES, SERVING SPOONS, SERVING FORKS, AND SERVING PLATTERS (U.S. CLS. 2, 13, 23, 29, 30, 33, 40 AND 50).
FIRST USE 7-1-2000; IN COMMERCE 7-1-2000.

CLASS 30—STAPLE FOODS

FOR CANDY AND CHOCOLATE (U.S. CL. 46).
FIRST USE 7-1-2000; IN COMMERCE 7-1-2000.

2,534,807. LEVEL 3 COMMUNICATIONS, INC., FORMERLY KIEWIT DIVERSIFIED GROUP INC., OMAHA, NE. SN 75-981,322. PUB. 10-24-2000, FILED 3-24-1998.

LEVEL 3 COMMUNICATIONS

NO CLAIM IS MADE TO THE EXCLUSIVE RIGHT TO USE "COMMUNICATIONS", APART FROM THE MARK AS SHOWN.

CLASS 37—CONSTRUCTION AND REPAIR

FOR INSTALLATION OF TELECOMMUNICATION SYSTEMS, NAMELY, FIBER OPTIC NETWORKS (U.S. CLS. 100, 103 AND 106).
FIRST USE 3-0-1998; IN COMMERCE 3-0-1998.

CLASS 38—COMMUNICATION

FOR TELECOMMUNICATIONS GATEWAY SERVICES; TELECOMMUNICATIONS SERVICES, NAMELY, VOICE TELEPHONE LOCAL AND LONG DISTANCE SERVICES, FACSIMILE, AND DATA TRANSMISSION SERVICES VIA FIBER OPTIC NETWORK; PROVIDING MULTIPLE USER ACCESS TO A GLOBAL COMPUTER INFORMATION NETWORK; TELECOMMUNICATION SERVICES, NAMELY, VOICE MAIL SERVICES (U.S. CLS. 100, 101 AND 104).
FIRST USE 3-0-1998; IN COMMERCE 3-0-1998.

2,534,810. WHOLE FOODS MARKET SERVICES, INC., AUSTIN, TX. SN 75-981,404. PUB. 11-7-2000, FILED 8-7-1998.



NO CLAIM IS MADE TO THE EXCLUSIVE RIGHT TO USE "KIDS" AND "ORGANIC", APART FROM THE MARK AS SHOWN.

CLASS 29—MEATS AND PROCESSED FOODS

FOR PEANUT BUTTER, APPLESAUCE, STRAWBERRY JAM, HOT DOGS (MEAT OR TOFU ONLY, NOT SANDWICHES), AND SOY-BASED FOOD BEVERAGES USED AS MILK SUBSTITUTE AND FRUIT-BASED SNACK BARS, ALL MADE FROM ORGANIC INGREDIENTS (U.S. CL. 46).

FIRST USE 3-7-1999; IN COMMERCE 3-7-1999.

CLASS 30—STAPLE FOODS

FOR HOT CHOCOLATE, TORTILLA CHIPS, PROCESSED CEREAL, PASTA SAUCE, SALSA, MACARONI AND CHEESE, HONEY, MUSTARD, AND GRANOLA-BASED SNACK BARS, BARS, ALL MADE FROM ORGANIC INGREDIENTS (U.S. CL. 46).

FIRST USE 1-31-2000; IN COMMERCE 1-31-2000.

2,534,819. FLORISTS' TRANSWORLD DELIVERY, INC., DOWNERS GROVE, IL. SN 76-006,214. PUB. 12-26-2000, FILED 3-21-2000.



OWNER OF U.S. REG. NOS. 844,748, 1,108,614, AND OTHERS.

NO CLAIM IS MADE TO THE EXCLUSIVE RIGHT TO USE "DIRECTORY SERVICES", APART FROM THE MARK AS SHOWN.

CLASS 16—PAPER GOODS AND PRINTED MATTER

FOR PRINTED PUBLICATIONS IN THE NATURE OF DIRECTORIES, BROCHURES, PRODUCT CATALOGS, POSTERS, ADVERTISING WORKBOOKS, ANNOUNCEMENTS AND NEWSLETTERS ALL FEATURING TOPICS OF INTEREST TO THOSE IN THE GIFT TRADE AND FLORIST INDUSTRY (U.S. CLS. 2, 5, 22, 23, 29, 37, 38 AND 50).

FIRST USE 0-0-2000; IN COMMERCE 0-0-2000.

CLASS 42—SCIENTIFIC, COMPUTER AND LEGAL SERVICES

FOR COMPUTER SERVICES, NAMELY, PROVIDING ON-LINE PUBLICATIONS IN THE NATURE OF DIRECTORIES, BROCHURES, PRODUCT CATALOGS, POSTERS, ADVERTISING WORKBOOKS, ANNOUNCEMENTS AND NEWSLETTERS ALL FEATURING TOPICS OF INTEREST TO THOSE IN THE GIFT TRADE AND FLORIST INDUSTRY; CUSTOMIZED PRINTING OF PRINTED AND ELECTRONIC PUBLICATIONS IN THE FLORIST AND GIFT TRADE CONSISTING OF DIRECTORIES, BROCHURES, PRODUCT CATALOGS, POSTERS, ADVERTISING WORKBOOKS, ANNOUNCEMENTS AND NEWSLETTERS (U.S. CLS. 100 AND 101).

FIRST USE 0-0-2000; IN COMMERCE 0-0-2000.

2,534,825. HEMINGWAY, LTD., NEW YORK, NY. SN 76-010,092. PUB. 1-9-2001, FILED 3-27-2000.

ERNEST HEMINGWAY

OWNER OF U.S. REG. NO. 2,319,754.

THE NAME SHOWN IN THE MARK DOES NOT IDENTIFY A PARTICULAR LIVING INDIVIDUAL.

CLASS 16—PAPER GOODS AND PRINTED MATTER

FOR GLOBES (U.S. CLS. 2, 5, 22, 23, 29, 37, 38 AND 50).

FIRST USE 6-1-2001; IN COMMERCE 6-1-2001.

CLASS 20—FURNITURE AND ARTICLES NOT OTHERWISE CLASSIFIED

FOR FURNITURE SCREENS, ROOM DIVIDERS (U.S. CLS. 2, 13, 22, 25, 32 AND 50).

FIRST USE 4-1-2001; IN COMMERCE 4-1-2001.

CLASS 21—HOUSEWARES AND GLASS

FOR WINE RACKS; CONTAINERS FOR HOUSEHOLD OR KITCHEN USE NOT OF PRECIOUS METAL (U.S. CLS. 2, 13, 23, 29, 30, 33, 40 AND 50).

FIRST USE 5-2-2001; IN COMMERCE 5-2-2001.

2,534,839. GREAT NUMBERS! LLC, RED BANK, NJ. SN 76-018,344. PUB. 2-6-2001, FILED 4-5-2000.

THE EXTRAORDINARY EXECUTIVE PROGRAM

NO CLAIM IS MADE TO THE EXCLUSIVE RIGHT TO USE "EXECUTIVE PROGRAM", APART FROM THE MARK AS SHOWN.

CLASS 35—ADVERTISING AND BUSINESS

FOR BUSINESS MANAGEMENT CONSULTING SERVICES (U.S. CLS. 100, 101 AND 102).

FIRST USE 2-5-2001; IN COMMERCE 2-5-2001.

CLASS 41—EDUCATION AND ENTERTAINMENT

FOR EDUCATIONAL SERVICES, NAMELY, CONDUCTING TRAINING WORKSHOPS, SEMINARS, AND LECTURES IN THE FIELD OF BUSINESS MANAGEMENT CONSULTING (U.S. CLS. 100, 101 AND 107).
FIRST USE 2-5-2001; IN COMMERCE 2-5-2001.

2,534,919. STEVENS, KAREN M., BRADLEY BEACH, NJ. SN 76-099,830. PUB. 3-27-2001, FILED 7-31-2000.

FROM THE HEARTH**CLASS 16—PAPER GOODS AND PRINTED MATTER**

FOR COOKBOOKS (U.S. CLS. 2, 5, 22, 23, 29, 37, 38 AND 50).
FIRST USE 11-0-2000; IN COMMERCE 11-0-2000.

CLASS 35—ADVERTISING AND BUSINESS

FOR MAIL ORDER CATALOG SERVICES FEATURING GOURMET FOODS AND CULINARY ACCESSORIES; ON-LINE RETAIL STORE SERVICES FEATURING GOURMET FOODS AND CULINARY ACCESSORIES (U.S. CLS. 100, 101 AND 102).
FIRST USE 11-0-2000; IN COMMERCE 11-0-2000.

2,534,841. GRAHAM WEBB INTERNATIONAL LIMITED PARTNERSHIP, CARLSBAD, CA. SN 76-020,733. PUB. 12-5-2000, FILED 4-7-2000.

BIBO**CLASS 3—COSMETICS AND CLEANING PREPARATIONS**

FOR SKIN CARE PREPARATIONS, NAMELY, MOISTURIZERS, CLEANSERS, TONERS, FACE MASKS, EYE CREAM, ANTI-AGING CREAM, AND BODY LOTION; FOUNDATION, FACE POWDER, EYE SHADOW, BLUSH, LIP PENCILS, LIPSTICK, MASCARA, EYELINER, EYE PENCILS, AND LIP GLOSS (U.S. CLS. 1, 4, 6, 50, 51 AND 52).
FIRST USE 9-6-2000; IN COMMERCE 9-6-2000.

CLASS 21—HOUSEWARES AND GLASS

FOR COSMETIC BRUSHES AND APPLICATORS (U.S. CLS. 2, 13, 23, 29, 30, 33, 40 AND 50).
FIRST USE 9-6-2000; IN COMMERCE 9-6-2000.

2,534,974. BINDING SITE. LTD., THE, BIRMINGHAM, UNITED KINGDOM. SN 78-017,010. PUB. 6-5-2001, FILED 7-17-2000.

FREELITE**CLASS 1—CHEMICALS**

FOR REAGENTS, DIAGNOSTIC REAGENTS, BIOLOGICAL REAGENTS, HISTOLOGY REAGENTS, ENZYME RADIOIMMUNOASSAY REAGENTS, IMMUNOASSAY REAGENTS, ANTIGEN SUBSTRATES, AND ANTIBODIES FOR SCIENTIFIC RESEARCH USE; AND TEST KITS COMPRISED OF REAGENTS, BUFFERS, CALIBRATORS, DILUENTS, ANTIBODIES, ANTIGEN SUBSTRATES, CONJUGATES, STOPPING SOLUTIONS, ANTISERA AND/OR DROPPER BOTTLES FOR SCIENTIFIC AND RESEARCH USE USING BLOOD, BODY FLUIDS, BODY TISSUES OR EXTRACTS THEREOF (U.S. CLS. 1, 5, 6, 10, 26 AND 46).
FIRST USE 10-20-2000; IN COMMERCE 10-20-2000.

2,534,910. S-T-N HOLDINGS, INC., LAS VEGAS, NV. SN 76-090,220. PUB. 3-6-2001, FILED 6-30-2000.

FirePRO**CLASS 5—PHARMACEUTICALS**

FOR CALIBRATING SOLUTIONS, DILUENTS, CONTROL SAMPLES, REAGENTS, ANTIBODIES, ANTIGEN SUBSTRATES, CONJUGATES, STOPPING SOLUTIONS, IMMUNOFLUORESCENCE REAGENTS, HISTOLOGY REAGENTS, ENZYME IMMUNOASSAY REAGENTS AND GENERAL PURPOSE REAGENTS FOR MEDICAL AND VETERINARY DIAGNOSTIC AND CLINICAL USE; AND DIAGNOSTIC AND IMMUNOLOGICAL TEST KITS CONSISTING OF REAGENTS, CONTROLS, BUFFERS, CALIBRATORS, DILUENTS, ANTIBODIES, ANTIGEN SUBSTRATES, CONJUGATES, STOPPING SOLUTIONS, ANTISERA AND/OR DROPPER BOTTLES, ALL FOR USE IN MEASURING THE CONCENTRATION OF PROTEINS, ANTIBODIES, ANTIGENS AND OTHER SUBSTANCES IN BLOOD, OTHER BODY FLUIDS AND BODY TISSUES, OR EXTRACTS THEREOF, FOR USE IN THE DIAGNOSIS, TREATMENT, CURE, PREVENTION OR MITIGATION OF DISEASES AND OTHER CONDITIONS IN HUMANS AND ANIMALS (U.S. CLS. 6, 18, 44, 46, 51 AND 52).
FIRST USE 6-29-2001; IN COMMERCE 6-29-2001.

CLASS 1—CHEMICALS

FOR CHEMICAL COMPOSITION TO IMPART FLAME RETARDANCY TO WOOD PRODUCTS (U.S. CLS. 1, 5, 6, 10, 26 AND 46).
FIRST USE 1-11-2001; IN COMMERCE 1-11-2001.

CLASS 19—NON-METALLIC BUILDING MATERIALS

FOR WOOD PRODUCTS, NAMELY LUMBER, TIMBERS, PLYWOOD, PARTICLE BOARD, LAMINATED WOOD PRODUCTS, ORIENTED STRAND BOARD, AND FIBER BOARD TREATED WITH A CHEMICAL COMPOSITION TO IMPART FLAME RETARDANCY (U.S. CLS. 1, 12, 33 AND 50).
FIRST USE 1-11-2001; IN COMMERCE 1-11-2001.

JANUARY 29, 2002

U.S. PATENT AND TRADEMARK OFFICE

TM 499

2,534,984. GEORGE E MEHLMAUER, DBA 3BUSYGUYS.-
COM, HEMET, CA. SN 78-032,320. PUB. 6-5-2001, FILED
10-25-2000.

3 BUSY GUYS

CLASS 37—CONSTRUCTION AND REPAIR

FOR CUSTOM CONSTRUCTION, REAL ESTATE DE-
VELOPMENT, CONSTRUCTION INSPECTION, CON-
STRUCTION SUPERVISION, CONSTRUCTION
RENOVATION (U.S. CLS. 100, 103 AND 106).
FIRST USE 2-28-1994; IN COMMERCE 2-28-1994.

CLASS 36—INSURANCE AND FINANCIAL

FOR REAL ESTATE BROKERAGE (U.S. CLS. 100, 101
AND 102).
FIRST USE 2-28-1994; IN COMMERCE 2-28-1994.

* * * * *

SECTION 2.— INTERNATIONAL CLASSIFICATION

The short titles associated below with the international class numbers are terms designed merely for quick identification and are not an official part of the international classification. The full names of international classes are given in section 6.1 of the trademark rules of practice.

The designation "U.S. Cl." appearing in this section refers to the U.S. class in effect prior to Sep. 1, 1973 rather than the international class which applies to applications filed on or after that date. For adoption of international classification see notice in the OFFICIAL GAZETTE of Jun. 26, 1973 (911 O.G. TM 210).

Application in one class

CLASS 1—CHEMICALS

2,534,534. RWE-DEA AKTIENGESELLSCHAFT FUR MINERALOEL UND CHEMIE, D-22297 HAMBURG, FED REP GERMANY. SN 75-672,311. PUB. 8-1-2000, FILED 3-31-1999.

CLASS 1—(Continued).

2,534,823. BIO-LAB, INC., DECATUR, GA. SN 76-008,077. PUB. 1-9-2001, FILED 3-23-2000.

MARLOQUEST

FOR CHEMICALS, NAMELY DISPERSING AGENTS, SEQUESTERING AGENTS AND SOIL RELEASE POLYMERS FOR USE AS WASHING AND CLEANING AGENTS IN INDUSTRIAL AND INSTITUTIONAL CLEANING CHEMICALS, IN TEXTILE PROCESSING AND FINISHING CHEMICALS AND IN PULP AND PAPER CHEMICALS (U.S. CLS. 1, 5, 6, 10, 26 AND 46).
FIRST USE 11-0-1999; IN COMMERCE 11-0-1999.

RENEWAL

FOR WATER TREATMENT CHEMICALS FOR USE IN SWIMMING POOLS AND SPAS (U.S. CLS. 1, 5, 6, 10, 26 AND 46).
FIRST USE 4-19-2001; IN COMMERCE 4-19-2001.

2,534,725. EVERGREEN INDUSTRIES.COM, EATONVILLE, WA. SN 75-875,394. PUB. 10-24-2000, FILED 1-3-2000.

CHECKMATE

FOR FORENSIC TEST KITS FOR HOME USE CONSISTING PRIMARILY OF DIAGNOSTIC REAGENTS FOR DETECTING THE PRESENCE OF SEMEN ON ANY MATERIAL (U.S. CLS. 1, 5, 6, 10, 26 AND 46).
FIRST USE 5-27-2000; IN COMMERCE 5-27-2000.

CLASS 2—PAINTS

2,534,620. MCWHORTER TECHNOLOGIES, INC., CARPENTERSVILLE, IL. SN 75-767,578. PUB. 3-28-2000, FILED 8-4-1999.

CHARISMA COLORANTS

NO CLAIM IS MADE TO THE EXCLUSIVE RIGHT TO USE "COLORANTS", APART FROM THE MARK AS SHOWN.

FOR COLORANTS FOR USE IN THE MANUFACTURE OF ARCHITECTURAL PAINTS, STAINS, AND PLASTICS (U.S. CLS. 6, 11 AND 16).
FIRST USE 1-4-2001; IN COMMERCE 1-4-2001.

2,534,814. LESCO TECHNOLOGIES LLC, STRONGSVILLE, OH, BY ASSIGNMENT LESCO, INC., ROCKY RIVER, OH. SN 75-981,514. PUB. 12-5-2000, FILED 1-24-2000.

NOVEX

FOR FERTILIZERS FOR AGRICULTURAL AND DOMESTIC USE IN ALL TYPES OF MARKETS (U.S. CLS. 1, 5, 6, 10, 26 AND 46).
FIRST USE 9-21-1999; IN COMMERCE 9-21-1999.

CLASS 3—COSMETICS AND CLEANING PREPARATIONS

CLASS 3—(Continued).

2,534,401. SALVATORE FERRAGAMO ITALIA S.P.A., FLORENCE, ITALY. SN 75-388,374. PUB. 3-23-1999, FILED 11-12-1997.

CLASS 3—(Continued).

2,534,456. TOVA CORPORATION, BEVERLY HILLS, CA. SN 75-529,100. PUB. 5-4-1999, FILED 7-31-1998.

TOVA SECRETS ON LOCATION

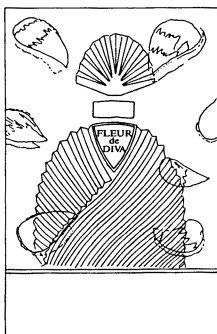

OWNER OF U.S. REG. NOS. 1,124,818, 1,295,432, AND 1,464,964.
 FOR COSMETIC TRAVEL KIT, NAMELY, MAKEUP AND MAKEUP CASE SOLD AS A UNIT (U.S. CLS. 1, 4, 6, 50, 51 AND 52).
 FIRST USE 9-0-1998; IN COMMERCE 9-0-1998.

2,534,567. JEAN CHARLES, INCORPORATED, THERMAL, CA. SN 75-708,856. PUB. 1-25-2000, FILED 5-17-1999.

KOALA DREAMS

OWNER OF U.S. REG. NOS. 654,884, 1,457,922, AND OTHERS.

THE LINING ON THE BOTTLE IS A FEATURE OF THE MARK AND FALLING PETALS ARE LINED FOR THE COLORS GREEN, ORANGE AND PINK.

THE PETAL SHAPED DESIGNS IN THE MARK APPEAR IN ALTERNATING COLORS OF GREEN, ORANGE, AND PINK.

THE ENGLISH TRANSLATION OF "FLEUR DE DIVA" IS "FLOWER OF STAR".

FOR PERFUMES, EAU DE PARFUM, COLOGNE, TOILET WATER, ESSENTIAL OILS FOR PERSONAL USE; COSMETICS, NAMELY, EYE MAKEUP, EYE SHADOW, EYELINER, LIP GLOSS, LIPSTICK, FACIAL MAKEUP, FOUNDATION MAKEUP, MASCARA, FACE POWDER; HAIR CARE PREPARATIONS, HAIR CLEANING PREPARATIONS, HAIR STYLING PREPARATIONS; SOAPS, BATH SOAPS, TOILET SOAPS; BATH AND SHOWER GEL; BODY LOTIONS AND SKIN LOTIONS (U.S. CLS. 1, 4, 6, 50, 51 AND 52).

FIRST USE 2-0-1998; IN COMMERCE 3-0-1998.

FOR HAIR SHAMPOOS, HAIR CONDITIONERS, HAND SOAPS, SKIN, BODY AND HAND LOTIONS (U.S. CLS. 1, 4, 6, 50, 51 AND 52).

FIRST USE 12-0-2000; IN COMMERCE 12-0-2000.

2,534,632. T.W. ENTERPRISES, LTD., ST.CLOUD, MN. SN 75-778,866. PUB. 3-28-2000, FILED 8-19-1999.

CONCEPT

FOR TANNING LOTIONS (U.S. CLS. 1, 4, 6, 50, 51 AND 52).

FIRST USE 1-3-2000; IN COMMERCE 1-3-2000.

2,534,442. DERMOFARM, S.A., 08025 BARCELONA, SPAIN. SN 75-492,203. PUB. 5-4-1999, FILED 5-28-1998.

COMODYNES

FOR PRE-MOISTENED COSMETIC TISSUES, PRE-MOISTENED COSMETIC TOWELETTES, PRE-MOISTENED COSMETIC WIPES (U.S. CLS. 1, 4, 6, 50, 51 AND 52).

FIRST USE 6-0-1996; IN COMMERCE 2-14-2001.

2,534,657. COLGATE-PALMOLIVE COMPANY, NEW YORK, NY. SN 75-806,901. PUB. 4-25-2000, FILED 9-23-1999.

SPRINGTIME EVERY TIME YOU DO DISHES

FOR DISHWASHING DETERGENT AND HAND SOAP (U.S. CLS. 1, 4, 6, 50, 51 AND 52).

FIRST USE 7-0-1999; IN COMMERCE 7-0-1999.

CLASS 3—(Continued).

2,534,700. VALUE SMART PRODUCTS, LLC, CHESTERFIELD, MO. SN 75-844,040. PUB. 3-20-2001, FILED 11-9-1999.

BUG FREE

NO CLAIM IS MADE TO THE EXCLUSIVE RIGHT TO USE "BUG", APART FROM THE MARK AS SHOWN.

FOR WIND SHIELD AND VEHICLE WASHER FLUID AND SPRAY; AUTOMOBILE CLEANING PREPARATION, NAMELY, A COMPOSITION FOR APPLICATION TO VEHICLE SURFACES TO PROTECT AGAINST BUGS AND REMOVE THE SAME THROUGH DISSOLVING UPON WASHING (U.S. CLS. 1, 4, 6, 50, 51 AND 52).

FIRST USE 12-1-1989; IN COMMERCE 12-1-1989.

2,534,719. MAKE-UP ART COSMETICS INC., NEW YORK, NY. SN 75-868,483. PUB. 3-6-2001, FILED 12-10-1999.

STUDIO MOISTURE FIX

OWNER OF U.S. REG. NO. 2,207,315.

NO CLAIM IS MADE TO THE EXCLUSIVE RIGHT TO USE "MOISTURE", APART FROM THE MARK AS SHOWN.

FOR SKINCARE PRODUCTS, NAMELY, MOISTURIZERS (U.S. CLS. 1, 4, 6, 50, 51 AND 52).

FIRST USE 6-26-2001; IN COMMERCE 6-26-2001.

2,534,724. PROCTER & GAMBLE COMPANY, THE, CINCINNATI, OH. SN 75-875,149. PUB. 4-17-2001, FILED 12-28-1999.

DEEP DOWN FRESH

FOR LAUNDRY DETERGENT (U.S. CLS. 1, 4, 6, 50, 51 AND 52).

FIRST USE 5-15-2000; IN COMMERCE 5-15-2000.

2,534,757. HOWARD, GLENN, ENGLEWOOD, CO. SN 75-911,356. PUB. 12-5-2000, FILED 2-7-2000.

SIMPLY ALOE

NO CLAIM IS MADE TO THE EXCLUSIVE RIGHT TO USE "ALOE", APART FROM THE MARK AS SHOWN.

FOR COSMETICS, NAMELY SKIN CARE PREPARATIONS IN THE FORM OF FACIAL MOISTURIZERS, FACIAL CLEANSERS, ASTRINGENTS, FACIAL TONERS, FACIAL EXFOLIATING SCRUBS, FACIAL CLEANSING GELS, MASQUES, LOTIONS, REGENERATING GELS, EYE CREAMS, NIGHT CREAMS, DAY CREAMS, SHAVING CREAMS, SHAVING LOTIONS, ANTI BABY RASH CREAMS, BABY RASH SALVES, SUNSCREEN LOTIONS, SUNSCREEN GELS, SUNSCREEN SPRAYS; AND HAIR CARE PREPARATIONS (U.S. CLS. 1, 4, 6, 50, 51 AND 52).

FIRST USE 4-30-2000; IN COMMERCE 4-30-2000.

CLASS 3—(Continued).

2,534,763. POLA CHEMICAL INDUSTRIES, INC., SHIZUOKA-SHI, SHIZUOKA-KEN, JAPAN. SN 75-914,457. PUB. 2-13-2001, FILED 2-8-2000.



THE MARK CONSISTS OF THE CHARACTERS "1/f" AND THE TERM "UN-EF".

THE ENGLISH TRANSLATION OF "UN-EF" IS THE FRENCH PRONUNCIATION FOR "ONE-F".

FOR COSMETICS, NAMELY, LOTIONS FOR SKIN, LOTIONS FOR BODY, SUNSCREEN LOTIONS, SUNSCREEN POWDERS, SUNSCREEN CREAMS, LOTIONS FOR WHITENING THE SKIN, SKIN WHITENING ESSENCES (U.S. CLS. 1, 4, 6, 50, 51 AND 52).

FIRST USE 8-1-2001; IN COMMERCE 8-1-2001.

2,534,776. ARAMIS INC., NEW YORK, NY. SN 75-926,829. PUB. 5-1-2001, FILED 2-23-2000.

LEMON CREAM PIE

OWNER OF U.S. REG. NO. 2,245,110.

FOR SKIN CARE PREPARATIONS NAMELY, SKIN HYDRATING AND MOISTURIZING LOTION (U.S. CLS. 1, 4, 6, 50, 51 AND 52).

FIRST USE 8-0-2000; IN COMMERCE 8-0-2000.

2,534,779. BIOCHEM SYSTEMS, INC., WICHITA, KS. SN 75-928,759. PUB. 11-28-2000, FILED 2-25-2000.

TARPEDO

FOR SOLVENT-TYPE CLEANING PRODUCT USED FOR CLEANING ASPHALT, GREASE, OIL, AND ADHESIVES (U.S. CLS. 1, 4, 6, 50, 51 AND 52).

FIRST USE 9-1-2000; IN COMMERCE 9-1-2000.

CLASS 3—(Continued).

2,534,781. VALUE SMART PRODUCTS, LLC, CHESTER-FIELD, MO. SN 75-930,792. PUB. 2-6-2001, FILED 2-28-2000.

BUG SHIELD

NO CLAIM IS MADE TO THE EXCLUSIVE RIGHT TO USE "BUG", APART FROM THE MARK AS SHOWN.

FOR AUTOMOBILE CLEANING PREPARATION, NAMELY, A COMPOSITION FOR APPLICATION TO VEHICLE SURFACES TO PROTECT AGAINST INSECTS AND OTHER DIRT AND REMOVES THE SAME THROUGH DISSOLVING UPON WASHING (U.S. CLS. 1, 4, 6, 50, 51 AND 52).

FIRST USE 8-0-1999; IN COMMERCE 8-0-1999.



2,534,805. L' OREAL, 75008 PARIS, FRANCE. SN 75-981,219. PUB. 10-10-2000, FILED 1-6-2000.

AGE-PERFECT

FOR SKIN MOISTURIZE (U.S. CLS. 1, 4, 6, 50, 51 AND 52).

FIRST USE 3-1-2001; IN COMMERCE 3-1-2001.



2,534,808. MARY KAY INC., DALLAS, TX. SN 75-981,334. PUB. 11-9-1999, FILED 6-18-1998.

WONDERFUL

FOR COSMETICS, BEAUTY AND SKIN CARE PRODUCTS, NAMELY, SKIN CLEANSERS, SHAMPOOS, CONDITIONERS, SUN SCREENING LOTIONS, OILS AND GELS; SUN TANNING LOTIONS, OILS AND GELS; SHOWER GELS, SHAVING GELS, SHAVING LOTIONS, BODY LOTIONS, BODY POWDERS, FACIAL AND BODY SCRUBS, FACIAL AND BODY MASKS, AND SKIN EMOLLIENTS (U.S. CLS. 1, 4, 6, 50, 51 AND 52).

FIRST USE 6-0-1998; IN COMMERCE 7-0-2000.



2,534,816. PRIORITIES, INC., RICHMOND, VA. SN 76-001,845. PUB. 4-3-2001, FILED 3-16-2000.

R&R

FOR SKIN CARE LOTION (U.S. CLS. 1, 4, 6, 50, 51 AND 52).

FIRST USE 6-1-2000; IN COMMERCE 6-1-2000.

CLASS 3—(Continued).

2,534,830. TOO, INC., COLUMBUS, OH. SN 76-012,679. PUB. 12-12-2000, FILED 3-29-2000.



OWNER OF U.S. REG. NOS. 2,263,715, 2,383,565, AND OTHERS.

FOR PERSONAL CARE PRODUCTS, NAMELY, BODY GLITTER (U.S. CLS. 1, 4, 6, 50, 51 AND 52).

FIRST USE 8-22-2001; IN COMMERCE 8-22-2001.



2,534,842. GRAHAM WEBB INTERNATIONAL LIMITED PARTNERSHIP, CARLSBAD, CA. SN 76-021,803. PUB. 12-5-2000, FILED 4-7-2000.

BRING INNER BEAUTY OUT

FOR SKIN CARE PREPARATIONS, NAMELY, MOISTURIZERS, CLEANSERS, TONERS, FACE MASKS, EYE CREAM, ANTI-AGING CREAM, AND BODY LOTION; FOUNDATION, FACE POWDER, EYE SHADOW, BLUSH, LIP PENCILS, LIPSTICK, MASCARA, EYELINER, EYE PENCILS, AND LIP GLOSS (U.S. CLS. 1, 4, 6, 50, 51 AND 52).

FIRST USE 9-6-2000; IN COMMERCE 9-6-2000.



2,534,843. GRAHAM WEBB INTERNATIONAL LIMITED PARTNERSHIP, CARLSBAD, CA. SN 76-021,869. PUB. 12-5-2000, FILED 4-7-2000.

BIBO BRING INNER BEAUTY OUT

FOR SKIN CARE PREPARATIONS, NAMELY, MOISTURIZERS, CLEANSERS, TONERS, FACE MASKS, EYE CREAM, ANTI-AGING CREAM, AND BODY LOTION; FOUNDATION, FACE POWDER, EYE SHADOW, BLUSH, LIP PENCILS, LIPSTICK, MASCARA, EYELINER, EYE PENCILS, AND LIP GLOSS (U.S. CLS. 1, 4, 6, 50, 51 AND 52).

FIRST USE 9-6-2000; IN COMMERCE 9-6-2000.

CLASS 3—(Continued).

2,534,864. INTIMATE BEAUTY CORPORATION, DBA VICTORIA'S SECRET BEAUTY, NEW YORK, NY. SN 76-038,062. PUB. 12-12-2000, FILED 5-1-2000.

GENTLE COMFORT

FOR PERSONAL CARE PRODUCTS, NAMELY, NAIL POLISH, NAIL POLISH REMOVER, NAIL STENCILS, HARD ARTIFICIAL NAILS, SHOWER GEL, BUBBLE BATH, FRAGRANT BODY SPLASH, HAND LOTION, BODY LOTION, FACE LOTION, HAND SOAP, BODY SOAP, FACE SOAP, HAIR SHAMPOO, HAIR CONDITIONER, HAIR STYLING GEL, HAIR SPRAY, HAIR DYES, HAIR RINSES, PERFUME, COLOGNE, BODY GLITTER, MASCARA, BLUSH, EYE SHADOW, LIP STICK, LIP GLOSS, MAKE-UP, MAKE-UP REMOVER, EYECREAM, HAND CREAM, BODY CREAM, FACE CREAM, ASTRINGENT FOR THE FACE, FACE CLEANSER, BATH OIL, BATH BEADS, BODY POWDER, FACE POWDER, TALCUM POWDER, NON-MEDICATED BLEMISH STICK, SHAVING CREAM, DEODORANT, POTPOURRI, SACHETS, SCENTED BEADS, BODY SUNTAN LOTION, FACE SUNTAN LOTION, BODY SUNLESS TANNING LOTION, FACE SUNLESS TANNING LOTION, BODY PRE-SUNTANNING LOTION, FACE PRE-SUNTANNING LOTION, BODY AFTER SUNTANNING LOTION AND FACE AFTER SUNTANNING LOTION (U.S. CLS. 1, 4, 6, 50, 51 AND 52).

FIRST USE 6-0-2001; IN COMMERCE 6-0-2001.

2,534,874. ARAMIS INC., NEW YORK, NY. SN 76-042,293. PUB. 2-6-2001, FILED 5-5-2000.

PEPPERMINT STICK

NO CLAIM IS MADE TO THE EXCLUSIVE RIGHT TO USE "PEPPERMINT", APART FROM THE MARK AS SHOWN.

FOR SKIN CARE PREPARATIONS NAMELY, SHOWER GEL AND SKIN MOISTURIZING LOTION (U.S. CLS. 1, 4, 6, 50, 51 AND 52).

FIRST USE 12-0-2000; IN COMMERCE 12-0-2000.

2,534,879. C-ZONE, LLC, DENVER, CO. SN 76-048,571. PUB. 1-2-2001, FILED 5-15-2000.

CZONE

FOR HAIR CARE PRODUCTS, NAMELY, SHAMPOO AND CONDITIONER (U.S. CLS. 1, 4, 6, 50, 51 AND 52).

FIRST USE 3-0-2001; IN COMMERCE 3-0-2001.

CLASS 3—(Continued).

2,534,890. SAN TELMO, INC., BARRINGTON, IL. SN 76-057,634. PUB. 3-6-2001, FILED 5-26-2000.

VM

FOR COSMETICS, FRAGRANCES AND PERSONAL CARE PRODUCTS, NAMELY, LIPSTICK, LIP LINER, LIP LACQUER, LIP GLOSS, EYE LINER, MASCARA, EYE SHADOW, FOUNDATION, BLUSH, SKIN BRONZING POWDER, SKIN PRESSED POWDER, SKIN LOOSE POWDER AND CONCEALERS (U.S. CLS. 1, 4, 6, 50, 51 AND 52).

FIRST USE 8-28-2000; IN COMMERCE 8-28-2000.

2,534,895. HELENE CURTIS, INC., WILMINGTON, DE. SN 76-059,935. PUB. 12-5-2000, FILED 5-30-2000.

SUAVE NATURALS

OWNER OF U.S. REG. NOS. 613,664, 2,317,270, AND OTHERS.

NO CLAIM IS MADE TO THE EXCLUSIVE RIGHT TO USE "NATURALS", APART FROM THE MARK AS SHOWN. FOR ANTIPERSPIRANT AND DEODORANT (U.S. CLS. 1, 4, 6, 50, 51 AND 52).

FIRST USE 12-11-2000; IN COMMERCE 12-11-2000.

2,534,924. HELENE CURTIS, INC., WILMINGTON, DE. SN 76-109,096. PUB. 5-1-2001, FILED 8-14-2000.

AROMABENEFITS

FOR HAIR CARE PRODUCTS, NAMELY, SHAMPOO AND CONDITIONER (U.S. CLS. 1, 4, 6, 50, 51 AND 52).

FIRST USE 2-1-2001; IN COMMERCE 2-1-2001.

2,534,937. JOHN PAUL MITCHELL SYSTEMS, SANTA CLARITA, CA. SN 76-152,536. PUB. 7-10-2001, FILED 10-23-2000.

TAMING SPRAY

NO CLAIM IS MADE TO THE EXCLUSIVE RIGHT TO USE "SPRAY", APART FROM THE MARK AS SHOWN.

FOR HAIR STYLING PREPARATIONS, HAIR SPRAY, AND HAIR CONDITIONER (U.S. CLS. 1, 4, 6, 50, 51 AND 52).

FIRST USE 4-15-2001; IN COMMERCE 4-15-2001.

CLASS 3—(Continued).

2,534,969. PIONEER ECLIPSE CORPORATION, SPARTA, NC. SN 78-015,078. PUB. 5-22-2001, FILED 6-30-2000.

ECONOSTAR

FOR PREPARATIONS FOR POLISHING, FINISHING, STRIPPING AND CLEANING FLOOR SURFACES (U.S. CLS. 1, 4, 6, 50, 51 AND 52).
FIRST USE 10-9-2000; IN COMMERCE 10-9-2000.

CLASS 5—(Continued).

2,534,532. DURVET, INC., BLUE SPRINGS, MO. SN 75-669,876. PUB. 5-1-2001, FILED 3-29-1999.

DURGUARD

FOR BIOLOGICAL PREPARATIONS FOR PROTECTING CATTLE AGAINST BOVINE RESPIRATORY DISEASE (U.S. CLS. 6, 18, 44, 46, 51 AND 52).
FIRST USE 9-0-1999; IN COMMERCE 9-0-1999.

2,534,976. KAY CHEMICAL COMPANY, GREENSBORO, NC. SN 78-018,444. PUB. 3-27-2001, FILED 7-26-2000.

NO THAW

FOR CLEANERS FOR FREEZERS AND COOLERS (U.S. CLS. 1, 4, 6, 50, 51 AND 52).
FIRST USE 10-18-2000; IN COMMERCE 10-18-2000.

2,534,614. DONALEX CORPORATION, LAGUNA HILLS, CA. SN 75-754,024. PUB. 4-17-2001, FILED 7-19-1999.

TOAST

FOR TOPICAL ANALGESICS; TOPICAL ANALGESICS FOR ATHLETES AND FOR ARTHRITIS SUFFERERS (U.S. CLS. 6, 18, 44, 46, 51 AND 52).
FIRST USE 1-24-2000; IN COMMERCE 2-1-2000.

CLASS 4—LUBRICANTS AND FUELS

2,534,942. BOHANNON, GARY MICHAEL, SHASTA, CA. SN 78-000,588. PUB. 7-24-2001, FILED 3-23-2000.

MONKEY JUNK

FOR SPORTS RELATED PRODUCTS, NAMELY BICYCLE LUBRICATING OILS (U.S. CLS. 1, 6 AND 15).
FIRST USE 1-1-2001; IN COMMERCE 1-1-2001.

2,534,639. CREATIVE PET PRODUCTS, INC., WAYZATA, MN. SN 75-792,337. PUB. 5-30-2000, FILED 9-3-1999.

HEALTHY HOUND

NO CLAIM IS MADE TO THE EXCLUSIVE RIGHT TO USE "HOUND", APART FROM THE MARK AS SHOWN.
FOR KITS CONTAINING GROOMING PREPARATIONS FOR DOGS, NAMELY, TOOTHPASTE, TOOTHBRUSHES, VITAMINS AND SHAMPOOS (U.S. CLS. 6, 18, 44, 46, 51 AND 52).
FIRST USE 8-21-2001; IN COMMERCE 8-21-2001.

CLASS 5—PHARMACEUTICALS

2,534,414. CERDIC B.V., 6718 TB EDE, NETHERLANDS, BY ASSIGNMENT CHRISTIAANS & VAN DE WIEL B.V., 6718 TB EDE, NETHERLANDS. SN 75-436,965. PUB. 7-25-2000, FILED 2-19-1998.

CERDIC

OWNER OF BENELUX REG. NO. 570563, DATED 3-31-1995, EXPIRES 3-31-2005.
FOR MEDICAL PREPARATIONS, NAMELY, NUTRITIONAL SUPPLEMENTS FOR STIMULATING GROWTH AND/OR ADAPTING HUMAN PHYSICAL SHAPE (U.S. CLS. 6, 18, 44, 46, 51 AND 52).
FIRST USE 1-0-1994; IN COMMERCE 1-0-1994.

2,534,682. PHARMACIA & UPJOHN S.A., L-1470, LUXEMBOURG. SN 75-832,455. PUB. 7-11-2000, FILED 10-26-1999.

AXERT

FOR PHARMACEUTICAL PREPARATIONS FOR THE TREATMENT OF MIGRAINES (U.S. CLS. 6, 18, 44, 46, 51 AND 52).
FIRST USE 4-30-2000; IN COMMERCE 4-30-2000.

2,534,471. MEAD JOHNSON & COMPANY, EVANSVILLE, IN. SN 75-557,272. PUB. 3-30-1999, FILED 9-23-1998.

ENFALYTE

FOR ORAL ELECTROLYTE SOLUTION (U.S. CLS. 6, 18, 44, 46, 51 AND 52).
FIRST USE 4-7-2001; IN COMMERCE 4-7-2001.

2,534,717. IXION BIOTECHNOLOGY, INC., ALACHUA, FL. SN 75-867,965. PUB. 8-1-2000, FILED 12-9-1999.

OX-CONTROL

FOR NUTRITIONAL SUPPLEMENTS TO PALLIATE THE EFFECTS OF OXALATE (U.S. CLS. 6, 18, 44, 46, 51 AND 52).
FIRST USE 6-29-2001; IN COMMERCE 7-27-2001.

CLASS 5—(Continued).

2,534,753. METAGENICS, INC., SAN CLEMENTE, CA. SN 75-907,612. PUB. 11-21-2000, FILED 1-27-2000.

ULTRA CLA

NO CLAIM IS MADE TO THE EXCLUSIVE RIGHT TO USE "CLA", APART FROM THE MARK AS SHOWN.

FOR DIETARY SUPPLEMENTS CONTAINING CONJUGATED LINOLEIC ACID (U.S. CLS. 6, 18, 44, 46, 51 AND 52).

FIRST USE 2-16-2000; IN COMMERCE 2-16-2000.

CLASS 5—(Continued).

2,534,863. NORTH AMERICAN PHARMACAL/NATURAL PRODUCTS, INC., NORWALK, CT. SN 76-037,837. PUB. 3-6-2001, FILED 5-1-2000.

DEFLECT

FOR NUTRITIONAL SUPPLEMENTS (U.S. CLS. 6, 18, 44, 46, 51 AND 52).

FIRST USE 1-0-2000; IN COMMERCE 5-0-2000.

2,534,771. ECR PHARMACEUTICALS, RICHMOND, VA. SN 75-923,295. PUB. 12-26-2000, FILED 2-18-2000.

DexPak

FOR PHARMACEUTICAL PRODUCT, NAMELY, AN ORAL STEROID AND DEXAMETHASONE (U.S. CLS. 6, 18, 44, 46, 51 AND 52).

FIRST USE 2-7-2000; IN COMMERCE 4-4-2000.

2,534,801. SCA HYGIENE PRODUCTS AB, S-405 03 GOTE-BORG, SWEDEN. SN 75-981,012. PUB. 1-18-2000, FILED 1-14-1999.

TENA

OWNER OF U.S. REG. NO. 1,782,362.
FOR INCONTINENCE GARMENTS, NAMELY, DIAPERS AND PANTS, PRODUCTS FOR HYGIENE PURPOSES, NAMELY, SANITARY NAPKINS AND TOWELS, TAMPONS, POCKET PADS, DRESSING, COMPRESSES AND SWABS THAT ABSORB FECAL MATTER, URINE, BLOOD AND OTHER HUMAN SECRETIONS, DISPOSABLE CELLULOSE DIAPERS AND PANTS FOR INCONTINENCE SUFFERS (U.S. CLS. 6, 18, 44, 46, 51 AND 52).
FIRST USE 10-3-2000; IN COMMERCE 10-3-2000.

2,534,845. SALIX PHARMACEUTICALS, INC., RALEIGH, NC. SN 76-025,821. PUB. 6-5-2001, FILED 4-14-2000.

COLAZAL

FOR PHARMACEUTICAL PREPARATIONS FOR THE PREVENTION AND TREATMENT OF GASTROINTESTINAL DISEASES (U.S. CLS. 6, 18, 44, 46, 51 AND 52).
FIRST USE 12-11-2000; IN COMMERCE 12-11-2000.

2,534,876. TISHCON CORP., WESTBURY, NY. SN 76-046,187. PUB. 4-24-2001, FILED 5-11-2000.



FOR NUTRITIONAL SUPPLEMENTS (U.S. CLS. 6, 18, 44, 46, 51 AND 52).

FIRST USE 8-21-2001; IN COMMERCE 8-21-2001.

2,534,892. GRIFFIN L.L.C., VALDOSTA, GA. SN 76-059,008. PUB. 4-17-2001, FILED 5-30-2000.

AVAST!

FOR PESTICIDES AND HERBICIDES FOR AGRICULTURAL, COMMERCIAL AND DOMESTIC (U.S. CLS. 6, 18, 44, 46, 51 AND 52).

FIRST USE 2-0-1999; IN COMMERCE 8-0-2000.

2,534,911. NATURAL SUPPLEMENT ASSOCIATION, INC., DBA EXPERIMENTAL AND APPLIED SCIENCES, INC., GOLDEN, CO. SN 76-090,265. PUB. 4-17-2001, FILED 7-17-2000.

AEROMAX

FOR DIETARY AND NUTRITIONAL SUPPLEMENTS (U.S. CLS. 6, 18, 44, 46, 51 AND 52).
FIRST USE 8-26-2000; IN COMMERCE 8-26-2000.

CLASS 5—(Continued).

2,534,912. NATURAL SUPPLEMENT ASSOCIATION, INC., DBA EXPERIMENTAL AND APPLIED SCIENCES, GOLDEN, CO. SN 76-090,266. PUB. 4-17-2001, FILED 7-17-2000.

SYNTHEVOL

FOR DIETARY AND NUTRITIONAL SUPPLEMENTS (U.S. CLS. 6, 18, 44, 46, 51 AND 52).
FIRST USE 9-29-2000; IN COMMERCE 9-29-2000.

2,534,914. WILSON, COLLEEN G., SAN DIEGO, CA. SN 76-092,414. PUB. 5-8-2001, FILED 7-20-2000.

NIMBLE

FOR ANIMAL NUTRITIONAL SUPPLEMENTS (U.S. CLS. 6, 18, 44, 46, 51 AND 52).
FIRST USE 10-5-2000; IN COMMERCE 1-17-2001.

2,534,915. WILSON, COLLEEN G., SAN DIEGO, CA. SN 76-092,416. PUB. 5-8-2001, FILED 7-20-2000.

GLEAM & GAIN

FOR ANIMAL NUTRITIONAL SUPPLEMENTS (U.S. CLS. 6, 18, 44, 46, 51 AND 52).
FIRST USE 10-5-2000; IN COMMERCE 1-17-2001.

2,534,918. RED RAM PET NUTRITION, LLC, ST. LOUIS, MO. SN 76-096,706. PUB. 6-5-2001, FILED 7-26-2000.



FOR PET CARE PREPARATIONS FOR VETERINARY USE, NAMELY, PHARMACEUTICALS, DIETARY AND NUTRITIONAL SUPPLEMENTS, MEDICATED BREATH FRESHENERS, MULTI-VITAMINS, DIGESTIVE ENZYMES AND MEDICATED PREPARATIONS FOR THE TREATMENT OF ARTHRITIS (U.S. CLS. 6, 18, 44, 46, 51 AND 52).
FIRST USE 4-22-2001; IN COMMERCE 4-22-2001.

CLASS 5—(Continued).

2,534,941. PAN AMERICAN LABORATORIES, INC., COVINGTON, LA. SN 78-000,477. PUB. 12-26-2000, FILED 3-22-2000.

PANNAZ

FOR ANTIHISTAMINE/DECONGESTANT (U.S. CLS. 6, 18, 44, 46, 51 AND 52).
FIRST USE 2-1-1988; IN COMMERCE 2-1-1988.

2,534,982. GENETIC EVOLUTIONARY NUTRITION, LLC, MARINA DEL REY, CA. SN 78-026,706. PUB. 6-5-2001, FILED 9-19-2000.

THERMONOL XS

FOR DIETARY SUPPLEMENT (U.S. CLS. 6, 18, 44, 46, 51 AND 52).
FIRST USE 10-14-2001; IN COMMERCE 10-14-2001.

CLASS 6—METAL GOODS

2,534,364. TRUTH HARDWARE CORPORATION, OWATONNA, MN. SN 75-226,081. PUB. 11-4-1997, FILED 1-15-1997.

TRU BRIGHT

NO CLAIM IS MADE TO THE EXCLUSIVE RIGHT TO USE "BRIGHT", APART FROM THE MARK AS SHOWN. FOR METAL DOOR HARDWARE, NAMELY LOCKS, HANDLES, LATCHES AND LEVERSETS (U.S. CLS. 2, 12, 13, 14, 23, 25 AND 50).
FIRST USE 3-0-1998; IN COMMERCE 3-0-1998.

2,534,451. I.E.L. MANUFACTURING LTD., DELTA, BRITISH COLUMBIA, CANADA. SN 75-522,950. PUB. 10-3-2000, FILED 7-21-1998.

FUTURE TILE

PRIORITY CLAIMED UNDER SEC. 44(D) ON CANADA APPLICATION NO. 867401, FILED 1-26-1998.
NO CLAIM IS MADE TO THE EXCLUSIVE RIGHT TO USE "TILE", APART FROM THE MARK AS SHOWN. FOR METAL ROOFING PRODUCTS, NAMELY, ROOFING PANELS, SHINGLES, TILES, ACCESSORY TRIMS, AND MOLDINGS (U.S. CLS. 2, 12, 13, 14, 23, 25 AND 50).
FIRST USE 7-0-1998; IN COMMERCE 7-0-1998.

CLASS 6—(Continued).

2,534,452. I.E.L. MANUFACTURING LTD., DELTA, BRITISH COLUMBIA, CANADA. SN 75-522,951. PUB. 10-3-2000, FILED 7-21-1998.

CLASS 6—(Continued).

2,534,674. DUCOLON, BRUCE E., DBA JUST A MAILBOX, MIAMIVILLE, OH. SN 75-826,096. PUB. 12-19-2000, FILED 10-18-1999.

FUTURE SHAKE

PRIORITY CLAIMED UNDER SEC. 44(D) ON CANADA APPLICATION NO. 867400, FILED 1-26-1998.
 NO CLAIM IS MADE TO THE EXCLUSIVE RIGHT TO USE "SHAKE", APART FROM THE MARK AS SHOWN.
 FOR METAL ROOFING PRODUCTS, NAMELY ROOFING PANELS, SHINGLES, TILES, ACCESSORY TRIMS, AND MOLDINGS (U.S. CLS. 2, 12, 13, 14, 23, 25 AND 50).
 FIRST USE 7-0-1998; IN COMMERCE 7-0-1998.

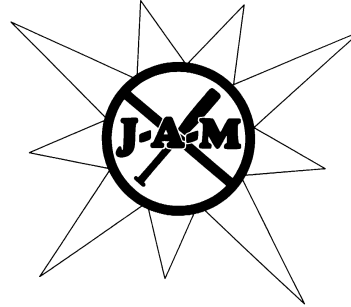

2,534,466. TYLER STEEL COMPANY, TYLER, TX. SN 75-549,909. PUB. 8-31-1999, FILED 9-8-1998.

THE MARK CONSISTS IN PART OF A BAT FOR RESIDENTIAL STEEL MAILBOXES HAVING A DECORATIVE SHAPE (U.S. CLS. 2, 12, 13, 14, 23, 25 AND 50).
 FIRST USE 4-10-2001; IN COMMERCE 4-10-2001.

WOODSTOCK

FOR METAL BRACKETS FOR STORAGE RACKS (U.S. CLS. 2, 12, 13, 14, 23, 25 AND 50).
 FIRST USE 6-5-2000; IN COMMERCE 8-11-2000.

2,534,760. KNOMARK, INC., AURORA, IL. SN 75-913,065. PUB. 9-26-2000, FILED 2-8-2000.

ANVIL

2,534,586. UNION METALS CO., LTD., 727 - 15, KOJAN-DONG NAMDONG-GU, INCHEON, REPUBLIC OF KOREA. SN 75-732,193. PUB. 5-16-2000, FILED 6-18-1999.

FOR HOUSEHOLD ALUMINUM FOIL (U.S. CLS. 2, 12, 13, 14, 23, 25 AND 50).
 FIRST USE 6-26-2000; IN COMMERCE 6-26-2000.

UNIX

THUNDERFORGED

FOR METAL GOODS, NAMELY, METAL CONTAINERS FOR THE STORAGE AND TRANSPORTATION OF HIGH COMPRESSED GAS, METAL STORAGE TANKS FOR PRESERVATION, AND MANUALLY OPERATED METAL VALVES (U.S. CLS. 2, 12, 13, 14, 23, 25 AND 50).
 FIRST USE 3-11-1999; IN COMMERCE 3-11-1999.

FOR FORGED STEEL FOR USE IN FABRICATING KNIFE BLADES AND PARTS (U.S. CLS. 2, 12, 13, 14, 23, 25 AND 50).
 FIRST USE 8-20-1999; IN COMMERCE 8-20-1999.

CLASS 7—MACHINERY

CLASS 7—(Continued).

2,534,356. BOWE SYSTEC AG, 86159 AUGSBURG, FED REP GERMANY. SN 75-165,249. PUB. 3-23-1999, FILED 9-13-1996.

BÖWE SYSTEC - THE PAPER MANAGEMENT COMPANY

PRIORITY CLAIMED UNDER SEC. 44(D) ON FED REP GERMANY APPLICATION NO. 39613129.8, FILED 3-19-1996, REG. NO. 39613129, DATED 7-5-1996, EXPIRES 3-31-2006.

NO CLAIM IS MADE TO THE EXCLUSIVE RIGHT TO USE "THE PAPER MANAGEMENT COMPANY", APART FROM THE MARK AS SHOWN.

FOR MACHINES FOR PROCESSING PRINTED PAPER, PLASTIC CARDS AND ENVELOPES AND PARTS THEREFOR, NAMELY, ENVELOPE INSTALLATIONS, SUPPLEMENT FEEDERS, FILLING STATIONS, SEQUENCE SORTERS, CUTTING MACHINES, SHEET FEEDERS, ENVELOPE FEEDERS, STREAM POCKETS, COLLECTION STATIONS, TACKING UNITS, FOLDING UNIT, AND TURNING UNITS; AND ELECTRONIC CONTROLLERS THEREFOR SOLD TOGETHER WITH THE ABOVE GOODS AS A UNIT (U.S. CLS. 13, 19, 21, 23, 31, 34 AND 35).

FIRST USE 3-31-1996; IN COMMERCE 3-31-1996.

2,534,479. NEXEN GROUP, INC., VADNASI HEIGHTS, MN, BY ASSIGNMENT HORTON, INC., MINNEAPOLIS, MN. SN 75-577,280. PUB. 11-2-1999, FILED 10-23-1998.

ECLIPSE

FOR CLUTCHES AND BRAKES FOR MACHINES (U.S. CLS. 13, 19, 21, 23, 31, 34 AND 35).

FIRST USE 7-30-1999; IN COMMERCE 7-30-1999.

2,534,484. PACIFIC INTERNATIONAL TOOL & SHEAR, LTD., KINGSTON, WA. SN 75-589,185. PUB. 1-9-2001, FILED 11-16-1998.

RAZORBACKER

FOR POWER TOOLS, NAMELY, RECIPROCATING SHEARS FOR CUTTING FIBER-CEMENT EXTERIOR SIDING MATERIALS USED IN CONSTRUCTION (U.S. CLS. 13, 19, 21, 23, 31, 34 AND 35).

FIRST USE 4-8-1999; IN COMMERCE 4-8-1999.

CLASS 7—(Continued).

2,534,486. KOREA PNEUMATIC SYSTEM CO., LTD., SEOUL, 153-030, REPUBLIC OF KOREA. SN 75-596,826. PUB. 12-26-2000, FILED 11-30-1998.



FOR AIR SUCTION MACHINES, COMPRESSED AIR PUMPS, CYLINDER FOR MACHINES, EJECTORS, PNEUMATIC TRANSPORTERS, MACHINE VACUUM PUMPS, VACUUM PADS FOR VACUUM PUMP MACHINES, MACHINE PARTS, NAMELY SHOCK ABSORBER PLUNGERS AND VALVES, INDUSTRIAL ROBOTS (U.S. CLS. 13, 19, 21, 23, 31, 34 AND 35).

FIRST USE 4-20-2001; IN COMMERCE 4-20-2001.

2,534,496. STINGER WELLHEAD PROTECTION, INC., ALLEN, TX. SN 75-606,752. PUB. 7-25-2000, FILED 12-16-1998.

STINGER

FOR TUBING HANGERS AND TUBING HEAD SPOOLS FOR USE IN THE OIL WELL, GAS WELL AND WATER WELL INDUSTRY AS COMPONENTS OF WELLHEADS MOUNTED TO DRILLED, CASED OIL, GAS AND WATER WELLS (U.S. CLS. 13, 19, 21, 23, 31, 34 AND 35).

FIRST USE 7-1-1999; IN COMMERCE 7-18-2001.

2,534,498. CHEM FINANCIAL, INC, OAKVILLE, ONTARIO, CANADA. SN 75-610,880. PUB. 6-6-2000, FILED 12-23-1998.

MICROSPERSE

FOR MACHINES, NAMELY, EMULSION MAKE DOWN SYSTEMS COMPRISED OF TANKS AND MIXERS, USED TO MIX EMULSIONS (U.S. CLS. 13, 19, 21, 23, 31, 34 AND 35).

FIRST USE 7-31-1999; IN COMMERCE 7-31-1999.

2,534,553. PRAXAIR TECHNOLOGY, INC., DANBURY, CT. SN 75-693,592. PUB. 5-8-2001, FILED 4-29-1999.

COJET

FOR INDUSTRIAL GAS INJECTION SYSTEMS COMPRISED OF INJECTOR NOZZLE ASSEMBLIES, GAS SUPPLY CONDUITS, CONTROL VALVES AND CONTROL COMPUTERS, ALL SOLD AS A UNIT, FOR USE IN METALS MANUFACTURING INDUSTRIES; AND REPLACEMENT PARTS THEREFOR (U.S. CLS. 13, 19, 21, 23, 31, 34 AND 35).

FIRST USE 12-31-2000; IN COMMERCE 12-31-2000.

CLASS 7—(Continued).

2,534,599. KENDRO LABORATORY PRODUCTS, L.P., NEW-TOWN, CT. SN 75-742,739. PUB. 2-15-2000, FILED 7-2-1999.

EVOLUTION

FOR CENTRIFUGES (U.S. CLS. 13, 19, 21, 23, 31, 34 AND 35).
FIRST USE 6-0-2001; IN COMMERCE 6-0-2001.

2,534,629. ADVANCE PRODUCTS CORPORATION, BENTON HARBOR, MI. SN 75-776,041. PUB. 11-28-2000, FILED 8-13-1999.

WINDOW TO THE WORLD

FOR DIE CASTING EQUIPMENT AND FOUNDRY EQUIPMENT, NAMELY, SHOT SLEEVES, PLUNGER TIPS, PLUNGER RODS, DIE CLAMPS, LADLERS AND LADLE CUPS, EXTRACTORS, LUBRICATORS, SPRAY SYSTEMS FOR RELEASING DIES, CONSISTING OF SPRAY HEADS AND SPRAY MANIFOLDS AND CONTROLLERS THEREFOR, RECLAIMERS FOR COLLECTING AND FILTERING RUN-OFF LUBRICANT, AND PARTS FOR ALL OF THE AFORESAID GOODS (U.S. CLS. 13, 19, 21, 23, 31, 34 AND 35).
FIRST USE 2-0-2001; IN COMMERCE 2-0-2001.

2,534,630. WINDSOR ACQUISITION LLC, MILAN, TN. SN 75-776,978. PUB. 2-22-2000, FILED 8-16-1999.

SPEED TIP

FOR GUIDE BARS FOR POWER OPERATED SAWS (U.S. CLS. 13, 19, 21, 23, 31, 34 AND 35).
FIRST USE 0-0-1980; IN COMMERCE 0-0-1980.

2,534,772. DEVILBISS AIR POWER COMPANY, JACKSON, TN. SN 75-925,244. PUB. 12-5-2000, FILED 2-9-2000.

SITE BOSS

FOR AIR COMPRESSORS (U.S. CLS. 13, 19, 21, 23, 31, 34 AND 35).
FIRST USE 10-0-2000; IN COMMERCE 10-0-2000.

CLASS 7—(Continued).

2,534,820. STEPPER, INC., OLATHE, KS. SN 76-006,441. PUB. 12-26-2000, FILED 3-21-2000.



OWNER OF U.S. REG. NO. 2,127,276 AND OTHERS. FOR NEWSPAPER HANDLING MACHINES, NAMELY, FEEDERS, HOPPERS, COLLATORS AND INSERTERS, FOLD TIERS, BAGGERS AND SEALERS (U.S. CLS. 13, 19, 21, 23, 31, 34 AND 35).
FIRST USE 4-21-2000; IN COMMERCE 3-23-2001.

2,534,921. WHITE CONSOLIDATED INDUSTRIES, INC., CLEVELAND, OH. SN 76-104,871. PUB. 4-24-2001, FILED 8-7-2000.



FOR VACUUM CLEANERS (U.S. CLS. 13, 19, 21, 23, 31, 34 AND 35).
FIRST USE 9-22-2000; IN COMMERCE 9-22-2000.

2,534,968. COSMOS VACCUM TECHNOLOGY CORPORATION, TAIPEI, TAIWAN. SN 78-014,834. PUB. 5-29-2001, FILED 6-28-2000.

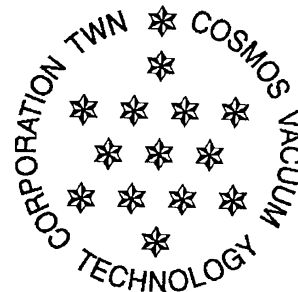

NO CLAIM IS MADE TO THE EXCLUSIVE RIGHT TO USE TECHNOLOGY CORPORATION, APART FROM THE MARK AS SHOWN.
FOR ROUTERS (U.S. CLS. 13, 19, 21, 23, 31, 34 AND 35).
FIRST USE 6-15-2000; IN COMMERCE 6-15-2000.

CLASS 7—(Continued).

2,534,985. WEST SALEM MACHINERY COMPANY, SALEM, OR. SN 78-033,540. PUB. 8-7-2001, FILED 11-2-2000.

THE BRUTE

FOR MACHINES USED FOR CHIPPING AND GRINDING COMMERCIAL AND INDUSTRIAL RECYCLABLE MATERIALS (U.S. CLS. 13, 19, 21, 23, 31, 34 AND 35).
FIRST USE 1-1-2001; IN COMMERCE 1-1-2001.

CLASS 8—HAND TOOLS

2,534,806. NATIONAL MANUFACTURING CO., STERLING, IL. SN 75-981,277. PUB. 12-19-2000, FILED 9-9-1999.



FOR HEX KEY WRENCHES (U.S. CLS. 23, 28 AND 44).
FIRST USE 11-0-1999; IN COMMERCE 11-0-1999.

CLASS 9—ELECTRICAL AND SCIENTIFIC APPARATUS

2,534,368. LEAPFROG ENTERPRISES, INC., EMERYVILLE, CA. BY CHANGE OF NAME; ASSIGNEE OF; BY ASSIGNMENT KNOWLEDGE KIDS ENTERPRISES, INC., LOS ANGELES, CA. SN 75-239,425. PUB. 9-15-1998, FILED 2-10-1997.

LEAPFROG

OWNER OF U.S. REG. NO. 1,306,993.
FOR SOFTWARE GAMES FOR CHILDREN (U.S. CLS. 21, 23, 26, 36 AND 38).
FIRST USE 2-1-1998; IN COMMERCE 8-16-1999.

2,534,369. KNOWLEDGE KIDS ENTERPRISES, INC., LOS ANGELES, CA. SN 75-239,516. PUB. 11-3-1998, FILED 2-10-1997.

LEAPFROG

OWNER OF U.S. REG. NO. 1,306,993.
FOR EDUCATIONAL SOFTWARE FOR CHILDREN FEATURING THE DEVELOPMENT OF READING, MATHEMATICS, SCIENCE, LANGUAGE AND OTHER ACADEMIC SKILLS (U.S. CLS. 21, 23, 26, 36 AND 38).
FIRST USE 2-1-1998; IN COMMERCE 8-16-1999.

CLASS 9—(Continued).

2,534,376. INSYNC SYSTEMS, INC., MILPITAS, CA. SN 75-253,968. PUB. 3-30-1999, FILED 3-6-1997.

VERSA PLANE

NO CLAIM IS MADE TO THE EXCLUSIVE RIGHT TO USE "PLANE", APART FROM THE MARK AS SHOWN.
FOR RECONFIGURABLE GAS CONTROL SYSTEMS SUBASSEMBLIES, NAMELY, MOUNTING PLANES AND SUPPORTS THEREFOR USED IN THE MANUFACTURE OF SEMICONDUCTOR COMPONENTS (U.S. CLS. 21, 23, 26, 36 AND 38).
FIRST USE 6-20-2001; IN COMMERCE 6-20-2001.

2,534,389. ACE WORLD COMPANIES, INC., FORT WORTH, TX. SN 75-330,625. PUB. 7-4-2000, FILED 7-25-1997.

ACE-TRONICS

FOR ELECTRONIC CONTROLLER FOR USE IN AN ELECTRONIC OVERHEAD HOIST (U.S. CLS. 21, 23, 26, 36 AND 38).
FIRST USE 1-2-1998; IN COMMERCE 1-2-1998.

2,534,391. HELIX TECHNOLOGY CORPORATION, MANSFIELD, MA. SN 75-334,856. PUB. 5-19-1998, FILED 8-4-1997.

CONDUCTRON

OWNER OF U.S. REG. NO. 1,954,345.
FOR VACUUM GAUGES, NAMELY, GAUGE TUBES AND VACUUM GAUGE CONTROLLERS USED IN THE MEASUREMENT OF VACUUMS (U.S. CLS. 21, 23, 26, 36 AND 38).
FIRST USE 4-10-2001; IN COMMERCE 4-10-2001.

2,534,393. CADENCE DESIGN SYSTEMS, INC., SAN JOSE, CA. SN 75-350,883. PUB. 3-16-1999, FILED 9-3-1997.

SPECCTRAQUEST

FOR COMPUTER SOFTWARE FOR THE DESIGN, TESTING, FABRICATION AND INSTALLATION OF INTEGRATED CIRCUITS, SEMICONDUCTORS, CIRCUIT BOARDS AND ELECTRONIC PRODUCTS (U.S. CLS. 21, 23, 26, 36 AND 38).
FIRST USE 3-31-1998; IN COMMERCE 3-31-1998.

CLASS 9—(Continued).

2,534,396. PHILIPS ELECTRONICS NORTH AMERICA CORPORATION, NEW YORK, NY. BY MERGER; BY MERGER VOICE CONTROL SYSTEMS, INC., DALLAS, TX. SN 75-370,183. PUB. 12-14-1999, FILED 10-8-1997.

SPEECHWAVE

FOR COMPUTER SOFTWARE FOR USE IN SPEECH RECOGNITION APPLICATIONS (U.S. CLS. 21, 23, 26, 36 AND 38).

FIRST USE 5-31-2000; IN COMMERCE 5-31-2000.

2,534,399. BROKAT INFORMATIONSSYSTEME GMBH, BOBLINGEN, FED REP GERMANY. SN 75-373,689. PUB. 1-11-2000, FILED 10-15-1997.

**BROKAT**

THE DESIGN PORTION OF THE MARK CONSISTS OF A PATTERN OF THREE SQUARES, ONE ABOVE THE OTHER.

FOR COMPUTER PROGRAMS FOR DATA PROCESSING USE IN THE BANKING, FINANCIAL, TELECOMMUNICATIONS INDUSTRIES AND THE HEALTH AND GOVERNMENT SECTORS; COMPUTER SOFTWARE FOR THE DESIGN AND DEVELOPMENT OF COMPUTER SOFTWARE INTERFACES AND FOR DELIVERY OF ELECTRONIC SERVICES VIA GLOBAL COMPUTER NETWORKS, ENCRYPTION COMPUTER SOFTWARE FOR INTEGRITY PROTECTION AND SECURITY PURPOSES AND DIGITAL SIGNATURE AUTHENTICATION AND REPUDIATION, COMPUTER SOFTWARE FOR VIRUS PROTECTION, DATA PROCESSORS; GENERAL ELECTRONIC PURPOSE SECURE COMPUTER PLATFORMS; COMPUTERS AND COMPUTER COMPONENTS, NAMELY, SERVERS, COMPUTER INTERFACE BOARDS, CRYPTO ACCELERATORS/PROCESSORS AND MODEMS FOR USE IN THE BANKING, FINANCIAL, TELECOMMUNICATIONS INDUSTRIES AND THE HEALTH AND GOVERNMENT SECTORS, MAGNETIC AND OPTICAL STORAGE MEDIA, NAMELY, SMART CARDS, CD-ROMS, COMPUTER DISCS, FLOPPY DISCS AND STREAMERS, COMPUTER COMPONENTS, NAMELY, FIRE WALLS, PCMICA ADAPTORS, BRIDGES, ROUTERS AND HUBS AND COMPUTER OPERATING PROGRAMS FOR CREATING, MAINTAINING AND SERVICING ELECTRONIC TRANSACTIONS AND DATA INTERCHANGE FOR THE BANKING, FINANCIAL AND TELECOMMUNICATIONS INDUSTRIES AND THE HEALTH AND GOVERNMENT SECTORS (U.S. CLS. 21, 23, 26, 36 AND 38).

FIRST USE 10-0-1994; IN COMMERCE 2-0-1995.

CLASS 9—(Continued).

2,534,405. BARAZZOTTO, ZOT, DBA TETON TECHNOLOGY, XENIA, OH. SN 75-396,253. PUB. 4-13-1999, FILED 11-25-1997.

MICROCLEAR

FOR SOFTWARE FEATURING ALGORITHMS FOR REGULATING AND CONTROLLING HEARING AIDS (U.S. CLS. 21, 23, 26, 36 AND 38).

FIRST USE 5-22-2001; IN COMMERCE 5-22-2001.

2,534,429. COACH, INC., NEW YORK, NY. SN 75-471,782. PUB. 1-5-1999, FILED 4-21-1998.



OWNER OF U.S. REG. NOS. 1,309,779, 2,088,706, AND OTHERS.

FOR EYEGLASSES, EYEGLASS FRAMES, SUNGLASSES (U.S. CLS. 21, 23, 26, 36 AND 38).

FIRST USE 11-18-1999; IN COMMERCE 11-18-1999.

2,534,435. SCHRADER-BRIDGEPORT INTERNATIONAL, INC., DEERFIELD, IL. SN 75-483,896. PUB. 6-13-2000, FILED 5-12-1998.

SCHRADER SMART VALVE

OWNER OF U.S. REG. NOS. 173,962 AND 174,164.

NO CLAIM IS MADE TO THE EXCLUSIVE RIGHT TO USE "SMART VALVE", APART FROM THE MARK AS SHOWN.

FOR TIRE PRESSURE MONITORING SYSTEM COMPRISED MAINLY OF A DASHBOARD DISPLAY, RADIO RECEIVER, WHEEL SENSOR, AND AUDIBLE ALARM (U.S. CLS. 21, 23, 26, 36 AND 38).

FIRST USE 11-0-1998; IN COMMERCE 11-0-1998.

2,534,447. HUNTER FAN COMPANY, MEMPHIS, TN. SN 75-511,187. PUB. 6-8-1999, FILED 6-30-1998.



FOR THERMOSTATS FOR USE IN RESIDENTIAL, COMMERCIAL AND INDUSTRIAL BUILDINGS (U.S. CLS. 21, 23, 26, 36 AND 38).

FIRST USE 1-1-2000; IN COMMERCE 3-1-2000.

CLASS 9—(Continued).

2,534,449. INTERNATIONAL SPACE OPTICS, S.A., IRVINE, CA. SN 75-519,045. PUB. 6-1-1999, FILED 7-15-1998.

RAINBOW

OWNER OF U.S. REG. NO. 1,892,002.
 FOR ELECTRONIC MULTIPLEXER UNITS, MOTORIZED PAN AND TILT UNITS FOR MOVING TELEVISION CAMERAS, ELECTRONIC QUAD UNITS FOR SPLITTING IMAGES DISPLAYED ON TELEVISION MONITORS, ELECTRONIC SWITCHER UNITS, AND VIDEO RECORDERS, ALL FOR USE FOR CLOSED CIRCUIT TELEVISION; AND CLOSED CIRCUIT TELEVISION SURVEILLANCE SYSTEMS COMPRISED OF TELEVISION CAMERAS AND MONITORS, ELECTRONIC MULTIPLEXER UNITS, MOTORIZED PAN AND TILT UNITS FOR MOVING TELEVISION CAMERAS, ELECTRONIC QUAD UNITS FOR SPLITTING IMAGES DISPLAYED ON TELEVISION MONITORS, ELECTRONIC SWITCHER UNITS, AND VIDEO RECORDERS (U.S. CLS. 21, 23, 26, 36 AND 38).
 FIRST USE 6-0-1999; IN COMMERCE 6-0-1999.

2,534,453. MINDBRIDGE.COM, INC., FORT WASHINGTON, PA. SN 75-524,246. PUB. 6-1-1999, FILED 7-23-1998.

INTRASMART

FOR COMPUTER SOFTWARE FOR DESIGNING, CREATING, EDITING, TESTING AND MAINTAINING LOCAL AREA INFORMATION NETWORKS (U.S. CLS. 21, 23, 26, 36 AND 38).
 FIRST USE 7-0-1999; IN COMMERCE 7-0-1999.

2,534,457. INSIGHT IMAGING, INC., SCOTTSDALE, AZ. SN 75-538,034. PUB. 7-27-1999, FILED 8-17-1998.

IMAGEBALL

FOR HAND-HELD VIEWER FOR VIEWING PHOTOGRAPHIC SLIDES AND TRANSPARENCIES (U.S. CLS. 21, 23, 26, 36 AND 38).
 FIRST USE 11-1-2000; IN COMMERCE 11-1-2000.

2,534,460. KLA-TENCOR CORPORATION, SAN JOSE, CA. SN 75-539,363. PUB. 1-25-2000, FILED 8-20-1998.

INTEGRATOR

FOR COMPUTER SOFTWARE FOR YIELD MANAGEMENT IN SEMICONDUCTOR MANUFACTURING AND TESTING (U.S. CLS. 21, 23, 26, 36 AND 38).
 FIRST USE 12-10-1993; IN COMMERCE 12-10-1993.

CLASS 9—(Continued).

2,534,464. GUILLEMOT INTERNATIONAL INC., MONTREAL, QUEBEC H2T 1S6, CANADA. SN 75-543,370. PUB. 8-17-1999, FILED 8-26-1998.

MAXI GAMER PHOENIX

NO CLAIM IS MADE TO THE EXCLUSIVE RIGHT TO USE "GAMER", APART FROM THE MARK AS SHOWN. FOR VIDEO CARDS (U.S. CLS. 21, 23, 26, 36 AND 38).
 FIRST USE 10-0-1998; IN COMMERCE 10-0-1998.

2,534,476. UNIVERSAL LIGHTING TECHNOLOGIES, INC., NASHVILLE, TN, BY ASSIGNMENT MAGNETEK, INC., NASHVILLE, TN. SN 75-568,860. PUB. 11-7-2000, FILED 10-13-1998.

ACCUSTART

FOR LIGHTING BALLASTS (U.S. CLS. 21, 23, 26, 36 AND 38).
 FIRST USE 10-9-1998; IN COMMERCE 10-9-1998.

2,534,477. KENT COMPUTER CONSULTANTS LIMITED, HADLOW, TONBRIDGE, KENT TN11 0EF, UNITED KINGDOM. SN 75-569,012. PUB. 7-18-2000, FILED 10-13-1998.

REBUS

FOR COMPUTER SOFTWARE (U.S. CLS. 21, 23, 26, 36 AND 38).
 FIRST USE 1-0-1995; IN COMMERCE 0-0-1996.

2,534,478. CRYSTAL DYNAMICS, INC., MENLO PARK, CA. SN 75-576,197. PUB. 2-29-2000, FILED 10-23-1998.

GEX

OWNER OF U.S. REG. NOS. 2,027,967, 2,074,572, AND 2,166,622.
 FOR VIDEO GAME CARTRIDGES, COMPUTER GAME CASSETTES (U.S. CLS. 21, 23, 26, 36 AND 38).
 FIRST USE 3-0-1995; IN COMMERCE 3-0-1995.

2,534,487. MUGLER, ALFRED, 82362 WEILHEIM, FED REP GERMANY. SN 75-597,158. PUB. 4-11-2000, FILED 11-30-1998.

TAXOBASE

FOR COMPUTER PROGRAMS FOR USE IN DATA BASE MANAGEMENT FOR GENERAL USE (U.S. CLS. 21, 23, 26, 36 AND 38).
 FIRST USE 7-3-2001; IN COMMERCE 7-3-2001.

CLASS 9—(Continued).

2,534,488. MUGLER, ALFRED, 82362 WEILHEIM, FED REP GERMANY. SN 75-597,159. PUB. 4-11-2000, FILED 11-30-1998.

NEVER BEFORE HAS IT BEEN SO EASY TO FIND EXACTLY WHAT YOU WANT

FOR COMPUTER PROGRAMS FOR USE AS SEARCH ENGINES, FOR USE IN DATA BASE MANAGEMENT FOR GENERAL USE, AND FOR USE IN DEVELOPING, DESIGNING AND IMPLEMENTING WEBSITES (U.S. CLS. 21, 23, 26, 36 AND 38).

FIRST USE 7-3-2001; IN COMMERCE 7-3-2001.

2,534,497. ACT. INC., IOWA CITY, IA. SN 75-609,041. PUB. 5-29-2001, FILED 12-21-1998.

INTERACTIVE UNIVERSITY

NO CLAIM IS MADE TO THE EXCLUSIVE RIGHT TO USE "INTERACTIVE", APART FROM THE MARK AS SHOWN.

FOR FEATURE OF COMPUTER SOFTWARE FOR PREPARATION FOR COLLEGE ADMISSIONS TESTING THAT PRODUCES A SIMULATED UNIVERSITY CAMPUS (U.S. CLS. 21, 23, 26, 36 AND 38).

FIRST USE 10-16-1998; IN COMMERCE 4-2-1999.

2,534,515. DALY.COMMERCE, INC., PROVIDENCE, RI. SN 75-642,328. PUB. 7-25-2000, FILED 2-17-1999.

DALY.COMMERCE

FOR COMPUTER SOFTWARE FOR USE IN THE MANUFACTURE AND WHOLESALE DISTRIBUTION OF MERCHANDISE, NAMELY, CUSTOMER SERVICES, INVENTORY MANAGEMENT, WAREHOUSE MANAGEMENT AND FINANCIAL APPLICATIONS (U.S. CLS. 21, 23, 26, 36 AND 38).

FIRST USE 10-1-1998; IN COMMERCE 10-1-1998.

2,534,517. DALY.COMMERCE, INC., PROVIDENCE, RI. SN 75-643,355. PUB. 7-25-2000, FILED 2-17-1999.

DALY.COMMERCE ENTERPRISE SOFTWARE@WORK

NO CLAIM IS MADE TO THE EXCLUSIVE RIGHT TO USE "ENTERPRISE SOFTWARE", APART FROM THE MARK AS SHOWN.

FOR COMPUTER SOFTWARE FOR USE IN THE MANUFACTURE AND WHOLESALE DISTRIBUTION OF MERCHANDISE, NAMELY, CUSTOMER SERVICE, INVENTORY MANAGEMENT, WAREHOUSE MANAGEMENT AND FINANCIAL APPLICATIONS (U.S. CLS. 21, 23, 26, 36 AND 38).

FIRST USE 10-1-1998; IN COMMERCE 10-1-1998.

CLASS 9—(Continued).

2,534,529. NEC AMERICA, INC., MELVILLE, NY. SN 75-661,638. PUB. 11-30-1999, FILED 3-16-1999.

ELITEMAIL VMS

NO CLAIM IS MADE TO THE EXCLUSIVE RIGHT TO USE "VMS", APART FROM THE MARK AS SHOWN.

FOR TELECOMMUNICATIONS EQUIPMENT, NAMELY, A VOICEMAIL SYSTEM COMPRISED OF TELECOMMUNICATIONS HARDWARE IN THE NATURE OF TELEPHONES, TELEPHONE RECEIVERS AND TRANSMITTERS, MULTIPLEXERS, SWITCHES AND MODEMS, COMPUTER HARDWARE AND COMPUTER SOFTWARE USED IN OPERATING VOICEMAIL SYSTEMS, AND INSTRUCTION MANUALS, SOLD AS A UNIT (U.S. CLS. 21, 23, 26, 36 AND 38).

FIRST USE 11-0-1998; IN COMMERCE 11-0-1998.

2,534,530. HEALTHFUSION.COM INC., SOLANA BEACH, CA, BY MERGER TBIC LLC, SAN DIEGO, CA. SN 75-666,416. PUB. 9-5-2000, FILED 3-23-1999.

HEALTHFUSION

FOR COMPUTER SOFTWARE THAT USES BROWSER TECHNOLOGY TO PROVIDE INTERACTIVE INFORMATION SYSTEMS, THE FUNCTION OF WHICH IS, NAMELY, TO AID IN THE DETERMINATION OF PATIENT ELIGIBILITY FOR MEDICAL BENEFITS AND IN THE COORDINATION OF PATIENT REFERRALS AND PROVIDER CLAIMS, AND TO PROVIDE INFORMATION RELATING TO PROVIDERS, LABORATORY AND PHARMACY DATA, MEDICAL AND OPTICAL SUPPLIES AND INVENTORY AND MEDICAL QUALITY MAINTENANCE (U.S. CLS. 21, 23, 26, 36 AND 38).

FIRST USE 1-0-2000; IN COMMERCE 1-0-2000.

2,534,535. ACCURATE METERING SYSTEMS, INC., SCHAUMBURG, IL. SN 75-674,216. PUB. 1-9-2001, FILED 4-5-1999.

ACCU MASS

FOR FLOW METER FOR CONTINUOUSLY MEASURING THE MASS OF LIQUID FLOWING IN A PROCESS PIPELINE USED IN THE CARBONATED BEVERAGE INDUSTRY (U.S. CLS. 21, 23, 26, 36 AND 38).

FIRST USE 8-30-2001; IN COMMERCE 8-30-2001.

2,534,536. ACCURATE METERING SYSTEMS, INC., SCHAUMBURG, IL. SN 75-674,217. PUB. 8-8-2000, FILED 4-5-1999.

ACCU-CARB

FOR BEVERAGE CARBONATION SYSTEM COMPRISING AT LEAST ONE FLOW METER, AT LEAST ONE REGULATOR, AT LEAST ONE FLOW CONTROL VALVE, A SPARGER AND A STATIC MIXER MOUNTED IN A CONDUIT (U.S. CLS. 21, 23, 26, 36 AND 38).

FIRST USE 3-1-1999; IN COMMERCE 4-28-2000.

CLASS 9—(Continued).

2,534,540. CASCADE MICROTECH, INC., BEAVERTON, OR. SN 75-684,857. PUB. 2-29-2000, FILED 4-19-1999.

MICROSCRUB

FOR MEMBRANE-TYPE ELECTRICAL PROBES FOR TESTING INTEGRATED CIRCUITS ON SEMICONDUCTOR WAFERS (U.S. CLS. 21, 23, 26, 36 AND 38). FIRST USE 10-3-2001; IN COMMERCE 10-6-2001.

2,534,546. LXE INC., NORCROSS, GA. SN 75-688,292. PUB. 12-28-1999, FILED 4-21-1999.

SPIRE

FOR ANTENNAS FOR WIRELESS COMMUNICATION APPLICATIONS (U.S. CLS. 21, 23, 26, 36 AND 38). FIRST USE 12-14-1998; IN COMMERCE 3-15-1999.

2,534,548. INCENTIA DESIGN SYSTEMS, INC., SANTA CLARA, CA. SN 75-688,641. PUB. 12-28-1999, FILED 4-22-1999.

DESIGNCRAFT

FOR ELECTRONIC DESIGN AUTOMATION SOFTWARE FOR THE DESIGN AND DEVELOPMENT OF MICROCHIPS (U.S. CLS. 21, 23, 26, 36 AND 38). FIRST USE 3-31-2000; IN COMMERCE 5-18-2000.

2,534,550. LILLY SOFTWARE ASSOCIATES, INC., HAMPTON, NH. SN 75-690,714. PUB. 8-22-2000, FILED 4-23-1999.

VISUAL ORDER MANAGEMENT

NO CLAIM IS MADE TO THE EXCLUSIVE RIGHT TO USE "ORDER MANAGEMENT", APART FROM THE MARK AS SHOWN.

FOR COMPUTER SOFTWARE USED BY MANUFACTURING, WHOLESALING, STORAGE, TRANSPORTATION, AND RETAILING BUSINESSES FOR SCHEDULING MATERIALS, RESOURCES, AND TRANSPORTATION, FOR PLANNING OPERATIONS, UNIT SALES GOALS, AND INVENTORY REPLENISHMENT, FOR BOOKKEEPING, AND FOR INVENTORY TRACKING (U.S. CLS. 21, 23, 26, 36 AND 38). FIRST USE 5-17-1999; IN COMMERCE 5-17-1999.

CLASS 9—(Continued).

2,534,555. BANDWIDTH9, INC., FREMONT, CA. SN 75-694,530. PUB. 1-16-2001, FILED 4-30-1999.

BANDWIDTH9

FOR OPTICAL NETWORKING COMPONENTS AND SUBSYSTEMS FOR TELECOMMUNICATIONS AND DATA COMMUNICATIONS, NAMELY TUNABLE LASERS, DETECTORS, FILTERS, ATTENUATORS, OPTICAL AMPLIFIERS, LOCKERS, VCSEL (VERTICAL CAVITY SURFACE EMITTING LASERS), RESONANT CAVITY DETECTOR, OPTICAL MEMS (MICRO-ELECTROMECHANICAL SYSTEMS), OPTICAL CROSS CONNECTS, WDM (WAVELENGTH DIVISION MULTIPLEXING) MULTIPLEXER, AND DEMULTIPLEXER, OPTICAL PROCESSOR, PHOTONIC SWITCH, ROUTER, CONVERTER, OPTICAL INTERLEVER, SPECTROMETER, OPTICAL INTERCONNECTS, DFB (DISTRIBUTED FEED BACK) AND DBR (DISTRIBUTING BRAGG REFLECTOR) LASERS, APD (AVALANCHE PHOTODIODE), SOA (SEMI-CONDUCTOR OPTICAL AMPLIFIER) AND EDFA (ERBIUM DOPED FIBER AMPLIFIER) (U.S. CLS. 21, 23, 26, 36 AND 38). FIRST USE 2-0-1998; IN COMMERCE 2-0-2001.

2,534,556. HDR POWER SYSTEMS, INC., COLOMBUS, OH. SN 75-695,828. PUB. 4-18-2000, FILED 4-30-1999.



OWNER OF U.S. REG. NO. 1,251,583.
FOR CUSTOMIZED ELECTRIC POWER CONTROLS FOR CONTROLLING POWER TO MACHINERY, NAMELY, AUTOCLAVES, ELECTRIC DRYERS, FURNACES, KILNS, OVENS, ENVIRONMENTAL CHAMBERS, EXTRUDERS, MOLDING EQUIPMENT, PAINT DRYING EQUIPMENT, PAPER DRYERS, INFRARED HEATERS, CERAMIC MELTERS, GLASS FOREHEARTH MELTERS, ELECTOCHEMICAL RECTIFIERS, AND HEAT SEALERS; POWER CONTROL SYSTEMS, NAMELY, CONTROLLERS FOR REGULATING, MEASURING, FILTERING, AND DISTRIBUTING ELECTRICAL CURRENT FOR RESISTANCE HEATING APPLICATIONS; AND ELECTRICAL POWER SUPPLIES (U.S. CLS. 21, 23, 26, 36 AND 38). FIRST USE 11-0-1999; IN COMMERCE 11-0-1999.

2,534,562. CABOT SAFETY INTERMEDIATE CORPORATION, NEWARK, DE. SN 75-701,872. PUB. 3-14-2000, FILED 5-10-1999.

BLASTS

FOR PERSONAL HEARING PROTECTIVE DEVICES, NAMELY, EAR PLUGS NOT FOR MEDICAL USE (U.S. CLS. 21, 23, 26, 36 AND 38). FIRST USE 9-0-1999; IN COMMERCE 9-0-1999.

CLASS 9—(Continued).

2,534,578. BACOU USA SAFETY, INC., SMITHFIELD, RI. SN 75-719,249. PUB. 2-15-2000, FILED 6-2-1999.

FALCON

FOR SAFETY EYEWEAR, NAMELY, SPECTACLES, FRAMES AND LENSES THEREFOR (U.S. CLS. 21, 23, 26, 36 AND 38).

FIRST USE 6-30-2001; IN COMMERCE 6-30-2001.

2,534,581. C LEVEL DESIGN, INC., SAN JOSE, CA. SN 75-721,444. PUB. 1-11-2000, FILED 6-4-1999.

C2V

FOR COMPUTER PROGRAMS FOR ELECTRONIC DESIGN OF COMPUTER HARDWARE AND ELECTRONIC SYSTEMS (U.S. CLS. 21, 23, 26, 36 AND 38).

FIRST USE 11-30-1999; IN COMMERCE 11-30-1999.

2,534,595. INTELLISEEK INC., CINCINNATI, OH. SN 75-739,969. PUB. 11-21-2000, FILED 6-30-1999.

BULLSEYE PRO

OWNER OF U.S. REG. NO. 2,298,993.
FOR COMPUTER SOFTWARE FOR SEARCHING, TRACKING AND RETRIEVING INFORMATION FROM A LOCAL AND GLOBAL COMPUTER NETWORK AND USER MANUALS SOLD THEREWITH (U.S. CLS. 21, 23, 26, 36 AND 38).

FIRST USE 9-1-1998; IN COMMERCE 9-1-1998.

2,534,598. ACUSON CORPORATION, MOUNTAIN VIEW, CA. SN 75-741,239. PUB. 2-6-2001, FILED 7-1-1999.

PERSPECTIVE

FOR SOFTWARE FOR PROCESSING IMAGES FROM ULTRASONIC MEDICAL DIAGNOSTIC APPARATUS AND THE USER MANUALS SOLD THEREWITH (U.S. CLS. 21, 23, 26, 36 AND 38).

FIRST USE 11-29-1998; IN COMMERCE 11-29-1998.

CLASS 9—(Continued).

2,534,606. INTERSIL AMERICAS INC., IRVINE, CA, BY ASSIGNMENT; BY ASSIGNMENT; BY ASSIGNMENT INTERSIL CORPORATION, PALM BAY, FL. SN 75-746,727. PUB. 8-8-2000, FILED 7-8-1999.



OWNER OF U.S. REG. NO. 1,014,040.
FOR SEMICONDUCTORS; INTEGRATED CIRCUITS, NAMELY, CIRCUITS CONTAINING TRANSISTORS OR OTHER SEMICONDUCTOR DEVICES USED IN CIRCUITS FOR COMPUTERS, WIRED AND WIRELESS COMMUNICATIONS, ELECTRONIC NETWORKS, DIGITAL AND ANALOG ELECTRONIC CIRCUITS, MICROPROCESSORS, MICROCONTROLLERS, DIGITAL SIGNAL PROCESSORS, PROGRAMMABLE LOGIC CIRCUITS, MEMORY CIRCUITS, POWER CONTROL CIRCUITS, AMPLIFIERS AND POWER CONVERTERS, ANALOG AND DIGITAL CONVERTERS; POWER SEMICONDUCTORS, NAMELY, MOSFETS, AND DIODE ARRAYS; ELECTRONIC CIRCUIT BOARDS AND ASSEMBLED ELECTRONIC MODULES CONTAINING SAID INTEGRATED CIRCUITS AND POWER TELECOMMUNICATION DEVICES; CIRCUIT BOARDS FOR TELEPHONES, WIRELESS COMMUNICATION, RADIO, TELEVISION AND TELEPHONE TRANSMISSION AND RECEPTION, DATA RECORDING AND STORAGE MEDIA; COMPUTER SOFTWARE, NAMELY, UTILITY PROGRAMS FOR USE WITH THE ABOVE GOODS, AND APPLICATION SOFTWARE FOR ENABLING TRANSMISSION, RECEPTION, RECORDING AND STORAGE OF DATA TRANSMITTED OVER TELEPHONES, WIRELESS COMMUNICATION, RADIO, TELEVISION AND TELEPHONE TRANSMISSION AND RECEPTION, DATA RECORDING AND STORAGE MEDIA; COMPUTER SOFTWARE FOR USE IN MANUFACTURE OF SEMICONDUCTORS, NAMELY, FOR PROCESS, CONTROL, YIELD ENHANCEMENT, AS WELL AS PROCESS AND CIRCUIT DESIGN; ELECTRONIC COMPONENTS, NAMELY, HYBRID ELECTRONIC CIRCUITS, CIRCUIT BOARDS, INTEGRATED CIRCUIT PACKAGES, AND LEAD FRAMES USED IN MANUFACTURING SEMICONDUCTORS, AND USER MANUALS SOLD WITH THE ABOVE GOODS (U.S. CLS. 21, 23, 26, 36 AND 38).

FIRST USE 8-0-1999; IN COMMERCE 8-0-1999.

2,534,635. IGT, RENO, NV. SN 75-783,769. PUB. 5-8-2001, FILED 8-24-1999.

NEON NIGHTS

FOR GAMING MACHINES; NAMELY, SLOT MACHINES WITH OR WITHOUT A VIDEO OUTPUT (U.S. CLS. 21, 23, 26, 36 AND 38).

FIRST USE 12-20-2000; IN COMMERCE 4-30-2001.

CLASS 9—(Continued).

2,534,640. CALLOUT PUBLISHING, L.L.C., DRAPER, UT. SN 75-793,236. PUB. 11-28-2000, FILED 9-7-1999.

LETTERPRO

FOR COMPUTER SOFTWARE FOR LETTER PREPARATION IN THE FIELD OF NETWORK MARKETING BUSINESS ENDEAVORS (U.S. CLS. 21, 23, 26, 36 AND 38).

FIRST USE 11-0-1998; IN COMMERCE 11-0-1998.

2,534,641. CRUME, RICK, GLYNDON, MN. SN 75-794,269. PUB. 7-17-2001, FILED 10-26-1998.

ONELIBRARY.COM

FOR COMPUTER CD-ROMS THAT PROVIDE INFORMATION CONSISTING OF LISTS OF LIBRARY HOLDINGS, SUCH AS BOOKS, PERIODICALS, MANUSCRIPTS, MICROFORMS AND CD-ROMS; LIBRARY PROFILES AND GUIDES, AND AIDS FOR USING LIBRARIES (U.S. CLS. 21, 23, 26, 36 AND 38).

FIRST USE 6-4-1999; IN COMMERCE 6-4-1999.

2,534,642. GRAYWOLF SENSING SOLUTIONS, L.T.D., NORWALK, CT. SN 75-795,602. PUB. 11-28-2000, FILED 9-9-1999.

DIRECTSENSE

FOR ENVIRONMENTAL AND SCIENTIFIC TESTING AND MONITORING EQUIPMENT, NAMELY, INDOOR AIR QUALITY MONITORS AND COMPUTER SOFTWARE FOR USE IN MEASURING CARBON DIOXIDE, CARBON MONOXIDE, RELATIVE HUMIDITY, DEWPOINT AND TEMPERATURE, MONITORING, CALCULATING, DOCUMENTING, DIAGNOSING INDOOR AIR QUALITY; TEMPERATURE ANALYZERS, HUMIDITY ANALYZERS, GAS ANALYZERS, CARBON MONOXIDE ANALYZERS, CARBON DIOXIDE ANALYZERS; ENVIRONMENTAL MONITORS, DEWPOINT MONITORS, TEMPERATURE MONITORS, GAS MONITORS, CARBON MONOXIDE MONITORS, CARBON DIOXIDE MONITORS, HAND-HELD MONITORS; ENVIRONMENTAL PROBES, HUMIDITY PROBES, DEWPOINT PROBES, GAS PROBES, CARBON MONOXIDE PROBES, CARBON DIOXIDE PROBES, TEMPERATURE PROBES, SURFACE TEMPERATURE PROBES, INSERTION TEMPERATURE PROBES; ENVIRONMENTAL SENSORS, TEMPERATURE SENSORS, HUMIDITY SENSORS, DEWPOINT SENSORS, GAS SENSORS CARBON MONOXIDE SENSORS, CARBON DIOXIDE SENSORS; DATA ACQUISITION SYSTEMS CONSISTING OF RECORDERS, DATALOGGERS, COMPUTER TERMINALS, DIGITAL INPUT/OUTPUT INTERFACES, COMPUTER PRINTERS; MICROPROCESSOR OPERATED DATA PROCESSORS (U.S. CLS. 21, 23, 26, 36 AND 38).

FIRST USE 9-1-1998; IN COMMERCE 2-3-1999.

CLASS 9—(Continued).

2,534,644. TALON AUDIO TECHNOLOGIES, DRAPER, UT. SN 75-796,455. PUB. 6-6-2000, FILED 9-8-1999.

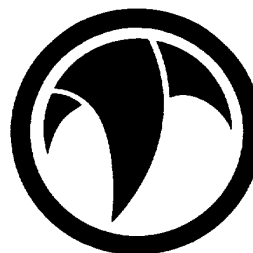

FOR DIGITAL AND/OR ANALOG DEVICES OR SYSTEMS FOR THE RECORDING, REPRODUCTION OR PLAYBACK OF SOUND OR IMAGES, NAMELY CD PLAYERS, CD TRANSPORTS, DVD PLAYERS, DVD TRANSPORTS, PHONOGRAPH SYSTEMS, MAGNETIC TAPE SYSTEMS, DIGITAL TO ANALOG CONVERTERS, ANALOG TO DIGITAL CONVERTERS, POWER FILTERS, POWER CONDITIONERS, POWER CONNECTOR SYSTEMS, POWER WIRE AND CABLE, POWER DISTRIBUTION, DIGITAL AND ANALOG SIGNAL PROCESSORS, EQUALIZERS, TRANSDUCERS INCLUDING MICROPHONES, SWITCHERS, PREAMPLIFIERS, AMPLIFIERS, RECEIVERS, PHONO LEVEL INTERCONNECTING WIRE AND CABLES, LINE LEVEL INTERCONNECTING WIRE AND CABLES, POWER INTERCONNECTING WIRE AND CABLES, MIC LEVEL INTERCONNECTING WIRE AND CABLES, WIRELESS TRANSMITTERS AND RECEIVERS, HEADPHONE LEVEL WIRE AND CABLE, LOUDSPEAKER LEVEL WIRE AND CABLES, LOUDSPEAKERS, HEADPHONES, AND ACCESSORIES EMPLOYED BY THE ABOVE LISTED DEVICES (U.S. CLS. 21, 23, 26, 36 AND 38).

FIRST USE 3-30-1999; IN COMMERCE 7-1-1999.

2,534,658. DICTAPHONE CORPORATION, STRATFORD, CT. SN 75-807,235. PUB. 6-13-2000, FILED 9-23-1999.

ICHART

FOR SOUND RECORDING AND REPRODUCING EQUIPMENT, NAMELY, DIGITAL DICTATION AND TRANSCRIPTION UNITS, SPEECH RECOGNITION SOFTWARE AND RECORD CODING AND ANALYSIS SOFTWARE USED IN A COMPUTER NETWORK; COMPUTER SOFTWARE USED FOR ACCESSING A GLOBAL COMPUTER NETWORK FOR USE IN REMOTE COMMUNICATION EXCHANGE (U.S. CLS. 21, 23, 26, 36 AND 38).

FIRST USE 6-0-2000; IN COMMERCE 10-0-2000.

CLASS 9—(Continued).

2,534,659. DICTAPHONE CORPORATION, STRATFORD, CT. SN 75-807,658. PUB. 6-13-2000, FILED 9-24-1999.

CHARTMAGIC

FOR SOUND RECORDING AND REPRODUCING EQUIPMENT, NAMELY, DIGITAL DICTATION AND TRANSCRIPTION UNITS, SPEECH RECOGNITION SOFTWARE AND RECORD CODING AND ANALYSIS SOFTWARE USED IN A COMPUTER NETWORK; COMPUTER SOFTWARE USED FOR ACCESSING A GLOBAL COMPUTER NETWORK FOR USE IN REMOTE COMMUNICATION EXCHANGE (U.S. CLS. 21, 23, 26, 36 AND 38).

FIRST USE 6-0-2000; IN COMMERCE 10-0-2000.

2,534,668. FEI COMPANY, HILLSBORO, OR. SN 75-822,158. PUB. 12-5-2000, FILED 10-13-1999.

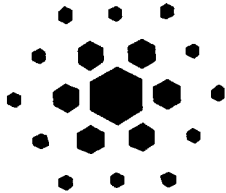

OWNER OF U.S. REG. NOS. 1,681,042 AND 2,263,534.
FOR HIGH BRIGHTNESS, SUBMICRON ION AND ELECTRON BEAM COLUMNS USING FIELD EMISSION TECHNOLOGY; NAMELY, FOCUSED ION BEAM COLUMNS FOR ION LITHOGRAPHY, ION BEAM MILLING, SECONDARY ION MASS SPECTROSCOPY AND MASK REPAIR; FOCUSED ELECTRON BEAM COLUMNS FOR ELECTRON BEAM LITHOGRAPHY AND ELECTRON BEAM MICROSCOPY; SINGLE CRYSTAL SOURCE MATERIALS; NAMELY, REFRACTORY METALS, LAB, MINI-VOGEL MOUNT CATHODES, CEB, MINI-VOGEL MOUNT CATHODES, CONTROL GRID ELECTRODES, NAMELY, REBUILT WEHNELT, COLD FIELD EMITTERS, SCHOTTKY EMITTERS, AND LIQUID METAL ION SOURCES (U.S. CLS. 21, 23, 26, 36 AND 38).
FIRST USE 11-0-1999; IN COMMERCE 11-0-1999.

2,534,678. CONTINENTAL AIRLINES, INC., HOUSTON, TX. SN 75-829,532. PUB. 7-25-2000, FILED 10-22-1999.

EZR

FOR COMPUTER PROGRAM USED AS AN OPEN SYSTEM STANDARD INTERFACE TO ACCESS DATA FROM A MAINFRAME SYSTEM TO AUTOMATE AND STREAMLINE COMPLEX BUSINESS PROCESSES USED IN THE TRAVEL AND TRANSPORTATION INDUSTRY (U.S. CLS. 21, 23, 26, 36 AND 38).
FIRST USE 4-30-1998; IN COMMERCE 4-30-1998.

CLASS 9—(Continued).

2,534,686. ANCHOR GAMING, LAS VEGAS, NV. SN 75-834,313. PUB. 6-20-2000, FILED 10-28-1999.

ACE IN THE HOLE

FOR GAMING MACHINES WITH OR WITHOUT VIDEO OUTPUT AND VIDEO GAMES SOLD AS A COMPONENT PART THEREFORE (U.S. CLS. 21, 23, 26, 36 AND 38).

FIRST USE 9-12-2000; IN COMMERCE 9-12-2000.

2,534,693. BOXER LEARNING, INC., CHARLOTTESVILLE, VA. SN 75-839,460. PUB. 10-31-2000, FILED 11-1-1999.

LEDGER

FOR COMPUTER SOFTWARE FOR COMPILING, MONITORING, EVALUATING, SUMMARIZING AND PRESENTING USER ACTIVITY AND PERFORMANCE DATA IN THE FIELD OF EDUCATIONAL MATERIALS AND TUTORIALS (U.S. CLS. 21, 23, 26, 36 AND 38).

FIRST USE 9-1-2000; IN COMMERCE 9-1-2000.

2,534,696. ENTEK IRD INTERNATIONAL CORPORATION, MILFORD, OH. SN 75-839,673. PUB. 12-5-2000, FILED 11-3-1999.

ENLUBE

FOR COMPUTER SOFTWARE USED TO ANALYZE THE PROPERTIES OF LUBRICANTS CONTAINED IN INDUSTRIAL EQUIPMENT IN FIELDS OF INDUSTRIAL USE FOR THE PURPOSES OF MONITORING THE CONDITION OF THE EQUIPMENT AND/OR THE LUBRICANT CONTAINED THEREIN (U.S. CLS. 21, 23, 26, 36 AND 38).

FIRST USE 5-29-2000; IN COMMERCE 5-29-2000.

2,534,708. SOFT TRACKS ENTERPRISES LTD., RICHMOND, BRITISH COLUMBIA V6V 2X7, CANADA. SN 75-852,425. PUB. 6-6-2000, FILED 11-18-1999.

SKYPAY

FOR FINANCIAL COMPUTER SOFTWARE FOR FACILITATING FINANCIAL TRANSACTIONS OVER A WIRELESS COMMUNICATIONS NETWORK (U.S. CLS. 21, 23, 26, 36 AND 38).
FIRST USE 8-9-2001; IN COMMERCE 8-9-2001.

CLASS 9—(Continued).

2,534,710. FUJITSU GENERAL AMERICA, INC., FAIRFIELD, NJ. SN 75-853,467. PUB. 1-30-2001, FILED 11-19-1999.

Plasmavision SlimScreen

OWNER OF U.S. REG. NO. 2,029,352.
NO CLAIM IS MADE TO THE EXCLUSIVE RIGHT TO USE "SLIMSCREEN", APART FROM THE MARK AS SHOWN.

FOR DISPLAY SCREENS, NAMELY, COMPUTER AND VIDEO SCREENS, TELEVISION MONITORS AND COMPUTER MONITORS (U.S. CLS. 21, 23, 26, 36 AND 38).

FIRST USE 9-0-2001; IN COMMERCE 9-0-2001.

2,534,711. FUJITSU GENERAL AMERICA, INC., FAIRFIELD, NJ. SN 75-853,468. PUB. 3-13-2001, FILED 11-19-1999.

**PLASMAVISION
SLIMSCREEN**

OWNER OF U.S. REG. NO. 2,029,352.
NO CLAIM IS MADE TO THE EXCLUSIVE RIGHT TO USE "SLIMSCREEN", APART FROM THE MARK AS SHOWN.

FOR DISPLAY SCREENS, NAMELY, COMPUTER AND VIDEO SCREENS, TELEVISION MONITORS AND COMPUTER MONITORS (U.S. CLS. 21, 23, 26, 36 AND 38).

FIRST USE 9-0-2001; IN COMMERCE 9-0-2001.

CLASS 9—(Continued).

2,534,712. ILLUMINATION TECHNOLOGIES, INC., EAST SYRACUSE, NY. SN 75-854,699. PUB. 8-22-2000, FILED 11-22-1999.

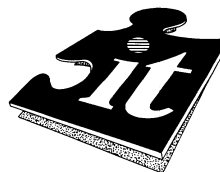

OWNER OF U.S. REG. NO. 2,058,689.
THE STIPPLING IN THE MARK IS FOR SHADING, AND DOES NOT INDICATE COLOR.

FOR ILLUMINATING DEVICES, NAMELY MACHINE VISION ILLUMINATION DEVICES AND PARTS THEREOF, MICROSCOPE ILLUMINATION DEVICES AND PARTS THEREOF, TUNGSTEN HALOGEN LIGHT-SOURCES, HIGH PRESSURE SODIUM LIGHT-SOURCES, FIBER OPTIC LIGHTSOURCES, FIBER OPTIC LIGHT DELIVERY DEVICES, FIBER OPTIC RING LIGHTS, FIBER OPTIC LIGHTGUIDES, FIBER OPTIC BACKLIGHTS, FIBER OPTIC LIGHTLINES, DIFFUSE RING ILLUMINATORS, LED LIGHTS AND PARTS THEREOF, LED STROBE CONTROLLERS, LED RING-LIGHTS, LED BACKLIGHTS, LED LIGHTBARS, AND LED LIGHTLINES, ALL FOR INDUSTRIAL USE (U.S. CLS. 21, 23, 26, 36 AND 38).

FIRST USE 1-1-2000; IN COMMERCE 1-1-2000.

2,534,714. LG ELECTRONICS INC., SEOUL, REPUBLIC OF KOREA. SN 75-856,039. PUB. 10-31-2000, FILED 11-23-1999.

Facefon

FOR TELEPHONES, CELLULAR WIRELESS LOCAL LOOP TELEPHONES, TELEPHONE HANDSETS, COMPUTER TELEPHONY SOFTWARE FOR USE IN ADAPTING A COMPUTER TO PERFORM THE FUNCTIONS OF A TELEPHONE, COMPUTER TERMINALS, VIDEO-PHONES, NAMELY, TELEPHONES WITH LIQUID CRYSTAL DISPLAY (U.S. CLS. 21, 23, 26, 36 AND 38).

FIRST USE 9-0-2000; IN COMMERCE 9-0-2000.

2,534,722. BARBARA CREATIONS, INC., SKOKIE, IL. SN 75-873,101. PUB. 9-19-2000, FILED 12-16-1999.

WEBIWEAR

FOR COMPUTER GLASSES, NAMELY, EYEGLASSES USED TO ASSIST COMPUTER OPERATORS IN READING A COMPUTER SCREEN (U.S. CLS. 21, 23, 26, 36 AND 38).

FIRST USE 4-0-2000; IN COMMERCE 4-0-2000.

CLASS 9—(Continued).

2,534,730. LUCENT TECHNOLOGIES INC., MURRAY HILL, NJ. SN 75-877,512. PUB. 4-24-2001, FILED 12-21-1999.

SUREPAY

FOR COMPUTER SOFTWARE, NAMELY, COMPUTER OPERATING SOFTWARE THAT ENABLES TELECOMMUNICATIONS PROVIDERS THE ABILITY TO OFFER THEIR CUSTOMERS PRE-PAID LOCAL AND LONG-DISTANCE TELECOMMUNICATIONS SERVICES (U.S. CLS. 21, 23, 26, 36 AND 38).

FIRST USE 5-0-2000; IN COMMERCE 5-0-2000.

2,534,737. IMPLI, INC., SAN FRANCISCO, CA, BY ASSIGNMENT INNOVENTRY, SAN FRANCISCO, CA. SN 75-884,433. PUB. 8-29-2000, FILED 12-29-1999.

IMPLI

FOR KIOSKS AND AUTOMATED TRANSACTION MACHINES AND COMPUTER SOFTWARE FOR OPERATING THEM FOR USE IN ELECTRONIC TRANSACTION PROCESSING, INTERACTIVE AND MULTIMEDIA ENTERTAINMENT SERVICES, ONLINE GAMES, ELECTRONIC TICKET PURCHASING, DISPLAYING VIDEO ADVERTISEMENTS, AND PROVIDING ONLINE LINKS TO NEWS, SPORTS, WEATHER, CURRENT EVENTS AND RETAIL SITES (U.S. CLS. 21, 23, 26, 36 AND 38).

FIRST USE 3-0-2000; IN COMMERCE 3-0-2000.

2,534,752. NOMINUM, INC., REDWOOD CITY, CA. SN 75-906,913. PUB. 1-23-2001, FILED 1-24-2000.

**COMMUNICATION BY
NAME**

NO CLAIM IS MADE TO THE EXCLUSIVE RIGHT TO USE "NAME", APART FROM THE MARK AS SHOWN.

FOR COMPUTER HARDWARE AND SOFTWARE FOR DETERMINING AND ALLOCATING NETWORK DEVICE NAMES, TCP/IP ADDRESS ASSIGNMENTS AND RELATED NAME BASED NETWORK TRAFFIC LOAD BALANCING TECHNIQUES (U.S. CLS. 21, 23, 26, 36 AND 38).

FIRST USE 1-31-2001; IN COMMERCE 1-31-2001.

2,534,764. INFRAWORKS CORPORATION, AUSTIN, TX. SN 75-914,571. PUB. 9-26-2000, FILED 2-10-2000.

INTETHER

FOR COMPUTER SOFTWARE, NAMELY SOFTWARE TO PREVENT THE UNAUTHORIZED COPYING OF FILES FROM CD-ROM FLOPPY DISK, WEB SITES OR OTHER ELECTRONIC SOURCES OF DATA (U.S. CLS. 21, 23, 26, 36 AND 38).

FIRST USE 10-18-1999; IN COMMERCE 10-18-1999.

CLASS 9—(Continued).

2,534,767. OAKLEY, INC., FOOTHILL RANCH, CA. SN 75-918,514. PUB. 2-27-2001, FILED 2-14-2000.

Water Jacket

OWNER OF U.S. REG. NO. 1,952,697.

FOR PROTECTIVE AND ANTI-GLARE EYEWEAR, NAMELY SUNGLASSES, GOGGLES, SPECTACLES AND COMPONENT PARTS AND ACCESSORIES THEREFOR, NAMELY, REPLACEMENT LENSES, EARSTEMS, FRAMES, NOSE PIECES AND FOAM STRIPS; EYEGLASS CASES, NAMELY CASES SPECIALLY ADAPTED FOR PROTECTIVE AND ANTI-GLARE EYEWEAR (U.S. CLS. 21, 23, 26, 36 AND 38).

FIRST USE 3-1-2001; IN COMMERCE 3-1-2001.

2,534,784. PMCV TECHNOLOGIES LLC, CHICAGO, IL. SN 75-932,732. PUB. 1-9-2001, FILED 2-25-2000.

PMCV

FOR SOFTWARE FOR ANALYSIS OF BUSINESS APPLICATIONS UTILIZING PRINCIPLES OF MATHEMATICAL ALGORITHMS (U.S. CLS. 21, 23, 26, 36 AND 38).

FIRST USE 9-0-2001; IN COMMERCE 9-0-2001.

2,534,788. IGT, RENO, NV. SN 75-935,778. PUB. 10-10-2000, FILED 3-3-2000.

ENCHANTED UNICORN

FOR GAMING MACHINES, NAMELY, SLOT MACHINES WITH OR WITHOUT A VIDEO OUTPUT (U.S. CLS. 21, 23, 26, 36 AND 38).

FIRST USE 4-0-2001; IN COMMERCE 4-0-2001.

2,534,838. EAGLE RESEARCH, INC., SAN FRANCISCO, CA. SN 76-016,390. PUB. 5-29-2001, FILED 4-3-2000.

Software for the Internet Age

NO CLAIM IS MADE TO THE EXCLUSIVE RIGHT TO USE "SOFTWARE", APART FROM THE MARK AS SHOWN.

FOR COMPUTER SOFTWARE WHICH IMPLEMENTS CUSTOM-DESIGNED BUSINESS APPLICATIONS AS A FUNCTIONAL COMPONENTS OF A CORPORATE WEB SITE, BASED ON SPECIFIC REQUIREMENTS DEFINED BY A CLIENT COMPANY (U.S. CLS. 21, 23, 26, 36 AND 38).

FIRST USE 4-10-2000; IN COMMERCE 4-10-2000.

CLASS 9—(Continued).

2,534,851. ELECTRONIC ARTS INC., REDWOOD CITY, CA. SN 76-029,648. PUB. 12-19-2000, FILED 4-18-2000.

UNDYING

FOR COMPUTER GAME SOFTWARE AND RELATED INSTRUCTION MANUALS SOLD TOGETHER AS A UNIT (U.S. CLS. 21, 23, 26, 36 AND 38).
FIRST USE 2-20-2001; IN COMMERCE 2-20-2001.

2,534,854. ACCO WORLD CORPORATION, LINCOLNSHIRE, IL. SN 76-031,483. PUB. 12-19-2000, FILED 4-21-2000.

SIMPLY PORTABLE

FOR CARRYING CASES FOR COMPUTERS (U.S. CLS. 21, 23, 26, 36 AND 38).
FIRST USE 9-1-2000; IN COMMERCE 9-1-2000.

2,534,856. DOUBLETWIST, INC., OAKLAND, CA. SN 76-032,161. PUB. 11-21-2000, FILED 4-21-2000.

TWISTTOOLS

FOR COMPUTER SOFTWARE FOR ORGANIZING BIOLOGICAL AND BIOCHEMICAL DATA (U.S. CLS. 21, 23, 26, 36 AND 38).
FIRST USE 5-1-2000; IN COMMERCE 5-1-2000.

2,534,857. WMS GAMING INC., CHICAGO, IL. SN 76-032,980. PUB. 1-23-2001, FILED 4-24-2000.

BIG TIPPERS

FOR CURRENCY AND CREDIT OPERATED SLOT MACHINES AND GAMING DEVICES, NAMELY, GAMING MACHINES FOR USE IN GAMING ESTABLISHMENTS (U.S. CLS. 21, 23, 26, 36 AND 38).
FIRST USE 6-22-2001; IN COMMERCE 6-22-2001.

2,534,893. DAKA DEVELOPMENT LTD., KOWLOON, HONG KONG, CHINA. SN 76-059,861. PUB. 5-1-2001, FILED 5-31-2000.

ROACHCONTRO

FOR ELECTRONIC DEVICES FOR USE IN WARDING OFF UNWANTED PESTS, NAMELY, ELECTRONIC INSECT TRAPS, FLYING INSECT LIGHT TRAPS AND ULTRASONIC AND ELECTROMAGNETIC CIRCUITS AND TIMERS RELATED THERETO (U.S. CLS. 21, 23, 26, 36 AND 38).
FIRST USE 12-1-2000; IN COMMERCE 12-1-2000.

CLASS 9—(Continued).

2,534,894. RANDOLPH ENGINEERING, INC., RANDOLPH, MA. SN 76-059,933. PUB. 4-24-2001, FILED 5-30-2000.



FOR EYEWEAR, NAMELY, SUNGLASSES (U.S. CLS. 21, 23, 26, 36 AND 38).
FIRST USE 8-1-1997; IN COMMERCE 6-30-2000.

2,534,903. RICHARD S. CARSON & ASSOCIATES, INC., BETHESDA, MD. SN 76-077,713. PUB. 5-29-2001, FILED 6-22-2000.

SAINTWRITER

FOR COMPUTER PROGRAMS FOR PRODUCING SECURITY ASSESSMENT REPORTS (U.S. CLS. 21, 23, 26, 36 AND 38).
FIRST USE 1-10-2001; IN COMMERCE 1-10-2001.

2,534,922. GOLD WIRE TECHNOLOGY INC., WALTHAM, MA. SN 76-106,688. PUB. 5-1-2001, FILED 8-9-2000.

FORMULATOR

FOR COMPUTER PROGRAMS FOR USE IN AUTOMATION, DEPLOYMENT, MAINTENANCE, SUPPORT AND OPERATION OF DATA COMMUNICATIONS NETWORKS (U.S. CLS. 21, 23, 26, 36 AND 38).
FIRST USE 3-22-2001; IN COMMERCE 3-22-2001.

2,534,923. J.A. WOOLLAM CO. INC., LINCOLN, NE. SN 76-107,360. PUB. 5-15-2001, FILED 8-11-2000.

VUV-VASE

OWNER OF U.S. REG. NOS. 2,296,463, 2,419,157, AND OTHERS.

FOR ELLIPSOMETERS, POLARIMETERS AND SPECTROPHOTOMETERS WHICH UTILIZE ELECTROMAGNETIC RADIATION TO INVESTIGATE SAMPLES IN VACUUM (U.S. CLS. 21, 23, 26, 36 AND 38).
FIRST USE 5-1-2000; IN COMMERCE 5-1-2000.

CLASS 9—(Continued).

2,534,925. PANGEA SOFTWARE, INC., AUSTIN, TX. SN 76-109,309. PUB. 5-8-2001, FILED 8-14-2000.

CRO-MAG RALLY

FOR VIDEO GAME SOFTWARE (U.S. CLS. 21, 23, 26, 36 AND 38).
FIRST USE 2-1-2000; IN COMMERCE 10-15-2000.

2,534,928. NUESOFT TECHNOLOGIES, INC., ATLANTA, GA. SN 76-111,474. PUB. 5-22-2001, FILED 8-16-2000.

NUEMD

FOR COMPUTER SOFTWARE AND INSTRUCTIONAL MANUALS SOLD AS A UNIT FOR USE IN MEDICAL OFFICE ADMINISTRATION AND MEDICAL OFFICE INFORMATION MANAGEMENT, NAMELY, FOR USE IN MEDICAL OFFICE BILLING, INSURANCE PAYMENT SUBMISSIONS, AND MAINTAINING MEDICAL PATIENT HISTORIES (U.S. CLS. 21, 23, 26, 36 AND 38).
FIRST USE 5-1-2001; IN COMMERCE 5-1-2001.

2,534,938. VIDITEC, INC., PLANO, TX. SN 78-000,093. PUB. 11-14-2000, FILED 3-20-2000.



FOR CABLE MODEM; CABLE MODEM WITH VOICE OVER INTERNET PROTOCOL (VOIP) (U.S. CLS. 21, 23, 26, 36 AND 38).
FIRST USE 6-1-1999; IN COMMERCE 6-1-1999.

2,534,939. QUICK COM AG, ZUG, SWITZERLAND. SN 78-000,448. PUB. 12-5-2000, FILED 3-22-2000.

QUICK COM

FOR COMPUTER SOFTWARE THAT ENABLES THE ELECTRONIC TRANSMISSION OF DOCUMENT AND DATA FILES OVER A DATA NETWORK USING SERVERLESS TECHNOLOGY (U.S. CLS. 21, 23, 26, 36 AND 38).
FIRST USE 8-1-2000; IN COMMERCE 8-1-2000.

CLASS 9—(Continued).

2,534,943. KIDSNET, INC., TALLAHASSEE, FL. SN 78-000,750. PUB. 5-22-2001, FILED 3-23-2000.



NO CLAIM IS MADE TO THE EXCLUSIVE RIGHT TO USE "KIDSNET.COM", APART FROM THE MARK AS SHOWN.

FOR COMPUTER SOFTWARE FOR RESTRICTED INTERNET ACCESS FOR CHILDREN AND BUSINESSES THAT MAY ALSO BE DOWNLOADED FROM A GLOBAL COMPUTER NETWORK (U.S. CLS. 21, 23, 26, 36 AND 38).
FIRST USE 9-5-2001; IN COMMERCE 9-5-2001.

2,534,951. INTERGRAPH CORPORATION, HUNTSVILLE, AL. SN 78-006,075. PUB. 4-3-2001, FILED 4-28-2000.

DCS

FOR COMPUTER GRAPHICS SOFTWARE FOR PUBLISHING AND PRODUCING GEOGRAPHIC AND NON-GEOGRAPHIC MAPS; AND INSTRUCTION MANUALS SOLD THEREWITH (U.S. CLS. 21, 23, 26, 36 AND 38).
FIRST USE 5-17-2001; IN COMMERCE 5-17-2001.

2,534,967. ISCO, INC., LINCOLN, NE. SN 78-014,730. PUB. 5-22-2001, FILED 6-28-2000.

FIELD WIZARD

FOR COMPUTER USED TO RETRIEVE STORED DATA FROM AND TO CONFIGURE FLOW MONITORING/RECORDING INSTRUMENTS USED IN THE FIELD OF WATER MONITORING (U.S. CLS. 21, 23, 26, 36 AND 38).
FIRST USE 2-2-2001; IN COMMERCE 2-2-2001.

2,534,978. J.R. JENSEN, SPANISH FORK, UT. SN 78-019,987. PUB. 3-20-2001, FILED 8-7-2000.

QUOMATION

FOR COMPUTER SOFTWARE FOR INDEPENDENT INSURANCE AGENCIES, NAMELY, FOR PROCESSING INSURANCE QUOTES AND FOR DATABASE MANAGEMENT (U.S. CLS. 21, 23, 26, 36 AND 38).
FIRST USE 5-1-2000; IN COMMERCE 6-1-2000.

CLASS 9—(Continued).

2,534,979. CORRIGO, INC., REDWOOD CITY, CA. SN 78-021,335. PUB. 4-24-2001, FILED 8-15-2000.

CORRIGOSOURCE

FOR PROVIDING TEMPORARY USE OF ON-LINE NON-DOWNLOADABLE COMMUNICATIONS SOFTWARE TO ALLOW CUSTOMERS TO AUTOMATE ORDER, TRACKING AND RECEIPT PROCESSES FOR MRO (MAINTENANCE, REPAIR AND OPERATION) PRODUCTS VIA THE GLOBAL COMPUTER NETWORK (U.S. CLS. 21, 23, 26, 36 AND 38).
FIRST USE 7-1-2000; IN COMMERCE 8-1-2000.

CLASS 10—MEDICAL APPARATUS

2,534,382. MATTIOLI ENGINEERING LTD., LONDON, UNITED KINGDOM. SN 75-300,086. PUB. 5-30-2000, FILED 5-29-1997.

A NEW SCIENCE IN SKIN CARE

FOR MEDICAL APPARATUS, NAMELY, SKIN ABRADERS AND DERMOABRADERS (U.S. CLS. 26, 39 AND 44).
FIRST USE 2-27-1998; IN COMMERCE 2-27-1998.

2,534,489. BIOPOOL AB, S-907 04 UMEA, SWEDEN. SN 75-597,868. PUB. 1-9-2001, FILED 12-2-1998.

MINIQUANT

FOR MEDICAL DIAGNOSTIC APPARATUS FOR DETECTING ANALYTES IN A PATIENT FLUID SAMPLE (U.S. CLS. 26, 39 AND 44).
FIRST USE 1-15-1999; IN COMMERCE 1-15-1999.

2,534,528. PREVENTIVE MEDICAL TECHNOLOGIES, INC., PHOENIXVILLE, PA. SN 75-657,333. PUB. 8-1-2000, FILED 3-10-1999.

ISOPAD

FOR DEVICE FOR DETECTING AND DISPLAYING TO A USER FORCE APPLIED BY THE USER PARTICULARLY FOR USE IN ISOMETRIC EXERCISE (U.S. CLS. 26, 39 AND 44).
FIRST USE 10-10-2001; IN COMMERCE 10-10-2001.

CLASS 10—(Continued).

2,534,723. NOVAFON ELEKTROMEDIZINISCHE GERATE GMBH, D-70736 FELLBACH, FED REP GERMANY. SN 75-873,776. PUB. 10-24-2000, FILED 12-15-1999.

NOSTRAFON

OWNER OF U.S. REG. NO. 1,614,661.
FOR ELECTROMEDICAL DEVICES, NAMELY, MASSAGE APPARATUS FOR MEDICAL AND DIAGNOSTIC PURPOSES; ULTRA SONIC THERAPY APPARATUS FOR MEDICAL USE (U.S. CLS. 26, 39 AND 44).
FIRST USE 11-23-1987; IN COMMERCE 12-20-1999.

2,534,746. THERMAGE, HAYWARD, CA. SN 75-897,497. PUB. 9-26-2000, FILED 1-14-2000.

THERMAGE

FOR MEDICAL DEVICE FOR CONTRACTING SKIN, BODY SCULPTING AND SOFT TISSUE RECONSTRUCTION IN A NON-INVASIVE MANNER (U.S. CLS. 26, 39 AND 44).
FIRST USE 2-24-2001; IN COMMERCE 2-24-2001.

2,534,750. DARBY DENTAL SUPPLY CO., INC., WESTBURY, NY. SN 75-903,912. PUB. 10-31-2000, FILED 1-27-2000.

SILENT TORQUE

NO CLAIM IS MADE TO THE EXCLUSIVE RIGHT TO USE "TORQUE", APART FROM THE MARK AS SHOWN.
FOR DENTAL HAND PIECES (U.S. CLS. 26, 39 AND 44).
FIRST USE 3-1-2001; IN COMMERCE 3-1-2001.

2,534,774. RMO, INC., DENVER, CO. SN 75-925,807. PUB. 12-19-2000, FILED 2-24-2000.

LUXI

FOR ORTHODONTIC APPARATUS, NAMELY, CERAMIC BRACKET (U.S. CLS. 26, 39 AND 44).
FIRST USE 3-1-2001; IN COMMERCE 5-1-2001.

2,534,786. CORDIS CORPORATION, MIAMI LAKES, FL. SN 75-933,722. PUB. 12-26-2000, FILED 3-2-2000.

BX VELOCITY

FOR MEDICAL DEVICES, NAMELY, STENTS (U.S. CLS. 26, 39 AND 44).
FIRST USE 5-22-2000; IN COMMERCE 5-22-2000.

CLASS 10—(Continued).

2,534,888. HOWMEDICA OSTEONICS CORP., ALLENDALE, NJ. SN 76-056,548. PUB. 4-3-2001, FILED 5-25-2000.

EIUS

FOR SURGICAL INSTRUMENTS AND APPARATUS, NAMELY, ORTHOPEDIC IMPLANTS, NAMELY, KNEE IMPLANTS; AND ORTHOPEDIC SURGICAL INSTRUMENTS AND TOOLS, NAMELY, INSTRUMENTS AND TOOLS FOR IMPLANTING KNEE IMPLANTS (U.S. CLS. 26, 39 AND 44).

FIRST USE 7-0-2000; IN COMMERCE 7-0-2000.

2,534,909. FLA ORTHOPEDICS, INC., MIRAMAR, FL. SN 76-090,125. PUB. 4-10-2001, FILED 7-17-2000.

POWER FORM

FOR ORTHOPEDIC SUPPORTS (U.S. CLS. 26, 39 AND 44).

FIRST USE 6-25-2001; IN COMMERCE 6-25-2001.

2,534,917. POWERMED, INC., NEW HOPE, PA. SN 76-096,597. PUB. 4-3-2001, FILED 7-24-2000.

SURGASSIST

FOR SURGICAL INSTRUMENTS, NAMELY SURGICAL STAPLERS (U.S. CLS. 26, 39 AND 44).

FIRST USE 6-21-1999; IN COMMERCE 6-25-2001.

2,534,956. CNMC COMPANY, NASHVILLE, TN. SN 78-009,148. PUB. 4-17-2001, FILED 5-22-2000.

EQUILYZER

FOR METER TO READ DIODE OUTPUTS AND FOR DAILY OUTPUT/SYMMETRY/FLATNESS CHECKS OF RADIATION THERAPY TREATMENT MACHINES (U.S. CLS. 26, 39 AND 44).

FIRST USE 7-1-1999; IN COMMERCE 7-1-1999.

2,534,965. VAST RESOURCES, INC., SAN FERNANDO, CA. SN 78-014,541. PUB. 3-27-2001, FILED 6-27-2000.

ERECTO-GRIP

FOR STIMULATION DEVICES FOR AIDING IN SEXUAL AROUSAL AND SEXUAL PERFORMANCE; CONstrictor RINGS FOR USE TO MAINTAIN ERECTIONS; CONDOMS (U.S. CLS. 26, 39 AND 44).

FIRST USE 7-0-2000; IN COMMERCE 7-0-2000.

CLASS 10—(Continued).

2,534,981. ARTHROCARE CORPORATION, SUNNYVALE, CA. SN 78-025,880. PUB. 5-15-2001, FILED 9-14-2000.

TITAN

FOR MEDICAL DEVICES FOR ELECTROSURGERY AND ELECTRON PLASMA ASSISTED SURGERY IN ARTHROSCOPIC SURGICAL PROCEDURES; NAMELY, ELECTROSURGICAL PROBES, ELECTRODES, AND POWER SUPPLIES FOR THE ELECTRODES (U.S. CLS. 26, 39 AND 44).

FIRST USE 9-29-2000; IN COMMERCE 9-29-2000.

CLASS 11—ENVIRONMENTAL CONTROL APPARATUS

2,534,361. GROUND HEATERS, INC., CALUMET, MI. SN 75-206,670. PUB. 8-26-1997, FILED 12-2-1996.

VULCAN

FOR GROUND HEATERS AND CONCRETE CURING UNITS FOR DOMESTIC, COMMERCIAL AND INDUSTRIAL USE (U.S. CLS. 13, 21, 23, 31 AND 34).

FIRST USE 12-21-1998; IN COMMERCE 12-21-1998.

2,534,378. HERBERT WALDMANN GMBH & CO., D- 78056 VILLINGEN-SCHWENNINGEN, FED REP GERMANY. SN 75-264,937. PUB. 11-9-1999, FILED 3-27-1997.

CORTO

OWNER OF FED REP GERMANY REG. NO. 39543099, DATED 6-12-1996, EXPIRES 10-31-2005.

THE FORMAL TRANSLATION OF THE SPANISH OR ITALIAN WORD "CORTO" INTO ENGLISH IS "SHORT".

FOR ELECTRIC LIGHTING FIXTURES AND LAMPS (U.S. CLS. 13, 21, 23, 31 AND 34).

FIRST USE 7-0-2001; IN COMMERCE 7-0-2001.

2,534,400. CAPITAL CONTROLS CO., INC., DBA TETRA PROCESS TECHNOLOGIES, COLMAR, PA. BY ASSIGNMENT; BY ASSIGNMENT TETRA TECHNOLOGIES, INC., THE WOODLANDS, TX. SN 75-384,973. PUB. 1-5-1999, FILED 11-5-1997.

B PLATE

NO CLAIM IS MADE TO THE EXCLUSIVE RIGHT TO USE "PLATE", APART FROM THE MARK AS SHOWN.

FOR FILTER PLATES FOR USE IN WASTEWATER FLUID TREATMENT SYSTEMS (U.S. CLS. 13, 21, 23, 31 AND 34).

FIRST USE 3-1-1999; IN COMMERCE 3-1-1999.

CLASS 11—(Continued).

2,534,470. MORGAN CONSTRUCTION COMPANY, WORCESTER, MA. SN 75-556,607. PUB. 9-7-1999, FILED 9-22-1998.

MORGAN ISLEY

FOR FURNACE PARTS FOR THE GLASS AND STEEL INDUSTRIES, NAMELY, REVERSING VALVES, EJEC-TORS AND SECONDARY REGENERATORS (U.S. CLS. 13, 21, 23, 31 AND 34).

FIRST USE 5-27-1998; IN COMMERCE 5-27-1998.

2,534,594. WATER PIK TECHNOLOGIES, INC., NEWPORT BEACH, CA. BY ASSIGNMENT; BY ASSIGNMENT TELE-DYNE INDUSTRIES, INC., DBA TELEDYNE WATER PIK, LOS ANGELES, CA. SN 75-739,735. PUB. 12-12-2000, FILED 6-29-1999.

SMART FLOW

OWNER OF U.S. REG. NO. 1,772,308.
NO CLAIM IS MADE TO THE EXCLUSIVE RIGHT TO USE "FLOW", APART FROM THE MARK AS SHOWN.
FOR SHOWERHEAD AND COMPONENTS THEREOF (U.S. CLS. 13, 21, 23, 31 AND 34).

FIRST USE 9-4-2001; IN COMMERCE 9-4-2001.

2,534,605. VAPORTEK, INC., SUSSEX, WI. SN 75-745,691. PUB. 8-29-2000, FILED 7-8-1999.

VAPOR SHARK

NO CLAIM IS MADE TO THE EXCLUSIVE RIGHT TO USE "VAPOR", APART FROM THE MARK AS SHOWN.

FOR ELECTRIC ROOM DEODORIZING UNITS FOR NEUTRALIZING AND DEODORIZING ODOR-CAUSING COMPONENTS IN AIR AND OTHER VAPORS, FOR COMMERCIAL, DOMESTIC AND INDUSTRIAL USE (U.S. CLS. 13, 21, 23, 31 AND 34).

FIRST USE 1-0-1999; IN COMMERCE 1-0-1999.

2,534,611. WEIN PRODUCTS, INC., LOS ANGELES, CA. SN 75-751,155. PUB. 1-25-2000, FILED 7-14-1999.

SANILYSER

FOR ELECTRIC STERILIZER AND DEODORIZER PRODUCT THAT USES A CORONA DISCHARGE PLASMA TO DESTROY PATHOGENS FOR BUSINESS AND INDUSTRIAL USE (U.S. CLS. 13, 21, 23, 31 AND 34).

FIRST USE 7-17-2001; IN COMMERCE 7-17-2001.

CLASS 11—(Continued).

2,534,707. AIRFLOW SYSTEMS, INC., DALLAS, TX. SN 75-851,285. PUB. 2-27-2001, FILED 11-16-1999.

MISTPLUS

FOR AIR FILTERS FOR COLLECTING AIRBORNE PARTICULATES, MIST AND SMOKE GENERATED BY OPERATION OF INDUSTRIAL METAL WORKING EQUIPMENT SUCH AS LATHES, MILLS, GRINDERS, DRILLS AND THREADING MACHINES (U.S. CLS. 13, 21, 23, 31 AND 34).

FIRST USE 9-14-1999; IN COMMERCE 9-14-1999.

2,534,733. CPL CARBON LINK CORPORATION, COLUMBUS, OH. SN 75-879,439. PUB. 5-22-2001, FILED 12-23-1999.



FOR GAS AND AIR FILTRATION AND PURIFICA-TION EQUIPMENT FOR INDUSTRIAL AND COMMER-CIAL USE: WATER AND LIQUID FILTERING UNITS FOR GROUND WATER, FUGITIVE AND PROCESS FILTRATION; AND MODULAR FILTRATION UNITS AND SYSTEMS COMPOSED PRIMARILY OF A COMBI-NATION OF THE FOLLOWING, PANEL CARBON RE-TAINING VESSELS, DEEP BED CARBON RETAINING VESSELS, FANS, PUMPS, PARTICULATE PRE-FILTRA-TION, PARTICULATE POST-FILTRATION, AND PER-FORMANCE MEASURING DEVICES (U.S. CLS. 13, 21, 23, 31 AND 34).

FIRST USE 11-0-1999; IN COMMERCE 11-0-1999.

2,534,736. KIM LIGHTING INC., CITY OF INDUSTRY, CA. SN 75-884,136. PUB. 10-3-2000, FILED 12-29-1999.

Era

FOR LUMINAIRES (U.S. CLS. 13, 21, 23, 31 AND 34).
FIRST USE 10-16-1999; IN COMMERCE 10-16-1999.

2,534,782. ARMAMENT SYSTEMS AND PROCEDURES, INC., APPLETON, WI. SN 75-931,517. PUB. 12-12-2000, FILED 2-29-2000.

TIME CAPSULE

FOR STORAGE CASES FOR FLASHLIGHT COMPO-NENTS (U.S. CLS. 13, 21, 23, 31 AND 34).

FIRST USE 10-31-2000; IN COMMERCE 10-31-2000.

CLASS 11—(Continued).

2,534,793. LTG, LTD., FARGO, ND. SN 75-943,128. PUB. 12-12-2000, FILED 3-10-2000.

ENVIRO-SAFE

FOR FLUORESCENT LAMPS (U.S. CLS. 13, 21, 23, 31 AND 34).
FIRST USE 8-23-2000; IN COMMERCE 8-23-2000.

2,534,905. GENLYTE THOMAS GROUP LLC, LOUISVILLE, KY. SN 76-081,778. PUB. 3-27-2001, FILED 6-30-2000.

GEOFLOOD

FOR ELECTRIC LIGHTING FIXTURES (U.S. CLS. 13, 21, 23, 31 AND 34).
FIRST USE 4-7-2001; IN COMMERCE 5-25-2001.

2,534,962. JOHNSON, WAYNE A., MUNISING, MI. SN 78-013,028. PUB. 3-20-2001, FILED 6-16-2000.

BUGBUSTER

FOR WATER TREATMENT EQUIPMENT, NAMELY, ULTRAVIOLET STERILIZATION UNITS, REVERSE OSMOSIS FILTRATION UNITS, CARTRIDGE FILTRATION UNITS AND CHEMICAL STERILIZATION UNITS USED TO RENDER BACTERIA AND PARASITES FOUND IN WATER HARMLESS FOR DOMESTIC USE (U.S. CLS. 13, 21, 23, 31 AND 34).
FIRST USE 4-19-1999; IN COMMERCE 4-19-1999.

CLASS 12—VEHICLES

2,534,383. AMERICAN AXLE & MANUFACTURING, INC., DETROIT, MI. SN 75-306,731. PUB. 5-5-1998, FILED 6-11-1997.

POWERLITE

FOR LIGHTWEIGHT ALUMINUM AXLES FOR USE IN CONNECTION WITH LAND VEHICLES (U.S. CLS. 19, 21, 23, 31, 35 AND 44).
FIRST USE 9-0-1998; IN COMMERCE 11-0-2000.

2,534,463. KAWASAKI JUKOGYO KABUSHIKI KAISHA, DBA KAWASAKI HEAVY INDUSTRIES, LTD., CHUOKU, KOBE, JAPAN. SN 75-542,731. PUB. 12-12-2000, FILED 8-25-1998.

DRIFTER

FOR MOTORCYCLES AND THEIR STRUCTURAL PARTS (U.S. CLS. 19, 21, 23, 31, 35 AND 44).
FIRST USE 10-1-1998; IN COMMERCE 10-1-1998.

CLASS 12—(Continued).

2,534,491. AEROFLEX INTERNATIONAL CO., LTD., CHANGWAD RAYONG, THAILAND. SN 75-601,827. PUB. 4-11-2000, FILED 12-8-1998.



NO CLAIM IS MADE TO THE EXCLUSIVE RIGHT TO USE "TRUNK TRAY", APART FROM THE MARK AS SHOWN.

THE STIPPLING IS FOR SHADING PURPOSES. FOR FITTED LINERS FOR THE CARGO AREA OF PICK-UP TRUCKS (U.S. CLS. 19, 21, 23, 31, 35 AND 44).
FIRST USE 0-0-1998; IN COMMERCE 0-0-1998.

2,534,665. MICHELIN NORTH AMERICA, INC., GREENVILLE, SC. SN 75-816,440. PUB. 4-10-2001, FILED 10-6-1999.



FOR TIRES FOR LAND VEHICLES AND INNER TUBES FOR VEHICLE TIRES (U.S. CLS. 19, 21, 23, 31, 35 AND 44).
FIRST USE 11-0-2000; IN COMMERCE 11-0-2000.

2,534,709. DEL-NAT TIRE CORPORATION, MEMPHIS, TN. SN 75-852,742. PUB. 6-13-2000, FILED 11-18-1999.

TRINITY

FOR TIRES (U.S. CLS. 19, 21, 23, 31, 35 AND 44).
FIRST USE 8-1-2001; IN COMMERCE 8-1-2001.

2,534,773. ENCORA, LLC, RENO, NV. SN 75-925,671. PUB. 1-9-2001, FILED 2-22-2000.

ENCORA

FOR FUEL EFFICIENCY MODULE FOR INTERNAL COMBUSTION ENGINES THAT REALIGNS MOLECULES FOR IMPROVED BURN RATE (U.S. CLS. 19, 21, 23, 31, 35 AND 44).
FIRST USE 4-30-2001; IN COMMERCE 4-30-2001.

CLASS 12—(Continued).

2,534,780. WALTCO TRUCK EQUIPMENT CO., TALLMADGE, OH. SN 75-929,968. PUB. 1-23-2001, FILED 2-25-2000.

SDL

FOR LIFTS FOR ATTACHMENT TO A VEHICLE TO RAISE AND LOWER LOADS TO AND FROM AN ELEVATED LEVEL, NAMELY, TRUCK TAILGATE LIFTS (U.S. CLS. 19, 21, 23, 31, 35 AND 44).
FIRST USE 10-31-1999; IN COMMERCE 10-31-1999.

CLASS 13—(Continued).

2,534,681. HUNTER PACIFIC LIMITED, TORTOLA, BR. VIRGIN ISLANDS. SN 75-832,111. PUB. 12-19-2000, FILED 10-27-1999.

JUMPING CRACKER

NO CLAIM IS MADE TO THE EXCLUSIVE RIGHT TO USE "CRACKER", APART FROM THE MARK AS SHOWN. FOR FIREWORKS (U.S. CLS. 2 AND 9).
FIRST USE 11-13-2000; IN COMMERCE 11-13-2000.

2,534,865. VOGUE TYRE & RUBBER COMPANY, MT. PROSPECT, IL. SN 76-038,194. PUB. 1-23-2001, FILED 5-1-2000.

CLASS 14—JEWELRY

2,534,358. NIKE, INC., BEAVERTON, OR. SN 75-187,264. PUB. 12-9-1997, FILED 10-24-1996.

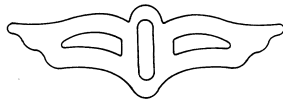

OWNER OF U.S. REG. NO. 778,766.
THE MARK CONSISTS OF A REPRESENTATION OF A WING.
FOR VEHICLE TIRES (U.S. CLS. 19, 21, 23, 31, 35 AND 44).
FIRST USE 2-24-2000; IN COMMERCE 2-24-2000.



OWNER OF U.S. REG. NOS. 1,237,469, 1,595,356, AND OTHERS.
FOR TIMEPIECES OF ALL TYPES, NAMELY, STOPWATCHES (U.S. CLS. 2, 27, 28 AND 50).
FIRST USE 10-7-1999; IN COMMERCE 10-7-1999.

2,534,947. POLAR BARROW, INC., STANCHFIELD, MN, BY CHANGE OF NAME ESQUARED, INC., STANCHFIELD, MN. SN 78-003,488. PUB. 4-3-2001, FILED 4-11-2000.

POLAR BARROW

NO CLAIM IS MADE TO THE EXCLUSIVE RIGHT TO USE "BARROW", APART FROM THE MARK AS SHOWN.
FOR CONVERTIBLE UTILITY WAGON FOR LAWN AND GARDEN AND RECREATIONAL USES (U.S. CLS. 19, 21, 23, 31, 35 AND 44).
FIRST USE 1-16-2001; IN COMMERCE 8-28-2001.

2,534,458. ARMY OF DARKNESS, INC., LOS ANGELES, CA, BY ASSIGNMENT ARMY OF DARKNESS, LOS ANGELES, CA. SN 75-538,307. PUB. 8-17-1999, FILED 8-18-1998.

CLASS 13—FIREARMS

2,534,472. EBSCO INDUSTRIES, INC., BIRMINGHAM, AL. SN 75-558,650. PUB. 1-11-2000, FILED 9-24-1998.



CAMO GUN SKIN

NO CLAIM IS MADE TO THE EXCLUSIVE RIGHT TO USE "CAMO GUN", APART FROM THE MARK AS SHOWN.
FOR GUN CASES, NAMELY, CAMOUFLAGE GUN CASES (U.S. CLS. 2 AND 9).
FIRST USE 11-16-1998; IN COMMERCE 11-16-1998.

THE MARK CONSISTS OF THE WORD "ANTAETAG" IN THE STYLIZED DESIGN AS SHOWN IN THE DRAWING.
FOR JEWELRY AND DOG TAGS BEING JEWELRY (U.S. CLS. 2, 27, 28 AND 50).
FIRST USE 3-29-2000; IN COMMERCE 3-29-2000.

CLASS 14—(Continued).

2,534,468. BEIHANG TECHNOLOGY LIMITED, CAUSEWAY BAY, HONG KONG. SN 75-550,797. PUB. 6-1-1999, FILED 9-10-1998.

TIMEAROUND

FOR TIME KEEPING DEVICES, NAMELY, CHRONOMETERS, FOR REGULATING THE PACE AT WHICH A ROUND OF GOLF IS PLAYED (U.S. CLS. 2, 27, 28 AND 50).

FIRST USE 6-19-2001; IN COMMERCE 6-19-2001.

2,534,569. PAJ, INC., DALLAS, TX. SN 75-710,984. PUB. 12-28-1999, FILED 5-21-1999.



FOR JEWELRY (U.S. CLS. 2, 27, 28 AND 50).
FIRST USE 1-28-2000; IN COMMERCE 1-28-2000.

2,534,809. CLARK, DAN, OVERLAND PARK, KS. SN 75-981,365. PUB. 5-30-2000, FILED 4-12-1999.

THE LIFE COMPASS

FOR JEWELRY (U.S. CLS. 2, 27, 28 AND 50).
FIRST USE 11-0-1999; IN COMMERCE 11-0-1999.

CLASS 16—PAPER GOODS AND PRINTED MATTER

2,534,355. WADE, DIANE, FRANKLIN, TN. SN 75-141,729. PUB. 10-14-1997, FILED 7-29-1996.

TOMMY TURTLE

FOR CHILDREN'S BOOKS AND STORIES, COLORING BOOKS, STICKERS AND PENCILS (U.S. CLS. 2, 5, 22, 23, 29, 37, 38 AND 50).
FIRST USE 4-17-2000; IN COMMERCE 4-17-2000.

CLASS 16—(Continued).

2,534,359. VIACOM INTERNATIONAL INC., NEW YORK, NY. SN 75-189,380. PUB. 4-15-1997, FILED 10-29-1996.

CATDOG

FOR PRINTED MATTER, NAMELY, BOOKS ON THE TOPICS OF TELEVISION AND ENTERTAINMENT (U.S. CLS. 2, 5, 22, 23, 29, 37, 38 AND 50).

FIRST USE 7-0-1999; IN COMMERCE 7-0-1999.

2,534,373. HAAS, KEN, BARRYVILLE, NY. SN 75-250,479. PUB. 9-22-1998, FILED 3-3-1997.

PICTOID

FOR MOUNTED AND UNMOUNTED PHOTOGRAPHS, GRAPHIC ART REPRODUCTIONS, GRAPHIC ART PICTURES AND PRINTS, PHOTOGRAPHIC PRINTS, AND PICTURES AND ETCHINGS (U.S. CLS. 2, 5, 22, 23, 29, 37, 38 AND 50).

FIRST USE 12-16-2000; IN COMMERCE 12-16-2000.

2,534,379. LINDA DENNIS CREATIVE SERVICES, GREENVILLE, SC. SN 75-279,220. PUB. 9-1-1998, FILED 4-22-1997.

COVERWORKS

FOR FABRIC COVERED TURNED EDGE PRODUCTS FOR GRAPHIC AND COLOR IMPRINTING, NAMELY, BINDERS, PHOTO ALBUMS, JOURNALS, PAPER PANELS, GREETING CARDS AND FOLDERS (U.S. CLS. 2, 5, 22, 23, 29, 37, 38 AND 50).

FIRST USE 9-0-2000; IN COMMERCE 9-0-2000.

2,534,394. MARTIN YALE INDUSTRIES, INC., WABASH, IN. SN 75-365,916. PUB. 12-29-1998, FILED S.R. 9-30-1997; AM. P.R. 10-26-1998.

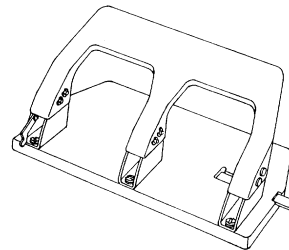

SEC. 2(F).
FOR PAPER HOLE PUNCHES (U.S. CLS. 2, 5, 22, 23, 29, 37, 38 AND 50).
FIRST USE 10-0-1993; IN COMMERCE 10-0-1993.

CLASS 16—(Continued).

2,534,398. FORT JAMES OPERATING COMPANY, RICHMOND, VA. SN 75-372,818. PUB. 7-28-1998, FILED 10-14-1997.

ALLTEMP

FOR PAPER CUPS (U.S. CLS. 2, 5, 22, 23, 29, 37, 38 AND 50).
FIRST USE 5-1-2001; IN COMMERCE 5-1-2001.

2,534,404. TECHNOLOGIES I, INC., HENDERSON, NV. SN 75-395,814. PUB. 7-14-1998, FILED 11-25-1997.

EXECULINE

FOR PAPER TISSUE AND PAPER WIPES (U.S. CLS. 2, 5, 22, 23, 29, 37, 38 AND 50).
FIRST USE 6-25-1999; IN COMMERCE 6-25-1999.

2,534,427. ADDISON WESLEY LONGMAN, INC., READING, MA. SN 75-467,462. PUB. 1-26-1999, FILED 4-17-1998.



FOR BOOKMARKS, INSTRUCTIONAL AND EDUCATIONAL MATERIALS FOR STUDENTS IN PRESCHOOL THROUGH GRADE 12 AND FOR TEACHERS AND PARENTS OF SUCH CHILDREN; AND FOR CATALOGUES FEATURING EDUCATIONAL AND INSTRUCTIONAL BOOKS, AUDIOTAPES, CDROMS, SOFTWARE, AND EDUCATIONAL KITS ON A WIDE AREA OF CURRICULAR SUBJECT FOR TEACHERS PARENTS AND CHILDREN IN PRESCHOOL THROUGH GRADE 12 (U.S. CLS. 2, 5, 22, 23, 29, 37, 38 AND 50).
FIRST USE 9-1-1999; IN COMMERCE 9-1-1999.

2,534,440. DEMARS, ROBERT A., WOODLAND HILLS, CA. AND PETERSON, CHRISTOPHER G., VENTURA, CA. SN 75-489,403. PUB. 12-29-1998, FILED 5-21-1998.

PEN UPS

FOR WRITING INSTRUMENTS, NAMELY, PENS, PENCILS, MARKERS, AND HIGHLIGHTING MARKERS (U.S. CLS. 2, 5, 22, 23, 29, 37, 38 AND 50).
FIRST USE 5-8-2001; IN COMMERCE 5-8-2001.

CLASS 16—(Continued).

2,534,448. SHELDON, KRISTIN, BOULDER, CO. SN 75-517,767. PUB. 4-13-1999, FILED 7-13-1998.

HEARTOONS

FOR CARTOON STRIPS, CARTOON PRINTS, NEWSPAPER CARTOONS, GREETING CARDS AND FICTION BOOKS (U.S. CLS. 2, 5, 22, 23, 29, 37, 38 AND 50).
FIRST USE 10-21-2001; IN COMMERCE 10-21-2001.

2,534,459. POTLATCH CORPORATION, SPOKANE, WA. SN 75-539,052. PUB. 8-10-1999, FILED 8-19-1998.

ALLURE

FOR PAPER NAPKINS AND FACIAL TISSUE (U.S. CLS. 2, 5, 22, 23, 29, 37, 38 AND 50).
FIRST USE 6-0-2001; IN COMMERCE 6-0-2001.

2,534,475. ESSELTE CORPORATION, GARDEN CITY, NY. SN 75-567,712. PUB. 4-24-2001, FILED 10-9-1998.

LETRATAG

OWNER OF U.S. REG. NOS. 903,896, 1,531,935, AND OTHERS.

FOR OFFICE REQUISITES, NAMELY, ELECTRONIC LABELING MACHINES; CASSETTES AND CARTRIDGES CONTAINING TAPES, BLANK LABELS, ADDRESS LABELS, SHIPPING LABELS, PAPER TAGS, PAPER PRICE TAGS AND PAPER IDENTIFICATION TAGS FOR USE WITH ELECTRONIC LABELING MACHINES; BLANK LABELS, PAPER TAGS, PAPER PRICE TAGS AND PAPER IDENTIFICATION TAGS (U.S. CLS. 2, 5, 22, 23, 29, 37, 38 AND 50).
FIRST USE 8-17-1999; IN COMMERCE 8-17-1999.

2,534,510. UNITED COMMUNICATIONS GROUP LIMITED PARTNERSHIP, ROCKVILLE, MD. SN 75-634,682. PUB. 10-5-1999, FILED 8-7-1998.

PHYSICIAN COMPLIANCE ALERT

NO CLAIM IS MADE TO THE EXCLUSIVE RIGHT TO USE "PHYSICIAN COMPLIANCE", APART FROM THE MARK AS SHOWN.

FOR NEWSLETTERS RELATING TO THE APPLICATION OF RULES DEALING WITH HEALTH CARE CLAIMS AND REFERRALS (U.S. CLS. 2, 5, 22, 23, 29, 37, 38 AND 50).
FIRST USE 1-0-1999; IN COMMERCE 1-0-1999.

CLASS 16—(Continued).

2,534,539. ENESCO GROUP, INC., ITASCA, IL, BY CHANGE OF NAME ENESCO CORPORATION, ITASCA, IL. SN 75-684,216. PUB. 5-23-2000, FILED 4-16-1999.

TOUCHING LIVES WITH BEAUTY AND EMOTION

FOR NEWSLETTERS FOR EMPLOYEES, SALES REPRESENTATIVES, CUSTOMERS AND COLLECTORS CLUB MEMBERS (U.S. CLS. 2, 5, 22, 23, 29, 37, 38 AND 50).

FIRST USE 4-30-1999; IN COMMERCE 4-30-1999.

2,534,547. PITANIELLO, KRISTINA, BOSTON, MA. SN 75-688,444. PUB. 6-13-2000, FILED 4-22-1999.

HOVER PEN

NO CLAIM IS MADE TO THE EXCLUSIVE RIGHT TO USE "PEN", APART FROM THE MARK AS SHOWN.

FOR WRITING INSTRUMENTS (U.S. CLS. 2, 5, 22, 23, 29, 37, 38 AND 50).

FIRST USE 8-18-2001; IN COMMERCE 8-18-2001.

2,534,568. COHEN BROWN PICTURE COMPANY, INC., LOS ANGELES, CA. SN 75-709,984. PUB. 1-11-2000, FILED 5-20-1999.

ONEFINANCIAL INSTITUTIONISM

FOR PRINTED MATTER, NAMELY, BOOKS, AND COURSE MATERIALS IN THE FIELDS OF BANKING, BROKERAGE, MORTGAGE, INSURANCE, AND FINANCE (U.S. CLS. 2, 5, 22, 23, 29, 37, 38 AND 50).

FIRST USE 9-19-1999; IN COMMERCE 9-0-1999.

2,534,575. FAULKNER EXPORT PACKAGING LIMITED, DUBLIN 20, IRELAND. SN 75-717,322. PUB. 1-23-2001, FILED 5-28-1999.

SNAZZYBAGS

FOR OPAQUE, TRANSLUCENT, METALLIC-COLOURED AND NON-METALLIC COLOURED, OPTIONALLY SELF-ADHESIVE, RE-SEALABLE OR HEAT-SEALABLE PLASTIC BAGS, PAPER AND PLASTIC MAIL POUCHES AND PAPER AND PLASTIC POUCHES FOR MERCHANDISE PACKAGING, PAPER AND PLASTIC FOR WRAPPING AND PACKAGING, GIFT BAGS (U.S. CLS. 2, 5, 22, 23, 29, 37, 38 AND 50).

FIRST USE 8-18-1999; IN COMMERCE 8-18-1999.

CLASS 16—(Continued).

2,534,589. AMERICAN NUCLEAR SOCIETY INCORPORATED, LA GRANGE PARK, IL. SN 75-736,470. PUB. 3-6-2001, FILED 6-24-1999.

RADWASTE SOLUTIONS

NO CLAIM IS MADE TO THE EXCLUSIVE RIGHT TO USE "RADWASTE", APART FROM THE MARK AS SHOWN.

FOR MAGAZINE CONCERNING SCIENTIFIC AND ENGINEERING SUBJECTS (U.S. CLS. 2, 5, 22, 23, 29, 37, 38 AND 50).

FIRST USE 1-21-2000; IN COMMERCE 1-21-2000.

2,534,601. HALLINAN, JAMES D., GLEN MILLS, PA. SN 75-743,816. PUB. 6-6-2000, FILED 7-6-1999.

POEM POWER

NO CLAIM IS MADE TO THE EXCLUSIVE RIGHT TO USE "POEM", APART FROM THE MARK AS SHOWN.

FOR POETRY BOOKS, INSPIRATION CALENDARS FEATURING POETRY, JOURNALS FEATURING POETRY, BOOKMARKS AND GREETING CARDS (U.S. CLS. 2, 5, 22, 23, 29, 37, 38 AND 50).

FIRST USE 12-11-1998; IN COMMERCE 10-20-2001.

2,534,607. YOUNG LIFE, COLORADO SPRINGS, CO. SN 75-747,402. PUB. 2-22-2000, FILED 7-12-1999.

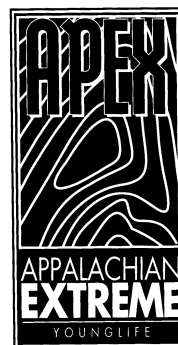

NO CLAIM IS MADE TO THE EXCLUSIVE RIGHT TO USE "APPALACHIAN", APART FROM THE MARK AS SHOWN.

FOR PRINTED MATERIALS, NAMELY NEWSLETTERS, PERIODICALS, AND NOTEPADS, FEATURING INFORMATION ABOUT ACTIVITIES, PROGRAMS AND ENTERTAINMENT AT A YOUTH CAMP LOCATED IN THE APPALACHIAN MOUNTAINS (U.S. CLS. 2, 5, 22, 23, 29, 37, 38 AND 50).

FIRST USE 11-5-1998; IN COMMERCE 5-30-1999.

CLASS 16—(Continued).

2,534,652. MILLER, RUSSELL, NEW YORK, NY. SN 75-802,009. PUB. 11-28-2000, FILED 9-17-1999.

FIDGET

FOR MAGAZINES IN THE FIELDS OF FASHION, MUSIC, CULTURE, AND CURRENT EVENTS (U.S. CLS. 2, 5, 22, 23, 29, 37, 38 AND 50).

FIRST USE 2-1-1996; IN COMMERCE 2-1-1996.

2,534,718. MOODY BIBLE INSTITUTE, CHICAGO, IL. SN 75-868,136. PUB. 4-17-2001, FILED 12-9-1999.

LIFE ESSENTIALS

FOR PERSONAL PLANNERS AND PERSONAL ORGANIZERS HAVING INSPIRATIONAL GUIDANCE AND TEXT (U.S. CLS. 2, 5, 22, 23, 29, 37, 38 AND 50).

FIRST USE 9-0-1999; IN COMMERCE 9-0-1999.

2,534,731. HEALTHDIRECTOR.COM, INCLINE VILLAGE, NV. SN 75-878,494. PUB. 11-7-2000, FILED 12-20-1999.

HEALTHDIRECTOR.COM

FOR MEDICAL REPORTS IN PRINTED FORM (U.S. CLS. 2, 5, 22, 23, 29, 37, 38 AND 50).

FIRST USE 4-0-2000; IN COMMERCE 4-0-2000.

2,534,734. MCGRAW-HILL COMPANIES, INC., THE, NEW YORK, NY, BY MERGER; BY MERGER EVERYDAY LEARNING CORPORATION, CHICAGO, IL. SN 75-880,791. PUB. 11-7-2000, FILED 12-21-1999.

MEEKS HEIT

FOR BOOKS, BOOKLETS, WORK SHEETS, CHARTS AND CARDS, FEATURING EDUCATIONAL MATERIAL ON HEALTH (U.S. CLS. 2, 5, 22, 23, 29, 37, 38 AND 50).

FIRST USE 6-0-1998; IN COMMERCE 6-0-1998.

2,534,770. BJS PARTNERS, ST. LOUIS, MO. SN 75-922,538. PUB. 11-21-2000, FILED 2-18-2000.

SPEEDBUMPS

FOR RAISED STICKERS FOR MARKING KEYS ON KEYBOARDS AND KEYPADS (U.S. CLS. 2, 5, 22, 23, 29, 37, 38 AND 50).

FIRST USE 8-8-2001; IN COMMERCE 8-8-2001.

CLASS 16—(Continued).

2,534,789. BELZ INVESTCO GP, MEMPHIS, TN. SN 75-935,888. PUB. 10-17-2000, FILED 3-6-2000.

COME DOWNTOWN AND PLAY

FOR GENERAL CIRCULAR NEWSPAPER, POSTERS, CALENDARS, JOURNALS, PAMPHLETS AND BROCHURES PROMOTING TOURISM (U.S. CLS. 2, 5, 22, 23, 29, 37, 38 AND 50).

FIRST USE 4-1-2000; IN COMMERCE 4-1-2000.

2,534,790. PROJECT EXPLORATION, CHICAGO, IL. SN 75-939,382. PUB. 1-2-2001, FILED 3-9-2000.

PROJECT EXPLORATION

FOR PRINTED EDUCATIONAL MATERIALS, NAMELY, TEXT BOOKS, POSTERS, FLYERS AND WORKBOOKS IN THE FIELD OF PALEONTOLOGY (U.S. CLS. 2, 5, 22, 23, 29, 37, 38 AND 50).

FIRST USE 10-9-1999; IN COMMERCE 10-9-1999.

2,534,818. KENSINGTON PUBLISHING CORP., NEW YORK, NY. SN 76-004,214. PUB. 12-5-2000, FILED 3-20-2000.

DAFINA

THE ENGLISH TRANSLATION OF "DAFINA" IS "UNEXPECTED GIFT".

FOR SERIES OF FICTION AND NONFICTION BOOKS OF INTEREST TO AFRICAN-AMERICANS (U.S. CLS. 2, 5, 22, 23, 29, 37, 38 AND 50).

FIRST USE 10-12-2000; IN COMMERCE 10-12-2000.

2,534,828. AVANTAGE GROUP, INC., THE, REDONDO BEACH, CA. SN 76-011,023. PUB. 12-19-2000, FILED 3-24-2000.

HANDLESTAR

FOR TRASH BAGS (U.S. CLS. 2, 5, 22, 23, 29, 37, 38 AND 50).

FIRST USE 10-26-2001; IN COMMERCE 10-26-2001.

2,534,834. BALL, DON, BEND, OR. SN 76-014,704. PUB. 12-12-2000, FILED 3-31-2000.

GUY FLOWERS

FOR PAPER AND CARDBOARD CONTAINERS FOR CARRYING BEVERAGE CANS AND BOTTLES (U.S. CLS. 2, 5, 22, 23, 29, 37, 38 AND 50).

FIRST USE 3-31-2001; IN COMMERCE 3-31-2001.

CLASS 16—(Continued).

2,534,860. ENSZ, MARIANNE, PRAIRIE VILLAGE, KS. SN 76-035,664. PUB. 12-12-2000, FILED 4-26-2000.

WEE PRAY

NO CLAIM IS MADE TO THE EXCLUSIVE RIGHT TO USE "PRAY", APART FROM THE MARK AS SHOWN.

FOR BOOKS, BOOKLETS, AND PREPRINTED PIECES OF PAPER AND PREPRINTED STRIPS OF PAPER FEATURING QUESTIONS DESIGNED TO STIMULATE PRAYER IN VARIOUS SETTINGS (U.S. CLS. 2, 5, 22, 23, 29, 37, 38 AND 50).

FIRST USE 8-31-2001; IN COMMERCE 8-31-2001.

2,534,861. GEORGIA-PACIFIC CORPORATION, ATLANTA, GA. SN 76-035,886. PUB. 12-5-2000, FILED 4-27-2000.

FLOWKRAFT

FOR BLEACHED AND UNBLEACHED KRAFT PAPER (U.S. CLS. 2, 5, 22, 23, 29, 37, 38 AND 50).

FIRST USE 9-5-2000; IN COMMERCE 9-5-2000.

2,534,896. GLOBAL BUSINESS DIALOGUE, INC., THE, WASHINGTON, DC. SN 76-062,365. PUB. 3-13-2001, FILED 6-2-2000.

GLOBAL POSITIONS

FOR INTERNATIONAL BUSINESS AND TRADE NEWSLETTER (U.S. CLS. 2, 5, 22, 23, 29, 37, 38 AND 50).

FIRST USE 6-30-2000; IN COMMERCE 6-30-2000.

2,534,897. TIME INC., NEW YORK, NY. SN 76-063,866. PUB. 2-20-2001, FILED 6-8-2000.

**SAVE BUILD KNOWLEDGE
BUILD WEALTH**

FOR NEWSLETTERS IN THE FIELD OF FINANCE, INVESTMENTS AND TOPICS OF GENERAL INTEREST (U.S. CLS. 2, 5, 22, 23, 29, 37, 38 AND 50).

FIRST USE 9-0-2000; IN COMMERCE 9-0-2000.

2,534,899. MEAD CORPORATION, THE, DAYTON, OH. SN 76-074,353. PUB. 3-13-2001, FILED 6-21-2000.

INTELLI-GEAR

FOR BINDER, NAMELY, A BINDER COMBINED WITH SOFTWARE PERMITTING THE CONSUMER TO CUSTOMIZE ELEMENTS OF THE BINDER CONTENTS TO ACCOMMODATE CURRENT INTERESTS, SCHEDULE OR PERSONAL NEEDS OF THE CONSUMER (U.S. CLS. 2, 5, 22, 23, 29, 37, 38 AND 50).

FIRST USE 11-15-2000; IN COMMERCE 11-15-2000.

CLASS 16—(Continued).

2,534,904. RANDOM HOUSE, INC., NEW YORK, NY. SN 76-078,726. PUB. 5-8-2001, FILED 6-27-2000.

**VILLARD**

OWNER OF U.S. REG. NOS. 1,577,737, 1,604,558, AND 1,995,724.

THE STIPLING IS A FEATURE OF THE MARK AND DOES NOT INDICATE COLOR.

FOR SERIES OF BOOKS ON A VARIETY OF SUBJECTS (U.S. CLS. 2, 5, 22, 23, 29, 37, 38 AND 50).

FIRST USE 8-14-2000; IN COMMERCE 8-14-2000.

2,534,913. LIFEWAY CHRISTIAN RESOURCES OF THE SOUTHERN BAPTIST CONVENTION, NASHVILLE, TN. SN 76-091,668. PUB. 4-10-2001, FILED 7-17-2000.

THE BODY LIFE JOURNEY

FOR PRINTED RELIGIOUS BOOKS, PRINTED RELIGIOUS MAGAZINES, STUDY GUIDES, AND NEWSLETTERS (U.S. CLS. 2, 5, 22, 23, 29, 37, 38 AND 50).

FIRST USE 4-2-2001; IN COMMERCE 4-2-2001.

2,534,926. ARRINGTON'S BED & BREAKFAST JOURNAL, L.P., MIDLAND, TX. SN 76-110,488. PUB. 5-8-2001, FILED 8-16-2000.

**ARRINGTON'S BED &
BREAKFAST JOURNAL**

NO CLAIM IS MADE TO THE EXCLUSIVE RIGHT TO USE "BED & BREAKFAST JOURNAL", APART FROM THE MARK AS SHOWN.

FOR TRADE PUBLICATION, NAMELY A MONTHLY MAGAZINE CONTAINING INFORMATION RELATING TO THE BED AND BREAKFAST INDUSTRY AND SPECIFICALLY TARGETED TO BED AND BREAKFAST AND COUNTRY INN OWNERS, OPERATORS, INNSITERS, AND ASPIRING OWNERS (U.S. CLS. 2, 5, 22, 23, 29, 37, 38 AND 50).

FIRST USE 10-25-2000; IN COMMERCE 10-25-2000.

CLASS 16—(Continued).

2,534,927. KENSINGTON PUBLISHING CORP., NEW YORK, NY. SN 76-110,503. PUB. 5-8-2001, FILED 8-16-2000.



FOR SERIES OF ROMANCE NOVELS (U.S. CLS. 2, 5, 22, 23, 29, 37, 38 AND 50).
FIRST USE 1-15-2001; IN COMMERCE 1-15-2001.

2,534,931. FOAMPRO MFG INC, IRVINE, CA. SN 76-120,699. PUB. 5-15-2001, FILED 9-5-2000.

TOUCH-UP-TIPS

FOR PAINT APPLICATORS FABRICATED FROM CELLULAR FOAM POLYMERS (U.S. CLS. 2, 5, 22, 23, 29, 37, 38 AND 50).
FIRST USE 5-1-2001; IN COMMERCE 5-1-2001.

2,534,933. PROSKAUER ROSE LLP, NEW YORK, NY. SN 76-129,285. PUB. 5-22-2001, FILED 9-15-2000.

**PROSKAUER ROSE
PRODUCE RESULTS**

OWNER OF U.S. REG. NO. 2,351,675.
FOR NEWSLETTERS PROVIDING INFORMATION ON LEGAL ISSUES (U.S. CLS. 2, 5, 22, 23, 29, 37, 38 AND 50).
FIRST USE 5-1-2001; IN COMMERCE 5-1-2001.

2,534,934. JUDY BERGSMA GALLERIES, INC., BELLINGHAM, WA. SN 76-134,386. PUB. 5-22-2001, FILED 9-25-2000.

HEARTFELT EXPRESSIONS

FOR GREETING CARDS (U.S. CLS. 2, 5, 22, 23, 29, 37, 38 AND 50).
FIRST USE 9-1-2000; IN COMMERCE 9-1-2000.

CLASS 16—(Continued).

2,534,955. MERCER, TODD, BRYANT, CHEBOYGAN, MI. SN 78-007,942. PUB. 12-26-2000, FILED 5-12-2000.

BIKE AND BREW AMERICA

NO CLAIM IS MADE TO THE EXCLUSIVE RIGHT TO USE "AMERICA", APART FROM THE MARK AS SHOWN.
FOR TRAVEL GUIDE PAIRING MOUNTAIN BIKE TRAILS AND BREWPUBS NATIONWIDE (U.S. CLS. 2, 5, 22, 23, 29, 37, 38 AND 50).
FIRST USE 8-15-1999; IN COMMERCE 3-15-2001.

2,534,958. SCOTT, DAVID, M, LEXINGTON, MA. SN 78-010,352. PUB. 5-8-2001, FILED 5-29-2000.



FOR FICTION AND NON-FICTION BOOKS ON A VARIETY OF SUBJECTS (U.S. CLS. 2, 5, 22, 23, 29, 37, 38 AND 50).
FIRST USE 8-1-2000; IN COMMERCE 10-1-2000.

2,534,961. HERO ARTS RUBBER STAMPS, INC., EMERYVILLE, CA. SN 78-011,634. PUB. 1-9-2001, FILED 6-7-2000.

INSPIRATION PRINTS

NO CLAIM IS MADE TO THE EXCLUSIVE RIGHT TO USE "PRINTS", APART FROM THE MARK AS SHOWN.
FOR DECORATIVE RUBBER STAMPS, DECORATIVE RUBBER STAMP SETS COMPRISED OF INK PAD AND ONE OR MORE DECORATIVE RUBBER STAMPS (U.S. CLS. 2, 5, 22, 23, 29, 37, 38 AND 50).
FIRST USE 7-0-2000; IN COMMERCE 7-0-2000.

2,534,963. SHELDON, ROBERT, VIRGINIA BEACH, VA. SN 78-013,853. PUB. 3-13-2001, FILED 6-21-2000.

CY KICK & MISS STICK

FOR COMIC STRIPS' COMIC FEATURES (U.S. CLS. 2, 5, 22, 23, 29, 37, 38 AND 50).
FIRST USE 7-23-2001; IN COMMERCE 7-23-2001.

CLASS 16—(Continued).

2,534,971. SMITH, GWENDOLYN K., NORTH HOLLYWOOD, CA. SN 78-015,557. PUB. 12-5-2000, FILED 7-5-2000.

MAGNETIC THOUGHTS

NO CLAIM IS MADE TO THE EXCLUSIVE RIGHT TO USE "MAGNETIC", APART FROM THE MARK AS SHOWN. FOR CALENDARS, NOTE PADS (U.S. CLS. 2, 5, 22, 23, 29, 37, 38 AND 50).
FIRST USE 12-1-2000; IN COMMERCE 12-1-2000.

CLASS 17—RUBBER GOODS

2,534,426. CHOU, TERRY, TAINAN CITY, TAIWAN. SN 75-467,373. PUB. 1-25-2000, FILED 4-13-1998.

SILTEX

FOR SYNTHETIC AND LATEX RUBBER FOR USE IN THE MANUFACTURE OF SWIMMING GOGGLES, SWIMMING CAPS, LIFE PRESERVERS, FLOATS FOR BUOYANTLY SUPPORTING A PERSON OR OBJECT ON WATER INCLUDING FLOATING PLATFORMS, BOOTS FOR UNDERWATER DIVING, TOY RUBBER RINGS FOR THROWING, AND PLASTIC IN BARS, BLOCKS, PELLETS, RODS, SHEETS AND TUBES FOR USE IN THE MANUFACTURE OF SWIMMING GOGGLES, SWIMMING CAPS, LIFE PRESERVERS, FLOATS FOR BUOYANTLY SUPPORTING A PERSON OR OBJECT ON WATER INCLUDING FLOATING PLATFORMS, BOOTS FOR UNDERWATER DIVING, SURF BOARDS, BODY BOARDS AND OTHER WATER BOARDS (U.S. CLS. 1, 5, 12, 13, 35 AND 50).
FIRST USE 1-1-1999; IN COMMERCE 1-1-1999.

2,534,796. NIEDNER LIMITED, COATICOOK, PQ, CANADA. SN 75-955,905. PUB. 11-28-2000, FILED 3-10-2000.

COLDTRAIL

FOR FIRE HOSE (U.S. CLS. 1, 5, 12, 13, 35 AND 50).
FIRST USE 12-1-2000; IN COMMERCE 12-1-2000.

CLASS 18—LEATHER GOODS

2,534,367. LEAPFROG ENTERPRISES, INC., EMERYVILLE, CA, ASSIGNEE OF; BY CHANGE OF NAME LEAPFROG, L.L.C., EMERYVILLE, CA. SN 75-238,938. PUB. 12-23-1997, FILED 2-10-1997.

LEAPFROG

FOR SCHOOL BAGS (U.S. CLS. 1, 2, 3, 22 AND 41).
FIRST USE 2-17-2000; IN COMMERCE 2-17-2000.

CLASS 18—(Continued).

2,534,411. RALPH, ROBERT J., PLEASANTON, CA. SN 75-422,907. PUB. 11-17-1998, FILED 1-26-1998.

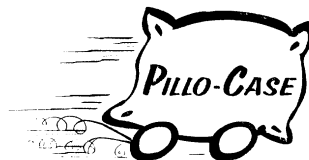

FOR TRAVEL/CARRY-ON BAGS FOR PERSONAL SLEEPING PILLOWS (U.S. CLS. 1, 2, 3, 22 AND 41).
FIRST USE 1-5-2001; IN COMMERCE 1-5-2001.

CLASS 19—NON-METALLIC BUILDING MATERIALS

2,534,455. STANDARD PLYWOODS, INC., DBA ANDERSON HARDWOOD FLOORS, CLINTON, SC. SN 75-526,611. PUB. 9-7-1999, FILED 7-28-1998.

ELEMENTS

FOR WOOD FLOORING (U.S. CLS. 1, 12, 33 AND 50).
FIRST USE 1-0-1999; IN COMMERCE 1-0-1999.

2,534,465. MPHI SA, 68510 SIERENTZ, FRANCE. SN 75-549,894. PUB. 5-16-2000, FILED 9-9-1998.

EXTENZO

FOR NON-METALLIC CEILING PANELS, FALSE CEILINGS AND SUSPENDED CEILINGS; NON-METALLIC VERTICAL AND HORIZONTAL PANELS AND WALLS FOR USE IN BUILDING CONSTRUCTION (U.S. CLS. 1, 12, 33 AND 50).
FIRST USE 0-0-1985; IN COMMERCE 0-0-1999.

2,534,604. SPECIALTY PRODUCTS & SERVICES, INC., SAN JOSE, CA. SN 75-745,634. PUB. 4-17-2001, FILED 7-8-1999.

UV2

FOR CORRUGATED POLYCARBONATE WALL AND ROOF PANELS AND SHEETS FOR USE IN GREENHOUSES AND CORRUGATED POLYCARBONATE PANELS USED AS GLAZING MATERIALS (U.S. CLS. 1, 12, 33 AND 50).
FIRST USE 6-0-1998; IN COMMERCE 6-0-1998.

CLASS 19—(Continued).

2,534,761. ALCOA INC., PITTSBURGH, PA. SN 75-913,200.
PUB. 9-26-2000, FILED 2-7-2000.

ENDURING ELEGANCE

FOR NON-METALLIC SHUTTERS FOR EXTERIOR USE ON BUILDINGS (U.S. CLS. 1, 12, 33 AND 50).
FIRST USE 7-1-2001; IN COMMERCE 7-1-2001.

2,534,785. GORELL ENTERPRISES, INC., INDIANA, PA. SN 75-932,815. PUB. 4-10-2001, FILED 2-25-2000.

STARVIEW

FOR NEW CONSTRUCTION VINYL WINDOWS (U.S. CLS. 1, 12, 33 AND 50).
FIRST USE 9-1-1999; IN COMMERCE 9-1-1999.

2,534,815. INTERNATIONAL AMERICAN CERAMICS, INC., TULSA, OK. SN 76-000,818. PUB. 12-19-2000, FILED 3-15-2000.

MONUMENT

FOR CERAMIC TILE (U.S. CLS. 1, 12, 33 AND 50).
FIRST USE 1-9-2001; IN COMMERCE 1-9-2001.

2,534,983. ALCOA INC., PITTSBURGH, PA. SN 78-028,539. PUB. 6-5-2001, FILED 10-2-2000.

PREMIUM DESIGN. PROVEN PERFORMANCE.

FOR VINYL SIDING AND VINYL SOFFIT (U.S. CLS. 1, 12, 33 AND 50).
FIRST USE 4-15-2001; IN COMMERCE 4-15-2001.

CLASS 20—FURNITURE AND ARTICLES NOT OTHERWISE CLASSIFIED

2,534,357. ETW CORP., CLEVELAND, OH. SN 75-177,177. PUB. 8-26-1997, FILED 10-4-1996.

TIGER WOODS

"TIGER WOODS" IS THE NAME OF A LIVING INDIVIDUAL WHOSE CONSENT IS OF RECORD.
FOR PLAQUES (U.S. CLS. 2, 13, 22, 25, 32 AND 50).
FIRST USE 7-1-1998; IN COMMERCE 7-1-1998.

CLASS 20—(Continued).

2,534,386. LUCASFILM LTD., NICASIO, CA. SN 75-306,997. PUB. 9-15-1998, FILED 6-11-1997.

STAR WARS

FOR SHOWCASES FOR COLLECTIBLES, AND SLEEPING BAGS (U.S. CLS. 2, 13, 22, 25, 32 AND 50).
FIRST USE 5-31-1999; IN COMMERCE 5-31-1999.

2,534,407. TINKER'S DEN, TORRANCE, CA. SN 75-403,623. PUB. 5-18-1999, FILED 12-11-1997.

L'IL DAVINCI

FOR PICTURE FRAMES FOR STORAGE AND DISPLAY OF SEVERAL PHOTOGRAPHS (U.S. CLS. 2, 13, 22, 25, 32 AND 50).
FIRST USE 7-0-1998; IN COMMERCE 7-0-1998.

2,534,549. L&P PROPERTY MANAGEMENT COMPANY, SOUTH GATE, CA. SN 75-689,571. PUB. 12-21-1999, FILED 4-22-1999.

SLEEPING IN THE SPRING RATHER THAN ON IT

FOR MATTRESSES AND BOX SPRINGS (U.S. CLS. 2, 13, 22, 25, 32 AND 50).
FIRST USE 8-17-2001; IN COMMERCE 8-17-2001.

2,534,745. PRODUCTS UNLIMITED, INC., OMAHA, NE. SN 75-893,753. PUB. 8-22-2000, FILED 1-10-2000.



FOR PILLOWS (U.S. CLS. 2, 13, 22, 25, 32 AND 50).
FIRST USE 8-1-1999; IN COMMERCE 12-1-1999.

CLASS 20—(Continued).

2,534,930. ASHLAND, INC., COVINGTON, KY. SN 76-117,314. PUB. 5-8-2001, FILED 8-25-2000.

SPIRIT

FOR NOVELTY ITEM, NAMELY, A RUBBERIZED, PEELABLE FOAM OR PLIABLE SPONGE-LIKE COMPOSITION DISPENSED IN THE FORM OF FOAM FROM AN AEROSOL CAN USED FOR DECORATING NON POROUS SURFACES SUCH AS PAINTED SURFACES AND GLASS (U.S. CLS. 2, 13, 22, 25, 32 AND 50).

FIRST USE 9-0-2000; IN COMMERCE 8-0-2001.

CLASS 21—(Continued).

2,534,622. GEIER, PAULA, CAMDENTON, MO. SN 75-769,701. PUB. 11-14-2000, FILED 8-6-1999.



FOR CONTAINERS AND THE LIDS THEREFOR USED TO HOLD VETERINARY MEDICINE (U.S. CLS. 2, 13, 23, 29, 30, 33, 40 AND 50).

FIRST USE 1-0-1999; IN COMMERCE 9-0-1999.

2,534,945. LOTTO DESIGN GROUP, THE, WESTLAKE VIL-LAGE, CA. SN 78-002,684. PUB. 2-27-2001, FILED 4-5-2000.

DESIGNITURE

FOR CUSTOM DESIGNED FURNITURE (U.S. CLS. 2, 13, 22, 25, 32 AND 50).

FIRST USE 1-1-2001; IN COMMERCE 1-1-2001.

2,534,689. BAYER CORPORATION, ELKHART, IN. SN 75-836,845. PUB. 6-13-2000, FILED 11-1-1999.

OUTPOST**CLASS 21—HOUSEWARES AND GLASS**

2,534,418. JOHNSON & JOHNSON, NEW BRUNSWICK, NJ. SN 75-454,697. PUB. 5-15-2001, FILED 3-23-1998.

REACH POWERBRUSH

OWNER OF U.S. REG. NOS. 1,031,482, 1,987,868, AND OTHERS.

NO CLAIM IS MADE TO THE EXCLUSIVE RIGHT TO USE "POWERBRUSH", APART FROM THE MARK AS SHOWN.

FOR BATTERY-OPERATED TOOTHBRUSH (U.S. CLS. 2, 13, 23, 29, 30, 33, 40 AND 50).

FIRST USE 8-31-1998; IN COMMERCE 8-31-1998.

FOR NON-METAL CONTAINERS FOR USE WITH CHEMICAL INSECTICIDES FOR INSERTION IN AND AROUND BUILDINGS AND STRUCTURES, TO KILL TERMITES (U.S. CLS. 2, 13, 23, 29, 30, 33, 40 AND 50).

FIRST USE 3-31-2001; IN COMMERCE 3-31-2001.

2,534,695. TEN REN TEA CO., LTD., TAIPEI, TAIWAN. SN 75-839,582. PUB. 5-1-2001, FILED 11-3-1999.



2,534,565. US JESCO INTERNATIONAL LTD. INC., CAR-ROLLTON, TX. SN 75-707,009. PUB. 7-25-2000, FILED 5-14-1999.

EURO CLEAN

NO CLAIM IS MADE TO THE EXCLUSIVE RIGHT TO USE "CLEAN", APART FROM THE MARK AS SHOWN.

FOR HOUSEHOLD CLEANING PRODUCTS, NAMELY PVA MOPS, CHAMOIS CLOTHS, SPONGES AND CLEANING CLOTHS (U.S. CLS. 2, 13, 23, 29, 30, 33, 40 AND 50).

FIRST USE 8-8-1999; IN COMMERCE 8-8-1999.

OWNER OF U.S. REG. NO. 1,541,755.
THE TRANSLITERATION OF THE CHINESE CHARACTERS IN THE MARK ARE "TEN" MEANING "SKY" AND "REN'S" MEANING "HUMANITY".

FOR TEA INFUSING BALLS NOT OF PRECIOUS METAL, TEA CADDIES NOT OF PRECIOUS METAL, TEA INFUSERS NOT OF PRECIOUS METAL, TEA SERVICE NOT OF PRECIOUS METAL, TEA STRAINERS NOT OF PRECIOUS METAL, TEAPOTS NOT OF PRECIOUS METAL, CUPS NOT OF PRECIOUS METAL (U.S. CLS. 2, 13, 23, 29, 30, 33, 40 AND 50).

FIRST USE 0-0-1953; IN COMMERCE 0-0-1984.

CLASS 21—(Continued).

2,534,747. BAGDON, MARK D., RIO RANCHO, NM. SN 75-899,767. PUB. 12-5-2000, FILED 1-21-2000.

UNLOCK THE ADVENTURE

FOR NON-METAL GAME BOXES (U.S. CLS. 2, 13, 23, 29, 30, 33, 40 AND 50).
FIRST USE 3-1-2000; IN COMMERCE 5-1-2000.

2,534,891. SCHAFER SYSTEMS INC., ADAIR, IA. SN 76-058,517. PUB. 3-27-2001, FILED 5-30-2000.

WATCHDOG

FOR LOTTERY TICKET DISPENSERS (U.S. CLS. 2, 13, 23, 29, 30, 33, 40 AND 50).
FIRST USE 7-15-2001; IN COMMERCE 7-15-2001.

2,534,952. EDDIE BAUER, INC., REDMOND, WA. SN 78-006,445. PUB. 1-16-2001, FILED 5-2-2000.

EDDIE BAUER

OWNER OF U.S. REG. NOS. 880,279, 994,152, AND 2,237,509.
FOR COOKWARE FOR CAMPING, NAMELY, POTS, PANS, PLATES, BOWLS AND CUPS (U.S. CLS. 2, 13, 23, 29, 30, 33, 40 AND 50).
FIRST USE 2-1-2001; IN COMMERCE 2-1-2001.

2,534,980. ROSE, ANDREW, DAVID, SCOTTSDALE, AZ. SN 78-022,148. PUB. 4-17-2001, FILED 8-21-2000.

AIRBASE

FOR HOUSEPLANT POT INSERT THAT ALLOWS WATER TO DRAIN AWAY AND LEAVES AN AIR POCKET UNDERNEATH THE SOIL (U.S. CLS. 2, 13, 23, 29, 30, 33, 40 AND 50).
FIRST USE 8-15-2000; IN COMMERCE 8-27-2001.

CLASS 22—CORDAGE AND FIBERS

2,534,350. DANA DESIGN, LTD., BOZEMAN, MT. SN 75-009,821. PUB. 10-1-1996, FILED 10-24-1995.

DANA DESIGN

OWNER OF U.S. REG. NO. 1,691,557.
NO CLAIM IS MADE TO THE EXCLUSIVE RIGHT TO USE "DESIGN", APART FROM THE MARK AS SHOWN.
FOR TENTS SOLD EXCLUSIVELY IN SPORTING GOODS, OUTDOOR AND MOUNTAINEERING SHOPS (U.S. CLS. 1, 2, 7, 19, 22, 42 AND 50).
FIRST USE 3-0-1996; IN COMMERCE 3-0-1996.

CLASS 24—FABRICS

2,534,422. JPS CONVERTER AND INDUSTRIAL CORPORATION, SLATER, SC. SN 75-464,070. PUB. 10-5-1999, FILED 4-7-1998.

STANDARDFLEX

FOR OPEN MESH FIBER GLASS FABRIC USED AS SUBSTRATE FOR REINFORCING POLYMERIC STRUCTURES AND DECORATIVE ARCHITECTURAL COMPONENTS (U.S. CLS. 42 AND 50).
FIRST USE 1-11-1999; IN COMMERCE 1-11-1999.

2,534,680. SPRINGS INDUSTRIES, INC., FORT MILL, SC. SN 75-830,823. PUB. 6-20-2000, FILED 10-25-1999.

EGYPTIAN COMFORT

NO CLAIM IS MADE TO THE EXCLUSIVE RIGHT TO USE "EGYPTIAN", APART FROM THE MARK AS SHOWN.
FOR BED SHEETS, AND PILLOWCASES (U.S. CLS. 42 AND 50).
FIRST USE 12-0-1999; IN COMMERCE 12-0-1999.

CLASS 25—CLOTHING

2,534,346. AUTHENTIC FITNESS PRODUCTS INC., VAN NUYS, CA. SN 74-561,936. PUB. 5-6-1997, FILED 8-17-1994.

AUTHENTIC SPORT BRA

NO CLAIM IS MADE TO THE EXCLUSIVE RIGHT TO USE "SPORT BRA", APART FROM THE MARK AS SHOWN.
FOR INTIMATE APPAREL, NAMELY BRAS, SPORTS BRAS, CROP TOPS, BRIEFS, PANTIES, SLIPS, BODYSUITS AND CAMISOLES (U.S. CLS. 22 AND 39).
FIRST USE 12-8-2000; IN COMMERCE 12-8-2000.

2,534,366. INTERNATIONAL NYLONS, INC., METAIRIE, LA. SN 75-234,192. PUB. 12-2-1997, FILED 1-31-1997.

A PAIR-N-A SPARE

FOR CLOTHING, NAMELY, PANTYHOSE (U.S. CLS. 22 AND 39).
FIRST USE 7-14-2001; IN COMMERCE 7-14-2001.

CLASS 25—(Continued).

2,534,385. LUCASFILM LTD., NICASIO, CA. SN 75-306,994. PUB. 9-29-1998, FILED 6-11-1997.

STAR WARS

FOR ATHLETIC SHOES, BOXER SHORTS, CAPS, CHILDREN'S FOOTWEAR, HATS, HEAD WEAR, KNIT CAPS, MASQUERADE COSTUMES, ACCESSORIES, AND MASKS SOLD IN CONNECTION THEREWITH, PAJAMAS, RAINWEAR, SHIRTS, SLEEPWEAR, SLIPPERS, SOCKS, SWEATPANTS, SWEATSHIRTS, TIES, T-SHIRTS, UNDERWEAR, AND WRISTBANDS (U.S. CLS. 22 AND 39).

FIRST USE 5-31-1999; IN COMMERCE 5-31-1999.

CLASS 25—(Continued).

2,534,444. DONALD J PLINER CONCEPTS, INC., MIAMI BEACH, FL. SN 75-501,673. PUB. 11-23-1999, FILED 6-12-1998.

DONALD J PLINER

OWNER OF U.S. REG. NOS. 1,991,045 AND 2,007,793. THE NAME IN THE MARK IDENTIFIES A LIVING INDIVIDUAL WHOSE CONSENT IS OF RECORD.

FOR MEN'S AND WOMEN'S CLOTHING, NAMELY, SCARVES, SPORTSWEAR, SWEATERS, T-SHIRTS, TIES, HATS, SWEATSHIRTS, SHORTS, OUTERWEAR, NAMELY, COATS AND JACKETS, HOSIERY AND MEN'S SHOES (U.S. CLS. 22 AND 39).

FIRST USE 9-0-1998; IN COMMERCE 10-0-1998.

2,534,406. HARDCAP LLC, NEW YORK, NY, BY CHANGE OF NAME QUARTET PRODUCTS, LLC, NEW YORK, NY. SN 75-397,754. PUB. 12-22-1998, FILED 12-1-1997.

BARRETT GIRL

NO CLAIM IS MADE TO THE EXCLUSIVE RIGHT TO USE "GIRL", APART FROM THE MARK AS SHOWN.

FOR WOMEN'S CLOTHING, NAMELY, SCARVES, HATS AND BELTS (U.S. CLS. 22 AND 39).

FIRST USE 3-16-2001; IN COMMERCE 3-16-2001.

2,534,492. GATES-MILLS, INC., JOHNSTOWN, NY. SN 75-603,250. PUB. 11-2-1999, FILED 12-10-1998.

CAMO-TEK

FOR GLOVES (U.S. CLS. 22 AND 39).

FIRST USE 8-15-1999; IN COMMERCE 8-15-1999.

2,534,413. BRIGHTHOUSE, LLC, ATLANTA, GA, BY ASSIGNMENT GGT U.S.A./SOUTH, INC., DBA BRIGHTHOUSE, ATLANTA, GA. SN 75-429,746. PUB. 11-30-1999, FILED 2-6-1998.

2,534,493. ZOOMERS, INC., BROOKLYN, NY. SN 75-603,290. PUB. 12-5-2000, FILED 12-10-1998.

**PLANET MOTHERHOOD
2000****THINKING FOR A LIVING**

FOR CLOTHING FOR MEN, WOMEN AND CHILDREN, NAMELY, CAPS, GOLF SHIRTS, SPORT SHIRTS, POLO SHIRTS, T-SHIRTS, JACKETS, SWEATERS, SWEAT BANDS, SWEAT SHIRTS, SWEAT SHORTS, JOGGING SUITS, AND WARM-UP SUITS (U.S. CLS. 22 AND 39).

FIRST USE 4-0-1998; IN COMMERCE 4-0-1998.

FOR CLOTHING FOR ADULTS, TEENAGERS, CHILDREN AND BABIES, NAMELY, SHIRTS, T-SHIRTS, DRESSES, SWEAT SHIRTS, PANTS, SWEAT PANTS, SHORTS, COATS, JACKETS, WARM-UP SUITS, TANK SHIRTS, GOLF SHIRTS, BRIEFS, BATHING SUITS, BATHING TRUNKS, BEACH CLOTHES, HATS, VISORS, JERSEYS, NECKTIES, PAJAMAS, MATERNITY CLOTHING, JUMPERS, SLEEPERS, ROMPERS, CROMPERS, BIBS, CLOTH DIAPERS, SOCKS, SHOES, BOOTS AND BOOTIES (U.S. CLS. 22 AND 39).

FIRST USE 7-27-2001; IN COMMERCE 7-27-2001.

2,534,417. AMERISPORT, L.L.C., NEW YORK, NY. SN 75-447,459. PUB. 10-12-1999, FILED 3-10-1998.

AMERIPRO

FOR MEN'S, WOMEN'S, CHILDREN'S, INFANT'S AND TODDLER'S CLOTHING, NAMELY, JOGGING SUITS, PANTS, SHORTS, JACKETS AND T-SHIRTS (U.S. CLS. 22 AND 39).

FIRST USE 11-25-2000; IN COMMERCE 12-10-2000.

2,534,502. HIGH FIVE ENTERTAINMENT, INC, NASHVILLE, TN. SN 75-619,804. PUB. 11-9-1999, FILED 1-12-1999.

SECRETS OF THE HUNT

OWNER OF U.S. REG. NOS. 2,358,699 AND 2,483,012. FOR CLOTHING, NAMELY, SHIRTS, SLACKS, PANTS, SHORTS, SOCKS, SHOES, BOOTS, UNDERWEAR, COATS, JACKETS, HATS, GLOVES, COVERALLS, SWEATSHIRTS, T-SHIRTS AND RAINWEAR (U.S. CLS. 22 AND 39).

FIRST USE 1-1-2001; IN COMMERCE 1-1-2001.

CLASS 25—(Continued).

2,534,507. TRENDS CLOTHING CORP., HIALEAH GARDENS, FL. SN 75-628,286. PUB. 4-11-2000, FILED 1-27-1999.

X-ISSUE

FOR CLOTHING, NAMELY SHIRTS, SLACKS, DRESSES, SHORTS, TOPS, SWEATSHIRTS, T-SHIRTS, SKIRTS, BLOUSES AND JACKETS (U.S. CLS. 22 AND 39).

FIRST USE 2-1-2000; IN COMMERCE 2-1-2000.



2,534,520. WILLIFORD, LAWRENCE RICHARD, YORBA LINDA, CA. SN 75-648,679. PUB. 2-15-2000, FILED 2-25-1999.



FOR CLOTHING FOR WOMEN, NAMELY, SHIRTS, PANTS, AND SHOES (U.S. CLS. 22 AND 39).
FIRST USE 5-6-1999; IN COMMERCE 5-6-1999.



2,534,522. WEYCO GROUP, INC., MILWAUKEE, WI. SN 75-651,632. PUB. 12-5-2000, FILED 3-2-1999.

SA STACY ADAMS

OWNER OF U.S. REG. NOS. 380,669, 1,522,719, AND 2,177,612.

THE NAME "STACY ADAMS" DOES NOT IDENTIFY A LIVING INDIVIDUAL.

FOR MEN'S CLOTHING AND TAILORED CLOTHING, NAMELY, SHIRTS, SUITS, SPORT COATS, TUXEDOS, PANTS UNDERWEAR, SOCKS, BELTS, SUSPENDERS, HATS AND NECKWEAR (U.S. CLS. 22 AND 39).

FIRST USE 10-0-1998; IN COMMERCE 10-0-1998.



2,534,538. AVENUE, INC., THE, WILMINGTON, DE. SN 75-679,659. PUB. 1-23-2001, FILED 4-12-1999.

AVENUE BODY

OWNER OF U.S. REG. NOS. 1,563,443, 2,218,272, AND OTHERS.

FOR SLEEPWEAR, ROBES, PANTIES, BRAS, LINGERIE, UNDERGARMENTS, CHEMISE, TOPS, NEGLIGENCE, STOCKINGS, PANTYHOSE, GIRDLES (U.S. CLS. 22 AND 39).

FIRST USE 11-0-1999; IN COMMERCE 11-0-1999.

CLASS 25—(Continued).

2,534,563. OHARA, MICHIKO, ARCADIA, CA. SN 75-704,187. PUB. 4-11-2000, FILED 5-10-1999.



FOR CLOTHING AND HEADGEAR, NAMELY, PANTS, SHIRTS, SHORTS, JACKETS, DRESSES, SKIRTS, SWEATERS, SWEATSHIRTS, SWEATPANTS, SOCKS, AND HATS (U.S. CLS. 22 AND 39).

FIRST USE 6-0-1999; IN COMMERCE 2-7-2001.



2,534,579. OLD NAVY (APPAREL) INC., SAN BRUNO, CA. SN 75-719,382. PUB. 7-25-2000, FILED 6-2-1999.

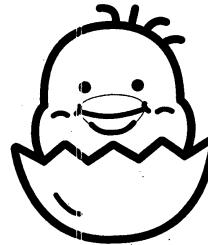

FOR CLOTH BIBS AND SOCKS (U.S. CLS. 22 AND 39).
FIRST USE 1-0-2000; IN COMMERCE 1-0-2000.

CLASS 25—(Continued).

2,534,616. CARTOON NETWORK LP, LLLP, ATLANTA, GA.
SN 75-759,038. PUB. 8-1-2000, FILED 7-23-1999.



FOR CLOTHING FOR MEN, WOMEN AND CHILDREN, NAMELY, SHIRTS, T-SHIRTS, SWEATSHIRTS, JOGGING SUITS, TROUSERS, JEANS, SHORTS, TANK TOPS, RAINWEAR, CLOTH BIBS, SKIRTS, BLOUSES, DRESSES, SUSPENDERS, SWEATERS, JACKETS, COATS, RAINCOATS, SNOWSUITS, TIES, ROBES, HATS, CAPS, SUNVISORS, BELTS, SCARVES, SLEEPWEAR, PAJAMAS, LINGERIE, UNDERWEAR, BOXER SHORTS, SOCKS, SHOES, SWIMWEAR, AND COSTUMES MASKS IN CONNECTION WITH MASQUERADE COSTUMES (U.S. CLS. 22 AND 39).

FIRST USE 8-27-2001; IN COMMERCE 8-27-2001.

2,534,643. BRANCH OFFICE, INC., THE, ALEXANDRIA, IN.
SN 75-796,243. PUB. 2-22-2000, FILED 9-8-1999.

FRITZ THE BIRD

FOR CHILDREN'S CLOTHING, NAMELY, SHIRTS, T-SHIRTS, SWEATSHIRTS, SOCKS, SLEEPWEAR, JACKETS, COATS, HATS, CAPS, UNDERWEAR, FOOTWEAR AND RAINWEAR (U.S. CLS. 22 AND 39).

FIRST USE 9-8-1999; IN COMMERCE 7-10-2001.

2,534,649. HUGGER-MUGGER YOGA PRODUCTS, LLC,
SALT LAKE CITY, UT. SN 75-800,564. PUB. 9-26-2000,
FILED 10-12-1999.

YOGATARD

FOR EXERCISE CLOTHING, NAMELY, ONE PIECE BODY SUIT FOR WEAR DURING YOGA AND OTHER FITNESS ACTIVITIES (U.S. CLS. 22 AND 39).

FIRST USE 6-0-1999; IN COMMERCE 6-0-1999.

CLASS 25—(Continued).

2,534,664. OLIVER BRYAN THAMES, DBA BULLS BAY SUPPLY, INC., MCCLELLANVILLE, SC. SN 75-815,522.
PUB. 12-5-2000, FILED 10-27-1999.

PALMETTO REPUBLIC

NO CLAIM IS MADE TO THE EXCLUSIVE RIGHT TO USE "PALMETTO", APART FROM THE MARK AS SHOWN. FOR CLOTHING, NAMELY SHIRTS, PANTS, HATS, BELTS, SHORTS, JACKETS, VESTS, AND SCARVES (U.S. CLS. 22 AND 39).

FIRST USE 10-5-2000; IN COMMERCE 10-5-2000.

2,534,670. ANDERSON, THOMAS M., BIRMINGHAM, MI.
SN 75-824,081. PUB. 11-14-2000, FILED 10-15-1999.

SHUT UP AND SKI

OWNER OF U.S. REG. NO. 1,974,472.

FOR CLOTHING; NAMELY, TEE-SHIRTS, SHORTS, SWEATSUITS, SHOES, LEOTARDS, LEGGINGS, SLIPPERS AND TOPS (U.S. CLS. 22 AND 39).

FIRST USE 1-0-2000; IN COMMERCE 1-0-2000.

2,534,672. Q.C. CUTTING CORP., BROOKLYN, NY. SN 75-824,897. PUB. 11-21-2000, FILED 10-18-1999.

KRISTIN NICOLE

THE NAME "KRISTIN NICOLE" DOES NOT IDENTIFY A LIVING INDIVIDUAL.

FOR MEN'S CLOTHING, NAMELY, SUITS, SHIRTS, SWEATERS, PANTS, SHOES, SOCKS, UNDERWEAR, BELTS, AND TIES; AND WOMEN'S CLOTHING, NAMELY, DRESSES, SKIRTS, PANTS, BLOUSES, JACKETS, SHOES, BATS, BELTS, SCARVES, UNDERWEAR, AND HOSIERY (U.S. CLS. 22 AND 39).

FIRST USE 10-29-1999; IN COMMERCE 10-29-1999.

2,534,690. SHANE-HUNTER, INC., DBA AQUA BLUES, SAN FRANCISCO, CA. SN 75-837,124. PUB. 11-21-2000, FILED 11-1-1999.

AQUA BLUES

OWNER OF U.S. REG. NO. 1,769,363.

FOR MEN'S AND BOYS' CLOTHING, NAMELY PANTS, SHIRTS, SWEATERS, SUITS, COATS, JACKETS, OVERALLS, CAPS, HATS, BELTS, NECKTIES, SCARVES, SWIMSUITS, ROBES, GLOVES, UNDERWEAR, SOCKS, AND FOOTWEAR INCLUDING BOOTS, SHOES, SANDALS, AND SLIPPERS (U.S. CLS. 22 AND 39).

FIRST USE 11-22-2000; IN COMMERCE 11-22-2000.

CLASS 25—(Continued).

2,534,699. BETSY KARP, L.L.C., WOODBURY, NY. SN 75-843,043. PUB. 8-29-2000, FILED 11-5-1999.

BETSY KARP

"BETSY KARP" IDENTIFIES A LIVING INDIVIDUAL WHOSE CONSENT IS OF RECORD. FOR CLOTHING, NAMELY WOMEN'S TOPS, VESTS AND SKIRTS (U.S. CLS. 22 AND 39). FIRST USE 10-16-2000; IN COMMERCE 10-16-2000.

2,534,902. HOCKENBURY, RITA M., HOUSTON, TX. SN 76-077,236. PUB. 3-13-2001, FILED 6-23-2000.

vizini

THE MARK CONSISTS OF THE STYLIZED WORD "VIZINI" WITH THE "IS" IN THE SHAPE OF A CRESCENT MOON. FOR HEADWEAR (U.S. CLS. 22 AND 39). FIRST USE 7-15-2001; IN COMMERCE 7-28-2001.

CLASS 26—FANCY GOODS

2,534,617. STACHOWSKI, BARBARA C., ORINDA, CA. SN 75-759,544. PUB. 1-18-2000, FILED 7-26-1999.

HAIRAGAMI

FOR HAIR ACCESSORY, NAMELY A HAIR CLIP THAT IS USED ON REAL HAIR, WIGS, AND DOLL HAIR (U.S. CLS. 37, 39, 40, 42 AND 50). FIRST USE 3-0-2000; IN COMMERCE 3-0-2000.

CLASS 27—FLOOR COVERINGS

2,534,506. GODFREY HIRST AUSTRALIA PTY. LTD., VICTORIA 3220, AUSTRALIA. SN 75-627,428. PUB. 7-18-2000, FILED 1-21-1999.

SUPALOC

PRIORITY CLAIMED UNDER SEC. 44(D) ON AUSTRALIA APPLICATION NO. 768076, FILED 7-22-1998, REG. NO. 768076, DATED 7-22-1998, EXPIRES 7-22-2008. FOR CARPETS; CARPET UNDERLAYS; RUGS (U.S. CLS. 19, 20, 37, 42 AND 50). FIRST USE 11-30-1999; IN COMMERCE 10-31-2000.

CLASS 27—(Continued).

2,534,628. SHAW INDUSTRIES, INC., DALTON, GA. SN 75-774,790. PUB. 2-15-2000, FILED 8-13-1999.

**PATCRAFT COMMERCIAL
CARPET THE COMMON
SENSE OF STYLE**

OWNER OF U.S. REG. NOS. 1,923,818, 1,925,577, AND 2,251,270. NO CLAIM IS MADE TO THE EXCLUSIVE RIGHT TO USE "COMMERCIAL CARPET", APART FROM THE MARK AS SHOWN. FOR CARPETING (U.S. CLS. 19, 20, 37, 42 AND 50). FIRST USE 12-20-1999; IN COMMERCE 12-20-1999.

2,534,769. E. I. DU PONT DE NEMOURS AND COMPANY, WILMINGTON, DE. SN 75-921,434. PUB. 11-21-2000, FILED 2-17-2000.

ANTRON

OWNER OF U.S. REG. NOS. 706,147, 1,858,264, AND OTHERS. FOR CARPET AND RUGS (U.S. CLS. 19, 20, 37, 42 AND 50). FIRST USE 7-25-2001; IN COMMERCE 7-25-2001.

CLASS 28—TOYS AND SPORTING GOODS

2,534,353. GERWECK, JENNIFER L., NORTHPORT, NY. SN 75-088,213. PUB. 8-5-1997, FILED 4-15-1996.

THE GREAT PUPPY TYRONE

PRIORITY CLAIMED UNDER SEC. 44(D) ON GREAT BRITAIN APPLICATION NO. 75749601, FILED 5-12-1999, REG. NO. 001171149, DATED 5-12-1999, EXPIRES 5-12-2001. NO CLAIM IS MADE TO THE EXCLUSIVE RIGHT TO USE "PUPPY", APART FROM THE MARK AS SHOWN. THE NAME "TYRONE" DOES NOT IDENTIFY A LIVING INDIVIDUAL. FOR KITS COMPRISING STUFFED TOY ANIMALS AND ACCESSORIES THEREFOR, AND CHILDREN'S BOOKS SOLD AS A UNIT (U.S. CLS. 22, 23, 38 AND 50). FIRST USE 8-3-2000; IN COMMERCE 9-18-2000.

CLASS 28—(Continued).

2,534,365. SQUARE CO., LTD., MEGURO-KU, TOKYO, JAPAN. SN 75-226,760. PUB. 4-7-1998, FILED 1-16-1997.



OWNER OF U.S. REG. NOS. 1,731,282, 2,004,569, AND OTHERS.

NO CLAIM IS MADE TO THE EXCLUSIVE RIGHT TO USE "ORIGINAL TOYS", APART FROM THE MARK AS SHOWN.

FOR DOLLS, PLUSH DOLLS, TOY FIGURES, STUFFED ANIMALS (U.S. CLS. 22, 23, 38 AND 50). FIRST USE 1-0-1998; IN COMMERCE 1-0-1998.

2,534,384. LUCAS LICENSING LTD., NICASIO, CA. SN 75-306,939. PUB. 6-29-1999, FILED 6-11-1997.

GUNGAN

FOR TOY ACTION FIGURES (U.S. CLS. 22, 23, 38 AND 50). FIRST USE 5-31-2000; IN COMMERCE 5-31-2000.

2,534,415. SPRI MEDICAL & REHAB, NORTHBROOK, IL. SN 75-437,012. PUB. 9-22-1998, FILED 2-19-1998.

RESIST-A-BAND

FOR MANUALLY OPERATED EXERCISE EQUIPMENT, NAMELY, ELASTOMERIC MATERIALS WHICH PROVIDE RESISTANCE THROUGH ELONGATION (U.S. CLS. 22, 23, 38 AND 50).

FIRST USE 3-1-2000; IN COMMERCE 3-1-2000.

2,534,428. YOGA WORLD, INC., DBA AGE IN REVERSE, COSTA MESA, CA. SN 75-469,405. PUB. 6-15-1999, FILED 4-17-1998.

BODY CHAIR

NO CLAIM IS MADE TO THE EXCLUSIVE RIGHT TO USE "CHAIR", APART FROM THE MARK AS SHOWN.

FOR MANUALLY-OPERATED EXERCISE EQUIPMENT (U.S. CLS. 22, 23, 38 AND 50). FIRST USE 2-21-2001; IN COMMERCE 4-30-2001.

CLASS 28—(Continued).

2,534,439. WALKER, VERNON, DBA MASTER PLAY ENTERTAINMENT, ST. LOUIS, MO. SN 75-489,094. PUB. 2-20-2001, FILED 5-21-1998.

ESCAPE

FOR CARD GAME SOLD WITH A SPECIAL DECK OF CARDS (U.S. CLS. 22, 23, 38 AND 50). FIRST USE 10-0-1998; IN COMMERCE 10-0-1998.

2,534,485. RICE, MARK, CUMMING, GA. SN 75-596,703. PUB. 7-27-1999, FILED 11-27-1998.

FUNKY MONKEYS

FOR BOARD GAME (U.S. CLS. 22, 23, 38 AND 50). FIRST USE 9-1-1998; IN COMMERCE 9-1-1998.

2,534,508. EPIX, INC., LAKE MILLS, WI. SN 75-629,755. PUB. 8-22-2000, FILED 1-27-1999.

HORIZON FITNESS

NO CLAIM IS MADE TO THE EXCLUSIVE RIGHT TO USE "FITNESS", APART FROM THE MARK AS SHOWN.

FOR EXERCISE EQUIPMENT, NAMELY, EXERCISE BIKES, TREADMILLS, STAIR STEPPING MACHINES, ELLIPTICAL EXERCISE MACHINES, SKI MACHINES, AND WEIGHT LIFTING MACHINES (U.S. CLS. 22, 23, 38 AND 50).

FIRST USE 10-1-1999; IN COMMERCE 10-1-1999.

2,534,514. NEMETH, STEPHEN, LOS ANGELES, CA. SN 75-638,041. PUB. 10-26-1999, FILED 2-11-1999.

SCOLF

FOR ACTION SKILL GAMES AND EQUIPMENT SOLD AS A UNIT TO PLAY THE SAME (U.S. CLS. 22, 23, 38 AND 50).

FIRST USE 8-0-2000; IN COMMERCE 8-0-2000.

2,534,523. DSI TOYS, HOUSTON, TX, BY MERGER MERITUS INDUSTRIES, INC., FAIRFIELD, NJ. SN 75-653,608. PUB. 6-20-2000, FILED 3-4-1999.

BUBBLE BUGGY

NO CLAIM IS MADE TO THE EXCLUSIVE RIGHT TO USE "BUGGY", APART FROM THE MARK AS SHOWN.

FOR DOLLS, DOLL ACCESSORIES AND REMOTE CONTROL CONVERTIBLE, FOUR-WHEELED CARS (U.S. CLS. 22, 23, 38 AND 50).

FIRST USE 10-3-1999; IN COMMERCE 10-3-1999.

CLASS 28—(Continued).

2,534,531. SHIMANO INC., SAKAI OSAKA 590-77, JAPAN. SN 75-666,906. PUB. 8-15-2000, FILED 3-24-1999.

CALYX

FOR FISHING TACKLE, NAMELY, REELS, RODS, LINES, LINE GUIDES, HOOKS, JIGS, LURES, ARTIFICIAL BAITS, SPINNERS AND TACKLE CONTAINERS (U.S. CLS. 22, 23, 38 AND 50).

FIRST USE 5-0-1999; IN COMMERCE 5-0-1999.

CLASS 28—(Continued).

2,534,543. BRUNSWICK CORPORATION, LAKE FOREST, IL. SN 75-684,920. PUB. 11-23-1999, FILED 4-16-1999.

MONGOOSE

OWNER OF U.S. REG. NOS. 1,148,240, 1,633,966, AND OTHERS.

FOR CHILDREN'S PLASTIC MULTIPLE ACTIVITY TOYS (U.S. CLS. 22, 23, 38 AND 50).

FIRST USE 2-1-2001; IN COMMERCE 2-1-2001.

2,534,533. NKOK, INC., LOS ANGELES, CA. SN 75-671,015. PUB. 12-26-2000, FILED 3-30-1999.

NKOK R/C RACING

NO CLAIM IS MADE TO THE EXCLUSIVE RIGHT TO USE "R/C OR RACING", APART FROM THE MARK AS SHOWN.

FOR RADIO CONTROLLED TOY VEHICLES AND RADIO-CONTROLLED TOY ANIMALS (U.S. CLS. 22, 23, 38 AND 50).

FIRST USE 6-1-2000; IN COMMERCE 6-1-2000.



2,534,544. BRUNSWICK CORPORATION, LAKE FOREST, IL. SN 75-684,921. PUB. 11-23-1999, FILED 4-16-1999.

FOR CHILDREN'S PLASTIC MULTIPLE ACTIVITY TOYS (U.S. CLS. 22, 23, 38 AND 50).

FIRST USE 2-1-2001; IN COMMERCE 2-1-2001.

2,534,541. BRUNSWICK CORPORATION, LAKE FOREST, IL. SN 75-684,918. PUB. 11-23-1999, FILED 4-16-1999.

MONGOOSE

OWNER OF U.S. REG. NOS. 1,148,240, 1,633,966, AND OTHERS.

FOR CHILDREN'S PLASTIC RIDE-ON TOYS (U.S. CLS. 22, 23, 38 AND 50).

FIRST USE 3-1-2000; IN COMMERCE 3-1-2000.

POUNDIN' BEDBUGS

OWNER OF U.S. REG. NO. 1,199,706.

NO CLAIM IS MADE TO THE EXCLUSIVE RIGHT TO USE "POUNDING", APART FROM THE MARK AS SHOWN.

FOR CHILDREN'S ACTION SKILL GAME (U.S. CLS. 22, 23, 38 AND 50).

FIRST USE 5-5-1999; IN COMMERCE 5-5-1999.

2,534,542. BRUNSWICK CORPORATION, LAKE FOREST, IL. SN 75-684,919. PUB. 11-23-1999, FILED 4-16-1999.



2,534,580. MATTEL, INC., EL SEGUNDO, CA. SN 75-721,344. PUB. 12-5-2000, FILED 6-4-1999.

PAPER SURPRISE

NO CLAIM IS MADE TO THE EXCLUSIVE RIGHT TO USE "PAPER", APART FROM THE MARK AS SHOWN.

FOR CHILDRENS CRAFT KITS COMPRISED OF A TOY WHEELBARROW AND PARTS FOR MAKING A TOY FLOWER AND BUTTERFLY-THEMED CRAFTS (U.S. CLS. 22, 23, 38 AND 50).

FIRST USE 2-27-2001; IN COMMERCE 2-27-2001.

FOR CHILDREN'S PLASTIC RIDE-ON TOYS (U.S. CLS. 22, 23, 38 AND 50).

FIRST USE 3-1-2000; IN COMMERCE 3-1-2000.

CLASS 28—(Continued).

2,534,588. MATTEL, INC., EL SEGUNDO, CA. SN 75-735,558.
PUB. 2-8-2000, FILED 7-21-1999.

HYPER-CYCLES

FOR TOY VEHICLES AND ACCESSORIES THEREFOR, TOY VEHICLE LAUNCHERS (U.S. CLS. 22, 23, 38 AND 50).

FIRST USE 3-19-2000; IN COMMERCE 3-19-2000.

2,534,596. MCCLURE, CINDY M., CAMAS, WA. SN 75-740,487. PUB. 12-28-1999, FILED 7-28-1999.



FOR DOLLS MADE OF VINYL AND ACCESSORIES THEREFOR (U.S. CLS. 22, 23, 38 AND 50).

FIRST USE 10-1-1998; IN COMMERCE 10-1-1998.

2,534,597. ETTER, MATTHIAS, CH-6086 HASLIBERG REUTI, SWITZERLAND. SN 75-740,648. PUB. 4-18-2000, FILED 6-30-1999.

CUBORO

FOR GAMES AND PUZZLES, NAMELY, MARBLE-TRACKS, MARBLES, AND MANIPULATIVE PUZZLES (U.S. CLS. 22, 23, 38 AND 50).

FIRST USE 12-5-1999; IN COMMERCE 12-5-1999.

CLASS 28—(Continued).

2,534,610. TRENDMASTERS, INC., ST. LOUIS, MO. SN 75-749,677. PUB. 10-17-2000, FILED 7-13-1999.

LIGHTNING FORCE 1

OWNER OF U.S. REG. NOS. 1,895,635 AND 1,964,158.
FOR OUTDOOR WATER ACTIVITY TOYS AND OUTDOOR WATER SPORT TOYS, NAMELY, WATERGUNS, TOY LASER LIGHT GUN THAT SQUIRTS WATER, WATERGUN WITH LASER SIGHT, WATER SQUIRTING YARD TOYS THAT CONNECT TO GARDEN HOSES, INFLATABLE BALLS, SPONGE BALLS, RUBBER BALLS, PLASTIC AND FOAM FLYING DISCS AND CASES FOR PLAY ACCESSORIES (U.S. CLS. 22, 23, 38 AND 50).

FIRST USE 1-0-2000; IN COMMERCE 1-0-2000.

2,534,684. STERN PINBALL, INC., MELROSE PARK, IL. SN 75-833,979. PUB. 11-14-2000, FILED 10-28-1999.

STERN PINBALL, INC.

NO CLAIM IS MADE TO THE EXCLUSIVE RIGHT TO USE "PINBALL INC.", APART FROM THE MARK AS SHOWN.

FOR PINBALL GAMES (U.S. CLS. 22, 23, 38 AND 50).

FIRST USE 1-11-2000; IN COMMERCE 1-11-2000.

2,534,685. STERN PINBALL, INC., MELROSE PARK, IL. SN 75-833,981. PUB. 5-30-2000, FILED 10-28-1999.

STERN

FOR PINBALL GAMES (U.S. CLS. 22, 23, 38 AND 50).

FIRST USE 1-11-2000; IN COMMERCE 1-11-2000.

2,534,703. L.L. BEAN, INC., FREEPORT, ME. SN 75-845,859.
PUB. 5-29-2001, FILED 11-10-1999.

FIRST CAST

NO CLAIM IS MADE TO THE EXCLUSIVE RIGHT TO USE "CAST", APART FROM THE MARK AS SHOWN.

FOR FLY FISHING EQUIPMENT AND ACCESSORIES, NAMELY, FISHING BOXES, FISHING RODS, FLY REELS, FLY LINE, FLY LEADERS, FLIES, AND A FISHING ACCESSORY KIT THAT CONTAINS LURES, PRE-TIED LEADERS, FORCEPS, AND NIPPERS (U.S. CLS. 22, 23, 38 AND 50).

FIRST USE 1-25-2000; IN COMMERCE 1-25-2000.

CLASS 28—(Continued).

2,534,704. REMARK-ABLE PRODUCTS, INC., ORLANDO, FL. SN 75-847,870. PUB. 1-23-2001, FILED 11-12-1999.



NO CLAIM IS MADE TO THE EXCLUSIVE RIGHT TO USE "GOLF", APART FROM THE MARK AS SHOWN. THE LINING IS A FEATURE OF THE MARK AND DOES NOT INDICATE COLOR.
FOR CARD GAME (U.S. CLS. 22, 23, 38 AND 50).
FIRST USE 10-5-2001; IN COMMERCE 10-5-2001.

2,534,716. MIZUNO KABUSHIKI KAISHA (MIZUNO CORPORATION), CHUO-KU, OSAKA, JAPAN. SN 75-866,895. PUB. 8-15-2000, FILED 12-8-1999.

PCCP

FOR BALLS, NAMELY GOLF BALLS; GLOVES AND MITTENS, NAMELY, GOLF GLOVES; BATS, CLUBS, STICKS AND RACKETS, NAMELY, GOLF CLUBS AND GOLF CLUB SHAFTS; GOLF EQUIPMENT, NAMELY GOLF BAGS, GOLF TEES, GOLF CLUB HEAD COVERS, GOLF BALL CASES, GOLF CLUB CASES AND GOLF SHOE CASES (U.S. CLS. 22, 23, 38 AND 50).
FIRST USE 11-1-1999; IN COMMERCE 5-1-2000.

2,534,729. PREMIUM PRODUCTS, INC., MOUNT VERNON, VA. SN 75-876,853. PUB. 8-22-2000, FILED 12-21-1999.

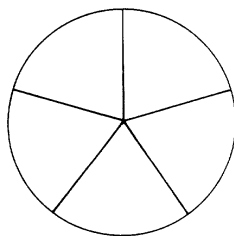

FOR FOOTBALLS (U.S. CLS. 22, 23, 38 AND 50).
FIRST USE 9-4-2001; IN COMMERCE 9-4-2001.

CLASS 28—(Continued).

2,534,738. PLANET TOYS INTERNATIONAL, INC., SARASOTA, FL. SN 75-885,759. PUB. 8-22-2000, FILED 1-3-2000.

FLOODLES

FOR INFLATABLE WATER FLOATATION TOY (U.S. CLS. 22, 23, 38 AND 50).
FIRST USE 2-15-2000; IN COMMERCE 2-15-2000.

2,534,742. WGBH EDUCATIONAL FOUNDATION, BOSTON, MA. SN 75-892,243. PUB. 11-14-2000, FILED 1-7-2000.

LEONA

FOR PUZZLES, CARD GAMES, TOY STUFFED ANIMALS, PLUSH TOYS, TOY CHARACTER FIGURES, ELECTRONIC AND MECHANICAL ACTION TOYS, AND PUPPETS (U.S. CLS. 22, 23, 38 AND 50).
FIRST USE 7-1-2000; IN COMMERCE 7-1-2000.

2,534,749. MIDWAY AMUSEMENT GAMES, LLC, CHICAGO, IL. SN 75-901,128. PUB. 8-29-2000, FILED 1-21-2000.

POND KINGS

FOR COIN-OPERATED ARCADE AND VIDEO GAMES (U.S. CLS. 22, 23, 38 AND 50).
FIRST USE 3-27-2000; IN COMMERCE 3-27-2000.

2,534,756. GLOBAL STYLE IMAGES, INC., SAN DIEGO, CA. SN 75-910,626. PUB. 11-7-2000, FILED 2-7-2000.

BOARD BUDDIEZ

NO CLAIM IS MADE TO THE EXCLUSIVE RIGHT TO USE "BOARD", APART FROM THE MARK AS SHOWN.
FOR TOYS, NAMELY, MINIATURE SKATEBOARDS, MINIATURE SNOWBOARDS, MINIATURE SURFBOARDS, MINIATURE WAKEBOARDS, MINIATURE SKIS, MINIATURE BICYCLES, AND RELATED ACCESSORIES FOR THE FOREGOING TOYS THAT ARE SOLD AS A UNIT WITH THE TOYS; BOARD GAMES; CARD GAMES; ACTION FIGURES; YO-YOS; FLYING DISKS; PLUSH TOYS; MODEL TOY VEHICLES AND RELATED ACCESSORIES SOLD AS A UNIT; MINIATURE TOY RAMPS FOR THE TOY VEHICLES (U.S. CLS. 22, 23, 38 AND 50).
FIRST USE 7-11-2001; IN COMMERCE 7-11-2001.

CLASS 28—(Continued).

2,534,762. FUN PUBLICATIONS, INC., FORT WORTH, TX. SN 75-914,279. PUB. 1-16-2001, FILED 2-4-2000.



THE MARK CONSISTS OF THE LETTERS "A" AND "T", SURROUNDED BY A CIRCLE. THE TOP OF THE "T" IS THE BAR ACROSS THE "A".

FOR ACTION FIGURES AND ACCESSORIES THEREFORE (U.S. CLS. 22, 23, 38 AND 50).

FIRST USE 6-25-1999; IN COMMERCE 2-28-2001.

2,534,765. LEAPFROG ENTERPRISES, INC., EMERYVILLE, CA. BY CHANGE OF NAME KNOWLEDGE KIDS ENTERPRISES, INC., EMERYVILLE, CA. SN 75-916,584. PUB. 1-16-2001, FILED 2-11-2000.

TURBO TWIST

FOR ELECTRONIC HANDHELD TEACHING GAME MACHINES THAT TEACH CHILDREN SPELLING, MATHEMATICS, SCIENCE, MUSIC, HISTORY, GEOGRAPHY AND LITERATURE (U.S. CLS. 22, 23, 38 AND 50).

FIRST USE 8-25-2000; IN COMMERCE 8-25-2000.

2,534,766. CHENILLE KRAFT COMPANY, THE, GURNEE, IL. SN 75-917,132. PUB. 5-15-2001, FILED 2-11-2000.

CRAF-T-BAG

FOR GIFT BAGS CONTAINING HOBBY CRAFT KITS COMPRISED OF PIPE CLEANERS, FEATHERS, FOAM CRAFT SHAPES, WIGGLE EYES, POM POMS, GLUE, WOOD CRAFT STICKS, GLITTER GLUE PENS AND IDEA SHEETS (U.S. CLS. 22, 23, 38 AND 50).

FIRST USE 6-8-2000; IN COMMERCE 6-8-2000.

2,534,777. FARNUM COMPANIES, INC, PHOENIX, AZ, BY ASSIGNMENT HAPPY DOG TOYS, LLC, TEMPE, AZ. SN 75-927,134. PUB. 9-5-2000, FILED 2-23-2000.

ZOOBEEZ!

FOR PET TOYS (U.S. CLS. 22, 23, 38 AND 50). FIRST USE 11-17-2000; IN COMMERCE 11-17-2000.

CLASS 28—(Continued).

2,534,787. SPORTS LICENSING, INC., HANOVER, NH. SN 75-935,200. PUB. 6-12-2001, FILED 2-16-2000.

F55

FOR LACROSSE STICKS (U.S. CLS. 22, 23, 38 AND 50). FIRST USE 9-27-2000; IN COMMERCE 2-19-2001.

2,534,794. JIM HENSON COMPANY, INC., THE, LOS ANGELES, CA. SN 75-943,605. PUB. 10-31-2000, FILED 3-14-2000.

GONZO

FOR DOLLS (U.S. CLS. 22, 23, 38 AND 50). FIRST USE 5-0-2000; IN COMMERCE 5-0-2000.

2,534,821. PRESTIGE TOY CORPORATION, NEW YORK, NY. SN 76-007,805. PUB. 1-9-2001, FILED 3-17-2000.

TUMBLE TUMMIES

FOR STUFFED TOYS (U.S. CLS. 22, 23, 38 AND 50). FIRST USE 1-1-2000; IN COMMERCE 1-1-2000.

2,534,824. ECHO TOYS, LTD., TAI PO NT, HONG KONG. SN 76-010,044. PUB. 12-12-2000, FILED 3-27-2000.

AQUA RIDER

FOR RADIO CONTROLLED TOY VEHICLES (U.S. CLS. 22, 23, 38 AND 50). FIRST USE 1-1-2000; IN COMMERCE 2-2-2000.

2,534,829. DNA (HOUSEMARKS) LIMITED, LONDON SW1P 1BX, ENGLAND. SN 76-012,555. PUB. 11-14-2000, FILED 3-30-2000.

DUNLOP TOTAL PERFORMANCE

OWNER OF U.S. REG. NOS. 1,476,071, 1,890,603, AND OTHERS. FOR GOLF BALLS (U.S. CLS. 22, 23, 38 AND 50). FIRST USE 9-1-2000; IN COMMERCE 9-1-2000.

CLASS 28—(Continued).

2,534,832. BOYDS COLLECTION, LTD., THE, MCSHERRYS-TOWN, PA. SN 76-014,047. PUB. 12-12-2000, FILED 3-31-2000.

BEARS IN THE ATTIC

NO CLAIM IS MADE TO THE EXCLUSIVE RIGHT TO USE "BEARS", APART FROM THE MARK AS SHOWN. FOR PLUSH TOYS (U.S. CLS. 22, 23, 38 AND 50). FIRST USE 10-1-1991; IN COMMERCE 10-1-1991.

CLASS 28—(Continued).

2,534,853. BOYLES, RAY, DBA SHO-TYME MOTOR SPORTS, MERRIAM, KS. SN 76-029,941. PUB. 3-20-2001, FILED 4-20-2000.



2,534,833. ALTERS, DENNIS B., ENCINITAS, CA. SN 76-014,306. PUB. 11-21-2000, FILED 3-31-2000.

WIZDOM'S WAY

OWNER OF U.S. REG. NO. 2,161,935. FOR GAMES, NAMELY GAMES INCORPORATING PLAYING PIECES MOVED ON A PLAYING SURFACE (U.S. CLS. 22, 23, 38 AND 50). FIRST USE 8-1-2001; IN COMMERCE 8-8-2001.

NO CLAIM IS MADE TO THE EXCLUSIVE RIGHT TO USE "MOTOR SPORTS", APART FROM THE MARK AS SHOWN. FOR BOARD GAMES AND TOY CARS (U.S. CLS. 22, 23, 38 AND 50). FIRST USE 7-15-2000; IN COMMERCE 7-15-2000.

2,534,844. NORMARK CORPORATION, MINNETONKA, MN. SN 76-022,417. PUB. 12-5-2000, FILED 4-10-2000.

THUNDERCRANK

FOR ARTIFICIAL FISHING LURES (U.S. CLS. 22, 23, 38 AND 50). FIRST USE 10-0-2000; IN COMMERCE 10-0-2000.



FOR SURFBOARDS, BODYBOARDS, AND SAILBOARDS (U.S. CLS. 22, 23, 38 AND 50). FIRST USE 4-30-1985; IN COMMERCE 1-31-2001.

2,534,848. DANIELSON COMPANY, INC., THE, AUBURN, WA. SN 76-028,919. PUB. 12-12-2000, FILED 4-19-2000.

ZING TAIL

NO CLAIM IS MADE TO THE EXCLUSIVE RIGHT TO USE "TAIL", APART FROM THE MARK AS SHOWN. FOR FISHING TACKLE, NAMELY LURES (U.S. CLS. 22, 23, 38 AND 50). FIRST USE 8-18-2000; IN COMMERCE 8-18-2000.

2,534,873. LOJO PRODUCTIONS, LAKE MARY, FL. SN 76-040,194. PUB. 2-13-2001, FILED 5-4-2000.

HIPSAWAY

FOR MANUALLY OPERATED EXERCISE EQUIPMENT WHICH TARGETS AND ISOLATES THE HIP MUSCLES (U.S. CLS. 22, 23, 38 AND 50). FIRST USE 2-16-2001; IN COMMERCE 2-16-2001.

2,534,850. ZUTANO, INC., CABOT, VT. SN 76-029,043. PUB. 12-5-2000, FILED 4-18-2000.

HIP HOPPY

FOR PLUSH TOYS (U.S. CLS. 22, 23, 38 AND 50). FIRST USE 12-1-1999; IN COMMERCE 12-1-1999.

2,534,883. M & C TOY CENTRE LTD., TSIMSHATSUI EAST, KOWLOON, HONG KONG. SN 76-054,178. PUB. 3-20-2001, FILED 5-23-2000.

COOL FLYER

FOR TOYS, NAMELY, TOY ACTION FIGURES, DOLLS, TOY WEAPONS, TOY VEHICLES, THREE-DIMENSIONAL PLAYSETS DEPICTING SCENES AND SCENERY, PLAYSETS COMPRISING ONE OR MORE OF THE FOREGOING ITEMS (U.S. CLS. 22, 23, 38 AND 50). FIRST USE 8-4-2001; IN COMMERCE 8-4-2001.

CLASS 28—(Continued).

2,534,884. PERETZ, HOWARD G., WATCHUNG, NJ. SN 76-054,615. PUB. 4-17-2001, FILED 5-24-2000.



NO CLAIM IS MADE TO THE EXCLUSIVE RIGHT TO USE "DOLLS", APART FROM THE MARK AS SHOWN. FOR STUFFED SOFT DOLLS (U.S. CLS. 22, 23, 38 AND 50). FIRST USE 1-0-2001; IN COMMERCE 1-0-2001.

2,534,885. M & C TOY CENTRE LTD., TSIMSHATSUI EAST, KOWLOON, HONG KONG. SN 76-055,037. PUB. 3-20-2001, FILED 5-23-2000.

COOL DRIVER

FOR TOYS, NAMELY, TOY ACTION FIGURES, DOLLS, TOY WEAPONS, TOY VEHICLES, THREE-DIMENSIONAL PLAYSETS DEPICTING SCENES AND SCENERY, PLAYSETS COMPRISING ONE OR MORE OF THE FOREGOING ITEMS (U.S. CLS. 22, 23, 38 AND 50). FIRST USE 10-5-2000; IN COMMERCE 10-5-2000.

2,534,886. M & C TOY CENTRE LTD., TSIMSHATSUI EAST, KOWLOON, HONG KONG. SN 76-055,084. PUB. 3-27-2001, FILED 5-23-2000.

COOL KILLER

FOR TOYS, NAMELY, TOY ACTION FIGURES, DOLLS, TOY WEAPONS, TOY VEHICLES, THREE-DIMENSIONAL PLAYSETS DEPICTING SCENES AND SCENERY, PLAYSETS COMPRISING ONE OR MORE OF THE FOREGOING ITEMS (U.S. CLS. 22, 23, 38 AND 50). FIRST USE 8-4-2001; IN COMMERCE 8-4-2001.

CLASS 28—(Continued).

2,534,900. CHRISTIAN BROTHERS, INC., WARROAD, MN. SN 76-074,823. PUB. 3-13-2001, FILED 6-20-2000.

DIAMONDLITE

FOR HOCKEY STICKS AND HOCKEY STICK SHAFTS (U.S. CLS. 22, 23, 38 AND 50). FIRST USE 8-8-2001; IN COMMERCE 8-8-2001.

2,534,908. JOCHUM, DARRELL W., MERCER ISLAND, WA. SN 76-088,425. PUB. 3-20-2001, FILED 7-13-2000.

A GAME OF OPINIONS...WHERE YOUR OPINION COUNTS!

FOR BOARD GAMES (U.S. CLS. 22, 23, 38 AND 50). FIRST USE 11-8-2000; IN COMMERCE 11-8-2000.

2,534,966. MATHIS, MIMI L., FAYETTEVILLE, AR. SN 78-014,642. PUB. 1-30-2001, FILED 6-27-2000.

BABY BEING

NO CLAIM IS MADE TO THE EXCLUSIVE RIGHT TO USE "BABY", APART FROM THE MARK AS SHOWN. FOR DOLLS (U.S. CLS. 22, 23, 38 AND 50). FIRST USE 12-1-2000; IN COMMERCE 1-1-2001.

2,534,973. CALLAWAY GOLF COMPANY, CARLSBAD, CA. SN 78-016,738. PUB. 5-22-2001, FILED 7-14-2000.

BLACKBIRD

FOR GOLF CLUBS, GOLF CLUB HEAD COVERS, GOLF BAGS AND GOLF BALLS (U.S. CLS. 22, 23, 38 AND 50). FIRST USE 12-1-2000; IN COMMERCE 12-1-2000.

CLASS 29—MEATS AND PROCESSED FOODS

2,534,650. H. E. BUTT GROCERY COMPANY, SAN ANTONIO, TX. SN 75-800,993. PUB. 1-23-2001, FILED 9-16-1999.

H-E-B CLASSIC SELECTIONS

NO CLAIM IS MADE TO THE EXCLUSIVE RIGHT TO USE "SELECTIONS", APART FROM THE MARK AS SHOWN. FOR FROZEN ENTREES CONSISTING PRIMARILY OF MEAT, FISH, POULTRY OR VEGETABLES (U.S. CL. 46). FIRST USE 2-0-2000; IN COMMERCE 2-0-2000.

CLASS 29—(Continued).

2,534,677. DEL MONTE CORPORATION, SAN FRANCISCO, CA. SN 75-828,247. PUB. 6-13-2000, FILED 10-22-1999.



OWNER OF U.S. REG. NOS. 827,921 AND 881,339. NO CLAIM IS MADE TO THE EXCLUSIVE RIGHT TO USE "QUALITY", APART FROM THE MARK AS SHOWN. FOR PROCESSED FRUIT, PROCESSED VEGETABLES AND PROCESSED TOMATOES (U.S. CL. 46). FIRST USE 10-15-1999; IN COMMERCE 10-15-1999.

2,534,720. DODGE CITY STEAK COMPANY, L.L.C., DODGE CITY, KS. SN 75-869,001. PUB. 5-1-2001, FILED 12-11-1999.



NO CLAIM IS MADE TO THE EXCLUSIVE RIGHT TO USE "DODGE CITY STEAK COMPANY", APART FROM THE MARK AS SHOWN. FOR BOXED AND PACKAGED MEATS (U.S. CL. 46). FIRST USE 12-11-1999; IN COMMERCE 12-11-1999.

2,534,906. LEWIS AND CLARK BICENTENNIAL MARKETING GROUP, INC., LAKESIDE, MN. SN 76-084,561. PUB. 5-22-2001, FILED 7-10-2000.

SACAGAWEA'S TRAIL SNACKS

NO CLAIM IS MADE TO THE EXCLUSIVE RIGHT TO USE "SNACKS", APART FROM THE MARK AS SHOWN. FOR DRIED OR SMOKED MEATS, PRESERVED OR DRIED FRUITS AND VEGETABLES, JELLIES AND JAMS, JERKY, SNACK MIX CONSISTING PRIMARILY OF PROCESSED FRUITS, PROCESSED NUTS AND RAISINS WITH OR WITHOUT CHOCOLATE CHIPS (U.S. CL. 46). FIRST USE 8-1-2001; IN COMMERCE 8-1-2001.

CLASS 30—STAPLE FOODS

2,534,437. NINTENDO OF AMERICA INC., REDMOND, WA. SN 75-487,785. PUB. 4-13-1999, FILED 5-19-1998.

MEOWTH

FOR CANDY, CHEWING GUM, BAKERY GOODS, ICE CREAM, NOODLES, PASTA, PASTRIES, PROCESSED UNPOPPED POPCORN, WHEAT-BASED SNACK FOODS, RICE-BASED SNACK FOODS, CORN-BASED SNACK FOODS AND FLOVORED, SWEETENED GRAIN-BASED SNACK FOODS (U.S. CL. 46). FIRST USE 10-0-1999; IN COMMERCE 10-0-1999.

2,534,590. NIN JIOM MEDICINE MANUFACTORY (HK) LTD., TSUEN WAN, NEW TERRITORIES, HONG KONG. SN 75-737,493. PUB. 11-21-2000, FILED 6-25-1999.

菴慈念

THE CHINESE CHARACTERS IN THE MARK TRANSLITERATE TO "NIM" (TO THINK OF), "JI" (COMPASSION) AND "OM" (CONVENT) AND THIS MEANS "COMMEMORATION OF MY MOTHER" IN ENGLISH. FOR CONFECTIONERY, NAMELY, HERBAL CANDY (U.S. CL. 46). FIRST USE 1-0-1998; IN COMMERCE 10-0-1999.

2,534,683. TEN REN TEA CO., LTD., TAIPEI, TAIWAN. SN 75-833,186. PUB. 5-1-2001, FILED 10-26-1999.



OWNER OF U.S. REG. NOS. 1,179,412 AND 1,541,755. THE TRANSLITERATION OF THE CHINESE WORDS IN THE MARK ARE "TEN" TRANSLATED AS "SKY" FOR THE FIRST CHARACTER, AND "REN'S" TRANSLATED AS "HUMANITY" FOR THE SECOND CHARACTER. FOR TEA, TEA BAGS, TEA LEAVES, CAKES, TEA-BASED FILLINGS FOR CAKES AND PIES, COCOA, COFFEE, CANDIES, COOKIES (U.S. CL. 46). FIRST USE 0-0-1953; IN COMMERCE 0-0-1984.

CLASS 30—(Continued).

2,534,846. DALUFE FOOD DISTRIBUTOR, INC., MIAMI, FL. SN 76-027,625. PUB. 2-20-2001, FILED 4-14-2000.

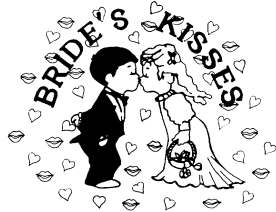

FOR TAPIOCA STARCH BASED PUFFED SNACKS (U.S. CL. 46).
FIRST USE 6-30-1997; IN COMMERCE 11-30-2000.

CLASS 30—(Continued).

2,534,957. AMYX, SCOTT S., DBA L'AMYX TEA BAR, CASTRO VALLEY, CA. SN 78-010,055. PUB. 5-15-2001, FILED 5-25-2000.



2,534,907. LEWIS AND CLARK BICENTENNIAL MARKET-
ING GROUP, INC., LAKESIDE, MT. SN 76-084,562. PUB. 5-
22-2001, FILED 7-10-2000.

SACAGAWEA'S TRAIL TREATS

NO CLAIM IS MADE TO THE EXCLUSIVE RIGHT TO
USE "TREATS", APART FROM THE MARK AS SHOWN.
FOR COFFEE, HONEY AND SWEET CONFECTION-
ERY EDIBLES AND CANDIES, NAMELY, FRUIT FLA-
VORED CANDIES, JORDAN ALMONDS, LICORICE
BRIDGE MIX, CHOCOLATE MINTS, LICORICE PAS-
TELS, CHOCOLATE COVERED NUTS, CHOCOLATE
COVERED RAISINS AND JELLY BEANS (U.S. CL. 46).
FIRST USE 8-1-2001; IN COMMERCE 8-1-2001.

NO CLAIM IS MADE TO THE EXCLUSIVE RIGHT TO
USE "TEA BAR", APART FROM THE MARK AS SHOWN.
THE MARK IS LINED FOR THE COLORS YELLOW AND
GREEN.

FOR TEA, TEA-BASED BEVERAGES, COFFEE, AND
TAPIOCA (U.S. CL. 46).
FIRST USE 5-25-2000; IN COMMERCE 5-25-2000.

2,534,964. WILES, SCOTT, INCLINE VILLAGE, NV. SN 78-
013,993. PUB. 5-22-2001, FILED 6-22-2000.

SHARKY'S

2,534,940. NEETZ, JOHN, C, BAY CITY, MI. SN 78-000,466.
PUB. 3-20-2001, FILED 3-22-2000.

CLUBMOCHA

FOR COFFEE, TEA, COCOA, GOURMET COOKIES,
GOURMET CANDIES, AND BISKETS (U.S. CL. 46).
FIRST USE 1-23-2001; IN COMMERCE 6-21-2001.

FOR COFFEE AND COFFEE-BASED BEVERAGES
CONTAINING MILK (U.S. CL. 46).
FIRST USE 3-0-2000; IN COMMERCE 3-0-2000.

**CLASS 31—NATURAL AGRICULTURAL PRO-
DUCTS**

CLASS 31—(Continued).

2,534,461. PROMARK INTERNATIONAL, INC., BOISE, ID. SN 75-541,452. PUB. 11-2-1999, FILED 8-24-1998.

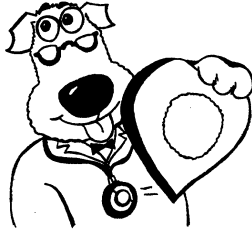

THE STIPLING IS FOR SHADING PURPOSES ONLY AND DOES NOT INDICATE COLOR.
FOR PET FOOD (U.S. CLS. 1 AND 46).
FIRST USE 11-1-1998; IN COMMERCE 11-1-1998.

CLASS 33—(Continued).

2,534,345. MOOSEHEAD BREWERIES LIMITED, SAINT JOHN, NEW BRUNSWICK, CANADA, ASSIGNEE OF LANG FAMILY DISTILLERIES INC., PORT MOODY, BRITISH COLUMBIA, CANADA. SN 74-233,296. PUB. 8-24-1993, FILED 12-24-1991.

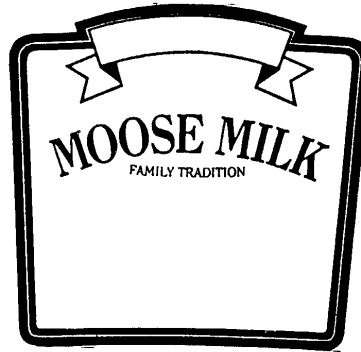

OWNER OF CANADA REG. NO. TMA470331, DATED 2-4-1997, EXPIRES 2-4-2017.
FOR LIQUEUR (U.S. CLS. 47 AND 49).
FIRST USE 2-19-2001; IN COMMERCE 2-19-2001.

CLASS 32—LIGHT BEVERAGES

2,534,802. COOL RUNNINGS SPRING WATER COMPANY LTD., MONTEGO BAY, ST. JAMES, JAMAICA. SN 75-981,087. PUB. 8-15-2000, FILED 2-13-1998.

REGGAE WATER

NO CLAIM IS MADE TO THE EXCLUSIVE RIGHT TO USE "WATER" IN CLASS 32, APART FROM THE MARK AS SHOWN.
FOR BOTTLED DRINKING WATER (U.S. CLS. 45, 46 AND 48).
FIRST USE 1-1-1998; IN COMMERCE 6-1-1998.

2,534,410. TAKARA SAKE USA, INC., BERKELEY, CA. SN 75-421,235. PUB. 12-8-1998, FILED 1-21-1998.

TAKARA SIERRA COLD SAKE

2,534,948. MOUNTAIN MUDD, LLC, BILLINGS, MT. SN 78-003,628. PUB. 4-10-2001, FILED 4-11-2000.

MUDD FLUDD

FOR FILTERED WATER (U.S. CLS. 45, 46 AND 48).
FIRST USE 5-1-2000; IN COMMERCE 5-1-2000.

NO CLAIM IS MADE TO THE EXCLUSIVE RIGHT TO USE "COLD SAKE", APART FROM THE MARK AS SHOWN.
THE ENGLISH TRANSLATION OF "TAKARA" IS "TREASURE".
FOR SAKE (U.S. CLS. 47 AND 49).
FIRST USE 4-0-2000; IN COMMERCE 4-0-2000.

CLASS 33—WINES AND SPIRITS

CLASS 33—(Continued).

2,534,557. KABUSHIKI KAISHA MASUICHI ICHIMURA SYUZOJYO, KAMITAKAI-GUN, NAGANO 381-0201, JAPAN. SN 75-697,161. PUB. 11-23-1999, FILED 5-4-1999.

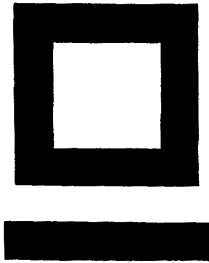

FOR SAKE (U.S. CLS. 47 AND 49).
FIRST USE 5-5-2001; IN COMMERCE 5-5-2001.

2,534,626. BUENA VISTA WINERY, INC., SONOMA, CA. SN 75-771,948. PUB. 11-28-2000, FILED 8-9-1999.

BUENA VISTA CLASSICS

OWNER OF U.S. REG. NO. 2,289,085 AND OTHERS.
NO CLAIM IS MADE TO THE EXCLUSIVE RIGHT TO USE "CLASSICS", APART FROM THE MARK AS SHOWN.
THE ENGLISH TRANSLATION OF "BUENA VISTA" IS "BEAUTIFUL VIEW".
FOR WINE (U.S. CLS. 47 AND 49).
FIRST USE 7-0-1999; IN COMMERCE 7-0-1999.

2,534,631. AYRES, BRONTE FRANCIS, SOUTH AUSTRALIA 5065, AUSTRALIA. AND AYRES, MANDY BLANCHE, SOUTH AUSTRALIA 5065, AUSTRALIA. SN 75-777,002. PUB. 11-28-2000, FILED 8-16-1999.

THE PALATINE

FOR TABLE WINE (U.S. CLS. 47 AND 49).
FIRST USE 4-0-2000; IN COMMERCE 4-0-2000.

CLASS 34—SMOKERS' ARTICLES

CLASS 34—(Continued).

2,534,392. J J HOLAND LIMITED, ROAD TOWN, TORTOLA, BR. VIRGIN ISLANDS. SN 75-349,500. PUB. 11-9-1999, FILED 8-29-1997.



NO CLAIM IS MADE TO THE EXCLUSIVE RIGHT TO USE "VIRGINIA", APART FROM THE MARK AS SHOWN.
FOR FILTER CIGARETTES (U.S. CLS. 2, 8, 9 AND 17).
FIRST USE 5-0-1999; IN COMMERCE 5-0-1999.

2,534,495. KARELIA TOBACCO COMPANY INC., KALAMATA, GREECE. SN 75-605,586. PUB. 2-1-2000, FILED 12-11-1998.



FOR CIGARETTES (U.S. CLS. 2, 8, 9 AND 17).
FIRST USE 0-0-1995; IN COMMERCE 0-0-1996.

SERVICE MARKS
CLASS 35—ADVERTISING AND BUSINESS

CLASS 35—(Continued).

2,534,374. EDGAR, PROCHAZKA, PRAHA 4, CZECH REPUBLIC. SN 75-250,520. PUB. 5-18-1999, FILED 3-3-1997.

STUDIO LUKAS

NO CLAIM IS MADE TO THE EXCLUSIVE RIGHT TO USE "STUDIO", APART FROM THE MARK AS SHOWN.
 FOR ADVERTISING AND MARKETING FOR OTHERS, NAMELY, BY MEANS OF DIRECT MAIL, DISSEMINATION OF ADVERTISING MATTERS, PROVIDING SPACE IN PERIODICALS, ELECTRONIC BILLBOARD ADVERTISING, RENTAL OF ADVERTISING SPACE, PROVIDING TELEVISION AND RADIO ADVERTISING FOR OTHERS, PREPARING AUDIO-VISUAL PRESENTATIONS AND CONSULTATIONS THEREOF (U.S. CLS. 100, 101 AND 102).
 FIRST USE 5-0-2000; IN COMMERCE 5-0-2000.

CLASS 35—(Continued).

2,534,390. A.M. CASTLE & CO., FRANKLIN PARK, IL. SN 75-330,848. PUB. 5-11-1999, FILED 7-25-1997.

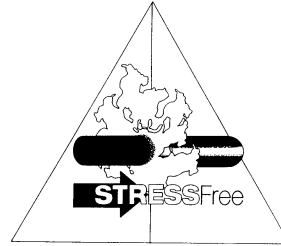

NO CLAIM IS MADE TO THE EXCLUSIVE RIGHT TO USE "STRESS FREE", APART FROM THE MARK AS SHOWN.
 FOR DISTRIBUTORSHIPS IN THE FIELD OF CARBON AND CARBON ALLOY BAR PRODUCTS THAT HAVE BEEN QUENCHED AND TEMPERED (U.S. CLS. 100, 101 AND 102).
 FIRST USE 6-0-1997; IN COMMERCE 7-0-1997.

2,534,377. WEINER, JOEL, MARINA DEL REY, CA. SN 75-255,038. PUB. 6-29-1999, FILED 3-10-1997.

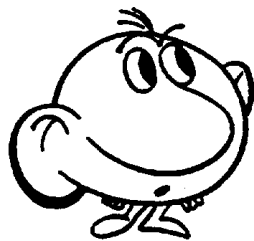

2,534,473. INTERNATIONAL DATA, LLC, BLOOMINGTON, IN. SN 75-560,727. PUB. 12-7-1999, FILED 9-28-1998.

PROMOTION INSIGHTS

NO CLAIM IS MADE TO THE EXCLUSIVE RIGHT TO USE "PROMOTION", APART FROM THE MARK AS SHOWN.
 FOR PROVISION OF INFORMATION CONCERNING SALES AND MARKETING PROMOTIONS FOR OTHERS (U.S. CLS. 100, 101 AND 102).
 FIRST USE 1-0-1999; IN COMMERCE 1-0-1999.

2,534,513. SMARTHEALTH, INC., DBA SMARTPRACTICE, PHOENIX, AZ. SN 75-637,809. PUB. 5-22-2001, FILED 2-11-1999.

SELLSMART

FOR ADVERTISING AND PROMOTIONAL SERVICES, NAMELY, CARTOON CHARACTER LICENSING, DEVELOPING ADVERTISING CAMPAIGNS UTILIZING CARTOON CHARACTERS FROM COMIC AND COLORING BOOKS (U.S. CLS. 100, 101 AND 102).
 FIRST USE 3-17-2000; IN COMMERCE 3-17-2000.

FOR CATALOG ORDERING SERVICES OFFERING CUSTOM PRINTED PROMOTIONAL MATERIALS (U.S. CLS. 100, 101 AND 102).
 FIRST USE 3-10-1999; IN COMMERCE 3-10-1999.

CLASS 35—(Continued).

2,534,519. ASPEN MARKETING, INC., LOS ANGELES, CA, BY ASSIGNMENT SUDDEN IMPACT, INC., NEW YORK, NY. SN 75-644,854. PUB. 2-1-2000, FILED 2-22-1999.

SEYMOUR OUTDOOR

NO CLAIM IS MADE TO THE EXCLUSIVE RIGHT TO USE "OUTDOOR", APART FROM THE MARK AS SHOWN. FOR ADVERTISING AGENCIES, NAMELY, ADVERTISING AND PROMOTING THE GOODS AND SERVICES OF OTHERS, PUBLIC RELATIONS, BUSINESS MARKETING CONSULTING SERVICES (U.S. CLS. 100, 101 AND 102).

FIRST USE 1-1-1999; IN COMMERCE 1-1-1999.

2,534,526. POLYNESIAN CULTURAL CENTER, LAIE, HI. SN 75-656,094. PUB. 12-14-1999, FILED 3-12-1999.

THE HUKILAU STORE

NO CLAIM IS MADE TO THE EXCLUSIVE RIGHT TO USE "STORE", APART FROM THE MARK AS SHOWN. THE WORD "HUKILAU" IS A HAWAIIAN WORD MEANING "TO FISH USING A SEINE".

FOR RETAIL STORE SERVICES FOR ITEMS RELATING TO POLYNESIA (U.S. CLS. 100, 101 AND 102).

FIRST USE 9-0-1998; IN COMMERCE 10-0-1998.

2,534,554. KIM, JUNG PIL, CERRITOS, CA. SN 75-693,613. PUB. 10-31-2000, FILED 4-28-1999.

ITEMEXCHANGE.COM

FOR COMPUTERIZED ON-LINE SERVICES, NAMELY PROVIDING A FORUM TO CONNECT SELLERS OF USED, RECONDITIONED AND SALVAGED INDUSTRIAL PRODUCTS WITH BUYERS BY MEANS OF A GLOBAL COMPUTER INFORMATION NETWORK (U.S. CLS. 100, 101 AND 102).

FIRST USE 12-1-1998; IN COMMERCE 12-1-1998.

2,534,558. ELI'S CHEESECAKE COMPANY, THE, CHICAGO, IL. SN 75-697,322. PUB. 4-17-2001, FILED 5-4-1999.

ELI'S CRAVINGS

OWNER OF U.S. REG. NOS. 1,284,508, 2,139,700, AND OTHERS.

FOR WHOLESALE DISTRIBUTORSHIP FEATURING CHEESECAKE (U.S. CLS. 100, 101 AND 102).

FIRST USE 5-15-1999; IN COMMERCE 5-15-1999.

CLASS 35—(Continued).

2,534,585. BANANA REPUBLIC (APPAREL) INC., SAN BRUNO, CA. SN 75-731,849. PUB. 11-21-2000, FILED 6-18-1999.

BANANAREPUBLIC.COM

OWNER OF U.S. REG. NOS. 1,347,849, 2,111,440, AND OTHERS.

FOR RETAIL STORE SERVICES, COMPUTERIZED ONLINE RETAIL SERVICES, AND MAIL ORDER CATALOG SERVICES, INCLUDING PROVIDING CUSTOMERS WITH AVAILABLE PRODUCT AND SERVICE INFORMATION, IN THE FIELDS OF CLOTHING, CLOTHING ACCESSORIES, SUNGLASSES, JEWELRY, CLOCKS, PRE-RECORDED COMPACT DISCS, PERSONAL CARE PRODUCTS, HOUSEHOLD PRODUCTS FOR DINING, BED AND BATH, HOUSEWARES AND GLASS, PAPER GOODS, LEATHER GOODS, LUGGAGE AND BAGS, ELECTRONIC GIFT WISH LIST SERVICES (U.S. CLS. 100, 101 AND 102).

FIRST USE 12-2-2000; IN COMMERCE 12-2-2000.

2,534,603. DOLLAR GENERAL INTELLECTUAL PROPERTY, L.P., BURLINGTON, VT. SN 75-744,392. PUB. 6-27-2000, FILED 7-7-1999.

GOT A MINUTE? GET A LOT!

FOR RETAIL STORE SERVICES IN THE FIELD OF GENERAL MERCHANDISE (U.S. CLS. 100, 101 AND 102).

FIRST USE 5-1-2001; IN COMMERCE 5-1-2001.

2,534,618. CURTIS 1000, INC., ATLANTA, GA. SN 75-763,836. PUB. 1-30-2001, FILED 7-28-1999.

CURTIS DIRECT

OWNER OF U.S. REG. NOS. 1,053,911, 1,157,548, AND 1,178,425.

FOR ON-LINE ORDERING SERVICES IN THE FIELD OF OFFICE SUPPLIES, NAMELY BUSINESS FORMS, LABELS, CUSTOM BINDERS, ENVELOPES AND THE LIKE (U.S. CLS. 100, 101 AND 102).

FIRST USE 6-24-1999; IN COMMERCE 8-1-1999.

2,534,625. HISPANIC BROADCASTING CORPORATION, DALLAS, TX. SN 75-771,280. PUB. 8-15-2000, FILED 8-9-1999.

EN TOTAL

THE ENGLISH TRANSLATION OF THE MARK IS "IN TOTAL".

FOR PROVIDING AN ON-LINE COMPUTER DATABASE FEATURING MARKETING INFORMATION AND ADVERTISING SERVICES, NAMELY, PROMOTING THE GOODS AND SERVICES OF OTHERS THROUGH TELECOMMUNICATION CHANNELS (U.S. CLS. 100, 101 AND 102).

FIRST USE 8-4-1999; IN COMMERCE 8-4-1999.

CLASS 35—(Continued).

2,534,646. C/HCA, INC., NASHVILLE, TN. SN 75-799,423. PUB. 5-15-2001, FILED 9-13-1999.



NO CLAIM IS MADE TO THE EXCLUSIVE RIGHT TO USE "HEALTH SYSTEM", APART FROM THE MARK AS SHOWN.

THE MARK INCLUDES THE IMAGE OF THREE STARS. FOR MANAGEMENT OF HOSPITALS AND OTHER HEALTHCARE PROVIDER INSTITUTIONS (U.S. CLS. 100, 101 AND 102).

FIRST USE 7-22-1999; IN COMMERCE 7-22-1999.

2,534,651. INTERNATIONAL TRADE ADMINISTRATION, WASHINGTON, DC. SN 75-801,597. PUB. 4-24-2001, FILED 11-5-1999.

MYEXPORTS.COM

FOR BUSINESS INFORMATION AND CONSULTING SERVICES TO ASSIST THE UNITED STATES BUSINESS COMMUNITY IN THE FIELD OF INTERNATIONAL TRADE, NAMELY, CONSULTATION, INFORMATION AND ASSISTANCE CONCERNING THE IMPORT AND EXPORT OF GOODS AND SERVICES, PROVIDING A VENUE VIA A GLOBAL COMPUTER NETWORK FOR THE CONDUCT OF TRADE SHOWS AND THE MARKETING OF GOODS AND SERVICES, PROVIDING A DIRECTORY OF EXPORT SERVICE PROVIDERS, TRADING COMPANIES AND TRADE INTERMEDIARIES, AND THE PROVISION OF OVERSEAS TRADE LEADS TO THE UNITED STATES BUSINESS COMMUNITY (U.S. CLS. 100, 101 AND 102).

FIRST USE 12-1-1999; IN COMMERCE 12-1-1999.

2,534,655. PASSIONWORKS, LLC, SAMMAMISH, WA, BY ASSIGNMENT ALDERTON, CHARLOTTE, REDMOND, WA. SN 75-803,639. PUB. 4-18-2000, FILED 9-17-1999.

PASSIONWORKS

FOR BUSINESS CONSULTATION IN THE FIELDS OF THE STARTING AND DEVELOPMENT OF BUSINESSES AND SELF-PUBLICATION OF PRINTED AND ELECTRONIC MATTER (U.S. CLS. 100, 101 AND 102).

FIRST USE 8-14-2000; IN COMMERCE 11-18-2000.

CLASS 35—(Continued).

2,534,656. SHORTWALK PTY LTD, SYDNEY NSW, AUSTRALIA. SN 75-805,367. PUB. 12-12-2000, FILED 10-14-1999.

SHORTWALK

FOR DISSEMINATION OF ADVERTISING FOR OTHERS VIA AN ON-LINE ELECTRONIC COMMUNICATIONS NETWORK; ELECTRONIC BILLBOARD ADVERTISING; PROMOTING THE GOODS AND SERVICES OF OTHERS BY PREPARING AND PLACING ADVERTISEMENTS IN AN ELECTRONIC MAGAZINE ACCESSED THROUGH A GLOBAL COMPUTER NETWORK (U.S. CLS. 100, 101 AND 102).

FIRST USE 4-21-1999; IN COMMERCE 12-9-1999.

2,534,661. VIVIDENCE CORPORATION, SAN MATEO, CA, BY CHANGE OF NAME VIVIDENCE CORPORATION, SAN MATEO, CA. SN 75-811,757. PUB. 9-26-2000, FILED 9-29-1999.

VIVIDENCE

FOR BUSINESS MANAGEMENT, CUSTOMER WEBSITE EVALUATION, MARKET ANALYSIS, AND CONSULTATION SERVICES FOR ON-LINE BUSINESSES (U.S. CLS. 100, 101 AND 102).

FIRST USE 8-18-1999; IN COMMERCE 8-18-1999.

2,534,666. HARMONY HOLDINGS, INC., MINNEAPOLIS, MN. SN 75-818,444. PUB. 5-30-2000, FILED 10-11-1999.

UNSCENTED

FOR PRODUCING TELEVISION COMMERCIALS FOR OTHERS (U.S. CLS. 100, 101 AND 102).

FIRST USE 3-4-1999; IN COMMERCE 3-4-1999.

2,534,692. WONDERCLICK.COM, INC., WASHINGTON, DC. SN 75-839,263. PUB. 6-27-2000, FILED 11-3-1999.

WONDERCLICK.COM

FOR PROMOTING THE GOODS AND SERVICES OF OTHERS BY PLACING ADVERTISEMENTS AND PROMOTIONAL DISPLAYS IN AN ELECTRONIC SITE ACCESSED THROUGH COMPUTER NETWORKS; PROVIDING A WEBSITE ON A GLOBAL COMPUTER NETWORK CONTAINING INFORMATION RELATING TO FREE CONSUMER RETAIL ITEMS OFFERED THROUGH A SWEEPSTAKE (U.S. CLS. 100, 101 AND 102).

FIRST USE 1-17-2000; IN COMMERCE 1-17-2000.

CLASS 35—(Continued).

2,534,694. BOXER LEARNING, INC., CHARLOTTESVILLE, VA. SN 75-839,461. PUB. 10-31-2000, FILED 11-1-1999.

LEDGER

FOR DATA COLLECTION AND MANAGEMENT SERVICES, NAMELY, COMPILING, MONITORING, EVALUATING, SUMMARIZING AND PRESENTING USER ACTIVITY AND PERFORMANCE DATA IN EDUCATIONAL MATERIALS (U.S. CLS. 100, 101 AND 102).
FIRST USE 9-1-1999; IN COMMERCE 9-1-1999.

2,534,706. KING, MICHELLE, IRVINE, CA. SN 75-849,310. PUB. 2-27-2001, FILED 11-16-1999.

REALITY ENTERTAINMENT

NO CLAIM IS MADE TO THE EXCLUSIVE RIGHT TO USE "ENTERTAINMENT", APART FROM THE MARK AS SHOWN.
FOR MANAGEMENT OF PERFORMANCE ARTISTS (U.S. CLS. 100, 101 AND 102).
FIRST USE 1-1-2000; IN COMMERCE 1-1-2000.

2,534,721. HY-KO PRODUCTS COMPANY, WALTON HILLS, OH. SN 75-870,664. PUB. 12-5-2000, FILED 12-14-1999.

SHARPSALES.COM

FOR DISSEMINATION OF CLASSIFIED ADVERTISING FOR OTHERS VIA A GLOBAL COMPUTER NETWORK (U.S. CLS. 100, 101 AND 102).
FIRST USE 8-13-2001; IN COMMERCE 8-13-2001.

2,534,726. VIBA FIMA, INC., BUFFALO GROVE, IL. SN 75-876,795. PUB. 2-13-2001, FILED 12-21-1999.

PERCS

FOR PROVIDING GENERAL COMMERCIAL INFORMATION AND DIRECTORY SERVICES WITHIN SPECIFIC LOCAL GEOGRAPHIC AREAS VIA A GLOBAL COMPUTER INFORMATION NETWORK (U.S. CLS. 100, 101 AND 102).
FIRST USE 7-4-2001; IN COMMERCE 7-4-2001.

2,534,727. VIBA FIMA, INC., BUFFALO GROVE, IL. SN 75-876,796. PUB. 2-13-2001, FILED 12-21-1999.

PERCSONAL

FOR PROVIDING GENERAL COMMERCIAL INFORMATION AND DIRECTORY SERVICES WITHIN SPECIFIC LOCAL GEOGRAPHIC AREAS VIA A GLOBAL COMPUTER INFORMATION NETWORK (U.S. CLS. 100, 101 AND 102).
FIRST USE 7-4-2001; IN COMMERCE 7-4-2001.

CLASS 35—(Continued).

2,534,728. VIBA FIMA, INC., BUFFALO GROVE, IL. SN 75-876,797. PUB. 1-30-2001, FILED 12-21-1999.

SWEEPEY

FOR PROVIDING GENERAL COMMERCIAL INFORMATION AND DIRECTORY SERVICES WITHIN SPECIFIC LOCAL GEOGRAPHIC AREAS VIA A GLOBAL COMPUTER INFORMATION NETWORK (U.S. CLS. 100, 101 AND 102).
FIRST USE 7-4-2001; IN COMMERCE 7-4-2001.

2,534,743. ELI'S CHEESECAKE COMPANY, THE, CHICAGO, IL. SN 75-893,165. PUB. 4-17-2001, FILED 1-10-2000.

ELI'S CHICAGO STYLE CHEESECAKE

OWNER OF U.S. REG. NOS. 1,284,508, 2,102,702, AND 2,139,700.
NO CLAIM IS MADE TO THE EXCLUSIVE RIGHT TO USE "CHICAGO STYLE CHEESECAKE", APART FROM THE MARK AS SHOWN.
FOR WHOLESALE DISTRIBUTORSHIPS FEATURING CHEESECAKE AND OTHER BAKERY GOODS (U.S. CLS. 100, 101 AND 102).
FIRST USE 6-0-1995; IN COMMERCE 6-0-1995.

2,534,795. NYB FOODS, INC., MESA, AZ. SN 75-945,569. PUB. 3-20-2001, FILED 2-26-2000.

NEW YORK BURRITO GOURMET WRAPS

OWNER OF U.S. REG. NO. 1,993,286.
NO CLAIM IS MADE TO THE EXCLUSIVE RIGHT TO USE "GOURMET WRAPS", APART FROM THE MARK AS SHOWN.
SEC. 2(F) AS TO "NEW YORK BURRITO".
FOR FRANCHISING, NAMELY OFFERING TECHNICAL ASSISTANCE IN THE ESTABLISHMENT AND/OR OPERATION OF MEXICAN FAST FOOD RESTAURANTS (U.S. CLS. 100, 101 AND 102).
FIRST USE 10-1-1995; IN COMMERCE 10-1-1995.

2,534,797. GREENE, RALPH F., DBA SPICES-N-STUFF, RICHARDSON, TX. SN 75-960,162. PUB. 12-12-2000, FILED 3-14-2000.

SPICES-N-STUFF

FOR COMPUTERIZED ON-LINE RETAIL SERVICES IN THE FIELD OF GOURMET FOODS, SEASONINGS AND KITCHEN ACCESSORIES (U.S. CLS. 100, 101 AND 102).
FIRST USE 8-21-2001; IN COMMERCE 8-21-2001.

CLASS 35—(Continued).

2,534,812. ASKART.COM, INC., SAN FRANCISCO, CA. SN 75-981,438. PUB. 8-15-2000, FILED 8-31-1999.

ASKART

FOR ADMINISTERING, MANAGING AND CONDUCTING AN ONLINE WEBSITE FOR THE SALE OF THIRD PARTY GOODS AND SERVICES RELATING TO THE ART INDUSTRY AND THE ART MARKET; PROVIDING AN ONLINE SERVICE FEATURING ARTWORK AND OTHER RELATED PRODUCTS BY MEANS OF A GLOBAL COMPUTER NETWORK; PROMOTING THE GOODS AND SERVICES OF OTHERS IN THE ART INDUSTRY BY DISSEMINATING THE ADVERTISING OF OTHERS VIA A GLOBAL COMPUTER NETWORK (U.S. CLS. 100, 101 AND 102).

FIRST USE 9-30-1999; IN COMMERCE 9-30-1999.

2,534,817. KEYSTONE MARKETING SERVICES, INC., LAS VEGAS, NV, BY ASSIGNMENT KEYAUTOPARTS.COM, INC., MAYNARD, MA. SN 76-002,766. PUB. 11-21-2000, FILED 3-17-2000.

DRIVERFX

FOR COMPUTERIZED ONLINE RETAIL STORE AND ORDERING SERVICES, AND WHOLESALE DISTRIBUTORSHIPS, FEATURING AUTOMOTIVE PARTS AND ACCESSORIES (U.S. CLS. 100, 101 AND 102).

FIRST USE 11-1-2000; IN COMMERCE 11-1-2000.

2,534,827. HIGHWAY IMPRESSIONS, INC., TOWSON, MD. SN 76-010,972. PUB. 1-9-2001, FILED 3-24-2000.

ADFLAPS

FOR ADVERTISING SERVICES, NAMELY, PROMOTING THE GOODS AND SERVICES OF OTHERS THROUGH MOBILE SIGNAGE, NAMELY, MUD GUARDS AND PAINTED TRUCK-SIDE SIGNS (U.S. CLS. 100, 101 AND 102).

FIRST USE 4-1-2000; IN COMMERCE 4-1-2000.

2,534,831. COMMERCIAL LAW AFFILIATES, INC., MINNEAPOLIS, MN. SN 76-012,813. PUB. 2-6-2001, FILED 3-29-2000.

UPHOLDING THE HIGHEST STANDARDS. YOURS.

FOR LAWYER REFERRAL SERVICES DIRECTED TO MEMBER LAW FIRMS INVOLVED IN COMMERCIAL LAW ISSUES (U.S. CLS. 100, 101 AND 102).

FIRST USE 3-31-2000; IN COMMERCE 3-31-2000.

CLASS 35—(Continued).

2,534,836. BEUTLER HEATING & AIR CONDITIONING, EL DORADO HILLS, CA. SN 76-015,366. PUB. 11-28-2000, FILED 4-3-2000.



THE DRAWING IS LINED FOR THE COLOR RED. FOR ADVERTISING THE GOODS AND SERVICES OF OTHERS BY PLACING ADVERTISEMENTS IN AN ONLINE SHOPPING MALL VIA A GLOBAL COMPUTER NETWORK (U.S. CLS. 100, 101 AND 102).

FIRST USE 1-0-2001; IN COMMERCE 1-0-2001.

2,534,837. CULVER STAFFING RESOURCES, SAN DIEGO, CA. SN 76-016,147. PUB. 2-6-2001, FILED 4-3-2000.

CULVER

FOR PERSONNEL PLACEMENT SERVICES (U.S. CLS. 100, 101 AND 102).

FIRST USE 7-1-2001; IN COMMERCE 7-1-2001.

2,534,840. IN STEREO LLC, NEWINGTON, CT. SN 76-018,994. PUB. 5-8-2001, FILED 3-3-2000.

BOOMERBAY

FOR RETAIL STORES FEATURING AUDIO EQUIPMENT AND ACCESSORIES (U.S. CLS. 100, 101 AND 102).

FIRST USE 4-0-2000; IN COMMERCE 4-0-2000.

2,534,847. CAHN, JERRY, NEW YORK, NY. SN 76-028,319. PUB. 5-29-2001, FILED 4-17-2000.

LICENSEYOURDOTCOM

FOR LICENSING ADVERTISING SLOGANS, TRADEMARKS, LOGOS AND TRADE NAMES TO DOT COM CORPORATIONS AND DOT COM RELATED CORPORATIONS (U.S. CLS. 100, 101 AND 102).

FIRST USE 7-8-2000; IN COMMERCE 7-8-2000.

CLASS 35—(Continued).

2,534,859. HIGHWAY IMPRESSIONS, INC., TOWSON, MD. SN 76-035,480. PUB. 1-9-2001, FILED 4-26-2000.

HIGHWAY IMPRESSIONS

FOR ADVERTISING SERVICES, NAMELY PROMOTING THE GOODS AND SERVICES OF OTHERS THROUGH MOBILE SIGNAGE, NAMELY, MUD GUARDS AND PAINTED TRUCK SIGNS (U.S. CLS. 100, 101 AND 102).

FIRST USE 4-21-2000; IN COMMERCE 4-21-2000.

2,534,870. SMITH & NOBLE, LLC, CORONA, CA. SN 76-039,922. PUB. 1-2-2001, FILED 5-3-2000.

SMITH + NOBLE

OWNER OF U.S. REG. NO. 1,870,878.
FOR MAIL ORDER CATALOG SERVICES AND ON-LINE CATALOG SERVICES FEATURING WINDOW TREATMENTS, COVERINGS, VALANCES, CORNICES, FIXTURES, FABRICS, AND ACCESSORIES (U.S. CLS. 100, 101 AND 102).

FIRST USE 10-31-1993; IN COMMERCE 10-31-1993.

2,534,871. FLEET NATIONAL BANK, BOSTON, MA. BY ASSIGNMENT SMITH & NOBLE, LLC, CORONA, CA. SN 76-039,923. PUB. 1-2-2001, FILED 5-3-2000.

WINDOW ELEMENTS

OWNER OF U.S. REG. NO. 2,193,719.
NO CLAIM IS MADE TO THE EXCLUSIVE RIGHT TO USE "WINDOW", APART FROM THE MARK AS SHOWN.
FOR MAIL ORDER CATALOG SERVICES AND ON-LINE CATALOG SERVICES FEATURING WINDOW TREATMENTS, COVERINGS, VALANCES, CORNICES, FIXTURES, FABRICS, AND ACCESSORIES (U.S. CLS. 100, 101 AND 102).

FIRST USE 7-11-1997; IN COMMERCE 7-11-1997.

2,534,872. SMITH & NOBLE, LLC, CORONA, CA. SN 76-039,924. PUB. 1-2-2001, FILED 5-3-2000.

WINDOWARE

OWNER OF U.S. REG. NO. 1,870,879.
FOR MAIL ORDER CATALOG SERVICES AND ON-LINE CATALOG SERVICES FEATURING WINDOW TREATMENTS, COVERINGS, VALANCES, CORNICES, FIXTURES, FABRICS, AND ACCESSORIES (U.S. CLS. 100, 101 AND 102).

FIRST USE 10-31-1993; IN COMMERCE 10-31-1993.

CLASS 35—(Continued).

2,534,875. OLD WORLD MERCHANT.COM, INC., GLEN ALLEN, VA. SN 76-044,107. PUB. 5-8-2001, FILED 5-9-2000.

OLDWORLDMERCHANT.COM

FOR ELECTRONIC RETAILING SERVICES VIA INTERNET FEATURING POLISH POTTERY AND CZECH CRYSTAL FROM EUROPE (U.S. CLS. 100, 101 AND 102).

FIRST USE 8-1-2001; IN COMMERCE 8-1-2001.

2,534,878. SUPERIOR PRODUCTS, INC., CLEVELAND, OH. SN 76-047,339. PUB. 1-30-2001, FILED 5-12-2000.

A DOT.COM WITH A FACE

FOR ON-LINE RETAIL AND WHOLESALE STORE SERVICES FEATURING WELDING SUPPLIES (U.S. CLS. 100, 101 AND 102).

FIRST USE 5-0-1999; IN COMMERCE 5-0-1999.

2,534,881. MOBILESPRING, INC., NEW YORK, NY. SN 76-053,871. PUB. 4-17-2001, FILED 5-19-2000.

MOBILESPRING

FOR BUSINESS DEVELOPMENT SERVICES, NAMELY, PROVIDING START-UP ACTIVITIES FOR THE BUSINESSES OF OTHERS; BUSINESS CONSULTING SERVICES; AND BUSINESS MARKETING CONSULTATION SERVICES (U.S. CLS. 100, 101 AND 102).

FIRST USE 3-14-2000; IN COMMERCE 3-14-2000.

2,534,901. HENNESSEY INDUSTRIES, INC., SEATTLE, WA. SN 76-074,873. PUB. 3-20-2001, FILED 6-21-2000.

EVERSIO

FOR RETAIL STORE SERVICES AND RETAIL STORE SERVICES AVAILABLE THROUGH COMPUTER COMMUNICATIONS AND INTERACTIVE TELEVISION FEATURING AUTOMATED DATA COLLECTION HARDWARE, SOFTWARE AND CONSUMABLES, NAMELY LABELS, TAGS AND RIBBONS (U.S. CLS. 100, 101 AND 102).

FIRST USE 6-4-2000; IN COMMERCE 6-4-2000.

2,534,920. INSIGHT TOOLS LLC, MINNEAPOLIS, MN. SN 76-103,535. PUB. 4-17-2001, FILED 8-4-2000.

INSIGHTTOOLS

FOR PROVIDING INTERNET-BASED MARKET RESEARCH SERVICES FOR OTHERS (U.S. CLS. 100, 101 AND 102).

FIRST USE 9-1-2000; IN COMMERCE 9-1-2000.

CLASS 35—(Continued).

2,534,932. ROHSEN TECHNOLOGY & MARKETING, INC., ORANGE, CA. SN 76-121,383. PUB. 7-10-2001, FILED 9-5-2000.

RFQsolutions

FOR COMPUTERIZED INFORMATION SERVICES, NAMELY, PROVIDING A DATA BASE THROUGH THE INTERNET TO COMPILE DATA FROM SUPPLIERS OF MATERIALS, PRODUCTS AND/OR SERVICES, AND TO ENABLE BUSINESSES WHICH SEEK ANY SUCH MATERIALS, PRODUCTS AND/OR SERVICES TO LOCATE THE SUPPLIERS OF SAME, EXCHANGE INFORMATION WITH THEM, OBTAIN PRICE QUOTES AND REAL-TIME MULTIPLE BIDS, AND CONDUCT BUSINESS TRANSACTIONS (U.S. CLS. 100, 101 AND 102).
FIRST USE 3-12-2000; IN COMMERCE 4-17-2000.

2,534,953. GREENLEES, JAY, DACULA, GA. SN 78-007,602. PUB. 11-28-2000, FILED 5-10-2000.

DON'T TRADE WITHOUT IT

FOR TRADE EXCHANGE SERVICES, NAMELY, BARTERING OF GOODS FOR OTHERS AND MAINTAINING ACCOUNT RECORDS FOR PROGRAM PARTICIPANTS VIA A GLOBAL COMPUTER NETWORK (U.S. CLS. 100, 101 AND 102).
FIRST USE 8-14-2001; IN COMMERCE 8-14-2001.

2,534,954. GREENLEES, JAY, DACULA, GA. SN 78-007,604. PUB. 11-28-2000, FILED 5-10-2000.

DON'T BARTER WITHOUT IT

FOR TRADE EXCHANGE SERVICES, NAMELY, BARTERING OF GOODS FOR OTHERS AND MAINTAINING ACCOUNT RECORDS FOR PROGRAM PARTICIPANTS VIA A GLOBAL COMPUTER NETWORK (U.S. CLS. 100, 101 AND 102).
FIRST USE 8-1-2001; IN COMMERCE 8-1-2001.

2,534,977. LOUISIANA ONLINE, INC., BATON ROUGE, LA. SN 78-019,378. PUB. 6-5-2001, FILED 8-2-2000.

SOHO DEPOT

NO CLAIM IS MADE TO THE EXCLUSIVE RIGHT TO USE "SOHO", APART FROM THE MARK AS SHOWN.
FOR DISSEMINATION OF ADVERTISING FOR OTHERS VIA AN ON-LINE ELECTRONIC COMMUNICATIONS NETWORK; AND ON-LINE RETAIL STORE SERVICES FEATURING HOME OFFICE EQUIPMENT AND SUPPLIES (U.S. CLS. 100, 101 AND 102).
FIRST USE 9-11-2001; IN COMMERCE 9-11-2001.

CLASS 36—INSURANCE AND FINANCIAL

2,534,360. EPO CAPITAL CORPORATION, WILKES BARRE, PA. SN 75-193,323. PUB. 2-3-1998, FILED 11-5-1996.

EPO

FOR FINANCIAL CONSULTING SERVICES, AND FINANCIAL ADVISORY SERVICES REGARDING USE OF GLOBAL COMPUTER NETWORKS BY COMPANIES TO OBTAIN FINANCING (U.S. CLS. 100, 101 AND 102).
FIRST USE 6-0-1997; IN COMMERCE 6-0-1997.

2,534,403. INTERSCOPE COMMUNICATIONS, INC., LOS ANGELES, CA. SN 75-392,387. PUB. 10-13-1998, FILED 11-18-1997.

MR. HOLLAND'S OPUS

THE NAME SHOWN IN THE MARK DOES NOT IDENTIFY A LIVING INDIVIDUAL.
FOR CHARITABLE FUND RAISING (U.S. CLS. 100, 101 AND 102).
FIRST USE 1-2-1997; IN COMMERCE 1-2-1997.

2,534,467. CNA FINANCIAL CORPORATION, TORONTO, ONTARIO, MSC 2V9, CANADA. SN 75-550,347. PUB. 8-8-2000, FILED 9-9-1998.



FOR INSURANCE SERVICES, NAMELY, UNDERWRITING SERVICES IN THE FIELD OF PROPERTY AND CASUALTY (U.S. CLS. 100, 101 AND 102).
FIRST USE 6-0-1998; IN COMMERCE 6-0-1998.

2,534,474. PUGLIN, MICHAEL J., ZELIENOPLE, PA. SN 75-564,244. PUB. 11-2-1999, FILED 10-2-1998.

REAL EZ

FOR REAL ESTATE SERVICES, NAMELY, PROVIDING INTERACTIVE DATABASES AND INFORMATION RELATED TO COMMERCIAL AND RESIDENTIAL REAL ESTATE LISTINGS, INSURANCE, AND MORTGAGE SERVICES, VIA A GLOBAL COMPUTER NETWORK (U.S. CLS. 100, 101 AND 102).
FIRST USE 3-17-2001; IN COMMERCE 3-17-2001.

CLASS 36—(Continued).

2,534,521. COMPLIANCE COACH, INC., SAN DIEGO, CA, BY ASSIGNMENT HUDA, SAI, SAN DIEGO, CA. SN 75-651,431. PUB. 1-25-2000, FILED 3-10-1999.

COMPLIANCE COACH

NO CLAIM IS MADE TO THE EXCLUSIVE RIGHT TO USE "COMPLIANCE", APART FROM THE MARK AS SHOWN.

FOR PROVIDING INFORMATION REGARDING FINANCIAL SERVICES AND FINANCIAL INSTITUTION REGULATORY COMPLIANCE VIA A GLOBAL COMPUTER NETWORK AND CONSULTING SERVICES THEREWITH (U.S. CLS. 100, 101 AND 102).

FIRST USE 4-30-1999; IN COMMERCE 4-30-1999.

2,534,593. WEINGARTEN, JEFFREY, LONDON W8 4RP, ENGLAND. SN 75-739,322. PUB. 7-24-2001, FILED 6-29-1999.

BUTTONWOOD

FOR FINANCIAL SERVICES, NAMELY, THE DISCRETIONARY MANAGEMENT OF PUBLIC AND PRIVATE INVESTMENT FOR OTHERS IN THE GLOBAL EQUITY MARKET (U.S. CLS. 100, 101 AND 102).

FIRST USE 10-0-1999; IN COMMERCE 10-0-1999.

2,534,609. SYMONS INTERNATIONAL GROUP, INC., INDIANAPOLIS, IN. SN 75-749,156. PUB. 1-25-2000, FILED 7-13-1999.

DRIVING BUSINESS

FOR AUTO INSURANCE SERVICES, NAMELY, UNDERWRITING, BROKERAGE, CLAIMS ADMINISTRATION, CLAIMS PROCESSING AND AGENCY SERVICES (U.S. CLS. 100, 101 AND 102).

FIRST USE 8-2-1999; IN COMMERCE 8-2-1999.

CLASS 36—(Continued).

2,534,612. PARTNER PLUS, LLC, MINNEAPOLIS, MN. SN 75-753,423. PUB. 4-3-2001, FILED 7-19-1999.

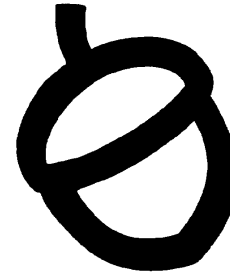

FOR ASSET MANAGEMENT SERVICES FOR FINANCIAL INSTITUTION CUSTOMERS, NAMELY, PURCHASING, MANAGEMENT AND COLLECTION OF ACCOUNTS RECEIVABLE (U.S. CLS. 100, 101 AND 102).

FIRST USE 8-1-1999; IN COMMERCE 8-1-1999.

2,534,645. DERIVIUM CAPITAL, L.L.C., SAN FRANCISCO, CA, BY CHANGE OF NAME FIRST SECURITY CAPITAL, L.L.C., SAN FRANCISCO, CA. SN 75-796,478. PUB. 5-16-2000, FILED 9-8-1999.

TAP INTO THE UPSIDE

FOR FINANCIAL SERVICES; NAMELY, PROVIDING FINANCING, HEDGING AND RISK MANAGEMENT SERVICES (U.S. CLS. 100, 101 AND 102).

FIRST USE 7-30-2001; IN COMMERCE 7-30-2001.

2,534,673. MARRIOTT INTERNATIONAL, INC., BETHESDA, MD. SN 75-825,686. PUB. 6-13-2000, FILED 10-18-1999.

SHADOW RIDGE

FOR REAL ESTATE SERVICES, NAMELY FINANCING, MANAGEMENT, BROKERAGE AND LEASING OF TIMESHARE PROPERTIES (U.S. CLS. 100, 101 AND 102).

FIRST USE 11-3-2000; IN COMMERCE 11-3-2000.

CLASS 36—(Continued).

2,534,688. FIREMAN'S FUND INSURANCE COMPANY, NOVATO, CA. SN 75-836,570. PUB. 11-14-2000, FILED 11-1-1999.

PRESTIGE AUTO

OWNER OF U.S. REG. NOS. 1,534,633 AND 1,534,636. NO CLAIM IS MADE TO THE EXCLUSIVE RIGHT TO USE "AUTO", APART FROM THE MARK AS SHOWN. FOR PROVIDING UNDERWRITING, CLAIMS, AND INSURANCE ADMINISTRATION FOR PROPERTY, CASUALTY, ACCIDENT, HEALTH, DISABILITY, AND WORKERS' COMPENSATION INSURANCE (U.S. CLS. 100, 101 AND 102). FIRST USE 7-1-1999; IN COMMERCE 7-1-1999.

2,534,775. LIBERTY FINANCIAL COMPANIES, INC., BOSTON, MA. SN 75-926,032. PUB. 11-21-2000, FILED 2-23-2000.

LIBERTY FUNDS

OWNER OF U.S. REG. NOS. 1,407,933, 1,479,977, AND 1,796,516. NO CLAIM IS MADE TO THE EXCLUSIVE RIGHT TO USE "FUNDS", APART FROM THE MARK AS SHOWN. FOR MUTUAL FUND INVESTMENT SERVICES (U.S. CLS. 100, 101 AND 102). FIRST USE 7-0-2000; IN COMMERCE 7-0-2000.

2,534,778. MICROSOFT CORPORATION, REDMOND, WA. SN 75-927,804. PUB. 11-14-2000, FILED 2-25-2000.

MAKE YOURSELF AT HOME

FOR PROVIDING INFORMATION CONCERNING REAL ESTATE, REAL ESTATE LISTINGS, REAL ESTATE FINANCING, REAL ESTATE AGENTS AND THE PURCHASE, SALE AND RENTAL OF REAL ESTATE, ALL VIA COMPUTER NETWORKS AND GLOBAL COMMUNICATIONS NETWORKS; AND REAL ESTATE BROKERAGE, REAL ESTATE APPRAISAL, REAL ESTATE INVESTMENT, REAL ESTATE LISTING, AND REAL ESTATE MANAGEMENT SERVICES, ALL PROVIDED VIA COMPUTER NETWORKS AND GLOBAL COMMUNICATIONS NETWORKS (U.S. CLS. 100, 101 AND 102). FIRST USE 5-15-2000; IN COMMERCE 5-15-2000.

2,534,811. METRIS DIRECT, INC., ST. LOUIS PARK, MN. SN 75-981,435. PUB. 7-25-2000, FILED 10-13-1999.

PUT THE WEB IN YOUR WALLET

FOR BANKING SERVICES (U.S. CLS. 100, 101 AND 102). FIRST USE 11-0-1999; IN COMMERCE 11-0-1999.

CLASS 36—(Continued).

2,534,813. GENERAL RE CORPORATION, STAMFORD, CT. SN 75-981,482. PUB. 12-26-2000, FILED 2-7-2000.

GEN RE

OWNER OF U.S. REG. NOS. 1,219,926, 2,064,414, AND OTHERS. FOR CONSULTATION SERVICES IN THE FIELDS OF FINANCIAL ANALYSIS, INVESTMENT ADVICE, ANALYSIS AND MANAGEMENT; FINANCIAL ANALYSIS SERVICES; INVESTMENT ADVICE, ANALYSIS AND MANAGEMENT SERVICES; SECURITIES BROKERAGE SERVICES (U.S. CLS. 100, 101 AND 102). FIRST USE 12-30-2000; IN COMMERCE 12-30-2000.

2,534,835. ULLICO INC., WASHINGTON, DC. SN 76-014,934. PUB. 12-12-2000, FILED 3-31-2000.



OWNER OF U.S. REG. NO. 1,875,543. FOR ORGANIZING PREFERRED PROVIDER PROGRAMS IN THE FIELD OF HEALTH CARE (U.S. CLS. 100, 101 AND 102). FIRST USE 11-15-2000; IN COMMERCE 11-15-2000.

2,534,852. JACKSON NATIONAL LIFE INSURANCE COMPANY, LANSING, MI. SN 76-029,921. PUB. 11-28-2000, FILED 4-20-2000.

JNL TARGET SELECT

OWNER OF U.S. REG. NO. 1,451,252. FOR ANNUITY UNDERWRITING SERVICES (U.S. CLS. 100, 101 AND 102). FIRST USE 5-1-2001; IN COMMERCE 5-1-2001.

2,534,858. COMMERCIAL FEDERAL BANK, OMAHA, NE. SN 76-035,409. PUB. 3-20-2001, FILED 4-27-2000.

COMFEDBANK

FOR BANKING SERVICES (U.S. CLS. 100, 101 AND 102). FIRST USE 6-1-1996; IN COMMERCE 6-1-1996.

CLASS 36—(Continued).

2,534,877. MELLON FINANCIAL CORPORATION, PITTSBURGH, PA. SN 76-046,980. PUB. 1-9-2001, FILED 5-12-2000.

MPAM

FOR FINANCIAL ASSET MANAGEMENT SERVICES (U.S. CLS. 100, 101 AND 102).
FIRST USE 5-13-1996; IN COMMERCE 5-13-1996.

2,534,949. TRAVERSE CITY STATE BANK, TRAVERSE CITY, MI. SN 78-004,180. PUB. 1-16-2001, FILED 4-14-2000.



NO CLAIM IS MADE TO THE EXCLUSIVE RIGHT TO USE "TRAVERSE CITY STATE BANK", APART FROM THE MARK AS SHOWN.
FOR BANKING (U.S. CLS. 100, 101 AND 102).
FIRST USE 7-6-2000; IN COMMERCE 7-6-2000.

2,534,972. MONEY-PASS.COM CORP., SCARSDALE, NY. SN 78-015,647. PUB. 2-13-2001, FILED 7-6-2000.

IDXCARD

FOR FINANCIAL SERVICES NAMELY, PROVIDING CREDIT CARD SERVICES, DEBIT CARD SERVICES, CHARGE CARD SERVICES, STORED VALUE CARD SERVICES, PREPAID PURCHASING CARD SERVICES, ELECTRONIC CASH TRANSACTIONS, ELECTRONIC PAYMENTS, NAMELY, ELECTRONIC PROCESSING AND TRANSMISSION OF BILL PAYMENT DATA ALL FEATURING PAYMENT ANONYMITY AND SECURITY FOR THE USER (U.S. CLS. 100, 101 AND 102).
FIRST USE 5-0-2000; IN COMMERCE 5-0-2000.

CLASS 37—CONSTRUCTION AND REPAIR**CLASS 37—(Continued).**

2,534,483. SUPER CLEAN YACHT SERVICE FRANCHISING, INC., NEWPORT BEACH, CA. SN 75-587,327. PUB. 9-28-1999, FILED 11-18-1998.



NO CLAIM IS MADE TO THE EXCLUSIVE RIGHT TO USE "SUPER CLEAN YACHT SERVICE", APART FROM THE MARK AS SHOWN.

FOR MARINE VESSEL CLEANING, INCLUDING WASH DOWNS, VARNISHING, AND TEAK OILING (U.S. CLS. 100, 103 AND 106).
FIRST USE 7-3-1998; IN COMMERCE 1-21-2000.

2,534,602. KWIK INDUSTRIES, INC., DALLAS, TX. SN 75-744,152. PUB. 1-16-2001, FILED 7-6-1999.

WASH-IT-KWIK

FOR LAUNDRY OF CLOTHING, FABRIC, LINEN AND TEXTILES (U.S. CLS. 100, 103 AND 106).
FIRST USE 4-0-1999; IN COMMERCE 4-0-1999.

2,534,936. ECO-LUBE CORPORATION, PALM BEACH GARDENS, FL. SN 76-150,353. PUB. 7-3-2001, FILED 10-19-2000.

ECO-LUBE

FOR VEHICLE LUBRICATION, VEHICLE GREASING, VEHICLE REPAIR AND MAINTENANCE, TIRE ROTATING AND BALANCING (U.S. CLS. 100, 103 AND 106).
FIRST USE 5-7-2001; IN COMMERCE 5-7-2001.

CLASS 38—COMMUNICATION

2,534,481. AT&T CORP., NEW YORK, NY. SN 75-582,413. PUB. 2-22-2000, FILED 11-5-1998.

AT&T LOCAL ONE RATE

OWNER OF U.S. REG. NOS. 215,460, 1,542,937, AND 1,960,607.

NO CLAIM IS MADE TO THE EXCLUSIVE RIGHT TO USE "LOCAL", APART FROM THE MARK AS SHOWN. SEC. 2(F) AS TO "ONE RATE".

FOR TELECOMMUNICATIONS SERVICES, NAMELY, THE ELECTRONIC TRANSMISSION OF VOICE, DATA, FACSIMILE AND INFORMATION (U.S. CLS. 100, 101 AND 104).

FIRST USE 10-31-1999; IN COMMERCE 10-31-1999.

CLASS 38—(Continued).

2,534,591. SUPERTUNER.COM, SANTA MONICA, CA, BY CHANGE OF NAME MEDIA & TRANSACTIONS, INC., SANTA MONICA, CA. SN 75-737,648. PUB. 1-30-2001, FILED 6-15-1999.

SUPERTUNER.COM

FOR ELECTRONIC VIDEO AND AUDIO MAIL SERVICES (U.S. CLS. 100, 101 AND 104).
FIRST USE 6-0-2000; IN COMMERCE 6-0-2000.

2,534,653. SMART CITY NETWORKS, MONTVALE, NJ, BY CHANGE OF NAME FACILITIES COMMUNICATION INTERNATIONAL LIMITED, DBA US TELCOM, MONTVALE, NJ. SN 75-803,056. PUB. 8-15-2000, FILED 9-17-1999.



OWNER OF U.S. REG. NO. 2,180,311.
FOR TELECOMMUNICATIONS SERVICES, NAMELY, PROVIDING HIGH-SPEED COMMUNICATIONS NETWORKS UTILIZING VOICE, DATA, VIDEO AND ON-LINE ACCESS THAT LINK CONVENTION CENTERS TO REMOTE LOCATIONS (U.S. CLS. 100, 101 AND 104).
FIRST USE 4-29-2001; IN COMMERCE 4-29-2001.

2,534,866. WESTERN INTEGRATED NETWORKS, LLC, DENVER, CO. SN 76-039,009. PUB. 4-3-2001, FILED 5-2-2000.

WINFIRST

FOR TELECOMMUNICATIONS SERVICES, NAMELY PROVIDING HIGH SPEED INTERNET ACCESS AND TRANSMISSION OF DATA, AUDIO, VIDEO AND OTHER SIGNALS OVER TELEPHONE, CABLE AND FIBER OPTIC NETWORKS (U.S. CLS. 100, 101 AND 104).
FIRST USE 9-17-2001; IN COMMERCE 9-17-2001.

CLASS 38—(Continued).

2,534,867. WESTERN INTEGRATED NETWORKS, LLC, DENVER, CO. SN 76-039,012. PUB. 4-3-2001, FILED 5-2-2000.

WWW WIRED WITH WINFIRST

FOR TELECOMMUNICATIONS SERVICES, NAMELY PROVIDING HIGH SPEED INTERNET ACCESS AND TRANSMISSION OF DATA, AUDIO, VIDEO AND OTHER SIGNALS OVER TELEPHONE, CABLE AND FIBER OPTIC NETWORKS (U.S. CLS. 100, 101 AND 104).
FIRST USE 9-17-2001; IN COMMERCE 9-17-2001.

2,534,868. WESTERN INTEGRATED NETWORKS, LLC, DENVER, CO. SN 76-039,013. PUB. 4-3-2001, FILED 5-2-2000.



FOR TELECOMMUNICATIONS SERVICES, NAMELY PROVIDING HIGH SPEED INTERNET ACCESS AND TRANSMISSION OF DATA, AUDIO, VIDEO AND OTHER SIGNALS OVER TELEPHONE, CABLE AND FIBER OPTIC NETWORKS (U.S. CLS. 100, 101 AND 104).
FIRST USE 9-17-2001; IN COMMERCE 9-17-2001.

2,534,869. WESTERN INTEGRATED NETWORKS, LLC, DENVER, CO. SN 76-039,015. PUB. 4-3-2001, FILED 5-2-2000.

THE FASTEST ROUTE TO THE INTERNET AND BACK

FOR TELECOMMUNICATIONS SERVICES, NAMELY PROVIDING HIGH SPEED INTERNET ACCESS AND TRANSMISSION OF DATA, AUDIO, VIDEO AND OTHER SIGNALS OVER TELEPHONE, CABLE AND FIBER OPTIC NETWORKS (U.S. CLS. 100, 101 AND 104).
FIRST USE 9-17-2001; IN COMMERCE 9-17-2001.

CLASS 38—(Continued).

2,534,880. MOBILESPRING, INC., NEW YORK, NY. SN 76-053,869. PUB. 4-17-2001, FILED 5-19-2000.

MOBILESPRING

FOR TELECOMMUNICATION SERVICES, NAMELY, WIRELESS INTERNET SERVICES AND INTERCONNECTION SERVICES; TELECOMMUNICATION NETWORK ENGINEERING SERVICES, NAMELY, SYSTEM INTEGRATION AND NETWORK INTERCONNECTIVITY (U.S. CLS. 100, 101 AND 104).

FIRST USE 3-14-2000; IN COMMERCE 3-14-2000.

CLASS 40—(Continued).

2,534,402. CONTINENTAL DYNAMICS CORPORATION, PORT WASHINGTON, NY. SN 75-391,645. PUB. 10-19-1999, FILED 11-17-1997.

GO CONFIGURE

FOR CUSTOMIZED MANUFACTURE OF COMPUTER HARDWARE FOR OTHERS (U.S. CLS. 100, 103 AND 106).

FIRST USE 12-0-1997; IN COMMERCE 12-0-1997.

2,534,935. NIVIN INC., BROOKFIELD, WI. SN 76-144,791. PUB. 6-26-2001, FILED 10-11-2000.

BIOWANT

FOR COMPUTER SERVICES, NAMELY, PROVIDING ON-LINE ELECTRONIC BULLETIN BOARDS FOR TRANSMISSION OF MESSAGES AMONG COMPUTER USERS CONCERNING BIOTECHNOLOGY PRODUCTS BY LISTING MANUFACTURED MATERIALS, METHODS, NEWS AND USER NEEDS (U.S. CLS. 100, 101 AND 104).

FIRST USE 6-1-2001; IN COMMERCE 6-1-2001.

2,534,623. PHOTO-TECH, INC, SARASOTA, FL. SN 75-770,967. PUB. 1-25-2000, FILED 8-9-1999.

IMAGEARCHIVE

FOR ELECTRONIC IMAGING, SCANNING, DIGITIZING, ALTERATION AND/OR RE-TOUCHING OF PHOTOGRAPHIC IMAGES AND NEGATIVES (U.S. CLS. 100, 103 AND 106).

FIRST USE 2-8-2000; IN COMMERCE 2-8-2000.

CLASS 39—TRANSPORTATION AND STORAGE

2,534,740. NEXTJET, INC., DALLAS, TX. SN 75-891,941. PUB. 2-13-2001, FILED 1-7-2000.

NEXTJETOUT

FOR PICK-UP, TRANSPORTATION, STORAGE, DELIVERY OF DOCUMENTS, PACKAGES AND FREIGHT BY LAND AND AIR (U.S. CLS. 100 AND 105).

FIRST USE 3-31-2001; IN COMMERCE 3-31-2001.

2,534,986. MASLEY, FRANCIS, J., WILMINGTON, DE. SN 78-036,690. PUB. 7-31-2001, FILED 11-27-2000.

HANDLOGIC

FOR CUSTOM MANUFACTURE AND FITTING OF PROTECTIVE HANDWEAR (U.S. CLS. 100, 103 AND 106).

FIRST USE 10-3-2001; IN COMMERCE 10-15-2001.

2,534,741. NEXTJET, INC., DALLAS, TX. SN 75-891,942. PUB. 9-12-2000, FILED 1-7-2000.

NEXTJETIT

FOR PICK-UP, TRANSPORTATION, STORAGE, DELIVERY OF DOCUMENTS, PACKAGES AND FREIGHT BY LAND AND AIR (U.S. CLS. 100 AND 105).

FIRST USE 7-31-2001; IN COMMERCE 7-31-2001.

CLASS 41—EDUCATION AND ENTERTAINMENT

2,534,349. RAINEY & RAINEY ENTERPRISES, INC., INGLEWOOD, NJ. SN 74-728,039. PUB. 12-1-1998, FILED 9-12-1995.

MISS/MRS. NUBIAN PAGEANT

NO CLAIM IS MADE TO THE EXCLUSIVE RIGHT TO USE "PAGEANTS", APART FROM THE MARK AS SHOWN.

FOR PAGEANTS IN THE NATURE OF COMPETITIONS ON THE BASIS OF THE PARTICIPANT'S APPEARANCE, CULTURAL HERITAGE, KNOWLEDGE AND SOCIAL SKILLS (U.S. CLS. 100, 101 AND 107).

FIRST USE 5-15-1994; IN COMMERCE 5-15-1994.

CLASS 40—MATERIAL TREATMENT

CLASS 41—(Continued).

2,534,371. CARTOON NETWORK LP, LLLP, THE, ATLANTA, GA, BY CHANGE OF NAME CARTOON NETWORK, INC., THE, ATLANTA, GA. SN 75-240,193. PUB. 6-2-1998, FILED 2-11-1997.

ANIMATE YOUR WORLD

FOR EDUCATIONAL AND ENTERTAINMENT SERVICES, NAMELY, EDUCATION AND ENTERTAINMENT IN THE NATURE OF ONGOING PROGRAMS IN THE FIELD OF VARIETY RELATED TO ANIMATION, PROVIDED THROUGH CABLE AND BROADCAST TELEVISION, RADIO, AND ON THE GLOBAL COMPUTER INFORMATION NETWORK (U.S. CLS. 100, 101 AND 107).

FIRST USE 4-7-1999; IN COMMERCE 8-7-1999.

2,534,409. E! ENTERTAINMENT TELEVISION, INC., LOS ANGELES, CA. SN 75-412,108. PUB. 9-1-1998, FILED 12-30-1997.

WEB SOUP

NO CLAIM IS MADE TO THE EXCLUSIVE RIGHT TO USE "WEB", APART FROM THE MARK AS SHOWN.

FOR ENTERTAINMENT IN THE NATURE OF ONGOING TELEVISION PROGRAMS IN THE FIELD OF THE GLOBAL COMPUTER INFORMATION NETWORK (U.S. CLS. 100, 101 AND 107).

FIRST USE 5-24-2001; IN COMMERCE 5-24-2001.

2,534,412. RUMBERA STEREO 101.9 F.M., C.A., VENZUELA CODIGO, VENEZUELA. SN 75-424,321. PUB. 10-5-1999, FILED 1-27-1998.

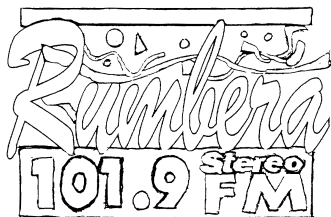

PRIORITY CLAIMED UNDER SEC. 44(D) ON VENEZUELA APPLICATION NO. 95-11385, FILED 8-3-1995, REG. NO. FM-02-NO531, DATED 8-3-1995, EXPIRES 3-7-2007.

NO CLAIM IS MADE TO THE EXCLUSIVE RIGHT TO USE "RUMBERA 101.0 STEREO FM", APART FROM THE MARK AS SHOWN.

THE WORD "RUMBERA" MEANS "A WOMAN DANCER OF RUMBA" WHICH IS A DANCE OF CUBAN NEGRO ORIGIN AND COMPLEX RHYTHM, CHARACTERIZED BY EMPHASIZED RHYTHMIC MOVEMENTS OF THE LOWER PART OF THE BODY.

FOR RADIO BROADCASTING, SCHEDULING RADIO PROGRAMMING (U.S. CLS. 100, 101 AND 107).

FIRST USE 8-3-1995; IN COMMERCE 1-1-1998.

CLASS 41—(Continued).

2,534,420. BOB BONDURANT SCHOOL OF HIGH PERFORMANCE DRIVING, INC., THE, CHANDLER, AZ. SN 75-461,297. PUB. 12-21-1999, FILED 4-3-1998.

BONDURANT SUPERKART

NO CLAIM IS MADE TO THE EXCLUSIVE RIGHT TO USE "SUPERKART", APART FROM THE MARK AS SHOWN.

FOR ENTERTAINMENT SERVICES IN THE NATURE OF STAGING RACING EVENTS (U.S. CLS. 100, 101 AND 107).

FIRST USE 12-0-1998; IN COMMERCE 12-0-1998.

2,534,490. BISHOP RINK HOLDINGS, LLC, RAPID CITY, KS, BY ASSIGNMENT KANSAS ICE OPERATING CO., L.L.C., LENEXA, KS. SN 75-598,562. PUB. 5-16-2000, FILED 12-3-1998.

ICE MIDWEST

FOR ENTERTAINMENT SERVICES, NAMELY, ICE SKATING RINK AND FITNESS CENTER SERVICES (U.S. CLS. 100, 101 AND 107).

FIRST USE 11-4-2000; IN COMMERCE 11-4-2000.

2,534,494. UNIVERSAL CITY STUDIOS, INC., UNIVERSAL CITY, CA. SN 75-605,058. PUB. 7-10-2001, FILED 12-14-1998.

SILVER STAR TICKET

NO CLAIM IS MADE TO THE EXCLUSIVE RIGHT TO USE "TICKET", APART FROM THE MARK AS SHOWN.

FOR AMUSEMENT PARK SERVICES (U.S. CLS. 100, 101 AND 107).

FIRST USE 8-6-1998; IN COMMERCE 8-6-1998.

CLASS 41—(Continued).

2,534,524. ROZA, MIKE, SAN CARLOS, CA. SN 75-655,124. PUB. 6-13-2000, FILED 3-5-1999.



NO CLAIM IS MADE TO THE EXCLUSIVE RIGHT TO USE "PITCHING ACADEMY", APART FROM THE MARK AS SHOWN.

THE FIGURE DEPICTED IN THE DRAWING DOES NOT DEPICT ANY PARTICULAR LIVING INDIVIDUAL.

FOR EDUCATIONAL SERVICES, NAMELY CONDUCTING SPORTS CLINICS IN THE FIELD OF BASEBALL (U.S. CLS. 100, 101 AND 107).

FIRST USE 3-1-1999; IN COMMERCE 1-2-2001.

CLASS 41—(Continued).

2,534,564. LYN, DAVID, WESTCHESTER, CA. SN 75-705,645. PUB. 12-21-1999, FILED 5-14-1999.

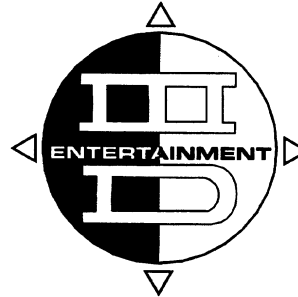

NO CLAIM IS MADE TO THE EXCLUSIVE RIGHT TO USE "ENTERTAINMENT", APART FROM THE MARK AS SHOWN.

FOR ENTERTAINMENT SERVICES, NAMELY, AUDIO AND RECORDING PRODUCTION OF ARTISTS AND RECORD PRODUCTION (U.S. CLS. 100, 101 AND 107).

FIRST USE 7-0-1999; IN COMMERCE 10-0-1999.

2,534,537. TRIEBOLD PALEONTOLOGY, INC., WOODLAND PARK, CO. SN 75-676,729. PUB. 7-25-2000, FILED 4-7-1999.

SAVAGE ANCIENT SEAS

NO CLAIM IS MADE TO THE EXCLUSIVE RIGHT TO USE "SEAS", APART FROM THE MARK AS SHOWN.

FOR ENTERTAINMENT AND EDUCATIONAL SERVICES IN THE NATURE OF PRESENTING TRAVELING EXHIBITIONS ABOUT PALEONTOLOGY AND FOSSILS, PARTICULARLY OCEANIC FOSSILS (U.S. CLS. 100, 101 AND 107).

FIRST USE 10-26-1999; IN COMMERCE 6-0-2000.

2,534,570. COHEN BROWN PICTURE COMPANY, INC., LOS ANGELES, CA. SN 75-711,248. PUB. 12-28-1999, FILED 5-20-1999.

**ONEFINANCIAL
INSTITUTIONISM**

FOR EDUCATIONAL SERVICES, NAMELY, CONDUCTING CLASSES, SEMINARS, CONFERENCES AND WORKSHOPS IN THE FIELD OF BANKING, BROKERAGE, MORTGAGE, INSURANCE AND FINANCE AND DISTRIBUTING COURSE MATERIALS IN CONNECTION THEREWITH; DEVELOPING AND DISSEMINATING EDUCATIONAL MATERIALS FOR OTHERS IN THE FIELD OF BANKING, BROKERAGE, MORTGAGE, INSURANCE AND FINANCE (U.S. CLS. 100, 101 AND 107).

FIRST USE 9-0-1999; IN COMMERCE 9-0-1999.

2,534,559. STEWART, TRICIA, SANTA MONICA, CA. SN 75-700,514. PUB. 5-29-2001, FILED 6-3-1999.

HUMAN BEING COMPANY

FOR EDUCATIONAL SERVICES, NAMELY, CONDUCTING CLASSES AND SEMINARS REGARDING RE-INVENTING LIFE, CAREER AND BUSINESS AND DISTRIBUTING COURSE MATERIALS IN CONNECTION THEREWITH (U.S. CLS. 100, 101 AND 107).

FIRST USE 6-1-1998; IN COMMERCE 6-1-1998.

2,534,576. HICKS, ERIC, SPRINGFIELD GARDENS, NY. SN 75-718,908. PUB. 1-11-2000, FILED 6-4-1999.

SHAKIN'

FOR ENTERTAINMENT SERVICES COMPRISING COMPETITIONS RELATING TO BASKETBALL SKILLS (U.S. CLS. 100, 101 AND 107).

FIRST USE 12-1-2000; IN COMMERCE 12-1-2000.

CLASS 41—(Continued).

2,534,577. BORDEN, INC., COLUMBUS, OH. SN 75-719,091. PUB. 1-16-2001, FILED 6-2-1999.

R.E.L.A.Y. REFINING THE EDUCATIONAL LINK TO AMERICA'S YOUTH

NO CLAIM IS MADE TO THE EXCLUSIVE RIGHT TO USE "EDUCATIONAL YOUTH", APART FROM THE MARK AS SHOWN.

FOR EDUCATIONAL AND MENTORING SERVICES FOR YOUTH TO DEVELOP EMPLOYMENT SKILLS (U.S. CLS. 100, 101 AND 107).

FIRST USE 7-27-2000; IN COMMERCE 7-27-2000.

CLASS 41—(Continued).

2,534,713. Q-SPORT, LLC, SANTA BARBARA, CA. SN 75-855,007. PUB. 3-6-2001, FILED 12-8-1999.

CHOOSE TO QRUZE

FOR PHYSICAL FITNESS INSTRUCTION AND CONSULTATION, NAMELY, PROVIDING INSTRUCTION AND TRAINING TO OTHERS BY SIMULATING AN OUTDOOR BICYCLE WORKOUT COMPLETED INDOORS ON A STATIONARY BICYCLE; PROVIDING FACILITIES FOR RECREATION AND PHYSICAL FITNESS ACTIVITIES; PROVIDING A WEBSITE FEATURING INFORMATION PERTAINING TO HEALTH, FITNESS, EXERCISE AND RELATED SUBJECTS (U.S. CLS. 100, 101 AND 107).

FIRST USE 12-1-1999; IN COMMERCE 12-1-1999.

2,534,583. H-D MICHIGAN, INC., ANN ARBOR, MI. SN 75-723,030. PUB. 5-9-2000, FILED 10-21-1999.

RIDER'S EDGE

NO CLAIM IS MADE TO THE EXCLUSIVE RIGHT TO USE "RIDER'S", APART FROM THE MARK AS SHOWN.

FOR PROVIDING EDUCATIONAL SERVICES IN THE NATURE OF CLASSROOM AND HANDS-ON SEMINARS FEATURING THE TECHNIQUE OF RIDING AND MAINTAINING A MOTORCYCLE, AND DISTRIBUTING COURSE MATERIALS IN CONNECTION THEREWITH (U.S. CLS. 100, 101 AND 107).

FIRST USE 8-1-2000; IN COMMERCE 8-1-2000.

2,534,735. CREIGHTON UNIVERSITY, OMAHA, NE. SN 75-883,268. PUB. 10-3-2000, FILED 12-29-1999.

BRAINS RULE

FOR EDUCATIONAL SERVICES, NAMELY, PROVIDING INTERACTIVE EDUCATIONAL WORKSHOPS IN THE FIELDS OF SCIENCE, MEDICINE AND TECHNOLOGY VIA AN INTERACTIVE COMPUTER NETWORK (U.S. CLS. 100, 101 AND 107).

FIRST USE 8-15-2000; IN COMMERCE 11-10-2000.

2,534,638. NY DANCE STUDIOS, INC., NEW YORK, NY. SN 75-792,229. PUB. 1-16-2001, FILED 9-3-1999.

YOU SHOULD BE DANCING

NO CLAIM IS MADE TO THE EXCLUSIVE RIGHT TO USE "DANCING", APART FROM THE MARK AS SHOWN.

FOR ENTERTAINMENT SERVICES, NAMELY, PROVIDING DANCING INSTRUCTIONS AND DANCE STUDIO SERVICES (U.S. CLS. 100, 101 AND 107).

FIRST USE 10-1-1999; IN COMMERCE 10-1-1999.

2,534,739. TELEVISION FOOD NETWORK, G.P., NEW YORK, NY. SN 75-886,805. PUB. 4-17-2001, FILED 1-5-2000.

FOOD 911

NO CLAIM IS MADE TO THE EXCLUSIVE RIGHT TO USE "FOOD", APART FROM THE MARK AS SHOWN.

FOR TELEVISION ENTERTAINMENT SERVICES, NAMELY, AN ON-GOING TELEVISION PROGRAM IN THE FIELDS OF COOKING, ENTERTAINING AND THE CULINARY ARTS (U.S. CLS. 100, 101 AND 107).

FIRST USE 4-13-2000; IN COMMERCE 4-13-2000.

2,534,663. STRALSER, STEVEN, TUCSON, AZ. SN 75-814,128. PUB. 12-5-2000, FILED 10-4-1999.

MBA BOOTCAMP

NO CLAIM IS MADE TO THE EXCLUSIVE RIGHT TO USE "MBA", APART FROM THE MARK AS SHOWN.

FOR EDUCATIONAL SERVICES; NAMELY, CONDUCTING SEMINARS IN THE FIELD OF BUSINESS MANAGEMENT, INTERPERSONAL SKILLS, AND CORPORATE BUDGETING STRATEGIES (U.S. CLS. 100, 101 AND 107).

FIRST USE 8-3-2001; IN COMMERCE 8-3-2001.

2,534,792. BOYS & GIRLS CLUBS OF AMERICA, ATLANTA, GA. SN 75-941,649. PUB. 4-10-2001, FILED 3-10-2000.

CAREER LAUNCH

NO CLAIM IS MADE TO THE EXCLUSIVE RIGHT TO USE "CAREER", APART FROM THE MARK AS SHOWN.

FOR EDUCATIONAL SERVICES, NAMELY, CONDUCTING CLASSES AND WORKSHOPS FOR YOUTHS FEATURING CAREER AND JOB TOPICS (U.S. CLS. 100, 101 AND 107).

FIRST USE 5-0-2000; IN COMMERCE 5-0-2000.

CLASS 41—(Continued).

2,534,798. GENERAL MILLS, INC., MINNEAPOLIS, MN. SN 75-960,326. PUB. 1-9-2001, FILED 3-15-2000.

CEREAL ADVENTURE

FOR AMUSEMENT CENTERS (U.S. CLS. 100, 101 AND 107).

FIRST USE 6-12-2001; IN COMMERCE 6-12-2001.

2,534,826. TIMEX CORPORATION, MIDDLEBURY, CT. SN 76-010,368. PUB. 12-26-2000, FILED 3-27-2000.

TIMEXPO

FOR MUSEUMS; TRAVELING MUSEUMS; PUBLICATION OF BOOKS, MAGAZINES AND BROCHURES (U.S. CLS. 100, 101 AND 107).

FIRST USE 5-0-2001; IN COMMERCE 5-0-2001.

2,534,855. DORMAIER, CHRISTINE G., SEATTLE, WA. SN 76-031,941. PUB. 3-6-2001, FILED 4-21-2000.

STRONG BONES YOGA

NO CLAIM IS MADE TO THE EXCLUSIVE RIGHT TO USE "YOGA", APART FROM THE MARK AS SHOWN.

FOR EDUCATIONAL SERVICES, NAMELY, CONDUCTING YOGA EXERCISE CLASSES AND COURSES FEATURING INSTRUCTION IN YOGA AND YOGA THERAPY (U.S. CLS. 100, 101 AND 107).

FIRST USE 4-0-1998; IN COMMERCE 4-0-1998.

2,534,887. KURASZ, BILL, SCOTTSDALE, AZ. SN 76-055,345. PUB. 1-16-2001, FILED 5-24-2000.

ACAPELLAFELLA

FOR ENTERTAINMENT SERVICES OFFERED OVER A WORLD WIDE COMPUTER NETWORK, NAMELY MUSICAL GREETINGS DELIVERED BY A CARTOON CHARACTER (U.S. CLS. 100, 101 AND 107).

FIRST USE 1-26-2001; IN COMMERCE 1-26-2001.

2,534,889. CNI HOLDING CORPORATION, CLEARWATER, FL. SN 76-056,997. PUB. 1-30-2001, FILED 5-25-2000.

ETC

FOR ENTERTAINMENT SERVICES, NAMELY TELEVISION PROGRAMMING AND PRODUCTION IN THE FIELD OF NEWS, MUSIC, MUSIC VIDEOS, MOVIES AND TALK SHOWS (U.S. CLS. 100, 101 AND 107).

FIRST USE 6-15-2001; IN COMMERCE 6-15-2001.

CLASS 41—(Continued).

2,534,916. LEXINGTON PROFESSIONAL BASEBALL COMPANY, LLC, LEXINGTON, KY. SN 76-095,413. PUB. 5-29-2001, FILED 7-25-2000.



NO CLAIM IS MADE TO THE EXCLUSIVE RIGHT TO USE "LEXINGTON" AND "PROFESSIONAL BASEBALL CLUB", APART FROM THE MARK AS SHOWN.

FOR ENTERTAINMENT IN THE NATURE OF PROFESSIONAL BASEBALL GAMES (U.S. CLS. 100, 101 AND 107).

FIRST USE 8-3-2000; IN COMMERCE 8-3-2000.

2,534,944. GEORGE GALUSTIAN, CHATSWORTH, CA. SN 78-001,168. PUB. 12-5-2000, FILED 3-27-2000.

**ASTROGARDEN PROJECT
R&D**

NO CLAIM IS MADE TO THE EXCLUSIVE RIGHT TO USE "R&D", APART FROM THE MARK AS SHOWN.

FOR ENTERTAINMENT SERVICES, NAMELY PROVIDING ON-LINE VIRTUAL REALITY AMUSEMENT PARKS (U.S. CLS. 100, 101 AND 107).

FIRST USE 11-20-1994; IN COMMERCE 8-1-1999.

**CLASS 42—SCIENTIFIC, COMPUTER AND
LEGAL SERVICES**

2,534,362. GENUITY INC., BURLINGTON, MA. SN 75-209,713. PUB. 11-16-1999, FILED 12-9-1996.

HOPSCOTCH

FOR CONSULTATION AND COMPUTER SERVICES RELATING TO USE AND UPDATING OF INFORMATION ON A GLOBAL COMPUTER INFORMATION NETWORK AND OTHER COMPUTER NETWORKS, FOR THE ELECTRONIC TRANSMISSION, STORAGE, RETRIEVAL AND DISSEMINATION OF DATA, IMAGES, DOCUMENTS AND MESSAGES; FOR PROVIDING ACCESS TO A GLOBAL COMPUTER INFORMATION NETWORK AND OTHER COMPUTER NETWORKS; FOR WEB PAGE HOSTING AND WEB PAGE DESIGN; FOR SECURING INFORMATION TRANSMITTED ON A GLOBAL COMPUTER NETWORK AND OTHER COMPUTER NETWORKS; AND FOR PROVIDING THE OPTIMAL MEANS TO ACCESS A GLOBAL COMPUTER NETWORK AND OTHER COMPUTER NETWORKS, AND THE OPTIMAL SELECTION OF SERVERS TO ACCOMPLISH SUCH ACCESS (U.S. CLS. 100 AND 101).

FIRST USE 9-0-1997; IN COMMERCE 9-0-1997.

CLASS 42—(Continued).

2,534,387. DOW INDUSTRIES, INC., WILMINGTON, MA. SN 75-326,454. PUB. 5-19-1998, FILED 7-16-1997.

LABELCARE

FOR DESIGNING AND PRINTING SPECIALIZED PHARMACEUTICAL LABELS IN ACCORDANCE WITH GOVERNMENT GUIDELINES (U.S. CLS. 100 AND 101).
FIRST USE 4-15-1986; IN COMMERCE 4-15-1986.

2,534,425. EASTERN PRESS, INC., BERKELEY, CA. SN 75-466,689. PUB. 6-15-1999, FILED 7-20-1998.

WEB AND MORE

NO CLAIM IS MADE TO THE EXCLUSIVE RIGHT TO USE "WEB", APART FROM THE MARK AS SHOWN.

FOR HOSTING THE WEB SITES OF OTHERS ON A COMPUTER SERVER FOR A GLOBAL COMPUTER NETWORK AND, COMPUTER SERVICES, NAMELY, CREATING AND MAINTAINING WEB SITES FOR OTHERS, EXCLUDING THE HOSTING OR USE OF WEB SITES WHICH ARE USED IN THE DESIGN, CREATION, ORDERING OR PROVISION OF STATIONERY, BUSINESS FORMS, LABELS, BROCHURES, PAMPHLETS, DIRECT OR RESPONSE MAIL PIECES, STATEMENTS OR PERSONALIZED PRODUCTS WHETHER IN PRINTED OR ELECTRONIC FORM (U.S. CLS. 100 AND 101).

FIRST USE 7-0-1998; IN COMMERCE 7-0-1998.

2,534,445. XTENIT, INC., NEW YORK, NY. SN 75-508,623. PUB. 7-13-1999, FILED 6-25-1998.

XTENIT

FOR COMPUTER SOFTWARE DESIGN AND DEVELOPMENT FOR OTHERS IN THE FIELDS OF FINANCIAL AND INFORMATION SERVICES; COMPUTER CONSULTATION SERVICES, NAMELY, PROVIDING RESEARCH AND ANALYSIS OF COMPUTER SOFTWARE AND COMPUTER SYSTEMS AND INFORMATION TECHNOLOGIES (U.S. CLS. 100 AND 101).

FIRST USE 6-30-1998; IN COMMERCE 6-30-1998.

2,534,450. IDAYO INVESTOR, INC., PHILADELPHIA, PA, BY CHANGE OF NAME; BY CHANGE OF NAME; BY MERGER; BY CHANGE OF NAME MUTUAL DISCOVERY NETWORK, L.L.C., THE, PHILADELPHIA, PA. SN 75-520,446. PUB. 11-9-1999, FILED 7-16-1998.

FUND4YOU

NO CLAIM IS MADE TO THE EXCLUSIVE RIGHT TO USE "FUND", APART FROM THE MARK AS SHOWN.

FOR COMPUTER SERVICES, NAMELY, PROVIDING A SEARCH ENGINE FOR OBTAINING DATA ON A GLOBAL COMPUTER NETWORK ABOUT MUTUAL FUNDS CONTAINING ASSETS IN PARTICULAR COMPANIES (U.S. CLS. 100 AND 101).

FIRST USE 8-0-1998; IN COMMERCE 8-0-1998.

CLASS 42—(Continued).

2,534,462. M.N.P.M., L.L.C., TRAVERSE CITY, MI. SN 75-541,935. PUB. 6-22-1999, FILED 8-24-1998.

CHERRY TREE INN ON THE BEACH

NO CLAIM IS MADE TO THE EXCLUSIVE RIGHT TO USE "INN ON THE BEACH", APART FROM THE MARK AS SHOWN.

FOR HOTEL/MOTEL SERVICES (U.S. CLS. 100 AND 101).

FIRST USE 4-1-1998; IN COMMERCE 3-0-1999.

2,534,500. SECURIFY INTERNATIONAL, INC., PALO ALTO, CA, BY MERGER KROL-O'GARA COMPANY, THE, FAIRFIELD, OH. SN 75-615,798. PUB. 6-13-2000, FILED 1-5-1999.

SECURIFY

FOR SECURITY SERVICES, NAMELY, COMPUTER SECURITY CONSULTING, AUDITING OF HARDWARE AND SOFTWARE FOR FRAUD PREVENTION, COMPUTER CRIMES, AND POTENTIAL SECURITY RISKS IN THE NATURE OF BREACHES OF ENCRYPTION, CERTIFICATION, AUTHORIZATION, AUTHENTICATION, DATA SECRECY AND DATE INTEGRITY PROGRAMS ON LOCAL COMPUTER NETWORKS; GLOBAL COMPUTER NETWORK SECURITY SERVICES, NAMELY, AUDITING, MONITORING, AND MAINTENANCE OF ENCRYPTION, CERTIFICATION, AUTHORIZATION, AUTHENTICATION, DATA SECRECY AND DATA INTEGRITY PROGRAMS FOR TRANSMISSION AND EXCHANGE OF DATA ON A GLOBAL COMPUTER NETWORK; AND DESIGN OF COMPUTER SOFTWARE FOR OTHERS (U.S. CLS. 100 AND 101).

FIRST USE 9-0-1998; IN COMMERCE 9-0-1998.

2,534,509. MEREDITH CORPORATION, DES MOINES, IA. SN 75-631,609. PUB. 7-11-2000, FILED 2-1-1999.

HEALTHY DOSE

FOR PROVIDING ON-LINE INFORMATION REGARDING HEALTH ISSUES (U.S. CLS. 100 AND 101).

FIRST USE 4-13-1999; IN COMMERCE 4-13-1999.

2,534,516. MARLYN NUTRACEUTICALS, INC., DBA NATURALLY VITAMINS, SCOTTSDALE, AZ. SN 75-642,494. PUB. 12-5-2000, FILED 2-17-1999.

NATURALLY.COM

FOR PROVIDING INFORMATION IN THE FIELD OF VITAMINS AND NUTRITIONAL SUPPLEMENTS BY MEANS OF A GLOBAL COMPUTER INFORMATION NETWORK (U.S. CLS. 100 AND 101).

FIRST USE 8-1-2001; IN COMMERCE 8-27-2001.

CLASS 42—(Continued).

2,534,525. WHITE CASTLE SYSTEM, INC., COLUMBUS, OH.
SN 75-655,334. PUB. 11-2-1999, FILED 3-8-1999.

CRAVE TALES

OWNER OF U.S. REG. NOS. 1,944,615, 2,105,125, AND OTHERS.
FOR RESTAURANT SERVICES (U.S. CLS. 100 AND 101).
FIRST USE 5-2-1999; IN COMMERCE 5-2-1999.

2,534,527. WHATABURGER, INC., CORPUS CHRISTI, TX.
SN 75-657,290. PUB. 11-16-1999, FILED 3-10-1999.

**WHATAPLACE!
WHATATASTE!**

FOR RESTAURANT SERVICES (U.S. CLS. 100 AND 101).
FIRST USE 10-11-1998; IN COMMERCE 10-11-1998.

2,534,582. INTERSIL AMERICAS INC., IRVINE, CA, BY ASSIGNMENT; BY ASSIGNMENT; BY ASSIGNMENT
INTERFIL CORPORATION, PALM BAY, FL. SN 75-721,751. PUB. 8-8-2000, FILED 6-4-1999.

INTERSIL

FOR INFORMATION SERVICES, NAMELY, PROVIDING TECHNICAL AND NON-TECHNICAL INFORMATION ON SEMICONDUCTORS, INCLUDING DISCRETE AND INTEGRATED CIRCUIT DEVICES; COMPUTER HARDWARE AND SOFTWARE CONSULTING SERVICES; MAINTENANCE OF COMPUTER SOFTWARE AND TECHNICAL SUPPORT, NAMELY, TROUBLESHOOTING OF COMPUTER HARDWARE AND SOFTWARE PROBLEMS VIA REMOTE ACCESS OVER TELECOMMUNICATION FACILITIES AND IN PERSON (U.S. CLS. 100 AND 101).
FIRST USE 8-0-1999; IN COMMERCE 8-0-1999.

2,534,584. HENDRY, DAVID W., JR., DBA JCRS, OAKLAND, CA. SN 75-729,482. PUB. 1-11-2000, FILED 6-22-1999.

GEMQUOTE

FOR PROVIDING INFORMATION REGARDING GEMSTONES (U.S. CLS. 100 AND 101).
FIRST USE 6-0-1991; IN COMMERCE 6-0-1991.

CLASS 42—(Continued).

2,534,592. CULINARY AMUSEMENTS, INC., LINCOLN, MA.
SN 75-739,294. PUB. 11-14-2000, FILED 6-29-1999.

ZUMA

FOR RESTAURANT SERVICES (U.S. CLS. 100 AND 101).
FIRST USE 11-20-1989; IN COMMERCE 11-20-1989.

2,534,608. BOI NA BRAZA, INC., GRAPEVINE, TX. SN 75-748,967. PUB. 1-23-2001, FILED 7-1-1999.

BOI NA BRAZA

THE ENGLISH TRANSLATION OF "BOI NA BRAZA" MEANS "OX IN EMBERS".
FOR RESTAURANT SERVICES (U.S. CLS. 100 AND 101).
FIRST USE 7-19-1999; IN COMMERCE 9-11-2000.

2,534,619. COBALT PICTURES, INC., CORAL GABLES, FL.
SN 75-765,648. PUB. 12-12-2000, FILED 8-2-1999.

ZOOMSTOCK

FOR LICENSING THE INTELLECTUAL PROPERTY RIGHTS OF PHOTOGRAPHS (U.S. CLS. 100 AND 101).
FIRST USE 1-1-2000; IN COMMERCE 1-1-2000.

2,534,633. LAFITTE SPORTMAN'S LODGE, INC., NEW ORLEANS, LA. SN 75-781,309. PUB. 12-5-2000, FILED 8-20-1999.



NO CLAIM IS MADE TO THE EXCLUSIVE RIGHT TO USE "LODGE OF LOUISIANA", APART FROM THE MARK AS SHOWN.
FOR HOTELS, RESTAURANT, AND COCKTAIL LOUNGE SERVICES (U.S. CLS. 100 AND 101).
FIRST USE 6-0-1999; IN COMMERCE 6-0-1999.

CLASS 42—(Continued).

2,534,634. KEEFER CONSULTING, INC., PHILADELPHIA, PA. SN 75-781,444. PUB. 12-19-2000, FILED 8-23-1999.



NO CLAIM IS MADE TO THE EXCLUSIVE RIGHT TO USE "CONSULTING, INC.", APART FROM THE MARK AS SHOWN.

SEC. 2(F).
FOR COMPUTER CONSULTATION IN THE FIELD OF INFORMATION SYSTEMS (U.S. CLS. 100 AND 101).
FIRST USE 6-15-1999; IN COMMERCE 6-15-1999.

2,534,648. NORTHEAST PHOENIX PARTNERS, SCOTTSDALE, AZ. SN 75-799,875. PUB. 12-12-2000, FILED 9-15-1999.

DESERT RIDGE

FOR PROVIDING A WIDE RANGE OF INFORMATION OF INTEREST TO RESIDENTS AND VISITORS OF A MASTER-PLANNED COMMUNITY RELATING TO COMMUNITY NEWS AND EVENTS, RECREATION AND LEISURE ACTIVITIES, EDUCATIONAL AND HEALTH FACILITIES, AND LOCAL MERCHANTS AND SERVICE PROVIDERS, BY ELECTRONIC AND NON-ELECTRONIC MEANS (U.S. CLS. 100 AND 101).
FIRST USE 8-0-1997; IN COMMERCE 8-0-1997.

2,534,654. NCR CORPORATION, DAYTON, OH. SN 75-803,160. PUB. 5-2-2000, FILED 9-20-1999.

NCR RELATIONSHIP TECHNOLOGIES

OWNER OF U.S. REG. NOS. 148,174, 750,700, AND OTHERS.

NO CLAIM IS MADE TO THE EXCLUSIVE RIGHT TO USE "RELATIONSHIP TECHNOLOGIES", APART FROM THE MARK AS SHOWN.

FOR COMPUTER SOFTWARE DESIGN FOR OTHERS FOR THE DEVELOPMENT AND IMPLEMENTATION OF NEW WAYS FOR CUSTOMERS TO CONDUCT BUSINESS THROUGH ELECTRONIC CHANNELS (U.S. CLS. 100 AND 101).
FIRST USE 7-10-1999; IN COMMERCE 7-10-1999.

CLASS 42—(Continued).

2,534,671. MAGELANG INSTITUTE, LTD., MENLO PARK, CA. SN 75-824,153. PUB. 6-20-2000, FILED 10-15-1999.



FOR PROVIDING A WEBSITE ON A GLOBAL COMPUTER NETWORK FEATURING INFORMATION AND LINKS TO OTHER WEBSITES, IN THE FIELD OF COMPUTER PROGRAMMING, SOFTWARE, AND TOPICS OF INTEREST TO COMPUTER SOFTWARE DEVELOPERS; PROVIDING TEMPORARY USE OF ONLINE NON-DOWNLOADABLE SOFTWARE FOR DEVELOPING OTHER SOFTWARE PROGRAMS (U.S. CLS. 100 AND 101).
FIRST USE 7-1-1999; IN COMMERCE 11-1-1999.

2,534,679. CARDIONOW, INC., SANTA MONICA, CA. SN 75-829,544. PUB. 4-17-2001, FILED 10-22-1999.

CARDIONOW

FOR PROVIDING AN ON-LINE COMPUTER DATABASE VIA A GLOBAL COMPUTER INFORMATION NETWORK IN THE FIELD OF MEDICAL, SCIENTIFIC, TECHNICAL AND CARDIOVASCULAR MEDICINE AND MEDICAL, TECHNICAL AND SCIENTIFIC RELATED TOPICS (U.S. CLS. 100 AND 101).
FIRST USE 10-12-2000; IN COMMERCE 10-12-2000.

2,534,687. THOMAS PUBLISHING COMPANY, NEW YORK, NY. SN 75-834,432. PUB. 1-23-2001, FILED 10-28-1999.

TR-XML

FOR PROVIDING TEMPORARY USE OF ON-LINE NON-DOWNLOADABLE SOFTWARE FOR SHARING DATA FROM AN INTERACTIVE DATABASE OF INDUSTRIAL PRODUCTS AND SERVICES VIA A MULTIPLE-USER GLOBAL COMPUTER NETWORK (U.S. CLS. 100 AND 101).
FIRST USE 9-0-2000; IN COMMERCE 9-0-2000.

CLASS 42—(Continued).

2,534,698. DOUGLASS, ANDREW IAN, BOSTON, MA. SN 75-841,737. PUB. 8-29-2000, FILED 11-5-1999.

**FROM-THE-IDEA-THRU-THE-
-IPO**

FOR LEGAL SERVICES, NAMELY, CONSULTATION AND REPRESENTATION ON ORGANIZING, FINANCING AND DEVELOPING SYSTEMS AND HUMAN RESOURCES FOR DEVSING AND IMPLEMENTING BUSINESS AND MARKETING PLANS FOR START-UP AND EARLY-STAGE BUSINESS ENTERPRISES (U.S. CLS. 100 AND 101).

FIRST USE 8-31-2001; IN COMMERCE 8-31-2001.

CLASS 42—(Continued).

2,534,748. TREEBOX INC., NEW YORK, NY. SN 75-900,421. PUB. 6-27-2000, FILED 1-19-2000.

TREEBOX

FOR GRAPHIC DESIGN SERVICES FOR OTHERS, NAMELY, DESIGN, DEVELOPMENT, PRODUCTION AND PROGRAMMING OF INTERACTIVE, DIGITAL AND ELECTRONIC MULTIMEDIA AND COMPUTER SITES, PROVIDING CONSULTING RELATED THERETO, AND PROVIDING INFORMATION THEREON VIA A GLOBAL COMPUTER NETWORK (U.S. CLS. 100 AND 101).

FIRST USE 1-1-2000; IN COMMERCE 1-5-2000.

2,534,702. CLIGNOSIS, INC., BOSTON, MA. SN 75-845,391. PUB. 8-1-2000, FILED 12-1-1999.

DATAPHORE

FOR DESIGN OF COMPUTER SOFTWARE FOR OTHERS IN CLINICAL DATABASE APPLICANTS (U.S. CLS. 100 AND 101).

FIRST USE 10-1-1998; IN COMMERCE 3-1-1999.

2,534,751. HELPHORIZONS.COM, INC., BOSTON, MA. SN 75-904,277. PUB. 1-23-2001, FILED 1-27-2000.

HelpHorizons.com

FOR PROVIDING MENTAL HEALTH INFORMATION AND ADVICE FOR PROFESSIONALS AND CONSUMERS, NAMELY, COUNSELING, THERAPY AND SUPPORT VIA WEB SITES ON THE GLOBAL COMPUTER NETWORK (U.S. CLS. 100 AND 101).

FIRST USE 3-1-2000; IN COMMERCE 3-1-2000.

2,534,705. CIGNA CORPORATION, PHILADELPHIA, PA. SN 75-848,276. PUB. 8-22-2000, FILED 11-13-1999.

PASSPORTEAP

NO CLAIM IS MADE TO THE EXCLUSIVE RIGHT TO USE "EAP", APART FROM THE MARK AS SHOWN.

FOR EMPLOYEE ASSISTANCE PROGRAM, NAMELY, MENTAL HEALTH AND SUBSTANCE ABUSE COUNSELING AND SUPPORT SERVICES (U.S. CLS. 100 AND 101).

FIRST USE 4-2-2001; IN COMMERCE 4-2-2001.

2,534,755. CADCAM-E.COM, INC., FARMINGTON HILLS, MI. SN 75-909,880. PUB. 12-26-2000, FILED 2-4-2000.

CADCAM-E.COM

FOR GLOBAL COMPUTER NETWORK SERVICES PROVIDING CAD, CAM AND CAE INTEROPERABILITY SOFTWARE APPLICATION SERVICES ON AN AUTOMATED REAL-TIME TRANSACTION BASIS (U.S. CLS. 100 AND 101).

FIRST USE 6-19-2000; IN COMMERCE 6-19-2000.

2,534,732. CPL CARBON LINK CORPORATION, COLUMBUS, OH. SN 75-879,123. PUB. 5-22-2001, FILED 12-23-1999.



FOR DESIGN SERVICES FOR OTHERS IN THE FIELD OF VAPOR PHASE AND LIQUID PHASE FILTRATION TREATMENT AND PURIFICATION EQUIPMENT AND SYSTEMS (U.S. CLS. 100 AND 101).

FIRST USE 11-0-1999; IN COMMERCE 11-0-1999.

2,534,758. EDGE 21, INC., NEW YORK, NY. SN 75-911,406. PUB. 9-19-2000, FILED 2-7-2000.

EDGE 21

FOR PRINTING AND REPRODUCTION OF INVESTMENT REPORTS TO FINANCIAL ANALYSTS, BROKERS AND INVESTORS (U.S. CLS. 100 AND 101).

FIRST USE 2-12-2000; IN COMMERCE 2-12-2000.

CLASS 42—(Continued).

2,534,759. KANBAY INCORPORATED, ROSEMONT, IL. SN 75-912,495. PUB. 1-16-2001, FILED 2-4-2000.

ENABLING BUSINESS TO EXCEL

FOR COMPUTER AND INFORMATION SYSTEMS CONSULTING AND PROGRAMMING FOR OTHERS (U.S. CLS. 100 AND 101).
FIRST USE 3-0-2000; IN COMMERCE 3-0-2000.

2,534,768. SEARCH CACTUS, L.L.C., TROY, MI. SN 75-921,007. PUB. 3-20-2001, FILED 2-17-2000.



NO CLAIM IS MADE TO THE EXCLUSIVE RIGHT TO USE "SEARCH", APART FROM THE MARK AS SHOWN.
FOR COMPUTER SERVICES, NAMELY, PROVIDING AN ONLINE GUIDE TO INFORMATION ON TOPICS OF GENERAL INTEREST VIA A GLOBAL INFORMATION NETWORK (U.S. CLS. 100 AND 101).
FIRST USE 4-0-2000; IN COMMERCE 4-0-2000.

2,534,803. ABP HOLDINGS, INC., BOSTON, MA. SN 75-981,117. PUB. 11-2-1999, FILED 6-30-1998.

AUBONPAIN.COM

OWNER OF U.S. REG. NOS. 1,134,895, 2,203,593, AND OTHERS.
THE ENGLISH TRANSLATION OF "AU BON PAIN" IS "AT OR TO THE GOOD BREAD".
FOR CATERING SERVICES OFFERED VIA A GLOBAL COMPUTER INFORMATION NETWORK (U.S. CLS. 100 AND 101).
FIRST USE 3-16-2001; IN COMMERCE 3-16-2001.

2,534,822. SERVICO, INC., ALBANY, NY. SN 76-008,000. PUB. 11-28-2000, FILED 3-23-2000.

SERVICO.COM

OWNER OF U.S. REG. NO. 1,853,898.
FOR LEGAL RESEARCH SERVICES FOR ATTORNEYS AND BUSINESSES, NAMELY, DOCUMENT RESEARCH AND RETRIEVAL; PREPARATION AND FILING OF LEGAL DOCUMENTS RELATING TO INCORPORATION, QUALIFICATION, STATUTORY REPRESENTATION OF CORPORATIONS AND COURT PROCEEDING; PROCESS SERVING; AND INTELLECTUAL PROPERTY SEARCHING, RESEARCH AND FILING (U.S. CLS. 100 AND 101).
FIRST USE 4-1-2000; IN COMMERCE 4-1-2000.

CLASS 42—(Continued).

2,534,849. INTERTEK TESTING SERVICES NA INC., LOMBARD, IL. SN 76-028,982. PUB. 3-27-2001, FILED 4-19-2000.



FOR CONSULTING AND TESTING SERVICES FOR CONSUMER PRODUCT SAFETY (U.S. CLS. 100 AND 101).
FIRST USE 7-1-2000; IN COMMERCE 7-1-2000.

2,534,882. INVETECH OPERATIONS PTY LTD, MOUNT WAVERLEY VIC 3149, AUSTRALIA. SN 76-053,912. PUB. 4-10-2001, FILED 5-22-2000.



FOR DESIGN SERVICES RELATING TO THE DEVELOPMENT OF BIOMEDICAL AND SCIENTIFIC INSTRUMENTATION, PRODUCT DEVELOPMENT AND INDUSTRIAL DESIGN RELATED SERVICES AND DESIGN SERVICES RELATING TO FACTORY AUTOMATION (U.S. CLS. 100 AND 101).
FIRST USE 0-0-1987; IN COMMERCE 7-0-2000.

2,534,898. SECOND HARVEST FOOD BANK OF WISCONSIN, INC., MILWAUKEE, WI. SN 76-072,330. PUB. 3-27-2001, FILED 6-16-2000.



FOR CHARITABLE SERVICES, NAMELY, COLLECTION AND DISTRIBUTION OF SURPLUS PRODUCE TO THE NEEDY (U.S. CLS. 100 AND 101).
FIRST USE 5-0-2000; IN COMMERCE 5-0-2000.

CLASS 42—(Continued).

2,534,929. ENEUTRAL, INC., ATLANTA, GA. SN 76-112,740. PUB. 5-8-2001, FILED 8-18-2000.

ENEUTRAL

FOR ALTERNATIVE DISPUTE RESOLUTION SERVICES, NAMELY PROVIDING ONLINE DISPUTE RESOLUTION SERVICES TO CUSTOMERS IN THE BUSINESS, PERSONAL, LEGAL, INSURANCE AND RISK MANAGEMENT MARKETS (U.S. CLS. 100 AND 101).

FIRST USE 1-0-1999; IN COMMERCE 7-1-2001.

2,534,946. LOTTO DESIGN GROUP, THE, WESTLAKE VILLAGES, CA. SN 78-002,686. PUB. 4-24-2001, FILED 4-5-2000.

INTERIART

FOR CUSTOM DESIGN OF FURNITURE FOR OTHERS (U.S. CLS. 100 AND 101).

FIRST USE 1-1-2001; IN COMMERCE 1-1-2001.

2,534,959. CORRIGO, INC., REDWOOD CITY, CA. SN 78-010,955. PUB. 5-1-2001, FILED 6-2-2000.

CORRIGO

FOR COMPUTER CONSULTING SERVICES IN THE AREA OF MOBILE ENTERPRISE APPLICATION SOLUTIONS; COMPUTER SOFTWARE DESIGN FOR OTHERS (U.S. CLS. 100 AND 101).

FIRST USE 2-1-1999; IN COMMERCE 2-1-1999.

CLASS 42—(Continued).

2,534,960. BAROODY, MICHAEL ELIAS, MCLEAN, VA. SN 78-011,488. PUB. 5-15-2001, FILED 6-6-2000.

OPETUARY

FOR COMPUTER SERVICES, NAMELY, PROVIDING A WEB SITE ON A GLOBAL COMPUTER NETWORK FEATURING PET OBITUARIES AND PET MEMORIALS (U.S. CLS. 100 AND 101).

FIRST USE 1-1-2000; IN COMMERCE 6-30-2000.

2,534,970. DRUDGE, ROBERT, B, SALISBURY, MD. SN 78-015,444. PUB. 6-5-2001, FILED 7-5-2000.

REFDESK.COM

FOR PROVIDING ON-LINE LIBRARY REFERENCE MATERIALS FOR CHILDREN AND ADULTS (U.S. CLS. 100 AND 101).

FIRST USE 6-1-1995; IN COMMERCE 6-1-1995.

2,534,975. ANDERSON, GREG, EDGEWOOD, MD. SN 78-017,515. PUB. 5-29-2001, FILED 7-19-2000.

EVILGREG.COM

THE NAME IN THE MARK IDENTIFIES A LIVING INDIVIDUAL WHOSE CONSENT IS OF RECORD.

FOR COMPUTER CONSULTATION SERVICES, NAMELY, COMPUTER HARDWARE AND SOFTWARE CONSULTING, HEALTHCARE INFORMATION SYSTEMS CONSULTING, AND APPLICATION DEVELOPMENT RELATING TO BUSINESS WORKFLOWS AND DATA REPORTING (U.S. CLS. 100 AND 101).

FIRST USE 12-15-2000; IN COMMERCE 12-15-2000.

* * * * *

PRIOR UNITED STATES CLASSIFICATION

APPLICATION IN ONE CLASS

CERTIFICATION MARKS

2,534,600. NATIONAL SAFETY COUNCIL, ITASCA, IL. SN 75-743,629. PUB. 3-7-2000, FILED 7-6-1999.

CLASS A—GOODS

2,534,504. NATIONAL FEDERATION OF STATE HIGH SCHOOL ASSOCIATIONS, KANSAS CITY, MO. SN 75-622,385. PUB. 12-7-1999, FILED 1-15-1999.

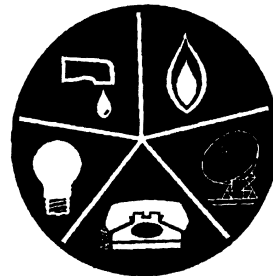

THE MARK CONSISTS OF A DARKENED RING DIVIDED INTO FIVE PIE-SHAPED SECTIONS, WITH ONE OF THE FOLLOWING DEPICTIONS CONTAINED IN EACH - A LIGHT BULB, A FAUCET WITH A SINGLE DRIP, A FLAME, A SATELLITE DISH AND A TELEPHONE.

THE CERTIFICATION MARK, AS USED BY PERSONS AUTHORIZED BY CERTIFIER, INDICATES THAT A CERTIFIED PARTY MEETS THE STANDARDS ESTABLISHED BY THE CERTIFIER FOR QUALIFIED UTILITY SAFETY PROFESSIONALS.

FOR INDICATING STATUS AS A CERTIFIED UTILITY SAFETY ADMINISTRATOR (U.S. CL. B). FIRST USE 7-1-1999; IN COMMERCE 7-1-1999.

OWNER OF U.S. REG. NOS. 2,186,025 AND 2,214,364. NO CLAIM IS MADE TO THE EXCLUSIVE RIGHT TO USE "RULE SPECIFICATIONS", APART FROM THE MARK AS SHOWN.

THE CERTIFICATION MARK IS INTENDED TO CERTIFY: THAT THE ATHLETIC EQUIPMENT MEETS RULES AND SPECIFICATIONS ESTABLISHED BY THE APPLICANT, ALSO KNOWN AS THE NFHS.

FOR ATHLETIC EQUIPMENT FOR USE IN HIGH SCHOOL ATHLETIC COMPETITION (U.S. CL. A). FIRST USE 11-0-1998; IN COMMERCE 11-0-1998.

2,534,636. BROKER'S INTERNATIONAL, LTD., PANORA, IA. SN 75-783,999. PUB. 11-28-2000, FILED 8-23-1999.



CERTIFICATION MARKS

CLASS B—SERVICES

THE CERTIFICATION MARK, AS INTENDED TO BE USED, IS INTENDED TO CERTIFY THAT PERSONS AUTHORIZED BY THE CERTIFIER HAVE COMPLETED EDUCATIONAL COURSE WORK REQUIREMENTS AND

WORK EXPERIENCE REQUIREMENTS OF THE CERTIFIER, HAVE SATISFACTORILY COMPLETED EXAMINATIONS ADMINISTERED BY THE CERTIFIER, HAVE AGREED TO ADHERE TO THE CERTIFIER'S STANDARDS FOR PROFESSIONAL RESPONSIBILITY, CONTINUING EDUCATION AND POST-CERTIFICATION REQUIREMENTS, AND WILL PROVIDE THE SERVICES IN ACCORDANCE WITH STANDARDS DEVELOPED BY THE CERTIFIER AND SUBJECT TO THE CERTIFIER'S APPROVAL.

FOR FINANCIAL PLANNING SERVICES, NAMELY ANNUITY INVESTMENT SERVICES (U.S. CL. B).
FIRST USE 10-1-1999; IN COMMERCE 10-1-1999.

* * * * *

SUPPLEMENTAL REGISTER

These registrations are not subject to opposition.

SECTION 1.— INTERNATIONAL CLASSIFICATION

The short titles associated below with the international class numbers are terms designed merely for quick identification and are not an official part of the international classification. The full names of international classes are given in section 6.1 of the trademark rules of practice.

The designation "U.S. Cl." appearing in this section refers to the U.S. class in effect prior to Sep. 1, 1973 rather than the international class which applies to applications filed on or after that date. For adoption of international classification see notice in the OFFICIAL GAZETTE of Jun. 26, 1973 (911 O.G. TM 210).

Application in more than one class

2,534,990. 3D LEARNER, INC., CORAL SPRINGS, FL. SN 75-449,573. FILED P.R. 3-13-1998; AM. S.R. 2-24-2000.

2,534,988. JACUZZI UK GROUP PLC, BRADFORD, WEST YORKSHIRE, UNITED KINGDOM, BY CHANGE OF NAME SPRING RAM HOLDINGS PLC, BRADFORD, WEST YORKSHIRE, UNITED KINGDOM. SN 75-393,152. FILED P.R. 11-19-1997; AM. S.R. 9-12-2001.

3D LEARNER

ROK

CLASS 11—ENVIRONMENTAL CONTROL APPARATUS

FOR SINKS, SINK UNITS AND WASH BASINS; PARTS AND FITTINGS THEREFOR (U.S. CLS. 13, 21, 23, 31 AND 34).
FIRST USE 4-1-1999; IN COMMERCE 4-1-1999.

CLASS 17—RUBBER GOODS

FOR NON-METALLIC MATERIALS COMPRISING AN ACRYLIC COMPOUND FOR USE IN THE MANUFACTURE OF SINKS, SINK UNITS AND WASH BASINS (U.S. CLS. 1, 5, 12, 13, 35 AND 50).
FIRST USE 4-1-1999; IN COMMERCE 4-1-1999.

CLASS 41—EDUCATION AND ENTERTAINMENT

FOR TEACHING PROGRAMS, NAMELY, ARRANGING AND CONDUCTING CLASSES, TRAINING PROGRAMS, SEMINARS AND WORKSHOPS IN THE FIELD OF MULTI-SENSORY LEARNING AND LEARNING ASSESSMENT, AND EDUCATIONAL CONSULTING RELATED THERETO; CORPORATE TRAINING PROGRAMS, NAMELY, ARRANGING AND CONDUCTING CLASSES, SEMINARS, WORKSHOPS IN THE FIELD OF MULTI-SENSORY LEARNING AND LEARNING ASSESSMENT; ARRANGING AND CONDUCTING TRAINING SEMINARS IN THE FIELD OF MULTI-SENSORY LEARNING AND LEARNING ASSESSMENT; ARRANGING AND CONDUCTING RECREATIONAL CAMPS; AND ARRANGING AND CONDUCTING ATHLETIC TRAINING CLASSES IN THE FIELD OF MULTI-SENSORY LEARNING AND LEARNING ASSESSMENT (U.S. CLS. 100, 101 AND 107).
FIRST USE 2-0-1998; IN COMMERCE 2-0-1998.

CLASS 42—SCIENTIFIC, COMPUTER AND LEGAL SERVICES

FOR MEDICAL TESTING AND EVALUATION SERVICES IN THE FIELD OF VISION IMPROVEMENT AND ASSESSMENT (U.S. CLS. 100 AND 101).
FIRST USE 2-0-1998; IN COMMERCE 2-24-2000.

2,534,991. DOCUMENT AUTHENTICATION SYSTEMS, INC., BALTIMORE, MD. SN 75-483,581. FILED P.R. 5-12-1998; AM. S.R. 9-1-2000.

ELECTRONIC ORIGINAL

CLASS 9—ELECTRICAL AND SCIENTIFIC APPARATUS

FOR COMPUTER SOFTWARE AND HARDWARE FOR THE ELECTRONIC TRANSMISSION, STORAGE AND RETRIEVAL OF AUTHENTICATED ELECTRONIC DOCUMENTS USING SOPHISTICATED CRYPTOGRAPHIC TECHNOLOGY AND PROVIDING ACCESS, VERSION AND DISTRIBUTION CONTROLS TOGETHER WITH A SECURE ELECTRONIC STORAGE FACILITY, ALL FOR USE IN THE CONTROL OF DOCUMENTATION OR OTHER INFORMATION OBJECTS IN MORTGAGE, LEASING, PHARMACEUTICAL AND OTHER BUSINESS APPLICATIONS (U.S. CLS. 21, 23, 26, 36 AND 38).

FIRST USE 5-0-1998; IN COMMERCE 5-0-1998.

CLASS 38—COMMUNICATION

FOR ELECTRONIC TRANSMISSION OF AUTHENTICATED ELECTRONIC DOCUMENTS USING SOPHISTICATED CRYPTOGRAPHIC TECHNOLOGY AND PROVIDING ACCESS, VERSION AND DISTRIBUTION CONTROLS, ALL FOR USE IN THE CONTROL OF DOCUMENTATION OR OTHER INFORMATION OBJECTS IN MORTGAGE, LEASING, PHARMACEUTICAL AND OTHER BUSINESS APPLICATIONS (U.S. CLS. 100, 101 AND 104).

FIRST USE 5-0-1998; IN COMMERCE 5-0-1998.

CLASS 39—TRANSPORTATION AND STORAGE

FOR ELECTRONIC STORAGE OF AUTHENTICATED ELECTRONIC DOCUMENTS USING SOPHISTICATED CRYPTOGRAPHIC TECHNOLOGY AND PROVIDING A SECURE ELECTRONIC STORAGE FACILITY, ALL FOR USE IN THE CONTROL OF DOCUMENTATION OR OTHER INFORMATION OBJECTS IN MORTGAGE, LEASING, PHARMACEUTICAL AND OTHER BUSINESS APPLICATIONS (U.S. CLS. 100 AND 105).

FIRST USE 5-0-1998; IN COMMERCE 5-0-1998.

2,534,996. BLAKE, JEANNE, GLOUCESTER, MA. SN 75-555,318. FILED P.R. 6-16-1999; AM. S.R. 7-30-2001.

RAISING HEALTHY KIDS

CLASS 9—ELECTRICAL AND SCIENTIFIC APPARATUS

FOR PRERECORDED EDUCATIONAL VIDEOTAPES FEATURING INFORMATION ABOUT HOW TO RAISE HEALTHY KIDS AND PREVENT ALCOHOL AND DRUG ABUSE (U.S. CLS. 21, 23, 26, 36 AND 38).

FIRST USE 6-1-1997; IN COMMERCE 6-1-1997.

CLASS 16—PAPER GOODS AND PRINTED MATTER

FOR PRINTED EDUCATIONAL, INSTRUCTIONAL AND TEACHING MATERIALS IN THE FIELD OF PARENTING SKILLS, NAMELY, INFORMATION ABOUT HOW TO RAISE HEALTHY KIDS AND PREVENT ALCOHOL AND DRUG ABUSE (U.S. CLS. 2, 5, 22, 23, 29, 37, 38 AND 50).

FIRST USE 6-1-1997; IN COMMERCE 6-1-1997.

2,534,998. KOMISAR TRAINING CONSULTANTS, NEW YORK, NY. SN 75-603,906. FILED P.R. 12-11-1998; AM. S.R. 5-7-2001.

KOMISAR TRAINING CONSULTANTS

CLASS 35—ADVERTISING AND BUSINESS

FOR BUSINESS CONSULTATION SERVICES IN THE FIELD OF HUMAN RESOURCES, CORPORATE TRAINING AND CORPORATE COMMUNICATIONS (U.S. CLS. 100, 101 AND 102).

FIRST USE 9-0-1998; IN COMMERCE 9-0-1998.

CLASS 41—EDUCATION AND ENTERTAINMENT

FOR EDUCATIONAL SERVICES, NAMELY, CONDUCTING CLASSES, SEMINARS AND WORKSHOPS IN THE FIELD OF STRESS MANAGEMENT, SELF-ESTEEM, CONFLICT RESOLUTION, NUTRITION, PARENTING AND TRAINING CHILDREN (U.S. CLS. 100, 101 AND 107).

FIRST USE 9-0-1998; IN COMMERCE 9-0-1998.

2,535,019. GOVERNMENT TECHNOLOGY SERVICES, INC., CHANTILLY, VA. SN 75-804,113. FILED P.R. 9-16-1999; AM. S.R. 7-30-2001.

GOVERNMENTIT.COM

CLASS 41—EDUCATION AND ENTERTAINMENT

FOR PROVIDING AN ON LINE COMPUTER LINK TO NEWS, WEATHER, SPORT AND CURRENT EVENTS AND REFERENCE MATERIALS IN A WIDE VARIETY OF FIELD (U.S. CLS. 100, 101 AND 107).

FIRST USE 5-3-1999; IN COMMERCE 5-3-1999.

CLASS 42—SCIENTIFIC, COMPUTER AND LEGAL SERVICES

FOR COMPUTER SERVICES, NAMELY, PROVIDING ACCESS TO DIRECTORY OF INFORMATION RESOURCES, IN A WIDE VARIETY OF FIELDS ON A GLOBAL COMPUTER NETWORK; CREATING INDEXES OF INFORMATION FOR OTHERS ON A GLOBAL COMPUTER NETWORK; PROVIDING ONLINE DATABASES FOR THE SEARCHING AND RETRIEVAL OF INFORMATION SITES ON COMPUTER NETWORKS (U.S. CLS. 100 AND 101).

FIRST USE 5-3-1999; IN COMMERCE 5-3-1999.

2,535,020. CASSON, FREDERICK B., BOSTON, MA. SN 75-819,042. FILED P.R. 10-8-1999; AM. S.R. 8-22-2001.



THE MARK IS LINED FOR THE COLORS YELLOW AND RED.

THE MARK CONSISTS OF THREE STACKED COLORED RECTANGULAR AREAS SURROUNDED BY A BLACK BORDER. THE TOP AREA CONSISTS OF A YELLOW BACKGROUND WITH BLOCK LETTERING STATE LAW IN BLACK. THE MIDDLE AREA CONSISTS OF A RED BACKGROUND WITH BLOCK LETTERING YIELD IN A LIGHT CONTRASTING COLOR. THE BOTTOM AREA CONSISTS OF A LIGHT CONTRASTING COLOR BACKGROUND WITH BLOCK LETTERING PEDESTRIANS IN XWALK IN BLACK.

CLASS 18—LEATHER GOODS

FOR CARRYING BAGS, NAMELY, TOTE BAGS, SHOPPING BAGS, HANDBAGS, PURSES, BACKPACKS, FANNY PACKS, SHOULDER BAGS, SPORT BAGS, SCHOOL BAGS, BOOK BAGS, LUGGAGE AND BRIEF-CASES (U.S. CLS. 1, 2, 3, 22 AND 41).

FIRST USE 10-1-1999; IN COMMERCE 10-6-1999.

CLASS 25—CLOTHING

FOR NOVELTY CLOTHING, NAMELY, SWEATSHIRTS, T-SHIRTS, UNDERWEAR, SWEATERS, JUMPERS, VESTS, JACKETS, COATS, SHIRTS, JERSEYS, TOPS, CAPS AND HATS (U.S. CLS. 22 AND 39).

FIRST USE 10-1-1999; IN COMMERCE 10-6-1999.

2,535,033. I-DNS.NET INTERNATIONAL, INC., MENLO PARK, CA. SN 75-862,449. FILED P.R. 12-2-1999; AM. S.R. 7-27-2001.

I-DNS

CLASS 9—ELECTRICAL AND SCIENTIFIC APPARATUS

FOR DOMAIN NAME SERVER SOFTWARE FOR OPERATING DOMAIN NAME SERVERS; MULTI-LINGUAL E-MAIL SOFTWARE; DOMAIN NAME RESOLUTION SOFTWARE FOR RESOLVING DOMAIN NAMES; DOMAIN NAME CONVERSION SOFTWARE FOR CONVERTING DOMAIN NAMES BETWEEN DISTINCT DOMAIN NAME SYSTEMS (U.S. CLS. 21, 23, 26, 36 AND 38).

FIRST USE 2-16-2000; IN COMMERCE 2-16-2000.

CLASS 42—SCIENTIFIC, COMPUTER AND LEGAL SERVICES

FOR PROVIDING AND MAINTAINING A REGISTRY OF DOMAIN NAMES FOR OTHERS; PROVIDING AND MAINTAINING DOMAIN NAME SERVERS FOR OTHERS; PROVIDING AND MAINTAINING DOMAIN NAME RESOLVER SOFTWARE FOR OTHERS; DOMAIN NAME RESOLUTION SERVICES IN THE NATURE OF DETERMINING IP ADDRESSES CORRESPONDING TO SPECIFIED DOMAIN NAMES FOR OTHERS (U.S. CLS. 100 AND 101).

FIRST USE 12-1-1999; IN COMMERCE 1-13-2000.

2,535,034. I-DNS.NET INTERNATIONAL, INC., MENLO PARK, CA. SN 75-862,991. FILED P.R. 12-2-1999; AM. S.R. 7-27-2001.

I-DNS.NET

CLASS 9—ELECTRICAL AND SCIENTIFIC APPARATUS

FOR DOMAIN NAME SERVER SOFTWARE FOR OPERATING DOMAIN NAME SERVERS; MULTI-LINGUAL E-MAIL SOFTWARE; DOMAIN NAME RESOLUTION SOFTWARE FOR RESOLVING DOMAIN NAMES; DOMAIN NAME CONVERSION SOFTWARE FOR CONVERTING DOMAIN NAMES BETWEEN DISTINCT DOMAIN NAME SYSTEMS (U.S. CLS. 21, 23, 26, 36 AND 38).

FIRST USE 2-16-2000; IN COMMERCE 2-16-2000.

CLASS 42—SCIENTIFIC, COMPUTER AND LEGAL SERVICES

FOR PROVIDING AND MAINTAINING A REGISTRY OF DOMAIN NAMES FOR OTHERS; PROVIDING AND MAINTAINING DOMAIN NAME SERVERS FOR OTHERS; PROVIDING AND MAINTAINING DOMAIN NAME RESOLVER SOFTWARE FOR OTHERS; DOMAIN NAME RESOLUTION SERVICES IN THE NATURE OF DETERMINING IP ADDRESSES CORRESPONDING TO SPECIFIED DOMAIN NAMES FOR OTHER (U.S. CLS. 100 AND 101).

FIRST USE 12-1-1999; IN COMMERCE 1-13-2000.

2,535,036. TUCKER INTERNATIONAL, BOULDER, CO. SN 75-868,712. FILED P.R. 12-10-1999; AM. S.R. 6-7-2001.

EXPATRIATE EVALUATION AND DEVELOPMENT GUIDE

CLASS 16—PAPER GOODS AND PRINTED MATTER

FOR PRINTED INSTRUCTIONAL AND TEACHING MATERIALS FOR EMPLOYEES ON OVERSEAS ASSIGNMENTS THAT COMBINE EMPLOYEE AND SUPERVISORY RESPONSES TO A STATISTICAL SURVEY WITH SUGGESTIONS FOR EMPLOYEE IMPROVEMENT IN AREAS OF LEADERSHIP AND INTERCULTURAL AWARENESS (U.S. CLS. 2, 5, 22, 23, 29, 37, 38 AND 50).

FIRST USE 7-19-1999; IN COMMERCE 7-19-1999.

CLASS 35—ADVERTISING AND BUSINESS

2,535,044. MEDPANEL, INC., CAMBRIDGE, MA. SN 75-906,625. FILED P.R. 2-1-2000; AM. S.R. 7-11-2001.

FOR BUSINESS CONSULTATION FOR EMPLOYEES ON OVERSEAS ASSIGNMENTS, NAMELY, ANALYZING EMPLOYEE AND SUPERVISORY RESPONSES TO A STATISTICAL SURVEY AND SUGGESTING EMPLOYEE IMPROVEMENT IN AREAS OF LEADERSHIP AND INTERCULTURAL AWARENESS (U.S. CLS. 100, 101 AND 102).

FIRST USE 7-19-1999; IN COMMERCE 7-19-1999.

MEDPANEL**CLASS 38—COMMUNICATION**

FOR PROVIDING AN ASYNCHRONOUS THREADED DISCUSSION VIA A GLOBAL COMPUTER NETWORK FOR THE TRANSMISSION OF MESSAGES AMONG COMPUTER USERS CONCERNING MEDICAL INFORMATION, NAMELY PROVIDING AND ONLINE FORUM ALLOWING COMPANIES, EDUCATIONAL INSTITUTIONS, AND GOVERNMENTAL BODIES TO PARTICIPATE IN A THREADED DISCUSSION IN THE FIELD OF MEDICINE (U.S. CLS. 100, 101 AND 104).

FIRST USE 10-1-1999; IN COMMERCE 10-1-1999.

CLASS 42—SCIENTIFIC, COMPUTER AND LEGAL SERVICES

FOR PROVIDING MEDICAL INFORMATION, NAMELY, PROVIDING THE OPINIONS OF PHYSICIANS TO COMPANIES, EDUCATIONAL INSTITUTIONS, AND GOVERNMENTAL BODIES VIA A GLOBAL COMPUTER NETWORK (U.S. CLS. 100 AND 101).

FIRST USE 10-1-1999; IN COMMERCE 10-1-1999.

2,535,039. TURNER COMMUNICATIONS CORP., MIAMI, FL. SN 75-882,084. FILED P.R. 12-28-1999; AM. S.R. 9-7-2001.

ROMANCE & TRAVEL**CLASS 16—PAPER GOODS AND PRINTED MATTER**

FOR PRINTED TRAVEL MAGAZINES (U.S. CLS. 2, 5, 22, 23, 29, 37, 38 AND 50).

FIRST USE 9-6-2001; IN COMMERCE 9-6-2001.

CLASS 42—SCIENTIFIC, COMPUTER AND LEGAL SERVICES

FOR COMPUTER SERVICES, NAMELY, PROVIDING ONLINE MAGAZINES IN THE FIELD OF TRAVEL (U.S. CLS. 100 AND 101).

FIRST USE 8-27-2001; IN COMMERCE 8-27-2001.

2,535,057. ALFA METALCRAFT CORPORATION, STAMFORD, CT. SN 76-001,238. FILED P.R. 3-15-2000; AM. S.R. 5-1-2001.

HOME CULINARIAN**CLASS 21—HOUSEWARES AND GLASS**

FOR FULL LINE OF NON-ELECTRIC POTS AND PANS; KITCHEN UTENSILS, NAMELY, BASTING SPOONS, SLOTTED SPOONS, SPATULAS, TURNERS, MIXING SPOONS, WHISKS, GRATERS, CUTTING BOARDS MADE OF WOOD, AND SERVING TRAYS NOT OF PRECIOUS METAL (U.S. CLS. 2, 13, 23, 29, 30, 33, 40 AND 50).

FIRST USE 11-30-2000; IN COMMERCE 11-30-2000.

2,535,042. TALENT ENTERTAINMENT GROUP, LLC, BEVERLY HILLS, CA. SN 75-893,920. FILED P.R. 1-11-2000; AM. S.R. 12-18-2000.

TALENT ENTERTAINMENT GROUP

NO CLAIM IS MADE TO THE EXCLUSIVE RIGHT TO USE "ENTERTAINMENT GROUP", APART FROM THE MARK AS SHOWN.

CLASS 35—ADVERTISING AND BUSINESS

FOR MANAGEMENT OF ACTORS, WRITERS, DIRECTORS, AND THE ENTERTAINMENT PERSONNEL (U.S. CLS. 100, 101 AND 102).

FIRST USE 2-2-2000; IN COMMERCE 2-2-2000.

CLASS 35—ADVERTISING AND BUSINESS

FOR SHOP-AT-HOME PARTIES FEATURING COOKWARE (U.S. CLS. 100, 101 AND 102).

FIRST USE 11-30-2000; IN COMMERCE 11-30-2000.

CLASS 41—EDUCATION AND ENTERTAINMENT

FOR ENTERTAINMENT SERVICES, NAMELY, PRODUCTION OF TELEVISION PROGRAMS (U.S. CLS. 100, 101 AND 107).

FIRST USE 4-11-2000; IN COMMERCE 4-11-2000.

CLASS 41—EDUCATION AND ENTERTAINMENT

FOR EDUCATIONAL SERVICES IN THE FORM OF LIVE PRESENTATIONS AND DEMONSTRATIONS ILLUSTRATING FOOD PREPARATION TECHNIQUES AND THE USE OF EQUIPMENT THEREFOR (U.S. CLS. 100, 101 AND 107).

FIRST USE 11-30-2000; IN COMMERCE 11-30-2000.

2,535,084. VIRTUAL EDGE U.S., L.L.C., YARDLEY, PA. SN 76-111,728. FILED P.R. 8-17-2000; AM. S.R. 8-16-2001.

2,535,089. MELALEUCA, INC., IDAHO FALLS, ID. SN 76-126,407. FILED P.R. 9-13-2000; AM. S.R. 10-5-2001.

E*FAIR

SUN VALLEY

CLASS 35—ADVERTISING AND BUSINESS

FOR PROVIDING BUSINESS INFORMATION CONCERNING PERSONNEL PLACEMENT AND RECRUITMENT VIA A GLOBAL COMPUTER NETWORK; DISSEMINATION OF ADVERTISING FOR OTHERS; PERSONNEL PLACEMENT AND RECRUITMENT; COMPUTERIZED DATABASE MANAGEMENT (U.S. CLS. 100, 101 AND 102).

FIRST USE 6-0-1998; IN COMMERCE 6-0-1998.

CLASS 38—COMMUNICATION

FOR ELECTRONIC TRANSMISSION OF MESSAGES AND DATA IN THE FIELD OF PERSONNEL PLACEMENT AND RECRUITMENT; PROVIDING ON-LINE ELECTRONIC BULLETIN BOARDS FOR TRANSMISSION OF MESSAGES AMONG COMPUTER USERS IN THE FIELD OF PERSONNEL PLACEMENT AND RECRUITMENT (U.S. CLS. 100, 101 AND 104).

FIRST USE 6-0-1998; IN COMMERCE 6-0-1998.

CLASS 39—TRANSPORTATION AND STORAGE

FOR ELECTRONIC STORAGE OF RESUMES AND EMPLOYMENT INFORMATION (U.S. CLS. 100 AND 105).

FIRST USE 6-0-1998; IN COMMERCE 6-0-1998.

CLASS 42—SCIENTIFIC, COMPUTER AND LEGAL SERVICES

FOR COMPUTER SERVICES, NAMELY, PROVIDING SEARCH ENGINES FOR OBTAINING DATA IN THE FIELD OF PERSONNEL PLACEMENT AND RECRUITMENT ON A GLOBAL COMPUTER NETWORK (U.S. CLS. 100 AND 101).

FIRST USE 6-0-1998; IN COMMERCE 6-0-1998.

CLASS 3—COSMETICS AND CLEANING PREPARATIONS

FOR FRAGRANCES, NAMELY, ROOM FRAGRANCES AND PERFUMES (U.S. CLS. 1, 4, 6, 50, 51 AND 52).

FIRST USE 8-5-1999; IN COMMERCE 8-5-1999.

CLASS 4—LUBRICANTS AND FUELS

FOR CANDLES (U.S. CLS. 1, 6 AND 15).

FIRST USE 8-5-1999; IN COMMERCE 8-5-1999.

2,535,100. MORAMARCO, GREGG, WESTBURY, NY. SN 140,186. FILED P.R. 10-4-2000; AM. S.R. 8-30-2001.

BIKINI & FITNESS

CLASS 16—PAPER GOODS AND PRINTED MATTER

FOR PRINTED MATERIAL, NAMELY, MAGAZINES, POSTERS, CALENDARS, POST CARDS, EVENT CARDS, BROCHURES, AND NEWS LETTERS, ALL FEATURING ITEMS OF INTERESTS TO WOMEN (U.S. CLS. 2, 5, 22, 23, 29, 37, 38 AND 50).

FIRST USE 8-1-1998; IN COMMERCE 8-1-1998.

CLASS 25—CLOTHING

FOR APPAREL, NAMELY, T-SHIRTS, HATS, SWEAT-PANTS, SWEATSHIRTS, SHORTS, JACKETS, WORKOUT CLOTHING, SWIMWEAR (U.S. CLS. 22 AND 39).

FIRST USE 8-1-1998; IN COMMERCE 8-1-1998.

* * * * *

SECTION 2.— INTERNATIONAL CLASSIFICATION

The short titles associated below with the international class numbers are terms designed merely for quick identification and are not an official part of the international classification. The full names of international classes are given in section 6.1 of the trademark rules of practice.

The designation "U.S. Cl." appearing in this section refers to the U.S. class in effect prior to Sep. 1, 1973 rather than the international class which applies to applications filed on or after that date. For adoption of international classification see notice in the OFFICIAL GAZETTE of Jun. 26, 1973 (911 O.G. TM 210).

Application in one class

CLASS 3—COSMETICS AND CLEANING PREPARATIONS

2,535,064. PURE OXYGEN, L.L.C., ABITA SPRINGS, LA. SN 76-046,357. FILED P.R. 5-10-2000; AM. S.R. 7-23-2001.

OXYGEN MIST

NO CLAIM IS MADE TO THE EXCLUSIVE RIGHT TO USE "OXYGEN", APART FROM THE MARK AS SHOWN. FOR COSMETICS, NAMELY, A HYDRATING FACIAL MIST (U.S. CLS. 1, 4, 6, 50, 51 AND 52). FIRST USE 9-30-2000; IN COMMERCE 9-30-2000.

CLASS 5—PHARMACEUTICALS

2,535,003. NUTRITION FOR LIFE INTERNATIONAL, INC., HOUSTON, TX. SN 75-678,668. FILED P.R. 4-7-1999; AM. S.R. 3-8-2001.

KHOLESTEROL BLOCKER

NO CLAIM IS MADE TO THE EXCLUSIVE RIGHT TO USE "KHOLESTEROL", APART FROM THE MARK AS SHOWN. FOR DIETARY SUPPLEMENTS (U.S. CLS. 6, 18, 44, 46, 51 AND 52). FIRST USE 6-11-1999; IN COMMERCE 6-11-1999.

2,535,050. KREMER, REINER G., FRANKTOWN, CO. SN 75-929,284. FILED P.R. 2-28-2000; AM. S.R. 12-27-2000.

ENATURALMEDICINE.COM

FOR VITAMINS; MINERAL SUPPLEMENTS; NUTRITIONAL SUPPLEMENTS; NAMELY, BOTANICALS, HOMEOPATHIC PHARMACEUTICALS FOR USE IN THE TREATMENT OF DISEASE; BOTANICALS FOR MEDICINAL USE; HERB TEAS FOR MEDICINAL PURPOSES (U.S. CLS. 6, 18, 44, 46, 51 AND 52). FIRST USE 4-4-2000; IN COMMERCE 4-4-2000.

CLASS 5—(Continued).

2,535,053. AMERICAN HOME PRODUCTS CORPORATION, MADISON, NJ. SN 75-932,594. FILED P.R. 3-1-2000; AM. S.R. 6-15-2001.



NO CLAIM IS MADE TO THE EXCLUSIVE RIGHT TO USE "BRAND", APART FROM THE MARK AS SHOWN. FOR PHARMACEUTICALS NAMELY, COUGH, COLD, HEADACHE, FLU AND FEVER PREPARATIONS (U.S. CLS. 6, 18, 44, 46, 51 AND 52). FIRST USE 11-30-2000; IN COMMERCE 11-30-2000.

2,535,111. AMERICAN BIO MEDICA, KINDERHOOK, NY. SN 76-177,897. FILED P.R. 12-8-2000; AM. S.R. 5-3-2001.

RAPID DRUG SCREEN

RAPID ONE
SINGLE DIP STICK

NO CLAIM IS MADE TO THE EXCLUSIVE RIGHT TO USE "DRUG SCREEN" AND "SINGLE DIP STICK", APART FROM THE MARK AS SHOWN. FOR TEST CARD FOR DETECTING DRUGS OF ABUSE (U.S. CLS. 6, 18, 44, 46, 51 AND 52). FIRST USE 7-15-1998; IN COMMERCE 7-15-1998.

CLASS 6—METAL GOODS

2,535,076. SOUTHWEST SPECIALTY PRODUCTS, LLC, PHOENIX, AZ. SN 76-076,335. FILED P.R. 6-23-2000; AM. S.R. 7-3-2001.



NO CLAIM IS MADE TO THE EXCLUSIVE RIGHT TO USE "SAFES", APART FROM THE MARK AS SHOWN. FOR PERSONAL METAL SAFES (U.S. CLS. 2, 12, 13, 14, 23, 25 AND 50). FIRST USE 5-8-1988; IN COMMERCE 5-8-1988.

2,535,129. AIRSEPT, INC., MARIETTA, GA. SN 78-032,236. FILED P.R. 10-25-2000; AM. S.R. 7-16-2001.

A/C COMPRESSOR GUARD

FOR METAL HARDWARE, NAMELY IN-LINE MESH FILTERS, FOR INSTALLATION IN AUTOMOTIVE AIR CONDITIONING SYSTEMS (U.S. CLS. 2, 12, 13, 14, 23, 25 AND 50). FIRST USE 7-0-2000; IN COMMERCE 7-0-2000.

CLASS 7—MACHINERY

2,535,024. SHURFLO PUMP MANUFACTURING COMPANY, SANTA ANA, CA. SN 75-829,841. FILED P.R. 10-22-1999; AM. S.R. 6-4-2001.

POWER TWIN

FOR DOUBLE HEADED PUMPS, NAMELY, DOUBLE HEADED PUMPS FOR PUMPING AND PROPORTIONING FLUIDS FOR INDUSTRIAL USE (U.S. CLS. 13, 19, 21, 23, 31, 34 AND 35). FIRST USE 12-12-1999; IN COMMERCE 12-12-1999.

CLASS 9—ELECTRICAL AND SCIENTIFIC APPARATUS

CLASS 9—(Continued).

2,535,011. INTERACTIVE INTELLIGENCE, INC., INDIANAPOLIS, IN. SN 75-737,158. FILED P.R. 6-25-1999; AM. S.R. 7-6-2001.

E-FAQ

FOR COMPUTER SOFTWARE USING ARTIFICIAL INTELLIGENCE FOR USE IN MANAGING HELP-DESK FUNCTIONS, NAMELY, FOR USE IN MAINTAINING HELP DESK LOGS, FOR USE IN PROCESSING AND TRACKING THIRD PARTY E-MAIL INQUIRIES, FOR USE IN COMPARING THE THIRD PARTY E-MAIL INQUIRIES WITH A SET OF PREVIOUSLY SUBMITTED QUESTIONS AND RESPONSES THERETO, AND FOR PROVIDING A LIST OF PROPOSED RESPONSES TO THE THIRD PARTY, AND FOR INSTRUCTION MANUALS SOLD THEREFOR AS A UNIT (U.S. CLS. 21, 23, 26, 36 AND 38). FIRST USE 11-0-1999; IN COMMERCE 11-0-1999.

2,535,013. QUINTESSENT COMMUNICATIONS, INC., REDMOND, WA. SN 75-771,298. FILED P.R. 8-9-1999; AM. S.R. 3-28-2001.

ASRXCHANGE

FOR COMPUTER GATEWAY SOFTWARE FOR INTERCONNECTING THE OPERATIONS SUPPORT SYSTEMS OF TELECOMMUNICATIONS CARRIERS (U.S. CLS. 21, 23, 26, 36 AND 38). FIRST USE 9-28-1999; IN COMMERCE 9-28-1999.

2,535,016. AUDIO NOTE UK LTD., EAST SUSSEX, ENGLAND. SN 75-776,223. FILED P.R. 8-6-1999; AM. S.R. 8-13-2001.

DIRECT FROM DISC

FOR AUDIO ELECTRONIC EQUIPMENT, NAMELY, DIGITAL-TO-ANALOG CONVERTERS (DAC), COMPACT DISC PLAYERS, OTHER AUDIO ELECTRONIC EQUIPMENT IN WHICH DIGITAL-TO-ANALOG CONVERSION IS PERFORMED, AND KITS FOR ASSEMBLING THE SAME (U.S. CLS. 21, 23, 26, 36 AND 38). FIRST USE 1-0-2001; IN COMMERCE 1-0-2001.

2,535,017. OPENGLOBE, INC., INDIANAPOLIS, IN, BY MERGER; BY ASSIGNMENT ESCIENT, INC., CARMEL, IN. SN 75-789,596. FILED P.R. 9-1-1999; AM. S.R. 6-6-2001.

CE-COMMERCE

FOR HARDWARE AND SOFTWARE COMPONENTS THAT FACILITATE DATA RECOGNITION AND CONTENT GENERATED OFFERS VIA A GLOBAL COMPUTER NETWORK (U.S. CLS. 21, 23, 26, 36 AND 38). FIRST USE 6-1-2001; IN COMMERCE 6-1-2001.

CLASS 9—(Continued).

2,535,022. NANODEVICES, SANTA BARBARA, CA. SN 75-829,123. FILED P.R. 10-30-1999; AM. S.R. 5-29-2001.

NANODEVICES

FOR PERIPHERAL EQUIPMENT FOR ATOMIC FORCE SCANNING PROBE MICROSCOPES, NAMELY, PIEZOELECTRICALLY ACTUATED, NANONEWTON-SCALE RULERS AND ATOMIC WEIGHT MEASURING DEVICES, AND COMPONENT PARTS THEREOF (U.S. CLS. 21, 23, 26, 36 AND 38).

FIRST USE 4-19-1999; IN COMMERCE 9-15-1999.

2,535,026. UNPLUGI, INC., NEW YORK, NY, BY ASSIGNMENT CADMUS JOURNAL SERVICES, INC., RICHMOND, VA. SN 75-832,915. FILED P.R. 10-27-1999; AM. S.R. 8-8-2001.

RAPID REVIEW

FOR COMPUTER SOFTWARE FOR THE MANAGEMENT OF THE SUBMISSION, SELECTION AND EDITING OF SCHOLARLY ARTICLES VIA A GLOBAL COMPUTER INFORMATION NETWORK, NAMELY SOFTWARE THAT ALLOWS FOR THE SUBMISSION OF SUCH ARTICLES, THE PARTICIPATION OF EXPERTS IN SCREENING FOR SELECTION AND EDITING OF SUCH ARTICLES, TASK ASSIGNMENT AND MANAGEMENT OF WORKFLOW, AND KEEPING RECORDS OF EVENTS IN THE SUBMISSION, SELECTION AND EDITING PROCESSES, ALL VIA A GLOBAL COMPUTER INFORMATION NETWORK (U.S. CLS. 21, 23, 26, 36 AND 38).

FIRST USE 7-14-2000; IN COMMERCE 7-14-2000.

2,535,027. FLASH VOS, INC., HOUSTON, TX. SN 75-836,191. FILED P.R. 10-29-1999; AM. S.R. 10-17-2000.

SUPER O/S

NO CLAIM IS MADE TO THE EXCLUSIVE RIGHT TO USE "O/S", APART FROM THE MARK AS SHOWN.

FOR COMPUTER SOFTWARE, NAMELY SOFTWARE THAT ENABLES THE VIRTUALIZATION, DYNAMIC MANIPULATION, AND PARTITIONING OF THE SECONDARY STORAGE OF A COMPUTER DEVICE; OPERATING SYSTEM MANAGEMENT SOFTWARE AND OPERATING SYSTEM MANIPULATION SOFTWARE (U.S. CLS. 21, 23, 26, 36 AND 38).

FIRST USE 1-15-2000; IN COMMERCE 1-15-2000.

2,535,029. 1GLOBALCITY.COM, INC., LARGO, FL. SN 75-846,535. FILED P.R. 11-12-1999; AM. S.R. 4-28-2000.

IBC

FOR CD-ROMS, ENCODED WITH MULTIMEDIA SOFTWARE, USED FOR PRESENTATION OF CORPORATE INFORMATION AND FOR MARKETING, AND FOR INTERCONNECTION WITH A GLOBAL COMPUTER NETWORK (U.S. CLS. 21, 23, 26, 36 AND 38).

FIRST USE 2-2-2000; IN COMMERCE 2-2-2000.

CLASS 9—(Continued).

2,535,030. WEINBERGER GROUP, L.L.C., THE, EAST BRUNSWICK, NJ. SN 75-854,057. FILED P.R. 11-19-1999; AM. S.R. 5-25-2001.

PAGESTAMP

FOR INKJET PRINTERS FOR ANNOTATION OF DOCUMENTS (U.S. CLS. 21, 23, 26, 36 AND 38).

FIRST USE 12-0-2000; IN COMMERCE 12-0-2000.

2,535,031. PHENOMENEX, INC., TORRANCE, CA. SN 75-854,450. FILED P.R. 11-22-1999; AM. S.R. 4-30-2001.

AQUA

FOR LIQUID CHROMATOGRAPHY COLUMNS (U.S. CLS. 21, 23, 26, 36 AND 38).

FIRST USE 3-31-1999; IN COMMERCE 3-31-1999.

2,535,048. INJURY SCIENCES LLC, SAN ANTONIO, TX. SN 75-914,681. FILED P.R. 2-9-2000; AM. S.R. 10-25-2000.

INJURY SCIENCES

FOR COMPUTER SOFTWARE FOR ANALYSIS OF AUTOMOBILE ACCIDENT IMPACT SEVERITY AND EVALUATION OF INJURY CLAIMS TO ESTABLISH IF AND HOW CLAIMED INJURIES WERE CAUSED IN THE SPECIFIC ACCIDENT EVENT AND CONTAINING SCIENTIFIC AND MEDICAL TREATISES AND VISUAL GRAPHICS RELATING TO HOW VARIOUS INJURIES ARE AND ARE NOT CAUSED (U.S. CLS. 21, 23, 26, 36 AND 38).

FIRST USE 10-9-1998; IN COMMERCE 10-9-1998.

2,535,097. KINETIC SPORTS INTERACTIVE, INC., BUFORD, GA. SN 76-138,663. FILED P.R. 10-2-2000; AM. S.R. 7-23-2001.

WORKOUT BUILDER

NO CLAIM IS MADE TO THE EXCLUSIVE RIGHT TO USE "WORKOUT", APART FROM THE MARK AS SHOWN.

FOR INTERACTIVE MULTIMEDIA COMPUTER PROGRAMS FOR ALLOWING AN INDIVIDUAL TO DEVELOP A PERSONAL PHYSICAL EXERCISE PROGRAM (U.S. CLS. 21, 23, 26, 36 AND 38).

FIRST USE 2-2-2000; IN COMMERCE 8-1-2000.

CLASS 10—MEDICAL APPARATUS

CLASS 10—(Continued).

2,535,088. LEVINSON MEDICAL CENTER FOR LEARNING DISABILITIES, INC., GREAT NECK, NY. SN 76-126,300. FILED P.R. 9-11-2000; AM. S.R. 6-25-2001.

3D AUDITORY SCANNER

NO CLAIM IS MADE TO THE EXCLUSIVE RIGHT TO USE "AUDITORY", APART FROM THE MARK AS SHOWN. FOR DIAGNOSTIC DEVICES, NAMELY, INSTRUMENTS FOR TREATMENT OF DYSMETRIC DYSLEXIA (U.S. CLS. 26, 39 AND 44).
FIRST USE 4-17-1991; IN COMMERCE 4-17-1991.

2,535,090. LEVINSON MEDICAL CENTER FOR LEARNING DISABILITIES, INC., GREAT NECK, NY. SN 76-126,683. FILED P.R. 9-11-2000; AM. S.R. 6-25-2001.

3D OPTICAL SCANNER

NO CLAIM IS MADE TO THE EXCLUSIVE RIGHT TO USE "OPTICAL", APART FROM THE MARK AS SHOWN. FOR DIAGNOSTIC DEVICES, NAMELY, INSTRUMENTS FOR TREATMENT OF DYSMETRIC DYSLEXIA (U.S. CLS. 26, 39 AND 44).
FIRST USE 4-17-2001; IN COMMERCE 4-17-2001.

CLASS 12—VEHICLES

2,535,055. BAJA MARINE CORPORATION, BUCYRUS, OH. SN 75-939,609. FILED P.R. 3-9-2000; AM. S.R. 3-15-2001.

WATER ADVENTURE VEHICLE

NO CLAIM IS MADE TO THE EXCLUSIVE RIGHT TO USE "VEHICLE", APART FROM THE MARK AS SHOWN. FOR PLEASURE BOATS (U.S. CLS. 19, 21, 23, 31, 35 AND 44).
FIRST USE 2-11-2000; IN COMMERCE 2-11-2000.

CLASS 12—(Continued).

2,535,062. V. MARIOTTI S.R.L., I-10095 GRUGLIASCO (TORINO), ITALY. SN 76-033,703. FILED P.R. 4-25-2000; AM. S.R. 6-18-2001.

V. MARIOTTI

PRIORITY CLAIMED UNDER SEC. 44(D) ON ITALY APPLICATION NO. TO99C004049, FILED 12-23-1999.
FOR FORKLIFT TRUCKS AND COMPONENTS, NAMELY, ENGINES FOR FORK LIFT TRUCKS, ELECTRIC MOTORS FOR FORK LIFT TRUCKS, TRANSMISSIONS FOR FORK LIFT TRUCKS, AXLE BEARING FOR FORK LIFT TRUCKS, BRAKE PADS FOR FORK LIFT TRUCKS, BRAKE CYLINDER REPAIR KIT FOR FORK LIFT TRUCKS, CONSISTING OF REPLACEMENT SPRINGS, SEALS AND PISTON AND CYLINDERS, CLUTCHES FOR FORK LIFT TRUCKS, TORQUE CONVERTERS FOR FORK LIFT TRUCKS, WHEELS FOR FORK LIFT TRUCKS, AND TIRES FOR FORK LIFT TRUCKS; AND REPLACEMENT PARTS THEREFOR (U.S. CLS. 19, 21, 23, 31, 35 AND 44).
FIRST USE 0-0-1936; IN COMMERCE 12-11-1998.

CLASS 14—JEWELRY

2,535,028. PHAT FASHIONS LLC, NEW YORK, NY. SN 75-837,394. FILED P.R. 11-1-1999; AM. S.R. 4-28-2001.

CARRINGTON

FOR WATCHES (U.S. CLS. 2, 27, 28 AND 50).
FIRST USE 3-1-2001; IN COMMERCE 3-1-2001.

2,535,134. MOUAWAD USA, INC., NEW YORK, NY. SN 78-057,523. FILED P.R. 4-9-2001; AM. S.R. 8-22-2001.

MOUAWAD

FOR WATCHES AND FINE JEWELRY (U.S. CLS. 2, 27, 28 AND 50).
FIRST USE 1-1-1890; IN COMMERCE 3-1-2001.

CLASS 15—MUSICAL INSTRUMENTS

CLASS 15—(Continued).

2,534,993. GIBSON GUITAR CORP., NASHVILLE, TN. SN 75-531,448. FILED P.R. 8-5-1998; AM. S.R. 7-5-2001.

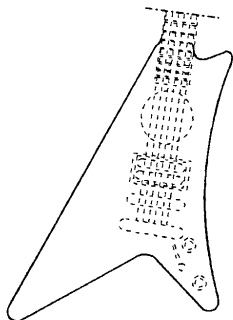

OWNER OF U.S. REG. NOS. 1,782,606, 2,053,805, AND OTHERS.

THE MATTER SHOWN IN BROKEN LINES SHOWS THE PLACEMENT OF THE MARK ON THE GOODS AND IS NOT PART OF THE MARK.

THE MARK COMPRISES A FANCIFUL DESIGN OF A BODY OF A GUITAR.

FOR STRINGED MUSICAL INSTRUMENTS, NAMELY GUITARS (U.S. CLS. 2, 21 AND 36).

FIRST USE 7-13-1999; IN COMMERCE 7-13-1999.

2,535,114. SCOTT CAO VIOLINS, CAMPBELL, CA. SN 76-212,010. FILED P.R. 2-20-2001; AM. S.R. 6-11-2001.

SCOTTI

FOR STRINGED MUSICAL INSTRUMENTS (U.S. CLS. 2, 21 AND 36).

FIRST USE 12-1-2000; IN COMMERCE 12-1-2000.

CLASS 16—PAPER GOODS AND PRINTED MATTER

2,535,005. C-LINE PRODUCTS, INC., MT. PROSPECT, IL. SN 75-688,830. FILED P.R. 4-22-1999; AM. S.R. 10-17-2001.



THE LINING SHOWN IN THE DRAWING IS INTENDED TO INDICATE THE COLOR RED.

FOR PLASTIC PAGES FOR HOLDING PHOTOGRAPHS (U.S. CLS. 2, 5, 22, 23, 29, 37, 38 AND 50).

FIRST USE 4-15-1999; IN COMMERCE 4-15-1999.

CLASS 16—(Continued).

2,535,010. MILLIMAN & ROBERTSON, INC., SEATTLE, WA. SN 75-714,666. FILED P.R. 5-27-1999; AM. S.R. 10-5-2001.

MILLIMAN

FOR BOOKS, LOOSE-LEAF BINDER COMPILATIONS, NEWSLETTERS, JOURNALS, AND MAGAZINES; ALL RELATING TO ACTUARIAL, BUSINESS CONSULTING, BENEFITS OUTSOURCING, PENSION AND RETIREMENT FUND ADMINISTRATION, AND HEALTHCARE MANAGEMENT SERVICES (U.S. CLS. 2, 5, 22, 23, 29, 37, 38 AND 50).

FIRST USE 5-31-2001; IN COMMERCE 5-31-2001.

2,535,049. VERMEER MANUFACTURING COMPANY, PELLA, IA. SN 75-922,708. FILED P.R. 2-18-2000; AM. S.R. 9-4-2001.

EQUIPMENT TRENDS

FOR PUBLICATIONS, NAMELY, NEWSLETTERS IN THE FIELDS OF INDUSTRIAL MACHINERY, THE INDUSTRIAL MARKET, INDUSTRIAL AND ENVIRONMENTAL TECHNOLOGIES, ENVIRONMENTAL MACHINERY, AND THE ENVIRONMENTAL MARKET (U.S. CLS. 2, 5, 22, 23, 29, 37, 38 AND 50).

FIRST USE 1-0-2000; IN COMMERCE 1-0-2000.

2,535,060. WERNER PUBLISHING CORPORATION, LOS ANGELES, CA. SN 76-023,507. FILED P.R. 4-11-2000; AM. S.R. 3-26-2001.

DIGITAL CAMERA & PHOTO

FOR MAGAZINES, NAMELY, A PERIODICALLY PUBLISHED BUYER'S GUIDE FEATURING INFORMATION ON DIGITAL CAMERAS AND DIGITAL PHOTOGRAPHY (U.S. CLS. 2, 5, 22, 23, 29, 37, 38 AND 50).

FIRST USE 10-0-1999; IN COMMERCE 10-0-1999.

2,535,067. REAL ESTATE MEDIA, INC., NEW YORK, NY. SN 76-052,524. FILED P.R. 5-19-2000; AM. S.R. 5-17-2001.

REAL ESTATE CHICAGO

OWNER OF U.S. REG. NOS. 1,215,808, 2,058,045, AND 2,456,338.

FOR PRINTED MATERIAL, NAMELY A SERIES OF MAGAZINES ON THE SUBJECT OF REAL ESTATE (U.S. CLS. 2, 5, 22, 23, 29, 37, 38 AND 50).

FIRST USE 9-1-2000; IN COMMERCE 9-1-2000.

CLASS 16—(Continued).

2,535,082. MOSBY, INC., ST. LOUIS, MO. SN 76-111,670. FILED P.R. 8-17-2000; AM. S.R. 9-6-2001.

**YEAR BOOK OF
DERMATOLOGY AND
DERMATOLOGIC SURGERY**

NO CLAIM IS MADE TO THE EXCLUSIVE RIGHT TO USE "DERMATOLOGY" AND "DERMATOLOGICAL SURGERY", APART FROM THE MARK AS SHOWN. FOR MEDICAL BOOK PUBLISHED ANNUALLY (U.S. CLS. 2, 5, 22, 23, 29, 37, 38 AND 50). FIRST USE 0-0-1998; IN COMMERCE 0-0-1998.

2,535,083. MOSBY, INC., ST. LOUIS, MO. SN 76-111,674. FILED P.R. 8-17-2000; AM. S.R. 9-6-2001.

**YEAR BOOK OF
RHEUMATOLOGY,
ARTHRITIS AND
MUSCULOSKELETAL
DISEASE**

NO CLAIM IS MADE TO THE EXCLUSIVE RIGHT TO USE "RHEUMATOLOGY", "ARTHRITIS" AND "MUSCULOSKELETAL DISEASE", APART FROM THE MARK AS SHOWN. FOR MEDICAL BOOK PUBLISHED ANNUALLY (U.S. CLS. 2, 5, 22, 23, 29, 37, 38 AND 50). FIRST USE 0-0-1999; IN COMMERCE 0-0-1999.

2,535,087. NEW PARADIGM RESOURCES GROUP, INC., CHICAGO, IL. SN 76-119,407. FILED P.R. 8-31-2000; AM. S.R. 4-16-2001.

CLEC ISSUES

FOR PRINTED MATTER, NAMELY PERIODIC REPORTS FEATURING INFORMATION REGARDING ISSUES IN THE FACILITIES-BASED COMPETITIVE LOCAL EXCHANGE CARRIER MARKET (U.S. CLS. 2, 5, 22, 23, 29, 37, 38 AND 50). FIRST USE 1-1-1996; IN COMMERCE 1-1-1996.

CLASS 16—(Continued).

2,535,117. MOHR GRAPHICS AND PUBLISHING, INC., PALM CITY, FL. SN 76-262,234. FILED P.R. 5-25-2001; AM. S.R. 9-24-2001.

**TREASURE COAST
MAGAZINE**

NO CLAIM IS MADE TO THE EXCLUSIVE RIGHT TO USE "MAGAZINE", APART FROM THE MARK AS SHOWN. FOR MAGAZINE FOR RESIDENTS AND VISITORS WHO WANT INFORMATION ABOUT THE AREA AND THE HOMES AND COMMUNITIES FORM NORTH PALM BEACH TO VERO BEACH (U.S. CLS. 2, 5, 22, 23, 29, 37, 38 AND 50). FIRST USE 3-1-1994; IN COMMERCE 3-1-1994.

2,535,118. MADISON GROUP, THE, HUNTINGTON BEACH, CA. SN 76-290,235. FILED P.R. 7-26-2001; AM. S.R. 10-5-2001.

MAKE -A- MOLD

FOR MODELING COMPOUNDS, NAMELY, MOLDING POWDER USED TO MAKE MOLDS (U.S. CLS. 2, 5, 22, 23, 29, 37, 38 AND 50). FIRST USE 7-20-2001; IN COMMERCE 7-20-2001.

2,535,124. BULTINCK, CHRISTINA, MARIE, FRANKFORT, IL. SN 78-012,624. FILED P.R. 6-14-2000; AM. S.R. 6-5-2001.

THE RECRUITER'S BIBLE

FOR EMPLOYER REFERENCE BOOK COMPRISING A PERIODICALLY UPDATED SERIES OF CURRENT LISTINGS OF FREE ONLINE RECRUITING SITES (U.S. CLS. 2, 5, 22, 23, 29, 37, 38 AND 50). FIRST USE 5-0-1997; IN COMMERCE 5-0-1997.

2,535,132. LE BOEUF, RONNIE, JOSEPH, BATON ROUGE, LA. SN 78-040,671. FILED P.R. 12-27-2000; AM. S.R. 7-23-2001.

THE PRACTICING NOTARY

FOR NEWSLETTERS IN THE FIELD OF NOTARIES AND THE NOTARY PUBLIC PROFESSION (U.S. CLS. 2, 5, 22, 23, 29, 37, 38 AND 50). FIRST USE 7-1-1996; IN COMMERCE 7-1-1996.

CLASS 17—RUBBER GOODS

CLASS 17—(Continued).

2,535,063. URASEAL, INC., DOVER, NH. SN 76-042,424. FILED P.R. 5-5-2000; AM. S.R. 4-2-2001.

SHAKE N' SEAL

FOR URETHANE SEALANTS FOR ENCAPSULATING SPLICES IN ELECTRICAL WIRES (U.S. CLS. 1, 5, 12, 13, 35 AND 50).

FIRST USE 4-17-2000; IN COMMERCE 4-17-2000.

2,535,066. TEMPLE-INLAND FOREST PRODUCTS CORPORATION, DIBOLL, TX. SN 76-051,503. FILED P.R. 5-18-2000; AM. S.R. 6-8-2001.

FIBER BASE

NO CLAIM IS MADE TO THE EXCLUSIVE RIGHT TO USE "FIBER", APART FROM THE MARK AS SHOWN.

FOR WOOD FIBER INSULATION USED IN ROOFS FOR BUILDINGS AND RESIDENCES (U.S. CLS. 1, 5, 12, 13, 35 AND 50).

FIRST USE 1-15-1990; IN COMMERCE 1-15-1990.

CLASS 20—FURNITURE AND ARTICLES NOT OTHERWISE CLASSIFIED

2,535,085. LEGREG COMPANY, MERCED, CA. SN 76-115,645. FILED P.R. 8-23-2000; AM. S.R. 8-28-2001.

BILL BENDER

THE MARK DOES NOT IDENTIFY A PARTICULAR LIVING INDIVIDUAL.

FOR HAT AND CAP SHAPERS MADE FROM PLASTIC, NAMELY, PLASTIC SHAPERS WHICH ADJUST THE BRIM OF HATS TO THE DESIRED SHAPE (U.S. CLS. 2, 13, 22, 25, 32 AND 50).

FIRST USE 6-14-2000; IN COMMERCE 6-22-2000.

CLASS 24—FABRICS

2,535,046. MURPHY CAP & GOWN COMPANY, ST. PETERSBURG, FL. SN 75-909,395. FILED P.R. 2-4-2000; AM. S.R. 12-26-2000.

DAMASCENE

FOR FABRIC FOR USE IN THE MANUFACTURING OF ROBES AND OTHER RELIGIOUS ATTIRE (U.S. CLS. 42 AND 50).

FIRST USE 12-28-1999; IN COMMERCE 12-28-1999.

CLASS 25—CLOTHING**CLASS 25—(Continued).**

2,534,992. SPRING FORD INDUSTRIES, SPRING CITY, PA. SN 75-492,957. FILED P.R. 5-29-1998; AM. S.R. 7-12-1999.

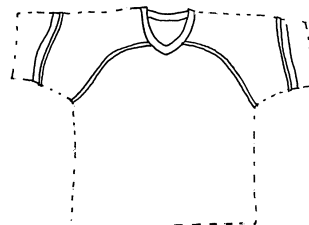

NO CLAIM IS MADE TO THE EXCLUSIVE RIGHT TO USE "THE REPRESENTATION OF THE SHAPE OF A UNIFORM JERSEY", APART FROM THE MARK AS SHOWN.

THE MARK CONSISTS OF A CONFIGURATION OF A UNIFORM JERSEY, WHICH CONSISTS OF A STRIPE ON THE V-NECK SEAM, DOUBLE BANDS AROUND THE UPPER PORTION OF EACH SLEEVE, AND A BAND IN THE SHAPE OF AN ARC RUNNING ACROSS THE SHIRT'S FRONT CONNECTING THE UNDERSIDE OF EACH ARM AND INTERSECTING THE BOTTOM OF THE SHIRT'S NECK. THE DOTTED LINES SHOW THE POSITION OF THE MARK ON THE GOODS.

FOR CLOTHING, NAMELY, T-SHIRTS AND JERSEY (U.S. CLS. 22 AND 39).

FIRST USE 4-4-1998; IN COMMERCE 4-4-1998.

2,535,008. ELDER MANUFACTURING COMPANY, INC., ST. LOUIS, MO. SN 75-707,037. FILED P.R. 5-14-1999; AM. S.R. 11-22-2000.

K-12 GEAR SCHOOL UNIFORMS

NO CLAIM IS MADE TO THE EXCLUSIVE RIGHT TO USE "GEAR" OR "SCHOOL UNIFORMS", APART FROM THE MARK AS SHOWN.

FOR CLOTHING, NAMELY TOPS, BOTTOMS, SHIRTS, SHORTS, SWEATERS, BLOUSES, SKIRTS AND UNIFORMS (U.S. CLS. 22 AND 39).

FIRST USE 2-25-2000; IN COMMERCE 2-25-2000.

2,535,056. KEST, BRYAN, SANTA MONICA, CA. SN 75-960,066. FILED P.R. 3-14-2000; AM. S.R. 4-17-2001.

SANTA MONICA POWER YOGA

FOR CLOTHING, NAMELY T-SHIRTS, SHIRTS, SWEATSHIRTS, PANTS, SWEATPANTS, SHORTS, SOCKS, JACKETS, COATS, HATS, CAPS, BANDANNAS (U.S. CLS. 22 AND 39).

FIRST USE 2-1-1998; IN COMMERCE 2-1-1998.

CLASS 25—(Continued).

2,535,126. BHANDARI, RAJINDER, IRVING, TX. SN 78-023,003. FILED P.R. 8-25-2000; AM. S.R. 7-19-2001.

SILK THREADS

FOR LADIES SILK DRESSES AND MEN'S SILK TUXEDOS (U.S. CLS. 22 AND 39).
FIRST USE 8-1-1991; IN COMMERCE 11-1-1991.

2,535,136. VIEWPOINT INTERNATIONAL, INC., NEW YORK, NY. SN 78-081,509. FILED P.R. 8-28-2001; AM. S.R. 10-30-2001.

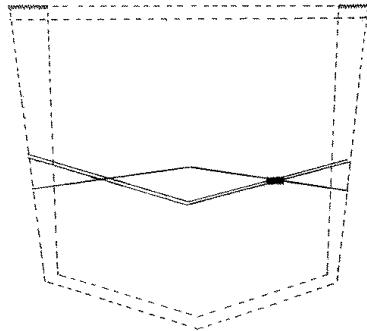

THE MARK CONSISTS OF A STITCHING PATTERN APPEARING ON THE BACK POCKET OF THE GOODS. THE MATTER SHOWN BY THE DOTTED LINES IS NOT A PART OF THE MARK AND SERVES ONLY TO SHOW THE POSITION OF THE MARK.

FOR CLOTHING, NAMELY, PANTS, JEANS, SHORTS AND SKIRTS (U.S. CLS. 22 AND 39).
FIRST USE 8-27-2001; IN COMMERCE 8-27-2001.

CLASS 27—FLOOR COVERINGS

2,535,115. RUCKSTUHL AG, 4901 LANGENTHAL, SWITZERLAND. SN 76-220,829. FILED P.R. 3-6-2001; AM. S.R. 9-19-2001.

RUCKSTUHL

OWNER OF SWITZERLAND REG. NO. 460792, DATED 12-16-1998, EXPIRES 12-16-2008.

FOR AREA RUGS, CARPETS, DOOR MATS, LINOLEUM FOR USE ON FLOORS AND HARD SURFACE COVERINGS FOR FLOORS (U.S. CLS. 19, 20, 37, 42 AND 50).

CLASS 28—TOYS AND SPORTING GOODS

CLASS 28—(Continued).

2,534,987. MANLEY TOYS U.S.A., LTD., NEW YORK, NY. SN 75-374,045. FILED P.R. 10-16-1997; AM. S.R. 8-14-2000.

NIGHT VISION

FOR TOY HEAD WEAR AND EYE WEAR, NAMELY, GOGGLES, EYEGLASSES, VISORS, FACE SHIELDS, HELMETS, CAPS AND HATS (U.S. CLS. 22, 23, 38 AND 50).
FIRST USE 3-0-1997; IN COMMERCE 3-0-1997.

2,535,119. MOULTRIE FEEDERS SECOND CORP., INC., ALABASTER, AL. SN 76-301,938. FILED 8-17-2001.

FEEDER REPEATER

FOR SPORTING GOODS, NAMELY, HUNTING GAME CALLS (U.S. CLS. 22, 23, 38 AND 50).
FIRST USE 4-0-2001; IN COMMERCE 4-0-2001.

CLASS 29—MEATS AND PROCESSED FOODS

2,535,080. SAVE-A-LOT FOOD STORES, INC., EARTH CITY, MO. SN 76-091,948. FILED P.R. 7-19-2000; AM. S.R. 3-6-2001.

CREAMY WHIP

NO CLAIM IS MADE TO THE EXCLUSIVE RIGHT TO USE "WHIP", APART FROM THE MARK AS SHOWN.
FOR WHIPPED TOPPING (U.S. CL. 46).
FIRST USE 11-14-2000; IN COMMERCE 11-14-2000.

2,535,093. NAKAMURA, MICHAEL TOSHIO, BURLINGAME, CA. SN 76-133,329. FILED P.R. 9-19-2000; AM. S.R. 4-12-2001.

GOURMET EDAMAME

NO CLAIM IS MADE TO THE EXCLUSIVE RIGHT TO USE "EDAMAME", APART FROM THE MARK AS SHOWN. THE ENGLISH TRANSLATION OF THE WORD "EDAMAME" IN THE MARK IS "SOYBEANS".
FOR FROZEN ENTREES CONSISTING PRIMARILY OF SOYBEANS, TURKEY, CHICKEN, BEEF, PORK, SUSHI AND VEGETABLES (U.S. CL. 46).
FIRST USE 5-1-1998; IN COMMERCE 5-1-1998.

CLASS 30—STAPLE FOODS

CLASS 30—(Continued).

2,535,004. DIEDRICH COFFEE, INC., IRVINE, CA. SN 75-679,093. FILED P.R. 4-12-1999; AM. S.R. 10-2-2001.

PAPUA NEW GUINEA

FOR COFFEE, COFFEE BEANS, AND BEVERAGES, NAMELY, COFFEE, ICED COFFEE, MOCHAS, LATTES, ESPRESSOS, CAPPUCCINOS AND COFFEE-BASED BEVERAGES (U.S. CL. 46).

FIRST USE 11-0-1998; IN COMMERCE 11-0-1998.

2,535,032. LAMB-WESTON, INC., KENNEWICK, WA. SN 75-855,775. FILED P.R. 11-23-1999; AM. S.R. 4-25-2001.

COLUMBIA BASIN BLENDS

NO CLAIM IS MADE TO THE EXCLUSIVE RIGHT TO USE "BLENDS", APART FROM THE MARK AS SHOWN.

FOR BREADING AND BATTER MIXES, WITH OR WITHOUT SEASONINGS, WHICH MIXES CONTAIN FLOURS AND FOOD STARCHES (U.S. CL. 46).

FIRST USE 2-28-2000; IN COMMERCE 2-28-2000.

2,535,043. RADEMAKER B.V., 1047 BA AMSTERDAM, NETHERLANDS. SN 75-903,412. FILED P.R. 1-25-2000; AM. S.R. 12-11-2000.

**AMSTERDAM
TRUFFLES**

OWNER OF BENELUX REG. NO. 0669594, DATED 12-17-1999, EXPIRES 12-17-2009.

NO CLAIM IS MADE TO THE EXCLUSIVE RIGHT TO USE "TRUFFLES", APART FROM THE MARK AS SHOWN.

FOR CHOCOLATE AND CHOCOLATE PRODUCTS, NAMELY CHOCOLATE POWDER, CHOCOLATE SYRUP, CHOCOLATE TOPPING AND CHOCOLATE BONBONS (U.S. CL. 46).

2,535,065. MAUI MEDICINAL HERBS, INC., MAKAWAO, HI. SN 76-048,794. FILED P.R. 5-15-2000; AM. S.R. 5-8-2001.

BREW OR CHEW

FOR COFFEE, TEA, COCOA, SUGAR, RICE, TAPIOCA, SAGO, ARTIFICIAL COFFEE, BREAKFAST CEREALS, BREAD, BAKERY GOODS, FROZEN CONFECTIONS, CANDY, HONEY, TREACLE, YEAST, BAKING POWDER, SALT, MUSTARD, VINEGAR, SPICES, ICE, AND CONDIMENTS, NAMELY SAUCES (U.S. CL. 46).

FIRST USE 7-23-1998; IN COMMERCE 7-23-1998.

CLASS 31—NATURAL AGRICULTURAL PRODUCTS

2,535,000. J.W. JUNG SEED COMPANY, RANDOLPH, WI. SN 75-643,171. FILED P.R. 2-17-1999; AM. S.R. 7-20-2001.

ROOTS & RHIZOMES

FOR LIVING DECORATIVE PERENNIAL PLANTS, IN BOTH POTTED AND BARE ROOT FORM, AND PEAT MOSS (U.S. CLS. 1 AND 46).

FIRST USE 3-0-1999; IN COMMERCE 3-0-1999.

2,535,037. PERFORMANCE FOODS, INC., BROOMFIELD, CO. SN 75-872,653. FILED P.R. 12-16-1999; AM. S.R. 11-24-2000.

FERRET COMPLETE

OWNER OF U.S. REG. NO. 1,844,627.

FOR PET FOOD, NAMELY FERRET FOOD (U.S. CLS. 1 AND 46).

FIRST USE 5-17-2000; IN COMMERCE 5-17-2000.

CLASS 32—LIGHT BEVERAGES

2,535,001. SCHULTHEISS-BRAUERREI GMBH, 13053 BERLIN, FED REP GERMANY. SN 75-663,090. FILED P.R. 3-18-1999; AM. S.R. 11-14-2000.

SCHULTHEISS

OWNER OF FED REP GERMANY REG. NO. 672,241, DATED 3-1-1955, EXPIRES 10-31-2003.

FOR BEERS (U.S. CLS. 45, 46 AND 48).

2,535,068. COTT CORPORATION, MISSISSAUGA, ONTARIO, CANADA. SN 76-055,481. FILED P.R. 5-24-2000; AM. S.R. 5-9-2001.

SUPER FRUIT

FOR NON-ALCOHOLIC, CARBONATED AND NON-CARBONATED SOFT DRINKS, FRUIT DRINKS AND FRUIT JUICES (U.S. CLS. 45, 46 AND 48).

FIRST USE 9-1-2000; IN COMMERCE 9-1-2000.

CLASS 33—WINES AND SPIRITS

CLASS 33—(Continued).

2,535,091. THOMA, MARILYNN, WILMETTE, IL, BY ASSIGNMENT PARDUCCI WINE ESTATES, LLC, UKIAH, CA. SN 76-127,188. FILED P.R. 9-14-2000; AM. S.R. 5-18-2001.

BRAMLETT

FOR WINE (U.S. CLS. 47 AND 49).
FIRST USE 1-10-2001; IN COMMERCE 1-16-2001.

CLASS 34—SMOKERS' ARTICLES

2,535,113. SMOKERS CHOICE OF PA., INC., LIBERTY, NY. SN 76-194,802. FILED P.R. 1-16-2001; AM. S.R. 8-21-2001.

NINE SELECT

FOR TOBACCO PRODUCTS, NAMELY TOBACCO (U.S. CLS. 2, 8, 9 AND 17).
FIRST USE 10-2-2000; IN COMMERCE 10-2-2000.

SERVICE MARKS

CLASS 35—ADVERTISING AND BUSINESS

2,534,989. BAKER DISTRIBUTING CO., JACKSONVILLE, FL. SN 75-423,737. FILED P.R. 1-26-1998; AM. S.R. 4-23-2001.

ICE DESIGN CENTER

NO CLAIM IS MADE TO THE EXCLUSIVE RIGHT TO USE "ICE", APART FROM THE MARK AS SHOWN.
FOR WHOLESALE OUTLET STORES FEATURING ICE MACHINES AND OTHER FOOD SERVICE PRODUCTS, NAMELY, REACH-IN FREEZERS OR REFRIGERATOR UNITS IN THE NATURE OF DRINK DISPENSERS, ICE DISPENSERS, WATER FILTRATION UNITS, WALK-IN COOLERS AND FREEZERS (U.S. CLS. 100, 101 AND 102).
FIRST USE 0-0-1998; IN COMMERCE 0-0-1998.

2,534,999. J.W. JUNG SEED COMPANY, RANDOLPH, WI. SN 75-643,151. FILED P.R. 2-17-1999; AM. S.R. 7-20-2001.

ROOTS & RHIZOMES

FOR MAIL ORDER CATALOG SERVICES, FEATURING DECORATIVE PERENNIAL PLANTS, IN POTTED AND BARE ROOT FORM, AND GARDENING TOOLS, BOOKS AND VIDEOS (U.S. CLS. 100, 101 AND 102).
FIRST USE 3-0-1999; IN COMMERCE 3-0-1999.

CLASS 35—(Continued).

2,535,002. SHOPKO STORES, INC., GREEN BAY, WI. SN 75-667,511. FILED P.R. 3-25-1999; AM. S.R. 6-14-2001.

SIMPLESIZING

FOR RETAIL DEPARTMENT STORE SERVICES FEATURING METHODS FOR SIZING IN BOYS AND GIRLS APPAREL TO CORRECTLY IDENTIFY HEIGHT AND WEIGHT STANDARDS BY SIZE (U.S. CLS. 100, 101 AND 102).
FIRST USE 7-5-1999; IN COMMERCE 7-5-1999.

2,535,007. BUSINESS INTEGRATION GROUP, CINCINNATI, OH. SN 75-696,038. FILED P.R. 4-30-1999; AM. S.R. 4-3-2001.

BUSINESS INTEGRATION GROUP

NO CLAIM IS MADE TO THE EXCLUSIVE RIGHT TO USE "BUSINESS" AND "GROUP", APART FROM THE MARK AS SHOWN.

FOR TECHNOLOGY CONSULTING COMPANY SERVICES, NAMELY, PROVIDING INFORMATION TECHNOLOGY "IT" STAFFING AND MANAGEMENT; PROVIDING IT STAFFING MANAGEMENT; PROVIDING IT STAFFING ON TEMPORARY AND PERMANENT BASIS; PROVIDING BUSINESS CONSULTING SERVICES REGARDING ELECTRONIC COMMERCE SOLUTIONS FOR BUSINESS; AND PROVIDING CONSULTING SERVICES WHICH UTILIZE A GLOBAL COMPUTER NETWORK-BASED AND CLIENT/SERVER TECHNOLOGIES TO PROVIDE MISSION-CRITICAL INTERNET-BASED AND CLIENT/SERVER TECHNOLOGIES PROVIDE MISSION-CRITICAL BUSINESS SOLUTIONS TO A WIDE RANGE OF COMPANIES IN THE INSURANCE, BANKING, LEASING, COMPUTER EQUIPMENT, FURNITURE AND AUTOMOBILE INDUSTRIES (U.S. CLS. 100, 101 AND 102).
FIRST USE 1-0-2000; IN COMMERCE 1-0-2000.

2,535,009. MILLIMAN & ROBERTSON, INC., SEATTLE, WA. SN 75-714,658. FILED P.R. 5-27-1999; AM. S.R. 10-5-2001.

MILLIMAN

FOR BUSINESS CONSULTING SERVICES (U.S. CLS. 100, 101 AND 102).
FIRST USE 5-31-2001; IN COMMERCE 5-31-2001.

CLASS 35—(Continued).

2,535,012. GLOBAL-SUPPLY.COM, INC, CHICAGO, IL. SN 75-741,415. FILED P.R. 6-30-1999; AM. S.R. 8-14-2001.

-supply.com

FOR ON-LINE RETAIL AND DISTRIBUTORSHIP SERVICES FEATURING EQUIPMENT, SUPPLIES, AND MATERIALS FOR USE WITH INKS, COATINGS, ADHESIVES, PAINTS, SEALANTS, PRINTING, PACKAGING, FINISHING, FURNITURE, PLUMBING, PUMPS, ELECTRONICS, PHOTOGRAPHY, TEXTILES, TESTING, MEASURING, RESEARCH AND DEVELOPMENT, LABORATORIES, POLYMERS, PLASTICS, METALS, CHEMICALS, WOODWORKING, FLOORING, RAPID PROTOTYPING, CONVERTING MATERIALS AND MACHINERY IN THE FIELD OF UV SUPPLIES; PROMOTING THE GOODS AND SERVICES OF OTHERS PERTAINING TO EQUIPMENT, SUPPLIES AND MATERIALS FOR USE WITH INKS, COATINGS, ADHESIVES, PAINTS, SEALANTS, PRINTING, PACKAGING, FINISHING, FURNITURE, PLUMBING, PUMPS, ELECTRONICS, PHOTOGRAPHY, TEXTILES, TESTING, MEASURING, RESEARCH AND DEVELOPMENT, LABORATORIES, POLYMERS, PLASTICS, METALS, CHEMICALS, WOODWORKING, FLOORING, RAPID PROTOTYPING, CONVERTING MATERIALS AND MACHINERY IN THE FIELD OF UV SUPPLIES, BY PREPARING AND PLACING ADVERTISEMENTS IN NEWSPAPERS, MAGAZINES AND ELECTRONIC MEDIA ACCESSED THROUGH A GLOBAL COMPUTER NETWORK (U.S. CLS. 100, 101 AND 102).

FIRST USE 6-14-1999; IN COMMERCE 6-14-1999.

2,535,014. MEDICAL DOCTOR ASSOCIATES, INC., NORCROSS, GA. SN 75-773,797. FILED P.R. 8-13-1999; AM. S.R. 8-6-2001.

MEDICAL DOCTOR ASSOCIATES

NO CLAIM IS MADE TO THE EXCLUSIVE RIGHT TO USE "ASSOCIATES", APART FROM THE MARK AS SHOWN.

FOR PHYSICIAN STAFFING SERVICES (U.S. CLS. 100, 101 AND 102).

FIRST USE 2-28-1987; IN COMMERCE 2-28-1987.

2,535,021. ADDRESS.COM, INC., MONTEBELLO, CA. SN 75-819,258. FILED P.R. 10-12-1999; AM. S.R. 8-30-2001.

ADDRESS.COM

FOR BUSINESS SERVICES, NAMELY PROVIDING ONLINE DIRECTORY SERVICES AND PROMOTING THE GOODS AND SERVICES OF OTHERS BY PROVIDING A WEBSITE ON A GLOBAL COMPUTER NETWORK WHICH PROVIDES LINKS TO A WIDE VARIETY OF BUSINESS AND COMPANIES' WEBSITES (U.S. CLS. 100, 101 AND 102).

FIRST USE 12-15-1994; IN COMMERCE 2-1-1999.

CLASS 35—(Continued).

2,535,025. ASSOCIATION OF BREWERS, INC., BOULDER, CO. SN 75-832,235. FILED P.R. 10-26-1999; AM. S.R. 8-24-2001.

BREWEXPO AMERICA

FOR ORGANIZING, PROMOTING, AND CONDUCTING CONFERENCES, TRADESHOWS, CONVENTIONS AND EXPOSITIONS IN THE FIELD OF BREWING BEER (U.S. CLS. 100, 101 AND 102).

FIRST USE 4-26-2000; IN COMMERCE 4-26-2000.

2,535,038. I B NET, LTD, NEW YORK, NY. SN 75-876,800. FILED P.R. 12-20-1999; AM. S.R. 11-21-2000.

I B NET

NO CLAIM IS MADE TO THE EXCLUSIVE RIGHT TO USE "NET", APART FROM THE MARK AS SHOWN.

FOR PROMOTING THE GOODS AND SERVICES OF OTHERS BY PROVIDING ON-LINE CATALOGS OF THE GOODS AND SERVICES OF OTHERS IN THE FIELD OF INTERNATIONAL BUSINESS; COMPUTERIZED ON-LINE INFORMATION SERVICES, NAMELY PROVIDING INFORMATION OVER THE GLOBAL COMPUTER NETWORKS CONCERNING SELLING AND PURCHASING THE GOODS AND SERVICES OF OTHERS, NAMELY PROVIDING INFORMATION CONCERNING THE PRICES AND AVAILABILITY OF THE GOODS AND SERVICES IN THE INTERNATIONAL BUSINESS FIELD THAT ALLOWS INTERNATIONAL BUSINESS VENDORS AND PURCHASERS TO FIND OTHER INTERNATIONAL BUSINESS VENDORS AND PURCHASERS THAT HAVE COMPLIMENTARY BUYING AND SELLING NEEDS; ON-LINE AUCTION SERVICES FEATURING THE GOODS AND SERVICES OF INTERNATIONAL BUSINESSES (U.S. CLS. 100, 101 AND 102).

FIRST USE 6-10-1999; IN COMMERCE 6-10-1999.

2,535,052. MESA AUTO X-CHANGE, INC, MESA, AZ. SN 75-930,911. FILED P.R. 2-29-2000; AM. S.R. 2-23-2001.

AUTOXCHANGE

FOR AUTOMOBILE DEALERSHIPS, AND PROVIDING INFORMATION IN THE FIELD OF AUTOMOBILE DEALERSHIPS VIA THE GLOBAL COMPUTER NETWORK (U.S. CLS. 100, 101 AND 102).

FIRST USE 2-0-1998; IN COMMERCE 2-0-1998.

CLASS 35—(Continued).

2,535,058. WORLD COMMERCE ONLINE, INC., ORLANDO, FL. SN 76-004,927. FILED P.R. 3-20-2000; AM. S.R. 5-29-2001.

FLORASHOPS.COM

FOR ONLINE RETAIL AND WHOLESALE DISTRIBUTORSHIP SERVICES FEATURING AGRICULTURAL AND HORTICULTURAL PRODUCTS; ADVERTISING, NAMELY, PROMOTING THE GOODS AND SERVICES OF OTHERS BY PREPARING AND PLACING ADVERTISEMENTS IN AN ELECTRONIC DIRECTORY ACCESSED THROUGH A GLOBAL COMPUTER NETWORK AND DISSEMINATION OF ADVERTISING FOR OTHERS VIA AN ON-LINE ELECTRONIC COMMUNICATIONS NETWORK (U.S. CLS. 100, 101 AND 102).

FIRST USE 6-7-1999; IN COMMERCE 6-7-1999.

2,535,074. HANENFELD, JOHN, SEAFORD, DE. SN 76-073,431. FILED P.R. 6-20-2000; AM. S.R. 6-8-2001.

buy@auction.com

FOR AUCTION SERVICES, NAMELY AUCTIONEERING THE REAL ESTATE PROPERTY AND RETAIL GOODS OF OTHERS; MARKETING SERVICES, NAMELY PROMOTING THE SALE OF REAL PROPERTY AND THE RETAIL GOODS OF OTHERS BY DIRECT MAIL AND INTERNET ADVERTISING (U.S. CLS. 100, 101 AND 102).

FIRST USE 10-0-2000; IN COMMERCE 10-0-2000.

2,535,075. HANENFELD, JOHN, SEAFORD, DE. SN 76-073,438. FILED P.R. 6-20-2000; AM. S.R. 6-8-2001.

BUY@AUCTION.COM

FOR AUCTION SERVICES, NAMELY AUCTIONEERING THE REAL ESTATE PROPERTY AND RETAIL GOODS OF OTHERS; MARKETING SERVICES, NAMELY PROMOTING THE SALE OF REAL PROPERTY AND THE RETAIL GOODS OF OTHERS BY DIRECT MAIL AND INTERNET ADVERTISING (U.S. CLS. 100, 101 AND 102).

FIRST USE 10-0-2000; IN COMMERCE 10-0-2000.

CLASS 35—(Continued).

2,535,081. ENTERPRISE IG, INC., NEW YORK, NY. SN 76-106,367. FILED P.R. 8-8-2000; AM. S.R. 7-10-2001.

BRAND ANALYTICS

FOR BUSINESS CONSULTING SERVICES IN THE FIELD OF CORPORATE IDENTITY AND BRAND IDENTITY AND DEVELOPMENT (U.S. CLS. 100, 101 AND 102).

FIRST USE 3-0-1999; IN COMMERCE 3-0-1999.

2,535,092. CANON COMMUNICATIONS LLC, LOS ANGELES, CA. SN 76-132,043. FILED P.R. 9-14-2000; AM. S.R. 8-3-2001.

ATLANTIC DESIGN & MANUFACTURING

FOR ARRANGING AND CONDUCTING OF TRADE SHOWS IN THE FIELD OF MANUFACTURING AND DESIGN ENGINEERING PRODUCTS AND SERVICES (U.S. CLS. 100, 101 AND 102).

FIRST USE 6-5-2001; IN COMMERCE 6-5-2001.

2,535,096. REDTAGOUTLET.COM, INC., EDEN PRAIRIE, MN. SN 76-138,118. FILED P.R. 9-29-2000; AM. S.R. 9-13-2001.

REDTAG.COM

OWNER OF U.S. REG. NO. 2,430,520.
FOR COMPUTERIZED ON-LINE RETAIL SERVICES OFFERING A VARIETY OF CONSUMER MERCHANDISE (U.S. CLS. 100, 101 AND 102).

FIRST USE 11-10-1998; IN COMMERCE 11-10-1998.

2,535,098. I-VALVE, INC., SAN FRANCISCO, CA. SN 76-140,078. FILED P.R. 10-3-2000; AM. S.R. 8-15-2001.

I-VALVE. COM

FOR COMPUTERIZED ON-LINE WHOLESALE AND RETAIL SERVICES IN THE FIELD OF VALVES (U.S. CLS. 100, 101 AND 102).

FIRST USE 9-19-2000; IN COMMERCE 9-19-2000.

2,535,099. TRADE SHOWS, INC., CLAREMONT, NC. SN 76-140,081. FILED P.R. 10-3-2000; AM. S.R. 8-23-2001.

NORTHWEST INDUSTRIAL WOODWORKING EXPO

OWNER OF U.S. REG. NOS. 2,358,920 AND 2,358,921.
NO CLAIM IS MADE TO THE EXCLUSIVE RIGHT TO

CLASS 35—(Continued).

USE "INDUSTRIAL WOODWORKING EXPO", APART FROM THE MARK AS SHOWN.

FOR ARRANGING AND CONDUCTING TRADE SHOW EXHIBITIONS IN THE FIELDS OF WOODWORKING, FURNITURE AND FURNITURE SUPPLIES (U.S. CLS. 100, 101 AND 102).

FIRST USE 1-0-2000; IN COMMERCE 1-0-2000.

2,535,103. 01 INC, NEW YORK, NY. SN 76-148,015. FILED P.R. 10-17-2000; AM. S.R. 10-16-2001.

THE MUSEUM OF WOODWORKING TOOLS

NO CLAIM IS MADE TO THE EXCLUSIVE RIGHT TO USE "MUSEUM", APART FROM THE MARK AS SHOWN.

FOR ON-LINE RETAIL STORE SERVICES FEATURING TOOLS, BOOKS AND ANTIQUES ASSOCIATED WITH WOODWORKING (U.S. CLS. 100, 101 AND 102).

FIRST USE 2-28-1996; IN COMMERCE 12-15-1997.

2,535,120. NORTHWEST AIRLINES, INC., ST. PAUL, MN. SN 76-303,591. FILED P.R. 8-22-2001; AM. S.R. 10-25-2001.

BIZ PERKS

OWNER OF U.S. REG. NOS. 2,365,494 AND 2,367,286. FOR INCENTIVE AWARD PROGRAMS, NAMELY, PROMOTING THE GOODS AND SERVICES OF OTHERS BY AWARDING FREQUENT FLYER MILES (U.S. CLS. 100, 101 AND 102).

FIRST USE 3-1-2001; IN COMMERCE 3-1-2001.

2,535,123. BOOKSPAN, GARDEN CITY, NY. SN 78-012,161. FILED P.R. 6-12-2000; AM. S.R. 8-13-2001.

COMPUTER GRAPHICS AND ANIMATION BOOK CLUB

NO CLAIM IS MADE TO THE EXCLUSIVE RIGHT TO USE "BOOK CLUB", APART FROM THE MARK AS SHOWN.

FOR BOOK CLUB SERVICES BY MAIL ORDER, TELEPHONE ORDER, AND BY MEANS OF GLOBAL COMPUTER NETWORK (U.S. CLS. 100, 101 AND 102).

FIRST USE 7-31-2000; IN COMMERCE 7-31-2000.

CLASS 35—(Continued).

2,535,127. STEPHANI, SCOTT P., ONEIDA, WI. SN 78-025,103. FILED P.R. 9-8-2000; AM. S.R. 4-30-2001.

FOR RETAIL STORE SERVICES DIRECTLY TO AND FROM THE PUBLIC FEATURING BOOKS, CAR AUDIO EQUIPMENT, CLOTHING, COMPACT DISCS, COMPUTER GAME PROGRAMS, COMPUTER HARDWARE, COMPUTER SOFTWARE, EXERCISE EQUIPMENT, HAND TOOLS, HOME ELECTRONICS, VIDEO CASSETTE TAPES AND DVDS CONTAINING MOTION PICTURES, MUSICAL INSTRUMENTS, POWER TOOLS, RECREATIONAL EQUIPMENT, SPORTING GOODS, COMPUTER VIDEO GAME PROGRAMS (U.S. CLS. 100, 101 AND 102).

FIRST USE 9-5-2000; IN COMMERCE 9-5-2000.

2,535,130. CATON SERVICES, INC, CEDAR PARK, TX. SN 78-036,039. FILED P.R. 11-20-2000; AM. S.R. 7-16-2001.

ORSUPPORT

FOR EMPLOYMENT AGENCY (U.S. CLS. 100, 101 AND 102).

FIRST USE 1-1-2000; IN COMMERCE 1-1-2000.

CLASS 36—INSURANCE AND FINANCIAL

2,535,006. AMERICAN MONEY TRANSFER, INC., LOS ANGELES, CA. SN 75-689,640. FILED P.R. 4-23-1999; AM. S.R. 11-14-2000.

AMERICAN MONEY TRANSFER, INC.

NO CLAIM IS MADE TO THE EXCLUSIVE RIGHT TO USE "MONEY TRANSFER, INC.", APART FROM THE MARK AS SHOWN.

FOR FINANCIAL SERVICES, NAMELY, MONEY TRANSFER SERVICES (U.S. CLS. 100, 101 AND 102).

FIRST USE 9-1-1998; IN COMMERCE 9-1-1998.

CLASS 36—(Continued).

2,535,018. NEW YORK INDEPENDENT SYSTEM OPERATOR, SCHENECTADY, NY. SN 75-796,497. FILED P.R. 9-8-1999; AM. S.R. 5-14-2001.



NO CLAIM IS MADE TO THE EXCLUSIVE RIGHT TO USE "INDEPENDENT SYSTEM OPERATOR", APART FROM THE MARK AS SHOWN.

FOR ELECTRICITY BROKERAGE SERVICES IN THE NATURE OF CONDUCTING AN ELECTRICITY COMMODITY MARKET IN WHICH POWER IS PURCHASED AND SOLD ON THE BASIS OF COMPETITIVE BIDDING (U.S. CLS. 100, 101 AND 102).

FIRST USE 4-1-1999; IN COMMERCE 4-1-1999.

2,535,072. MORTGAGES LTD., PHOENIX, AZ. SN 76-068,104. FILED P.R. 6-12-2000; AM. S.R. 4-5-2001.

DEFERRED DEEDS OF TRUST

NO CLAIM IS MADE TO THE EXCLUSIVE RIGHT TO USE "DEEDS OF TRUST", APART FROM THE MARK AS SHOWN.

FOR PROVISION OF MORTGAGE BANKING, MORTGAGE LENDING AND MORTGAGE BROKERAGE SERVICES (U.S. CLS. 100, 101 AND 102).

FIRST USE 1-2-1997; IN COMMERCE 1-2-1997.

2,535,073. MORTGAGES LTD., PHOENIX, AZ. SN 76-068,105. FILED P.R. 6-12-2000; AM. S.R. 4-5-2001.

INDIVIDUAL DEEDS OF TRUST

NO CLAIM IS MADE TO THE EXCLUSIVE RIGHT TO USE "DEEDS OF TRUST", APART FROM THE MARK AS SHOWN.

FOR PROVISION OF MORTGAGE BANKING, MORTGAGE LENDING AND MORTGAGE BROKERAGE SERVICES (U.S. CLS. 100, 101 AND 102).

FIRST USE 1-1-1963; IN COMMERCE 1-1-1963.

CLASS 36—(Continued).

2,535,079. ESCROW BANK USA, SALT LAKE CITY, UT. SN 76-091,914. FILED P.R. 7-19-2000; AM. S.R. 7-2-2001.

ESCROW BANK USA

NO CLAIM IS MADE TO THE EXCLUSIVE RIGHT TO USE "ESCROW BANK", APART FROM THE MARK AS SHOWN.

FOR PROVIDING FINANCIAL AND MORTGAGE ESCROW BANKING SERVICES, NAMELY, DEPOSITORY AND FIDUCIARY SERVICES FOR COMMERCIAL AND RESIDENTIAL MORTGAGE ESCROW FUNDS AND FIDUCIARY SERVICES FOR COMMERCIAL AND RESIDENTIAL MORTGAGE DOCUMENTS (U.S. CLS. 100, 101 AND 102).

FIRST USE 12-15-1999; IN COMMERCE 1-24-2000.

2,535,128. GENERAL MOTORS ACCEPTANCE CORPORATION, DETROIT, MI. SN 78-031,911. FILED P.R. 10-23-2000; AM. S.R. 8-21-2001.

UNIVERSAL WARRANTY

NO CLAIM IS MADE TO THE EXCLUSIVE RIGHT TO USE "WARRANTY", APART FROM THE MARK AS SHOWN.

FOR INSURANCE SERVICES, NAMELY, UNDERWRITING EXTENDED WARRANTY CONTRACTS IN THE FIELD OF AUTOMOBILES (U.S. CLS. 100, 101 AND 102).

FIRST USE 9-25-1998; IN COMMERCE 9-25-1998.

2,535,133. FOR SALE BY OWNER.COM CORP., NEW YORK, NY. SN 78-042,170. FILED P.R. 1-8-2001; AM. S.R. 7-16-2001.

NATIONAL REAL ESTATE LISTINGS WITHOUT THE COMMISSION!

FOR COMPUTER SERVICES, NAMELY PROVIDING ON-LINE LISTINGS IN THE FIELD OF REAL ESTATE THROUGH A GLOBAL OPEN ACCESS NETWORK (U.S. CLS. 100, 101 AND 102).

FIRST USE 9-0-1999; IN COMMERCE 9-0-1999.

CLASS 37—CONSTRUCTION AND REPAIR

2,534,994. DANIELS EQUIPMENT, INC., DBA COST LESS PARTS, AUBURN, NH. SN 75-538,886. FILED P.R. 8-18-1998; AM. S.R. 6-6-2001.

COST-LESS PARTS!

NO CLAIM IS MADE TO THE EXCLUSIVE RIGHT TO USE "PARTS", APART FROM THE MARK AS SHOWN.

FOR DISTRIBUTORSHIP SERVICES IN THE FIELD OF COMMERCIAL LAUNDRY AND DRY CLEANING EQUIPMENT (U.S. CLS. 100, 103 AND 106).

FIRST USE 6-0-1998; IN COMMERCE 6-0-1998.

CLASS 37—(Continued).

2,534,997. MOUNTAIN ENTERPRISES, INC., LEXINGTON, KY. SN 75-578,336. FILED P.R. 10-23-1998; AM. S.R. 8-16-2000.

MOUNTAIN MATERIALS

NO CLAIM IS MADE TO THE EXCLUSIVE RIGHT TO USE "MATERIALS", APART FROM THE MARK AS SHOWN.

FOR ROAD CONSTRUCTION; STREET CONSTRUCTION, NAMELY, GRADING ROADS; EXCAVATION; INSTALLATION OF DRAINAGE STRUCTURES; ROAD PAVING; QUARRYING; AND INCIDENTAL CONSTRUCTION RELATING TO ROAD BUILDING, NAMELY, CURB CONSTRUCTION (U.S. CLS. 100, 103 AND 106).

FIRST USE 6-1-1998; IN COMMERCE 6-1-1998.

CLASS 38—COMMUNICATION

2,535,023. TELESUITE CORPORATION, ENGLEWOOD, OH. SN 75-829,820. FILED P.R. 10-21-1999; AM. S.R. 6-4-2001.

E CAMPUS

FOR VIDEO AND AUDIO TELECONFERENCING DURING WHICH AN IMAGE OF AT LEAST ONE REMOTE PARTICIPANT IS DISPLAYED ON A SCREEN IN A ROOM SO THAT ANOTHER PARTICIPANT VIEWING THE SCREEN MAY FEEL THAT HE/SHE IS FACE-TO-FACE WITH THE REMOTE PARTICIPANT (U.S. CLS. 100, 101 AND 104).

FIRST USE 6-1-2001; IN COMMERCE 6-1-2001.

2,535,035. BESTNET COMMUNICATIONS CORP., TUCSON, AZ, BY CHANGE OF NAME WAVE TECH INTERNATIONAL, INC., TUCSON, AZ. SN 75-865,641. FILED P.R. 12-6-1999; AM. S.R. 7-24-2001.

BESTNETCALL.COM

FOR PROVIDING LONG DISTANCE TELEPHONE SERVICES VIA A GLOBAL COMPUTER NETWORK (U.S. CLS. 100, 101 AND 104).

FIRST USE 5-15-1999; IN COMMERCE 5-15-1999.

CLASS 38—(Continued).

2,535,116. GENTNER COMMUNICATIONS CORPORATION, SALT LAKE CITY, UT. SN 76-238,771. FILED P.R. 4-9-2001; AM. S.R. 6-29-2001.

EXPRESS CONFERENCE

NO CLAIM IS MADE TO THE EXCLUSIVE RIGHT TO USE "CONFERENCE", APART FROM THE MARK AS SHOWN.

FOR TELECOMMUNICATIONS SERVICES, NAMELY FULL-SERVICE, OPERATOR-CONTROLLED CONFERENCE CALLING THAT CAN BE ACCESSED ON DEMAND THROUGH A PRE-PROGRAMMED BUTTON FOUND ON TELEPHONES, CONFERENCE PHONES, AND A TOLL-FREE TELEPHONE NUMBER (U.S. CLS. 100, 101 AND 104).

FIRST USE 6-0-2000; IN COMMERCE 6-0-2000.

CLASS 39—TRANSPORTATION AND STORAGE

2,535,095. KEVIN C. BRYANT, SHELDON A. BUCKLER, GARY L. COUNTRYMAN, THOMAS G. DIGNAN, JR., CHARLES K. GIFFORD, NELSON S. GIFFORD, MATINA S. HORNER, FRANKLIN M. HUNDLEY, PAUL A. LA CAMERA, THOMAS J. MAY, SHERRY H. PENNEY, GERALD L. WILSON, AND RUSSELL D. WRIGHT, ALL U.S. CITIZENS, AS TRUSTEES OF THE TRUSTEES OF NSTAR, BOSTON, MA. SN 76-133,805. FILED P.R. 9-22-2000; AM. S.R. 7-5-2001.

SERVICE GUARANTEED

NO CLAIM IS MADE TO THE EXCLUSIVE RIGHT TO USE "SERVICE", APART FROM THE MARK AS SHOWN.

FOR PUBLIC UTILITY SERVICES IN THE NATURE OF TRANSMISSION AND DISTRIBUTION OF ELECTRICITY, NATURAL GAS AND LIQUEFIED PETROLEUM (U.S. CLS. 100 AND 105).

FIRST USE 8-25-1999; IN COMMERCE 8-25-1999.

CLASS 41—EDUCATION AND ENTERTAINMENT

2,535,040. MULTIBUYER, INC., PEARL RIVER, NY. SN 75-886,581. FILED P.R. 1-4-2000; AM. S.R. 6-14-2001.

GROUPLOTTO

FOR LOTTERY SERVICES (U.S. CLS. 100, 101 AND 107).

FIRST USE 11-15-1999; IN COMMERCE 11-15-1999.

CLASS 41—(Continued).

2,535,047. HENRICHS, MICHAEL H., ROCHESTER, NY. SN 75-912,567. FILED P.R. 2-8-2000; AM. S.R. 5-31-2001.

C.H.I.L.D.

FOR EDUCATIONAL AND GROUP COUNSELING SERVICES, NAMELY CONDUCTING SEMINARS AND WORKSHOPS ON THE SUBJECT OF HELPING CHILDREN AND THEIR FAMILIES COPE WITH SERIOUS ILLNESS, DEATH AND SEPARATION FROM LOVED ONES (U.S. CLS. 100, 101 AND 107).

FIRST USE 2-0-1999; IN COMMERCE 2-0-1999.

2,535,054. MICHIGAN ECONOMIC DEVELOPMENT CORPORATION, LANSING, MI. SN 75-939,252. FILED P.R. 3-6-2000; AM. S.R. 8-1-2001.

MICHIGAN TECHNICAL EDUCATION CENTER

NO CLAIM IS MADE TO THE EXCLUSIVE RIGHT TO USE "TECHNICAL EDUCATION CENTER", APART FROM THE MARK AS SHOWN.

FOR EDUCATIONAL SERVICES, NAMELY, PROVIDING STATE-OF-THE-ART JOB-TRAINING SERVICES IN THE NATURE OF EMPLOYER-DESIGNED COURSES FOR SKILLED WORKERS AT DEDICATED FACILITIES (U.S. CLS. 100, 101 AND 107).

FIRST USE 3-17-2000; IN COMMERCE 3-17-2000.

2,535,061. TRADE TECH, INC., RANCHO CORDOVA, CA. SN 76-028,553. FILED 4-17-2000.

DSLTECH

FOR VOCATIONAL INSTRUCTION AND CERTIFICATION IN THE FIELD OF DIGITAL SUBSCRIBER LINE INSTALLATION (U.S. CLS. 100, 101 AND 107).

FIRST USE 1-1-2001; IN COMMERCE 1-1-2001.

2,535,078. BILLIARD CONGRESS OF AMERICA, INC., COLORADO SPRINGS, CO. SN 76-089,217. FILED P.R. 7-14-2000; AM. S.R. 7-2-2001.

USA CUE SPORTS

FOR EDUCATIONAL AND ENTERTAINMENT SERVICES RELATING TO COMPETITIVE BILLIARDS (U.S. CLS. 100, 101 AND 107).

FIRST USE 5-15-2001; IN COMMERCE 5-15-2001.

CLASS 41—(Continued).

2,535,104. SBK SUPERBIKE INTERNATIONAL LTD., TORONTO, BR.VIRGIN ISLANDS. SN 76-148,317. FILED P.R. 10-16-2000; AM. S.R. 10-16-2000.



NO CLAIM IS MADE TO THE EXCLUSIVE RIGHT TO USE "SUPERSTOCK", APART FROM THE MARK AS SHOWN.

FOR PROVIDING FACILITIES FOR SPORTS TOURNAMENTS, NAMELY FOR MOTORCYCLE RACING, ENTERTAINMENT IN THE NATURE OF MOTORCYCLE RACING AND MOTORCYCLE GAMES, ORGANIZING AND MANAGING MOTORCYCLE RACING, ORGANIZING MOTORCYCLE RACING CONTESTS AND EXHIBITIONS AND CULTURAL AND RECREATIONAL ACTIVITIES IN MOTORCYCLE SPORTS (U.S. CLS. 100, 101 AND 107).

FIRST USE 4-0-1999; IN COMMERCE 7-9-2000.

2,535,107. ANSWER PAGE, INC. THE, SHARON, MA. SN 76-158,998. FILED P.R. 11-6-2000; AM. S.R. 8-23-2001.



NO CLAIM IS MADE TO THE EXCLUSIVE RIGHT TO USE "QUIZ FREE CME CONTINUING MEDICAL EDUCATION", APART FROM THE MARK AS SHOWN.

FOR EDUCATION SERVICES, NAMELY, CONDUCTING DAILY TRAINING SESSIONS FOR MEDICAL PROFESSIONALS OVER GLOBAL COMPUTER NETWORKS (U.S. CLS. 100, 101 AND 107).

FIRST USE 10-13-2000; IN COMMERCE 10-13-2000.

2,535,112. TWEEDIE, REBECCA HALE, DBA HISTORIC GRAND PRIX, SAN ANSELMO, CA. SN 76-194,165. FILED P.R. 1-11-2001; AM. S.R. 6-18-2001.

HISTORIC GRAND PRIX

NO CLAIM IS MADE TO THE EXCLUSIVE RIGHT TO USE "GRAND PRIX", APART FROM THE MARK AS SHOWN.

FOR ENTERTAINMENT SERVICES, NAMELY, ORGANIZING, PROMOTING AND CONDUCTING VINTAGE AUTOMOBILE RACES (U.S. CLS. 100, 101 AND 107).

FIRST USE 8-17-2000; IN COMMERCE 8-17-2000.

CLASS 41—(Continued).

2,535,135. AMERICAN COLLEGE OF FORENSIC EXAMINERS, INC., SPRINGFIELD, MO. SN 78-078,530. FILED P.R. 8-9-2001; AM. S.R. 11-5-2001.

CERTIFIED FORENSIC ACCOUNTANT CR.F.A.

FOR TESTING SERVICES, NAMELY, DEVELOPING, CONSTRUCTING AND ADMINISTERING TESTS AND TESTING PROGRAMS FOR CANDIDATES IN THE FIELD OF FORENSIC ACCOUNTING (U.S. CLS. 100, 101 AND 107).

FIRST USE 10-1-2001; IN COMMERCE 10-1-2001.

CLASS 42—SCIENTIFIC, COMPUTER AND LEGAL SERVICES

2,534,995. KELLEY, JASON, PRESCOTT, AZ. SN 75-545,207. FILED P.R. 8-31-1998; AM. S.R. 3-30-2000.

YOUTH 4 YOUTH

FOR ASSOCIATION SERVICES, NAMELY PROMOTING COMMUNITY SERVICE PROJECTS (U.S. CLS. 100 AND 101).

FIRST USE 12-0-1998; IN COMMERCE 12-0-1998.

2,535,015. DIMENGO, MARIA, CLEARWATER, FL. SN 75-775,117. FILED P.R. 9-7-1999; AM. S.R. 5-1-2000.

DIVERSIFIED NETWORKING GROUP

NO CLAIM IS MADE TO THE EXCLUSIVE RIGHT TO USE "NETWORKING GROUP", APART FROM THE MARK AS SHOWN.

FOR COMPUTER SERVICES, NAMELY, DESIGNING AND IMPLEMENTING COMPUTER NETWORK WEB PAGES FOR OTHERS (U.S. CLS. 100 AND 101).

FIRST USE 10-20-1999; IN COMMERCE 10-26-1999.

2,535,041. TIGER TESTING INC., NEW YORK, NY. SN 75-886,767. FILED P.R. 1-4-2000; AM. S.R. 12-22-2000.

THE INDEPENDENT COMPUTER SECURITY TESTING SPECIALISTS

NO CLAIM IS MADE TO THE EXCLUSIVE RIGHT TO USE "COMPUTER SECURITY TESTING", APART FROM THE MARK AS SHOWN.

FOR COMPUTER SECURITY TESTING SERVICES (U.S. CLS. 100 AND 101).

FIRST USE 2-0-1998; IN COMMERCE 2-0-1998.

CLASS 42—(Continued).

2,535,045. LAWYER'S WEEKLY, INC, BOSTON, MA. SN 75-909,220. FILED P.R. 2-4-2000; AM. S.R. 9-28-2001.

NCLAWYERSWEEKLY.COM

OWNER OF U.S. REG. NOS. 1,195,678, 1,210,432, AND 2,033,266.

FOR PROVIDING NEWS AND PROFESSIONAL INFORMATION OF INTEREST TO LAWYERS, THE JUDICIARY, AND RELATED INTEREST GROUPS BY MEANS OF A GLOBAL COMPUTER NETWORK (U.S. CLS. 100 AND 101).

FIRST USE 1-24-1999; IN COMMERCE 1-24-1999.

2,535,051. IN PHASE INTERNATIONAL, INC., TEMPE, AZ. SN 75-930,032. FILED P.R. 2-11-2000; AM. S.R. 6-18-2001.

LINKUSA

FOR PROVIDING MEDICAL INFORMATION VIA THE INTERNET (U.S. CLS. 100 AND 101).

FIRST USE 8-1-1999; IN COMMERCE 8-1-1999.

2,535,059. EPAGOS, INC., AVENTURA, FL. SN 76-016,421. FILED P.R. 4-3-2000; AM. S.R. 7-9-2001.

DOMAIN AMERICAS

FOR WEB SITE HOSTING FOR OTHERS ON A COMPUTER SERVER FOR GLOBAL COMPUTER NETWORKS, AND REGISTRATION OF DOMAIN NAMES FOR IDENTIFICATION OF USERS IN NORTH AMERICA OR SOUTH AMERICA ON A GLOBAL COMPUTER NETWORK (U.S. CLS. 100 AND 101).

FIRST USE 1-3-2000; IN COMMERCE 1-3-2000.

2,535,069. GRANT BECKSTRAND CANCER FOUNDATION, LONG BEACH, CA. SN 76-058,124. FILED P.R. 5-30-2000; AM. S.R. 6-11-2001.

JST 4 KDZ

FOR COMMUNITY SERVICE, NAMELY, ARRANGING AND CONDUCTING YOUTH SUPPORT PROGRAMS, FEATURING COUNSELING SESSIONS FOR HEALTHY YOUTH WHO HAVE A FAMILY MEMBER OR LIVED ONE SUFFERING FROM A LIFE THREATENING ILLNESS (U.S. CLS. 100 AND 101).

FIRST USE 0-0-1992; IN COMMERCE 0-0-1992.

CLASS 42—(Continued).

2,535,070. PHASE-1 MOLECULAR TOXICOLOGY, INC., SANTA FE, NM. SN 76-061,812. FILED P.R. 6-6-2000; AM. S.R. 4-9-2001.

TRANSCRIPTOME FINGERPRINTING

FOR MEDICAL TESTING SERVICES, NAMELY, ADMINISTERING A MEDICAL TEST TO SCREEN FOR PHARMACEUTICAL REACTIONS IN OTHERS (U.S. CLS. 100 AND 101).

FIRST USE 9-0-2000; IN COMMERCE 9-0-2000.

2,535,071. CHASE MANHATTAN CORPORATION, THE, NEW YORK, NY. SN 76-066,069. FILED P.R. 6-7-2000; AM. S.R. 3-26-2001.

PERSONALIZED LOAN ANALYZER

FOR PROVIDING TEMPORARY USE OF ONLINE, NON-DOWNLOADABLE SOFTWARE FOR CALCULATING THE MONTHLY PAYMENT ON BANK LOANS AND LOAN PAYMENT SCHEDULES (U.S. CLS. 100 AND 101).

FIRST USE 5-5-2000; IN COMMERCE 5-5-2000.

2,535,077. BILLIARD CONGRESS OF AMERICA, INC., COLORADO SPRINGS, CO. SN 76-089,216. FILED P.R. 7-14-2000; AM. S.R. 7-2-2001.

USA CUE SPORTS

FOR ASSOCIATION SERVICES, NAMELY PROMOTING INTEREST IN THE SPORT OF BILLIARDS IN THE UNITED STATES AND THROUGHOUT THE WORLD (U.S. CLS. 100 AND 101).

FIRST USE 5-15-2001; IN COMMERCE 5-15-2001.

2,535,086. PITA CAFE, INC., THE, BIRMINGHAM, AL. SN 76-118,729. FILED P.R. 8-23-2000; AM. S.R. 8-20-2001.

THE PITA CAFE

NO CLAIM IS MADE TO THE EXCLUSIVE RIGHT TO USE "CAFE", APART FROM THE MARK AS SHOWN.

FOR RESTAURANT SERVICES (U.S. CLS. 100 AND 101).

FIRST USE 10-31-1998; IN COMMERCE 10-31-1998.

CLASS 42—(Continued).

2,535,094. SANCTUM, LTD., HERZELIA 46733, ISRAEL. SN 76-133,455. FILED P.R. 9-22-2000; AM. S.R. 8-23-2001.

APPAUDIT

FOR COMPUTER SERVICES, NAMELY INVESTIGATING AND REPORTING ON THE INTEGRITY AND PRIVACY OF ELECTRONIC COMMERCE AND GLOBAL COMMUNICATIONS NETWORK APPLICATIONS, SYSTEMS AND TRANSACTIONS; INVESTIGATING AND REPORTING ON THE INTEGRITY AND PRIVACY OF COMPUTER DATA AND APPLICATIONS (U.S. CLS. 100 AND 101).

FIRST USE 12-1-1999; IN COMMERCE 12-1-1999.

2,535,101. USA COOKS, INC., CHICAGO, IL. SN 76-141,073. FILED P.R. 10-4-2000; AM. S.R. 9-25-2001.

CHICAGOCOOKS.COM

FOR COMPUTER SERVICES, NAMELY, PROVIDING ON-LINE INFORMATION IN THE FIELD OF HOME DINING (U.S. CLS. 100 AND 101).

FIRST USE 5-8-2000; IN COMMERCE 5-8-2000.

2,535,102. KAUFMAN, HARLEY, NEW YORK, NY. SN 76-146,389. FILED P.R. 10-11-2000; AM. S.R. 7-11-2001.

PHYSICIANLAWYER

FOR COMPUTER SERVICES, NAMELY, PROVIDING INFORMATION REGARDING LEGAL SERVICES, MEDICAL CARE SERVICES AND HEALTH CARE PRODUCTS AND SERVICES VIA GLOBAL COMPUTER NETWORK (U.S. CLS. 100 AND 101).

FIRST USE 7-2-2001; IN COMMERCE 7-2-2001.

2,535,105. KAUFMAN, HARLEY, NEW YORK, NY. SN 76-152,501. FILED P.R. 10-19-2000; AM. S.R. 8-15-2001.

MALPRACTICELAWYER

FOR COMPUTER SERVICES, NAMELY, PROVIDING INFORMATION REGARDING LEGAL SERVICES VIA GLOBAL COMPUTER NETWORK (U.S. CLS. 100 AND 101).

FIRST USE 8-2-2001; IN COMMERCE 8-2-2001.

CLASS 42—(Continued).

2,535,106. NATIONAL ASSOCIATION OF WATERPROOFING & STRUCTURAL REPAIR CONTRACTORS, CLEVELAND, OH. SN 76-156,133. FILED P.R. 10-27-2000; AM. S.R. 10-23-2001.

NATIONAL ASSOCIATION OF WATERPROOFING & STRUCTURAL REPAIR CONTRACTORS

NO CLAIM IS MADE TO THE EXCLUSIVE RIGHT TO USE "ASSOCIATION OF WATERPROOFING AND STRUCTURAL REPAIR CONTRACTORS", APART FROM THE MARK AS SHOWN.

FOR ASSOCIATION SERVICES NAMELY PROMOTING THE INTERESTS OF WATERPROOFING AND STRUCTURAL REPAIR CONTRACTORS AND PROVIDING PUBLIC UNDERSTANDING OF THE BASEMENT WATERPROOFING AND STRUCTURAL REPAIR INDUSTRY (U.S. CLS. 100 AND 101).

FIRST USE 8-1-2000; IN COMMERCE 8-1-2000.

2,535,108. NATIONAL SHOOTING SPORTS FOUNDATION, INC., NEWTOWN, CT. SN 76-159,163. FILED P.R. 11-2-2000; AM. S.R. 9-24-2001.

NATIONAL ASSOCIATION OF FIREARMS RETAILERS

NO CLAIM IS MADE TO THE EXCLUSIVE RIGHT TO USE "ASSOCIATION", APART FROM THE MARK AS SHOWN.

FOR ASSOCIATION SERVICES, NAMELY, PROMOTING THE LEGAL, LEGISLATIVE AND POLITICAL INTERESTS OF RETAIL STORES SELLING FIREARMS (U.S. CLS. 100 AND 101).

FIRST USE 12-0-2000; IN COMMERCE 12-0-2000.

2,535,109. EMPLOYER SERVICES ASSURANCE CORPORATION(ESAC), LITTLE ROCK, AR. SN 76-166,754. FILED P.R. 11-16-2000; AM. S.R. 9-28-2001.

EMPLOYER SERVICES ASSURANCE CORPORATION

FOR PROVIDING QUALITY ASSURANCE SERVICES IN THE FIELD OF PROFESSIONAL EMPLOYER ORGANIZATIONS, SPECIFICALLY, ASSURING THE INTEGRITY, LEGAL COMPLIANCE, AND FINANCIAL RESPONSIBILITY OF SUCH ORGANIZATIONS (U.S. CLS. 100 AND 101).

FIRST USE 7-1-2000; IN COMMERCE 7-1-2000.

CLASS 42—(Continued).

2,535,110. GLOBAL INFORMATION SECURITY INC, TAMPA, FL. SN 76-176,046. FILED P.R. 12-5-2000; AM. S.R. 6-19-2001.

GLOBAL INFORMATION SECURITY

FOR COMPUTER NETWORK SECURITY SERVICES, NAMELY, PROVIDING VIRUS PROTECTION, ENCRYPTION, FIREWALLS AND VIRTUAL PRIVATE NETWORKS, NAMELY, INTERNET PROTOCOL COMPUTER NETWORKS PROVIDING SECURE COMMUNICATIONS TO THE IP PROTOCOL BETWEEN ALL COMMUNICATING POINTS (U.S. CLS. 100 AND 101).

FIRST USE 11-28-2000; IN COMMERCE 11-28-2000.

2,535,121. CHRISTOPHERSON, NANCY, OLDSMAR, FL. SN 76-305,394. FILED P.R. 8-25-2001; AM. S.R. 10-24-2001.

FLORIDA FRIENDS

FOR SOCIAL INTRODUCTION SERVICES FOR WOMEN (U.S. CLS. 100 AND 101).

FIRST USE 8-10-2001; IN COMMERCE 8-10-2001.

2,535,122. DELL COMPUTER CORPORATION, ROUND ROCK, TX. SN 78-002,571. FILED P.R. 4-4-2000; AM. S.R. 3-12-2001.

SERVICE PROVIDER DIRECT

NO CLAIM IS MADE TO THE EXCLUSIVE RIGHT TO USE "SERVICE PROVIDER", APART FROM THE MARK AS SHOWN.

FOR TECHNICAL SUPPORT SERVICES, NAMELY, TECHNICAL ASSISTANCE AND TROUBLESHOOTING OF COMPUTER HARDWARE AND SOFTWARE PROBLEMS VIA THE TELEPHONE AND INTERNET; COMPUTER TECHNICAL CONSULTING SERVICES, NAMELY, DEVELOPING AND DESIGNING ELECTRONIC COMMERCE SYSTEMS FOR OTHERS (U.S. CLS. 100 AND 101).

FIRST USE 4-5-2000; IN COMMERCE 4-5-2000.

CLASS 42—(Continued).

2,535,125. DIVORCEINTERACTIVE.COM, INC., SMITH-TOWN, NY. SN 78-022,615. FILED P.R. 8-23-2000; AM. S.R. 10-23-2001.

CLASS 42—(Continued).

2,535,131. HEWLETT-PACKARD COMPANY, PALO ALTO, CA. SN 78-039,271. FILED P.R. 12-14-2000; AM. S.R. 9-24-2001.



E-SECURITY PROBE

FOR COMPUTER SERVICES, NAMELY, PROVIDING ON-LINE DATABASES, ON-LINE INFORMATION, AND SEARCH ENGINES, FOR OBTAINING DATA ON A GLOBAL COMPUTER NETWORK FEATURING NEWS, FACTS, SOURCES, RESOURCES AND INFORMATION IN THE FIELD OF LEGAL SERVICES RELATED TO FAMILY LAW ISSUES, AND ISSUES OF INTEREST TO THOSE SEEKING SUCH INFORMATION AND SERVICES, SUCH AS DIVORCE PROFESSIONALS, DIVORCE-RELATED BUSINESSES, DIVORCE SUPPORT GROUPS AND GOVERNMENT AGENCIES (U.S. CLS. 100 AND 101).
FIRST USE 10-4-2001; IN COMMERCE 10-4-2001.

NO CLAIM IS MADE TO THE EXCLUSIVE RIGHT TO USE E-SECURITY, APART FROM THE MARK AS SHOWN.
FOR CONSULTING SERVICES IN THE COMPUTER FIELD, NAMELY, CONSULTING RELATED TO IMPROVING THE SECURITY OF ELECTRONIC INFORMATION ON THE INTRANET AND EXTRANETS (U.S. CLS. 100 AND 101).
FIRST USE 2-13-2001; IN COMMERCE 2-13-2001.

* * * * *

TRADEMARK REGISTRATIONS RENEWED

The designation "U.S. Cl." appearing in this section refers to the U.S. class in effect prior to Sep. 1, 1973 rather than the international class which applies to applications filed on or after that date. For adoption of international classification see notice in the OFFICIAL GAZETTE of Jun. 26, 1973 (911 O.G. TM 210).

83,663.	ROYAL. U.S. CL. 23. (INT. CL. 7). REG. 10-3-1911.	550,729.	NEOTEX (STYLIZED). U.S. CL. 21. (INT. CL. 17). REG. 11-13-1951.
84,279.	CANOPUS (STYLIZED). U.S. CL. 15. (INT. CL. 4). REG. 11-21-1911.	551,042.	AEROQUIP AND DESIGN. U.S. CL. 35. (INT. CL. 17). REG. 11-20-1951.
84,282.	HYDRA. U.S. CL. 15. (INT. CL. 4). REG. 11-21-1911.	551,076.	VICKERS (STYLIZED). U.S. CL. 13. (INT. CL. 7). REG. 11-20-1951.
84,285.	MARFAK. U.S. CL. 15. (INT. CL. 4). REG. 11-21-1911.	552,243.	CALUMET AND DESIGN. U.S. CL. 46. (INT. CL. 30). REG. 12-18-1951.
84,347.	CAPELLA. U.S. CL. 15. (INT. CL. 4). REG. 11-28-1911.	554,685.	KIMPAK (STYLIZED). U.S. CL. 1. (INT. CL. 17). REG. 2-12-1952.
84,418.	PINNACLE. U.S. CL. 15. (INT. CL. 4). REG. 12-12-1911.	555,769.	MORRIS FEEL GLOVES (STYLIZED). U.S. CL. 39. (INT. CL. 25). REG. 3-4-1952.
84,432.	CRATER (STYLIZED). U.S. CL. 15. (INT. CL. 4). REG. 12-12-1911.	696,278.	Q-CAP. U.S. CL. 13. (INT. CL. 6). REG. 4-19-1960.
84,437.	THUBAN. U.S. CL. 15. (INT. CL. 4). REG. 12-12-1911.	711,273.	WOODALL'S. U.S. CL. 38. (INT. CL. 16). REG. 2-14-1961.
153,053.	LUBALOY. U.S. CL. 9. (INT. CL. 13). REG. 3-7-1922.	713,192.	INA AND DESIGN. U.S. CL. 38. (INT. CL. 16). REG. 3-28-1961.
286,793.	STRAIGHTLINE AND DESIGN. U.S. CL. 23. (INT. CL. 11). REG. 9-1-1931.	713,296.	INA. U.S. CL. 102. (INT. CL. 36). REG. 3-28-1961.
287,467.	SYNTHOL. U.S. CL. 16. (INT. CL. 2). REG. 9-29-1931.	713,297.	INA AND DESIGN. U.S. CL. 102. (INT. CL. 36). REG. 3-28-1961.
287,505.	METALHIDE (STYLIZED). U.S. CL. 16. (INT. CL. 2). REG. 9-29-1931.	713,434.	MISCELLANEOUS DESIGN. U.S. CL. 21. (INT. CL. 7). REG. 4-4-1961.
389,022.	"WONDER PUTTY". U.S. CL. 16. (INT. CL. 19). REG. 7-22-1941.	715,725.	POLY-CLIP. U.S. CL. 23. (INT. CLS. 6, 7, 8, 9, 11, 12, 16, 21 AND 28). REG. 5-23-1961.
390,357.	DICAL-D. U.S. CL. 6. (INT. CL. 5). REG. 9-23-1941.	716,701.	PILOT. U.S. CL. 11. (INT. CL. 16). REG. 6-13-1961.
391,990.	QUIKRETE. U.S. CL. 12. (INT. CL. 19). REG. 12-2-1941.	718,821.	SEVEN STAR. U.S. CL. 14. (INT. CL. 6). REG. 7-25-1961.
392,958.	NESCO. U.S. CL. 21. (INT. CL. 11). REG. 1-20-1942.	719,874.	HI WEAR 64. U.S. CL. 14. (INT. CL. 6). REG. 8-15-1961.
396,981.	SANTA FE (STYLIZED). U.S. CL. 17. (INT. CL. 34). REG. 8-11-1942.	721,412.	HAPPY KIDS. U.S. CL. 46. (INT. CLS. 1, 5, 29, 30, 31 AND 32). REG. 9-12-1961.
506,089.	SELMER (STYLIZED). U.S. CL. 38. (INT. CL. 16). REG. 1-25-1949.	721,812.	SUN X. U.S. CL. 19. (INT. CL. 12). REG. 9-26-1961.
525,798.	HALLMARK AND DESIGN. U.S. CL. 38. (INT. CLS. 9, 16 AND 28). REG. 5-30-1950.	721,987.	PLAYMATE. U.S. CL. 38. (INT. CL. 16). REG. 9-26-1961.
533,142.	STURDILITE. U.S. CL. 21. (INT. CL. 11). REG. 11-7-1950.	722,147.	B&W AND DESIGN. U.S. CL. 17. (INT. CL. 34). REG. 10-3-1961.
540,265.	"MELLO-TOASTED" AND DESIGN. U.S. CL. 46. (INT. CL. 30). REG. 4-3-1951.	722,175.	SAFEGUARD. U.S. CL. 19. (INT. CL. 12). REG. 10-3-1961.
540,407.	PERMAFUSE. U.S. CL. 5. (INT. CL. 1). REG. 4-3-1951.	722,337.	ITALIAN FESTIVAL. U.S. CL. 46. (INT. CL. 30). REG. 10-3-1961.
540,457.	COTT AND DESIGN. U.S. CL. 45. (INT. CL. 32). REG. 4-3-1951.	722,832.	THRULINE AND DESIGN. U.S. CL. 26. (INT. CL. 9). REG. 10-17-1961.
544,058.	ROTAVATOR. U.S. CL. 23. (INT. CL. 7). REG. 6-19-1951.	723,187.	ALBERTO VOS. U.S. CL. 51. (INT. CL. 3). REG. 10-24-1961.
545,042.	LYON. U.S. CL. 2. (INT. CL. 6). REG. 7-17-1951.	723,719.	KYNAR. INT. CL. 1. (U.S. CL. 1). REG. 11-14-1961.
546,338.	ACINTOL. INT. CL. 1. (U.S. CL. 1). REG. 8-7-1951.	725,840.	DAWE'S MICROFAC AND DESIGN. U.S. CL. 18. (INT. CL. 5). REG. 1-2-1962.
548,515.	NICE AND DESIGN. U.S. CL. 46. (INT. CL. 29). REG. 9-25-1951.	727,488.	FOR TOUGH REQUIREMENTS AND DESIGN. U.S. CL. 31. (INT. CL. 11). REG. 2-13-1962.
548,763.	LUCITONE. U.S. CL. 6. (INT. CL. 1). REG. 9-25-1951.	733,800.	TV TEASER. U.S. CL. 38. (INT. CL. 16). REG. 7-3-1962.
548,918.	LA FRANCE (STYLIZED). U.S. CL. 2. (INT. CL. 24). REG. 10-2-1951.	735,901.	AUTOPERF. U.S. CL. 13. (INT. CL. 6). REG. 8-14-1962.
549,097.	MISCELLANEOUS DESIGN. U.S. CL. 46. (INT. CL. 32). REG. 10-2-1951.	886,177.	RAIN FOR RENT. U.S. CL. 13. (INT. CLS. 6, 7, 11, 17, 20 AND 21). REG. 2-17-1970.
549,398.	DR. FRED PALMER SKIN WHITENER. U.S. CL. 51. (INT. CL. 3). REG. 10-16-1951.	904,028.	2 STIFFS MOTEL AND DESIGN. U.S. CL. 100. (INT. CL. 42). REG. 12-8-1970.
549,523.	"SHOT FROM GUNS" (STYLIZED). U.S. CL. 46. (INT. CL. 30). REG. 10-16-1951.	910,553.	ANVILETS. U.S. CL. 13. (INT. CL. 6). REG. 3-30-1971.
549,524.	"SHOT FROM GUNS" AND DESIGN. U.S. CL. 46. (INT. CL. 30). REG. 10-16-1951.	911,062.	SHUR-VALU AND DESIGN. U.S. CL. 101. (INT. CL. 35). REG. 4-6-1971.
549,652.	ROCK KRAFT (STYLIZED). U.S. CL. 2. (INT. CL. 16). REG. 10-16-1951.	911,501.	AQUATEST. U.S. CL. 26. (INT. CL. 9). REG. 4-20-1971.
549,742.	BUSINESS WEEK. U.S. CL. 38. (INT. CL. 16). REG. 10-23-1951.	915,850.	MACHETE. U.S. CL. 6. (INT. CL. 5). REG. 7-6-1971.
549,908.	ADMIRAL (STYLIZED). U.S. CL. 21. (INT. CL. 9). REG. 10-23-1951.	916,146.	KTM. U.S. CL. 13. (INT. CLS. 6 AND 11). REG. 7-13-1971.
550,448.	SOCCI. U.S. CL. 6. (INT. CL. 5). REG. 11-6-1951.	916,719.	AUTOMIX. U.S. CL. 26. (INT. CLS. 1, 9 AND 10). REG. 7-20-1971.

- 916,946. PETOSEED PS AND DESIGN. U.S. CL. 1. (INT. CL. 31). REG. 7-27-1971.
- 917,041. HERITAGE. U.S. CL. 13. (INT. CL. 11). REG. 7-27-1971.
- 917,618. MILWAUKEE AND DESIGN. U.S. CL. 23. (INT. CL. 7). REG. 8-3-1971.
- 918,422. FSP AND DESIGN. U.S. CLS. 21, 24, 31 AND 34. (INT. CLS. 7, 9 AND 11). REG. 8-17-1971.
- 918,720. GUIDE LINE. INT. CL. 1. (U.S. CL. 1). REG. 8-24-1971.
- 918,737. MOP & GLO. U.S. CL. 4. (INT. CL. 3). REG. 8-24-1971.
- 918,893. MISCELLANEOUS DESIGN. U.S. CL. 28. (INT. CL. 14). REG. 8-24-1971.
- 918,930. ACCOPAC. U.S. CL. 35. (INT. CL. 17). REG. 8-24-1971.
- 919,681. SCALA. U.S. CL. 13. (INT. CL. 11). REG. 9-7-1971.
- 919,802. HEATHKIT. U.S. CL. 38. (INT. CL. 16). REG. 9-7-1971.
- 919,941. CVS. U.S. CL. 101. (INT. CL. 35). REG. 9-7-1971.
- 920,066. DUNHILL INTERNATIONAL LONDON PARIS NEW YORK AND DESIGN. U.S. CL. 17. (INT. CL. 34). REG. 9-14-1971.
- 920,598. HITCH-UPS. U.S. CL. 22. (INT. CL. 28). REG. 9-21-1971.
- 920,624. TRANS FLITE. U.S. CL. 23. (INT. CL. 7). REG. 9-21-1971.
- 920,883. MRI. U.S. CL. 100. (INT. CL. 42). REG. 9-21-1971.
- 921,031. EVSCO. U.S. CL. 18. (INT. CL. 5). REG. 9-28-1971.
- 921,089. DIRT ALARM. U.S. CL. 26. (INT. CL. 9). REG. 9-28-1971.
- 921,198. INTRAFLO. U.S. CL. 44. (INT. CL. 10). REG. 9-28-1971.
- 921,207. LONE STAR AND DESIGN. U.S. CL. 46. (INT. CL. 30). REG. 9-28-1971.
- 921,356. MISCELLANEOUS DESIGN. U.S. CL. 200. REG. 9-28-1971.
- 921,357. MISCELLANEOUS DESIGN. U.S. CL. 200. REG. 9-28-1971.
- 921,393. RED DEVIL. U.S. CL. 12. (INT. CL. 17). REG. 10-5-1971.
- 921,396. DELTAR. U.S. CL. 13. (INT. CLS. 6 AND 20). REG. 10-5-1971.
- 921,425. RETIN A. U.S. CL. 18. (INT. CL. 5). REG. 10-5-1971.
- 921,456. MISCELLANEOUS DESIGN. U.S. CL. 19. (INT. CL. 12). REG. 10-5-1971.
- 921,518. REBOUND (STYLIZED). U.S. CL. 22. (INT. CL. 28). REG. 10-5-1971.
- 921,551. GLOBEMASTER. U.S. CL. 26. (INT. CL. 16). REG. 10-5-1971.
- 921,556. MINICOMMATE (STYLIZED). U.S. CL. 26. (INT. CL. 9). REG. 10-5-1971.
- 921,557. PEAKTOP (STYLIZED). U.S. CL. 26. (INT. CL. 9). REG. 10-5-1971.
- 921,573. MICROBEADS. U.S. CL. 31. (INT. CL. 1). REG. 10-5-1971.
- 921,692. AMERCO. U.S. CL. 101. (INT. CL. 35). REG. 10-5-1971.
- 921,719. PIGGLY WIGGLY. U.S. CL. 101. (INT. CL. 35). REG. 10-5-1971.
- 921,756. KINGS. U.S. CL. 107. (INT. CL. 41). REG. 10-5-1971.
- 921,757. LOS ANGELES KINGS AND DESIGN. U.S. CL. 107. (INT. CL. 41). REG. 10-5-1971.
- 921,774. KAOPOLITE. INT. CL. 1. (U.S. CL. 1). REG. 10-12-1971.
- 921,777. RIGIDEEP (STYLIZED). U.S. CL. 2. (INT. CL. 21). REG. 10-12-1971.
- 921,822. SPRITZER (STYLIZED). U.S. CL. 13. (INT. CL. 11). REG. 10-12-1971.
- 921,970. FINANCIAL ANALYSTS JOURNAL. U.S. CL. 38. (INT. CL. 16). REG. 10-12-1971.
- 922,117. PENNLON. U.S. CL. 1. (INT. CL. 17). REG. 10-19-1971.
- 922,166. EDGEMATE. U.S. CL. 12. (INT. CL. 19). REG. 10-19-1971.
- 922,219. MAR-COF. U.S. CL. 18. (INT. CL. 5). REG. 10-19-1971.
- 922,291. STAHSORB. U.S. CL. 21. (INT. CL. 9). REG. 10-19-1971.
- 922,397. REEL-COTE. U.S. CL. 37. (INT. CL. 16). REG. 10-19-1971.
- 922,602. LAWYER-PILOTS BAR ASSOCIATION AND DESIGN. U.S. CL. 200. REG. 10-19-1971.
- 922,726. CHOMERICS. U.S. CL. 21. (INT. CL. 9). REG. 10-26-1971.
- 922,768. CHEMCUT (STYLIZED). U.S. CL. 23. (INT. CL. 7). REG. 10-26-1971.
- 922,772. PENNLON. U.S. CL. 23. (INT. CL. 7). REG. 10-26-1971.
- 922,942. BURGERSVILLE U.S.A.. U.S. CL. 100. (INT. CL. 42). REG. 10-26-1971.
- 923,503. DICKEY-JOHN (STYLIZED). U.S. CL. 26. (INT. CL. 9). REG. 11-9-1971.
- 923,583. L'ESTANDON. U.S. CL. 47. (INT. CL. 33). REG. 11-9-1971.
- 923,617. MASTER HOSTS. U.S. CL. 100. (INT. CL. 42). REG. 11-9-1971.
- 924,012. DOLLARS FOR SCHOLARS. U.S. CLS. 102 AND 107. (INT. CLS. 36 AND 41). REG. 11-16-1971.
- 924,111. EURAND. U.S. CL. 18. (INT. CL. 5). REG. 11-23-1971.
- 924,272. MEASON. U.S. CL. 36. (INT. CL. 15). REG. 11-23-1971.
- 924,846. LUMMUS. U.S. CLS. 100, 101, 103 AND 106. (INT. CLS. 35, 37, 40 AND 42). REG. 11-30-1971.
- 925,599. AJI-SHIO. U.S. CL. 46. (INT. CL. 30). REG. 12-14-1971.
- 926,085. DOUGHBOY. U.S. CL. 12. (INT. CL. 28). REG. 12-28-1971.
- 926,775. MISCELLANEOUS DESIGN. U.S. CL. 23. (INT. CL. 7). REG. 1-11-1972.
- 927,749. CHARLOTTE. U.S. CL. 23. (INT. CL. 7). REG. 1-25-1972.
- 929,404. Q-CEL. U.S. CL. 6. (INT. CL. 1). REG. 2-22-1972.
- 931,071. SIG AND DESIGN. U.S. CLS. 12, 16 AND 22. (INT. CLS. 2, 19 AND 28). REG. 3-21-1972.
- 931,710. HYROP. U.S. CL. 23. (INT. CL. 7). REG. 4-4-1972.
- 936,318. EXPLORATORIUM. U.S. CL. 107. (INT. CL. 41). REG. 6-20-1972.
- 937,392. XTRA RANGE. U.S. CL. 13. (INT. CL. 6). REG. 7-11-1972.
- 939,055. SAFETY-KLEEN. U.S. CL. 100. (INT. CL. 42). REG. 7-25-1972.
- 942,143. FASHION BUG. U.S. CL. 101. (INT. CL. 42). REG. 8-29-1972.
- 1,128,824. FUJITEC. INT. CL. 7. (U.S. CLS. 13, 19, 21, 23, 31, 34 AND 35). REG. 1-8-1980.
- 1,135,973. XIM. INT. CL. 2. (U.S. CLS. 6, 11 AND 16). REG. 5-27-1980.
- 1,139,021. BEAVER CREEK. INT. CLS. 39 AND 41 ONLY. (U.S. CLS. 105 AND 107). REG. 8-26-1980.
- 1,139,593. QUO VADIS. INT. CL. 16. (U.S. CLS. 37 AND 38). REG. 9-16-1980.
- 1,140,833. CINTOFLEX. INT. CL. 22. (U.S. CL. 42). REG. 10-28-1980.
- 1,143,380. FAULKNER. INT. CLS. 17, 19 AND 20. (U.S. CLS. 1, 12 AND 50). REG. 12-16-1980.
- 1,145,346. PUBLIC CITIZEN AND DESIGN. INT. CL. 42. (U.S. CL. 100). REG. 12-30-1980.
- 1,146,252. FANCFOOD. INT. CLS. 29 AND 30. (U.S. CL. 46). REG. 1-20-1981.
- 1,148,823. PARASQUARE. INT. CL. 11. (U.S. CL. 34). REG. 3-24-1981.
- 1,149,728. ALTUS. INT. CL. 12. (U.S. CL. 19). REG. 3-31-1981.
- 1,149,968. SUNRISE FARMS. INT. CL. 29. (U.S. CL. 46). REG. 3-31-1981.
- 1,150,455. PREMIST. INT. CL. 21. (U.S. CL. 23). REG. 4-7-1981.
- 1,150,685. AAA FIRE, SAFETY & ALARM AND DESIGN. INT. CL. 42. (U.S. CL. 101). REG. 4-7-1981.
- 1,151,309. A GREAT LITTLE SEAFOOD PLACE. INT. CL. 42. (U.S. CL. 100). REG. 4-14-1981.
- 1,152,085. VITA-FRESH. INT. CL. 5. (U.S. CL. 18). REG. 4-28-1981.
- 1,153,856. REED & BARTON THE CLASSIC AMERICAN SILVER (STYLIZED). INT. CL. 14. (U.S. CLS. 2, 13, 23 AND 28). REG. 5-12-1981.
- 1,154,641. POWER ONE. INT. CL. 9. (U.S. CL. 21). REG. 5-19-1981.
- 1,154,854. CHARTWELL AND DESIGN. INT. CL. 16. (U.S. CL. 38). REG. 5-19-1981.
- 1,155,675. LORENZO BANFI. INT. CL. 25. (U.S. CL. 39). REG. 5-26-1981.
- 1,156,143. THE CLASSIC AMERICAN SILVER. INT. CL. 8. (U.S. CLS. 23 AND 28). REG. 6-2-1981.
- 1,156,144. REED & BARTON THE CLASSIC AMERICAN SILVER (STYLIZED). INT. CL. 8. (U.S. CLS. 23 AND 28). REG. 6-2-1981.

- 1,157,254. JOURNAL OF PHYSICAL AND CHEMICAL REFERENCE DATA. INT. CL. 16. (U.S. CL. 38). REG. 6-9-1981.
- 1,157,941. CADET. INT. CL. 11. (U.S. CL. 13). REG. 6-23-1981.
- 1,158,091. IL BISONTE AND DESIGN. INT. CL. 18. (U.S. CLS. 3 AND 41). REG. 6-23-1981.
- 1,158,329. CBC. INT. CL. 35. (U.S. CL. 101). REG. 6-23-1981.
- 1,160,673. TAYLOR CUTLERY. INT. CL. 8. (U.S. CL. 23). REG. 7-14-1981.
- 1,160,712. PI AND DESIGN. INT. CL. 9. (U.S. CL. 21). REG. 7-14-1981.
- 1,161,379. HERSHEY'S. INT. CL. 41. (U.S. CL. 107). REG. 7-14-1981.
- 1,161,489. INTERNATIONAL CLASSIFICATION INTERNATIONALE T ICCO AND DESIGN. U.S. CL. A. REG. 7-14-1981.
- 1,162,357. SOLOSIL. INT. CL. 1. (U.S. CL. 6). REG. 7-28-1981.
- 1,163,453. SEAL-MATIC. INT. CL. 7. (U.S. CL. 23). REG. 8-4-1981.
- 1,163,868. SPLASH. INT. CL. 25. (U.S. CL. 39). REG. 8-4-1981.
- 1,163,989. SI AND DESIGN. INT. CL. 31. (U.S. CL. 46). REG. 8-4-1981.
- 1,164,157. COLLECTORS COVEY AND DESIGN. INT. CL. 42. (U.S. CL. 101). REG. 8-4-1981.
- 1,164,470. WAVEMETER (STYLIZED). INT. CL. 9. (U.S. CL. 26). REG. 8-11-1981.
- 1,165,062. NESC AND DESIGN. INT. CL. 42. (U.S. CL. 100). REG. 8-11-1981.
- 1,165,261. TRAY-MATIC. INT. CL. 7. (U.S. CL. 23). REG. 8-18-1981.
- 1,165,638. REGATTA SPORT AND DESIGN. INT. CL. 25. (U.S. CL. 39). REG. 8-18-1981.
- 1,165,869. MISCELLANEOUS DESIGN. INT. CL. 41. (U.S. CL. 107). REG. 8-18-1981.
- 1,166,353. TIPROTECTOR. INT. CL. 10. (U.S. CL. 44). REG. 8-25-1981.
- 1,168,057. LRO. INT. CL. 7. (U.S. CL. 23). REG. 9-8-1981.
- 1,168,159. ACT AND DESIGN. INT. CLS. 9 AND 42. (U.S. CLS. 21 AND 100). REG. 9-8-1981.
- 1,168,192. DIGISTRIP (STYLIZED). INT. CL. 9. (U.S. CL. 26). REG. 9-8-1981.
- 1,168,433. CHEFMATE. INT. CL. 21. (U.S. CLS. 2 AND 13). REG. 9-8-1981.
- 1,168,689. SPEEDWAY AND DESIGN. INT. CL. 37. (U.S. CL. 103). REG. 9-8-1981.
- 1,168,799. LOWE'S. INT. CL. 42. (U.S. CL. 101). REG. 9-8-1981.
- 1,168,840. R AND DESIGN. INT. CL. 2. (U.S. CL. 11). REG. 9-15-1981.
- 1,168,980. SOLA. INT. CL. 9. (U.S. CL. 26). REG. 9-15-1981.
- 1,169,251. RESTAURANT HOSPITALITY. INT. CL. 16. (U.S. CL. 38). REG. 9-15-1981.
- 1,169,697. RAWHIDE. INT. CL. 42. (U.S. CL. 100). REG. 9-15-1981.
- 1,169,792. RBS 35. INT. CL. 3. (U.S. CLS. 6 AND 52). REG. 9-22-1981.
- 1,169,909. T TRI-STATE ...AROUND THE CLOCK, AROUNDTHE WORLD... AND DESIGN. INT. CL. 7. (U.S. CL. 23). REG. 9-22-1981.
- 1,169,932. PEABODY AND DESIGN. INT. CL. 9. (U.S. CL. 26). REG. 9-22-1981.
- 1,169,964. MAS-CON. INT. CL. 9. (U.S. CL. 21). REG. 9-22-1981.
- 1,170,094. ROLLITE. INT. CL. 12. (U.S. CL. 19). REG. 9-22-1981.
- 1,170,106. YAMAHA (STYLIZED). INT. CLS. 15, 18 AND 25. (U.S. CLS. 2, 3, 18, 36 AND 39). REG. 9-22-1981.
- 1,170,410. CAROLINA. INT. CL. 28. (U.S. CL. 22). REG. 9-22-1981.
- 1,170,449. SEA STAR. INT. CL. 29. (U.S. CL. 46). REG. 9-22-1981.
- 1,170,459. BRAVO. INT. CL. 30. (U.S. CL. 46). REG. 9-22-1981.
- 1,170,502. SKI DAZZLE. INT. CL. 35. (U.S. CL. 101). REG. 9-22-1981.
- 1,170,516. FACT. INT. CL. 35. (U.S. CL. 101). REG. 9-22-1981.
- 1,170,590. TEAM. INT. CL. 39. (U.S. CL. 105). REG. 9-22-1981.
- 1,170,769. GABOR. INT. CL. 25. (U.S. CL. 39). REG. 9-22-1981.
- 1,170,923. DUROFLOW (STYLIZED). INT. CL. 7. (U.S. CL. 23). REG. 9-29-1981.
- 1,171,238. RICEHULLITE. INT. CL. 17. (U.S. CL. 12). REG. 9-29-1981.
- 1,171,372. JUNIORFORM. INT. CL. 25. (U.S. CL. 39). REG. 9-29-1981.
- 1,171,442. BING CROSBY. INT. CL. 28. (U.S. CL. 50). REG. 9-29-1981.
- 1,171,451. IF LOST RELAX. INT. CL. 28. (U.S. CL. 22). REG. 9-29-1981.
- 1,171,693. ANNAPOLIS: A MUSEUM WITHOUT WALLS. INT. CL. 41. (U.S. CL. 107). REG. 9-29-1981.
- 1,171,878. GROOM AWAY GRAY. INT. CL. 3. (U.S. CL. 51). REG. 10-6-1981.
- 1,171,916. OPTIGENE. INT. CL. 5. (U.S. CL. 18). REG. 10-6-1981.
- 1,171,919. KOPHANE. INT. CL. 5. (U.S. CL. 18). REG. 10-6-1981.
- 1,171,925. HEXABRIX. INT. CL. 5. (U.S. CL. 18). REG. 10-6-1981.
- 1,172,053. TAMRAC. INT. CLS. 9 AND 18. (U.S. CLS. 3 AND 26). REG. 10-6-1981.
- 1,172,076. QUIK-ARC LONG LIFE TORCHES AND DESIGN. INT. CL. 9. (U.S. CL. 34). REG. 10-6-1981.
- 1,172,144. VALLEY (STYLIZED). INT. CLS. 11 AND 37. (U.S. CLS. 13 AND 103). REG. 10-6-1981.
- 1,172,146. MAX-FLOW UNI-SWET. INT. CL. 11. (U.S. CLS. 13 AND 31). REG. 10-6-1981.
- 1,172,156. GERBER G (STYLIZED). INT. CL. 11. (U.S. CLS. 13, 21, 23, 31 AND 34). REG. 10-6-1981.
- 1,172,166. PREVOST (STYLIZED). INT. CL. 12. (U.S. CL. 19). REG. 10-6-1981.
- 1,172,197. MISCELLANEOUS DESIGN. INT. CL. 14. (U.S. CL. 28). REG. 10-6-1981.
- 1,172,203. GIRL SCOUTS AND DESIGN. INT. CL. 16. (U.S. CL. 38). REG. 10-6-1981.
- 1,172,213. NU ART AND DESIGN. INT. CL. 16. (U.S. CL. 38). REG. 10-6-1981.
- 1,172,215. ANGEL SOFT. INT. CL. 16. (U.S. CL. 37). REG. 10-6-1981.
- 1,172,277. FOLD-A-WAY AND DESIGN. INT. CL. 19. (U.S. CL. 12). REG. 10-6-1981.
- 1,172,295. MAXIFLEX. INT. CL. 20. (U.S. CL. 32). REG. 10-6-1981.
- 1,172,316. SKALNY. INT. CL. 20. (U.S. CL. 2). REG. 10-6-1981.
- 1,172,341. LANA GATTO TOLLEGNO DAL 1900 AND DESIGN. INT. CLS. 23, 24 AND 25. (U.S. CLS. 39, 42 AND 43). REG. 10-6-1981.
- 1,172,343. SONTEX. INT. CL. 24. (U.S. CL. 42). REG. 10-6-1981.
- 1,172,478. SEA DYKE BRAND AND DESIGN. INT. CL. 30. (U.S. CL. 46). REG. 10-6-1981.
- 1,172,500. ENERGIZER 20. INT. CL. 31. (U.S. CL. 46). REG. 10-6-1981.
- 1,172,549. PLAN TODAY FOR TOMORROW. IT IS YOUR FUTURE.. INT. CL. 36. (U.S. CL. 102). REG. 10-6-1981.
- 1,172,557. AIG. INT. CL. 36. (U.S. CL. 102). REG. 10-6-1981.
- 1,172,589. DELIVEREX. INT. CL. 39. (U.S. CL. 107). REG. 10-6-1981.
- 1,172,629. MARCO'S AND DESIGN. INT. CL. 42. (U.S. CL. 101). REG. 10-6-1981.
- 1,172,748. GEN-VIS. INT. CL. 1. (U.S. CL. 6). REG. 10-13-1981.
- 1,172,795. EUCERIN. INT. CL. 3. (U.S. CL. 51). REG. 10-13-1981.
- 1,172,837. BERRY METAL AND DESIGN. INT. CLS. 6, 7 AND 11. (U.S. CLS. 13, 14, 19, 21, 23, 31, 34 AND 35). REG. 10-13-1981.
- 1,172,929. HBM AND DESIGN. INT. CL. 9. (U.S. CLS. 21, 26 AND 34). REG. 10-13-1981.
- 1,172,938. MISCELLANEOUS DESIGN. INT. CLS. 9, 18 AND 34. (U.S. CLS. 3, 8 AND 26). REG. 10-13-1981.
- 1,172,977. ZOOK. INT. CL. 9. (U.S. CL. 26). REG. 10-13-1981.
- 1,173,004. OPMI. INT. CL. 9. (U.S. CL. 26). REG. 10-13-1981.
- 1,173,041. UHLSPORT AND DESIGN. INT. CLS. 10, 25 AND 28. (U.S. CLS. 22, 39 AND 44). REG. 10-13-1981.
- 1,173,094. DRY-O-TRON. INT. CL. 11. (U.S. CL. 34). REG. 10-13-1981.
- 1,173,124. GIB'SEA. INT. CL. 12. (U.S. CL. 19). REG. 10-13-1981.
- 1,173,155. FARMWEEK (STYLIZED). INT. CL. 16. (U.S. CL. 38). REG. 10-13-1981.
- 1,173,166. CRAYOLA. INT. CL. 16. (U.S. CLS. 16, 29 AND 37). REG. 10-13-1981.
- 1,173,192. GLIDDEN AND DESIGN. INT. CL. 16. (U.S. CL. 29). REG. 10-13-1981.
- 1,173,297. MAXI-MISER (STYLIZED). INT. CL. 21. (U.S. CL. 3). REG. 10-13-1981.
- 1,173,317. THE WINNER. INT. CL. 21. (U.S. CL. 3). REG. 10-13-1981.

- 1,173,398. MEDICO M (STYLIZED). INT. CL. 25. (U.S. CL. 39). REG. 10-13-1981.
- 1,173,508. CHEF'S SPECIAL. INT. CL. 30. (U.S. CL. 46). REG. 10-13-1981.
- 1,173,561. INMAGIC. INT. CL. 35. (U.S. CL. 101). REG. 10-13-1981.
- 1,173,612. K AND DESIGN. INT. CL. 37. (U.S. CL. 103). REG. 10-13-1981.
- 1,173,637. PARADISE STREAM. INT. CLS. 39, 41 AND 42. (U.S. CLS. 100, 101, 105 AND 107). REG. 10-13-1981.
- 1,173,666. THE PATHWORK. INT. CL. 41. (U.S. CL. 107). REG. 10-13-1981.
- 1,173,706. STUART ANDERSON'S BLACK ANGUS/CATTLE COMPANY RESTAURANTS. INT. CL. 42. (U.S. CL. 100). REG. 10-13-1981.
- 1,173,718. PRINCESS HOTELS. INT. CL. 42. (U.S. CL. 100). REG. 10-13-1981.
- 1,173,777. BAYSILONE. INT. CL. 1. (U.S. CL. 6). REG. 10-20-1981.
- 1,173,902. FIRE KING. INT. CL. 6. (U.S. CL. 25). REG. 10-20-1981.
- 1,173,973. CRITERIA. INT. CL. 9. (U.S. CLS. 21 AND 34). REG. 10-20-1981.
- 1,173,977. MELDAS. INT. CL. 9. (U.S. CL. 26). REG. 10-20-1981.
- 1,174,281. THERMALSUEDE. INT. CL. 24. (U.S. CL. 42). REG. 10-20-1981.
- 1,174,285. DIVIDEND DOZEN. INT. CL. 24. (U.S. CL. 42). REG. 10-20-1981.
- 1,174,296. SUNSET. INT. CL. 24. (U.S. CL. 42). REG. 10-20-1981.
- 1,174,377. GODZILLA. INT. CL. 28. (U.S. CLS. 22, 23, 38 AND 50). REG. 10-20-1981.
- 1,174,443. DSA. INT. CL. 31. (U.S. CL. 46). REG. 10-20-1981.
- 1,174,566. COVE HAVEN. INT. CLS. 39, 41 AND 42. (U.S. CLS. 100, 101, 105 AND 107). REG. 10-20-1981.
- 1,174,898. CASTLE AND DESIGN. INT. CL. 9. (U.S. CL. 26). REG. 10-27-1981.
- 1,175,433. JOHN T'S BROWN GOLD. INT. CL. 34. (U.S. CL. 17). REG. 10-27-1981.
- 1,175,540. RISTORANTE PRIMAVERA AND DESIGN. INT. CL. 42. (U.S. CL. 100). REG. 10-27-1981.
- 1,175,559. DRI-EAR. INT. CL. 5. (U.S. CL. 18). REG. 10-27-1981.
- 1,175,572. GAGGENAU. INT. CL. 11. (U.S. CLS. 13, 31 AND 34). REG. 10-27-1981.
- 1,175,821. LOOPCO. INT. CL. 7. (U.S. CLS. 23 AND 26). REG. 11-3-1981.
- 1,175,881. BI-PIN. INT. CL. 9. (U.S. CL. 21). REG. 11-3-1981.
- 1,175,926. EICHEN AND DESIGN. INT. CL. 9. (U.S. CL. 21). REG. 11-3-1981.
- 1,176,320. YA AND DESIGN. INT. CL. 25. (U.S. CL. 39). REG. 11-3-1981.
- 1,176,480. PRIVEST. INT. CL. 36. (U.S. CL. 102). REG. 11-3-1981.
- 1,176,485. PLANNED FUTURES. INT. CL. 36. (U.S. CL. 102). REG. 11-3-1981.
- 1,176,566. SEA SEMESTER. INT. CL. 41. (U.S. CL. 107). REG. 11-3-1981.
- 1,176,620. BRISTOL BAR & GRILLE. INT. CL. 42. (U.S. CL. 100). REG. 11-3-1981.
- 1,176,810. ARESSA (STYLIZED). INT. CLS. 6, 14 AND 26. (U.S. CLS. 13 AND 28). REG. 11-10-1981.
- 1,177,058. WATERJET. INT. CL. 10. (U.S. CLS. 13 AND 44). REG. 11-10-1981.
- 1,177,155. AMERICAN JOURNAL OF OPHTHALMOLOGY. INT. CL. 16. (U.S. CL. 38). REG. 11-10-1981.
- 1,177,506. BUCKBOARD. INT. CL. 29. (U.S. CL. 46). REG. 11-10-1981.
- 1,177,591. SILVER SERVICE. INT. CL. 37. (U.S. CL. 103). REG. 11-10-1981.
- 1,177,592. GOLD CARE. INT. CL. 37. (U.S. CL. 103). REG. 11-10-1981.
- 1,177,618. MISCELLANEOUS DESIGN. INT. CLS. 41 AND 42. (U.S. CLS. 100 AND 107). REG. 11-10-1981.
- 1,177,626. ECAP (STYLIZED). INT. CL. 41. (U.S. CL. 107). REG. 11-10-1981.
- 1,177,754. CHEM-FUEL. INT. CL. 4. (U.S. CL. 15). REG. 11-17-1981.
- 1,178,636. FOR A CARD THAT'S A GIFT. INT. CL. 42. (U.S. CL. 101). REG. 11-17-1981.
- 1,178,682. QUICK LOAD. INT. CLS. 7 AND 9. (U.S. CLS. 23 AND 26). REG. 11-17-1981.
- 1,178,685. BUFFER PAK. INT. CL. 5. (U.S. CL. 18). REG. 11-17-1981.
- 1,178,947. OPTIMA. INT. CL. 9. (U.S. CLS. 23 AND 26). REG. 11-24-1981.
- 1,179,143. PRESLYN. INT. CL. 17. (U.S. CL. 1). REG. 11-24-1981.
- 1,179,144. ESTRALYN. INT. CL. 17. (U.S. CL. 1). REG. 11-24-1981.
- 1,179,200. TAP. INT. CL. 20. (U.S. CL. 32). REG. 11-24-1981.
- 1,179,465. LENOX. INT. CL. 35. (U.S. CL. 101). REG. 11-24-1981.
- 1,179,478. MISCELLANEOUS DESIGN. INT. CL. 36. (U.S. CL. 102). REG. 11-24-1981.
- 1,179,965. ELIPAR. INT. CL. 10. (U.S. CL. 44). REG. 12-1-1981.
- 1,179,985. EASTMAN. INT. CL. 11. (U.S. CL. 13). REG. 12-1-1981.
- 1,180,179. PLEKO. INT. CL. 19. (U.S. CL. 12). REG. 12-1-1981.
- 1,180,254. FORTREL. INT. CL. 23. (U.S. CL. 43). REG. 12-1-1981.
- 1,180,255. SUSSEX. INT. CL. 24. (U.S. CL. 42). REG. 12-1-1981.
- 1,180,439. CEGOS. INT. CLS. 35 AND 41. (U.S. CLS. 101 AND 107). REG. 12-1-1981.
- 1,180,983. PROSPLINTS. INT. CL. 10. (U.S. CL. 44). REG. 12-8-1981.
- 1,181,235. DOUBLE L. INT. CL. 25. (U.S. CL. 39). REG. 12-8-1981.
- 1,181,545. CNS. INT. CLS. 41 AND 42. (U.S. CLS. 100 AND 107). REG. 12-8-1981.
- 1,181,915. LITE MATE. INT. CL. 9. (U.S. CL. 21). REG. 12-15-1981.
- 1,181,974. RICH-MAR. INT. CL. 10. (U.S. CL. 44). REG. 12-15-1981.
- 1,182,011. AIRSTREAM EXCELLA. INT. CL. 12. (U.S. CL. 19). REG. 12-15-1981.
- 1,182,501. R (STYLIZED). INT. CL. 42. (U.S. CL. 100). REG. 12-15-1981.
- 1,183,102. KICK OFF. INT. CL. 28. (U.S. CL. 22). REG. 12-22-1981.
- 1,183,193. SPORTS AMERICA AND DESIGN. INT. CLS. 35 AND 41. (U.S. CLS. 101 AND 107). REG. 12-22-1981.
- 1,183,296. FLAP JACK SHACK. INT. CL. 42. (U.S. CL. 100). REG. 12-22-1981.
- 1,183,362. TIGER HAIR. INT. CL. 1. (U.S. CL. 1). REG. 12-29-1981.
- 1,183,801. HANDI-PRESS (STYLIZED). INT. CL. 20. (U.S. CL. 32). REG. 12-29-1981.
- 1,183,840. RAIN-NO-STAIN. INT. CL. 24. (U.S. CL. 42). REG. 12-29-1981.
- 1,183,855. HACKY SACK. INT. CLS. 25, 28 AND 41. (U.S. CLS. 22, 39 AND 107). REG. 12-29-1981.
- 1,183,929. SQUIRREL NUTKIN. INT. CL. 28. (U.S. CL. 22). REG. 12-29-1981.
- 1,184,195. LE SPORTSAC AND DESIGN. INT. CL. 42. (U.S. CL. 101). REG. 12-29-1981.
- 1,184,514. HSP HIGHWAY SAFETY PRODUCTS (STYLIZED). INT. CL. 9. (U.S. CL. 21). REG. 1-5-1982.
- 1,184,764. AQUASCUTUM. INT. CL. 18. (U.S. CLS. 3 AND 41). REG. 1-5-1982.
- 1,185,389. PROBIOCIN. INT. CL. 5. (U.S. CL. 18). REG. 1-12-1982.
- 1,185,687. JEMIMA PUDDLE-DUCK. INT. CL. 15. (U.S. CL. 36). REG. 1-12-1982.
- 1,185,896. BAXTER STATE PARKA (STYLIZED). INT. CL. 25. (U.S. CL. 39). REG. 1-12-1982.
- 1,186,341. MARAPLEX. INT. CL. 4. (U.S. CL. 15). REG. 1-19-1982.
- 1,188,037. NIELSEN HOMEVIDEO INDEX. INT. CL. 35. (U.S. CL. 101). REG. 1-26-1982.
- 1,188,649. DELCHEM AND DESIGN. INT. CL. 17. (U.S. CLS. 6 AND 12). REG. 2-2-1982.
- 1,188,682. SPACE STATION. INT. CL. 20. (U.S. CL. 32). REG. 2-2-1982.
- 1,188,755. ENDURA. INT. CL. 27. (U.S. CL. 42). REG. 2-2-1982.
- 1,188,784. BIG MOUTH SINGERS. INT. CL. 28. (U.S. CL. 22). REG. 2-2-1982.
- 1,188,853. DAIRY DELITE AND DESIGN. INT. CL. 30. (U.S. CL. 46). REG. 2-2-1982.
- 1,188,944. IRISH AND DESIGN. INT. CL. 37. (U.S. CL. 103). REG. 2-2-1982.
- 1,189,736. TWIST POP. INT. CL. 6. (U.S. CL. 13). REG. 2-16-1982.

- 1,190,389. RING 5. INT. CL. 3 ONLY. (U.S. CLS. 6, 51 AND 52). REG. 2-23-1982.
- 1,190,773. SIROCCO. INT. CL. 25. (U.S. CL. 39). REG. 2-23-1982.
- 1,190,791. LINDSEY ROSCOE. INT. CL. 25. (U.S. CL. 39). REG. 2-23-1982.
- 1,191,055. LANACORT. INT. CL. 5. (U.S. CL. 18). REG. 3-2-1982.
- 1,191,934. THIXO-SEALANT. INT. CL. 1. (U.S. CL. 5). REG. 3-16-1982.
- 1,192,038. KLOPP. INT. CL. 9. (U.S. CL. 26). REG. 3-16-1982.
- 1,192,052. F AND DESIGN. INT. CL. 10. (U.S. CL. 44). REG. 3-16-1982.
- 1,192,113. AQUA-MEND. INT. CL. 17. (U.S. CL. 12). REG. 3-16-1982.
- 1,192,840. POLLYANNA. INT. CL. 30. (U.S. CL. 46). REG. 3-30-1982.
- 1,196,032. VALFOR. INT. CL. 1. (U.S. CL. 6). REG. 5-25-1982.
- 1,197,782. BARATRON. INT. CL. 9. (U.S. CL. 26). REG. 6-15-1982.
- 1,201,329. A (STYLIZED). INT. CL. 30. (U.S. CL. 46). REG. 7-13-1982.
- 1,202,276. KODIAK. INT. CL. 34. (U.S. CL. 17). REG. 7-20-1982.
- 1,205,931. A SYMBOL OF ACHIEVEMENT IN THE FOUNDRY INDUSTRY AND DESIGN. INT. CLS. 6 AND 7. (U.S. CLS. 2, 12, 13, 14, 23, 25 AND 50). REG. 8-24-1982.
- 1,207,703. FASHION FINISH. INT. CL. 1. (U.S. CL. 6). REG. 9-14-1982.
- 1,208,354. PURE-LINE. INT. CL. 17. (U.S. CL. 13). REG. 9-14-1982.
- 1,209,484. ALLERDERM. INT. CL. 5. (U.S. CL. 18). REG. 9-21-1982.
- 1,210,134. FASTSET. INT. CL. 1. (U.S. CL. 1). REG. 9-21-1982.
- 1,210,932. WOR-CON (STYLIZED). INT. CL. 40. (U.S. CL. 106). REG. 9-28-1982.
- 1,568,152. GENTRAN:PLUS. INT. CL. 9. (U.S. CL. 38). REG. 11-28-1989.
- 1,568,759. COFFEE OF COLOMBIA 70 KILOS NETO AND DESIGN. INT. CL. 35. (U.S. CLS. 100, 101 AND 102). REG. 11-28-1989.
- 1,586,875. MISCELLANEOUS DESIGN. INT. CL. 25. (U.S. CL. 39). REG. 3-13-1990.
- 1,587,655. MEGA-T-UNISOFT. INT. CL. 12. (U.S. CL. 35). REG. 3-20-1990.
- 1,599,775. MERIDIAN. INT. CL. 30. (U.S. CL. 46). REG. 6-5-1990.
- 1,599,944. CASTLE ROCK ENTERTAINMENT AND DESIGN. INT. CL. 41. (U.S. CLS. 101 AND 107). REG. 6-5-1990.
- 1,606,547. MARCELLO'S. INT. CL. 29. (U.S. CL. 46). REG. 7-17-1990.
- 1,607,697. MAGICAL STUDIO VACATIONS AND DESIGN. INT. CL. 39. (U.S. CLS. 100 AND 105). REG. 7-24-1990.
- 1,607,730. NOTIUNO AND DESIGN. INT. CL. 41. (U.S. CL. 107). REG. 7-24-1990.
- 1,609,686. IMPERIALINE. INT. CL. 11. (U.S. CL. 34). REG. 8-14-1990.
- 1,612,648. MISCELLANEOUS DESIGN. INT. CL. 6. (U.S. CL. 13). REG. 9-11-1990.
- 1,612,697. ENFOQUE A LA FAMILIA AND DESIGN. INT. CLS. 9, 16 AND 41. (U.S. CLS. 2, 5, 21, 22, 23, 26, 29, 36, 37, 38, 50, 100, 101 AND 107). REG. 9-11-1990.
- 1,612,800. SAFETY SHOULDERS. INT. CL. 9. (U.S. CL. 26). REG. 9-11-1990.
- 1,618,411. GS (STYLIZED). INT. CL. 6. (U.S. CLS. 13 AND 14). REG. 10-23-1990.
- 1,621,113. MARIO VALENTINO. INT. CLS. 14 AND 26. (U.S. CLS. 2, 27, 28, 37, 39, 40, 42 AND 50). REG. 11-6-1990.
- 1,623,948. THE CALIFORNIA RAISINS. INT. CL. 35. (U.S. CL. 101). REG. 11-20-1990.
- 1,630,356. EVERGREEN AND DESIGN. INT. CL. 39. (U.S. CL. 105). REG. 1-1-1991.
- 1,630,776. HERITAGE CUSTOM TRAILERS. INT. CL. 12. (U.S. CL. 19). REG. 1-8-1991.
- 1,631,694. SHOE BE BABY (STYLIZED). INT. CL. 25. (U.S. CL. 39). REG. 1-15-1991.
- 1,632,840. ECO-FRESH AND DESIGN. INT. CLS. 3 AND 37. (U.S. CLS. 6, 52 AND 103). REG. 1-29-1991.
- 1,636,557. LOCKERBOX AND DESIGN. INT. CL. 20. (U.S. CLS. 2 AND 50). REG. 2-26-1991.
- 1,637,727. PRONTO COMBO. INT. CL. 30. (U.S. CL. 46). REG. 3-12-1991.
- 1,637,865. MISCELLANEOUS DESIGN. INT. CL. 41. (U.S. CL. 107). REG. 3-12-1991.
- 1,638,987. INNERVATOR. INT. CL. 10. (U.S. CL. 44). REG. 3-26-1991.
- 1,639,234. LIGHTSHIP. INT. CL. 32. (U.S. CL. 48). REG. 3-26-1991.
- 1,639,429. VEGGIE BEEF DOGS. INT. CL. 29. (U.S. CL. 46). REG. 3-26-1991.
- 1,639,556. POMS. INT. CL. 9. (U.S. CL. 38). REG. 4-2-1991.
- 1,639,673. TOVEX BREAKRITE 1. INT. CL. 13. (U.S. CL. 9). REG. 4-2-1991.
- 1,640,415. SHARK. INT. CL. 14. (U.S. CL. 27). REG. 4-9-1991.
- 1,640,429. PHILLIPS AND DESIGN. INT. CLS. 16, 35 AND 36. (U.S. CLS. 2, 37, 38, 101 AND 102). REG. 4-9-1991.
- 1,640,495. GR-FG. INT. CL. 19. (U.S. CL. 12). REG. 4-9-1991.
- 1,640,589. SOCKS GALORE & MORE AND DESIGN. INT. CL. 25. (U.S. CL. 39). REG. 4-9-1991.
- 1,640,846. BEVERLY HILLS WEIGHT LOSS CLINICS AND DESIGN. INT. CL. 42. (U.S. CL. 100). REG. 4-9-1991.
- 1,640,869. NALS AND DESIGN. INT. CL. 42. (U.S. CL. 100). REG. 4-9-1991.
- 1,641,012. LABIOSAN. INT. CL. 5. (U.S. CL. 18). REG. 4-16-1991.
- 1,641,686. SOCKS GALORE AND DESIGN. INT. CL. 42. (U.S. CL. 101). REG. 4-16-1991.
- 1,642,070. MEDIAMAP. INT. CL. 16. (U.S. CL. 38). REG. 4-23-1991.
- 1,642,837. BABYLON. INT. CL. 20. (U.S. CL. 32). REG. 4-30-1991.
- 1,643,667. THE PURISTS. INT. CL. 24. (U.S. CL. 42). REG. 5-7-1991.
- 1,645,803. OCTI-CUT AND DESIGN. INT. CL. 7. (U.S. CL. 23). REG. 5-28-1991.
- 1,645,920. LAMB. INT. CL. 12. (U.S. CL. 19). REG. 5-28-1991.
- 1,646,402. BRIGADE'S UNIQUE 110% MISTAKEPROOF MONEYBACK GUARANTEE. INT. CL. 42. (U.S. CL. 101). REG. 5-28-1991.
- 1,646,931. MISCELLANEOUS DESIGN. INT. CL. 28. (U.S. CL. 22). REG. 6-4-1991.
- 1,647,928. SIGNMAKER. INT. CL. 9. (U.S. CLS. 23 AND 26). REG. 6-18-1991.
- 1,650,551. LASS. INT. CL. 5. (U.S. CL. 18). REG. 7-16-1991.
- 1,652,119. MUSTARD BUSTER. INT. CL. 5. (U.S. CL. 6). REG. 7-30-1991.
- 1,652,651. SHOOT-THE-BULL 3 ON 3 ROUNDBALL CLASSIC. INT. CL. 41. (U.S. CL. 107). REG. 7-30-1991.
- 1,652,813. OZASOL. INT. CLS. 1 AND 16 ONLY. (U.S. CLS. 1, 2, 5, 6, 10, 22, 23, 26, 29, 37, 38, 46 AND 50). REG. 8-6-1991.
- 1,653,680. EQUINOX. INT. CL. 20. (U.S. CLS. 13 AND 32). REG. 8-13-1991.
- 1,653,894. BREATHE-EASY AIR DUCT CLEANING AND DESIGN. INT. CL. 37. (U.S. CL. 103). REG. 8-13-1991.
- 1,654,161. IRON BODIES. INT. CL. 5. (U.S. CL. 18). REG. 8-20-1991.
- 1,654,355. HITECH. INT. CL. 24. (U.S. CL. 42). REG. 8-20-1991.
- 1,654,419. F-O-L-K-T-A-I-L-S THE MONKEY'S TALE AND DESIGN. INT. CL. 28. (U.S. CL. 22). REG. 8-20-1991.
- 1,655,035. GRAND PRIX. INT. CL. 37. (U.S. CL. 103). REG. 8-27-1991.
- 1,656,140. EASTECH. INT. CL. 9. (U.S. CL. 26). REG. 9-10-1991.
- 1,656,295. PORTMEIRION. INT. CL. 24. (U.S. CL. 42). REG. 9-10-1991.
- 1,656,300. SCANDIA WOODS. INT. CL. 25. (U.S. CL. 39). REG. 9-10-1991.
- 1,656,676. ADVISOR. INT. CL. 9. (U.S. CL. 21). REG. 9-10-1991.
- 1,657,116. SOLE PACK. INT. CL. 5. (U.S. CL. 18). REG. 9-17-1991.
- 1,657,167. DOLER AND DESIGN. INT. CL. 7. (U.S. CL. 23). REG. 9-17-1991.
- 1,657,241. DIG DEEPER. INT. CL. 9. (U.S. CL. 38). REG. 9-17-1991.
- 1,657,330. CROSSROADS. INT. CL. 12. (U.S. CL. 19). REG. 9-17-1991.

- 1,657,352. MISCELLANEOUS DESIGN. INT. CLS. 16, 18, 21, 24, 25 AND 26. (U.S. CLS. 2, 3, 30, 37, 38, 39, 40, 42 AND 50). REG. 9-17-1991.
- 1,657,431. THORCO. INT. CL. 20. (U.S. CL. 32). REG. 9-17-1991.
- 1,657,537. ECONO BAKE. INT. CL. 29. (U.S. CL. 46). REG. 9-17-1991.
- 1,657,907. UNIVAL. INT. CL. 1. (U.S. CLS. 1 AND 6). REG. 9-24-1991.
- 1,658,044. COMPACT 600. INT. CL. 9. (U.S. CL. 21). REG. 9-24-1991.
- 1,658,118. CUSTOM RX. INT. CL. 10. (U.S. CL. 44). REG. 9-24-1991.
- 1,658,157. RAVEN'S HOARD. INT. CL. 14. (U.S. CL. 28). REG. 9-24-1991.
- 1,658,208. COLLAGE (STYLIZED). INT. CL. 16. (U.S. CL. 38). REG. 9-24-1991.
- 1,658,210. CHAMBERVISION. INT. CL. 16. (U.S. CL. 38). REG. 9-24-1991.
- 1,658,222. BILA AND DESIGN. INT. CLS. 18 AND 25. (U.S. CLS. 3 AND 39). REG. 9-24-1991.
- 1,658,286. DELONG USA AND DESIGN. INT. CL. 25. (U.S. CL. 39). REG. 9-24-1991.
- 1,658,344. CHEF APPROVED. INT. CL. 29. (U.S. CL. 46). REG. 9-24-1991.
- 1,658,377. SWEET DREAMS. INT. CL. 30. (U.S. CL. 46). REG. 9-24-1991.
- 1,658,513. MISCELLANEOUS DESIGN. INT. CL. 36. (U.S. CLS. 101 AND 102). REG. 9-24-1991.
- 1,658,544. CAROLINA KIDS HEALTH NETWORK AND DESIGN. INT. CL. 41. (U.S. CL. 107). REG. 9-24-1991.
- 1,658,571. COMPADRES AND DESIGN. INT. CL. 42. (U.S. CL. 100). REG. 9-24-1991.
- 1,658,643. FACSYS. INT. CL. 9. (U.S. CL. 38). REG. 9-24-1991.
- 1,658,658. WEDJETS. INT. CL. 10. (U.S. CL. 44). REG. 9-24-1991.
- 1,658,781. THIN & TRIM. INT. CL. 5. (U.S. CL. 18). REG. 10-1-1991.
- 1,658,811. ANOCAST. INT. CL. 7. (U.S. CL. 23). REG. 10-1-1991.
- 1,658,849. FISHER-PRICE AND DESIGN. INT. CLS. 9, 11, 12, 16, 18, 20, 21, 24 AND 28 ONLY. (U.S. CLS. 1, 2, 3, 5, 13, 19, 21, 22, 23, 26, 29, 32, 34, 37, 38, 41, 42 AND 50). REG. 10-1-1991.
- 1,658,855. LASERGUIDE. INT. CL. 9. (U.S. CLS. 26 AND 38). REG. 10-1-1991.
- 1,658,883. 5065. INT. CL. 9. (U.S. CL. 26). REG. 10-1-1991.
- 1,658,885. 5018. INT. CL. 9. (U.S. CL. 26). REG. 10-1-1991.
- 1,658,886. 1090. INT. CL. 9. (U.S. CL. 26). REG. 10-1-1991.
- 1,658,899. 5028. INT. CL. 9. (U.S. CL. 26). REG. 10-1-1991.
- 1,658,900. 5012. INT. CL. 9. (U.S. CL. 26). REG. 10-1-1991.
- 1,658,904. FORMEJECT (STYLIZED). INT. CL. 10. (U.S. CL. 44). REG. 10-1-1991.
- 1,658,934. LESLIE'S (STYLIZED). INT. CL. 14. (U.S. CL. 28). REG. 10-1-1991.
- 1,658,946. RITE - WRAP. INT. CL. 16. (U.S. CL. 37). REG. 10-1-1991.
- 1,658,948. PRESTIGE SERIES. INT. CL. 16. (U.S. CL. 38). REG. 10-1-1991.
- 1,658,987. D-FENDERS (STYLIZED). INT. CL. 20. (U.S. CLS. 32 AND 50). REG. 10-1-1991.
- 1,659,080. SPARTAN. INT. CLS. 35 AND 42. (U.S. CLS. 100 AND 101). REG. 10-1-1991.
- 1,659,081. THE CHICAGO GROUP INC.. INT. CL. 35. (U.S. CL. 101). REG. 10-1-1991.
- 1,659,098. KIS NOTIFICATION SERVICE. INT. CLS. 36 AND 42. (U.S. CLS. 100, 101 AND 102). REG. 10-1-1991.
- 1,659,141. JONATHON RUSH. INT. CL. 41. (U.S. CL. 107). REG. 10-1-1991.
- 1,659,176. DEEP BLUE VISIONS. INT. CL. 42. (U.S. CLS. 100 AND 101). REG. 10-1-1991.
- 1,659,190. MICR. INT. CL. 42. (U.S. CL. 100). REG. 10-1-1991.
- 1,659,205. FERRICLEAR. INT. CL. 1. (U.S. CL. 6). REG. 10-1-1991.
- 1,659,208. CRANACTIN. INT. CL. 5. (U.S. CL. 18). REG. 10-1-1991.
- 1,659,247. SMART MODULE. INT. CL. 36. (U.S. CL. 102). REG. 10-1-1991.
- 1,659,284. ENVIRONMENTAL PACKAGING TECHNOLOGIES. INT. CL. 35. (U.S. CL. 101). REG. 10-1-1991.
- 1,659,291. BIG GIG. INT. CL. 41. (U.S. CL. 107). REG. 10-1-1991.
- 1,659,315. VYNATHENE. INT. CL. 1. (U.S. CL. 6). REG. 10-8-1991.
- 1,659,351. LORD & MAYFAIR AND DESIGN. INT. CLS. 3, 21, 23 AND 25. (U.S. CLS. 29, 39, 43, 51 AND 52). REG. 10-8-1991.
- 1,659,365. STRIPIT25. INT. CL. 3. (U.S. CL. 52). REG. 10-8-1991.
- 1,659,380. BARRICAID. INT. CL. 5. (U.S. CL. 44). REG. 10-8-1991.
- 1,659,381. MAXICAP. INT. CL. 5. (U.S. CLS. 6 AND 44). REG. 10-8-1991.
- 1,659,392. REPEL'M. INT. CL. 5. (U.S. CL. 6). REG. 10-8-1991.
- 1,659,405. MEDI-SEAL. INT. CL. 5. (U.S. CL. 44). REG. 10-8-1991.
- 1,659,428. XT. INT. CL. 6. (U.S. CL. 13). REG. 10-8-1991.
- 1,659,442. NIKKO (STYLIZED). INT. CL. 7. (U.S. CLS. 19, 23 AND 35). REG. 10-8-1991.
- 1,659,459. PEGASUS. INT. CL. 7. (U.S. CL. 23). REG. 10-8-1991.
- 1,659,492. MICRO-GLOSS. INT. CL. 9. (U.S. CLS. 21, 23, 26, 36 AND 38). REG. 10-8-1991.
- 1,659,499. INFO GRAPHICS (STYLIZED). INT. CL. 9. (U.S. CLS. 21 AND 26). REG. 10-8-1991.
- 1,659,514. THRUPUT MANAGER. INT. CL. 9. (U.S. CL. 38). REG. 10-8-1991.
- 1,659,554. MEGASCREEN. INT. CL. 9. (U.S. CLS. 26 AND 38). REG. 10-8-1991.
- 1,659,591. TRIFAB (STYLIZED). INT. CL. 9. (U.S. CLS. 26 AND 39). REG. 10-8-1991.
- 1,659,714. SPARKLERS. INT. CL. 16. (U.S. CL. 38). REG. 10-8-1991.
- 1,659,718. YENDIE WILDCRITTER. INT. CL. 16. (U.S. CL. 38). REG. 10-8-1991.
- 1,659,752. LAPINUS. INT. CL. 17. (U.S. CLS. 35 AND 50). REG. 10-8-1991.
- 1,659,823. BUFFS. INT. CL. 25. (U.S. CLS. 22 AND 39). REG. 10-8-1991.
- 1,659,844. BUSHWACKER. INT. CL. 25. (U.S. CLS. 22 AND 39). REG. 10-8-1991.
- 1,659,911. SALUTAR. INT. CL. 29. (U.S. CL. 46). REG. 10-8-1991.
- 1,659,914. JAILHOUSE CAVIAR. INT. CL. 29. (U.S. CL. 46). REG. 10-8-1991.
- 1,659,921. GEBHARDT SINCE 1896 AND DESIGN. INT. CLS. 29 AND 30. (U.S. CL. 46). REG. 10-8-1991.
- 1,659,935. THE COUNTRY HEN. INT. CL. 29. (U.S. CL. 46). REG. 10-8-1991.
- 1,659,944. HARVEST DELIGHT (STYLIZED). INT. CL. 30. (U.S. CL. 46). REG. 10-8-1991.
- 1,659,963. CHALET DESSERTS AND DESIGN. INT. CL. 30. (U.S. CL. 46). REG. 10-8-1991.
- 1,659,981. RENK. INT. CL. 31. (U.S. CL. 1). REG. 10-8-1991.
- 1,659,982. GREEN VELVET. INT. CL. 31. (U.S. CL. 1). REG. 10-8-1991.
- 1,659,990. GTA FEEDS AND DESIGN. INT. CL. 31. (U.S. CL. 46). REG. 10-8-1991.
- 1,659,992. DRISCOLL'S AND DESIGN. INT. CL. 31. (U.S. CL. 46). REG. 10-8-1991.
- 1,660,013. LACRIMAROSA. INT. CL. 33. (U.S. CL. 47). REG. 10-8-1991.
- 1,660,031. ERNST & YOUNG. INT. CLS. 35 AND 36. (U.S. CLS. 101 AND 102). REG. 10-8-1991.
- 1,660,037. MISCELLANEOUS DESIGN. INT. CL. 35. (U.S. CL. 101). REG. 10-8-1991.
- 1,660,076. CAPS. INT. CL. 36. (U.S. CLS. 101 AND 102). REG. 10-8-1991.
- 1,660,099. GRASSLANDS. INT. CL. 37. (U.S. CL. 103). REG. 10-8-1991.
- 1,660,102. PRIMETIME PLAN. INT. CL. 38. (U.S. CLS. 100, 101 AND 104). REG. 10-8-1991.
- 1,660,104. DOWN TO EARTH SATELLITE SOLUTIONS. INT. CL. 38. (U.S. CL. 104). REG. 10-8-1991.
- 1,660,121. ONE HOUR MOTOPHOTO & PORTRAIT STUDIO. INT. CL. 40. (U.S. CL. 106). REG. 10-8-1991.
- 1,660,123. SMITH & WESSON PERFORMANCE CENTER. INT. CL. 40. (U.S. CL. 106). REG. 10-8-1991.
- 1,660,153. MISCELLANEOUS DESIGN. INT. CL. 41. (U.S. CL. 107). REG. 10-8-1991.
- 1,660,154. MISCELLANEOUS DESIGN. INT. CL. 41. (U.S. CL. 107). REG. 10-8-1991.
- 1,660,156. M AND DESIGN. INT. CL. 41. (U.S. CL. 107). REG. 10-8-1991.
- 1,660,176. HR AND DESIGN. INT. CL. 42. (U.S. CL. 100). REG. 10-8-1991.

- 1,660,198. K & K FLYFISHERS' SUPPLY AND DESIGN. INT. CL. 42. (U.S. CL. 101). REG. 10-8-1991.
- 1,660,202. WOLFFY'S ROCKIN' 50'S HAMBURGERS AND DESIGN. INT. CL. 42. (U.S. CL. 100). REG. 10-8-1991.
- 1,660,207. SGMA AND DESIGN. INT. CL. 42. (U.S. CL. 100). REG. 10-8-1991.
- 1,660,212. CAPS. INT. CL. 42. (U.S. CL. 100). REG. 10-8-1991.
- 1,660,221. ICE CREAM MAN FROM HELL. INT. CL. 42. (U.S. CL. 101). REG. 10-8-1991.
- 1,660,225. PUL. INT. CL. 42. (U.S. CL. 101). REG. 10-8-1991.
- 1,660,236. MISCELLANEOUS DESIGN. INT. CL. 42. (U.S. CL. 101). REG. 10-8-1991.
- 1,660,257. ACTHREL. INT. CL. 5. (U.S. CL. 18). REG. 10-8-1991.
- 1,660,260. PRO-SPORT. INT. CL. 6. (U.S. CLS. 13 AND 25). REG. 10-8-1991.
- 1,660,295. OPTIVEX. INT. CL. 9. (U.S. CL. 26). REG. 10-8-1991.
- 1,660,311. ULTRA SOFT. INT. CL. 9. (U.S. CL. 21). REG. 10-8-1991.
- 1,660,322. CP-90. INT. CL. 9. (U.S. CL. 26). REG. 10-8-1991.
- 1,660,325. YOU CAN CHOOSE. INT. CL. 9. (U.S. CLS. 21 AND 36). REG. 10-8-1991.
- 1,660,335. SUREVUE. INT. CL. 9. (U.S. CL. 26). REG. 10-8-1991.
- 1,660,350. AMERICAN FARMER. INT. CL. 12. (U.S. CL. 35). REG. 10-8-1991.
- 1,660,362. MARBLE EASE. INT. CL. 16. (U.S. CL. 16). REG. 10-8-1991.
- 1,660,406. SEARCH & RESCUE. INT. CL. 35. (U.S. CLS. 100 AND 101). REG. 10-8-1991.
- 1,660,407. COVENTRY. INT. CL. 36. (U.S. CL. 102). REG. 10-8-1991.
- 1,660,431. WELL-CONNECTED AWARD. INT. CL. 16. (U.S. CL. 38). REG. 10-8-1991.
- 1,660,484. REI. INT. CLS. 4 AND 42. (U.S. CLS. 15, 100 AND 101). REG. 10-15-1991.
- 1,660,494. STERILAMP. INT. CL. 5. (U.S. CLS. 18 AND 44). REG. 10-15-1991.
- 1,660,534. AMIGO. INT. CLS. 7, 12 AND 37. (U.S. CLS. 23, 44 AND 103). REG. 10-15-1991.
- 1,660,600. MEGACUT. INT. CL. 9. (U.S. CL. 21). REG. 10-15-1991.
- 1,660,694. FLOTHERM. INT. CL. 9. (U.S. CL. 38). REG. 10-15-1991.
- 1,660,709. THERMA PRO-V. INT. CL. 11. (U.S. CL. 34). REG. 10-15-1991.
- 1,660,721. SIDE ORDER COOKER. INT. CL. 11. (U.S. CL. 34). REG. 10-15-1991.
- 1,660,860. KITCHEN CRAFT. INT. CL. 21. (U.S. CLS. 2, 13 AND 21). REG. 10-15-1991.
- 1,660,889. KC (STYLIZED). INT. CL. 25. (U.S. CLS. 22 AND 39). REG. 10-15-1991.
- 1,660,896. CUTTER & BUCK C/B AND DESIGN. INT. CL. 25. (U.S. CLS. 22 AND 39). REG. 10-15-1991.
- 1,660,960. M&M'S AND DESIGN. INT. CL. 28. (U.S. CL. 22). REG. 10-15-1991.
- 1,660,998. MISCELLANEOUS DESIGN. INT. CL. 30. (U.S. CL. 46). REG. 10-15-1991.
- 1,661,005. CHALET SUZANNE. INT. CL. 30. (U.S. CL. 46). REG. 10-15-1991.
- 1,661,101. COOLING TOWERS INCORPORATED AND DESIGN. INT. CL. 37. (U.S. CL. 103). REG. 10-15-1991.
- 1,661,157. ANGELIKA FILM CENTER. INT. CL. 41. (U.S. CLS. 100, 101 AND 107). REG. 10-15-1991.
- 1,661,254. THE NAME FITS. INT. CL. 42. (U.S. CL. 101). REG. 10-15-1991.
- 1,661,282. LACTOMER. INT. CL. 10. (U.S. CL. 44). REG. 10-15-1991.
- 1,661,283. SOFSILK. INT. CL. 10. (U.S. CL. 44). REG. 10-15-1991.
- 1,661,299. SENSIBLE CHOICE. INT. CL. 31. (U.S. CL. 46). REG. 10-15-1991.
- 1,661,327. PROGENICS AND DESIGN. INT. CL. 1. (U.S. CLS. 1, 5, 6, 10, 26 AND 46). REG. 10-22-1991.
- 1,661,490. ZIGOR. INT. CLS. 9, 11 AND 13. (U.S. CLS. 2, 9, 13, 21, 23, 26, 31, 34, 36 AND 38). REG. 10-22-1991.
- 1,661,513. RESOURCE RFB. INT. CL. 9. (U.S. CL. 21). REG. 10-22-1991.
- 1,661,519. WIRING PROJECTS MADE EASY!. INT. CL. 9. (U.S. CLS. 21 AND 26). REG. 10-22-1991.
- 1,661,631. PAUL SMITH. INT. CLS. 14 AND 18. (U.S. CLS. 3 AND 27). REG. 10-22-1991.
- 1,661,643. DEAGAN AND DESIGN. INT. CL. 15. (U.S. CL. 36). REG. 10-22-1991.
- 1,661,663. PROJECT 2061. INT. CLS. 16 AND 41. (U.S. CLS. 38 AND 107). REG. 10-22-1991.
- 1,661,675. THE GREATEST SPECTACLE IN RACING. INT. CLS. 16 AND 25. (U.S. CLS. 2 AND 39). REG. 10-22-1991.
- 1,661,696. PRACTICAL HORSEMAN. INT. CL. 16. (U.S. CL. 38). REG. 10-22-1991.
- 1,661,700. P AND DESIGN. INT. CL. 16. (U.S. CL. 38). REG. 10-22-1991.
- 1,661,733. THE METROPOLITAN MUSEUM OF ART. INT. CL. 18. (U.S. CLS. 3 AND 41). REG. 10-22-1991.
- 1,661,741. H AND DESIGN. INT. CL. 19. (U.S. CLS. 12 AND 33). REG. 10-22-1991.
- 1,661,804. THE COURAGE TO COME BACK. (STYLIZED). INT. CL. 25. (U.S. CL. 39). REG. 10-22-1991.
- 1,661,818. PICK 'EM ALL (STYLIZED). INT. CL. 28. (U.S. CL. 22). REG. 10-22-1991.
- 1,661,858. THE GATHERING OF SAFFRON. INT. CL. 30. (U.S. CL. 46). REG. 10-22-1991.
- 1,661,893. NOVIA. INT. CL. 33. (U.S. CL. 47). REG. 10-22-1991.
- 1,661,943. CARISMA AND DESIGN. INT. CL. 37. (U.S. CL. 103). REG. 10-22-1991.
- 1,661,944. JETBLAST. INT. CL. 37. (U.S. CL. 103). REG. 10-22-1991.
- 1,661,953. THE BEST ALLOY & SPECIALTY BARS AND DESIGN. INT. CL. 37. (U.S. CLS. 103 AND 106). REG. 10-22-1991.
- 1,662,215. TAP AMERICA. INT. CL. 8. (U.S. CL. 23). REG. 10-29-1991.
- 1,662,293. POLYDOR AND DESIGN. INT. CL. 9. (U.S. CLS. 21, 23, 26, 36 AND 38). REG. 10-29-1991.
- 1,662,294. ART. INT. CL. 9. (U.S. CL. 26). REG. 10-29-1991.
- 1,662,479. LEVELALL. INT. CL. 19. (U.S. CL. 12). REG. 10-29-1991.
- 1,662,663. PESTO VINEYARDO. INT. CL. 30. (U.S. CL. 46). REG. 10-29-1991.
- 1,662,688. TEENI. INT. CL. 32. (U.S. CL. 45). REG. 10-29-1991.
- 1,662,742. THE GUARDIAN. INT. CL. 36. (U.S. CL. 102). REG. 10-29-1991.
- 1,662,783. 16 WNDUTV SOUTH BEND. INT. CL. 38. (U.S. CLS. 104 AND 107). REG. 10-29-1991.
- 1,662,800. CONNECTICUT SCHOOL OF BROADCASTING CSB EST. 1964 AND DESIGN. INT. CL. 41. (U.S. CL. 107). REG. 10-29-1991.
- 1,662,860. REHAB CHOICE. INT. CL. 42. (U.S. CL. 100). REG. 10-29-1991.
- 1,663,097. TEXCOOL. INT. CL. 1. (U.S. CL. 6). REG. 11-5-1991.
- 1,663,112. VALGARD. INT. CL. 2. (U.S. CL. 16). REG. 11-5-1991.
- 1,663,134. 0820. INT. CL. 3. (U.S. CLS. 51 AND 52). REG. 11-5-1991.
- 1,663,191. KTC AND DESIGN. INT. CL. 8. (U.S. CLS. 23, 28 AND 44). REG. 11-5-1991.
- 1,663,285. CODIAG. INT. CL. 9. (U.S. CL. 38). REG. 11-5-1991.
- 1,663,390. CARIBBEAN YELLOW PAGES CPC AND DESIGN. INT. CL. 16. (U.S. CL. 38). REG. 11-5-1991.
- 1,663,424. DIVERSI-PLAST. INT. CL. 17. (U.S. CLS. 1, 35 AND 50). REG. 11-5-1991.
- 1,663,437. TECHNICRETE. INT. CL. 19. (U.S. CL. 12). REG. 11-5-1991.
- 1,663,728. VIDEO UPDATE. INT. CL. 42. (U.S. CLS. 100 AND 101). REG. 11-5-1991.
- 1,663,810. BRING THE BARON HOME TONIGHT!. INT. CL. 30. (U.S. CL. 46). REG. 11-5-1991.
- 1,663,826. J'S MAINTENANCE (STYLIZED). INT. CL. 37. (U.S. CL. 103). REG. 11-5-1991.
- 1,663,847. FUELPAK. INT. CL. 4. (U.S. CL. 15). REG. 11-5-1991.
- 1,663,866. ITALY AND DESIGN. INT. CL. 25. (U.S. CL. 39). REG. 11-5-1991.
- 1,664,055. L (STYLIZED). INT. CL. 14. (U.S. CL. 28). REG. 11-12-1991.
- 1,664,437. CFI (STYLIZED). INT. CL. 39. (U.S. CLS. 100 AND 105). REG. 11-12-1991.
- 1,664,646. AQUA CHEM. INT. CLS. 1, 8, 9, 17 AND 21. (U.S. CLS. 5, 23, 26, 29 AND 35). REG. 11-19-1991.
- 1,664,883. ITE AND DESIGN. INT. CL. 9. (U.S. CL. 26). REG. 11-19-1991.
- 1,664,911. TRI-SENSE. INT. CL. 9. (U.S. CL. 26). REG. 11-19-1991.

- 1,665,007. THE MOVIE MONITOR. INT. CL. 16. (U.S. CL. 38). REG. 11-19-1991.
- 1,665,259. AMERICAN MUSICAL AMBASSADORS. INT. CL. 39. (U.S. CLS. 100 AND 105). REG. 11-19-1991.
- 1,665,404. PRILOSEC. INT. CL. 5. (U.S. CL. 18). REG. 11-19-1991.
- 1,665,519. PEANUT PANIC. INT. CL. 30. (U.S. CL. 46). REG. 11-19-1991.
- 1,665,542. THE VITALITY STORE. INT. CL. 42. (U.S. CL. 101). REG. 11-19-1991.
- 1,665,608. LIFTOSOME. INT. CL. 3. (U.S. CL. 51). REG. 11-26-1991.
- 1,665,675. NOVOTECHNIK (STYLIZED). INT. CL. 9. (U.S. CLS. 21 AND 26). REG. 11-26-1991.
- 1,665,727. ZENGER MILLER. INT. CLS. 9 AND 16. (U.S. CLS. 21 AND 38). REG. 11-26-1991.
- 1,665,842. SHIPFLAT AND DESIGN. INT. CL. 16. (U.S. CLS. 2, 32 AND 37). REG. 11-26-1991.
- 1,665,896. FURRY FEET AND DESIGN. INT. CL. 25. (U.S. CL. 39). REG. 11-26-1991.
- 1,665,914. SPORTIME. INT. CL. 28. (U.S. CL. 22). REG. 11-26-1991.
- 1,666,454. DYNAKART. INT. CL. 7. (U.S. CL. 23). REG. 12-3-1991.
- 1,666,744. RYCENGA AND DESIGN. INT. CLS. 19 AND 42. (U.S. CLS. 12 AND 101). REG. 12-3-1991.
- 1,666,757. M AND DESIGN. INT. CL. 20. (U.S. CL. 50). REG. 12-3-1991.
- 1,667,014. NEWSCENTER 16. INT. CL. 41. (U.S. CL. 107). REG. 12-3-1991.
- 1,667,406. ONLINET. INT. CL. 9. (U.S. CL. 38). REG. 12-10-1991.
- 1,667,701. BRET LIN. INT. CL. 27. (U.S. CLS. 37 AND 42). REG. 12-10-1991.
- 1,667,803. BAMBU (STYLIZED). INT. CL. 34. (U.S. CL. 8). REG. 12-10-1991.
- 1,667,851. OPTICHOICE. INT. CL. 36. (U.S. CLS. 101 AND 102). REG. 12-10-1991.
- 1,668,152. HUMIDITREAT. INT. CL. 1. (U.S. CL. 6). REG. 12-17-1991.
- 1,668,541. TC AND DESIGN. INT. CLS. 20 AND 37. (U.S. CLS. 2, 103 AND 106). REG. 12-17-1991.
- 1,668,695. NANCE'S. INT. CL. 30. (U.S. CL. 46). REG. 12-17-1991.
- 1,668,723. ELITE-NZW. INT. CL. 31. (U.S. CL. 1). REG. 12-17-1991.
- 1,668,948. METALSHIELD. INT. CL. 2. (U.S. CLS. 6, 11 AND 16). REG. 12-17-1991.
- 1,669,444. CLEAN TECH. INT. CL. 17. (U.S. CL. 1). REG. 12-24-1991.
- 1,669,521. BON WORTH. INT. CL. 25. (U.S. CL. 39). REG. 12-24-1991.
- 1,669,689. THE ALTERNATIVE BOARD TAB. INT. CL. 35. (U.S. CL. 101). REG. 12-24-1991.
- 1,670,014. KOCOLENE AND DESIGN. INT. CL. 4. (U.S. CL. 15). REG. 12-31-1991.
- 1,670,016. ALKY. INT. CL. 4. (U.S. CL. 15). REG. 12-31-1991.
- 1,670,174. WR (STYLIZED). INT. CL. 12. (U.S. CL. 19). REG. 12-31-1991.
- 1,670,236. PLAN-ON-IT AND DESIGN. INT. CL. 16. (U.S. CL. 37). REG. 12-31-1991.
- 1,670,268. M.C.A. AND DESIGN. INT. CL. 19. (U.S. CL. 12). REG. 12-31-1991.
- 1,670,275. FLEXSTEEL. INT. CL. 20. (U.S. CL. 32). REG. 12-31-1991.
- 1,670,306. ISDA & CO.. INT. CL. 25. (U.S. CL. 39). REG. 12-31-1991.
- 1,670,790. STEAMMASTER. INT. CL. 11. (U.S. CLS. 34 AND 50). REG. 12-31-1991.
- 1,670,797. ALEXIA (STYLIZED). INT. CL. 14. (U.S. CL. 28). REG. 12-31-1991.
- 1,670,839. STORMY MOUNTAIN. INT. CL. 25. (U.S. CL. 39). REG. 12-31-1991.
- 1,670,840. TRINKETS. INT. CL. 25. (U.S. CL. 39). REG. 12-31-1991.
- 1,670,841. DREXLITE. INT. CL. 25. (U.S. CL. 39). REG. 12-31-1991.
- 1,670,912. SCHU'S. INT. CL. 42. (U.S. CL. 100). REG. 12-31-1991.
- 1,670,921. ITALY AND DESIGN. INT. CL. 25. (U.S. CL. 39). REG. 12-31-1991.
- 1,670,958. LANOFRESH. INT. CL. 5. (U.S. CL. 18). REG. 1-7-1992.
- 1,671,290. PRO-BRED. INT. CL. 31. (U.S. CL. 46). REG. 1-7-1992.
- 1,671,511. ALERT. INT. CL. 1. (U.S. CL. 6). REG. 1-14-1992.
- 1,671,576. LACTIVATE. INT. CL. 5. (U.S. CL. 18). REG. 1-14-1992.
- 1,671,946. MISCELLANEOUS DESIGN. INT. CL. 30. (U.S. CL. 46). REG. 1-14-1992.
- 1,673,701. ALLIED HEALTH CARE PUBLICATIONS. INT. CL. 41. (U.S. CLS. 100, 101 AND 107). REG. 1-28-1992.
- 1,673,713. BEN SUTTON GOLF SCHOOL AND DESIGN. INT. CL. 41. (U.S. CL. 107). REG. 1-28-1992.
- 1,673,772. FAIRWAY SYSTEMS. INT. CL. 42. (U.S. CLS. 100 AND 101). REG. 1-28-1992.
- 1,673,873. AVENIR. INT. CL. 20. (U.S. CL. 32). REG. 1-28-1992.
- 1,674,130. DIAB-A-SHEETS. INT. CL. 10. (U.S. CLS. 1 AND 44). REG. 2-4-1992.
- 1,674,154. SHOK-BUFF. INT. CL. 13. (U.S. CL. 9). REG. 2-4-1992.
- 1,674,790. KAHLE (STYLIZED). INT. CL. 7. (U.S. CL. 23). REG. 2-11-1992.
- 1,675,125. WHISTLESIPPER (STYLIZED). INT. CL. 20. (U.S. CL. 50). REG. 2-11-1992.
- 1,675,427. N.E.T.. INT. CL. 41. (U.S. CL. 107). REG. 2-11-1992.
- 1,675,982. MISCELLANEOUS DESIGN. INT. CL. 29. (U.S. CL. 46). REG. 2-18-1992.
- 1,676,131. THE REAL COFFEE EXPERTS. INT. CL. 39. (U.S. CLS. 101 AND 105). REG. 2-18-1992.
- 1,676,376. UNI-PALLET. INT. CL. 20. (U.S. CL. 50). REG. 2-18-1992.
- 1,676,569. BARNES (STYLIZED). INT. CL. 7. (U.S. CL. 23). REG. 2-25-1992.
- 1,677,844. QUICK COLLECT. INT. CL. 36. (U.S. CL. 102). REG. 3-3-1992.
- 1,678,085. RODEO MILE. INT. CL. 14. (U.S. CL. 28). REG. 3-3-1992.
- 1,678,150. PCTAXI (STYLIZED). INT. CL. 9. (U.S. CLS. 26 AND 38). REG. 3-3-1992.
- 1,678,451. ENTERTAINMENT WEEKLY. INT. CL. 16. (U.S. CL. 38). REG. 3-10-1992.
- 1,678,513. PICKS & PANS. INT. CL. 16. (U.S. CL. 38). REG. 3-10-1992.
- 1,678,769. EUREKA!. INT. CL. 35. (U.S. CL. 101). REG. 3-10-1992.
- 1,678,957. AXAREL. INT. CL. 3. (U.S. CL. 52). REG. 3-10-1992.
- 1,679,116. ENDURIUM. INT. CL. 1. (U.S. CLS. 6 AND 15). REG. 3-17-1992.
- 1,679,277. PULSELITE. INT. CL. 9. (U.S. CL. 26). REG. 3-17-1992.
- 1,679,298. INTEGRAL. INT. CL. 10. (U.S. CL. 44). REG. 3-17-1992.
- 1,680,453. P (STYLIZED). INT. CL. 25. (U.S. CL. 39). REG. 3-24-1992.
- 1,680,540. BULL DURHAM AND DESIGN. INT. CL. 34. (U.S. CL. 17). REG. 3-24-1992.
- 1,680,897. GLYDANT PLUS. INT. CL. 1. (U.S. CL. 6). REG. 3-31-1992.
- 1,680,977. TOUR SMOOTH. INT. CL. 8. (U.S. CL. 23). REG. 3-31-1992.
- 1,681,312. P (STYLIZED). INT. CL. 28. (U.S. CL. 22). REG. 3-31-1992.
- 1,681,353. CINNAMON TOAST CRUNCH. INT. CL. 30. (U.S. CL. 46). REG. 3-31-1992.
- 1,681,754. ENDOVAC-BOVI (STYLIZED). INT. CL. 5. (U.S. CL. 18). REG. 4-7-1992.
- 1,682,972. POSTURE BEAUTY. INT. CL. 20. (U.S. CL. 32). REG. 4-14-1992.
- 1,683,055. MISCELLANEOUS DESIGN. INT. CL. 28. (U.S. CLS. 22, 23, 38 AND 50). REG. 4-14-1992.
- 1,684,392. SMALL WONDERS. INT. CL. 14. (U.S. CL. 28). REG. 4-28-1992.
- 1,684,552. WEIGHT WISE. INT. CL. 29. (U.S. CL. 46). REG. 4-28-1992.
- 1,684,698. BRYANT COLLEGE. INT. CL. 41. (U.S. CL. 107). REG. 4-28-1992.
- 1,686,459. WOODTONE AND DESIGN. INT. CL. 20. (U.S. CL. 32). REG. 5-12-1992.
- 1,686,591. BAHAMA. INT. CL. 30. (U.S. CL. 46). REG. 5-12-1992.
- 1,688,208. EYE SAVERS AND DESIGN. INT. CL. 42. (U.S. CLS. 100 AND 101). REG. 5-19-1992.
- 1,689,007. DR REPORTS. INT. CL. 16. (U.S. CL. 38). REG. 5-26-1992.

- 1,689,578. CLEARTEC (STYLIZED). INT. CL. 21. (U.S. CLS. 29 AND 50). REG. 5-26-1992.
- 1,693,075. CLEAN SWEEP (STYLIZED). INT. CL. 21. (U.S. CLS. 29 AND 50). REG. 6-9-1992.
- 1,693,238. CONSERVATIONIST. INT. CL. 28. (U.S. CL. 22). REG. 6-9-1992.
- 1,693,643. COUNTRY BASKET. INT. CL. 42. (U.S. CL. 100). REG. 6-9-1992.
- 1,694,181. RECWARE. INT. CL. 9. (U.S. CL. 38). REG. 6-16-1992.
- 1,698,679. CLIMATE RESPONSE. INT. CL. 3. (U.S. CLS. 51 AND 52). REG. 7-7-1992.
- 1,699,214. BRACKET KADDY. INT. CL. 28. (U.S. CL. 22). REG. 7-7-1992.
- 1,700,310. VMEHSD (STYLIZED). INT. CL. 9. (U.S. CL. 26). REG. 7-14-1992.
- 1,700,821. YOUR OLD METAIRIE SPECIALIST. INT. CL. 36. (U.S. CLS. 101 AND 102). REG. 7-14-1992.
- 1,701,091. TROPIC. INT. CL. 11. (U.S. CL. 34). REG. 7-14-1992.
- 1,701,362. MP (STYLIZED). INT. CLS. 5 AND 31. (U.S. CLS. 18 AND 46). REG. 7-21-1992.
- 1,702,971. JET PILOT. INT. CL. 9. (U.S. CLS. 26 AND 39). REG. 7-28-1992.
- 1,703,004. EYECOM. INT. CL. 9. (U.S. CL. 38). REG. 7-28-1992.
- 1,703,193. RHINESTONES AND DESIGN. INT. CL. 16. (U.S. CLS. 37 AND 38). REG. 7-28-1992.
- 1,704,034. EXCEL. INT. CL. 1. (U.S. CL. 6). REG. 7-28-1992.
- 1,704,272. SUSHI. INT. CL. 25. (U.S. CL. 39). REG. 7-28-1992.
- 1,704,976. MEL BAY. INT. CL. 16. (U.S. CL. 38). REG. 8-4-1992.
- 1,705,007. FIRESTALL. INT. CL. 19. (U.S. CL. 12). REG. 8-4-1992.
- 1,705,113. MONSTER MILE. INT. CL. 25. (U.S. CL. 39). REG. 8-4-1992.
- 1,705,191. POOF (STYLIZED). INT. CL. 28. (U.S. CL. 22). REG. 8-4-1992.
- 1,705,192. POOF. INT. CL. 28. (U.S. CL. 22). REG. 8-4-1992.
- 1,705,404. TFA. INT. CL. 36. (U.S. CL. 102). REG. 8-4-1992.
- 1,706,088. LIQUI-DAM. INT. CL. 1. (U.S. CLS. 6 AND 42). REG. 8-11-1992.
- 1,706,095. PRESERVCYT. INT. CL. 1. (U.S. CLS. 1, 5, 6, 10, 26 AND 46). REG. 8-11-1992.
- 1,708,300. DOVER DOWNS. INT. CL. 25. (U.S. CL. 39). REG. 8-18-1992.
- 1,708,617. ENHANCE. INT. CL. 36. (U.S. CL. 102). REG. 8-18-1992.
- 1,708,946. MISCELLANEOUS DESIGN. INT. CL. 42. (U.S. CL. 100). REG. 8-18-1992.
- 1,709,298. WARMAIR. INT. CL. 10. (U.S. CL. 44). REG. 8-18-1992.
- 1,710,878. INVERTED ROUTER. INT. CL. 7. (U.S. CLS. 13, 19, 21, 23, 31, 34 AND 35). REG. 8-25-1992.
- 1,712,068. BUTTERCUP. INT. CL. 34. (U.S. CL. 17). REG. 9-1-1992.
- 1,712,134. USAA. INT. CLS. 35, 36, 39 AND 42. (U.S. CLS. 100, 101, 102 AND 105). REG. 9-1-1992.
- 1,712,135. MISCELLANEOUS DESIGN. INT. CLS. 35, 36, 39 AND 42. (U.S. CLS. 100, 101, 102 AND 105). REG. 9-1-1992.
- 1,712,608. OBJECTIVITY. INT. CL. 9. (U.S. CL. 38). REG. 9-1-1992.
- 1,715,505. MISCELLANEOUS DESIGN. INT. CL. 13. (U.S. CL. 9). REG. 9-15-1992.
- 1,715,669. OFFICEMAX. INT. CL. 16. (U.S. CLS. 5, 37 AND 38). REG. 9-15-1992.
- 1,715,800. DAKOTA JACKSON. INT. CL. 20. (U.S. CL. 32). REG. 9-15-1992.
- 1,716,098. KOOKABURRA WINGS. INT. CL. 29. (U.S. CL. 46). REG. 9-15-1992.
- 1,716,209. CLARA STOVER. INT. CL. 30. (U.S. CL. 46). REG. 9-15-1992.
- 1,716,712. MISCELLANEOUS DESIGN. INT. CL. 41. (U.S. CL. 107). REG. 9-15-1992.
- 1,717,957. SS (STYLIZED). INT. CL. 15. (U.S. CL. 36). REG. 9-22-1992.
- 1,718,098. GULLIVER BOOKS. INT. CL. 16. (U.S. CL. 38). REG. 9-22-1992.
- 1,718,436. APPLE TIME. INT. CLS. 29 AND 32. (U.S. CL. 46). REG. 9-22-1992.
- 1,718,653. THE INFORMED ADVANTAGE. INT. CL. 35. (U.S. CLS. 100, 101 AND 102). REG. 9-22-1992.
- 1,718,742. AMERISOUTH. INT. CL. 36. (U.S. CL. 102). REG. 9-22-1992.
- 1,719,817. MAF (STYLIZED). INT. CL. 6. (U.S. CL. 13). REG. 9-29-1992.
- 1,720,493. ALICE SPRINGS CHICKEN. INT. CL. 29. (U.S. CL. 46). REG. 9-29-1992.
- 1,721,030. CAT-I (STYLIZED). INT. CL. 1. (U.S. CL. 6). REG. 9-29-1992.
- 1,722,155. MISSION IMPOSSIBLE. INT. CL. 28. (U.S. CLS. 22, 23, 38 AND 50). REG. 10-6-1992.

* * * * *

TRADEMARK REGISTRATIONS CANCELED

The designation "U.S. Cl." appearing in this section refers to the U.S. class in effect prior to Sep. 1, 1973 rather than the international class which applies to applications filed on or after that date. For adoption of international classification see notice in the OFFICIAL GAZETTE of Jun. 26, 1973 (911 O.G. TM 210).

SECTION 7(D)

- 1,649,049. MISCELLANEOUS DESIGN. INT. CL. 40. REG. 6-25-1991.
- 1,661,724. MISCELLANEOUS DESIGN. INT. CLS. 17 AND 19. REG. 10-22-1991.
- 1,665,654. MISCELLANEOUS DESIGN. INT. CLS. 7 AND 11. REG. 11-26-1991.
- 1,883,246. TRANSLUCENCE. INT. CL. 3. REG. 3-14-1995.
- 1,908,203. CEDENT CONNECTION. INT. CL. 9. REG. 8-1-1995.
- 1,910,430. RIVERSTONE HOMES. INT. CL. 37. REG. 8-8-1995.
- 1,930,669. LENIBAIN. INT. CLS. 3 AND 5. REG. 10-31-1995.
- 2,107,480. GK CHLORO GOLD. INT. CL. 5. REG. 10-21-1997.
- 2,135,906. COSCO. INT. CL. 39. REG. 2-10-1998.
- 2,349,846. INTELLITECH SYSTEMS, INC.. INT. CL. 42. REG. 5-16-2000.
- 2,367,988. MRS. WAGES HOME BREAD. INT. CL. 30. REG. 7-18-2000.
- 708,137. STEVENS MASCOT DENIMS AND DESIGN. U.S. CL. 42. REG. 12-6-1960.
- 708,142. CAPITOL FARMS AND DESIGN. U.S. CL. 46. REG. 12-6-1960.
- 708,149. MISCELLANEOUS DESIGN. U.S. CL. 46. REG. 12-6-1960.
- 708,151. SUPER - DUPER (STYLIZED). U.S. CL. 46. REG. 12-6-1960.
- 708,154. GRIFFITH'S. U.S. CL. 46. REG. 12-6-1960.
- 708,156. LA RUTA. U.S. CL. 46. REG. 12-6-1960.
- 708,162. FIESTA. U.S. CL. 46. REG. 12-6-1960.
- 708,212. GLASTEEL AND DESIGN. U.S. CL. 34. REG. 12-6-1960.
- 708,214. HELLER & CO. (STYLIZED). U.S. CL. 36. REG. 12-6-1960.
- 708,217. SEEBURG. U.S. CL. 36. REG. 12-6-1960.
- 1,139,021. BEAVER CREEK. INT. CLS. 35 AND 37 ONLY. REG. 8-26-1980.
- 1,142,163. MISCELLANEOUS DESIGN. INT. CLS. 1 AND 30. REG. 12-9-1980.
- 1,142,164. CELOTEX (STYLIZED). INT. CLS. 1, 2 AND 19. REG. 12-9-1980.
- 1,142,166. AMNICATOR. INT. CL. 1. REG. 12-9-1980.
- 1,142,173. BIO/DATA. INT. CLS. 1, 9 AND 16. REG. 12-9-1980.
- 1,142,176. MISCELLANEOUS DESIGN. INT. CLS. 2 AND 6. REG. 12-9-1980.
- 1,142,184. FRESH LASH. INT. CL. 3. REG. 12-9-1980.
- 1,142,191. CANDLE CABIN. INT. CL. 4. REG. 12-9-1980.
- 1,142,199. ANCRACK. INT. CL. 5. REG. 12-9-1980.
- 1,142,203. CLINIWIPE (STYLIZED). INT. CL. 5. REG. 12-9-1980.
- 1,142,207. AG-MARK AND DESIGN. INT. CL. 5. REG. 12-9-1980.
- 1,142,214. SPENCO SLEEVE NUT. INT. CL. 6. REG. 12-9-1980.
- 1,142,225. S AND DESIGN. INT. CL. 6. REG. 12-9-1980.
- 1,142,230. SOCBX. INT. CL. 7. REG. 12-9-1980.
- 1,142,231. SCOVILL. INT. CLS. 7, 9, 11, 14 AND 20. REG. 12-9-1980.
- 1,142,233. BEAD-UP AND DESIGN. INT. CL. 7. REG. 12-9-1980.
- 1,142,234. EMCO-UNIMAT AND DESIGN. INT. CL. 7. REG. 12-9-1980.
- 1,142,237. HK HILLMAN-KELLEY AND DESIGN. INT. CL. 7. REG. 12-9-1980.
- 1,142,245. CLARK (STYLIZED). INT. CLS. 7 AND 12. REG. 12-9-1980.
- 1,142,247. FRAMEMASTER. INT. CL. 7. REG. 12-9-1980.
- 1,142,248. MAXI-BALL. INT. CL. 7. REG. 12-9-1980.
- 1,142,249. ROLLERBALL. INT. CL. 7. REG. 12-9-1980.
- 1,142,251. PYROPLATE. INT. CL. 7. REG. 12-9-1980.
- 1,142,252. PEDIGREED AND DESIGN. INT. CLS. 7, 9 AND 12. REG. 12-9-1980.
- 1,142,253. MISCELLANEOUS DESIGN. INT. CL. 7. REG. 12-9-1980.
- 1,142,254. THE GOAT. INT. CL. 7. REG. 12-9-1980.
- 1,142,261. MISCELLANEOUS DESIGN. INT. CLS. 7 AND 12. REG. 12-9-1980.
- 1,142,262. DETTSON AND DESIGN. INT. CL. 7. REG. 12-9-1980.
- 1,142,263. BAG.O.MAT (STYLIZED). INT. CL. 7. REG. 12-9-1980.
- 1,142,270. CARE-FREE. INT. CL. 8. REG. 12-9-1980.

SECTION 8

- 137,790. AIRVEYOR (STYLIZED). U.S. CL. 23. REG. 12-7-1920.
- 383,295. TUPA ISIDORO PATORUZU AND DESIGN. U.S. CL. 38. REG. 12-3-1940.
- 383,316. LOG CABIN. U.S. CL. 46. REG. 12-3-1940.
- 383,354. PEDIKIT. U.S. CL. 50. REG. 12-3-1940.
- 707,934. OASIS. U.S. CL. 2. REG. 12-6-1960.
- 707,940. SHRUBTAINER. U.S. CL. 2. REG. 12-6-1960.
- 707,949. THERMOCOL (STYLIZED). U.S. CL. 6. REG. 12-6-1960.
- 707,952. NP 10. U.S. CL. 6. REG. 12-6-1960.
- 707,955. KLING. U.S. CL. 6. REG. 12-6-1960.
- 707,958. DURAFIN. U.S. CL. 6. REG. 12-6-1960.
- 707,986. CARB-RITE. U.S. CL. 13. REG. 12-6-1960.
- 707,999. DUPHAR AND DESIGN. U.S. CL. 18. REG. 12-6-1960.
- 708,005. MURINE FOR YOUR EYES (STYLIZED). U.S. CL. 18. REG. 12-6-1960.
- 708,010. TETRA-DELTA. U.S. CL. 18. REG. 12-6-1960.
- 708,012. KETARIN. U.S. CL. 18. REG. 12-6-1960.
- 708,015. REGAMYCIN. U.S. CL. 18. REG. 12-6-1960.
- 708,020. MILGESIC. U.S. CL. 18. REG. 12-6-1960.
- 708,026. HELLFAX. U.S. CL. 21. REG. 12-6-1960.
- 708,046. CONSTRUCT-O-STRAWS. U.S. CL. 22. REG. 12-6-1960.
- 708,075. AVISTRAP (STYLIZED). U.S. CL. 23. REG. 12-6-1960.
- 708,076. DUPLEX. U.S. CL. 24. REG. 12-6-1960.
- 708,087. GOLDEN CROWN. U.S. CL. 30. REG. 12-6-1960.
- 708,090. GOLDEN CROWN. U.S. CL. 33. REG. 12-6-1960.
- 708,091. PAN-JAM-BAN. U.S. CL. 34. REG. 12-6-1960.
- 708,099. SO-CLEAR (STYLIZED). U.S. CL. 37. REG. 12-6-1960.
- 708,103. RULE-PAK. U.S. CL. 37. REG. 12-6-1960.

- 1,142,282. DIP/LOC. INT. CL. 9. REG. 12-9-1980.
 1,142,286. PM. INT. CL. 9. REG. 12-9-1980.
 1,142,291. IVDS AND DESIGN. INT. CL. 9. REG. 12-9-1980.
 1,142,299. VIBRA-II. INT. CL. 9. REG. 12-9-1980.
 1,142,307. HI FI HUTCH. INT. CL. 9. REG. 12-9-1980.
 1,142,309. PROTOTOMETER. INT. CL. 9. REG. 12-9-1980.
 1,142,311. RETOUCH-O-MAT. INT. CL. 9. REG. 12-9-1980.
 1,142,312. PLAN 1040 (STYLIZED). INT. CL. 9. REG. 12-9-1980.
 1,142,314. TUSA. INT. CL. 9. REG. 12-9-1980.
 1,142,320. DELTA 1000. INT. CL. 9. REG. 12-9-1980.
 1,142,322. SKILOOK. INT. CL. 9. REG. 12-9-1980.
 1,142,323. RCS. INT. CL. 9. REG. 12-9-1980.
 1,142,326. CLAIMS-CASSETTE. INT. CL. 9. REG. 12-9-1980.
 1,142,328. TELE-ATHENAR. INT. CL. 9. REG. 12-9-1980.
 1,142,329. ERRORGUARD. INT. CL. 9. REG. 12-9-1980.
 1,142,330. HANDI-WELD. INT. CL. 9. REG. 12-9-1980.
 1,142,333. CLEAN STAT. INT. CL. 9. REG. 12-9-1980.
 1,142,341. SONOGAGE RT2 (STYLIZED). INT. CL. 9. REG. 12-9-1980.
 1,142,342. VOCRYPTER. INT. CL. 9. REG. 12-9-1980.
 1,142,344. GPR. INT. CL. 9. REG. 12-9-1980.
 1,142,345. MICRO-LOC. INT. CL. 9. REG. 12-9-1980.
 1,142,353. UNI-TUCK. INT. CL. 9. REG. 12-9-1980.
 1,142,356. TURBU FLOW AND DESIGN. INT. CL. 9. REG. 12-9-1980.
 1,142,366. SUPER-MITE. INT. CL. 9. REG. 12-9-1980.
 1,142,368. 772. INT. CL. 9. REG. 12-9-1980.
 1,142,379. KINGTEX. INT. CL. 10. REG. 12-9-1980.
 1,142,382. MOLD-AND-HOLD. INT. CL. 10. REG. 12-9-1980.
 1,142,383. MISCELLANEOUS DESIGN. INT. CLS. 10 AND 16. REG. 12-9-1980.
 1,142,394. BUBBLITE. INT. CL. 11. REG. 12-9-1980.
 1,142,397. COMPUT-A-SAVE (STYLIZED). INT. CL. 11. REG. 12-9-1980.
 1,142,400. HEMO-RO. INT. CL. 11. REG. 12-9-1980.
 1,142,401. GLASS PACEMAKER (STYLIZED). INT. CL. 11. REG. 12-9-1980.
 1,142,403. EVAK. INT. CL. 11. REG. 12-9-1980.
 1,142,409. SENTINEL. INT. CL. 11. REG. 12-9-1980.
 1,142,413. INTERBURNER. INT. CL. 11. REG. 12-9-1980.
 1,142,416. HEMISPHERE. INT. CL. 11. REG. 12-9-1980.
 1,142,417. DYN-O-MITE. INT. CL. 12. REG. 12-9-1980.
 1,142,420. HINOMOTO. INT. CL. 12. REG. 12-9-1980.
 1,142,424. TRAVELITE (STYLIZED). INT. CL. 12. REG. 12-9-1980.
 1,142,428. PER FEC TOW. INT. CL. 12. REG. 12-9-1980.
 1,142,432. TURBO TWIST. INT. CL. 12. REG. 12-9-1980.
 1,142,436. PEREGO (STYLIZED). INT. CL. 12. REG. 12-9-1980.
 1,142,437. LIBRE. INT. CL. 12. REG. 12-9-1980.
 1,142,442. PAZZAZZ AND DESIGN. INT. CL. 12. REG. 12-9-1980.
 1,142,449. COMPLIANCE. INT. CL. 12. REG. 12-9-1980.
 1,142,450. BIG TRAIL. INT. CL. 12. REG. 12-9-1980.
 1,142,454. FRECKLES. INT. CL. 12. REG. 12-9-1980.
 1,142,455. SANDS. INT. CL. 12. REG. 12-9-1980.
 1,142,456. SUNRISER. INT. CL. 12. REG. 12-9-1980.
 1,142,458. CIMARRON. INT. CLS. 14 AND 26. REG. 12-9-1980.
 1,142,461. WHISPER HINGE. INT. CL. 14. REG. 12-9-1980.
 1,142,466. GUITAR TRADER. INT. CLS. 15, 37 AND 42. REG. 12-9-1980.
 1,142,479. STEINBECK COUNTRY GENERAL STORE AND DESIGN. INT. CLS. 16 AND 41. REG. 12-9-1980.
 1,142,484. MISCELLANEOUS DESIGN. INT. CL. 16. REG. 12-9-1980.
 1,142,489. COLONIAL PARCHMENT. INT. CL. 16. REG. 12-9-1980.
 1,142,490. STASHER. INT. CL. 16. REG. 12-9-1980.
 1,142,492. DURA-DRUM. INT. CL. 16. REG. 12-9-1980.
 1,142,493. D AND DESIGN. INT. CLS. 16 AND 19. REG. 12-9-1980.
 1,142,501. SPORTSTYLE. INT. CL. 16. REG. 12-9-1980.
 1,142,504. E E P D AND DESIGN. INT. CL. 16. REG. 12-9-1980.
 1,142,508. REDS VUE. INT. CL. 16. REG. 12-9-1980.
 1,142,509. EULENBURG. INT. CL. 16. REG. 12-9-1980.
 1,142,515. SAFETY SIGNALS. INT. CL. 16. REG. 12-9-1980.
 1,142,516. AIRPORT SERVICES MANAGEMENT. INT. CL. 16. REG. 12-9-1980.
 1,142,521. THE SUAVE SMART SHOPPER. INT. CL. 16. REG. 12-9-1980.
 1,142,525. KRAZY KARGO (STYLIZED). INT. CL. 16. REG. 12-9-1980.
 1,142,526. MOD PENCILS (STYLIZED). INT. CL. 16. REG. 12-9-1980.
 1,142,537. PLUS 12 (STYLIZED). INT. CL. 16. REG. 12-9-1980.
 1,142,538. PLUS 24 (STYLIZED). INT. CL. 16. REG. 12-9-1980.
 1,142,539. SOFT IMPRESSIONS. INT. CL. 16. REG. 12-9-1980.
 1,142,541. SOFTMIST. INT. CL. 16. REG. 12-9-1980.
 1,142,544. RVCI. INT. CL. 16. REG. 12-9-1980.
 1,142,550. LOK-TITE. INT. CL. 16. REG. 12-9-1980.
 1,142,553. WOODHAVEN FOODS. INT. CL. 16. REG. 12-9-1980.
 1,142,555. ANCO AND DESIGN. INT. CL. 17. REG. 12-9-1980.
 1,142,556. POLYLAM. INT. CL. 17. REG. 12-9-1980.
 1,142,561. HUDSON'S BAY. INT. CL. 18. REG. 12-9-1980.
 1,142,562. GG (STYLIZED). INT. CL. 18. REG. 12-9-1980.
 1,142,564. COLEMAN AND DESIGN. INT. CLS. 18, 25 AND 28. REG. 12-9-1980.
 1,142,565. COLEMAN. INT. CLS. 18, 25 AND 28. REG. 12-9-1980.
 1,142,568. NEW ENGLAND LOG HOMES. INT. CL. 19. REG. 12-9-1980.
 1,142,569. E-Z KOTE. INT. CL. 19. REG. 12-9-1980.
 1,142,579. SAVE THE WHALE COLLECTION. INT. CL. 20. REG. 12-9-1980.
 1,142,581. ECON-O-LID. INT. CL. 20. REG. 12-9-1980.
 1,142,583. BILLOW PILLOW (STYLIZED). INT. CL. 20. REG. 12-9-1980.
 1,142,584. EARTHWOODS. INT. CL. 20. REG. 12-9-1980.
 1,142,599. BRUCE FOX DESIGN. INT. CL. 20. REG. 12-9-1980.
 1,142,604. THERMOPLAN. INT. CL. 21. REG. 12-9-1980.
 1,142,605. BOUNCER. INT. CL. 21. REG. 12-9-1980.
 1,142,607. BRUCE FOX DESIGN. INT. CL. 21. REG. 12-9-1980.
 1,142,609. A TIARA EXCLUSIVE (STYLIZED). INT. CL. 21. REG. 12-9-1980.
 1,142,613. ATLA-STRAN. INT. CL. 22. REG. 12-9-1980.
 1,142,614. HERCU-PUL. INT. CL. 22. REG. 12-9-1980.
 1,142,615. DAZEY. INT. CL. 22. REG. 12-9-1980.
 1,142,618. SPARMONT. INT. CL. 24. REG. 12-9-1980.
 1,142,628. VAINQUEUR. INT. CL. 25. REG. 12-9-1980.
 1,142,631. GUTS. INT. CL. 25. REG. 12-9-1980.
 1,142,633. GAYLON FURS. INT. CLS. 25, 37 AND 39. REG. 12-9-1980.
 1,142,638. 1166 COLLECTION (STYLIZED). INT. CL. 25. REG. 12-9-1980.
 1,142,643. J & M EAGLE SOFTEE. INT. CL. 25. REG. 12-9-1980.
 1,142,644. DONALD BROOKS. INT. CL. 25. REG. 12-9-1980.
 1,142,645. DONALD BROOKS. INT. CL. 25. REG. 12-9-1980.
 1,142,646. DONALD BROOKS. INT. CL. 25. REG. 12-9-1980.
 1,142,649. IT'S ME. INT. CL. 25. REG. 12-9-1980.
 1,142,650. COTTON FEELS. INT. CL. 25. REG. 12-9-1980.
 1,142,651. OPTIONS. INT. CL. 25. REG. 12-9-1980.
 1,142,652. EXPELLO. INT. CL. 25. REG. 12-9-1980.
 1,142,653. THE DAILY BASIC. INT. CL. 25. REG. 12-9-1980.
 1,142,654. ZAC. INT. CL. 25. REG. 12-9-1980.
 1,142,658. MORRY'S AND DESIGN. INT. CL. 25. REG. 12-9-1980.
 1,142,659. MORRY'S. INT. CL. 25. REG. 12-9-1980.
 1,142,661. MISS SBICCA. INT. CL. 25. REG. 12-9-1980.
 1,142,662. TURFMAN. INT. CL. 25. REG. 12-9-1980.
 1,142,664. THE ORIGINAL CRAYONS AND DESIGN. INT. CL. 25. REG. 12-9-1980.
 1,142,674. CUSTOM SQUARES. INT. CL. 27. REG. 12-9-1980.
 1,142,683. TRILASTIC. INT. CL. 27. REG. 12-9-1980.
 1,142,696. BUZ-Z-Z-Z DUDLY. INT. CL. 28. REG. 12-9-1980.
 1,142,702. BABY PERT-N-PRETTY. INT. CL. 28. REG. 12-9-1980.
 1,142,707. MISCELLANEOUS DESIGN. INT. CL. 28. REG. 12-9-1980.

- 1,142,710. JAWBREAKER AND DESIGN. INT. CL. 28. REG. 12-9-1980.
- 1,142,717. STRANDEX. INT. CL. 28. REG. 12-9-1980.
- 1,142,724. SLEUTH. INT. CL. 28. REG. 12-9-1980.
- 1,142,734. BATES BREEDERS AND PRODUCERS OF QUALITY AND DESIGN. INT. CL. 29. REG. 12-9-1980.
- 1,142,738. DATARI (STYLIZED). INT. CL. 29. REG. 12-9-1980.
- 1,142,741. HERITAGE HOUSE. INT. CLS. 29 AND 30. REG. 12-9-1980.
- 1,142,743. NY NEDICKS. INT. CL. 29. REG. 12-9-1980.
- 1,142,748. EMPIRE KOSHER POULTRY AND DESIGN. INT. CL. 29. REG. 12-9-1980.
- 1,142,749. EMPIRE KOSHER POULTRY AND DESIGN. INT. CL. 29. REG. 12-9-1980.
- 1,142,751. FISHERMAN'S NET AND DESIGN. INT. CL. 29. REG. 12-9-1980.
- 1,142,755. DEL HAVEN. INT. CL. 29. REG. 12-9-1980.
- 1,142,756. TASTE OF HAWAII (STYLIZED). INT. CLS. 29, 30 AND 32. REG. 12-9-1980.
- 1,142,763. SPRENGEL. INT. CL. 30. REG. 12-9-1980.
- 1,142,764. DULCERAMA AND DESIGN. INT. CL. 30. REG. 12-9-1980.
- 1,142,773. IVOIRIZ. INT. CL. 30. REG. 12-9-1980.
- 1,142,775. HICKORY HEAVEN. INT. CLS. 30 AND 42. REG. 12-9-1980.
- 1,142,792. EI AND DESIGN. INT. CL. 31. REG. 12-9-1980.
- 1,142,797. SKI AND DESIGN. INT. CL. 32. REG. 12-9-1980.
- 1,142,813. CF AND DESIGN. INT. CL. 33. REG. 12-9-1980.
- 1,142,817. WINE WITHOUT GUILT. INT. CL. 33. REG. 12-9-1980.
- 1,142,819. BRUCE FOX DESIGN. INT. CL. 34. REG. 12-9-1980.
- 1,142,822. WA WORLD ART SERVICES AND DESIGN. INT. CLS. 35 AND 42. REG. 12-9-1980.
- 1,142,824. MINIDATA. INT. CL. 35. REG. 12-9-1980.
- 1,142,825. HUDSON'S BAY COMPANY. INT. CL. 35. REG. 12-9-1980.
- 1,142,834. MAP AND DESIGN. INT. CL. 35. REG. 12-9-1980.
- 1,142,839. ALL BID AUCTION. INT. CL. 35. REG. 12-9-1980.
- 1,142,840. HULL AND DESIGN. INT. CL. 35. REG. 12-9-1980.
- 1,142,846. SLIM. INT. CL. 35. REG. 12-9-1980.
- 1,142,848. ROMAC. INT. CL. 35. REG. 12-9-1980.
- 1,142,849. ISOPS I S O P S AND DESIGN. INT. CL. 35. REG. 12-9-1980.
- 1,142,862. PLUS CENTER AND DESIGN. INT. CL. 36. REG. 12-9-1980.
- 1,142,864. THE PRESIDENTS AND DESIGN. INT. CL. 36. REG. 12-9-1980.
- 1,142,865. WASHINGTON INDUSTRIAL BANK. INT. CL. 36. REG. 12-9-1980.
- 1,142,870. MISCELLANEOUS DESIGN. INT. CL. 36. REG. 12-9-1980.
- 1,142,878. HOSPITALITY DIVISION H AND DESIGN. INT. CL. 36. REG. 12-9-1980.
- 1,142,885. A AND DESIGN. INT. CL. 37. REG. 12-9-1980.
- 1,142,893. LAMPTRICIAN. INT. CLS. 37 AND 42. REG. 12-9-1980.
- 1,142,894. THE RUSTICS OF LINDBERGH LAKE. INT. CL. 37. REG. 12-9-1980.
- 1,142,896. JET AIR. INT. CL. 37. REG. 12-9-1980.
- 1,142,898. W-100. INT. CL. 38. REG. 12-9-1980.
- 1,142,900. UST AND DESIGN. INT. CL. 39. REG. 12-9-1980.
- 1,142,901. SUPER SERVICE PROGRAM (STYLIZED). INT. CL. 39. REG. 12-9-1980.
- 1,142,902. SSP AND DESIGN. INT. CL. 39. REG. 12-9-1980.
- 1,142,903. GREAT LAKES TRANSCARIBBEAN LINE. INT. CL. 39. REG. 12-9-1980.
- 1,142,908. KEEPING YOU IN STITCHES. INT. CL. 40. REG. 12-9-1980.
- 1,142,911. JIN SHIN JYUTSU. INT. CL. 41. REG. 12-9-1980.
- 1,142,936. MC 2 (STYLIZED). INT. CL. 42. REG. 12-9-1980.
- 1,142,937. X MEANS I.D. PET. INT. CL. 42. REG. 12-9-1980.
- 1,142,939. MISCELLANEOUS DESIGN. INT. CL. 42. REG. 12-9-1980.
- 1,142,944. MISCELLANEOUS DESIGN. INT. CL. 42. REG. 12-9-1980.
- 1,142,952. AMFAC. INT. CL. 42. REG. 12-9-1980.
- 1,142,960. FLANIGAN'S AND DESIGN. INT. CL. 42. REG. 12-9-1980.
- 1,142,974. STEREO WAREHOUSE. INT. CL. 42. REG. 12-9-1980.
- 1,142,985. CFTC (STYLIZED). INT. CL. 42. REG. 12-9-1980.
- 1,142,986. TSE. INT. CL. 42. REG. 12-9-1980.
- 1,142,989. "YOUR" PIZZA SHOP AND DESIGN. INT. CL. 42. REG. 12-9-1980.
- 1,142,990. RISE TO A BETTER LIFE AND DESIGN. INT. CL. 42. REG. 12-9-1980.
- 1,142,993. DTAC TRUCK AIR CONDITIONING AND DESIGN. INT. CL. 42. REG. 12-9-1980.
- 1,142,994. SASI. INT. CL. 42. REG. 12-9-1980.
- 1,142,995. BONNIE & CLYDE'S. INT. CL. 42. REG. 12-9-1980.
- 1,142,996. VAPOR THERM. INT. CL. 42. REG. 12-9-1980.
- 1,143,000. NUTRI GUIDE. INT. CL. 42. REG. 12-9-1980.
- 1,143,001. THE HAIR PERFORMERS AND DESIGN. INT. CL. 42. REG. 12-9-1980.
- 1,190,389. RING 5. INT. CL. 5 ONLY. REG. 2-23-1982.
- 1,625,470. BST. INT. CL. 1. REG. 12-4-1990.
- 1,625,483. EP-50. INT. CL. 1. REG. 12-4-1990.
- 1,625,484. QUASPERSE 108C. INT. CL. 1. REG. 12-4-1990.
- 1,625,485. QUASPERSE 210. INT. CL. 1. REG. 12-4-1990.
- 1,625,489. MISCELLANEOUS DESIGN. INT. CL. 1. REG. 12-4-1990.
- 1,625,490. USBIOCLEAN. INT. CL. 1. REG. 12-4-1990.
- 1,625,491. LIGHTNING. INT. CL. 1. REG. 12-4-1990.
- 1,625,493. CD-2 MOTOR CURE. INT. CL. 1. REG. 12-4-1990.
- 1,625,496. KAPPA. INT. CL. 1. REG. 12-4-1990.
- 1,625,530. TECK. INT. CL. 3. REG. 12-4-1990.
- 1,625,531. H2O PLUS AND DESIGN. INT. CLS. 3 AND 5. REG. 12-4-1990.
- 1,625,533. WRIGHT'S. INT. CL. 3. REG. 12-4-1990.
- 1,625,539. BUNDEE INTERNATIONAL. INT. CL. 3. REG. 12-4-1990.
- 1,625,543. CLUB CLASSIC. INT. CL. 3. REG. 12-4-1990.
- 1,625,548. SUPER PLASTI-SHEEN. INT. CL. 3. REG. 12-4-1990.
- 1,625,549. CHARLES BOOTH. INT. CL. 3. REG. 12-4-1990.
- 1,625,556. C.E.O.. INT. CL. 3. REG. 12-4-1990.
- 1,625,567. BRITOL. INT. CL. 4. REG. 12-4-1990.
- 1,625,587. SUPER MALIC AND DESIGN. INT. CL. 5. REG. 12-4-1990.
- 1,625,589. TRM AND DESIGN. INT. CL. 5. REG. 12-4-1990.
- 1,625,597. BURN STOP. INT. CL. 5. REG. 12-4-1990.
- 1,625,621. OGRS. INT. CL. 6. REG. 12-4-1990.
- 1,625,622. VCRS-2. INT. CL. 6. REG. 12-4-1990.
- 1,625,630. MONOX-L. INT. CL. 7. REG. 12-4-1990.
- 1,625,631. SAFE T JACK (STYLIZED). INT. CL. 7. REG. 12-4-1990.
- 1,625,635. OSSBERGER. INT. CLS. 7 AND 9. REG. 12-4-1990.
- 1,625,641. CROSS-FLOW. INT. CLS. 7 AND 9. REG. 12-4-1990.
- 1,625,647. H.E.C. (STYLIZED). INT. CL. 7. REG. 12-4-1990.
- 1,625,651. THE HORNET. INT. CL. 7. REG. 12-4-1990.
- 1,625,658. GREENBRIER. INT. CL. 8. REG. 12-4-1990.
- 1,625,665. FYRE-SHIELD. INT. CL. 9. REG. 12-4-1990.
- 1,625,670. GIG. INT. CLS. 9, 16 AND 42. REG. 12-4-1990.
- 1,625,671. RAMCORDER. INT. CL. 9. REG. 12-4-1990.
- 1,625,673. MISCELLANEOUS DESIGN. INT. CL. 9. REG. 12-4-1990.
- 1,625,675. THE RIDER'S GUIDE. INT. CLS. 9 AND 16. REG. 12-4-1990.
- 1,625,678. 4H SAFETY 4 YOU AND DESIGN. INT. CLS. 9, 10 AND 17. REG. 12-4-1990.
- 1,625,682. ONTIME. INT. CL. 9. REG. 12-4-1990.
- 1,625,695. SKYLINX.25. INT. CL. 9. REG. 12-4-1990.
- 1,625,700. CC (STYLIZED). INT. CL. 9. REG. 12-4-1990.
- 1,625,702. R U S H M O R E AND DESIGN. INT. CL. 9. REG. 12-4-1990.
- 1,625,707. MAX RECEPTIONIST. INT. CL. 9. REG. 12-4-1990.
- 1,625,714. VAPOR-SAFE. INT. CL. 9. REG. 12-4-1990.
- 1,625,725. C-PAK. INT. CL. 9. REG. 12-4-1990.
- 1,625,739. THIRD EAR MUSIC. INT. CL. 9. REG. 12-4-1990.
- 1,625,752. LINKTEK. INT. CLS. 9 AND 42. REG. 12-4-1990.
- 1,625,761. MISCELLANEOUS DESIGN. INT. CLS. 9 AND 16. REG. 12-4-1990.

- 1,625,772. EDITVIEW. INT. CL. 9. REG. 12-4-1990.
 1,625,773. MIDINET. INT. CL. 9. REG. 12-4-1990.
 1,625,789. GSX-140. INT. CL. 9. REG. 12-4-1990.
 1,625,796. LABFUSION. INT. CL. 9. REG. 12-4-1990.
 1,625,804. DUPLEX. INT. CL. 9. REG. 12-4-1990.
 1,625,805. LECTON AND DESIGN. INT. CL. 9. REG. 12-4-1990.
 1,625,806. LECTON. INT. CL. 9. REG. 12-4-1990.
 1,625,807. ARMOR-FLEX. INT. CL. 9. REG. 12-4-1990.
 1,625,809. MONOGRAM. INT. CL. 9. REG. 12-4-1990.
 1,625,815. SRM. INT. CL. 9. REG. 12-4-1990.
 1,625,819. META MV. INT. CL. 10. REG. 12-4-1990.
 1,625,840. PARADERM. INT. CL. 10. REG. 12-4-1990.
 1,625,842. DIGIKIT. INT. CL. 10. REG. 12-4-1990.
 1,625,847. GRANSTAND. INT. CL. 10. REG. 12-4-1990.
 1,625,856. WT WALLACE & TIERNAN (STYLIZED). INT. CL. 11. REG. 12-4-1990.
 1,625,862. SP. INT. CL. 11. REG. 12-4-1990.
 1,625,871. SOLAR BEAM. INT. CL. 11. REG. 12-4-1990.
 1,625,904. LOVECRAFT. INT. CL. 14. REG. 12-4-1990.
 1,625,905. HSJ. INT. CL. 14. REG. 12-4-1990.
 1,625,910. ANZ (STYLIZED). INT. CL. 16. REG. 12-4-1990.
 1,625,917. EXCEL. INT. CL. 16. REG. 12-4-1990.
 1,625,926. MISCELLANEOUS DESIGN. INT. CL. 16. REG. 12-4-1990.
 1,625,927. THE NEIGHBORHOOD PHONE BOOK. INT. CL. 16. REG. 12-4-1990.
 1,625,933. HARDNEWS. INT. CL. 16. REG. 12-4-1990.
 1,625,938. MOON BEAR AND DESIGN. INT. CL. 16. REG. 12-4-1990.
 1,625,949. MISCELLANEOUS DESIGN. INT. CL. 16. REG. 12-4-1990.
 1,625,950. ICG INCORPORATED (STYLIZED). INT. CLS. 16 AND 17. REG. 12-4-1990.
 1,625,956. CHERISH. INT. CL. 16. REG. 12-4-1990.
 1,625,967. WHO'S WHO IN AMERICAN SADDLEBREDS. INT. CL. 16. REG. 12-4-1990.
 1,625,969. FOOD MATTERS (STYLIZED). INT. CL. 16. REG. 12-4-1990.
 1,625,972. BLANKBOARDS. INT. CL. 16. REG. 12-4-1990.
 1,625,974. FAST LANE. INT. CL. 16. REG. 12-4-1990.
 1,625,977. POLY-HI. INT. CL. 17. REG. 12-4-1990.
 1,625,980. FABWEL. INT. CL. 17. REG. 12-4-1990.
 1,625,986. MISCELLANEOUS DESIGN. INT. CL. 18. REG. 12-4-1990.
 1,625,989. ROCK-IT CARGO. INT. CL. 18. REG. 12-4-1990.
 1,625,990. FASTTRAK. INT. CL. 19. REG. 12-4-1990.
 1,625,992. DUCK MOULD. INT. CL. 19. REG. 12-4-1990.
 1,625,996. ROLITE. INT. CL. 19. REG. 12-4-1990.
 1,626,009. TOP TANK. INT. CL. 20. REG. 12-4-1990.
 1,626,017. BIG MOUTH AND DESIGN. INT. CL. 21. REG. 12-4-1990.
 1,626,039. CHEE-TOS (STYLIZED). INT. CL. 25. REG. 12-4-1990.
 1,626,045. AVANZATA. INT. CL. 25. REG. 12-4-1990.
 1,626,052. KL BY KARL LAGERFELD (STYLIZED). INT. CL. 25. REG. 12-4-1990.
 1,626,059. VELVET LACE (STYLIZED). INT. CL. 25. REG. 12-4-1990.
 1,626,064. LE SMOCK AND DESIGN. INT. CL. 25. REG. 12-4-1990.
 1,626,075. MOCS AND DESIGN. INT. CL. 25. REG. 12-4-1990.
 1,626,081. BRAETAN KIDS. INT. CL. 25. REG. 12-4-1990.
 1,626,098. BASS-A-HOLIC AND DESIGN. INT. CL. 28. REG. 12-4-1990.
 1,626,116. ACCENTS AND DESIGN. INT. CL. 28. REG. 12-4-1990.
 1,626,142. LA MARCA AND DESIGN. INT. CLS. 29 AND 30. REG. 12-4-1990.
 1,626,143. ALWAYS IN GOOD TASTE... MARGARITA AND DESIGN. INT. CL. 29. REG. 12-4-1990.
 1,626,149. ATOMIC WINGS AUTHENTIC BUFFALO AND DESIGN. INT. CLS. 29 AND 42. REG. 12-4-1990.
 1,626,169. KLOSTERMAN AND DESIGN. INT. CL. 30. REG. 12-4-1990.
 1,626,172. QUALITY HOUSE (STYLIZED). INT. CL. 30. REG. 12-4-1990.
 1,626,174. QUALITY HOUSE. INT. CL. 30. REG. 12-4-1990.
 1,626,184. THUNDERBOLTS. INT. CL. 30. REG. 12-4-1990.
 1,626,200. SOURCE CRYSTAL THE BEST SPRING WATER ON EARTH. INT. CL. 32. REG. 12-4-1990.
 1,626,205. THE BARON'S CSR BY EDMOND DE ROTHSCHILD. INT. CL. 33. REG. 12-4-1990.
 1,626,210. TONDENA MANILA RUM (STYLIZED). INT. CL. 33. REG. 12-4-1990.
 1,626,212. OTOKO SAKE. INT. CL. 33. REG. 12-4-1990.
 1,626,231. Q AND DESIGN. INT. CL. 35. REG. 12-4-1990.
 1,626,233. SAN DIEGO DESIGN CENTER AND DESIGN. INT. CLS. 35 AND 36. REG. 12-4-1990.
 1,626,241. MARINE INDUSTRIES ASSOCIATION OF SOUTH FLORIDA TO KEEP PLEASURE IN BOATING AND DESIGN. INT. CLS. 35 AND 42. REG. 12-4-1990.
 1,626,261. THE PROFESSIONALS. INT. CL. 35. REG. 12-4-1990.
 1,626,268. ENHANCED SPECIAL PROPERTY. INT. CL. 36. REG. 12-4-1990.
 1,626,269. HARRISCARD. INT. CL. 36. REG. 12-4-1990.
 1,626,270. DELAWARE GROUP TAX-FREE FUND. INT. CL. 36. REG. 12-4-1990.
 1,626,272. ALTMAN SIGNATURE APARTMENT HOMES (STYLIZED). INT. CL. 36. REG. 12-4-1990.
 1,626,275. ALLIANCE HEALTH SYSTEMS. INT. CL. 36. REG. 12-4-1990.
 1,626,276. L CALIFORNIA LOTTERY AND DESIGN. INT. CL. 36. REG. 12-4-1990.
 1,626,277. L CALIFORNIA LOTTERY AND DESIGN. INT. CL. 36. REG. 12-4-1990.
 1,626,284. PAYPOWER. INT. CL. 36. REG. 12-4-1990.
 1,626,285. MISCELLANEOUS DESIGN. INT. CLS. 36 AND 37. REG. 12-4-1990.
 1,626,290. CERTAIN FUTURE CD. INT. CL. 36. REG. 12-4-1990.
 1,626,291. CD BUILDER. INT. CL. 36. REG. 12-4-1990.
 1,626,292. RIGHT CHOICE CD. INT. CL. 36. REG. 12-4-1990.
 1,626,294. ISS (STYLIZED). INT. CLS. 37 AND 42. REG. 12-4-1990.
 1,626,303. MISCELLANEOUS DESIGN. INT. CL. 37. REG. 12-4-1990.
 1,626,329. AMERICAN STUDENT TRAVEL AND DESIGN. INT. CL. 39. REG. 12-4-1990.
 1,626,330. BRITRAIL. INT. CL. 39. REG. 12-4-1990.
 1,626,338. RED GIANT. INT. CL. 40. REG. 12-4-1990.
 1,626,341. THE MTS DEVELOPMENT PROCESS FOR SUPERVISORS AND DESIGN. INT. CL. 41. REG. 12-4-1990.
 1,626,342. MISCELLANEOUS DESIGN. INT. CL. 41. REG. 12-4-1990.
 1,626,346. SUN 'N FUN FLY-IN AND DESIGN. INT. CL. 41. REG. 12-4-1990.
 1,626,349. PUTT-PUTT GOLF HAPPY BIRTHDAY FROM PUTT-PUTT GOLF BUSTER AND DESIGN. INT. CL. 41. REG. 12-4-1990.
 1,626,354. REMNANT. INT. CL. 41. REG. 12-4-1990.
 1,626,381. SERVICE AMERICA THE FOOD SERVICE MANAGEMENT PEOPLE AND DESIGN. INT. CL. 42. REG. 12-4-1990.
 1,626,386. MISCELLANEOUS DESIGN. INT. CL. 42. REG. 12-4-1990.
 1,626,399. AMERICAN LIGHTING ASSOCIATION AND DESIGN. INT. CL. 42. REG. 12-4-1990.
 1,626,401. WELLSEIS. INT. CL. 42. REG. 12-4-1990.
 1,626,403. SPEDEX. INT. CL. 42. REG. 12-4-1990.
 1,626,407. SUMP'N SPESHUL. INT. CL. 42. REG. 12-4-1990.
 1,626,427. SAV-RITE. INT. CL. 42. REG. 12-4-1990.
 1,626,464. REFERENCEBOOK. INT. CL. 9. REG. 12-4-1990.
 1,626,465. REFERENCEBENCH. INT. CL. 9. REG. 12-4-1990.
 1,626,466. DIAMONICE. INT. CL. 14. REG. 12-4-1990.
 1,626,474. OFFERINGS IN THE OFFING. INT. CL. 16. REG. 12-4-1990.
 1,714,822. SMART SONIC (STYLIZED). INT. CLS. 1 AND 7. REG. 9-15-1992.
 1,754,657. DOG LOVERS. INT. CL. 16. REG. 2-23-1993.
 1,780,703. TRIP-BITS. INT. CL. 42. REG. 7-6-1993.
 1,781,338. ADELPHI UNIVERSITY. INT. CLS. 16, 20, 21 AND 25. REG. 7-13-1993.

- 1,793,662. MISCELLANEOUS DESIGN. INT. CL. 16. REG. 9-21-1993.
- 1,803,571. FOAM LOCK. INT. CL. 1. REG. 11-9-1993.
- 1,836,279. MISCELLANEOUS DESIGN. INT. CL. 28. REG. 5-10-1994.
- 1,836,654. PAGE 2000. INT. CL. 9. REG. 5-17-1994.
- 1,840,479. RECOMMENDED COUNTRY INNS. INT. CL. 16. REG. 6-21-1994.
- 1,841,280. MBF. INT. CL. 11. REG. 6-21-1994.
- 1,841,710. LISTEN. INT. CL. 9. REG. 6-28-1994.
- 1,853,861. R AND DESIGN. INT. CL. 41. REG. 9-13-1994.
- 1,855,533. DATAMAN. INT. CL. 9. REG. 9-27-1994.
- 1,856,383. MADAME X AND DESIGN. INT. CL. 31. REG. 9-27-1994.
- 1,858,501. WEDECO. INT. CL. 42 ONLY. REG. 10-18-1994.
- 1,858,693. SWISS USA. INT. CL. 26. REG. 10-18-1994.
- 1,859,827. LUCILLE FARMS. INT. CL. 29. REG. 10-25-1994.
- 1,860,702. SKC (STYLIZED). INT. CL. 9. REG. 11-1-1994.
- 1,863,789. CHUBB'S BRO'S. INT. CL. 25. REG. 11-22-1994.
- 1,865,490. MISCELLANEOUS DESIGN. INT. CLS. 1 AND 2. REG. 12-6-1994.
- 1,865,491. FENCE. INT. CLS. 1 AND 5. REG. 12-6-1994.
- 1,865,497. CEA GROUP AND DESIGN. INT. CL. 1. REG. 12-6-1994.
- 1,865,512. ALLSLOW. INT. CL. 2. REG. 12-6-1994.
- 1,865,513. UNCLE BIRTHDAY AND DESIGN. INT. CLS. 3, 9, 16, 28 AND 35. REG. 12-6-1994.
- 1,865,514. ORIENTAL GINSENG CREAM (STYLIZED). INT. CL. 3. REG. 12-6-1994.
- 1,865,517. DICKENSCENT. INT. CL. 3. REG. 12-6-1994.
- 1,865,518. AROMATHERAPY BODY OILS BODY BLENDS "BATH AND BODY OILS" AND DESIGN. INT. CL. 3. REG. 12-6-1994.
- 1,865,519. LEA COSMETICS INTERNATIONAL PERSONAL CARE SYSTEMS AND DESIGN. INT. CL. 3. REG. 12-6-1994.
- 1,865,523. SUNNY SQUARE AND DESIGN. INT. CLS. 3, 4, 5, 6, 10, 16, 21, 29, 30, 31 AND 32. REG. 12-6-1994.
- 1,865,524. FLARE. INT. CL. 3. REG. 12-6-1994.
- 1,865,525. LOVE'S CLEAN & NATURAL. INT. CL. 3. REG. 12-6-1994.
- 1,865,527. UNI-CHARM AND DESIGN. INT. CL. 3. REG. 12-6-1994.
- 1,865,529. GLUETISS. INT. CL. 5. REG. 12-6-1994.
- 1,865,531. EFAMAST. INT. CL. 5. REG. 12-6-1994.
- 1,865,535. IMMUNOQUEST. INT. CL. 5. REG. 12-6-1994.
- 1,865,537. I V ONE (STYLIZED). INT. CL. 5. REG. 12-6-1994.
- 1,865,541. KH-6. INT. CL. 5. REG. 12-6-1994.
- 1,865,542. PELT. INT. CL. 5. REG. 12-6-1994.
- 1,865,543. WIMEX AND DESIGN. INT. CLS. 5 AND 10. REG. 12-6-1994.
- 1,865,544. FRONTLINE. INT. CL. 5. REG. 12-6-1994.
- 1,865,545. PUSH PERFORMANCE AND DESIGN. INT. CL. 5. REG. 12-6-1994.
- 1,865,546. ANTIHEBSCELL-NEO. INT. CL. 5. REG. 12-6-1994.
- 1,865,547. PLAX AND DESIGN. INT. CL. 5. REG. 12-6-1994.
- 1,865,549. BP BOCK (STYLIZED). INT. CL. 5. REG. 12-6-1994.
- 1,865,552. EXGEST LA. INT. CL. 5. REG. 12-6-1994.
- 1,865,555. CRAVIT (STYLIZED). INT. CL. 5. REG. 12-6-1994.
- 1,865,563. OMNI. INT. CLS. 6 AND 20. REG. 12-6-1994.
- 1,865,569. HYDRO FLIGHT. INT. CL. 6. REG. 12-6-1994.
- 1,865,571. TIGHT TUBES AND DESIGN. INT. CL. 7. REG. 12-6-1994.
- 1,865,572. JETSUB. INT. CL. 7. REG. 12-6-1994.
- 1,865,573. EASYRAKE AND DESIGN. INT. CL. 7. REG. 12-6-1994.
- 1,865,575. ST AND DESIGN. INT. CL. 7. REG. 12-6-1994.
- 1,865,580. VE-VAC (STYLIZED). INT. CL. 7. REG. 12-6-1994.
- 1,865,582. AT&G. INT. CL. 8. REG. 12-6-1994.
- 1,865,586. SEND->IT! (STYLIZED). INT. CL. 9. REG. 12-6-1994.
- 1,865,588. DECISION MASTER. INT. CL. 9. REG. 12-6-1994.
- 1,865,589. MISCELLANEOUS DESIGN. INT. CLS. 9, 37 AND 41. REG. 12-6-1994.
- 1,865,591. PARAFLOW. INT. CL. 9. REG. 12-6-1994.
- 1,865,592. MONAAD AND DESIGN. INT. CLS. 9 AND 20. REG. 12-6-1994.
- 1,865,593. E STEP WATCH AND DESIGN. INT. CL. 9. REG. 12-6-1994.
- 1,865,595. SAVIT AND DESIGN. INT. CL. 9. REG. 12-6-1994.
- 1,865,596. CAL AND DESIGN. INT. CLS. 9, 37 AND 42. REG. 12-6-1994.
- 1,865,597. KAIMS (STYLIZED). INT. CL. 9. REG. 12-6-1994.
- 1,865,598. HR/LINK. INT. CL. 9. REG. 12-6-1994.
- 1,865,599. TURBO BOOKS AND DESIGN. INT. CL. 9. REG. 12-6-1994.
- 1,865,601. CHRISTIAN AUJARD AND DESIGN. INT. CLS. 9, 14, 18, 25 AND 34. REG. 12-6-1994.
- 1,865,604. CALL JAM. INT. CL. 9. REG. 12-6-1994.
- 1,865,605. CELLXSHIELD. INT. CL. 9. REG. 12-6-1994.
- 1,865,609. GLOBAL CONSENSUS, INC. INT. CL. 9. REG. 12-6-1994.
- 1,865,610. Q'CASE AND DESIGN. INT. CL. 9. REG. 12-6-1994.
- 1,865,611. MISCELLANEOUS DESIGN. INT. CL. 9. REG. 12-6-1994.
- 1,865,612. DEALERMASTER. INT. CL. 9. REG. 12-6-1994.
- 1,865,613. WEIGHMASTER. INT. CL. 9. REG. 12-6-1994.
- 1,865,614. MERCHANTS FAST RATE. INT. CL. 9. REG. 12-6-1994.
- 1,865,616. THOMAS SCHREDER LIGHTING (STYLIZED). INT. CL. 9. REG. 12-6-1994.
- 1,865,619. MAPCHART. INT. CL. 9. REG. 12-6-1994.
- 1,865,622. ABSOLUTE PERFORMANCE. INT. CLS. 9, 10, 40 AND 42. REG. 12-6-1994.
- 1,865,623. DUALDOT (STYLIZED). INT. CL. 9. REG. 12-6-1994.
- 1,865,624. FAX RESOURCE. INT. CL. 9. REG. 12-6-1994.
- 1,865,629. PET NET AND DESIGN. INT. CL. 9. REG. 12-6-1994.
- 1,865,630. UBIQUITOUS. INT. CL. 9. REG. 12-6-1994.
- 1,865,631. SUPER TURBO DUSTER. INT. CL. 9. REG. 12-6-1994.
- 1,865,632. PC*PRO AND DESIGN. INT. CL. 9. REG. 12-6-1994.
- 1,865,633. TOUCHBET KENO TERMINAL 200. INT. CL. 9. REG. 12-6-1994.
- 1,865,636. PRO DECK. INT. CL. 9. REG. 12-6-1994.
- 1,865,638. INFINITY CELL. INT. CL. 9. REG. 12-6-1994.
- 1,865,640. WORLDKIT. INT. CL. 9. REG. 12-6-1994.
- 1,865,643. MIGHTYMAK (STYLIZED). INT. CL. 9. REG. 12-6-1994.
- 1,865,645. MISCELLANEOUS DESIGN. INT. CL. 9. REG. 12-6-1994.
- 1,865,646. MISCELLANEOUS DESIGN. INT. CL. 9. REG. 12-6-1994.
- 1,865,647. RAIS. INT. CL. 9. REG. 12-6-1994.
- 1,865,648. SEEDPAK3. INT. CL. 9. REG. 12-6-1994.
- 1,865,650. PARAPRO. INT. CL. 9. REG. 12-6-1994.
- 1,865,651. MISCELLANEOUS DESIGN. INT. CL. 9. REG. 12-6-1994.
- 1,865,652. CELL TIME JAPAN AND DESIGN. INT. CL. 9. REG. 12-6-1994.
- 1,865,653. GTPRO. INT. CL. 9. REG. 12-6-1994.
- 1,865,657. CADTEX. INT. CL. 9. REG. 12-6-1994.
- 1,865,658. GTMASTER. INT. CL. 9. REG. 12-6-1994.
- 1,865,659. COLOREDGE. INT. CL. 9. REG. 12-6-1994.
- 1,865,661. ANTON PAAR USA (STYLIZED). INT. CL. 9. REG. 12-6-1994.
- 1,865,662. MAX. INT. CL. 9. REG. 12-6-1994.
- 1,865,663. CM AND DESIGN. INT. CL. 9. REG. 12-6-1994.
- 1,865,668. BROKERLINK THE OFFICIAL IC STOCK EXCHANGE (STYLIZED). INT. CL. 9. REG. 12-6-1994.
- 1,865,669. INSOURCE AND DESIGN. INT. CL. 9. REG. 12-6-1994.
- 1,865,672. VIBRA PLUS. INT. CL. 9. REG. 12-6-1994.
- 1,865,675. OCEAN ISLE SOFTWARE. INT. CL. 9. REG. 12-6-1994.
- 1,865,681. HILINE. INT. CL. 9. REG. 12-6-1994.
- 1,865,684. EMS 2000 AND DESIGN. INT. CLS. 10, 28 AND 41. REG. 12-6-1994.
- 1,865,689. DROPLET. INT. CL. 10. REG. 12-6-1994.
- 1,865,694. MERCURY'S PHILLIPS LARYNGOSCOPE. INT. CL. 10. REG. 12-6-1994.

- 1,865,699. NEOCOLD. INT. CL. 10. REG. 12-6-1994.
 1,865,705. CIW. INT. CL. 10. REG. 12-6-1994.
 1,865,706. HMSA. INT. CL. 10. REG. 12-6-1994.
 1,865,708. SELECT ONE. INT. CL. 10. REG. 12-6-1994.
 1,865,709. ULTRAMISTER (STYLIZED). INT. CL. 11. REG. 12-6-1994.
 1,865,710. HALOPLATE AND DESIGN. INT. CL. 11. REG. 12-6-1994.
 1,865,713. CRYSTALTAP. INT. CL. 11. REG. 12-6-1994.
 1,865,714. HEAT SWEEP. INT. CL. 11. REG. 12-6-1994.
 1,865,717. ACCUFIT WELDED. INT. CL. 11. REG. 12-6-1994.
 1,865,719. SELECT 12. INT. CL. 11. REG. 12-6-1994.
 1,865,720. SELECT 10. INT. CL. 11. REG. 12-6-1994.
 1,865,724. READY TO LINE. INT. CL. 12. REG. 12-6-1994.
 1,865,728. STRANGE ORDNANCE. INT. CL. 13. REG. 12-6-1994.
 1,865,731. CIVITAN INTERNATIONAL C AND DESIGN. INT. CLS. 14, 16, 25 AND 42. REG. 12-6-1994.
 1,865,733. LUMINESS. INT. CL. 14. REG. 12-6-1994.
 1,865,740. CECIL. INT. CL. 14. REG. 12-6-1994.
 1,865,741. COLLEZIO AND DESIGN. INT. CL. 14. REG. 12-6-1994.
 1,865,742. MISCELLANEOUS DESIGN. INT. CL. 14. REG. 12-6-1994.
 1,865,743. THE VENERABLE BEAD AND DESIGN. INT. CL. 14. REG. 12-6-1994.
 1,865,744. N. S. C. .925 AND DESIGN. INT. CL. 14. REG. 12-6-1994.
 1,865,745. J14K. INT. CL. 14. REG. 12-6-1994.
 1,865,747. S & S AND DESIGN. INT. CL. 16. REG. 12-6-1994.
 1,865,748. MOVIE MATE AND DESIGN. INT. CL. 16. REG. 12-6-1994.
 1,865,750. TWO-TEN AND DESIGN. INT. CLS. 16, 35, 36, 38, 41 AND 42. REG. 12-6-1994.
 1,865,752. YELLOW PAGES OF SKIING. INT. CL. 16. REG. 12-6-1994.
 1,865,753. DELOVIE LYUDI. INT. CL. 16. REG. 12-6-1994.
 1,865,754. ASTHMA & ALLERGY FOUNDATION OF AMERICA. INT. CLS. 16, 36, 41 AND 42. REG. 12-6-1994.
 1,865,755. QUAD/FAX. INT. CL. 16. REG. 12-6-1994.
 1,865,758. PARENT RESOURCE AND DESIGN. INT. CL. 16. REG. 12-6-1994.
 1,865,760. TAMBORA Y BANDA. INT. CL. 16. REG. 12-6-1994.
 1,865,764. TRAVEL MEMORIES AND DESIGN. INT. CL. 16. REG. 12-6-1994.
 1,865,765. CAROLINA ON WHEELS AND DESIGN. INT. CL. 16. REG. 12-6-1994.
 1,865,766. KOREAN YELLOW PAGES AND DESIGN. INT. CL. 16. REG. 12-6-1994.
 1,865,767. LOGISTICS TODAY. INT. CL. 16. REG. 12-6-1994.
 1,865,769. NATURE'S ECHO (STYLIZED). INT. CLS. 16 AND 25. REG. 12-6-1994.
 1,865,772. ESSENTIAL FM. INT. CL. 16. REG. 12-6-1994.
 1,865,773. MACARONI KIDS. INT. CL. 16. REG. 12-6-1994.
 1,865,777. COAST TO COAST. INT. CL. 16. REG. 12-6-1994.
 1,865,778. DINING OPTIONS. INT. CL. 16. REG. 12-6-1994.
 1,865,779. THE INVESTIGATOR'S CLUB. INT. CL. 16. REG. 12-6-1994.
 1,865,783. FIBERPERL. INT. CL. 17. REG. 12-6-1994.
 1,865,786. FI FABRICS INTERNATIONAL AND DESIGN. INT. CLS. 18 AND 24. REG. 12-6-1994.
 1,865,787. ENGLISH ROSE. INT. CL. 18. REG. 12-6-1994.
 1,865,788. B AND DESIGN. INT. CL. 18. REG. 12-6-1994.
 1,865,790. TIDY TRAVELER USEFUL PRODUCTS-LOS GATOS, CA 95032 AND DESIGN. INT. CL. 18. REG. 12-6-1994.
 1,865,791. THERMOLENE. INT. CL. 19. REG. 12-6-1994.
 1,865,797. PROJECT:FX. INT. CL. 20. REG. 12-6-1994.
 1,865,798. CRUISE'N'SNOOZE. INT. CL. 20. REG. 12-6-1994.
 1,865,799. COMFORT POCKETS. INT. CL. 20. REG. 12-6-1994.
 1,865,800. RAINSONG. INT. CL. 20. REG. 12-6-1994.
 1,865,801. SURFSONG. INT. CL. 20. REG. 12-6-1994.
 1,865,802. BROOKSONG. INT. CL. 20. REG. 12-6-1994.
 1,865,803. SHORE CORD CADDY AND DESIGN. INT. CL. 20. REG. 12-6-1994.
 1,865,804. JOHN GREENLEAF FURNITURE AND DESIGN. INT. CL. 20. REG. 12-6-1994.
 1,865,805. UNIWORX. INT. CL. 20. REG. 12-6-1994.
 1,865,808. FAST HINGES. INT. CL. 20. REG. 12-6-1994.
 1,865,809. PAW PRINTS. INT. CL. 20. REG. 12-6-1994.
 1,865,811. KIDNIC. INT. CL. 20. REG. 12-6-1994.
 1,865,812. COMICASE. INT. CL. 20. REG. 12-6-1994.
 1,865,813. FRIENDLY FOSSILS. INT. CL. 20. REG. 12-6-1994.
 1,865,814. AUTO VISIONS. INT. CL. 20. REG. 12-6-1994.
 1,865,818. DESIGNED TO HAVE EVERYTHING EXCEPT AN EQUAL. INT. CL. 20. REG. 12-6-1994.
 1,865,821. PURE INSTINCT. INT. CLS. 21 AND 25. REG. 12-6-1994.
 1,865,822. AMERICAN BY DESIGN INTERNATIONAL BY STYLE. INT. CL. 21. REG. 12-6-1994.
 1,865,825. THERMO-ROLL. INT. CL. 21. REG. 12-6-1994.
 1,865,826. OPUS KIDS. INT. CL. 21. REG. 12-6-1994.
 1,865,827. BOTANICA. INT. CL. 21. REG. 12-6-1994.
 1,865,832. MISCELLANEOUS DESIGN. INT. CL. 25. REG. 12-6-1994.
 1,865,835. CONDOMANIA. INT. CL. 25. REG. 12-6-1994.
 1,865,837. MASS CONFUSION!. INT. CL. 25. REG. 12-6-1994.
 1,865,839. BORACHO BOYZ. INT. CL. 25. REG. 12-6-1994.
 1,865,840. PRINT PRESSION (STYLIZED). INT. CL. 25. REG. 12-6-1994.
 1,865,841. WHAT'S THE BIG IDEA. INT. CL. 25. REG. 12-6-1994.
 1,865,842. AMERICA'S BEST SOCKS. INT. CL. 25. REG. 12-6-1994.
 1,865,844. SPORTSWEAR BY COUNTRY TOUCH AND DESIGN. INT. CL. 25. REG. 12-6-1994.
 1,865,845. NORTHFIELD TRADING. INT. CL. 25. REG. 12-6-1994.
 1,865,847. GLORYGASSOL. INT. CL. 25. REG. 12-6-1994.
 1,865,849. COME WALK WITH U.S. AND DESIGN. INT. CL. 25. REG. 12-6-1994.
 1,865,850. BONE COVERS (STYLIZED). INT. CL. 25. REG. 12-6-1994.
 1,865,851. MATAKE. INT. CL. 25. REG. 12-6-1994.
 1,865,852. COOL MASCOT AND DESIGN. INT. CL. 25. REG. 12-6-1994.
 1,865,853. WORLD ATHLETIC CLUB USA AND DESIGN. INT. CL. 25. REG. 12-6-1994.
 1,865,855. HOT SOX AND DESIGN. INT. CL. 25. REG. 12-6-1994.
 1,865,856. DIAMOND A RANCHWEAR. INT. CL. 25. REG. 12-6-1994.
 1,865,857. PANTROPIC (STYLIZED). INT. CL. 25. REG. 12-6-1994.
 1,865,858. MEGA SAFE THE POWER IN SAFETY AND DESIGN. INT. CL. 25. REG. 12-6-1994.
 1,865,860. INLINE WEAR AND DESIGN. INT. CL. 25. REG. 12-6-1994.
 1,865,865. BY GRANDMA (STYLIZED). INT. CL. 25. REG. 12-6-1994.
 1,865,866. BARBWIRE'S. INT. CL. 25. REG. 12-6-1994.
 1,865,867. SPANGLES. INT. CL. 26. REG. 12-6-1994.
 1,865,868. ADINA. INT. CL. 26. REG. 12-6-1994.
 1,865,869. REMARKABLY COLORFUL AND DESIGN. INT. CLS. 27 AND 42. REG. 12-6-1994.
 1,865,872. DRUM SHOE AND DESIGN. INT. CL. 27. REG. 12-6-1994.
 1,865,874. TARGETBALL AND DESIGN. INT. CL. 28. REG. 12-6-1994.
 1,865,875. MEDALS & MILLIONS. INT. CL. 28. REG. 12-6-1994.
 1,865,879. AFRINOPOLY. INT. CL. 28. REG. 12-6-1994.
 1,865,883. HANGTIME AND DESIGN. INT. CL. 28. REG. 12-6-1994.
 1,865,885. YARDARANG. INT. CL. 28. REG. 12-6-1994.
 1,865,890. MISCELLANEOUS DESIGN. INT. CL. 29. REG. 12-6-1994.
 1,865,894. PACIFIC PEARL. INT. CL. 29. REG. 12-6-1994.
 1,865,895. SEASIDE SINCE 1919 AND DESIGN. INT. CL. 29. REG. 12-6-1994.
 1,865,897. CARR'S MINI CROISSANT SNACKS. INT. CL. 30. REG. 12-6-1994.

- 1,865,898. MISCELLANEOUS DESIGN. INT. CL. 30. REG. 12-6-1994.
- 1,865,901. T & H. INT. CL. 30. REG. 12-6-1994.
- 1,865,902. CRYSTAL SUGAR AND DESIGN. INT. CL. 30. REG. 12-6-1994.
- 1,865,904. PRIVATE ROASTERS. INT. CL. 30. REG. 12-6-1994.
- 1,865,906. BARBWIRE'S. INT. CL. 30. REG. 12-6-1994.
- 1,865,907. SIMPLICITY. INT. CL. 31. REG. 12-6-1994.
- 1,865,910. SECOND TO NONE. INT. CL. 31. REG. 12-6-1994.
- 1,865,915. REGINE. INT. CL. 31. REG. 12-6-1994.
- 1,865,916. ATLANTIC FRESH. INT. CL. 31. REG. 12-6-1994.
- 1,865,918. DJ DOTSON TRIPLE SEC. INT. CL. 32. REG. 12-6-1994.
- 1,865,920. ROYAL EXPORT CERES AND DESIGN. INT. CL. 32. REG. 12-6-1994.
- 1,865,923. ARISTOFF THE ARISTOCRAT OF VODKA AND DESIGN. INT. CL. 33. REG. 12-6-1994.
- 1,865,926. CASTLE CREEK. INT. CL. 33. REG. 12-6-1994.
- 1,865,927. HNS HIVNET. INT. CL. 35. REG. 12-6-1994.
- 1,865,929. LABSTAFFERS. INT. CL. 35. REG. 12-6-1994.
- 1,865,930. LEGAL COPIES INTERNATIONAL AND DESIGN. INT. CL. 35. REG. 12-6-1994.
- 1,865,932. INTERNATIONAL CONCIERGE. INT. CL. 35. REG. 12-6-1994.
- 1,865,933. STRATEGISTS' STRATEGISTS. INT. CL. 35. REG. 12-6-1994.
- 1,865,937. SUCCESS IS KNOWING WHERE TO SHOW UP. INT. CL. 35. REG. 12-6-1994.
- 1,865,939. TEX-FURN. INT. CL. 35. REG. 12-6-1994.
- 1,865,940. ACTION USA INC AND DESIGN. INT. CL. 35. REG. 12-6-1994.
- 1,865,941. EMPLOYERS TRUST. INT. CLS. 35 AND 36. REG. 12-6-1994.
- 1,865,943. ANSWER ONE AND DESIGN. INT. CL. 35. REG. 12-6-1994.
- 1,865,944. MASTervalUES MASTERCARD AND DESIGN. INT. CL. 35. REG. 12-6-1994.
- 1,865,945. SMARTREPORTS. INT. CL. 35. REG. 12-6-1994.
- 1,865,949. B9D. INT. CL. 35. REG. 12-6-1994.
- 1,865,950. AUTOEDGE. INT. CLS. 35, 36 AND 39. REG. 12-6-1994.
- 1,865,952. FREIGHT BROKERS INTERNATIONAL. INT. CLS. 36 AND 39. REG. 12-6-1994.
- 1,865,953. GENERAL HEALTH SYSTEM. INT. CLS. 36, 41 AND 42. REG. 12-6-1994.
- 1,865,955. PLATINUM ADVANTAGE. INT. CL. 36. REG. 12-6-1994.
- 1,865,958. IMPROVED RISK. INT. CL. 36. REG. 12-6-1994.
- 1,865,959. WE SEE FARTHER.. INT. CL. 36. REG. 12-6-1994.
- 1,865,960. TRANSAMERICA HOMEFIRST. INT. CL. 36. REG. 12-6-1994.
- 1,865,965. MAS DE 120 ANOS UNIENDO FAMILIAS (STYLIZED). INT. CL. 36. REG. 12-6-1994.
- 1,865,966. TRANSTAR MORTGAGE (STYLIZED). INT. CL. 36. REG. 12-6-1994.
- 1,865,970. PRINCASH. INT. CL. 36. REG. 12-6-1994.
- 1,865,971. THE MORTGAGE SHOPPE "PERSONALIZED MORTGAGE LENDING" M AND DESIGN. INT. CL. 36. REG. 12-6-1994.
- 1,865,973. YOUR ARIZONA CONNECTION. INT. CL. 36. REG. 12-6-1994.
- 1,865,974. SKYLINE EUROPE PORTFOLIO. INT. CL. 36. REG. 12-6-1994.
- 1,865,975. PHILANTHROGROUP. INT. CL. 36. REG. 12-6-1994.
- 1,865,976. DUEL IN THE DOME. INT. CL. 36. REG. 12-6-1994.
- 1,865,981. WOODEN THUMB. INT. CL. 37. REG. 12-6-1994.
- 1,865,984. AMERISTAR AND DESIGN. INT. CL. 37. REG. 12-6-1994.
- 1,865,986. MISCELLANEOUS DESIGN. INT. CL. 37. REG. 12-6-1994.
- 1,865,987. FREEDOM PAGER. INT. CL. 38. REG. 12-6-1994.
- 1,865,989. ARROW 93 FM ALL ROCK & ROLL OLDIES AND DESIGN. INT. CL. 38. REG. 12-6-1994.
- 1,865,991. AMATEUR RADIO LEMURIAN ORDER OF PUPULE AND DESIGN. INT. CL. 38. REG. 12-6-1994.
- 1,865,992. LATELCO AND DESIGN. INT. CL. 38. REG. 12-6-1994.
- 1,865,995. FRIENDS AROUND THE WORLD ANYTIME AND DESIGN. INT. CL. 38. REG. 12-6-1994.
- 1,865,996. A AND DESIGN. INT. CL. 39. REG. 12-6-1994.
- 1,865,997. PENN VALLEY FARMS AND DESIGN. INT. CL. 39. REG. 12-6-1994.
- 1,865,998. JUST HOOK IT AND DESIGN. INT. CL. 39. REG. 12-6-1994.
- 1,866,003. QUALITY BULK NETWORK. INT. CL. 39. REG. 12-6-1994.
- 1,866,005. TECHNOLOGIES FOR SHAPING AND MOVING INFORMATION. INT. CL. 40. REG. 12-6-1994.
- 1,866,006. FIRST RECOVERY AND DESIGN. INT. CL. 40. REG. 12-6-1994.
- 1,866,008. FREUDIANA AND DESIGN. INT. CL. 41. REG. 12-6-1994.
- 1,866,009. VICI. INT. CLS. 41 AND 42. REG. 12-6-1994.
- 1,866,011. NEW EAST RECORDS AND DESIGN. INT. CL. 41. REG. 12-6-1994.
- 1,866,012. VITRO (STYLIZED). INT. CL. 41. REG. 12-6-1994.
- 1,866,015. PUDDLE. INT. CL. 41. REG. 12-6-1994.
- 1,866,016. MR. POSITIVE. INT. CL. 41. REG. 12-6-1994.
- 1,866,017. CREEPSHOW (STYLIZED). INT. CL. 41. REG. 12-6-1994.
- 1,866,019. NEON NELL. INT. CL. 41. REG. 12-6-1994.
- 1,866,020. AIR ADVENTURES. INT. CL. 41. REG. 12-6-1994.
- 1,866,021. DIRT MERCHANTS. INT. CL. 41. REG. 12-6-1994.
- 1,866,022. NO CHASER (STYLIZED). INT. CL. 41. REG. 12-6-1994.
- 1,866,023. LUCIDREADING. INT. CL. 41. REG. 12-6-1994.
- 1,866,024. FANTASY STABLES. INT. CL. 41. REG. 12-6-1994.
- 1,866,025. KITSAP COLOR CLASSIC. INT. CL. 41. REG. 12-6-1994.
- 1,866,027. THE CUSTOMER MAP ROAD TO SATISFACTION. INT. CL. 41. REG. 12-6-1994.
- 1,866,030. THE ALL-AMERICAN ALARM CLOCK. INT. CL. 41. REG. 12-6-1994.
- 1,866,032. ENERGY EXPRESS. INT. CL. 41. REG. 12-6-1994.
- 1,866,034. WOMAN'S WAY SELF-DEFENSE. INT. CL. 41. REG. 12-6-1994.
- 1,866,035. SUICIDE KINGS. INT. CL. 41. REG. 12-6-1994.
- 1,866,037. ALBANY POLECATS. INT. CL. 41. REG. 12-6-1994.
- 1,866,038. ONE ON WINE. INT. CL. 41. REG. 12-6-1994.
- 1,866,041. FAXAJOB. INT. CL. 42. REG. 12-6-1994.
- 1,866,043. THE ARTHUR W. PAGE SOCIETY. INT. CL. 42. REG. 12-6-1994.
- 1,866,044. ALLNU PRE-OWNED CARS. INT. CL. 42. REG. 12-6-1994.
- 1,866,045. SAN FRANCISCO BAY BLACKHAWKS PRO SOCCER AND DESIGN. INT. CL. 42. REG. 12-6-1994.
- 1,866,046. VICI CAPILLI. INT. CL. 42. REG. 12-6-1994.
- 1,866,048. T.J.'S SPORTS GARDEN AND RESTAURANT. INT. CL. 42. REG. 12-6-1994.
- 1,866,051. SIGNAL AND DESIGN. INT. CL. 42. REG. 12-6-1994.
- 1,866,052. DAKA RESTAURANTS AND DESIGN. INT. CL. 42. REG. 12-6-1994.
- 1,866,053. ZORN'S (STYLIZED). INT. CL. 42. REG. 12-6-1994.
- 1,866,054. OLIVE OIL'S AND DESIGN. INT. CL. 42. REG. 12-6-1994.
- 1,866,055. VITA SYSTEMS. INT. CL. 42. REG. 12-6-1994.
- 1,866,056. H.A.C.. INT. CL. 42. REG. 12-6-1994.
- 1,866,058. ARA HUMAN FACTORS AND DESIGN. INT. CL. 42. REG. 12-6-1994.
- 1,866,059. SKATE 2000. INT. CL. 42. REG. 12-6-1994.
- 1,866,061. TRIANGLE LABS. INT. CL. 42. REG. 12-6-1994.
- 1,866,062. TRIANGLE LABORATORIES, INC.. INT. CL. 42. REG. 12-6-1994.
- 1,866,064. CREATIVE PRINTING AND DESIGN. INT. CL. 42. REG. 12-6-1994.
- 1,866,065. LADY 'N WAITING AND DESIGN. INT. CL. 42. REG. 12-6-1994.

- 1,866,067. MONTECARE. INT. CL. 42. REG. 12-6-1994.
 1,866,070. KILLER BURRITOS. INT. CL. 42. REG. 12-6-1994.
 1,866,077. SOURCE OF WONDER. INT. CL. 42. REG. 12-6-1994.
 1,866,080. LINK. INT. CL. 42. REG. 12-6-1994.
 1,866,084. OCCUPATIONAL HEALTH CARE ACMH AND DESIGN. INT. CL. 42. REG. 12-6-1994.
 1,866,085. GOLD COAT EXPRESS. INT. CL. 42. REG. 12-6-1994.
 1,866,086. MISCELLANEOUS DESIGN. INT. CL. 42. REG. 12-6-1994.
 1,866,090. JIM N' JOHNNYS'. INT. CL. 42. REG. 12-6-1994.
 1,866,092. NATIONAL PARTS & ACCESSORY HEAD-QUARTERS. INT. CL. 42. REG. 12-6-1994.
 1,866,093. HOW-TO U. INT. CL. 42. REG. 12-6-1994.
 1,866,099. GIVING BEATS EVERYTHING!. INT. CL. 42. REG. 12-6-1994.
 1,866,100. SOLSTAR. INT. CL. 42. REG. 12-6-1994.
 1,866,104. ELKA AND DESIGN. INT. CL. 42. REG. 12-6-1994.
 1,866,108. TOTER WORKSAVER. INT. CLS. 7 AND 12. REG. 12-6-1994.
 1,866,112. LIBERTY CAREFIRST AND DESIGN. INT. CLS. 36 AND 42. REG. 12-6-1994.
 1,866,117. EUROPEAN COLLECTION. INT. CLS. 9 AND 11. REG. 12-6-1994.
 1,866,118. JERS. INT. CLS. 9 AND 16. REG. 12-6-1994.
 1,866,119. AIX/ESA. INT. CLS. 9 AND 16. REG. 12-6-1994.
 1,866,120. SALONNAIL 3. INT. CLS. 3 AND 11. REG. 12-6-1994.
 1,866,122. RAVE RANDOM ACCESS VIDEODISC EDUCATION AND DESIGN. INT. CLS. 35 AND 41. REG. 12-6-1994.
 1,866,124. HARRAHS CASINO JOLIET AND DESIGN. INT. CLS. 39, 41 AND 42. REG. 12-6-1994.
 1,866,130. INTEGRATED QUALITY MARKETING SYSTEM. INT. CLS. 35 AND 42. REG. 12-6-1994.
 1,866,131. YIKES!. INT. CLS. 12 AND 28. REG. 12-6-1994.
 1,866,133. CHAOSS. INT. CLS. 9 AND 16. REG. 12-6-1994.
 1,866,134. KELYA. INT. CLS. 27 AND 42. REG. 12-6-1994.
 1,866,135. THE WELLNESS COMMUNITY. INT. CLS. 41 AND 42. REG. 12-6-1994.
 1,866,138. LAN2WAN. INT. CLS. 37 AND 42. REG. 12-6-1994.
 1,866,141. KIDS' ARMY. INT. CLS. 16, 25 AND 28. REG. 12-6-1994.
 1,866,143. KITCHEN'S BEST. INT. CLS. 7 AND 11. REG. 12-6-1994.
 1,866,148. EARTH-GUARD. INT. CL. 1. REG. 12-6-1994.
 1,866,155. V-FINER. INT. CL. 1. REG. 12-6-1994.
 1,866,156. DURAPLAS. INT. CL. 2. REG. 12-6-1994.
 1,866,157. MISCELLANEOUS DESIGN. INT. CL. 2. REG. 12-6-1994.
 1,866,158. SUPIROX. INT. CL. 2. REG. 12-6-1994.
 1,866,161. MAY FLOWERS. INT. CL. 3. REG. 12-6-1994.
 1,866,166. SALONESSENCE. INT. CL. 3. REG. 12-6-1994.
 1,866,167. JETLINER. INT. CL. 3. REG. 12-6-1994.
 1,866,168. PRETTY POWDER. INT. CL. 3. REG. 12-6-1994.
 1,866,169. BALANCE WATER. INT. CL. 3. REG. 12-6-1994.
 1,866,171. HR HELENA RUBINSTEIN SUBLIMESCENCE (STYLIZED). INT. CL. 3. REG. 12-6-1994.
 1,866,172. ICE MONTEIL AND DESIGN. INT. CL. 3. REG. 12-6-1994.
 1,866,174. GLOVEMATE. INT. CL. 3. REG. 12-6-1994.
 1,866,175. BIORESPONSIVE. INT. CL. 3. REG. 12-6-1994.
 1,866,177. CAMOFORCE (STYLIZED). INT. CL. 5. REG. 12-6-1994.
 1,866,179. COZAAREX. INT. CL. 5. REG. 12-6-1994.
 1,866,181. AQUABLOK. INT. CL. 5. REG. 12-6-1994.
 1,866,184. FLEACOMBER. INT. CL. 5. REG. 12-6-1994.
 1,866,188. BIO-PATH AND DESIGN. INT. CL. 5. REG. 12-6-1994.
 1,866,191. JUMP START. INT. CL. 5. REG. 12-6-1994.
 1,866,192. TB FLUOROSTAIN. INT. CL. 5. REG. 12-6-1994.
 1,866,193. GADOLITE. INT. CL. 5. REG. 12-6-1994.
 1,866,194. REMEDYSTICK. INT. CL. 5. REG. 12-6-1994.
 1,866,195. HERDGUARD. INT. CL. 5. REG. 12-6-1994.
 1,866,196. LASER TECH. INT. CL. 6. REG. 12-6-1994.
 1,866,197. PNEU-CHOICE. INT. CL. 6. REG. 12-6-1994.
 1,866,199. RAMP SYSTEMS, INC. AND DESIGN. INT. CL. 6. REG. 12-6-1994.
 1,866,200. RAIMONDI VALVOLE S.P.A. R AND DESIGN. INT. CL. 6. REG. 12-6-1994.
 1,866,202. TELESKO ARM. INT. CL. 7. REG. 12-6-1994.
 1,866,204. RANGE RUSTLER. INT. CL. 7. REG. 12-6-1994.
 1,866,205. GLASS EATER. INT. CL. 7. REG. 12-6-1994.
 1,866,209. GEOTRACER. INT. CL. 9. REG. 12-6-1994.
 1,866,210. GRAFRAME. INT. CL. 9. REG. 12-6-1994.
 1,866,211. MEISLAB. INT. CL. 9. REG. 12-6-1994.
 1,866,214. EXCEEDING CUSTOMER EXPECTATIONS. INT. CL. 9. REG. 12-6-1994.
 1,866,218. PRIVAFAX. INT. CL. 9. REG. 12-6-1994.
 1,866,219. LPS 2000. INT. CL. 9. REG. 12-6-1994.
 1,866,220. USERLAND FRONTIER. INT. CL. 9. REG. 12-6-1994.
 1,866,221. TABLEAU. INT. CL. 9. REG. 12-6-1994.
 1,866,223. SAFE SMOKE HOOD EXIT AND DESIGN. INT. CL. 9. REG. 12-6-1994.
 1,866,224. SAFE TOUCH. INT. CL. 9. REG. 12-6-1994.
 1,866,230. BARCODE BATTLER. INT. CL. 9. REG. 12-6-1994.
 1,866,231. PENERGY. INT. CL. 9. REG. 12-6-1994.
 1,866,232. PAGES BY PAGES. INT. CL. 9. REG. 12-6-1994.
 1,866,233. ZONED ALPHANUMERIC PAGING. INT. CL. 9. REG. 12-6-1994.
 1,866,234. TEAMHUB. INT. CL. 9. REG. 12-6-1994.
 1,866,237. SONY S2 SOHO SQUARE AND DESIGN. INT. CL. 9. REG. 12-6-1994.
 1,866,238. GUARDIAQ. INT. CL. 9. REG. 12-6-1994.
 1,866,239. SCANMASTER. INT. CL. 9. REG. 12-6-1994.
 1,866,240. PHOTOSTACKER (STYLIZED). INT. CL. 9. REG. 12-6-1994.
 1,866,243. SHELL + +. INT. CL. 9. REG. 12-6-1994.
 1,866,244. MICRODOWSER. INT. CL. 9. REG. 12-6-1994.
 1,866,245. PROSENTRY. INT. CL. 9. REG. 12-6-1994.
 1,866,246. COMMSENSE. INT. CL. 9. REG. 12-6-1994.
 1,866,249. SCREENPOWER. INT. CL. 9. REG. 12-6-1994.
 1,866,250. FULL-DIMENSIONAL SOUND. INT. CL. 9. REG. 12-6-1994.
 1,866,251. OMNIBOOK. INT. CL. 9. REG. 12-6-1994.
 1,866,258. TIME ACTIVATOR AND DESIGN. INT. CL. 9. REG. 12-6-1994.
 1,866,259. BODY INSIGHT. INT. CL. 9. REG. 12-6-1994.
 1,866,261. WIDE ONE. INT. CL. 9. REG. 12-6-1994.
 1,866,263. WRAP TO FIT. INT. CL. 9. REG. 12-6-1994.
 1,866,265. DISTRICT MATCH. INT. CL. 9. REG. 12-6-1994.
 1,866,266. PHOTOGRAPHIC MEMORY. INT. CL. 9. REG. 12-6-1994.
 1,866,267. STARTOPAZ. INT. CL. 9. REG. 12-6-1994.
 1,866,270. R-FDMS. INT. CL. 9. REG. 12-6-1994.
 1,866,271. ULTRA TRAK. INT. CL. 9. REG. 12-6-1994.
 1,866,272. TRIAD. INT. CL. 9. REG. 12-6-1994.
 1,866,273. FEDTRAX. INT. CL. 9. REG. 12-6-1994.
 1,866,275. AMBASSADOR OF LIFE. INT. CL. 9. REG. 12-6-1994.
 1,866,276. 33HT. INT. CL. 9. REG. 12-6-1994.
 1,866,277. 31HT. INT. CL. 9. REG. 12-6-1994.
 1,866,278. 37HT. INT. CL. 9. REG. 12-6-1994.
 1,866,279. 30HT. INT. CL. 9. REG. 12-6-1994.
 1,866,280. 35HT. INT. CL. 9. REG. 12-6-1994.
 1,866,281. 29HT. INT. CL. 9. REG. 12-6-1994.
 1,866,284. PHOTO MESSAGE. INT. CL. 9. REG. 12-6-1994.
 1,866,285. REMEMORY. INT. CL. 9. REG. 12-6-1994.
 1,866,286. HANDIFAX. INT. CL. 9. REG. 12-6-1994.
 1,866,287. NOVEMBER RECORDS. INT. CL. 9. REG. 12-6-1994.
 1,866,288. PRO THRASH. INT. CL. 9. REG. 12-6-1994.
 1,866,289. ECHO GOLF REPORTER AND DESIGN. INT. CL. 9. REG. 12-6-1994.
 1,866,290. ACCUTAB. INT. CL. 9. REG. 12-6-1994.
 1,866,293. THE ADVENTURE DISC. INT. CL. 9. REG. 12-6-1994.
 1,866,294. FIREARM. INT. CL. 9. REG. 12-6-1994.
 1,866,295. VOICESELECT. INT. CL. 9. REG. 12-6-1994.
 1,866,296. TLINK. INT. CL. 9. REG. 12-6-1994.
 1,866,297. DOSE-MAP. INT. CL. 9. REG. 12-6-1994.
 1,866,299. EO AND DESIGN. INT. CL. 9. REG. 12-6-1994.
 1,866,300. LOGIC CONCEPTS. INT. CL. 9. REG. 12-6-1994.

- 1,866,304. MAGLIFE. INT. CL. 10. REG. 12-6-1994.
1,866,305. TENSOSHARP. INT. CL. 10. REG. 12-6-1994.
1,866,307. TWISTER. INT. CL. 10. REG. 12-6-1994.
1,866,308. QUICKCURE. INT. CL. 10. REG. 12-6-1994.
1,866,309. DANESCOPE. INT. CL. 10. REG. 12-6-1994.
1,866,312. V-MAX. INT. CL. 10. REG. 12-6-1994.
1,866,313. NOISE-BUSTERS. INT. CL. 10. REG. 12-6-1994.
1,866,316. HATCHBACK. INT. CL. 11. REG. 12-6-1994.
1,866,318. METASYS. INT. CL. 11. REG. 12-6-1994.
1,866,319. SCAN AND DESIGN. INT. CL. 11. REG. 12-6-1994.
1,866,322. RELAGS. INT. CL. 11. REG. 12-6-1994.
1,866,325. MULTI VIEW AND DESIGN. INT. CL. 12. REG. 12-6-1994.
1,866,327. NORDIC. INT. CL. 12. REG. 12-6-1994.
1,866,335. DIET. INT. CL. 14. REG. 12-6-1994.
1,866,336. YIKES!. INT. CL. 14. REG. 12-6-1994.
1,866,337. UPTOWN. INT. CL. 14. REG. 12-6-1994.
1,866,339. NETWORK TIMES. INT. CL. 16. REG. 12-6-1994.
1,866,341. FLORAL GARDENS. INT. CL. 16. REG. 12-6-1994.
1,866,342. VAL-U-VUE. INT. CL. 16. REG. 12-6-1994.
1,866,343. WISSH. INT. CL. 16. REG. 12-6-1994.
1,866,345. CLONE CARD. INT. CL. 16. REG. 12-6-1994.
1,866,347. SOAKERS. INT. CL. 16. REG. 12-6-1994.
1,866,348. IDENTITY. INT. CL. 16. REG. 12-6-1994.
1,866,349. LAVA. INT. CL. 16. REG. 12-6-1994.
1,866,354. THE ORIGINAL STATE OVALS. INT. CL. 16. REG. 12-6-1994.
1,866,355. YIKES!. INT. CL. 16. REG. 12-6-1994.
1,866,357. GEORGETTE. INT. CL. 16. REG. 12-6-1994.
1,866,359. FAST TRACK. INT. CL. 16. REG. 12-6-1994.
1,866,360. HARPER SPOTLIGHT. INT. CL. 16. REG. 12-6-1994.
1,866,362. THE HOME DECORATING INSTITUTE COUNTRY CRAFTS COLLECTION. INT. CL. 16. REG. 12-6-1994.
1,866,363. LOUIS L'AMOUR WESTERN MAGAZINE AND DESIGN. INT. CL. 16. REG. 12-6-1994.
1,866,364. THE GENTLEMAN'S CLUB. INT. CL. 16. REG. 12-6-1994.
1,866,365. KINDRED. INT. CL. 16. REG. 12-6-1994.
1,866,367. FABSTRIP. INT. CL. 17. REG. 12-6-1994.
1,866,373. BRAVO. INT. CL. 18. REG. 12-6-1994.
1,866,375. LIZ CLAIBORNE AND DESIGN. INT. CL. 18. REG. 12-6-1994.
1,866,376. SKYFLITE. INT. CL. 18. REG. 12-6-1994.
1,866,377. ECLAIR SPORTIF (STYLIZED). INT. CL. 18. REG. 12-6-1994.
1,866,378. WESTERN COLLECTION. INT. CL. 18. REG. 12-6-1994.
1,866,380. MERIDIAN. INT. CL. 19. REG. 12-6-1994.
1,866,381. WEEKEND RETREAT. INT. CL. 20. REG. 12-6-1994.
1,866,382. CATDOMINIUM. INT. CL. 20. REG. 12-6-1994.
1,866,383. SWIGSTER. INT. CL. 20. REG. 12-6-1994.
1,866,385. WRENCH BENCH. INT. CL. 20. REG. 12-6-1994.
1,866,390. RESINWEAVE. INT. CL. 20. REG. 12-6-1994.
1,866,391. HANG-EZ AND DESIGN. INT. CL. 20. REG. 12-6-1994.
1,866,392. HANDS OFF. INT. CL. 21. REG. 12-6-1994.
1,866,393. SCRUB-EEZE "NOT JUST ANOTHER RUBBER GLOVE" AND DESIGN. INT. CL. 21. REG. 12-6-1994.
1,866,394. SQUIRREL FOILER (STYLIZED). INT. CL. 21. REG. 12-6-1994.
1,866,395. BRUSH TONES. INT. CL. 21. REG. 12-6-1994.
1,866,396. RR ROYALE REGO (STYLIZED). INT. CL. 21. REG. 12-6-1994.
1,866,397. ELIZABETH. INT. CL. 21. REG. 12-6-1994.
1,866,398. PERMA-GLIDE. INT. CL. 21. REG. 12-6-1994.
1,866,403. SIESTA. INT. CL. 22. REG. 12-6-1994.
1,866,405. STORM SHIELD. INT. CL. 24. REG. 12-6-1994.
1,866,406. BARRISTAT. INT. CL. 24. REG. 12-6-1994.
1,866,407. IT'S A WRAP! REUSABLE EARTH-FRIENDLY GIFT WRAP (STYLIZED). INT. CL. 24. REG. 12-6-1994.
1,866,408. SEAVISTA. INT. CL. 24. REG. 12-6-1994.
1,866,412. PAR PRONE. INT. CL. 25. REG. 12-6-1994.
1,866,413. MISCELLANEOUS DESIGN. INT. CL. 25. REG. 12-6-1994.
1,866,414. MISCELLANEOUS DESIGN. INT. CL. 25. REG. 12-6-1994.
1,866,415. LACOSTE. INT. CL. 25. REG. 12-6-1994.
1,866,416. LACOSTE. INT. CL. 25. REG. 12-6-1994.
1,866,418. HEAVYWEAR. INT. CL. 25. REG. 12-6-1994.
1,866,419. DANBURY APPAREL. INT. CL. 25. REG. 12-6-1994.
1,866,421. DESIGNASAURUS. INT. CL. 25. REG. 12-6-1994.
1,866,422. DE VECCHI AND DESIGN. INT. CL. 25. REG. 12-6-1994.
1,866,423. STRIKE A POSE. INT. CL. 25. REG. 12-6-1994.
1,866,424. TOMORROW'S THUNDER. INT. CL. 25. REG. 12-6-1994.
1,866,425. DANIEL DRESCOTT. INT. CL. 25. REG. 12-6-1994.
1,866,426. MIXED PIECES. INT. CL. 25. REG. 12-6-1994.
1,866,427. B AND DESIGN. INT. CL. 25. REG. 12-6-1994.
1,866,428. CADDY GOLFWEAR AND DESIGN. INT. CL. 25. REG. 12-6-1994.
1,866,431. RUNBALL. INT. CL. 25. REG. 12-6-1994.
1,866,432. VENT-TECH. INT. CL. 25. REG. 12-6-1994.
1,866,436. MUSICWEAR. INT. CL. 25. REG. 12-6-1994.
1,866,438. PEBBLE BEACH FOREST COURSE. INT. CL. 25. REG. 12-6-1994.
1,866,439. RECYCOOL. INT. CL. 25. REG. 12-6-1994.
1,866,440. JV'S. INT. CL. 25. REG. 12-6-1994.
1,866,441. M.A.L. INT. CL. 25. REG. 12-6-1994.
1,866,444. BYOB. INT. CL. 25. REG. 12-6-1994.
1,866,447. FULL F/X EXPOSURE (STYLIZED). INT. CL. 25. REG. 12-6-1994.
1,866,448. SKIN F/X. INT. CL. 25. REG. 12-6-1994.
1,866,449. S AND DESIGN. INT. CL. 25. REG. 12-6-1994.
1,866,452. 4 REEL AND DESIGN. INT. CL. 25. REG. 12-6-1994.
1,866,453. MISCELLANEOUS DESIGN. INT. CL. 25. REG. 12-6-1994.
1,866,456. BLUE CACTUS. INT. CL. 25. REG. 12-6-1994.
1,866,459. NTE DIRECTION AND DESIGN. INT. CL. 25. REG. 12-6-1994.
1,866,462. STREET L-E-V-E-L. INT. CL. 25. REG. 12-6-1994.
1,866,463. X-OUT "THE HACKER'S CHOICE". INT. CL. 25. REG. 12-6-1994.
1,866,464. AMBASSADOR OF LIFE. INT. CL. 25. REG. 12-6-1994.
1,866,465. H.Q. STUDIO. INT. CL. 25. REG. 12-6-1994.
1,866,468. MAXIMUM PLEASURE GUARANTEED. INT. CL. 25. REG. 12-6-1994.
1,866,470. STACY LYNN. INT. CL. 25. REG. 12-6-1994.
1,866,473. EAGLE ROCK. INT. CL. 25. REG. 12-6-1994.
1,866,474. ISABELLA AND GIOVANNI. INT. CL. 25. REG. 12-6-1994.
1,866,475. BEVERLY HILLS 90210 AND DESIGN. INT. CL. 25. REG. 12-6-1994.
1,866,476. WHO'S GOT YOUR BACK?. INT. CL. 25. REG. 12-6-1994.
1,866,478. TREND SETTERS. INT. CL. 26. REG. 12-6-1994.
1,866,479. FAMILY LIVING. INT. CL. 27. REG. 12-6-1994.
1,866,480. LOUNGE. INT. CL. 27. REG. 12-6-1994.
1,866,481. ABDOMEX. INT. CL. 28. REG. 12-6-1994.
1,866,482. CHALLENGE MASTER AND DESIGN. INT. CL. 28. REG. 12-6-1994.
1,866,484. BIO POWER. INT. CL. 28. REG. 12-6-1994.
1,866,485. CREATIVE IMPRESSIONS. INT. CL. 28. REG. 12-6-1994.
1,866,488. STICK IT. INT. CL. 28. REG. 12-6-1994.
1,866,489. LORDS OF THUNDER. INT. CL. 28. REG. 12-6-1994.
1,866,490. ATIM. INT. CL. 28. REG. 12-6-1994.
1,866,492. THE MCCORD AND DESIGN. INT. CL. 28. REG. 12-6-1994.
1,866,493. FLAT BLASTARD. INT. CL. 28. REG. 12-6-1994.
1,866,494. BOOTBOX AND DESIGN. INT. CL. 28. REG. 12-6-1994.
1,866,495. UNIVERSAL WARRIOR. INT. CL. 28. REG. 12-6-1994.
1,866,496. EXTRA. INT. CL. 28. REG. 12-6-1994.

- 1,866,497. ENDRE'S WALKAMALS. INT. CL. 28. REG. 12-6-1994.
- 1,866,498. RUFF-RIDER. INT. CL. 28. REG. 12-6-1994.
- 1,866,502. COURT SERVE. INT. CL. 28. REG. 12-6-1994.
- 1,866,504. CHILLED OR GRILLED. INT. CL. 29. REG. 12-6-1994.
- 1,866,505. ROYAL OMAN. INT. CL. 29. REG. 12-6-1994.
- 1,866,509. NATIONS PRIDE DEDICATED TO IMPROVING FRESHNESS & QUALITY AND DESIGN. INT. CL. 29. REG. 12-6-1994.
- 1,866,510. PIERCE TREASURES. INT. CL. 29. REG. 12-6-1994.
- 1,866,511. HOMEBOY. INT. CL. 29. REG. 12-6-1994.
- 1,866,512. GRAND PRIX PIZZA (STYLIZED). INT. CL. 30. REG. 12-6-1994.
- 1,866,513. PERFECT CHOICE. INT. CL. 30. REG. 12-6-1994.
- 1,866,515. VITAMAX AND DESIGN. INT. CL. 30. REG. 12-6-1994.
- 1,866,516. EQUAL MEASURE. INT. CL. 30. REG. 12-6-1994.
- 1,866,518. THE POCKET WAD. INT. CL. 30. REG. 12-6-1994.
- 1,866,519. WEST PALM PEACH. INT. CL. 30. REG. 12-6-1994.
- 1,866,520. CINNAMON, MON. INT. CL. 30. REG. 12-6-1994.
- 1,866,522. TWILIGHT. INT. CL. 30. REG. 12-6-1994.
- 1,866,523. NOTHING HANDLES YOUR HUNGER LIKE A TRISCUIT. INT. CL. 30. REG. 12-6-1994.
- 1,866,527. GOLDTRENDS. INT. CL. 31. REG. 12-6-1994.
- 1,866,528. NATURE'S CAFE. INT. CL. 31. REG. 12-6-1994.
- 1,866,529. EUKANUBA NATURAL. INT. CL. 31. REG. 12-6-1994.
- 1,866,531. CLASSIC GARDEN. INT. CL. 31. REG. 12-6-1994.
- 1,866,533. LEMONHEAD (STYLIZED). INT. CL. 32. REG. 12-6-1994.
- 1,866,534. BONDI. INT. CL. 32. REG. 12-6-1994.
- 1,866,536. SAY NO MORE. INT. CL. 32. REG. 12-6-1994.
- 1,866,537. GRACELAND AND DESIGN. INT. CL. 32. REG. 12-6-1994.
- 1,866,538. GRAND CLASSICS. INT. CL. 32. REG. 12-6-1994.
- 1,866,539. FINLANDIA. VODKA FROM THE TOP OF THE WORLD. INT. CL. 33. REG. 12-6-1994.
- 1,866,541. THE NOVUS GROUP. INT. CL. 35. REG. 12-6-1994.
- 1,866,543. POSITIVE PERSONNEL. INT. CL. 35. REG. 12-6-1994.
- 1,866,547. WORKING HARDER WORKING SMARTER. INT. CL. 35. REG. 12-6-1994.
- 1,866,550. THE BRADFORD EXCHANGE ADVANTAGE. INT. CL. 36. REG. 12-6-1994.
- 1,866,551. BASICARE. INT. CL. 36. REG. 12-6-1994.
- 1,866,552. THE COLLECTIBLE SOURCE. INT. CL. 36. REG. 12-6-1994.
- 1,866,553. ADOPT-A-SIGN (STYLIZED). INT. CL. 36. REG. 12-6-1994.
- 1,866,554. APROBACIONPRIMERO (STYLIZED). INT. CL. 36. REG. 12-6-1994.
- 1,866,556. VDBS VANGUARD DISCOUNT BROKERAGE SERVICES A DIVISION OF VANGUARD MARKETING CORPORATION AND DESIGN. INT. CL. 36. REG. 12-6-1994.
- 1,866,560. UNIVERSAL CITYWALK (STYLIZED). INT. CL. 36. REG. 12-6-1994.
- 1,866,562. EBP HEALTHPLANS AND DESIGN. INT. CL. 36. REG. 12-6-1994.
- 1,866,563. NORVAC AND DESIGN. INT. CL. 37. REG. 12-6-1994.
- 1,866,564. CLS AND DESIGN. INT. CL. 37. REG. 12-6-1994.
- 1,866,565. VOICENOW. INT. CL. 38. REG. 12-6-1994.
- 1,866,567. FITNESS PLUS. INT. CL. 38. REG. 12-6-1994.
- 1,866,568. LEOPALACE. INT. CL. 39. REG. 12-6-1994.
- 1,866,569. METRO ACCESS. INT. CL. 39. REG. 12-6-1994.
- 1,866,571. BEST FRIENDS COMMISSION GUARANTEE. INT. CL. 39. REG. 12-6-1994.
- 1,866,573. DDA. INT. CL. 39. REG. 12-6-1994.
- 1,866,574. ULTIMATE GOLF. INT. CL. 41. REG. 12-6-1994.
- 1,866,577. FINANCIAL WELLNESS. INT. CL. 41. REG. 12-6-1994.
- 1,866,578. ITC HOME VIDEO AND DESIGN. INT. CL. 41. REG. 12-6-1994.
- 1,866,579. MED-AWARE AND DESIGN. INT. CL. 41. REG. 12-6-1994.
- 1,866,580. SOULS AT ZERO. INT. CL. 41. REG. 12-6-1994.
- 1,866,583. GRAND PRIX PIZZA (STYLIZED). INT. CL. 42. REG. 12-6-1994.
- 1,866,584. DERMAVIEW. INT. CL. 42. REG. 12-6-1994.
- 1,866,587. THE NATIONAL CONFERENCE NCCJ. INT. CL. 42. REG. 12-6-1994.
- 1,866,589. THE BEST GUYS. INT. CL. 42. REG. 12-6-1994.
- 1,866,592. HEALTHY EXPRESS. INT. CL. 42. REG. 12-6-1994.
- 1,866,597. SENTINEL. INT. CL. 42. REG. 12-6-1994.
- 1,866,599. MONTARE. INT. CL. 42. REG. 12-6-1994.
- 1,866,600. A STUDIO ART AND DESIGN. INT. CL. 42. REG. 12-6-1994.
- 1,866,602. KIDSOURCE. INT. CL. 42. REG. 12-6-1994.
- 1,866,603. MOVENPICK AND DESIGN. INT. CL. 42. REG. 12-6-1994.
- 1,866,604. GRAND MANSION. INT. CL. 42. REG. 12-6-1994.
- 1,866,605. THE CHILE GUY. INT. CL. 42. REG. 12-6-1994.
- 1,866,606. PET METRO. INT. CL. 42. REG. 12-6-1994.
- 1,866,607. SOFT SERVE STOP. INT. CL. 42. REG. 12-6-1994.
- 1,866,608. ARDEN COURTS. INT. CL. 42. REG. 12-6-1994.
- 1,866,609. CYBERIA. INT. CL. 42. REG. 12-6-1994.
- 1,866,611. ATCHAFALAYA CAJUN CAFE. INT. CL. 42. REG. 12-6-1994.
- 1,866,614. ACTIVATED BAKING SODA. INT. CL. 3. REG. 12-6-1994.
- 1,866,615. HERBAL CALCIUM RICH. INT. CL. 5. REG. 12-6-1994.
- 1,866,616. THE PERFECT. INT. CL. 6. REG. 12-6-1994.
- 1,866,617. COOPERATIVE SERVER TECHNOLOGY. INT. CL. 9. REG. 12-6-1994.
- 1,866,618. VIRTUAL SYSTEM ENVIRONMENT (STYLIZED). INT. CL. 9. REG. 12-6-1994.
- 1,866,619. UNIVERSAL REMOTE AND DESIGN. INT. CL. 9. REG. 12-6-1994.
- 1,866,620. MULTIVUE. INT. CL. 9. REG. 12-6-1994.
- 1,866,622. THE MODEL EMPLOYER. INT. CL. 16. REG. 12-6-1994.
- 1,866,623. THE WORLD'S MOST POWERFUL EXECUTIVE JOB-FINDING SYSTEM. INT. CL. 16. REG. 12-6-1994.
- 1,866,624. HEURISTICS THE JOURNAL OF KNOWLEDGE ENGINEERING (STYLIZED). INT. CL. 16. REG. 12-6-1994.
- 1,866,625. LAW & POLITICS (STYLIZED). INT. CL. 16. REG. 12-6-1994.
- 1,866,626. THE SANDWICH GENERATION. INT. CL. 16. REG. 12-6-1994.
- 1,866,628. INDOOR ENVIRONMENTAL NEWS. INT. CL. 16. REG. 12-6-1994.
- 1,866,629. ARMSTRONG. INT. CL. 16. REG. 12-6-1994.
- 1,866,630. GAY & LESBIAN YELLOW PAGES. INT. CL. 16. REG. 12-6-1994.
- 1,866,631. PET FOOD CLIP. INT. CL. 20. REG. 12-6-1994.
- 1,866,633. NATIONAL MALL MARKETING NETWORK. INT. CL. 35. REG. 12-6-1994.
- 1,866,635. TOUCHTONE TRANSPORTATION. INT. CL. 36. REG. 12-6-1994.
- 1,866,639. TITLETRAC. INT. CL. 42. REG. 12-6-1994.
- 1,866,641. FLUID POWER WEST. INT. CL. 42. REG. 12-6-1994.
- 1,871,812. ULTRABRASS. INT. CL. 6. REG. 1-3-1995.
- 1,874,688. ULTRABRASS. INT. CL. 20. REG. 1-17-1995.
- 1,876,682. FOREVER GREEN. INT. CL. 21. REG. 1-31-1995.
- 1,877,512. MEDIVISIONS. INT. CL. 10. REG. 2-7-1995.
- 1,895,837. RESPLEX. INT. CL. 5. REG. 5-30-1995.
- 1,930,762. SPEAKERS CORNER. INT. CL. 25 ONLY. REG. 10-31-1995.
- 1,947,956. FISH MATE. INT. CL. 11 ONLY. REG. 1-16-1996.

1,950,385. GARDUNO'S CHILE PACKING COMPANY AND
DESIGN. INT. CL. 33 ONLY. REG. 1-23-1996.



SECTION 18

756,782. PREMIER (STYLIZED). U.S. CL. 22. REG. 9-17-
1963.

1,273,061. NTRUST. INT. CL. 36. REG. 4-3-1984.
1,284,567. FINANCIALINE. INT. CL. 36. REG. 7-3-1984.
1,946,754. HAND-IN-HAND. INT. CL. 36. REG. 1-9-1996.
1,992,571. DETONATOR. INT. CL. 28. REG. 8-13-1996.
2,046,265. FLAP LOCK. INT. CL. 6. REG. 3-18-1997.
2,062,167. KLIMAX. INT. CL. 28. REG. 5-13-1997.
2,094,853. POLAR POWDER. INT. CL. 10. REG. 9-9-1997.
2,182,613. GO UGLY EARLY. INT. CL. 25. REG. 8-18-1998.
2,357,751. EXTREME. INT. CL. 21. REG. 6-13-2000.

* * * * *

TRADEMARK REGISTRATIONS AMENDED, CORRECTED, ETC.

The designation "U.S. Cl." appearing in this section refers to the U.S. class in effect prior to Sep. 1, 1973 rather than the international class which applies to applications filed on or after that date. For adoption of international classification see notice in the OFFICIAL GAZETTE of Jun. 26, 1973 (911 O.G. TM 210).

Any change to the registration will be indicated at the bottom of each entry under ELEMENTS AMENDED, CORRECTED OR RESTRICTED. With the exception of changes to the goods and services, additions to the registration will appear in asterisks and deletions of the registration will appear in brackets. Elements which are only changed will be listed with no punctuation. As to the goods/services statement, amendments to the goods/services will appear in asterisks and deletions will appear in brackets. In addition if any change to the goods/services occurs, the element "Goods/Services" will be listed under ELEMENTS AMENDED, CORRECTED OR RESTRICTED.

1,094,923. REG. 7-4-1978. RECKITT & COLMAN (OVERSEAS) LIMITED (GREAT BRITAIN LIMITED LIABILITY COMPANY) DANSOM LANE, HULL HU8 7DS, ENGLAND., SN 73-123,195. FILED 4-18-1977. PRINCIPAL REGISTER.

FOR SAUSAGE.
FIRST USE 0-0-1950; IN COMMERCE 0-0-1974.

ELEMENTS AMENDED
MARK



1,175,223. REG. 10-27-1981. JORH FRAME AND MOULDING COMPANY LTD (ILLINOIS CORPORATION), 21750 MAIN ST., MATTESON, IL, 60443, SN 73-285,643. FILED 11-24-1980. PRINCIPAL REGISTER.

OWNER OF GREAT BRITAIN REG. NO. 1013232, DATED 6-26-1973.

OWNER OF U.S. REG. NOS. 968,985 AND 972,682.

INT. CL. 5/U.S. CLS. 6, 18, 44, 46, 51 AND 52

FOR PHARMACEUTICAL, VETERINARY AND SANITARY PREPARATIONS—NAMELY, ANALGESICS, ANTI-INFLAMMATORY, ANTI-PYRETIC AND ANTI-RHEUMATIC PREPARATIONS; [LAXATIVES;] GASTRIC REFLUX SUPPRESSANTS; NATURAL FIBRE REGIMEN; ANTISEPTIC CREAMS AND GELS; [DRUGS FOR IMMOBILIZING ANIMALS AND DRUGS FOR USE IN THE REVIVING OF IMMOBILIZED ANIMALS;] MEDICATED PREPARATIONS FOR THE TREATMENTS OF THE SCALP AND SKIN; DISINFECTANTS; GERMICIDES AND ANTISEPTICS; MEDICATED BEVERAGES AND PREPARATIONS FOR MAKING MEDICATED BEVERAGES FOR THE RELIEF OF COUGH AND COLD SYMPTOMS.

FIRST USE ; IN COMMERCE .

ELEMENTS CORRECTED
GOODS/SERVICES

PLASTICPAC

INT. CL. 20/U.S. CL. 32
FOR PICTURE FRAMES.
FIRST USE 9-0-1972; IN COMMERCE 0-0-1978.

ELEMENTS CORRECTED
OWNER NAME

1,479,301. REG. 3-8-1988. GRAND LABORATORIES, INC. (SOUTH DAKOTA CORPORATION), 1447 140TH STREET, LARCHWOOD, IA, 512419778, SN 73-674,516. FILED 7-27-1987. PRINCIPAL REGISTER.

CLOSTRATOX

1,148,466. REG. 3-17-1981. S.W. (RED) SMITH, INC. (FLORIDA CORPORATION), 4145 S.W. 47TH AVENUE, DAVIE, FL, 33314, SN 73-225,475. FILED 7-30-1979. PRINCIPAL REGISTER.

RED SMITH

INT. CL. 5/U.S. CL. 18
FOR PREPARATION FOR VETERINARY USE, NAMELY FOR THE PREVENTION OF ENTEROTOXEMIA IN SWINE.
FIRST USE 3-5-1987; IN COMMERCE 3-5-1987.

ELEMENTS AMENDED
MARK

"S.W. (RED) SMITH" IS THE NAME OF A PERSON, INCLUDING NICKNAME. MR. SMITH IS NOW DECEASED.
INT. CL. 29/U.S. CL. 46

1,514,110. REG. 11-22-1988. SOFA EXPRESS, INC. (OHIO CORPORATION), 4600 SOUTH HAMILTON ROAD, GROVEPORT, OH, 43125, BY ASSIGNMENT, BY CHANGE OF NAME WESTGATE FURNITURE, INC. (OHIO CORPORATION), COLUMBUS, OH, SN 73-711,965. FILED 2-18-1988. PRINCIPAL REGISTER.

SOFA EXPRESS

NO CLAIM IS MADE TO THE EXCLUSIVE RIGHT TO USE "SOFA", APART FROM THE MARK AS SHOWN.
INT. CL. 42/U.S. CL. 101
FOR RETAIL FURNITURE STORE SERVICES.
FIRST USE 11-6-1987; IN COMMERCE 11-6-1987.

ELEMENTS AMENDED
MARK
DISCLAIMER



1,676,933. REG. 2-25-1992. GENERAL MILLS, INC. (DELAWARE CORPORATION), NUMBER ONE GENERAL MILLS BOULEVARD, MINNEAPOLIS, MN, 55426, SN 74-126,004. FILED 12-24-1990. PRINCIPAL REGISTER.



OWNER OF U.S. REG. NO. 1,449,955.
INT. CL. 30/U.S. CL. 46
FOR BREAKFAST CEREAL.
FIRST USE 11-12-1990; IN COMMERCE 11-12-1990.

ELEMENTS AMENDED
MARK



1,704,198. REG. 7-28-1992. ENVIRONMENTAL LIGHTING CONCEPTS, INC. (MARYLAND CORPORATION), 1214 WEST CASS STREET, TAMPA, FL, 33606, SN 74-081,414. FILED 7-19-1990. PRINCIPAL REGISTER.

OTT-LITE

INT. CL. 11/U.S. CLS. 13, 21, 23, 31 AND 34
FOR FLUORESCENT LIGHT FIXTURES.
FIRST USE 1-16-1990; IN COMMERCE 2-13-1990.

ELEMENTS AMENDED
MARK

1,760,689. REG. 3-23-1993. TRENWYTH INDUSTRIES, INC. (PENNSYLVANIA CORPORATION), ONE CONNELLY ROAD, EMIGSVILLE, PA, 17318, BY MERGER WITH TRENWYTH INDUSTRIES, INC. (D.C. CORPORATION), EMIGSVILLE (YORK), PA, SN 74-191,937. FILED 8-6-1991. PRINCIPAL REGISTER.

TRENDSTONE PLUS

OWNER OF U.S. REG. NO. 1,134,139.
INT. CL. 19/U.S. CL. 12
FOR GROUND FACE MASONRY BLOCKS.
FIRST USE 9-0-1991; IN COMMERCE 9-0-1991.

ELEMENTS CORRECTED
OWNER NAME



1,807,538. REG. 11-30-1993. FOX POOL CORPORATION (PENNSYLVANIA CORPORATION), P.O. BOX 549, YORK, PA, 17405, SN 74-305,139. FILED 8-17-1992. PRINCIPAL REGISTER.



OWNER OF U.S. REG. NO. 1,224,266.
INT. CL. 19/U.S. CL. 50
FOR FITTED SWIMMING POOL COVERS AND SWIMMING POOL ENCLOSURES; NAMELY, DOMES.
FIRST USE 2-0-1981; IN COMMERCE 9-4-1981.

ELEMENTS CORRECTED
OWNER NAME
OWNER ADDRESS
[ASSIGNMENT/NAME CHANGE]



1,920,535. REG. 9-19-1995. NATIONAL SOCIETY OF PROFESSIONAL ENGINEERS (SOUTH CAROLINA CORPORATION), DBA NATIONAL INSTITUTE FOR CERTIFICATION IN ENGINEERING TECHNOLOGIES, 1420 KING STREET, ALEXANDRIA, VA, 223142794, SN 74-501,566. FILED 3-18-1994. PRINCIPAL REGISTER.



CERTIFIES TESTED COMPETENCY OF TECHNICAL KNOWLEDGE IN AT LEAST ONE SPECIALTY IN THE FIELD OF ENGINEERING (E.G., HIGHWAY DESIGN, BRIDGE SAFETY INSPECTION, WATER/WASTEWATER PLANTS, ETC.).
INT. CL. B /U.S. CL. B

FOR CERTIFICATION SERVICES; NAMELY, CERTIFYING COMPETENCY IN A FIELD OF ENGINEERING. FIRST USE 4-15-1982; IN COMMERCE 4-15-1982.

ELEMENTS CORRECTED
OWNER NAME

1,926,040. REG. 10-10-1995. NATIONAL INSTITUTE FOR CERTIFICATION IN ENGINEERING TECHNOLOGIES (SOUTH CAROLINA CORPORATION), 1420 KING STREET, ALEXANDRIA, VA, 223142794, SN 74-501,567. FILED 3-18-1994. PRINCIPAL REGISTER.

NATIONAL INSTITUTE FOR CERTIFICATION IN ENGINEERING TECHNOLOGIES

NO CLAIM IS MADE TO THE EXCLUSIVE RIGHT TO USE "INSTITUTE FOR CERTIFICATION IN ENGINEERING TECHNOLOGIES", APART FROM THE MARK AS SHOWN.

SEC. 2(F).
INT. CL. 42/U.S. CLS. 100 AND 101
FOR ASSOCIATION SERVICES, NAMELY PROMOTING THE INTERESTS OF A SUB-ENGINEERING FIELD THROUGH THE AWARD OF EXAMINATION-BASED COMPETENCY CERTIFICATES; EVALUATION AND TESTING OF A PARTICULAR SUB-ENGINEERING FIELD AND AWARDED PROFICIENCY-BASED CERTIFICATES RELATED THERETO.
FIRST USE 7-17-1981; IN COMMERCE 7-17-1981.

ELEMENTS CORRECTED
OWNER NAME

1,928,929. REG. 10-24-1995. TERGRUP, S.L. (SPAIN CORPORATION), AVENIDA RAMON Y CAJAL, S/N, 46870 ONTENIENTE (VALENCIA), SPAIN., SN 74-405,849. FILED 6-21-1993. PRINCIPAL REGISTER.

ATRIVM

OWNER OF SPAIN REG. NO. 1.307.086(X), DATED 5-20-1991.
INT. CL. 24/U.S. CL. 42

FOR BATH LINENS; BED BLANKETS; BED LINEN, BEDSPREADS, COVERS FOR FURNITURE, CURTAINS, EIDERDOWN, HOUSEHOLD LINENS, PILLOW CASES, TABLE CLOTHS, TABLE LINEN AND TOWELS.

ELEMENTS AMENDED
MARK

1,936,999. REG. 11-21-1995. TOMORROW'S TREASURES, INC. (NEW JERSEY CORPORATION), 111 NORTH GLASSBORO ROAD, WOODBURY HEIGHTS, NJ, 08097, SN 74-595,303. FILED 11-4-1994. PRINCIPAL REGISTER.

TOMORROW'S TREASURES

INT. CL. 40/U.S. CLS. 100, 103 AND 106

FOR PHOTOGRAPHIC FILM DEVELOPMENT AND ENLARGEMENT LABORATORY SERVICES. FIRST USE 10-29-1980; IN COMMERCE 10-29-1980.

ELEMENTS CORRECTED
MARK

1,982,066. REG. 6-25-1996. KATTUS, JOHANN (AUSTRIA SOLE PROPRIETORSHIP) AM HOF 8, 1010 VIENNA, AUSTRIA., SN 74-607,094. FILED 12-5-1994. PRINCIPAL REGISTER.

HOCHRIEGL JOHANN KATTUS

OWNER OF U.S. REG. NO. 968,803.
THE NAME JOHANN KATTUS APPEARING IN THE TRADEMARK IS THE NAME OF APPLICANT'S FOUNDING PARTNER AND PREDECESSOR IN BUSINESS, AND IS NOW DECEASED.

INT. CL. 33/U.S. CLS. 47 AND 49
FOR SPARKLING WINES.
FIRST USE 0-0-1993; IN COMMERCE 0-0-1993.

ELEMENTS CORRECTED
ENTITY

2,197,591. REG. 10-20-1998. MARKET FACTS, INC. (DELAWARE CORPORATION), 3040 WEST SALT CREEK LANE, ARLINGTON HEIGHTS, IL, 60005, SN 75-308,929. FILED 6-16-1997. PRINCIPAL REGISTER.

PRODUCTQUEST

NO CLAIM IS MADE TO THE EXCLUSIVE RIGHT TO USE "PRODUCT", APART FROM THE MARK AS SHOWN.
INT. CL. 35/U.S. CLS. 100, 101 AND 102
FOR MARKET RESEARCH SERVICES IN THE FIELD OF PRODUCT TESTING.
FIRST USE 3-0-1997; IN COMMERCE 5-0-1997.

ELEMENTS AMENDED
MARK

2,284,378. REG. 10-12-1999. FRANKLIN RESOURCES, INC. (DELAWARE CORPORATION), 777 MARINERS ISLAND BOULEVARD, SAN MATEO, CA, 944037777, SN 75-237,020. FILED 2-5-1997. PRINCIPAL REGISTER.

MUTUAL SERIES

NO CLAIM IS MADE TO THE EXCLUSIVE RIGHT TO USE "SERIES", APART FROM THE MARK AS SHOWN.
SEC. 2(F).

INT. CL. 36/U.S. CLS. 100, 101 AND 102
FOR INVESTMENT MANAGEMENT SERVICES AND MUTUAL FUND ADVISORY, DISTRIBUTION AND ADMINISTRATION SERVICES.
FIRST USE 2-1-1988; IN COMMERCE 2-1-1988.

ELEMENTS AMENDED
DATE OF FIRST USE IN COMMERCE

2,304,039. REG. 12-28-1999. SCHULTZ, JR., DONALD F. (UNITED STATES CITIZEN), 17602 SAMPSON LANE, HUNTINGTON BEACH, CA, 926476749, BY ASSIGNMENT BEEKS, MARK E. (UNITED STATES CITIZEN), HUNTINGTON BEACH, CA, AND SCHULTZ, DONALD F. JR. (UNITED STATES CITIZEN), DBA WILD 1, HUNTINGTON BEACH, CA, SN 75-572,749. FILED 10-19-1998. PRINCIPAL REGISTER.

SELLERATOR

INT. CL. 20/U.S. CLS. 2, 13, 22, 25, 32 AND 50
 FOR SALES AND MERCHANDISING DISPLAY UNIT CONSISTING OF A TUBULAR METAL FRAME DISPLAY RACK.
 FIRST USE 12-2-1997; IN COMMERCE 7-19-1998.

ELEMENTS AMENDED
 ASSIGNMENT/NAME CHANGE

2,310,753. REG. 1-25-2000. JOHN HEWITT & ASSOCIATES, INC. (MAINE CORPORATION), 100 COMMERCIAL STREET, SUITE 210, PORTLAND, ME, 04101, SN 75-492,867. FILED 5-26-1998. PRINCIPAL REGISTER.



NO CLAIM IS MADE TO THE EXCLUSIVE RIGHT TO USE "FOR THE LONG TERM", APART FROM THE MARK AS SHOWN.

THE MARK IS LINED FOR THE COLORS BLUE AND GRAY

INT. CL. 36/U.S. CLS. 100, 101 AND 102
 FOR CONSULTING IN THE FIELD OF RISK MANAGEMENT AND DISABILITY INSURANCE.
 FIRST USE 6-15-1995; IN COMMERCE 6-15-1995.
 INT. CL. 41/U.S. CLS. 100, 101 AND 107
 FOR SEMINARS IN THE FIELD OF DISABILITY INSURANCE.
 FIRST USE 6-15-1995; IN COMMERCE 6-15-1995.

ELEMENTS CORRECTED
 LINING/STIPPLING STATEMENT

2,316,275. REG. 2-8-2000. P.T.C. BRAND, INC. (DELAWARE CORPORATION), 204 WELDIN BUILDING, 3411 SILVER-SIDE ROAD, WILMINGTON, DE, 19810, SN 75-602,634. FILED 12-10-1998. PRINCIPAL REGISTER.

TIMBER WOLF RACING

OWNER OF U.S. REG. NO. 1,539,498.
 NO CLAIM IS MADE TO THE EXCLUSIVE RIGHT TO USE "RACING", APART FROM THE MARK AS SHOWN.
 INT. CL. 41/U.S. CLS. 100, 101 AND 107
 FOR ENTERTAINMENT SERVICES, NAMELY, AUTO RACING.
 FIRST USE 1-4-1996; IN COMMERCE 1-4-1996.

ELEMENTS CORRECTED
 DISCLAIMER

2,322,498. REG. 2-22-2000. NEED SUPPLY COMPANY, L.L.C. (VIRGINIA LIMITED LIABILITY COMPANY) 3010 WEST CARY STREET, RICHMOND, VA, 23221, BY CHANGE OF NAME BLUES, L.C. (VIRGINIA), RICHMOND, VA, SN 75-567,058. FILED 10-7-1998. PRINCIPAL REGISTER.

NEED SUPPLY COMPANY

NO CLAIM IS MADE TO THE EXCLUSIVE RIGHT TO USE "COMPANY", APART FROM THE MARK AS SHOWN.
 INT. CL. 35/U.S. CLS. 100, 101 AND 102
 FOR RETAIL CLOTHING STORE SERVICES.
 FIRST USE 3-4-1999; IN COMMERCE 3-4-1999.

ELEMENTS CORRECTED
 OWNER NAME

2,339,903. REG. 4-11-2000. TOUCH TONE TECHNOLOGIES, INC. (FLORIDA CORPORATION), 1 LINCOLN PLACE, 1900 GLADES ROAD, SUITE 200, BOCA RATON, FL, 33431, SN 75-498,116. FILED 6-8-1998. PRINCIPAL REGISTER.



NO CLAIM IS MADE TO THE EXCLUSIVE RIGHT TO USE "TECHNOLOGIES, INC.", APART FROM THE MARK AS SHOWN.

INT. CL. 35/U.S. CLS. 100, 101 AND 102
 FOR DATA PROCESSING SERVICES.
 FIRST USE 6-22-1997; IN COMMERCE 6-22-1997.
 INT. CL. 37/U.S. CLS. 100, 103 AND 106
 FOR INSTALLATION OF TELECOMMUNICATIONS HARDWARE, NAMELY, COMPUTERS AND TELEPHONES, AND SOFTWARE THEREFOR.
 FIRST USE 6-22-1997; IN COMMERCE 6-22-1997.
 INT. CL. 38/U.S. CLS. 100, 101 AND 104
 FOR TELECOMMUNICATIONS SERVICES, NAMELY, PROVIDING INTEGRATED PHONE, VOICEMAIL, PAGING SERVICES, ELECTRONIC MAIL SERVICES, FAX SERVICES, AND THE PROVISION OF TELECOMMUNICATIONS CONNECTIONS TO A GLOBAL COMPUTER NETWORK.
 FIRST USE 6-22-1997; IN COMMERCE 6-22-1997.
 INT. CL. 41/U.S. CLS. 100, 101 AND 107
 FOR TRAINING OF OTHERS IN USE OF TELECOMMUNICATIONS EQUIPMENT.
 FIRST USE 6-22-1997; IN COMMERCE 6-22-1997.
 INT. CL. 42/U.S. CLS. 100 AND 101
 FOR CONSULTATION IN THE FIELD OF TELECOMMUNICATIONS; PROGRAMMING OF TELECOMMUNICATIONS EQUIPMENT AND SOFTWARE, NAMELY; UPDATING MIS SYSTEMS * AND REDUNDANT * BACKUP, NAMELY TECHNICAL TROUBLESHOOTING OF COMPUTER HARDWARE AND SOFTWARE PROBLEMS VIA TELEPHONE, E-MAIL, BY PERSON AND POSTINGS ON GLOBAL COMPUTER NETWORKS.
 FIRST USE 6-22-1997; IN COMMERCE 6-22-1997.

ELEMENTS CORRECTED
 GOODS/SERVICES

2,354,485. REG. 6-6-2000. INDUSTRIAS ALIMENTARIAS DE NAVARRA, S.A. (SPAIN CORPORATION), SAN ADRIAN NAVARRA, SPAIN., SN 75-463,587. FILED 4-7-1998. PRINCIPAL REGISTER.

BEBE

OWNER OF SPAIN REG. NO. 1023939, DATED 12-13-1982, RENEWED AS REG. NO. 1023939, DATED 12-13-2002, EXPIRES 12-13-2012.

OWNER OF SPAIN REG. NO. 788167, DATED 3-18-1982, EXPIRES 3-18-2002.

THE ENGLISH TRANSLATION OF "BEBE" IS "BABY" OR "HE/SHE/IT DRINKS".

INT. CL. 29/U.S. CL. 46

FOR PRESERVED, DRIED AND COOKED FRUITS AND VEGETABLES, JELLIES, JAMS AND PICKLES.

INT. CL. 30/U.S. CL. 46

FOR COFFEE; TEA, COCOA, RICE, TAPIOCA, ARTIFICIAL COFFEE; BREAD SPONGECAKE, CAKES, PASTRY; HONEY, TREACLE, YEAST, SALT, MUSTARD; VINEGAR, SAUCES (EXCEPT SALAD DRESSINGS); SPICES; ICE.

ELEMENTS CORRECTED
FOREIGN REG. EXPIRATION DATE
[FOREIGN RENEWAL REG. DATE]

2,373,263. REG. 8-1-2000. ALCANCIA B.V. (NETHERLANDS COMPANY), SLINGERDUIN 5, 1187 JM AMSTELVEEN, NETHERLANDS., SN 75-328,221. FILED 7-21-1997. PRINCIPAL REGISTER.



OWNER OF U.S. REG. NOS. 1,813,400, 1,936,483 AND OTHERS.

INT. CL. 41/U.S. CLS. 100, 101 AND 107

FOR CONDUCTING COURSES OF INSTRUCTION, TRAINING AND TEACHING IN THE FIELD OF THE MANUFACTURE, DESIGN, SALE, ADVERTISING AND PROMOTION OF CARDS AND OF ARTICLES AND PRODUCTS FROM PAPER, CARD, PARCHMENT AND PARCHMENT PAPER.

FIRST USE 9-0-1989; IN COMMERCE 8-0-1995.

ELEMENTS CORRECTED
OWNER NAME

2,390,316. REG. 9-26-2000. SKYEPHARMA INC. (CALIFORNIA CORPORATION), 10450 SCIENCE CENTER DRIVE, SAN DIEGO, CA, 92121, AND CHIRON CORPORATION (DELAWARE CORPORATION), 4560 HORTON STREET, EMERYVILLE, CA, 946082916, BY CHANGE OF NAME DEPOTECH CORPORATION (DELAWARE CORPORATION), SAN DIEGO, CA, AND CHIRON CORPORATION (DELAWARE CORPORATION), EMERYVILLE, CA, SN 75-505,327. FILED 6-19-1998. PRINCIPAL REGISTER.

DEPOCYT

INT. CL. 5/U.S. CLS. 6, 18, 44, 46, 51 AND 52

FOR CYTARABINE IN SLOW-RELEASE MICROCAPSULE FORM FOR USE IN THE TREATMENT OF CANCER.

FIRST USE 4-30-1999; IN COMMERCE 4-30-1999.

ELEMENTS CORRECTED
OWNER NAME
OWNER ADDRESS

2,401,366. REG. 11-7-2000. PERKINS PAPERS LTD/PAPIERS PERKINS LTEE (CANADA CORPORATION), 77, RUE MARIE-VICTORIN, CANDIAC (QUEBEC), CANADA, J5R 1C3, SN 75-606,469. FILED 12-16-1998. PRINCIPAL REGISTER.



PRIORITY CLAIMED UNDER SEC. 44(D) ON CANADA APPLICATION NO. 895880, FILED 11-9-1998, REG. NO. TMA522880, DATED 11-9-1998, EXPIRES 2-10-2015.

THE MARK CONSISTS OF A STYLIZED REPRESENTATION OF A TRIANGULAR GLASS WITH A BASE.

INT. CL. 16/U.S. CLS. 2, 5, 22, 23, 29, 37, 38 AND 50
FOR PAPER NAPKINS.

ELEMENTS CORRECTED
OWNER NAME

2,405,746. REG. 11-21-2000. EXPEDIA, INC. (WASHINGTON CORPORATION), 13810 S.E. EASTGATE WAY, STE 400, BELLEVUE, WA, 98005, BY ASSIGNMENT MICROSOFT CORPORATION (WASHINGTON CORPORATION), REDMOND, WA, SN 75-756,129. FILED 7-20-1999. PRINCIPAL REGISTER.

EXPEDIA.COM

OWNER OF U.S. REG. NOS. 2,168,097, 2,224,559 AND OTHERS.

INT. CL. 39/U.S. CLS. 100 AND 105

FOR TRAVEL AGENCY SERVICES, NAMELY, MAKING RESERVATIONS AND BOOKINGS FOR TRANSPORTATION; PROVIDING INFORMATION CONCERNING TRAVEL AND TRAVEL-RELATED TOPICS; PROVIDING GUIDEBOOKS, TRAVEL NEWS, MAPS, CITY DIRECTORIES AND LISTINGS FOR USE BY TRAVELERS AVAILABLE ELECTRONICALLY VIA A GLOBAL COMPUTER NETWORK; PROVIDING TRAVEL INFORMATION OVER COMPUTER NETWORKS AND GLOBAL COMMUNICATION NETWORKS.

FIRST USE 10-22-1996; IN COMMERCE 10-22-1996.

ELEMENTS CORRECTED
OWNER ADDRESS

2,415,962. REG. 12-26-2000. BLOOMBERG L.P. (PARTNERSHIP), 499 PARK AVENUE, NEW YORK, NY, 10022, SN 75-925,207. FILED 2-8-2000. PRINCIPAL REGISTER.

MONEYCAST

INT. CL. 41/U.S. CLS. 100, 101 AND 107

FOR ENTERTAINMENT SERVICES IN THE NATURE OF ON-GOING AUDIO AND VISUAL PROGRAMS IN THE FIELDS OF NEWS, BUSINESS, FINANCE, CURRENT EVENTS, ENTERTAINMENT, SPORTS, HUMAN INTEREST STORIES, SECURITIES, SECURITIES MARKETS AND THE ENERGY AND ASPHALT INDUSTRIES; ENTERTAINMENT SERVICES IN THE NATURE OF PRODUCTION AND DISTRIBUTION OF * ON- * GOING AUDIO AND VISUAL PROGRAMS IN THE FIELDS OF NEWS, BUSINESS, FINANCE, CURRENT EVENTS, ENTERTAINMENT, SPORTS, HUMAN INTEREST STORIES, SECURITIES, SECURITIES MARKETS AND THE ENERGY AND ASPHALT INDUSTRIES.

FIRST USE 1-10-2000; IN COMMERCE 1-10-2000.

ELEMENTS CORRECTED
GOODS/SERVICES

2,416,922. REG. 1-2-2001. PHARMA MEDICA RESEARCH INC. (CANADA CORPORATION), 966 PANTERA DRIVE, UNIT 31, MISSISSAUGA, ONTARIO L4W 2S1, CANADA,, SN 75-657,601. FILED 3-10-1999. PRINCIPAL REGISTER.

SCIENCE IS THE FOUNDATION PHARMA MEDICA IS THE SOURCE

PRIORITY CLAIMED UNDER SEC. 44(D) ON CANADA APPLICATION NO. 1002574, FILED 1-20-1999.

INT. CL. 42/U.S. CLS. 100 AND 101

FOR PHARMACEUTICAL CONTRACT RESEARCH.
FIRST USE 12-1-1998; IN COMMERCE 12-30-1998.

ELEMENTS CORRECTED
MARK

2,441,501. REG. 4-3-2001. EXECUTORS OF THE ESTATE OF OSCAR HAMMERSTEIN II, THE (NEW YORK ESTATE) C/O COLLYER & BOOSE LLP, ONE DAG HAMMARSKJOLD PLAZA, 575 MADISON AVE., NEW YORK, NY, 10017, AND FAMILY TRUST U/W OF RICHARD RODGERS, THE (NEW YORK TRUST) C/O RODGERS & HAMMERSTEIN, 1065 AVENUE OF THE AMERICAS, SUITE 2400, NEW YORK, NY, 10018, AND FAMILY TRUST U/W DOROTHY F. RODGERS, THE (NEW YORK TRUST) C/O RODGERS & HAMMERSTEIN, 1065 AVENUE OF THE AMERICAS, SUITE 2400, NEW YORK, NY, 10018, BY ASSIGNMENT RODGERS FAMILY LLC, THE (NEW YORK), NEW YORK, NY, AND EXECUTORS OF THE ESTATE OF OSCAR HAMMERSTEIN II, THE (NEW YORK LIMITED LIABILITY COMPANY), NEW YORK, NY, SN 75-663,020. FILED 3-18-1999. PRINCIPAL REGISTER.

THE KING AND I

OWNER OF U.S. REG. NOS. 1,371,381 AND 1,735,005.
INT. CL. 28/U.S. CLS. 22, 23, 38 AND 50

FOR MUSICAL CHARACTER DOLLS; ARTICULATED AND NON-ARTICULATED DOLLS; ACTION FIGURES, CLOTHING AND ACCESSORIES FOR DOLLS AND ACTION FIGURES; TOY PLUSH DOLLS AND ANIMALS.

FIRST USE 1-1-2000; IN COMMERCE 1-1-2000.

ELEMENTS CORRECTED
OWNER NAME

2,442,208. REG. 4-10-2001. DAIMLERCHRYSLER RAIL SYSTEMS GMBH (FED REP GERMANY LIMITED JOINT STOCK CORPORATION) SAATWINKLER DAMM 42, 13627 BERLIN, FED REP GERMANY,, SN 75-827,594. FILED 10-20-1999. PRINCIPAL REGISTER.

CARGOROO

OWNER OF FED REP GERMANY REG. NO. 39922544, DATED 6-28-1999, EXPIRES 4-30-2009.

INT. CL. 7/U.S. CLS. 13, 19, 21, 23, 31, 34 AND 35

FOR MACHINES FOR TRANSPORT AND TRANSHIPMENT OF GOODS WITHIN THE COMBINED TRANSPORT ON ROAD AND RAIL, NAMELY, CRANES AND LIFTING AND HOISTING MACHINES FOR TRANSFERRING FREIGHT FROM TRUCKS TO RAILROADS AND VICE-VERSA.

FIRST USE ; IN COMMERCE .

INT. CL. 9/U.S. CLS. 21, 23, 26, 36 AND 38

FOR ELECTRIC AND ELECTRONIC INSTRUMENTS FOR CONTROLLING TRACK BOUND VEHICLES AND TROLLEY BUSES; ELECTRIC AND ELECTRONIC VEHICLE CONTROLS FOR INCLINATION OF THE CAR BODY; ELECTRONIC DATA PROCESSING MACHINES AND COMPUTERS; DATA AND PROGRAMS STORED ON DATA CARRIERS, NAMELY MAGNETIC TAPES, DISCS, OPTICAL DISCS, CD ROMS AND SEMI-CONDUCTOR MEMORY; ELECTRIC CABLES, ELECTRIC LINES AND OVERHEAD LINES, ELECTRIC WIRES; BUS BARS AND CURRENT COLLECTORS FOR TRAINS AND TROLLEY BUSES; DATA COMMUNICATION CABLES; MAGNETS, ELECTRIC TRANSFORMERS, ELECTRIC SWITCHES, FUSES, SWITCHBOARDS, CONTACTORS, ELECTRIC PRESS SWITCHES; SENSORS, CURRENT TRANSFORMERS AND ELECTRIC SAFETY SWITCHES; ELECTRIC CURRENT CONVERTERS, INVERTERS, FREQUENCY CONVERTERS AND RECTIFIERS, DIRECT ELECTRIC INSTRUMENTS FOR AUTOMATIC TRAIN MONITORING AND CONTROL; ELECTRIC TICKET DISPENSERS, ELECTRIC AND ACOUSTIC DEVICES FOR PASSENGER INFORMATION COMPRISING OPTICAL INDICATORS, TRANSMITTERS AND LOUDSPEAKERS, CONTROL DEVICES FOR CONTROLLING RAIL POINTS, ELECTRIC CONTROL DEVICES FOR ELECTRIC DRIVES FOR LAND VEHICLES, RAILROAD SIGNALS.

FIRST USE ; IN COMMERCE .

INT. CL. 12/U.S. CLS. 19, 21, 23, 31, 35 AND 44

FOR VEHICLES FOR TRANSPORT OVER LAND, NAMELY LOCOMOTIVES, TRAINS, PASSENGER TRAINS, AUTOMATIC SHORT DISTANCE TRACKBOUND SHUTTLES FOR PASSENGER TRANSPORT, LOCAL TRAINS, HIGH-SPEED TRAINS, URBAN TRAINS, LONG DISTANCE TRAINS, RAILWAY WAGONS, RAIL BUSES, TRAMWAYS, TROLLEY BUSES, COGWHEEL, STATIONARY AND TELPHER RAILWAYS, NAMELY, CABLE CARS AND FUNICULARS, DRIVING UNITS, NAMELY, LOCOMOTIVES WITH WAGONS, RAIL CARS, BOGIES FOR THE COMBINED TRANSPORT ON ROAD AND RAIL, NAMELY FREIGHT VEHICLES THAT CAN BE SWITCHED FROM RAIL TO TRUCKS AND VICE-VERSA; ELECTRIC MOTORS FOR LAND VEHICLES, RAILWAY VEHICLES AND TROLLEY BUSES; ELECTRICAL TRACTION MOTORS, BRAKES, BOGIES, CAR BODIES, RAILWAY WHEELS, COMPONENT PARTS AND UNITS FOR STRUCTURAL PARTS FOR ALL AFOREMENTIONED GOODS.

FIRST USE ; IN COMMERCE .

INT. CL. 16/U.S. CLS. 2, 5, 22, 23, 29, 37, 38 AND 50

FOR MAGAZINES, PUBLICATIONS, NAMELY NEWS-LETTERS AND BROCHURES, SERVICE MANUALS AND TRAINING MANUALS IN THE FIELD OF LAND BOUND TRAFFIC.

FIRST USE : IN COMMERCE .
INT. CL. 37/U.S. CLS. 100, 103 AND 106

FOR REPAIR, MAINTENANCE AND CLEANING OF LAND BOUND VEHICLES .

FIRST USE : IN COMMERCE .
INT. CL. 39/U.S. CLS. 100 AND 105

FOR TRANSPORTATION SERVICES, NAMELY TRANSPORT OF GOODS AND/OR PERSONS BY TRAINS, TRUCKS AND OTHER VEHICLES.

FIRST USE : IN COMMERCE .

ELEMENTS CORRECTED
PRIORITY CLAIMED STATEMENT

2,444,713. REG. 4-17-2001. HANOLA INTERNATIONAL INC (CANADA CORPORATION), 17 FAWCETT RD STE 116, COQUITTON, BRITISH COLUMBIA, CANADA, V3K 6V2, BY CHANGE OF NAME M&R ENTERPRISES INC. (CANADA CORPORATION), COQUITLAM, BRITISH COLUMBIA, CANADA, SN 75-446,972. FILED 3-9-1998. PRINCIPAL REGISTER.

JAN-PLAN

PRIORITY CLAIMED UNDER SEC. 44(D) ON CANADA APPLICATION NO. 870451, FILED 2-25-1998, REG. NO. TMA518261, DATED 10-20-1999, EXPIRES 10-20-2014.

INT. CL. 9/U.S. CLS. 21, 23, 26, 36 AND 38

FOR EDUCATIONAL COMPUTER SOFTWARE PROGRAMS AND MANUALS SOLD AS A UNIT IN THE FIELD OF BUILDING MAINTENANCE, HOME RENOVATION AND LANDSCAPE MAINTENANCE; PRE-RECORDED AUDIO CASSETTES FEATURING INSTRUCTIONS ON BUILDING MAINTENANCE, HOME CARE AND LANDSCAPE MAINTENANCE; PRE-RECORDED VIDEO CASSETTES FEATURING INSTRUCTIONS ON BUILDING MAINTENANCE, HOME CARE AND LANDSCAPE MAINTENANCE.

FIRST USE 7-13-1999; IN COMMERCE 7-0-1999.
INT. CL. 16/U.S. CLS. 2, 5, 22, 23, 29, 37, 38 AND 50

FOR PRINTED EDUCATIONAL AND TRAINING MATERIALS IN THE FIELD OF BUILDING MAINTENANCE, HOME CARE, AND LANDSCAPE MAINTENANCE, NAMELY, BOOKS, CATALOGS, BUSINESS FORMS AND PAMPHLETS.

FIRST USE 7-13-1999; IN COMMERCE 7-0-1999.
INT. CL. 35/U.S. CLS. 100, 101 AND 102

FOR BUSINESS MARKETING CONSULTING SERVICES; FRANCHISING, NAMELY, TECHNICAL ASSISTANCE IN THE ESTABLISHMENT AND/OR OPERATION OF BUILDING MAINTENANCE, HOME CARE AND LANDSCAPE MAINTENANCE BUSINESSES.
FIRST USE 7-13-1999; IN COMMERCE 7-0-1999.

ELEMENTS CORRECTED
ASSIGNMENT/NAME CHANGE

2,446,088. REG. 4-24-2001. DATATRAC INFORMATION SERVICES, INC. (TEXAS CORPORATION), 2140 LAKE PARK BOULEVARD, RICHARDSON, TX, 75080, SN 75-886,406. FILED 1-5-2000. PRINCIPAL REGISTER.

G-CRM

INT. CL. 35/U.S. CLS. 100, 101 AND 102

FOR BUSINESS MANAGEMENT CONSULTING SERVICES PROVIDED TO FEDERAL, STATE AND LOCAL AGENCIES RELATING TO THE DEVELOPMENT AND MAINTENANCE OF RELATIONSHIPS WITH MEMBERS OF THE PUBLIC, BUSINESS PROCESS RE-ENGINEERING, CUSTOMER SATISFACTION MEASUREMENT AND CUSTOMER SERVICE PROGRAMS, NAMELY, CONDUCTING BUSINESS RESEARCH AND BUSINESS SURVEYS; AND OUTSOURCED TELEPHONE CALL CENTER, E-MAIL AND GLOBAL COMPUTER NETWORK TRANSACTION HANDLING SERVICES.

FIRST USE 2-24-2000; IN COMMERCE 2-24-2000.
INT. CL. 37/U.S. CLS. 100, 103 AND 106

FOR INSTALLATION, UPGRADE AND MAINTENANCE OF CALL CENTER HARDWARE, CONTACT MANAGEMENT AND CUSTOMER INTERACTION SYSTEMS, COMPUTER TELEPHONY INTEGRATION, INTERACTIVE VOICE RESPONSE SYSTEMS, E-MAIL AND INTERACTIVE SYSTEMS PROVIDED OVER A GLOBAL COMPUTER NETWORK, FOR FEDERAL, STATE AND LOCAL AGENCIES.

FIRST USE 2-24-2000; IN COMMERCE 2-24-2000.
INT. CL. 41/U.S. CLS. 100, 101 AND 107

FOR TRAINING SERVICES PROVIDED TO FEDERAL, STATE AND LOCAL AGENCIES RELATED TO THE DEVELOPMENT AND MAINTENANCE OF RELATIONSHIPS WITH MEMBERS OF THE PUBLIC, NAMELY, CONDUCTING SEMINARS, CLASSES AND WORKSHOPS IN THE FIELD OF ADVANCED COMMUNICATION SKILLS, GRAMMAR, PRONUNCIATION AND VOCABULARY, ACTIVE LISTENING, BUILDING RAPPORT, SKILLFUL USE OF QUESTIONS, CALL FLOW MANAGEMENT, AND HANDLING DIFFICULT CALLERS.

FIRST USE 2-24-2000; IN COMMERCE 2-24-2000.
INT. CL. 42/U.S. CLS. 100 AND 101

FOR CONSULTATION SERVICES PROVIDED FOR FEDERAL, STATE AND LOCAL AGENCIES RELATING TO INFORMATION TECHNOLOGY AND INFORMATION MANAGEMENT, COMPUTERS, NETWORKS, TELEPHONY SYSTEMS, AND SOFTWARE; AND INSTALLATION AND MAINTENANCE OF COMPUTER SOFTWARE SYSTEMS, NAMELY, ACD/PBX SYSTEMS.

FIRST USE 2-24-2000; IN COMMERCE 2-24-2000.

ELEMENTS AMENDED
OWNER ADDRESS

2,449,104. REG. 5-8-2001. JUNIPER GROVE, INC. (OREGON CORPORATION), DBA JUNIPER GROVE FARM, 2024 S.W. 58TH STREET, REDMOND, OR, 97756, SN 76-016,644. FILED 4-3-2000. PRINCIPAL REGISTER.

THOR'S

INT. CL. 29/U.S. CL. 46
FOR GOAT CHEESE.
FIRST USE 8-12-1997; IN COMMERCE 8-12-1997.

ELEMENTS CORRECTED
OWNER NAME

2,450,289. REG. 5-8-2001. RUTGERS, THE STATE UNIVERSITY OF NEW JERSEY (NEW JERSEY CORPORATION), 7 COLLEGE AVENUE, OFFICE OF UNIVERSITY COUNSEL, WINANTS HALL, ROOM 42, NEW BRUNSWICK, NJ, 08901, SN 75-563,705. FILED P.R. 10-5-1998; AM. S.R. 11-10-1999. SUPPLEMENTAL REGISTER.

UNIVERSITY OF NEW JERSEY

NO CLAIM IS MADE TO THE EXCLUSIVE RIGHT TO USE "UNIVERSITY", APART FROM THE MARK AS SHOWN.

INT. CL. 41/U.S. CLS. 100, 101 AND 107
FOR EDUCATIONAL SERVICES, NAMELY PROVIDING AND CONDUCTING COLLEGE LEVEL COURSES. FIRST USE 9-8-1998; IN COMMERCE 9-8-1998.

ELEMENTS CORRECTED
OWNER ADDRESS

2,451,350. REG. 5-15-2001. SOCCER DOCS, LLC (MINNESOTA LIMITED LIABILITY COMPANY) 262 SOUTH GRIGGS, ST. PAUL, MN, 55105, BY CHANGE OF NAME SOCCER STRATEGIES, LLC (MINNESOTA), ST. PAUL, MN, SN 75-479,168. FILED 5-5-1998. PRINCIPAL REGISTER.

SOCCERDOCS

INT. CL. 9/U.S. CLS. 21, 23, 26, 36 AND 38
FOR PROTECTIVE HEADWEAR FOR SOCCER. FIRST USE 6-26-2000; IN COMMERCE 6-26-2000.

ELEMENTS CORRECTED
ASSIGNMENT/NAME CHANGE

2,467,866. REG. 7-10-2001. LEASEFORUM, INC. (DELAWARE CORPORATION), 313 CONGRESS STREET, BOSTON, MA, 02210, SN 76-081,181. FILED 6-30-2000. PRINCIPAL REGISTER.

LEASEFORUM

INT. CL. 36/U.S. CLS. 100, 101 AND 102
FOR PROVIDING A WEB-BASED, ON-LINE MARKETPLACE FOR THE COMMERCIAL EQUIPMENT LEASING INDUSTRY, NAMELY, A COMMUNITY FOR LESSEES AND LESSORS TO EXCHANGE INFORMATION AND TO ORIGINATE, SELL AND MANAGE COMMERCIAL EQUIPMENT LEASES, LEASED ASSETS AND FIXED CAPITAL ASSETS, ALL VIA A GLOBAL COMPUTER NETWORK.
FIRST USE 8-16-1999; IN COMMERCE 8-16-1999.

ELEMENTS CORRECTED
MARK

2,473,248. REG. 7-31-2001. TIME WARNER ENTERTAINMENT COMPANY, L.P. (DELAWARE LIMITED PARTNERSHIP), 75 ROCKEFELLER PLAZA, NEW YORK, NY, 10019, SN 75-934,537. FILED 2-29-2000. PRINCIPAL REGISTER.

NO DRAWING-SENSORY MARK

THE MARK CONSISTS OF THIRTY (30) MUSICAL NOTES COMPRISING THE NOTES BFLAT4, EFLAT4, D4, C4, BFLAT3, G3, BFLAT3, EFLAT4, EFLAT4, D4, C4, DFLAT4, D4, D4, D4, BFLAT3, C4, BFLAT3, D4, D4, BFLAT3, C4, G3, G3, BFLAT3, B3, C4, D4, EFLAT, AND G4. THE MARK CONSISTS OF THE MERRIE MELODIES THEME SONG.

INT. CL. 41/U.S. CLS. 100, 101 AND 107
FOR ENTERTAINMENT SERVICES IN THE NATURE OF A LIVE-ACTION, COMEDY, DRAMA AND ANIMATED TELEVISION PROGRAMS; PRODUCTION OF LIVE-ACTION, COMEDY, DRAMA AND ANIMATED TELEVISION PROGRAMS; A LIVE-ACTION, COMEDY, DRAMA AND ANIMATED MOTION PICTURE THEATRICAL FILMS; PRODUCTION OF LIVE-ACTION, COMEDY, DRAMA AND ANIMATED MOTION PICTURE THEATRICAL FILMS; THEATRICAL PERFORMANCES BOTH ANIMATED AND LIVE ACTION; INTERNET SERVICE PROVIDING INFORMATION VIA AN ELECTRONIC GLOBAL COMPUTER NETWORK IN THE FIELD OF ENTERTAINMENT RELATING SPECIFICALLY TO MUSIC, MOVIES, AND TELEVISION; PROVIDING GENERAL INTEREST NEWS, ENTERTAINMENT, AND EDUCATION INFORMATION VIA A GLOBAL COMPUTER NETWORK; AND PROVIDING INFORMATION FOR AN ACTUAL ENTERTAINMENT VIA ELECTRONIC GLOBAL COMMUNICATION NETWORK IN THE NATURE OF LIVE ACTION, COMEDY, DRAMA AND/OR ANIMATED PROGRAMS AND PRODUCTION OF LIVE-ACTION COMEDY, ACTION AND ANIMATED MOTION FILMS FOR DISTRIBUTION VIA A GLOBAL COMPUTER NETWORK.
FIRST USE 0-0-1985; IN COMMERCE 0-0-1985.

ELEMENTS CORRECTED
DESCRIPTION OF MARK

2,475,420. REG. 8-7-2001. COMPASSCOM, INC. (COLORADO CORPORATION), 6770 S. DAWSON CIRCLE, UNIT 1A, ENGLEWOOD, CO, 80112, SN 75-934,439. FILED 3-2-2000. PRINCIPAL REGISTER.

COMPASSCOM

INT. CL. 42/U.S. CLS. 100 AND 101
FOR DESIGN OF COMPUTER SOFTWARE AND EQUIPMENT FOR USE IN GLOBAL POSITIONING SYSTEMS.
FIRST USE 10-18-1994; IN COMMERCE 10-18-1994.

ELEMENTS CORRECTED
OWNER NAME

2,476,317. REG. 8-7-2001. EXECUTORS OF THE ESTATE OF OSCAR HAMMERSTEIN II, THE (NEW YORK ESTATE) ONE DAG HAMMEARSKJOLF PLAZA, NEW YORK, NY, 10017, AND FAMILY TRUST U/W RICHARD RODGER, THE (NEW YORK TRUST) C/O RODGER & HAMMERSTEIN, 1065 AVENUE OF THE AMERICAS, SUITE 2400, NEW YORK, NY, 10018, AND FAMILY TRUST U/W DOROTHY F. RODGERS, THE (NEW YORK TRUST) C/O RODGERS & HAMMERSTEIN, 1065 AVENUE OF THE AMERICAS, SUITE 2400, NEW YORK, NY, 10018, BY ASSIGNMENT RODGERS FAMILY LLC, THE (NEW YORK), NEW YORK, NY, AND EXECUTORS OF THE ESTATE OF OSCAR HAMMERSTEIN II, THE (NEW YORK) LIMITED LIABILITY COMPANY, NEW YORK, NY, SN 75-663,170. FILED 3-18-1999. PRINCIPAL REGISTER.

THE KING AND I

OWNER OF U.S. REG. NOS. 1,371,381 AND 1,735,005.
INT. CL. 9/U.S. CLS. 21, 23, 26, 36 AND 38
FOR COMPUTER CD ROM'S, PRE-RECORDED AUDIO CASSETTES FEATURING PLOTS AND/OR CHARACTERS FROM THE PLAY OF THE SAME NAME AND BOOKS SOLD AS UNIT.
FIRST USE 1-1-2000; IN COMMERCE 1-1-2000.

ELEMENTS CORRECTED
OWNER NAME

2,478,095. REG. 8-14-2001. INTELLISPARK INC. (DELAWARE CORPORATION), 1025 CONNECTICUT AVE., STE. 1012, WASHINGTON, DC, 20036, SN 76-122,560. FILED 9-5-2000. PRINCIPAL REGISTER.

INTELLISPARK

INT. CL. 35/U.S. CLS. 100, 101 AND 102
FOR BUSINESS CONSULTING SERVICES, NAMELY, DESIGN AND DEVELOPMENT OF BUSINESS STRATEGY, INFORMATION TECHNOLOGY STRATEGY, BUSINESS PROCESSES AND PROJECT MANAGEMENT.
FIRST USE 10-15-2000; IN COMMERCE 10-15-2000.

ELEMENTS CORRECTED
OWNER ADDRESS

2,479,012. REG. 8-21-2001. GLOBAL TOTAL OFFICE (CANADA LIMITED PARTNERSHIP), 560 SUPERTEST RD, DOWNSVIEW ONTARIO, CANADA, M3J 2M6, BY ASSIGNMENT GLOBAL UPHOLSTERY COMPANY (CANADA LIMITED PARTNERSHIP), DOWNSVIEW ONTARIO, CANADA, SN 75-727,537. FILED 6-7-1999. PRINCIPAL REGISTER.

ALEXANDRA

PRIORITY CLAIMED UNDER SEC. 44(D) ON CANADA APPLICATION NO. 1004455, FILED 2-8-1999.
INT. CL. 20/U.S. CLS. 2, 13, 22, 25, 32 AND 50
FOR OFFICE FURNITURE.
FIRST USE 8-0-1999; IN COMMERCE 8-0-1999.

ELEMENTS CORRECTED
ASSIGNMENT/NAME CHANGE

2,480,722. REG. 8-21-2001. BOWEN HILL, LTD. (HONG KONG CORPORATION), SUITE 713, 7F., WING ON PLAZA, 62 MODY ROAD, TSIM SHA TSUI EAST, KOWLOON, HONG KONG., SN 75-803,332. FILED 9-20-1999. PRINCIPAL REGISTER.

ASTROLON

INT. CL. 9/U.S. CLS. 21, 23, 26, 36 AND 38
FOR TELESCOPES, MICROSCOPES, VIDEOSCOPIES, MAGNIFYING SCOPES, MAGNIFYING GLASSES, OPTICAL MIRRORS, BINOCULARS, AND EDUCATIONAL ACTIVITY AND CHEMISTRY KITS CONSISTING PRIMARILY OF MICROSCOPES, VIDEOSCOPIES, MAGNIFYING SCOPES, MAGNIFYING GLASSES, CHEMICALS IN VIALS, BEAKERS, TEST TUBES, TEST TUBE RACKS, CORK STOPPERS, MEASURING SPOONS, FUNNELS, STIRRING RODS, TUBING, LITMUS PAPERS, FILTER PAPERS, GOGGLES, BRUSHES, AND OPEN FLAME LAMPS.
FIRST USE 5-0-1998; IN COMMERCE 6-0-1998.

ELEMENTS CORRECTED
OWNER ADDRESS

2,480,901. REG. 8-21-2001. VIRTUOSO, LTD. (DELAWARE CORPORATION), 500 MAIN STREET, SUITE 400, FORT WORTH, TX, 76102, BY CHANGE OF NAME ALLIED PERCIVAL INTERNATIONAL, LTD. (DELAWARE CORPORATION), FORT WORTH, TX, SN 75-914,204. FILED 2-9-2000. PRINCIPAL REGISTER.

SPECIALISTS IN THE ART OF TRAVEL

INT. CL. 35/U.S. CLS. 100, 101 AND 102
FOR BUSINESS MARKETING CONSULTATION SERVICES FOR OTHERS, IN THE FIELD OF TRAVEL, NAMELY, MARKETING FOR TRAVEL AGENCIES, CRUISE LINES AND PACKAGED TRAVEL GROUPS.
FIRST USE 1-11-2000; IN COMMERCE 1-11-2000.
INT. CL. 38/U.S. CLS. 100, 101 AND 104
FOR PROVIDING MULTIPLE-USER ACCESS TO A GLOBAL COMPUTER INFORMATION NETWORK.
FIRST USE 1-11-2000; IN COMMERCE 1-11-2000.
INT. CL. 42/U.S. CLS. 100 AND 101
FOR HOSTING THE WEB SITES OF OTHERS ON A COMPUTER SERVER FOR A GLOBAL COMPUTER NETWORK.
FIRST USE 1-11-2000; IN COMMERCE 1-11-2000.

ELEMENTS CORRECTED
ASSIGNMENT/NAME CHANGE

2,481,177. REG. 8-28-2001. CORECO IMAGING, INC. (DELAWARE CORPORATION), 55 MIDDLESEX TURNPIKE, BEDFORD, MA, 017301421, BY CHANGE OF NAME IMAGING TECHNOLOGY INCORPORATED (MASSACHUSETTS CORPORATION), BEDFORD, MA, SN 75-527,432. FILED 7-29-1998. PRINCIPAL REGISTER.

PCVISION

OWNER OF U.S. REG. NO. 1,442,923.
INT. CL. 9/U.S. CLS. 21, 23, 26, 36 AND 38

FOR FRAME-GRABBERS, NAMELY, COMPUTER HARDWARE THAT CONVERTS VIDEO IMAGES INTO COMPUTER MEMORY AND DISPLAYS IMAGES FROM COMPUTER MEMORY, AND USER MANUALS SOLD AS A UNIT THEREWITH.

FIRST USE 12-0-1997; IN COMMERCE 12-0-1997.

ELEMENTS CORRECTED
OWNER ADDRESS

2,485,575. REG. 9-4-2001. LEVITON MANUFACTURING CO., INC. (DELAWARE CORPORATION), 59-25 LITTLE NECK PARKWAY, LITTLE NECK, NY, 11362, SN 75-487,245. FILED 5-18-1998. PRINCIPAL REGISTER.

GIGAMAX

INT. CL. 9/U.S. CLS. 21, 23, 26, 36 AND 38

FOR ELECTRICAL JACKS, PLUGS, PATCH CORDS, INSULATION DISPLACEMENT CONNECTOR BLOCKS, [CONNECTOR BLOCKS,] CONNECTOR MODULES, AND CONNECTORS FOR THE TRANSMISSION AND INTERCONNECTION OF VOICE, DATA, VIDEO, AND AUDIO SIGNALS; AND PLATES, SURFACE-MOUNT BOXES, PATCH PANELS, PATCH BLOCKS, PATCH CORDS, INSULATION DISPLACEMENT CONNECTOR BLOCKS, AND HOUSINGS IN WHICH JACKS, PLUGS, CONNECTOR MODULES, AND CONNECTORS FOR THE TRANSMISSION AND INTERCONNECTION OF VOICE, DATA, VIDEO, AND AUDIO SIGNALS ARE MOUNTED OR OTHERWISE RETAINED.

FIRST USE 7-0-1998; IN COMMERCE 7-0-1998.

ELEMENTS CORRECTED
GOODS/SERVICES

2,486,014. REG. 9-4-2001. PC MARKETING, INC. (NEW JERSEY CORPORATION), 1040 WILT AVENUE, RIDGEFIELD, NJ, 07657, SN 75-810,935. FILED 9-29-1999. PRINCIPAL REGISTER.

VECTOR PLUS

INT. CL. 11/U.S. CLS. 13, 21, 23, 31 AND 34

FOR TANNING [BEDS COMPONENT] *BED COMPONENTS*, NAMELY, ULTRAVIOLET LAMPS.

FIRST USE 9-1-1999; IN COMMERCE 2-0-2000.

ELEMENTS CORRECTED
GOODS/SERVICES

2,488,159. REG. 9-11-2001. WHEAT FIRST SECURITIES, INC. (VIRGINIA CORPORATION), 901 EAST BYRD STREET, RICHMOND, VA, 23219, SN 75-564,925. FILED 10-6-1998. PRINCIPAL REGISTER.

RETIREMENT LANDSCAPE FINANCIAL SUCCESS IN A CHANGING WORLD

OWNER OF U.S. REG. NOS. 1,883,105 AND 2,152,849.
INT. CL. 36/U.S. CLS. 100, 101 AND 102

FOR FINANCIAL SERVICES, NAMELY, INDIVIDUAL RETIREMENT PLANNING.

FIRST USE 1-0-1999; IN COMMERCE 1-0-1999.

ELEMENTS CORRECTED
ASSIGNMENT/NAME CHANGE

2,492,003. REG. 9-25-2001. DEALS-NOTHING OVER A DOLLAR, LLC (MISSOURI CORPORATION), 11966 ST. CHARLES ROCK ROAD, BRIDGETON, MO, 63044, BY ASSIGNMENT GRAMEX CORPORATION (MISSOURI), BRIDGETON, MO, SN 75-863,507. FILED 12-3-1999. PRINCIPAL REGISTER.



NO CLAIM IS MADE TO THE EXCLUSIVE RIGHT TO USE "NOTHING OVER A DOLLAR", APART FROM THE MARK AS SHOWN.

INT. CL. 35/U.S. CLS. 100, 101 AND 102

FOR RETAIL STORE SERVICES FEATURING GENERAL MERCHANDISE AT DISCOUNT PRICES.

FIRST USE 11-1-1999; IN COMMERCE 11-1-1999.

ELEMENTS CORRECTED
OWNER ADDRESS
CITIZENSHIP
ASSIGNMENT/NAME CHANGE
OWNER NAME
ENTITY

2,493,030. REG. 9-25-2001. INLITEN, L.L.C. (ILLINOIS CORPORATION), 181 NORTH WAUKEGAN ROAD, SUITE 205, NORTHFIELD, IL, 60093, SN 75-545,576. FILED 8-31-1998. PRINCIPAL REGISTER.

INLITEN

INT. CL. 9/U.S. CLS. 21, 23, 26, 36 AND 38

FOR ELECTRICAL POWER EXTENSION CORDS; AND ELECTRICAL AND BATTERY OPERATED TESTING DEVICES USED TO TEST ELECTRICAL VOLTAGE AND CURRENT; BATTERY OPERATED CHRISTMAS DECORATIONS; AND ELECTRIC CHRISTMAS AND SEASONAL ORNAMENTS AND GARLANDS THAT MOVE OR EMIT SOUNDS.

FIRST USE 6-1-1998; IN COMMERCE 6-1-1998.

INT. CL. 11/U.S. CLS. 13, 21, 23, 31 AND 34

FOR DECORATIVE ELECTRIC LIGHT STRINGS; STRING LIGHTING SETS COMPRISED OF LIGHTS, EXTENSION CORDS, BULBS; ELECTRIC DECORATIVE ORNAMENTS IN THE NATURE OF ELECTRIC CANDLES, SIGNS AND CHARACTERS; ORNAMENTAL LIGHTING, NAMELY, ELECTRIC LIGHTS AND BULBS FOR CHRISTMAS AND SEASONAL HOLIDAYS; SEASONAL DECORATIONS MADE OF ELECTRIC LIGHTING FIXTURES; ELECTRICALLY-ACTIVATED AIR FRESHENERS DISPENSING UNITS FOR ROOM FRAGRANCES; AND BATTERY OPERATED CHRISTMAS LIGHTS; ILLUMINATED ELECTRIC CHRISTMAS AND SEASONAL LIGHTING DISPLAYS WITH PREPROGRAMMED LIGHTS FOR DISPLAYING CHANGEABLE HOLIDAY MESSAGES; AND ELECTRIC AND [BATTERY] *BATTERY* POWERED LIGHTING DISPLAYS.

FIRST USE 6-1-1998; IN COMMERCE 6-1-1998.

INT. CL. 20/U.S. CLS. 2, 13, 22, 25, 32 AND 50

FOR ELECTRIC DECORATIVE WATER GLOBES;
CHRISTMAS AND SEASONAL DECORATIONS IN THE
NATURE OF PLASTIC TWO-SIDE SCENES; AND PLAS-
TIC CHRISTMAS AND SEASONAL ORNAMENTS.
FIRST USE 6-1-1998; IN COMMERCE 6-1-1998.

ELEMENTS CORRECTED
GOODS/SERVICES

* * * * *

TRADEMARK REGISTRATIONS—NEW CERTIFICATES

New Certificates issued under section 7(e) of the Trademark Act of 1946 for the unexpired term of the original registrations.

1,816,552. SUPER SHIMMER. INT. CL. 1. CHALLENGER
MANUFACTURING, INC., BATAVIA, IL. REG. 1-18-1994.
NEW CERT. SEC. 7(C) TO REGISTRANT.

2,445,781. SUPER JUICE WITH ECHINACEA AND DE-
SIGN. INT. CL. 32. ODWALLA, INC., HALF MOON BAY,
CA. REG. 4-24-2001. NEW CERT. SEC. 7(C) TO REGIS-
TRANT.

* * * * *

This page is intentionally blank

INDEX OF REGISTRANTS

JANUARY 29, 2002

(Registered; Renewed; Canceled; Amended, Corrected, etc.; New Certificates; 12c Publications.)

The designation "U.S. Cl." appearing in this section refers to the U.S. class in effect prior to Sep. 1, 1973 rather than the international class which applies to applications filed on or after that date. For adoption of international classification see notice in the OFFICIAL GAZETTE of Jun. 26, 1973 (911 O.G. TM 210).

& CO., SAN FRANCISCO, CA, W.A.I.T., INC., SAN FRANCISCO, CA:
1,670,306. REN. 12-21-01. INT. CL. 25.

"O.D.A.M." OFFICE DE DISTRIBUTION D'APPAREILS MEDICAUX (SOCIETE ANONYME), 67160, WISSEMBOURG, FRANCE:
1,866,304, CANC. INT. CL. 10.

A. J. BRANDON, INC., MINNEAPOLIS, MN:
1,866,462, CANC. INT. CL. 25.

A. O. SMITH CORPORATION, KANKAKEE, IL:
708,212, CANC. U.S. CL. 34.

A.M. CASTLE & CO., FRANKLIN PARK, IL:
2,534,390, INT. CL. 35.

A.T. & G. COMPANY, INC., FARMINGTON HILLS, MI:
1,865,582, CANC. INT. CL. 8.

AAA FIRE & SAFETY, INC., SEATTLE, WA, AAA FIRE EXTINGUISHER COMPANY, INC., SEATTLE, WA:
1,150,685. REN. 12-21-01. INT. CL. 42.

AB PH. NEDERMAN & CO., S-252 28 HELSINGBORG, SWEDEN:
2,533,574, PUB. 11-6-2001. INT. CL. 11.

ABATIS INTERNATIONAL, LLC, GARFIELD, NJ:
2,534,082, PUB. 11-6-2001. MULTIPLE CLASS, INT. CLS. 9 AND 41.

ABAYA, CAROL, MARLBORO, NJ, DBA CAROL ABAYA ASSOCIATES:
1,866,626, CANC. INT. CL. 16.

ABB LUMMUS GLOBAL, INC., BLOOMFIELD, NJ, LUMMUS COMPANY, THE, BLOOMFIELD, NJ:
924,846. REN. 12-18-01. MULTIPLE CLASS, U.S. CLS. 100 (INT. CL. 42), 101 (INT. CL. 35), 103 (INT. CL. 37) AND 106 (INT. CL. 40).

ABBOTT LABORATORIES, ABBOTT PARK, IL:
390,357. REN. 12-21-01. U.S. CL. 6 (INT. CL. 5).

ABBOTT LABORATORIES, NORTH CHICAGO, IL:
708,005, CANC. U.S. CL. 18.

ABBOTT LABORATORIES, ABBOTT PARK, IL, SORENSON RESEARCH CO., SALT LAKE CITY, UT:
921,198. REN. 12-19-01. U.S. CL. 44 (INT. CL. 10).

ABDULLAH BIN YOUSUF ALI HAMADI, RUWI, OMAN, DBA AL-HAMADI TRADING & CONTRACTING ESTABLISHMENT:
1,866,505, CANC. INT. CL. 29.

ABN AMRO NORTH AMERICA, INC., CHICAGO, IL:
2,533,224, PUB. 11-6-2001. INT. CL. 36.
2,533,226, PUB. 11-6-2001. INT. CL. 36.

ABP HOLDINGS, INC., BOSTON, MA:
2,534,803, INT. CL. 42.

ACCETTA, RODERICK W., DOVER, DE:
2,533,554, PUB. 11-6-2001. INT. CL. 10.

ACCO WORLD CORPORATION, LINCOLNSHIRE, IL:
2,534,854, INT. CL. 9.

ACCOUNTABLE ADVERTISING, INC., GARDEN CITY, NY, DBA BENCI-VENTURES, INC.:
1,866,623, CANC. INT. CL. 16.

ACCURATE METERING SYSTEMS, INC., SCHAUMBURG, IL:
2,534,535, INT. CL. 9.
2,534,536, INT. CL. 9.

ACE WORLD COMPANIES, INC., FORT WORTH, TX FROM ACE-TRONICS COMPANY, INC., FORT WORTH, TX:
2,534,389, INT. CL. 9.

ACEY SALES & DEVELOPMENT CO., DEARBORN, MI:
1,142,253, CANC. INT. CL. 7.
1,142,254, CANC. INT. CL. 7.

ACHIEVEGLOBAL, INC., TAMPA, FL, ZENGER-MILLER, INC., SAN JOSE, CA:
1,665,727. REN. 12-19-01. MULTIPLE CLASS, INT. CLS. 9 AND 16.

ACT. INC., IOWA CITY, IA:
2,534,497, INT. CL. 9.

ACTION * USA, INC., PRINCETON, NJ:
1,865,940, CANC. INT. CL. 35.

ACTIVITY DIRECTORIES INTERNATIONAL, INC., LITTLETON, CO:
1,865,752, CANC. INT. CL. 16.

ACUCOR, INC., URBAN DALE, IA:
2,534,329, PUB. 11-6-2001. INT. CL. 37.

ACUSON CORPORATION, MOUNTAIN VIEW, CA:
2,534,598, INT. CL. 9.

ADAMSBERG HOLDINGS LIMITED, ROAD TOWN, TORTOLA, BR. VIRGIN ISLANDS, JONES APPAREL GROUP, INC., BRISTOL, PA:
1,165,638. REN. 12-20-01. INT. CL. 25.

ADCO, INC., SEDALIA, MO:
1,207,703. REN. 12-20-01. INT. CL. 1.

ADDAZI, INC., LOS ANGELES, CA:
1,865,835, CANC. INT. CL. 25.

ADDISON WESLEY LONGMAN, INC., READING, MA:
2,534,427, INT. CL. 16.

ADDRESS.COM, INC., MONTEBELLO, CA:
2,535,021, INT. CL. 35.

ADELPHI UNIVERSITY, GARDEN CITY, NY:
1,781,338, CANC. MULTIPLE CLASS, INT. CLS. 16, 20, 21 AND 25.

ADERO, INC., BOSTON, MA:
2,533,653, PUB. 11-6-2001. MULTIPLE CLASS, INT. CLS. 35 AND 42.

ADINA WIGS INC., STATEN ISLAND, NY:
1,865,868, CANC. INT. CL. 26.

ADOBEAIR, INC., PHOENIX, AZ:
1,865,714, CANC. INT. CL. 11.

ADPAC COMPUTING LANGUAGES CORPORATION, SAN FRANCISCO, CA:
1,142,286, CANC. INT. CL. 9.

ADVANCE PRODUCTS CORPORATION, BENTON HARBOR, MI:
2,534,629, INT. CL. 7.

ADVANCED CIRCUIT TECHNOLOGY, INC., NASHUA, NH:
1,168,159. REN. 12-15-01. MULTIPLE CLASS, INT. CLS. 9 AND 42.

ADVANCED HARDWARE ARCHITECTURES, INC., PULLMAN, WA:
2,533,212, PUB. 11-6-2001. INT. CL. 9.

ADVANCED INSTITUTE OF HAIR DESIGN, INC., MILWAUKEE, WI AND BEAUTY SCHOOLS, INC., MILWAUKEE, WI AND ONE TEN, INC., MILWAUKEE, WI:
1,866,009, CANC. MULTIPLE CLASS, INT. CLS. 41 AND 42.
1,866,046, CANC. INT. CL. 42.

ADVENTURE GOLF & GAMES, INC., WINSTON-SALEM, NC:
2,533,776, PUB. 11-6-2001. INT. CL. 41.

- AEGIS ENTERTAINMENT, INC., SAN DIEGO, CA:
1,866,365, CANC. INT. CL. 16.
- AEOLIAN PIANOS, INC., NEW YORK, NY:
708,214, CANC. U.S. CL. 36.
- AEOLUS TECHNOLOGY LLC, FORT COLLINS, CO:
2,533,265, PUB. 11-6-2001. INT. CL. 12.
- AEROFLEX INTERNATIONAL CO., LTD., CHANGWAD
RAYONG, THAILAND:
2,534,491, INT. CL. 12.
- AFFIRMED MEDICAL, INC., CATHEDRAL CITY, CA:
1,866,313, CANC. INT. CL. 10.
- AF2 ENTERPRISES LLC, CHICAGO, IL:
2,534,231, PUB. 11-6-2001. INT. CL. 41.
2,534,273, PUB. 11-6-2001. INT. CL. 41.
2,534,274, PUB. 11-6-2001. INT. CL. 41.
2,534,275, PUB. 11-13-2001. MULTIPLE CLASS, INT. CLS.
16, 25 AND 41.
- AG COMMUNICATION SYSTEMS CORPORATION, PHOE-
NIX, AZ:
1,865,604, CANC. INT. CL. 9.
- AG-MARK, INC., TEACHEY, NC:
1,142,207, CANC. INT. CL. 5.
- AGFA-GEVAERT N.V., B- 2640 MORTSEL, BELGIUM,
HOECHST AKTIENGESELLSCHAFT, 6230 FRANKFURT
AM MAIN 80, FED REP GERMANY:
1,652,813. REN. 12-19-01. MULTIPLE CLASS, INT. CLS. 1
AND 16.
- AGRESTORE, INC., WAVERLY, IA:
1,671,576. REN. 12-19-01. INT. CL. 5.
- AGRI-MARKETING CORPORATION, MINNEAPOLIS, MN:
1,142,834, CANC. INT. CL. 35.
- AGROHANSA, INC., HOUSTON, TX:
2,534,186, PUB. 11-6-2001. INT. CL. 30.
- AHA! SOFTWARE CORPORATION, MOUNTAIN VIEW, CA:
1,866,263, CANC. INT. CL. 9.
- AIR PRODUCTS AND CHEMICALS, INC., TREXLER-
TOWN, PA:
707,986, CANC. U.S. CL. 13.
- AIR SYSTEM COMPONENTS LP, RICHARDSON, TX, HART
& COOLEY, INC., HOLLAND, MI:
1,609,686. REN. 12-20-01. INT. CL. 11.
- AIR-LEC INDUSTRIES, INC., MADISON, WI:
1,142,442, CANC. INT. CL. 12.
- AIRFLOW SYSTEMS, INC., DALLAS, TX:
2,534,707, INT. CL. 11.
- AIRSEPT, INC., MARIETTA, GA:
2,535,129, INT. CL. 6.
- AIRWORKS CORPORATION, NASSAU, BAHAMAS:
1,625,772, CANC. INT. CL. 9.
1,625,773, CANC. INT. CL. 9.
- AJINOMOTO KABUSHIKI KAISHA, CHUO-KU, TOKYO
104, JAPAN, DBA AJINOMOTO CO., INC.:
925,599. REN. 12-17-01. U.S. CL. 46 (INT. CL. 30).
- AKKADIX CORPORATION, LA JOLLA, CA:
2,533,820, PUB. 6-5-2001. INT. CL. 42.
- ALAKH SPORTSWEAR, INC., NEW YORK, NY:
1,866,423, CANC. INT. CL. 25.
- ALAMO RENT-A-CAR, INC., FORT LAUDERDALE, FL:
1,866,571, CANC. INT. CL. 39.
- ALASKA PRIDE BAKERY COMPANY LLC, ANCHORAGE,
AK:
2,533,401, PUB. 11-6-2001. INT. CL. 30.
- ALBANY GENERAL HOSPITAL & HEALTH SERVICES
FOUNDATION, ALBANY, OR:
1,866,579, CANC. INT. CL. 41.
- ALBANY PROFESSIONAL BASEBALL CLUB, INC., AL-
BANY, GA:
1,866,037, CANC. INT. CL. 41.
- ALBERTI, 21047 SARONNO (VA), ITALY:
2,533,326, PUB. 11-6-2001. INT. CL. 7.
- ALBERTO-CULVER COMPANY, MELROSE PARK, IL, AL-
BERTO-CULVER COMPANY, MELROSE PARK, IL:
723,187. REN. 12-21-01. U.S. CL. 51 (INT. CL. 3).
- ALBERTSON'S, INC., BOISE, ID:
1,866,085, CANC. INT. CL. 42.
- ALBERTSON'S, INC.:
See— TOPCO ASSOCIATES, INC..
- ALCANCIA B.V., 1187 JM AMSTELVEEN, NETHERLANDS:
2,373,263, COR. INT. CL. 41.
- ALCO INDUSTRIES, INC., VALLEY FORGE, PA, SCHROE-
DER BROTHERS CORPORATION, MCKEES ROCKS, PA:
921,089. REN. 12-16-01. U.S. CL. 26 (INT. CL. 9).
- ALCOA INC., PITTSBURGH, PA:
2,534,761, INT. CL. 19.
2,534,983, INT. CL. 19.
- ALEXANDER, EUGENE D., WASHINGTON, DC:
1,865,879, CANC. INT. CL. 28.
- ALEXANDRE OF ENGLAND, INC., NORFOLK, VA:
1,866,425, CANC. INT. CL. 25.
- ALEXANDROV, STEFAN, KIRIL, CAMBRIDGE, MA:
2,533,813, PUB. 11-6-2001. INT. CL. 16.
- ALFA METALCRAFT CORPORATION, STAMFORD, CT:
2,535,057, MULTIPLE CLASS, INT. CLS. 21, 35 AND 41.
- ALKO LTD., SF-00180 HELSINKI, FINLAND:
1,866,539, CANC. INT. CL. 33.
- ALL SYSTEMS REAL ESTATE, INC., HUTCHINSON, MN:
1,142,839, CANC. INT. CL. 35.
- ALLEGHENY POWER SERVICE CORPORATION, GREENS-
BURG, PA, AKA APSC:
1,865,996, CANC. INT. CL. 39.
- ALLEGRO NEW MEDIA, INC., FAIRFIELD, NJ:
1,865,599, CANC. INT. CL. 9.
- ALLEN TELECOM GROUP, INC., SOLON, OH:
1,625,807, CANC. INT. CL. 9.
- ALGOODE NATURAL FOOD & BEVERAGES, INC., CAR-
PINTERIA, CA:
2,534,159, PUB. 11-6-2001. INT. CL. 30.
- ALLIANCE CAPITAL MANAGEMENT L.P., NEW YORK,
NY:
2,533,364, PUB. 11-6-2001. INT. CL. 36.
- ALLIANCE HEALTH SYSTEMS, INC., INDIANAPOLIS, IN:
1,626,275, CANC. INT. CL. 36.
- ALLIED MARKETING, INC., VERNON HILLS, IL:
2,533,719, PUB. 5-15-2001. INT. CL. 30.
- ALLIED PERCIVAL INTERNATIONAL, LTD., FORT
WORTH, TX TO ALLIED PERCIVAL INTERNATIONAL,
LTD., FORT WORTH, TX:
2,480,901, COR. MULTIPLE CLASS, INT. CLS. 35, 38
AND 42.
- ALPHACOS SA, C.P. 5, 2822 COURROUX, SWITZERLAND:
2,533,800, PUB. 11-6-2001. MULTIPLE CLASS, INT. CLS. 7
AND 42.
- ALTA-DENA CERTIFIED DAIRY, INC., CITY OF INDUS-
TRY, CA:
1,866,519, CANC. INT. CL. 30.
1,866,520, CANC. INT. CL. 30.
- ALTERS, DENNIS B., ENCINITAS, CA:
2,534,833, INT. CL. 28.
- ALTMAN DEVELOPMENT CORPORATION, BOCA RA-
TON, FL:
1,626,272, CANC. INT. CL. 36.
- ALTMAN GENERAL MERCHANDISE INC., NEW YORK,
NY, DBA ALTMAN LUGGAGE CO.:
1,866,376, CANC. INT. CL. 18.
- ALTRIO COMMUNICATIONS, INC., GLENDALE, CA:
2,533,914, PUB. 11-6-2001. INT. CL. 38.
2,533,915, PUB. 11-6-2001. INT. CL. 38.
- AMELIA ISLAND COMPANY, CLEVELAND, OH:
2,534,172, PUB. 11-6-2001. MULTIPLE CLASS, INT. CLS.
41 AND 42.
- AMERIC CORPORATION, ARLINGTON HEIGHTS, IL:
1,866,202, CANC. INT. CL. 7.
- AMERICAN APPAREL, LLC, LOS ANGELES, CA:
2,534,188, PUB. 11-6-2001. INT. CL. 25.
2,534,189, PUB. 11-6-2001. INT. CL. 25.
2,534,190, PUB. 11-6-2001. INT. CL. 25.
- AMERICAN ASSOCIATION FOR THE ADVANCEMENT OF
SCIENCE, WASHINGTON, DC:
1,661,663. REN. 12-19-01. MULTIPLE CLASS, INT. CLS.
16 AND 41.
- AMERICAN AXLE & MANUFACTURING, INC., DETROIT,
MI:
2,534,383, INT. CL. 12.

AMERICAN BANDS ABROAD, INC., WEST LAFAYETTE, IN:
1,665,259. REN. 12-15-01. INT. CL. 39.

AMERICAN BEVERAGE CORPORATION, VERONA, PA, SUNBURST FRUIT JUICES, INC., SALEM, MA:
1,662,688. REN. 12-17-01. INT. CL. 32.

AMERICAN BIO MEDICA, KINDERHOOK, NY:
2,535,111. INT. CL. 5.

AMERICAN COLLEGE OF FORENSIC EXAMINERS, INC., SPRINGFIELD, MO:
2,535,135. INT. CL. 41.

AMERICAN CRYSTAL SUGAR COMPANY, MOORHEAD, MN:
1,865,902. CANC. INT. CL. 30.

AMERICAN HEART ASSOCIATION, INC., DALLAS, TX:
1,660,153. REN. 12-20-01. INT. CL. 41.

AMERICAN HOME PRODUCTS CORPORATION, MADISON, NJ:
2,535,053. INT. CL. 5.

AMERICAN INSTITUTE OF PHYSICS, MELVILLE, NY, AMERICAN CHEMICAL SOCIETY, WASHINGTON, DC:
1,157,254. REN. 12-20-01. INT. CL. 16.

AMERICAN INTERNATIONAL GROUP, INC., NEW YORK, NY:
1,172,557. REN. 12-20-01. INT. CL. 36.

AMERICAN LIGHTING ASSOCIATION, DALLAS, TX:
1,626,399. CANC. INT. CL. 42.

AMERICAN MAIZE-PRODUCTS COMPANY, STAMFORD, CT:
1,142,163. CANC. MULTIPLE CLASS, INT. CLS. 1 AND 30.

AMERICAN MANAGEMENT SYSTEMS, INC., ARLINGTON, VA:
1,866,219. CANC. INT. CL. 9.

AMERICAN MONEY TRANSFER, INC., LOS ANGELES, CA:
2,535,006. INT. CL. 36.

AMERICAN NATIONAL CAN COMPANY, CHICAGO, IL:
1,865,563. CANC. MULTIPLE CLASS, INT. CLS. 6 AND 20.

AMERICAN NUCLEAR SOCIETY INCORPORATED, LA GRANGE PARK, IL:
2,534,589. INT. CL. 16.

AMERICAN ORT, INC., NEW YORK, NY:
2,533,494. PUB. 11-6-2001. MULTIPLE CLASS, INT. CLS. 14, 16, 25, 36 AND 41.

AMERICAN RETIREMENT PLANNERS, RENO, NV:
2,534,320. PUB. 11-6-2001. INT. CL. 36.

AMERICAN STANDARD INC., PISCATAWAY, NJ:
917,041. REN. 12-20-01. U.S. CL. 13 (INT. CL. 11).
919,681. REN. 12-20-01. U.S. CL. 13 (INT. CL. 11).
1,157,941. REN. 12-19-01. INT. CL. 11.

AMERICAN STERILIZER COMPANY, ERIE, PA:
1,142,383. CANC. MULTIPLE CLASS, INT. CLS. 10 AND 16.

AMERICAN STERILIZER COMPANY, MENTOR, OH:
2,533,204. PUB. 11-6-2001. MULTIPLE CLASS, INT. CLS. 10 AND 11.

AMERICAN STORES COMPANY, SALT LAKE CITY, UT:
1,142,751. CANC. INT. CL. 29.

AMERICAN STUDENT TRAVEL, INC., HOUSTON, TX:
1,626,329. CANC. INT. CL. 39.

AMERICAN TRADING AND PRODUCTION CORPORATION, BALTIMORE, MD:
1,625,949. CANC. INT. CL. 16.

AMERICAN WAREHOUSE ASSOCIATION, PARK RIDGE, IL:
1,865,767. CANC. INT. CL. 16.

AMERICARES FOUNDATION, INC., NEW CANAAN, CT:
2,533,777. PUB. 11-6-2001. INT. CL. 42.

AMERIDEN INTERNATIONAL, LLC, FALLBROOK, CA:
2,534,205. PUB. 11-6-2001. INT. CL. 5.

AMERISOUTH MORTGAGE COMPANY, CHARLOTTE, NC, BEST MORTGAGE COMPANY, CHARLOTTE, NC:
1,718,742. REN. 12-21-01. INT. CL. 36.

AMERISPORT, L.L.C., NEW YORK, NY:
2,534,417. INT. CL. 25.

AMERISTAR FUELS CORPORATION, HOUSTON, TX:
1,865,984. CANC. INT. CL. 37.

AMERSHAM INTERNATIONAL PLC, BUCKINGHAMSHIRE, ENGLAND:
1,625,490. CANC. INT. CL. 1.

AMFAC, INC., FOLSOM, HI:
1,142,952. CANC. INT. CL. 42.

AMICO, JOHN F., BRIDGEVIEW, IL:
1,143,001. CANC. INT. CL. 42.

AMIGO MOBILITY INTERNATIONAL, INC., BRIDGEPORT, MI:
1,660,534. REN. 12-21-01. MULTIPLE CLASS, INT. CLS. 7, 12 AND 37.

AMOS, MATTHEW P., HARRISBURG, PA:
2,533,855. PUB. 11-6-2001. INT. CL. 36.

AMREP, INC., MARIETTA, GA:
2,533,775. PUB. 11-6-2001. INT. CL. 1.

AMRION, INC., BOULDER, CO:
1,895,837. CANC. INT. CL. 5.

AMSCAN INC., HARRISON, NY:
1,866,478. CANC. INT. CL. 26.
1,866,600. CANC. INT. CL. 42.

AMYX, SCOTT S., CASTRO VALLEY, CA, DBA L'AMYX TEA BAR:
2,534,957. INT. CL. 30.

ANABOLIC VIDEO PRODUCTIONS, INC., VENICE, CA:
2,533,907. PUB. 11-6-2001. INT. CL. 9.

ANCHOR COIN, LAS VEGAS, NV:
2,533,253. PUB. 3-27-2001. INT. CL. 9.

ANCHOR GAMING, LAS VEGAS, NV:
2,534,686. INT. CL. 9.

ANCHOR HOCKING CORPORATION, FREEPORT, IL:
1,866,397. CANC. INT. CL. 21.

ANCO COLLECTOR SUPPLIES, INC., FLORENCE, AL:
1,866,359. CANC. INT. CL. 16.

ANDELMAN, BOYAJIAN & CO., INC., FOUNTAIN VALLEY, CA:
1,866,547. CANC. INT. CL. 35.

ANDERSON COMPANY OF INDIANA, THE, GARY, IN:
1,142,555. CANC. INT. CL. 17.

ANDERSON KILL OLICK & OSHINSKY, P.C., NEW YORK, NY:
1,866,622. CANC. INT. CL. 16.

ANDERSON, GREG, EDGEWOOD, MD:
2,534,975. INT. CL. 42.

ANDERSON, THOMAS M., BIRMINGHAM, MI:
2,534,670. INT. CL. 25.

ANDERSONS AGRISERVICES, INC., THE, CHAMPAIGN, IL:
2,533,866. PUB. 11-6-2001. INT. CL. 1.

ANECOOP S. COOP., E-46010 VALENCIA, SPAIN:
2,533,452. PUB. 11-6-2001. INT. CL. 31.

ANGELA ENTERPRISES INC, GILFORD, NH, BEVERLY HILLS WEIGHT LOSS CLINICS INTERNATIONAL, INC., WINCHESTER, VA:
1,640,846. REN. 12-20-01. INT. CL. 42.

ANGELI, DARLENE B., FOSTER CITY, CA:
2,534,040. PUB. 11-6-2001. INT. CL. 5.

ANIMAL SUPPLY COMPANY, AUBURN, WA:
1,866,528. CANC. INT. CL. 31.

ANNABELLE CANDY CO., INC., HAYWARD, CA:
1,201,329. REN. 12-15-01. INT. CL. 30.

ANORAD CORPORATION, HAUPPAUGE, NY:
1,658,811. REN. 12-19-01. INT. CL. 7.

ANSWER ONE, INC., CLEARWATER, FL:
1,865,943. CANC. INT. CL. 35.

ANSWER PAGE, INC. THE, SHARON, MA:
2,535,107. INT. CL. 41.

ANTIVIRALS INC., PORTLAND, OR:
2,534,408. MULTIPLE CLASS, INT. CLS. 1 AND 5.

ANTON PAAR U.S.A., INC., ASHLAND, VA:
1,865,661. CANC. INT. CL. 9.

ANTONIO GARCIA INESTA, S.L., 03660 NOVELDA (ALICANTE), SPAIN:
1,661,858. REN. 12-18-01. INT. CL. 30.

APOGEE INTERNATIONAL, INC., HILLSBORO, OR:
1,865,852. CANC. INT. CL. 25.

- APOTHECARY PRODUCTS, INC., BURNSVILLE, MN:
2,534,071, PUB. 11-6-2001. INT. CL. 20.
- APPLICATION ENGINEERING CORPORATION, ELK GROVE VILLAGE, IL:
1,142,356, CANC. INT. CL. 9.
- APPLIED COATINGS, INC., ROCHESTER, NY, BAUSCH & LOMB INCORPORATED, ROCHESTER, NY:
1,660,295, REN. 12-19-01. INT. CL. 9.
- APPLIED DATA SCIENCES, INC., CARROLLTON, TX:
1,678,150, REN. 12-21-01. INT. CL. 9.
1,700,310, REN. 12-21-01. INT. CL. 9.
- APPLIED INDUSTRIAL HYGIENE, INC., CINCINNATI, OH:
2,533,992, PUB. 11-6-2001. INT. CL. 41.
- APPLIED RESEARCH ASSOCIATES, INC., BURTONSVILLE, MD, DBA ARA HUMAN FACTORS:
1,866,058, CANC. INT. CL. 42.
- APPRISS, INC., LOUISVILLE, KY:
2,533,888, PUB. 11-6-2001. INT. CL. 38.
2,533,889, PUB. 11-6-2001. INT. CL. 38.
- AQUA CLEAR INDUSTRIES, LLC, WATERVLIET, NY:
2,533,638, PUB. 11-6-2001. INT. CL. 1.
- AQUASCUTUM, LIMITED, LONDON, W., ENGLAND:
1,184,764, REN. 12-18-01. INT. CL. 18.
- ARA SERVICES, INC., PHILADELPHIA, PA:
1,142,553, CANC. INT. CL. 16.
- ARAMIS INC., NEW YORK, NY:
1,866,584, CANC. INT. CL. 42.
2,534,776, INT. CL. 3.
2,534,874, INT. CL. 3.
- ARCHDIOCESE OF DETROIT, DETROIT, MI:
2,534,240, PUB. 11-6-2001. INT. CL. 36.
- ARCHER DANIELS MIDLAND, DECATUR, IL, HENKEL CORPORATION, MINNEAPOLIS, MN:
1,172,748, REN. 12-16-01. INT. CL. 1.
- ARG ENTERPRISES, INC., LOS ALTOS, CA, SAGA ENTERPRISES, INC., MENLO PARK, CA:
1,173,706, REN. 12-16-01. INT. CL. 42.
- ARISTOCRAT LEISURE INDUSTRIES PTY LTD:
See— ARISTOCRAT TECHNOLOGIES AUSTRALIA PTY. LIMITED.
- ARISTOCRAT TECHNOLOGIES AUSTRALIA PTY. LIMITED, NEW SOUTH WALES, AUSTRALIA FROM ARISTOCRAT LEISURE INDUSTRIES PTY LTD, NEW SOUTH WALES 2066, AUSTRALIA:
2,533,447, PUB. 11-6-2001. INT. CL. 9.
- ARIZONA CHEMICAL COMPANY, JACKSONVILLE, FL:
546,338, REN. 12-20-01. U.S. CL. 1 (INT. CL. 1).
- ARMAMENT SYSTEMS AND PROCEDURES, INC., APPLETON, WI:
2,534,782, INT. CL. 11.
- ARMOR BOX COMPANY, BLOOMFIELD, CT:
2,534,093, PUB. 11-6-2001. INT. CL. 20.
- ARMOUR, TYRONE, LOOKOUT MOUNTAIN, TN:
2,533,321, PUB. 11-6-2001. INT. CL. 25.
- ARMSTRONG COUNTY MEMORIAL HOSPITAL, KITTANNING, PA:
1,866,084, CANC. INT. CL. 42.
- ARMY OF DARKNESS, INC., LOS ANGELES, CA FROM ARMY OF DARKNESS, LOS ANGELES, CA:
2,534,458, INT. CL. 14.
- ARNETT, GLENN E., JR., HOUSTON, TX:
1,865,517, CANC. INT. CL. 3.
- ARRINGTON'S BED & BREAKFAST JOURNAL, L.P., MIDLAND, TX:
2,534,926, INT. CL. 16.
- ARTEK, INC., FRANCETOWN, NH:
1,142,579, CANC. INT. CL. 20.
- ARTHROCARE CORPORATION, SUNNYVALE, CA:
2,534,981, INT. CL. 10.
- ARTHUR W. PAGE SOCIETY, INC., THE, CHICAGO, IL:
1,866,043, CANC. INT. CL. 42.
- ARTISTS RIGHTS FOUNDATION, LOS ANGELES, CA:
2,533,366, PUB. 11-6-2001. INT. CL. 41.
- ARTZAPPER, LLC, KANSAS CITY, MO:
2,533,768, PUB. 11-6-2001. INT. CL. 35.
- ARVIDA/JMB PARTNERS, BOCA RATON, FL:
2,533,373, PUB. 11-6-2001. INT. CL. 42.
- AS SPILKA INTERNATIONAL LTD., N-6013 ALESUND, NORWAY:
1,661,741, REN. 12-16-01. INT. CL. 19.
- ASAMERA OIL (U.S.) INC., DENVER, CO:
1,142,885, CANC. INT. CL. 37.
- ASARI PLASTIC CORPORATION, BALDWIN PARK, CA:
1,866,629, CANC. INT. CL. 16.
- ASHLAND OIL, INC., RUSSELL, KY:
1,866,006, CANC. INT. CL. 40.
- ASHLAND, INC., COVINGTON, KY:
2,534,930, INT. CL. 20.
- ASIA CHEMICAL CORPORATION, TAIPEI, TAIWAN:
2,534,505, MULTIPLE CLASS, INT. CLS. 9, 16 AND 17.
- ASIAN & WESTERN CLASSICS B.V., 1101 BE AMSTERDAM, NETHERLANDS:
1,626,052, CANC. INT. CL. 25.
- ASKART.COM, INC., SAN FRANCISCO, CA FROM COLLINS, GEORGE, SAN FRANCISCO, CA:
2,534,812, INT. CL. 35.
- ASPEN MARKETING, INC., LOS ANGELES, CA FROM SUDDEN IMPACT, INC., NEW YORK, NY:
2,534,519, INT. CL. 35.
- ASSOCIATED WHOLESALE GROCERS, INC., KANSAS CITY, KS:
2,534,701, MULTIPLE CLASS, INT. CLS. 29 AND 30.
- ASSOCIATION FOR INVESTMENT MANAGEMENT AND RESEARCH, CHARLOTTESVILLE, VA, FINANCIAL ANALYSTS FEDERATION, THE, CHARLOTTESVILLE, VA:
921,970, REN. 12-15-01. U.S. CL. 38 (INT. CL. 16).
- ASSOCIATION OF BREWERS, INC., BOULDER, CO:
2,535,025, INT. CL. 35.
- ASTEC INDUSTRIES, INC., CHATTANOOGA, TN, KOLBERG MANUFACTURING CORPORATION, YANKTON, SD:
920,624, REN. 12-19-01. U.S. CL. 23 (INT. CL. 7).
- ASTENJOHNSON, INC., KANATA, ONTARIO, CANADA, JWI LTD., KANATA, ONTARIO, CANADA:
1,179,143, REN. 12-18-01. INT. CL. 17.
- ASTERJOHNSON, INC., KANATA, CANADA, JWI LTD., KANATA, ONTARIO, CANADA:
1,179,144, REN. 12-18-01. INT. CL. 17.
- ASTHMA & ALLERGY FOUNDATION OF AMERICA, WASHINGTON, DC:
1,865,754, CANC. MULTIPLE CLASS, INT. CLS. 16, 36, 41 AND 42.
- ASTRAZENECA AB, SODERTALJE, SWEDEN, AKTIEBOLAGET ASTRA, S-151 85 SODERTALJE, SWEDEN:
1,665,404, REN. 12-20-01. INT. CL. 5.
- AT&T CORP., NEW YORK, NY:
2,534,481, INT. CL. 38.
- ATCO LTD., CALGARY, ALBERTA, CANADA:
1,172,277, REN. 12-20-01. INT. CL. 19.
- ATG ELECTRONIC, INC., MEMPHIS, TN:
1,865,640, CANC. INT. CL. 9.
- ATHLETICS INVESTMENT GROUP, LLC, OAKLAND, CA:
1,660,889, REN. 12-19-01. INT. CL. 25.
- ATLANTA HUNT MEETING AND STEEPLECHASE, INC., ATLANTA, GA:
1,165,869, REN. 12-17-01. INT. CL. 41.
- ATLANTA LEGAL COPIES, INC., ATLANTA, GA, DBA LEGAL COPIES INTERNATIONAL:
1,865,930, CANC. INT. CL. 35.
- ATLANTA-FULTON COUNTY ZOO, INC., ATLANTA, GA:
2,534,347, MULTIPLE CLASS, INT. CLS. 16, 25 AND 28.
- ATLANTIC FRESH, INC., BLAINE, ME:
1,865,916, CANC. INT. CL. 31.
- ATLANTIC RICHFIELD COMPANY, LOS ANGELES, CA:
1,625,489, CANC. INT. CL. 1.
1,866,607, CANC. INT. CL. 42.
- ATLAS PUTTY PRODUCTS CO., TINLEY PARK, IL:
389,022, REN. 12-18-01. U.S. CL. 16 (INT. CL. 19).
- ATLAS SUPPLY COMPANY, SPRINGFIELD, NJ:
1,142,450, CANC. INT. CL. 12.
- ATOFINA CHEMICALS, INC., PHILADELPHIA, PA, PENNSALT CHEMICALS CORPORATION, PHILADELPHIA, PA:
723,719, REN. 12-19-01. U.S. CL. 1 (INT. CL. 1).

- ATOTECH USA INC., STATE COLLEGE, PA, CHEMCUT CORPORATION, STATE COLLEGE, PA:
922,768. REN. 12-21-01. U.S. CL. 23 (INT. CL. 7).
- ATTITUDES, INC., GRAND JUNCTION, CO:
2,533,860, PUB. 11-6-2001. INT. CL. 20.
- AUDI A.G., INGOLSTADT, FED REP GERMANY:
2,534,302, PUB. 11-6-2001. INT. CL. 12.
- AUDIO NOTE UK LTD., EAST SUSSEX, ENGLAND:
2,535,016, INT. CL. 9.
- AUSTIN, BRIAN, UPPER MARLBORO, MD, DBA ATM ONE:
2,534,241, PUB. 11-6-2001. INT. CL. 36.
- AUSTRALIA AND NEW ZEALAND BANKING GROUP LIMITED, NEW YORK, NY:
1,625,910, CANC. INT. CL. 16.
- AUSTRALIAN MACADAMIA SOCIETY LIMITED, LISMORE, NEW SOUTH WALES, AUSTRALIA:
2,533,718, PUB. 11-6-2001. INT. CL. 29.
- AUTHENTIC FITNESS PRODUCTS INC., VAN NUYS, CA:
2,534,346, INT. CL. 25.
- AUTOMATED COMPLIANCE SYSTEMS, INC., BRIDGEWATER, NJ:
1,865,648, CANC. INT. CL. 9.
- AUTOMATED SOLUTIONS, INC., CHATTANOOGA, TN, DBA MILLENNIUM COMPUTER TECHNOLOGY:
2,533,191, PUB. 10-24-1995. INT. CL. 16.
- AUTOMATIC DATA PROCESSING, INC., CLIFTON, NJ:
1,142,323, CANC. INT. CL. 9.
- AUTOMOBILES CITROEN, 92200 NEUILLY SUR SEINE, FRANCE:
2,533,221, PUB. 11-6-2001. MULTIPLE CLASS, INT. CLS. 7 AND 12.
- AUTOVISIONS, INC., TROY, MI:
1,865,814, CANC. INT. CL. 20.
- AVALON BEVERAGE COMPANY, GLEN ALLEN, VA:
2,533,416, PUB. 11-6-2001. INT. CL. 32.
- AVALON HILL GAME COMPANY, THE, BALTIMORE, MD:
1,142,724, CANC. INT. CL. 28.
- AVALON PUBLISHING GROUP, INC., BERKELEY, CA:
2,534,293, PUB. 11-6-2001. MULTIPLE CLASS, INT. CLS. 16 AND 41.
- AVANTAGE GROUP, INC., THE, REDONDO BEACH, CA:
2,534,828, INT. CL. 16.
- AVENUE, INC., THE, WILMINGTON, DE:
2,534,538, INT. CL. 25.
- AXE DIGITAL TELEVISION, INC., VENICE, CA, DBA FILMSPEED:
2,533,754, PUB. 11-6-2001. INT. CL. 41.
- AXIOM INDUSTRIES, INC., FRESNO, CA:
1,625,847, CANC. INT. CL. 10.
- AYRES, BRONTE FRANCIS, SOUTH AUSTRALIA 5065, AUSTRALIA AND AYRES, MANDY BLANCHE, SOUTH AUSTRALIA 5065, AUSTRALIA:
2,534,631, INT. CL. 33.
- AZIENDA VINICOLA MICHELE MASTROBERARDINO S.R.L., 83042 ATRIPALDA (AV), ITALY, AZIENDA VINICOLA MICHELE MASTROBERARDINO S.N.C., 83042 ATRIPALDA (AV), ITALY:
1,661,893. REN. 12-15-01. INT. CL. 33.
- AZIENDA VINICOLA MICHELE MASTROBERARDINO S.R.L., 83042 ATRIPALDA (AV), ITALY, AZIENDA VINICOLA MICHELE MASTROBERARDINO S.N.C., 83042 ATRIPALDA (AV), ITALY:
1,660,013. REN. 12-15-01. INT. CL. 33.
- AZIMUTH MEMORY PRODUCTS INC., PHOENIX, AZ:
1,865,595, CANC. INT. CL. 9.
- AZUMA FOODS INTERNATIONAL, INC. U.S.A., HAYWARD, CA:
2,533,723, PUB. 11-6-2001. INT. CL. 29.
- B. A. BALLOU & CO., INC., EAST PROVIDENCE, RI:
1,684,392. REN. 12-17-01. INT. CL. 14.
- B. G. INDUSTRIES INC, NORTHBRIDGE, CA:
1,172,295. REN. 12-20-01. INT. CL. 20.
- B. SPRENGEL & CO., HANNOVER, FED REP GERMANY:
1,142,763, CANC. INT. CL. 30.
- B.E.L-TRONICS LIMITED, MISSISSAUGA, ONTARIO, CANADA:
1,866,250, CANC. INT. CL. 9.
- B.F.GOODRICH COMPANY, THE, BRECKSVILLE, OH:
2,533,691, PUB. 11-6-2001. INT. CL. 1.
- B.W. HARRIS MANUFACTURING COMPANY, ST. PAUL, MN:
1,865,845, CANC. INT. CL. 25.
- B.Y.O.B. CLOTHING COMPANY, PLAINFIELD, IN:
1,866,444, CANC. INT. CL. 25.
- B&L CONSULTANTS, INC., NORWOOD, MA, DBA NPC FREIGHT SERVICES:
1,865,632, CANC. INT. CL. 9.
- BABY EINSTEIN COMPANY, LLC, THE, LITTLETON, CO:
2,533,408, PUB. 11-6-2001. INT. CL. 9.
- BABY OTTER SWIM SCHOOL, INC., COOPER CITY, FL:
2,533,938, PUB. 11-6-2001. INT. CL. 41.
- BACKFLIPS, INC., NEW YORK, NY:
1,704,272. REN. 12-17-01. INT. CL. 25.
- BACOU USA SAFETY, INC., SMITHFIELD, RI:
2,534,578, INT. CL. 9.
- BAGDON, MARK D., RIO RANCHO, NM:
2,534,747, INT. CL. 21.
- BAIK, SUNG HAK, BUCHEON CITY, KYUNGGT-DO, REPUBLIC OF KOREA:
1,176,320. REN. 12-17-01. INT. CL. 25.
- BAJA MARINE CORPORATION, BUCYRUS, OH:
2,535,055, INT. CL. 12.
- BAKER DISTRIBUTING CO., JACKSONVILLE, FL:
2,534,989, INT. CL. 35.
- BAKER HUGHES INCORPORATED, HOUSTON, TX, TRI-STATE OIL TOOL INDUSTRIES, INC., BOSSIER CITY, LA:
1,169,909. REN. 12-21-01. INT. CL. 7.
- BALCHEM CORPORATION, SLATE HILL, NY:
2,533,588, PUB. 11-6-2001. INT. CL. 5.
2,533,613, PUB. 11-6-2001. INT. CL. 1.
- BALDWIN GRAPHIC SYSTEMS INC., SHELTON, CT, BALDWIN-GEGENHEIMER CORPORATION, STAMFORD, CT:
916,719. REN. 12-18-01. U.S. CL. 26 (INT. CLS. 1, 9 AND 10).
- BALDWIN RICHARDSON FOODS CO., MATTESON, IL, RICHARDSON FOODS CORPORATION, MACEDON, NY:
1,668,695. REN. 12-18-01. INT. CL. 30.
- BALL, DON, BEND, OR:
2,534,834, INT. CL. 16.
- BALLY TOTAL FITNESS HOLDING CORPORATION, CHICAGO, IL:
2,533,193, PUB. 11-6-2001. INT. CL. 5.
- BALTEFF, GREGORY, WESTLAND, MI:
1,866,016, CANC. INT. CL. 41.
- BALTIMORE COMMITTEE FOR INTERNATIONAL WRESTLING, INC., COCKEYSVILLE, MD:
2,533,590, PUB. 11-6-2001. INT. CL. 41.
- BAMA COMPANIES, INC., THE, TULSA, OK:
2,533,972, PUB. 11-6-2001. MULTIPLE CLASS, INT. CLS. 30 AND 35.
2,533,991, PUB. 11-6-2001. MULTIPLE CLASS, INT. CLS. 30, 35 AND 41.
- BAMBU SALES, INC., WESTBURY, NY:
1,667,803. REN. 12-16-01. INT. CL. 34.
- BANANA REPUBLIC (APPAREL) INC., SAN BRUNO, CA:
2,534,585, INT. CL. 35.
- BANDWIDTH9, INC., FREMONT, CA:
2,534,555, INT. CL. 9.
- BANK OF NOVA SCOTIA, THE, TORONTO, ONTARIO, CANADA:
2,534,352, MULTIPLE CLASS, INT. CLS. 35 AND 36.
- BANSAL, ASHOK, SANTA CLARA, CA:
2,533,669, PUB. 11-6-2001. INT. CL. 41.
- BANTERRA CORP., ELDORADO, IL:
2,533,740, PUB. 11-6-2001. INT. CL. 36.
- BANYAN, SHARAAM STEVE, LA JOLLA, CA:
1,626,200, CANC. INT. CL. 32.
- BAP SOFTWARE INC., FRESNO, CA:
1,663,285. REN. 12-19-01. INT. CL. 9.
- BARAZZOTTO, ZOT, XENIA, OH, DBA TETON TECHNOLOGY:
2,534,405, INT. CL. 9.

- BARBARA CREATIONS, INC., SKOKIE, IL:
2,534,722, INT. CL. 9.
- BARNES INTERNATIONAL, INC., ROCKFORD, IL:
1,676,569, REN. 12-20-01. INT. CL. 7.
- BARON-BLAKESLEE, INC., LAKEWOOD, CA:
1,142,581, CANC. INT. CL. 20.
- BAROODY, MICHAEL ELIAS, MCLEAN, VA:
2,534,960, INT. CL. 42.
- BARR LABORATORIES, INC., POMONA, NY:
2,534,124, PUB. 11-6-2001. INT. CL. 5.
- BASCOM CORPORATION, PATTERSON, NJ:
2,533,202, PUB. 11-6-2001. MULTIPLE CLASS, INT. CLS.
29 AND 30.
- BASE-X, INCORPORATED, STERLING, VA:
2,534,311, PUB. 11-6-2001. INT. CL. 40.
- BASEBALL ACQUISITION CORPORATION, PORTLAND,
OR FROM IHLENBURG, FREDERICK H., PORTLAND,
OR:
2,534,613, MULTIPLE CLASS, INT. CLS. 18, 21, 25 AND
28.
- BASKET OF BOWS, INC., ST. LOUIS, MO:
1,865,867, CANC. INT. CL. 26.
- BASS - A - HOLIC, INC., EAST MOLINE, IL:
1,626,098, CANC. INT. CL. 28.
- BASS PRO TRADEMARKS, L.L.C., SPRINGFIELD, MO,
BASS PRO SHOPS, INC., SPRINGFIELD, MO:
1,693,238, REN. 12-19-01. INT. CL. 28.
- BASS PUBLIC LIMITED COMPANY, DE14 2WB, ENGLAND:
2,533,717, PUB. 11-6-2001. INT. CL. 42.
- BATES; WILLIAM C., FT. DEPOSIT, AL, DBA BATES
TURKEY FARM:
1,142,734, CANC. INT. CL. 29.
- BATLAS, THEODORE J., FREEHOLD, NJ:
1,865,593, CANC. INT. CL. 9.
- BAXTER INTERNATIONAL INC., DEERFIELD, IL:
1,866,307, CANC. INT. CL. 10.
2,533,450, PUB. 11-6-2001. INT. CL. 10.
- BAYER AKTIENGESELLSCHAFT, LEVERKUSEN, FED
REP GERMANY:
1,173,777, REN. 12-20-01. INT. CL. 1.
- BAYER CORPORATION, ELKHART, IN:
2,534,689, INT. CL. 21.
- BAYLON MANUFACTURING COMPANY, BROOKLYN,
NY:
1,865,853, CANC. INT. CL. 25.
- BAZELL OIL CO., INC., LOGAN, OH:
1,670,016, REN. 12-20-01. INT. CL. 4.
- BC INTERNATIONAL COSMETIC & IMAGE SERVICES,
INC., WILMINGTON, DE:
1,865,524, CANC. INT. CL. 3.
- BE WISE RANCH, SAN DIEGO, CA:
2,533,840, PUB. 11-6-2001. INT. CL. 31.
- BEAD-UP, INC., TULARE, CA:
1,142,233, CANC. INT. CL. 7.
- BEAR ROCK JUNCTION, INC., NEW TRIPOLI, PA:
2,534,102, PUB. 11-6-2001. INT. CL. 41.
- BEARD/PARKER MUSIC PRODUCTIONS, LAUREL, MD:
2,182,613, CANC. INT. CL. 25.
- BEATRICE VON TRESCOW DESIGNS LTD., CHELTEN-
HAM GLOS, UNITED KINGDOM:
2,533,729, PUB. 11-6-2001. MULTIPLE CLASS, INT. CLS.
18 AND 25.
- BEAULIEU, THOMAS J, TORRINGTON, WY:
2,533,874, PUB. 11-6-2001. U.S. CL. 200.
- BEBE GIRDLE CORP, BROOKLYN, NY, JUNIOR-
FORMLTD., NEW YORK, NY:
1,171,372, REN. 12-17-01. INT. CL. 25.
- BECKER-UNDERWOOD, INC., AMES, IA:
2,533,657, PUB. 11-6-2001. INT. CL. 2.
- BECKY LEADBETTER, SPENCER ST. CYR, STEVEN LEAD-
BETTER PARTNERSHIP, THE, EVERGREEN, CO:
1,865,850, CANC. INT. CL. 25.
- BECTON DICKINSON AND COMPANY, FRANKLIN
LAKES, NJ:
2,534,009, PUB. 11-6-2001. INT. CL. 42.
- BEELE ENGINEERING B.V., 7122 NZ AALTEN, NETHER-
LANDS:
2,533,817, PUB. 11-6-2001. MULTIPLE CLASS, INT. CLS.
6, 9, 17, 19 AND 42.
- BEI ELECTRONICS, INC., LITTLE ROCK, AR:
1,142,345, CANC. INT. CL. 9.
- BEIERSDORF AG, HANNOVER, FED REP GERMANY:
1,172,795, REN. 12-20-01. INT. CL. 3.
- BEIHANG TECHNOLOGY LIMITED, CAUSEWAY BAY,
HONG KONG:
2,534,468, INT. CL. 14.
- BEIJING GUI ZHI BAO ECONOMIC AND TRADE DEVEL-
OPMENT CO., LTD., BEIJING, CHINA:
2,533,769, PUB. 11-6-2001. INT. CL. 14.
- BELFER, GERALD A., BEDFORD HTS., OH AND DONO-
VAN, WILLIAM, CHICAGO, IL:
1,866,335, CANC. INT. CL. 14.
- BELLEZZA, ANTHONY P, PARKESBURG, PA AND BEL-
LEZZA, MARY L, PARKESBURG, PA:
2,533,400, PUB. 11-6-2001. MULTIPLE CLASS, INT. CLS.
5, 30 AND 31.
- BELZ INVESTCO GP, MEMPHIS, TN:
2,534,789, INT. CL. 16.
- BENDER, DONNA R., NEW YORK, NY:
1,866,426, CANC. INT. CL. 25.
- BENNINGTON MOTOR CAR, INC., BENNINGTON, VT:
2,534,108, PUB. 11-6-2001. INT. CL. 36.
- BERDICHEVSKY, RUAL, SANTA MONICA, CA:
2,533,793, PUB. 11-6-2001. MULTIPLE CLASS, INT. CLS. 5
AND 25.
- BERKELEY-CHARLESTON-DORCHESTER TECHNICAL
EDUCATION CENTER, CHARLESTON, SC, AKA TRI-
DENT TECHNICAL COLLEGE:
2,534,115, PUB. 11-6-2001. INT. CL. 41.
- BERKENHOFF GMBH, D-35452 HEUCHELHEIM, FED REP
GERMANY:
1,660,600, REN. 12-20-01. INT. CL. 9.
- BERKLEY, INC., SPIRIT LAKE, IA:
1,866,484, CANC. INT. CL. 28.
- BERN & KOPPSTEIN DIVISION OF IMPERIAL COMMOD-
ITIES CORPORATION, NEW YORK, NY:
708,156, CANC. U.S. CL. 46.
- BEROL CORPORATION, BRENTWOOD, TN:
1,866,131, CANC. MULTIPLE CLASS, INT. CLS. 12 AND
28.
1,866,336, CANC. INT. CL. 14.
1,866,355, CANC. INT. CL. 16.
- BERRYMAN PRODUCTS, INC., ARLINGTON, TX:
2,533,751, PUB. 11-6-2001. MULTIPLE CLASS, INT. CLS.
1, 16 AND 25.
- BERWIND CORPORATION, PHILADELPHIA, PA:
1,658,513, REN. 12-19-01. INT. CL. 36.
- BEST SOFTWARE, INC., RESTON, VA:
2,533,778, PUB. 11-6-2001. INT. CL. 42.
- BESTNET COMMUNICATIONS CORP., TUSCON, AZ
FROM WAVE TECH INTERNATIONAL, INC., TUCSON,
AZ:
2,535,035, INT. CL. 38.
- BETRAS PLASTICS, INC., SPARTANBURG, SC:
1,626,017, CANC. INT. CL. 21.
- BETSY KARP, L.L.C., WOODBURY, NY:
2,534,699, INT. CL. 25.
- BETTER PLACE RECORDS, INC., FORT LEE, NJ:
2,533,594, PUB. 11-6-2001. INT. CL. 41.
- BETTS TACKLE, LTD., FUQUAY-VARINA, NC:
1,170,410, REN. 12-19-01. INT. CL. 28.
- BEUTLER HEATING & AIR CONDITIONING, EL DORADO
HILLS, CA:
2,534,836, INT. CL. 35.
- BEYOND 9 DOTS, INC., BARRINGTON, IL, DBA B9D:
1,865,949, CANC. INT. CL. 35.
- BHANDARI, RAJINDER, IRVING, TX:
2,535,126, INT. CL. 25.
- BI-LO BRANDS, INC., WILMINGTON, DE, BI-LO, INC.,
MAULDIN, SC:
1,661,254, REN. 12-20-01. INT. CL. 42.
- BIBB COMPANY, THE, ATLANTA, GA:
2,534,395, MULTIPLE CLASS, INT. CLS. 20 AND 24.
- BIBLE STUDY TIME, INC., SPARTANBURG, SC:
2,534,213, PUB. 11-6-2001. INT. CL. 42.

BIG BEANS, INC., CONCORD, MA:
1,866,169, CANC. INT. CL. 3.

BIG BOB'S NEW & USED CARPET OF AMERICA, INC., SHAWNEE MISSION, KS:
2,534,062, PUB. 11-6-2001. INT. CL. 35.

BIG FUN A GO-GO, INC., DESITT, NY:
1,646,931. REN. 12-20-01. INT. CL. 28.

BILL HEARD ENTERPRISES, INC., COLUMBUS, GA:
2,533,318, PUB. 11-6-2001. INT. CL. 35.

BILLIARD CONGRESS OF AMERICA, INC., COLORADO SPRINGS, CO:
2,535,077, INT. CL. 42.
2,535,078, INT. CL. 41.

BILTRITE CORPORATION, THE, WALTHAM, MA, AMERICAN BILTRITE INC., CAMBRIDGE, MA:
1,188,755. REN. 12-20-01. INT. CL. 27.

BINDING SITE. LTD., THE, BIRMINGHAM, UNITED KINGDOM:
2,534,974, MULTIPLE CLASS, INT. CLS. 1 AND 5.

BINNEY & SMITH PROPERTIES, INC., EASTON, PA, BINNEY & SMITH INC., EASTON, PA:
1,173,166. REN. 12-21-01. INT. CL. 16.

BIO-LAB, INC., DECATUR, GA:
2,534,823, INT. CL. 1.

BIO-RAD LABORATORIES, INC., HERCULES, CA:
1,625,470, CANC. INT. CL. 1.

BIO/DATA CORPORATION, HATBORO, PA:
1,142,173, CANC. MULTIPLE CLASS, INT. CLS. 1, 9 AND 16.

BIOCHEM SYSTEMS, INC., WICHITA, KS:
2,534,779, INT. CL. 3.

BIOLAB SERVICES, INC., WILMINGTON, DE, BIO-LAB, INC., DECATUR, GA:
1,652,119. REN. 12-19-01. INT. CL. 5.

BIOLAB SERVICES, INC., WILMINGTON, DE, GROW GROUP, INC., NEW YORK, NY:
1,664,646. REN. 12-19-01. MULTIPLE CLASS, INT. CLS. 1, 8, 9, 17 AND 21.

BIOLOGIX SYSTEMS CORP., ST. LOUIS, MO:
2,533,806, PUB. 11-6-2001. INT. CL. 37.

BIOMERIEUX, INC., HAZELWOOD, MO:
2,533,515, PUB. 11-6-2001. INT. CL. 5.

BIOMET, INC., WARSAW, IN:
1,679,298. REN. 12-17-01. INT. CL. 10.

BIONDA-BRUNA, LLC, ATLANTA, GA:
2,533,807, PUB. 11-6-2001. INT. CL. 21.

BIOPOOL AB, S-907 04 UMEA, SWEDEN:
2,534,489, INT. CL. 10.

BIRD ELECTRONIC CORPORATION, SOLON, OH:
722,832. REN. 12-18-01. U.S. CL. 26 (INT. CL. 9).

BISHOP RINK HOLDINGS, LLC, RAPID CITY, KS FROM KANSAS ICE OPERATING CO., L.L.C., LENEXA, KS:
2,534,490, INT. CL. 41.

BIZJOURNALS.COM, INC., CHARLOTTE, NC:
2,533,692, PUB. 11-6-2001. INT. CL. 35.

BJS PARTNERS, ST. LOUIS, MO:
2,534,770, INT. CL. 16.

BLAIR CORPORATION, WARREN, PA, BLAIR CORPORATION, WARREN, PA:
1,656,300. REN. 12-18-01. INT. CL. 25.

BLAKE LABORATORIES CORPORATION, GREAT NECK, NY:
1,865,535, CANC. INT. CL. 5.

BLAKE, JEANNE, GLOUCESTER, MA:
2,534,996, MULTIPLE CLASS, INT. CLS. 9 AND 16.

BLAKNEY, DENISE, ARLINGTON, TX:
2,534,154, PUB. 11-6-2001. INT. CL. 42.

BLENHEIM HOLDINGS, INC., FORT LEE, NJ:
1,865,937, CANC. INT. CL. 35.

BLIMPIE INTERNATIONAL, INC., NEW YORK, NY:
2,534,443, MULTIPLE CLASS, INT. CLS. 29, 30 AND 42.

BLOCK DRUG COMPANY, INC., JERSEY CITY, NJ:
1,866,175, CANC. INT. CL. 3.

BLOCKBUSTER INC., DALLAS, TX:
2,533,241, PUB. 11-6-2001. INT. CL. 35.

BLOOMBERG L.P., NEW YORK, NY:
2,415,962, COR. INT. CL. 41.

BLOWFISH LLC, SAN FRANCISCO, CA:
2,534,343, PUB. 11-6-2001. INT. CL. 41.

BLUE GRANITE CORPORATION, GRANITE FALLS, WA, AKA BGC PET FOODS:
2,534,042, PUB. 11-6-2001. INT. CL. 31.

BLUE SEAL FEEDS, INC., MUSCATINE, IA, H. K. WEBSTER COMPANY, INC., LAWRENCE, MA:
1,172,500. REN. 12-17-01. INT. CL. 31.

BO'S PLACE, HOUSTON, TX:
2,534,116, PUB. 11-6-2001. INT. CL. 42.

BOB BONDURANT SCHOOL OF HIGH PERFORMANCE DRIVING, INC., THE, CHANDLER, AZ:
2,534,420, INT. CL. 41.

BOB TIMBERLAKE COLLECTION, INC., THE, LEXINGTON, NC:
2,534,363, MULTIPLE CLASS, INT. CLS. 14, 18 AND 25.

BOB'S SPACE RACERS, INC., DAYTONA BEACH, FL:
1,683,055. REN. 12-19-01. INT. CL. 28.

BOCK PHARMACAL COMPANY, ST. LOUIS, MO:
1,865,549, CANC. INT. CL. 5.

BODEGAS RAMON BILBAO, SA., 26200 HARO, LA RIOJA, SPAIN:
2,533,512, PUB. 11-6-2001. INT. CL. 33.

BODY MASTERS SPORTS INDUSTRIES, INC., RAYNE, LA:
2,533,756, PUB. 11-6-2001. MULTIPLE CLASS, INT. CLS. 28 AND 41.

BOEHRINGER MANNHEIM GMBH, D-68298 MANNHEIM, GERMAN DEM REP:
1,865,544, CANC. INT. CL. 5.

BOGGLE GOGGLE ENTERPRISES, LLC, CARLISLE, MA:
2,533,755, PUB. 11-6-2001. INT. CL. 41.

BOHANNON, GARY MICHAEL, SHASTA, CA:
2,534,942, INT. CL. 4.

BOI NA BRAZA, INC., GRAPEVINE, TX FROM MATHEUS BROTHERS, THE, ARLINGTON, TX:
2,534,608, INT. CL. 42.

BOLT TECHNOLOGY CORPORATION, NORWALK, CT:
1,626,401, CANC. INT. CL. 42.

BON WORTH, INC., HENDERSONVILLE, NC:
1,669,521. REN. 12-16-01. INT. CL. 25.

BONDED LIGHTNING PROTECTION SYSTEMS, LTD., ARGYLE, TX:
2,534,140, PUB. 11-6-2001. INT. CL. 37.

BONNEVILLE WORLDWIDE, INC., ANAHEIM, CA:
2,534,169, PUB. 11-6-2001. INT. CL. 18.

BONNIE & CLYDE, INC., OCEAN SPRINGS, MS:
1,142,995, CANC. INT. CL. 42.

BOOK SALES INC., EDISON, NJ:
1,154,854. REN. 12-19-01. INT. CL. 16.

BOOKS FOR KIDS FOUNDATION, THE, NEW YORK, NY:
2,533,913, PUB. 11-6-2001. INT. CL. 42.

BOOKSPAN, GARDEN CITY, NY:
2,535,123, INT. CL. 35.

BOONE, CARLA B., BROOKLYN, NY:
2,534,501, MULTIPLE CLASS, INT. CLS. 9, 25 AND 35.

BOOTH, CHARLES, NEW YORK, NY:
1,625,549, CANC. INT. CL. 3.

BORDEN, INC., COLUMBUS, OH:
2,534,577, INT. CL. 41.

BOS ASSOCIATES, INC., BREA, CA AND PROFILE DESIGN FOR BUSINESS COMMUNICATIONS, INC., SAN FRANCISCO, CA:
1,866,080, CANC. INT. CL. 42.

BOS SPORTS, INC., SAN MATEO, CA:
2,062,167, CANC. INT. CL. 28.

BOSS MANUFACTURING COMPANY, KEWANEE, IL, SLIMOVITZ, MORRIS L., NEWBERN, TN, DBA MORRIS MFG. CO.:
555,769. REN. 12-20-01. U.S. CL. 39 (INT. CL. 25).

BOSS MANUFACTURING COMPANY, KEWANEE, IL:
1,142,662, CANC. INT. CL. 25.

BOSTON BEER CORPORATION, BOSTON, MA, BOSTON BEER COMPANY LIMITED PARTNERSHIP, BOSTON, MA, DBA THE BOSTON BEER COMPANY:
1,639,234. REN. 12-16-01. INT. CL. 32.

BOSTON PROBES, INC., BEDFORD, MA:
2,533,877, PUB. 11-6-2001. INT. CL. 9.

- BOWE SYSTEC AG, 86159 AUGSBURG, FED REP GERMANY:
2,534,356, INT. CL. 7.
- BOWEN HILL, LTD., KOWLOON, HONG KONG:
2,480,722, COR. INT. CL. 9.
- BOXER LEARNING, INC., CHARLOTTESVILLE, VA:
2,534,693, INT. CL. 9.
2,534,694, INT. CL. 35.
- BOXSELL, SEAN MICHAEL, 4165, QUEENSLAND, AUSTRALIA:
1,865,798, CANC. INT. CL. 20.
- BOYD COFFEE COMPANY, PORTLAND, OR:
1,676,131, REN. 12-17-01, INT. CL. 39.
- BOYDS COLLECTION, LTD., THE, MCSHERRYSTOWN, PA:
2,534,832, INT. CL. 28.
- BOYER, CATHERINE L, SILVERTON, OR:
2,533,964, PUB. 11-6-2001, INT. CL. 31.
- BOYLES, RAY, MERRIAM, KS, DBA SHO-TYME MOTOR SPORTS:
2,534,853, INT. CL. 28.
- BOYS & GIRLS CLUBS OF AMERICA, ATLANTA, GA:
2,534,792, INT. CL. 41.
- BOYT LIMITED PARTNERSHIP, IOWA FALLS, IA:
1,865,788, CANC. INT. CL. 18.
- BRABENDER TECHNOLOGIE KG, D-47055 DUISBURG, FED REP GERMANY:
2,533,682, PUB. 11-6-2001, INT. CL. 9.
- BRADFORD EXCHANGE, LTD., THE, NILES, IL:
1,866,550, CANC. INT. CL. 36.
- BRADLEY MANUFACTURING COMPANY, CHICAGO, IL:
1,142,416, CANC. INT. CL. 11.
- BRADSHAW INTERNATIONAL, INC., RANCHO CUCA-MONGA, CA:
2,534,158, PUB. 11-6-2001, INT. CL. 21.
- BRADY MARKETING COMPANY, PACHECO, CA, DBA NATIONAL PARTS & ACCESSORY HEADQUARTERS:
1,866,092, CANC. INT. CL. 42.
- BRAETAN, INC., NEW YORK, NY:
1,626,081, CANC. INT. CL. 25.
- BRANCH OFFICE, INC., THE, ALEXANDRIA, IN:
2,534,643, INT. CL. 25.
- BRANDT, MICHAEL WAYNE, DALLAS, TX, DBA ECO-SAFE:
1,632,840, REN. 12-20-01, MULTIPLE CLASS, INT. CLS. 3 AND 37.
- BRANER USA, INC., SCHILLER PARK, IL, LOOPCO INDUSTRIES, INC., TWINSBURG, OH:
1,175,821, REN. 12-17-01, INT. CL. 7.
- BRAVO S. A. COFFEE ROASTERS, ATHENS, GREECE:
1,170,459, REN. 12-19-01, INT. CL. 30.
- BRAYWOOD LIMITED, GIBRALTAR:
2,534,173, PUB. 11-6-2001, INT. CL. 29.
- BREATHE-EASY, INC., TULSA, OK:
1,653,894, REN. 12-21-01, INT. CL. 37.
- BREEN & COMPANY, CLEVELAND, OH:
2,534,016, PUB. 11-6-2001, INT. CL. 36.
- BRENNAN, THOMAS, LAMBERTVILLE, NJ:
1,866,453, CANC. INT. CL. 25.
- BRETLIN, INC., CALHOUN, GA, CARRIAGE INDUSTRIES, INC., CALHOUN, GA:
1,667,701, REN. 12-17-01, INT. CL. 27.
- BREWSTER WALLCOVERING COMPANY, RANDOLPH, MA:
1,866,479, CANC. INT. CL. 27.
- BRI PRODUCTION S.A., 38610 GIERES, FRANCE:
1,865,832, CANC. INT. CL. 25.
- BRIGADE QUARTERMASTERS, LTD., KENNESAW, GA:
1,646,402, REN. 12-19-01, INT. CL. 42.
- BRIGHTHOUSE, LLC, ATLANTA, GA FROM GGT U.S.A./SOUTH, INC., ATLANTA, GA, DBA BRIGHTHOUSE:
2,534,413, INT. CL. 25.
- BRINSON PARTNERS, INC., CHICAGO, IL FROM UBS AG, SH-8001 ZURICH, SWITZERLAND:
2,533,236, PUB. 11-6-2001, MULTIPLE CLASS, INT. CLS. 14, 35, 36 AND 38.
- BRISTOL BAR & GRILLE, INC., LOUISVILLE, KY:
1,176,620, REN. 12-17-01, INT. CL. 42.
- BRITE VOICE SYSTEMS, INC., WICHITA, KS:
1,866,295, CANC. INT. CL. 9.
- BRITRAIL TRAVEL INTERNATIONAL INC., NEW YORK, NY:
1,626,330, CANC. INT. CL. 39.
- BRJG PUBLISHING CORPORATION, MINNEAPOLIS, MN:
1,866,625, CANC. INT. CL. 16.
- BROADMOORE LABS, INC., VENTURA, CA:
2,533,194, PUB. 11-6-2001, INT. CL. 5.
- BROKAT INFORMATIONSSYSTEME GMBH, BOBLINGEN, FED REP GERMANY:
2,534,399, INT. CL. 9.
- BROKER'S INTERNATIONAL, LTD., PANORA, IA:
2,534,636, U.S. CL. B.
- BROOKS, DONALD, NEW YORK, NY:
1,142,644, CANC. INT. CL. 25.
1,142,645, CANC. INT. CL. 25.
1,142,646, CANC. INT. CL. 25.
- BROWN & WILLIAMSON TOBACCO CORPORATION, LOUISVILLE, KY:
722,147, REN. 12-20-01, U.S. CL. 17 (INT. CL. 34).
2,533,893, PUB. 11-6-2001, INT. CL. 34.
- BROWN JORDAN COMPANY, EL MONTE, CA:
1,866,390, CANC. INT. CL. 20.
- BROWN, EARL C., ST. ALBANS, NY:
1,866,392, CANC. INT. CL. 21.
- BRUDER HEALTHCARE COMPANY, MARIETTA, GA:
1,865,699, CANC. INT. CL. 10.
- BRUMIT, KENNETH R., ALBUQUERQUE, NM, DBA QUIK QUARTER:
1,626,231, CANC. INT. CL. 35.
- BRUNSWICK BOWLING & BILLIARDS CORPORATION, MUSKEGON, MI:
2,533,602, PUB. 11-6-2001, MULTIPLE CLASS, INT. CLS. 2, 3, 9, 21 AND 28.
- BRUNSWICK CORPORATION, LAKE FOREST, IL:
2,533,784, PUB. 11-6-2001, INT. CL. 36.
2,533,897, PUB. 11-6-2001, INT. CL. 16.
- BRUNSWICK CORPORATION, LAKE FOREST, IL FROM BRUNSWICK CORPORATION, LAKE FOREST, IL:
2,534,541, INT. CL. 28.
2,534,542, INT. CL. 28.
2,534,543, INT. CL. 28.
- BRUNSWICK CORPORATION, LAKE FOREST, IL:
2,534,544, INT. CL. 28.
- BRYAN ASSOCIATES, INC., PROVIDENCE, RI:
1,866,027, CANC. INT. CL. 41.
- BRYANT COLLEGE, SMITHFIELD, RI:
1,684,698, REN. 12-17-01, INT. CL. 41.
- BRYGGERGRUPPEN A/S, 4640 FAKSE, DENMARK:
1,865,920, CANC. INT. CL. 32.
2,533,838, PUB. 11-6-2001, INT. CL. 33.
- BSH BOSCH UND SIEMENS HAUSGERATE GMBH, 81669 MUNICH, FED REP GERMANY, GAGGENAU WERKE, HAUS- UND LUFTTECHNIK GMBH, GAGGENAU, FED REP GERMANY:
1,175,572, REN. 12-21-01, INT. CL. 11.
- BUCHANAN, INC., CORINTH, TX:
1,866,174, CANC. INT. CL. 3.
- BUCK, L.L.C., WILLIAMSBURG, MI, DBA BUCK WILDER ADVENTURES:
2,533,346, PUB. 11-6-2001, INT. CL. 16.
- BUENA VISTA WINERY, INC., SONOMA, CA:
2,534,626, INT. CL. 33.
- BUFFALINO U.S.A., INC., CARTERET, NJ, HONGSON, INC., NEW YORK, NY:
1,659,823, REN. 12-18-01, INT. CL. 25.
- BUILDING INSIGHT TECHNOLOGIES INC., VANCOUVER, BRITISH COLUMBIA V6R 1P2, CANADA:
2,533,222, PUB. 11-6-2001, INT. CL. 42.
- BUILDINGSNOW.COM ARCHITECTURE ON THE FAST TRACK, FORT MYERS, FL:
2,533,348, PUB. 11-6-2001, INT. CL. 42.
- BULLY HILL VINEYARDS, INC., HAMMONDSPORT, NY:
1,142,817, CANC. INT. CL. 33.
- BULTINCK, CHRISTINA, MARIE, FRANKFORT, IL:
2,535,124, INT. CL. 16.

- BUNN-O-MATIC CORPORATION, SPRINGFIELD, IL:
2,533,331, PUB. 11-6-2001. MULTIPLE CLASS, INT. CLS.
7, 11, 35 AND 37.
- BURLEE NETWORKS, LLC, SOUTH BURLINGTON, VT:
2,533,916, PUB. 11-6-2001. MULTIPLE CLASS, INT. CLS.
39 AND 42.
2,533,917, PUB. 11-6-2001. MULTIPLE CLASS, INT. CLS.
39 AND 42.
- BURLEIGH INSTRUMENTS, INC., FISHERS VICTOR, NY:
1,164,470. REN. 12-15-01. INT. CL. 9.
- BURLINGTON INDUSTRIES, INC., GREENSBORO, NC:
1,866,408, CANC. INT. CL. 24.
- BURLINGTON NORTHERN RAILROAD COMPANY, FORT
WORTH, TX:
1,866,003, CANC. INT. CL. 39.
- BURNS PHILP FOOD INC., OAKLAND, CA:
2,534,083, PUB. 11-6-2001. INT. CL. 30.
- BUSHKO, RENATA, HOPKINTON, MA:
2,533,319, PUB. 11-6-2001. INT. CL. 41.
- BUSINESS INTEGRATION GROUP, CINCINNATI, OH:
2,535,007, INT. CL. 35.
- BUSINESS TELECOM, INC., RALEIGH, NC:
2,533,513, PUB. 11-6-2001. INT. CL. 38.
- BUSY BODY, INC., ADDISON, TX:
2,533,824, PUB. 11-6-2001. INT. CL. 42.
- BUTLER, ROBERT, SANTEE, CA:
1,865,571, CANC. INT. CL. 7.
- BUXTON ACQUISITION CO LLC, CHICOPEE, MA, BEA-
TRICE FOODS CO., CHICAGO, IL:
1,172,938. REN. 12-19-01. MULTIPLE CLASS, INT. CLS. 9,
18 AND 34.
- BUYER'S FUND, INC., THE, OREM, UT:
2,534,332, PUB. 11-6-2001. INT. CL. 36.
- BY THE VINE, INC., SEBASTOPOL, CA:
2,533,912, PUB. 11-6-2001. INT. CL. 35.
- BYK-GARDNER GMBH, D-8192 GERETSRIED 2, FED REP
GERMANY:
1,659,492. REN. 12-17-01. INT. CL. 9.
- BYTEX CORPORATION, WESTBOROUGH, MA:
1,866,245, CANC. INT. CL. 9.
- C LEVEL DESIGN, INC., SAN JOSE, CA:
2,534,581, INT. CL. 9.
- C. W. DAVIS ENTERPRISES, INC., DALLAS, TX:
1,142,993, CANC. INT. CL. 42.
- C.B. FLEET INVESTMENT CORPORATION, WILMING-
TON, DE:
2,534,286, PUB. 11-6-2001. INT. CL. 3.
- C.L. INDUSTRIES, INC., ORLANDO, FL:
2,534,135, PUB. 11-6-2001. INT. CL. 19.
- C.M. INDUSTRIES, INC., ADAMSTOWN, PA:
2,534,076, PUB. 11-6-2001. INT. CL. 35.
- C.P. MEDICAL, PORTLAND, OR:
1,866,312, CANC. INT. CL. 10.
- C.R. ONSRUD, INC., TROUTMAN, NC:
1,710,878. REN. 12-19-01. INT. CL. 7.
- C.S.F. CORP., WILMINGTON, DE:
942,143. REN. 12-15-01. U.S. CL. 101 (INT. CL. 42).
- C&M PHARMACAL, INC., MORRISTOWN, NJ:
2,533,762, PUB. 11-6-2001. INT. CL. 5.
- C-LINE PRODUCTS, INC., MT. PROSPECT, IL:
2,535,005, INT. CL. 16.
- C-ZONE, LLC, DENVER, CO:
2,534,879, INT. CL. 3.
- C/HCA, INC., NASHVILLE, TN:
2,534,646, INT. CL. 35.
- CABOT SAFETY INTERMEDIATE CORPORATION, NEW-
ARK, DE:
2,534,562, INT. CL. 9.
- CADBURY BEVERAGES DELAWARE, INC., STAMFORD,
CT, PURETEX LEMON JUICE, INC., RAYMONDVILLE,
TX:
549,097. REN. 12-16-01. U.S. CL. 46 (INT. CL. 32).
- CADCAM-E.COM, INC., FARMINGTON HILLS, MI:
2,534,755, INT. CL. 42.
- CADENCE CHEMICAL RESOURCES, INC., MICHIGAN
CITY, IN:
1,663,847. REN. 12-21-01. INT. CL. 4.
- CADENCE DESIGN SYSTEMS, INC., SAN JOSE, CA:
2,534,393, INT. CL. 9.
- CADENCE ENVIRONMENTAL ENERGY, INC., MICHIGAN
CITY, IN, CADENCE CHEMICAL RESOURCES, INC.,
MICHIGAN CITY, IN:
1,177,754. REN. 12-21-01. INT. CL. 4.
- CADMUS JOURNAL SERVICES, INC.:
See—UNPLUGI, INC..
- CADTEX CORPORATION, NEW YORK, NY:
1,865,657, CANC. INT. CL. 9.
- CAFETERIA OPERATORS, L.P., LUBBOCK, TX:
1,866,531, CANC. INT. CL. 31.
- CAG 45, INC., OMAHA, NE, BASIC VEGETABLE PRO-
DUCTS, INC., VACAVILLE, CA:
540,265. REN. 12-17-01. U.S. CL. 46 (INT. CL. 30).
- CAHN, JERRY, NEW YORK, NY:
2,534,847, INT. CL. 35.
- CAJUN EDGE LLC, CHANDLER, AZ:
2,533,753, PUB. 11-6-2001. INT. CL. 42.
- CAL CORPORATION, OTTAWA, ONTARIO, CANADA:
1,865,596, CANC. MULTIPLE CLASS, INT. CLS. 9, 37
AND 42.
- CAL-WEST SPECIALTY COATINGS, INC., SUNNYVALE,
CA:
2,533,705, PUB. 11-6-2001. INT. CL. 2.
- CALIFORNIA BEAN GROWERS ASSOCIATION, VEN-
TURA, CA, DBA MERIDIAN FOODS:
1,865,895, CANC. INT. CL. 29.
- CALIFORNIA DEPARTMENT OF FOOD AND AGRICUL-
TURE, SACRAMENTO, CA, CALIFORNIA RAISIN AD-
VISORY BOARD, FRESNO, CA:
1,623,948. REN. 12-20-01. INT. CL. 35.
- CALIFORNIA INNOVATIONS INC., WILLOWDALE, ON-
TARIO, CANADA:
2,357,751, CANC. INT. CL. 21.
- CALIFORNIA REAL ESTATE INSPECTION ASSOCIATION,
SAN DIEGO, CA:
2,533,287, PUB. 11-6-2001. INT. CL. 16.
- CALIFORNIA STATE LOTTERY, THE, SACRAMENTO, CA:
1,626,276, CANC. INT. CL. 36.
1,626,277, CANC. INT. CL. 36.
- CALIPER MANAGEMENT, INC., PRINCETON, NJ:
1,142,504, CANC. INT. CL. 16.
- CALLAHAN CREEK, INC., LAWRENCE, KS:
2,534,246, PUB. 11-6-2001. INT. CL. 35.
- CALLARD & BOWSER-SUCHARD, INC., NORTHFIELD, IL:
1,866,522, CANC. INT. CL. 30.
- CALLAWAY GOLF COMPANY, CARLSBAD, CA:
2,534,973, INT. CL. 28.
- CALLOUT PUBLISHING, L.L.C., DRAPER, UT:
2,534,640, INT. CL. 9.
- CALSCIENCE ENGINEERING AND LABORATORIES INC.,
CITY OF INDUSTRY, CA:
2,533,549, PUB. 11-6-2001. MULTIPLE CLASS, INT. CLS.
38 AND 41.
- CAM FRAN TOOL CO., INC., BENSENVILLE, IL:
1,142,985, CANC. INT. CL. 42.
- CAMBRIDGE DATA SERVICES, INC., SAN ANTONIO, TX,
DBA CURTIS HILL PUBLISHING COMPANY:
1,865,610, CANC. INT. CL. 9.
- CAMPBELL SERVICES, INC., SOUTHFIELD, MI:
1,625,682, CANC. INT. CL. 9.
- CAMPBELL, CHARLES B., III, WINSTON-SALEM, NC:
2,533,453, PUB. 11-6-2001. INT. CL. 42.
- CANADIAN ATLAS FURNITURE CORPORATION, MISSIS-
SAUGA, ONTARIO L4T 3T1, CANADA:
2,533,451, PUB. 11-6-2001. INT. CL. 20.
- CANAL+ D.A., 92514 BOULOGNE, FRANCE:
2,533,609, PUB. 11-6-2001. INT. CL. 16.
- CANON COMMUNICATIONS LLC, LOS ANGELES, CA:
2,535,092, INT. CL. 35.
- CANTINA SOCIALE COOPERATIVA DI LOCOROTONDO
SOCIETA COOPERATIVA A RESPONSABILITA LIMIT-
ATA, LOCOROTONDO BARI, ITALY:
2,533,423, PUB. 11-6-2001. INT. CL. 33.
- CAPE ELEUTHERA ISLAND SCHOOL, ELEUTHERA, BA-
HAMAS:
2,533,937, PUB. 11-6-2001. INT. CL. 41.

- CAPITAL CITIES MEDIA, INC., NEW YORK, NY:
1,142,501, CANC. INT. CL. 16.
- CAPITAL CONTROLS CO., INC., COLMAR, PA, DBA
TETRA PROCESS TECHNOLOGIES FROM TETRA TECH-
NOLOGIES, INC., THE WOODLANDS, TX:
2,534,400, INT. CL. 11.
- CAPITOL DRUGS, INC., WEST HOLLYWOOD, CA:
2,534,006, PUB. 11-6-2001. INT. CL. 35.
- CAPRICORN ELECTRONICS, LTD., KOWLOON BAY,
KOWLOON, HONG KONG:
1,866,286, CANC. INT. CL. 9.
- CAPTAIN D'S INC., NASHVILLE, TN, SHONEY'S, INC.,
NASHVILLE, TN:
1,151,309, REN. 12-19-01. INT. CL. 42.
- CARBUG, INC., BEDFORD, VA:
2,534,318, PUB. 11-6-2001. INT. CL. 9.
- CARD EXPERTS, INC., OREM, UT:
2,533,757, PUB. 11-6-2001. INT. CL. 36.
- CARDEN EDUCATIONAL FOUNDATION, INC., HILTON
HEAD ISLAND, SC:
2,533,814, PUB. 11-6-2001. INT. CL. 41.
- CARDGUARD U.S.A., INC., STILLWATER, MN:
2,533,374, PUB. 11-6-2001. INT. CL. 10.
- CARDINALCOMMERCE.COM, INC., MENTOR, OH:
2,533,968, PUB. 11-6-2001. INT. CL. 42.
- CARDIONOW, INC., SANTA MONICA, CA:
2,534,679, INT. CL. 42.
- CAREBUILD CONSTRUCTION, INC., IRVINE, CA:
1,866,325, CANC. INT. CL. 12.
- CAREER REWARDS, INC., MCLEAN, VA:
2,533,790, PUB. 11-6-2001. INT. CL. 35.
- CARESCIENCE, INC., PHILADELPHIA, PA:
2,534,223, PUB. 11-6-2001. MULTIPLE CLASS, INT. CLS.
35, 41 AND 42.
- CARIBBEAN PUBLISHING COMPANY, LTD., GEORGE-
TOWN, GRAND CAYMAN, CAYMAN ISLANDS:
1,663,390, REN. 12-17-01. INT. CL. 16.
- CARL MARKS & CO. INC., NEW YORK, NY:
2,533,430, PUB. 11-6-2001. INT. CL. 36.
- CARL-ZEISS-STIFTUNG, OBERKOCHEN, FED REP GER-
MANY, AKA CARL ZEISS:
1,173,004, REN. 12-16-01. INT. CL. 9.
- CARLE, CASEY M, EAST HADDAM, CT, DBA K&C
ENTERPRISES:
2,533,965, PUB. 11-6-2001. INT. CL. 41.
- CARLIE MOBILE SELF STORE LLLC, DENVER, CO:
2,533,477, PUB. 11-6-2001. INT. CL. 39.
- CARLS COCKTAIL LOUNGE SUPPLIES, INC., EL CAJON,
CA:
2,534,128, PUB. 11-6-2001. INT. CL. 30.
- CARMEL ENERGY, INC., HOUSTON, TX:
1,142,996, CANC. INT. CL. 42.
- CARNRICK LABORATORIES, INC., CEDAR KNOLLS, NJ:
1,865,552, CANC. INT. CL. 5.
- CAROLINAS MEDICAL CENTER, CHARLOTTE, NC:
1,625,926, CANC. INT. CL. 16.
- CARRIERPOINT, INC., ATLANTA, GA:
2,533,797, PUB. 11-6-2001. INT. CL. 39.
- CARTER-WALLACE, INC., NEW YORK, NY:
708,020, CANC. U.S. CL. 18.
1,866,168, CANC. INT. CL. 3.
2,533,749, PUB. 11-6-2001. INT. CL. 10.
- CARTOON NETWORK LP, LLLP, ATLANTA, GA:
2,534,616, INT. CL. 25.
- CARTOON NETWORK LP, LLLP, THE, ATLANTA, GA
FROM CARTOON NETWORK, INC., THE, ATLANTA,
GA:
2,534,371, INT. CL. 41.
- CASCADE BICYCLE CLUB, SEATTLE, WA:
1,866,025, CANC. INT. CL. 41.
- CASCADE MICROTTECH, INC., BEAVERTON, OR:
2,534,540, INT. CL. 9.
- CASIO, INC., DOVER, NJ:
1,866,077, CANC. INT. CL. 42.
- CASSON, FREDERICK B., BOSTON, MA:
2,535,020, MULTIPLE CLASS, INT. CLS. 18 AND 25.
- CASTLE ACOUSTICS LIMITED, SKIPTON, NORTH YORK-
SHIRE, ENGLAND:
1,174,898, REN. 12-17-01. INT. CL. 9.
- CASTLE ROCK ENTERTAINMENT, BEVERLY HILLS, CA:
1,599,944, REN. 12-20-01. INT. CL. 41.
- CASTRELLON, DAMIAN MADRID, SAN GABRIEL, CA:
1,866,463, CANC. INT. CL. 25.
- CATAPHOTE, INC., JACKSON, MS, CATAPHOTE COR-
PORATION, FLOWOOD, MS:
921,573, REN. 12-20-01. U.S. CL. 31 (INT. CL. 1).
- CATHOLIC UNIVERSITY OF AMERICA, THE, WASHING-
TON, DC:
2,533,347, PUB. 11-6-2001. INT. CL. 25.
- CATON SERVICES, INC, CEDAR PARK, TX:
2,535,130, INT. CL. 35.
- CAUCCI, CHARLES, MAYS LANDING, NJ AND CAUCCI,
ROSEMARIE, MAYS LANDING, NJ:
2,533,530, PUB. 11-6-2001. INT. CL. 35.
- CAVANAUGH MARKETING NETWORK, INC., PITTS-
BURGH, PA:
2,533,986, PUB. 11-6-2001. INT. CL. 35.
- CBS INC., NEW YORK, NY:
1,865,989, CANC. INT. CL. 38.
- CD&L INC., HACKENSACK, NJ:
2,534,060, PUB. 11-6-2001. MULTIPLE CLASS, INT. CLS.
35 AND 39.
- CD&L, INC., HACKENSACK, NJ:
2,534,061, PUB. 11-6-2001. MULTIPLE CLASS, INT. CLS.
35 AND 39.
- CDI CORPORATION, PHILADELPHIA, PA:
2,534,084, PUB. 11-6-2001. INT. CL. 35.
- CEA AB, STRANGNAS, SWEDEN:
1,865,497, CANC. INT. CL. 1.
- CEGOS, ISSY LES MOULINEAUX, FRANCE:
1,180,439, REN. 12-16-01. MULTIPLE CLASS, INT. CLS.
35 AND 41.
- CELEBRITY CRUISES INC., MIAMI, FL:
2,533,295, PUB. 11-6-2001. INT. CL. 39.
- CELESTION INTERNATIONAL LIMITED, SUFFOLK IP3
8JP, ENGLAND:
1,865,591, CANC. INT. CL. 9.
- CELLSTAR, LTD., CARROLLTON, TX:
2,533,227, PUB. 11-6-2001. MULTIPLE CLASS, INT. CLS.
35, 36, 37, 38 AND 42.
- CELLULAR SERVICES GROUP, INC., BALTIMORE, MD:
1,866,218, CANC. INT. CL. 9.
- CELLULAR SHOP CORP., MIAMI, FL:
1,865,652, CANC. INT. CL. 9.
- CELOTEX CORPORATION, THE, TAMPA, FL:
1,142,164, CANC. MULTIPLE CLASS, INT. CLS. 1, 2 AND
19.
- CEMEX FINANACE, INC., ONTARIO, CA, LIMESTONE
PRODUCTS CORPORATION OF AMERICA, NEWTON,
NJ:
918,720, REN. 12-18-01. U.S. CL. 1 (INT. CL. 1).
- CENEX HARVEST STATES COOPERATIVES, INVER
GROVE HEIGHTS, MN, HARVEST STATES COOPERA-
TIVES, ST. PAUL, MN:
1,659,990, REN. 12-17-01. INT. CL. 31.
- CENTER FOR ANTHROPOSOLOGY, WILTON, NH:
2,534,024, PUB. 11-6-2001. INT. CL. 41.
- CENTER FOR EMPLOYMENT TRAINING, SAN JOSE, CA:
2,533,758, PUB. 11-6-2001. INT. CL. 41.
- CENTER FOR NEUROLOGIC STUDY, LA JOLLA, CA:
1,181,545, REN. 12-17-01. MULTIPLE CLASS, INT. CLS.
41 AND 42.
- CENTER FOR SALES STRATEGY, INC., THE, TAMPA, FL:
2,533,488, PUB. 11-6-2001. INT. CL. 41.
- CENTER FOR WOMEN'S MINISTRIES, INC., BLOOMING-
TON, IN:
2,533,610, PUB. 11-6-2001. INT. CL. 42.
- CENTRAL CITY ON-LINE, INC., HUNTINGTON, WV:
2,533,233, PUB. 11-6-2001. INT. CL. 38.
- CENTRAL DESIGN SYSTEMS, INC., SAN JOSE, CA, DBA
GOBOSH:
2,533,710, PUB. 11-6-2001. MULTIPLE CLASS, INT. CLS.
37 AND 42.

- CENTRAL FIBER CORPORATION, WELLSVILLE, KS:
2,534,073, PUB. 11-6-2001. INT. CL. 31.
- CENTRAL FLORIDA INVESTMENTS, INC., ORLANDO, FL:
2,533,600, PUB. 11-6-2001. INT. CL. 16.
- CENTRAL FREIGHT LINES, INC., WACO, TX:
2,533,963, PUB. 11-6-2001. INT. CL. 39.
- CENTURY BROADCASTING CORPORATION, CHICAGO, IL:
1,142,898, CANC. INT. CL. 38.
- CENTURY MARKETING CORPORATION, BOWLING GREEN, OH:
2,534,291, PUB. 11-6-2001. INT. CL. 16.
- CENTURY PRECISION INDUSTRIES, INC., NORTH HOLLYWOOD, CA:
1,142,328, CANC. INT. CL. 9.
- CENTURY SPORTS, INC., PLAINFIELD, NJ:
1,142,717, CANC. INT. CL. 28.
- CEPHEID, SUNNYVALE, CA:
2,534,624, MULTIPLE CLASS, INT. CLS. 9 AND 10.
- CERADYNE, INC., COSTA MESA, CA:
2,533,815, PUB. 11-6-2001. INT. CL. 1.
- CERCORP INITIATIVES INC., BLOOMINGDALE, OH:
2,534,137, PUB. 11-6-2001. INT. CL. 19.
- CERDIC B.V., 6718 TB EDE, NETHERLANDS FROM CHRISTIAANS & VAN DE WIEL B.V., 6718 TB EDE, NETHERLANDS:
2,534,414, INT. CL. 5.
- CERTAINTED CORPORATION, VALLEY FORGE, PA:
1,866,380, CANC. INT. CL. 19.
- CERVECERIA DEL PACIFICO, S.A. DE C.V., SINALOA, MEXICO:
2,534,167, PUB. 11-6-2001. INT. CL. 41.
- CESPA - S.R.L., VERGINI ZONA INDUSTRIALE B, ITALY:
2,533,219, PUB. 4-27-1999. INT. CL. 3.
- CE3000.COM, SACRAMENTO, CA:
2,534,011, PUB. 11-6-2001. INT. CL. 41.
- CFM MAJESTIC INC., MISSISSAUGA, ONTARIO L5T 2N1, CANADA:
2,533,643, PUB. 11-6-2001. INT. CL. 11.
- CHAINTECH COMPUTER CO., LTD., TU CHEN CITY, TAIPEI HSIEN, TAIWAN:
2,533,899, PUB. 11-6-2001. INT. CL. 9.
2,533,900, PUB. 11-6-2001. INT. CL. 9.
- CHALET DESSERTS, INC., CHICAGO, IL:
1,659,963, REN. 12-17-01. INT. CL. 30.
- CHALET SUZANNE FOODS, INC., LAKE WALES, FL:
1,661,005, REN. 12-18-01. INT. CL. 30.
- CHALLENGER MANUFACTURING, INC., BATAVIA, IL:
1,816,552 NEW CERT. 1-29-2002. INT. CL. 1.
- CHALONE WINE GROUP, LTD., THE, NAPA, CA:
2,533,490, PUB. 11-6-2001. INT. CL. 33.
- CHAMBERBENEFITS, INC., ORLANDO, FL:
2,533,617, PUB. 11-6-2001. INT. CL. 41.
- CHAN, KENNETH CHONG-KUAN, HAYWARD, CA, DBA PROLIFIC COMPANY:
1,865,840, CANC. INT. CL. 25.
- CHAPLIN, DENISE, NEW YORK, NY:
2,533,538, PUB. 11-6-2001. INT. CL. 21.
- CHARLOTTE MEMORIAL HOSPITAL AND MEDICAL CENTER, CHARLOTTE, NC:
1,658,544, REN. 12-20-01. INT. CL. 41.
- CHASE MANHATTAN CORPORATION, THE, NEW YORK, NY:
2,535,071, INT. CL. 42.
- CHASEMELLON SHAREHOLDER SERVICES, L.L.C, RIDGEFIELD PARK, NJ:
2,533,639, PUB. 11-6-2001. INT. CL. 36.
- CHAYET COMMUNICATIONS GROUP, INC., BOSTON, MA:
2,534,354, MULTIPLE CLASS, INT. CLS. 38 AND 41.
- CHEM FINANCIAL, INC, OAKVILLE, ONTARIO, CANADA:
2,534,498, INT. CL. 7.
- CHEMENCE, INC., MENTOR, OH:
1,625,491, CANC. INT. CL. 1.
- CHEMICAL PRODUCTS R. BORGHGRAEF, 1190 BRUXELLES, BELGIUM:
1,169,792, REN. 12-19-01. INT. CL. 3.
- CHEMICOLLOID LABORATORIES, INC., THE, GARDEN CITY PARK, NY:
927,749, REN. 12-19-01. U.S. CL. 23 (INT. CL. 7).
- CHENILLE KRAFT COMPANY, THE, GURNEE, IL:
2,534,766, INT. CL. 28.
- CHESEBROUGH-POND'S INC., GREENWICH, CT:
383,354, CANC. U.S. CL. 50.
- CHESEBROUGH-POND'S INC., WILMINGTON, DE:
2,534,123, PUB. 11-6-2001. INT. CL. 3.
2,534,129, PUB. 11-6-2001. INT. CL. 3.
2,534,130, PUB. 11-6-2001. INT. CL. 3.
2,534,236, PUB. 11-6-2001. INT. CL. 3.
- CHICAGO GROUP, INC., THE, CHICAGO, IL:
1,659,081, REN. 12-20-01. INT. CL. 35.
- CHICAGO INDUSTRIAL PUMP CO., CHICAGO, IL:
2,533,853, PUB. 11-6-2001. INT. CL. 7.
- CHICAGO MASONRY CONSTRUCTION, INC., ELK GROVE VILLAGE, IL:
2,533,977, PUB. 11-6-2001. INT. CL. 37.
- CHICAGO PIZZA & BREWERY, INC., HUNTINGTON BEACH, CA:
2,534,325, PUB. 11-6-2001. INT. CL. 42.
- CHICAGO PROFESSIONAL SPORTS LIMITED PARTNERSHIP, CHICAGO, IL:
1,652,651, REN. 12-15-01. INT. CL. 41.
1,866,427, CANC. INT. CL. 25.
- CHICAGO WHITE METAL CASTING, INC., BENSENVILLE, IL:
2,533,305, PUB. 11-6-2001. MULTIPLE CLASS, INT. CLS. 6 AND 40.
- CHICOR INFORMATION MANAGEMENT, INC., CHICAGO, IL:
2,533,661, PUB. 11-6-2001. INT. CL. 36.
- CHILCOTE COMPANY, THE, CLEVELAND, OH:
1,179,200, REN. 12-17-01. INT. CL. 20.
- CHILDREN'S BROADCASTING CORPORATION, MINNEAPOLIS, MN:
1,866,030, CANC. INT. CL. 41.
- CHILDREN'S CANCER ASSOCIATION, PORTLAND, OR:
2,534,048, PUB. 11-6-2001. INT. CL. 42.
- CHINA OCEAN SHIPPING COMPANY AMERICAS, INC., SECAUCUS, NJ:
2,135,906, CANC. INT. CL. 39.
- CHIPMASTERS, INC., RATHDRUM, ID:
2,534,315, PUB. 11-6-2001. INT. CL. 37.
- CHOICE ONE COMMUNICATIONS, INC., ROCHESTER, NY:
2,533,926, PUB. 11-6-2001. INT. CL. 42.
- CHOMERICS, INC., WOBURN, MA:
922,726, REN. 12-15-01. U.S. CL. 21 (INT. CL. 9).
- CHOU, TERRY, TAINAN CITY, TAIWAN:
2,534,426, INT. CL. 17.
- CHR. HANSEN'S BIOSYSTEMS A/S, DK-2970, HORSHOLM, DENMARK, PIONEER HI-BRED INTERNATIONAL, INC., DES MOINES, IA:
1,185,389, REN. 12-21-01. INT. CL. 5.
- CHRISTENSEN, BARBARA, LAS VEGAS, NV:
1,866,497, CANC. INT. CL. 28.
- CHRISTIAN BROTHERS, INC., WARROAD, MN:
2,534,900, INT. CL. 28.
- CHRISTIAN UNIVERSITY GLOBALNET, LITTLETON, CO:
2,534,503, MULTIPLE CLASS, INT. CLS. 41 AND 42.
- CHRISTOPHERSON, NANCY, OLDSMAR, FL:
2,535,121, INT. CL. 42.
- CHRISTY'S COUNTRY CANDLES, INC., MADISON, IN:
2,533,307, PUB. 11-6-2001. MULTIPLE CLASS, INT. CLS. 4 AND 35.
- CHU, GENE C., ALHAMBRA, CA:
2,533,795, PUB. 11-6-2001. INT. CL. 38.
- CHUM LIMITED, TORONTO, ONTARIO M4T 1Y1, CANADA:
1,930,762, CANC. INT. CL. 25.
- CHUN, ZHANG, SANTA ANA, CA:
2,533,764, PUB. 11-6-2001. INT. CL. 5.
- CHURCH & DWIGHT COMPANY, GREEN RIVER, WY:
1,866,614, CANC. INT. CL. 3.
- CI SEAFOODS, INC., SEATTLE, WA:
1,865,894, CANC. INT. CL. 29.

- CIGNA CORPORATION:
See— CIGNA INTELLECTUAL PROPERTY, INC..
- CIGNA CORPORATION, PHILADELPHIA, PA FROM CIGNA CORPORATION, PHILADELPHIA, PA: 2,534,705, INT. CL. 42.
- CIGNA INTELLECTUAL PROPERTY, INC., WILMINGTON, DE FROM CIGNA CORPORATION, PHILADELPHIA, PA: 2,533,724, PUB. 11-6-2001. INT. CL. 35.
- CIMA LABS, INC., EDEN PRAIRIE, MN: 2,533,761, PUB. 11-6-2001. INT. CL. 5.
 2,534,423, MULTIPLE CLASS, INT. CLS. 35 AND 42.
- CINCINNATI REDS, CINCINNATI, OH: 1,142,508, CANC. INT. CL. 16.
- CINCINNATI REDS, LLC, THE, CINCINNATI, OH: 2,533,903, PUB. 11-6-2001. INT. CL. 41.
 2,533,904, PUB. 11-6-2001. INT. CL. 41.
- CINCINNATI SUB-ZERO PRODUCTS, INC., CINCINNATI, OH: 1,709,298. REN. 12-21-01. INT. CL. 10.
- CIRCUIT CITY STORES WEST COAST, INC., WALNUT, CA: 1,866,589, CANC. INT. CL. 42.
- CITIPATE, INC., ROSLYN HEIGHTS, NY: 1,142,251, CANC. INT. CL. 7.
- CITIZEN AMERICA CORPORATION, SANTA MONICA, CA: 1,625,789, CANC. INT. CL. 9.
- CITIZENS' SCHOLARSHIP FOUNDATION OF AMERICA, INC., BOSTON, MA: 924,012. REN. 12-17-01. MULTIPLE CLASS, U.S. CLS. 102 (INT. CL. 36) AND 107 (INT. CL. 41).
- CITRA-SOLV LLC, RIDGEFIELD, CT FROM SHADOW LAKE, INC., RIDGEFIELD, CT: 2,533,620, PUB. 11-6-2001. INT. CL. 3.
- CITY CANYONS PRODUCING & PUBLISHING CO., NEW YORK, NY: 2,534,627, MULTIPLE CLASS, INT. CLS. 9 AND 25.
- CITY EXPRESS, INC., BOSTON, MA: 2,534,072, PUB. 11-6-2001. INT. CL. 39.
- CITY OF LOUISVILLE, KENTUCKY, LOUISVILLE, KY: 2,534,019, PUB. 11-6-2001. INT. CL. 35.
- CITY OF THOMASVILLE, GEORGIA, ST. THOMASVILLE, CA: 2,533,455, PUB. 11-6-2001. INT. CL. 38.
- CITYSOFT, INC., WATERTOWN, MA: 2,533,468, PUB. 11-6-2001. INT. CL. 42.
- CIVITAN INTERNATIONAL, BIRMINGHAM, AL: 1,865,731, CANC. MULTIPLE CLASS, INT. CLS. 14, 16, 25 AND 42.
- CLAIR, KEVIN P., LAYTONSVILLE, MD: 2,533,264, PUB. 11-6-2001. INT. CL. 37.
- CLAIREMONT ELECTRONICS LIMITED, GREENOCK PA16 0EQ, UNITED KINGDOM: 2,533,547, PUB. 11-6-2001. INT. CL. 40.
- CLARIAN HEALTH PARTNERS, INC., INDIANAPOLIS, IN: 2,534,051, PUB. 11-6-2001. INT. CL. 42.
- CLARK EQUIPMENT COMPANY, BUCHANAN, MI: 1,142,245, CANC. MULTIPLE CLASS, INT. CLS. 7 AND 12.
- CLARK UNIVERSITY, WORCESTER, MA: 2,534,058, PUB. 11-6-2001. INT. CL. 41.
- CLARK, DAN, OVERLAND PARK, KS: 2,534,809, INT. CL. 14.
- CLASSIC ATTRACTION, INC., GRAND PRAIRIE, TX: 2,533,748, PUB. 11-6-2001. INT. CL. 41.
- CLAYTON COLLEGE OF NATURAL HEALTH, INC., BIRMINGHAM, AL: 2,533,696, PUB. 11-6-2001. INT. CL. 41.
- CLEAN TECH, INC., PLYMOUTH, MI: 1,669,444. REN. 12-18-01. INT. CL. 17.
- CLEVELAND INSTITUTE OF DENTAL-MEDICAL ASSISTANTS, INC., CLEVELAND, OH: 1,637,865. REN. 12-19-01. INT. CL. 41.
- CLEVELAND TUBING, INC., CLEVELAND, TN: 1,675,125. REN. 12-15-01. INT. CL. 20.
- CLICKSPIN.COM LLC, WOODLAND HILLS, CA FROM DEAN CHILDERS; JACK STRELIOFF AND RALPH PIEPLENBOS PARTNERSHIP, THE, WOODLAND HILLS, CA: 2,533,387, PUB. 10-30-2001. INT. CL. 41.
- CLIGNOSIS, INC., BOSTON, MA: 2,534,702, INT. CL. 42.
- CLINIPAD CORPORATION, THE, GUILFORD, CT: 1,142,203, CANC. INT. CL. 5.
- CLOSE, WILLIAM, BROOKFIELD, WI: 2,533,516, PUB. 11-6-2001. MULTIPLE CLASS, INT. CLS. 35 AND 42.
- CLOUGHERTY PACKING COMPANY, LOS ANGELES, CA: 2,534,225, PUB. 11-6-2001. INT. CL. 42.
- CLUB ASSIST INTERNATIONAL INC., PHOENIX, AZ: 2,534,321, PUB. 11-6-2001. INT. CL. 37.
- CLUB SPORTSWEAR, INC., IRVINE, CA: 1,625,986, CANC. INT. CL. 18.
- CMP MEDIA LLC, MANHASSET, NY, CMP PUBLICATIONS, INC., MANHASSET, NY: 1,660,431. REN. 12-15-01. INT. CL. 16.
- CMP PUBLICATIONS, INC., MANHASSET, NY: 1,865,662, CANC. INT. CL. 9.
 1,866,339, CANC. INT. CL. 16.
- CNA FINANCIAL CORPORATION, TORONTO, ONTARIO, M5C 2V9, CANADA: 2,534,467, INT. CL. 36.
- CNI HOLDING CORPORATION, CLEARWATER, FL: 2,534,889, INT. CL. 41.
- CNMC COMPANY, NASHVILLE, TN: 2,534,956, INT. CL. 10.
- COACH, INC., NEW YORK, NY FROM SARA LEE CORPORATION, WINSTON-SALEM, NC: 2,534,429, INT. CL. 9.
- COALITION OF SOUTHERN NEW JERSEY PRIVATE SPECIAL EDUCATION SCHOOLS, INC., THE, HADDONFIELD, NJ: 2,534,199, PUB. 11-6-2001. INT. CL. 16.
- COBALT PICTURES, INC., CORAL GABLES, FL: 2,534,619, INT. CL. 42.
- COBURN OPTICAL INDUSTRIES, INC., TULSA, OK: 1,625,548, CANC. INT. CL. 3.
- COCA-COLA COMPANY, THE, ATLANTA, GA: 1,865,875, CANC. INT. CL. 28.
- CODE MAVEN CORP., HUNTINGTON, NY: 2,533,422, PUB. 11-6-2001. INT. CL. 42.
- COFFEE BUTLER SERVICE, INC., WASHINGTON, DC: 1,626,172, CANC. INT. CL. 30.
 1,626,174, CANC. INT. CL. 30.
- COFFEE PROCESS TECHNOLOGY CORPORATION, HOUSTON, TX: 2,533,980, PUB. 11-6-2001. INT. CL. 30.
- COGNEX CORPORATION, NEEDHAM, MA: 1,855,533, CANC. INT. CL. 9.
- COGNIS DEUTSCHLAND GMBH, DUESSELDORF, FED REP GERMANY: 2,533,551, PUB. 11-6-2001. INT. CL. 1.
- COHEN BROWN PICTURE COMPANY, INC., LOS ANGELES, CA: 2,534,568, INT. CL. 16.
 2,534,570, INT. CL. 41.
- COHEN, JEFFREY ROBERT, FORT WORTH, TX: 2,533,392, PUB. 11-6-2001. INT. CL. 9.
- COHEN, SETH, MIAMI, FL: 2,533,563, PUB. 11-6-2001. INT. CL. 42.
- COIN MECHANISMS, INC., GLENDALE HEIGHTS, IL: 1,865,663, CANC. INT. CL. 9.
- COKER, BRYAN, WILLIAM, LOS GATOS, CA: 2,534,307, PUB. 11-6-2001. INT. CL. 42.
- COLART/AMERICAS INC, PISCATAWAY, NJ, BINNEY & SMITH INC., EASTON, PA: 1,660,362. REN. 12-19-01. INT. CL. 16.
- COLDWATER SEAFOOD CORP., SCARSDALE, NY: 1,170,449. REN. 12-20-01. INT. CL. 29.
- COLE-PARMER INSTRUMENT COMPANY, VERNON HILLS, IL: 1,178,682. REN. 12-20-01. MULTIPLE CLASS, INT. CLS. 7

- AND 9.
1,664,911. REN. 12-19-01. INT. CL. 9.
- COLEMAN CABLE SYSTEMS, INC., NORTH CHICAGO, IL:
1,625,700. CANC. INT. CL. 9.
- COLEMAN CABLE, INC., WAUKEGAN, IL, COLEMAN
CABLE SYSTEMS, INC., NORTH CHICAGO, IL:
1,658,044. REN. 12-17-01. INT. CL. 9.
- COLEMAN COMPANY, INC., THE, WICHITA, KS:
1,142,564. CANC. MULTIPLE CLASS, INT. CLS. 18, 25
AND 28.
1,142,565. CANC. MULTIPLE CLASS, INT. CLS. 18, 25
AND 28.
- COLGATE-PALMOLIVE COMPANY, NEW YORK, NY:
2,534,657. INT. CL. 3.
- COLLAGE VIDEO SPECIALTIES, INC., MINNEAPOLIS,
MN:
1,658,208. REN. 12-17-01. INT. CL. 16.
- COLLATECH, INC., CHAMPAIGN, IL, DBA DCHAIN COM-
MERCE:
2,533,628. PUB. 11-6-2001. INT. CL. 35.
2,533,632. PUB. 11-6-2001. INT. CL. 35.
- COLLECTIVE TECHNOLOGIES, INC., AUSTIN, TX:
2,533,409. PUB. 11-6-2001. MULTIPLE CLASS, INT. CLS.
37 AND 42.
- COLLECTOR TECHNOLOGIES, INC., DALLAS, TX:
2,533,403. PUB. 11-6-2001. INT. CL. 35.
- COLLECTORS COVEY, INC., DALLAS, TX:
1,164,157. REN. 12-21-01. INT. CL. 42.
- COLLECTORS PRODUCTS CORPORATION, ASHEVILLE,
NC:
1,865,812. CANC. INT. CL. 20.
- COLLINS PRODUCTS COMPANY, LIVINGSTON, TX:
2,533,802. PUB. 11-6-2001. INT. CL. 7.
- COLONY COMPANIES, INC., THE, MALIBU, CA:
2,533,700. PUB. 11-6-2001. INT. CL. 35.
- COLOR STAR GROWERS, INC., FORT LUPTON, CO:
2,534,270. PUB. 11-6-2001. INT. CL. 31.
- COLORADO NATIONAL BANK OF DENVER, THE, DEN-
VER, CO:
1,142,862. CANC. INT. CL. 36.
1,142,870. CANC. INT. CL. 36.
- COLORLAB COSMETICS, INC., ROCKFORD, IL:
2,534,285. PUB. 11-6-2001. INT. CL. 3.
- COLORTEC, INC., SAGINAW, MI, DBA FINISHZONE:
2,533,832. PUB. 11-6-2001. INT. CL. 37.
- COLTENE AG, ALSTATTEN, SWITZERLAND:
2,533,983. PUB. 11-6-2001. INT. CL. 5.
- COLTENE WHALEDENT, INC, MAHWAH, NJ, HYGENIC
CORPORATION, THE, AKRON, OH:
1,658,658. REN. 12-16-01. INT. CL. 10.
- COLUMBIA INDUSTRIES, INC., SAN ANTONIO, TX:
1,142,707. CANC. INT. CL. 28.
- COLUMBIA PICTURES INDUSTRIES, INC., NEW YORK,
NY:
1,142,537. CANC. INT. CL. 16.
1,142,538. CANC. INT. CL. 16.
- COMAIR ROTRON, INC., SAN DIEGO, CA:
1,660,709. REN. 12-15-01. INT. CL. 11.
- COMBE INCORPORATED, WHITE PLAINS, NY:
1,191,055. REN. 12-19-01. INT. CL. 5.
- COMEASE.COM, INC., LONG BEACH, CA:
2,533,988. PUB. 11-6-2001. INT. CL. 38.
- COMERS, CHAMBERY, FRANCE:
2,533,434. PUB. 11-6-2001. INT. CL. 32.
- COMMERCE BANCORP, INC., CHERRY HILL, NJ:
2,533,220. PUB. 11-6-2001. INT. CL. 36.
- COMMERCIAL FEDERAL BANK, OMAHA, NE:
2,534,858. INT. CL. 36.
- COMMERCIAL LAW AFFILIATES, INC., MINNEAPOLIS,
MN:
2,534,831. INT. CL. 35.
- COMMEREX INTERNATIONAL, L.L.C., PLANO, TX:
2,534,111. PUB. 11-6-2001. INT. CL. 35.
- COMMON KNOWLEDGE, INC., DALLAS, TX:
2,533,864. PUB. 11-6-2001. INT. CL. 35.
- COMMONWEALTH BRANDS, INC., BOWLING GREEN,
KY, AMERICAN TOBACCO COMPANY, THE, STAM-
FORD, CT:
1,680,540. REN. 12-17-01. INT. CL. 34.
- COMMUNITY AFFORDABLE HOUSING EQUITY CORP.,
RALEIGH, NC:
2,533,948. PUB. 11-6-2001. INT. CL. 36.
- COMMUNITY COFFEE COMPANY, L.L.C., BATON
ROUGE, LA:
2,533,901. PUB. 11-6-2001. INT. CL. 30.
- COMMUNITY COLLEGE FOUNDATION, SACRAMENTO,
CA:
2,533,647. PUB. 11-6-2001. INT. CL. 41.
- COMMUNITY CONNECT INC., NEW YORK, NY:
2,533,436. PUB. 11-6-2001. MULTIPLE CLASS, INT. CLS.
35, 38 AND 42.
- COMMUNITY FOR EDUCATION FOUNDATION, NEW
YORK, NY:
2,533,344. PUB. 8-8-2000. MULTIPLE CLASS, INT. CLS.
16, 36 AND 41.
- COMMUNITY HEALTH SERVICES, INC., OWINGS MILLS,
MD:
1,866,112. CANC. MULTIPLE CLASS, INT. CLS. 36 AND
42.
- COMPACTALL INC., NEW YORK, NY:
1,866,205. CANC. INT. CL. 7.
- COMPADRES, THE, HONOLULU, HI:
1,658,571. REN. 12-19-01. INT. CL. 42.
- COMPASSCOM, INC., ENGLEWOOD, CO:
2,475,420. COR. INT. CL. 42.
- COMPLIANCE COACH, INC., SAN DIEGO, CA FROM
HUDA, SAI, SAN DIEGO, CA:
2,534,521. INT. CL. 36.
- COMPUTER LANGUAGE RESEARCH, INC., CARROLL-
TON, TX:
1,865,669. CANC. INT. CL. 9.
- COMPUTER PRO, INC., DULUTH, MN:
2,533,670. PUB. 11-6-2001. INT. CL. 37.
- COMSCIENCES, INC., LOS ANGELES, CA:
2,533,737. PUB. 11-6-2001. MULTIPLE CLASS, INT. CLS.
35 AND 42.
- COMWORKER.COM, INC., OAK HILL, VA:
2,533,317. PUB. 11-6-2001. INT. CL. 35.
- CON-SOLE GOLF CORPORATION, MAMARONECK, NY:
1,866,498. CANC. INT. CL. 28.
- CONAGRA BRANDS, INC., OMAHA, NE, HUNT-WESSON,
INC., FULLERTON, CA:
1,659,921. REN. 12-21-01. MULTIPLE CLASS, INT. CLS.
29 AND 30.
- CONAGRA GROCERY PRODUCTS COMPANY, IRVINE,
CA, AMERICAN HOME PRODUCTS CORPORATION,
NEW YORK, NY:
1,173,508. REN. 12-21-01. INT. CL. 30.
- CONCENTRIX CORPORATION, PITTSFORD, NY FROM
MATRICS CORPORATION, ROCHESTER, NY:
2,533,198. PUB. 11-6-2001. MULTIPLE CLASS, INT. CLS.
35 AND 40.
- CONCEPT SYSTEMS, INC., FORT COLLINS, CO, DBA
SCUBA SCHOOLS INTERNATIONAL, INC.:
2,533,535. PUB. 11-6-2001. INT. CL. 41.
- CONCORD CAMERA CORP., AVENEL, NJ:
1,866,284. CANC. INT. CL. 9.
- CONCRETE LEVELING, INC., AKRON, OH:
1,866,564. CANC. INT. CL. 37.
- CONFERENCE PLUS, INC., SCHAUMBURG, IL:
2,533,631. PUB. 11-6-2001. INT. CL. 38.
- CONGOLEUM CORPORATION, KEARNY, NJ:
1,142,683. CANC. INT. CL. 27.
- CONMED CORPORATION, UTICA, NY:
1,865,708. CANC. INT. CL. 10.
2,533,478. PUB. 11-6-2001. INT. CL. 10.
- CONNECTICUT SCHOOL OF BROADCASTING, INC.,
FARMINGTON, CT:
1,662,800. REN. 12-16-01. INT. CL. 41.
- CONNELL RICE & SUGAR CO., INC., WESTFIELD, NJ:
1,142,773. CANC. INT. CL. 30.
- CONSECO, INC., CARMEL, IN:
2,533,803. PUB. 11-6-2001. INT. CL. 36.

- CONSERVATION TOURISM, LTD., ROAD TOWN, TORTULLA, BR. VIRGIN ISLANDS:
2,533,266, PUB. 11-6-2001. INT. CL. 39.
- CONSILIENCE GROUP, LLC, MEMPHIS, TN:
2,534,080, PUB. 11-6-2001. INT. CL. 35.
- CONSOLIDATED VALVE, LTD., CINCINNATI, OH, LUNKENHEIMER COMPANY, THE, CINCINNATI, OH:
83,663. REN. 12-17-01. U.S. CL. 23 (INT. CL. 7).
- CONSOLTEX INC., ST. LAURENT, QUEBEC, CANADA:
2,534,174, PUB. 11-6-2001. INT. CL. 24.
- CONSUMERS UNITED INSURANCE COMPANY, WASHINGTON, DC:
1,866,551, CANC. INT. CL. 36.
- CONTINENTAL AIRLINES, INC., HOUSTON, TX:
2,534,678, INT. CL. 9.
- CONTINENTAL DYNAMICS CORPORATION, PORT WASHINGTON, NY:
2,534,402, INT. CL. 40.
- CONTRACT FREIGHTERS, INC., JOPLIN, MO:
1,664,437. REN. 12-18-01. INT. CL. 39.
- CONTRERAS, ROBERT ANDREW, BENICIA, CA:
2,533,481, PUB. 11-6-2001. INT. CL. 40.
- CONTROL DATA CORPORATION, MINNEAPOLIS, MN:
1,142,824, CANC. INT. CL. 35.
- CONVERGENCE, INCORPORATED, LAGUNA BEACH, CA:
2,533,389, PUB. 11-6-2001. INT. CL. 42.
- CONVERGYS CORPORATION, CINCINNATI, OH FROM TMJ, INC., CINCINNATI, OH:
2,534,431, MULTIPLE CLASS, INT. CLS. 9, 35, 38 AND 42.
- COOKIE INDUSTRIES, INC., CHESHIRE, OR:
2,534,196, PUB. 11-6-2001. INT. CL. 7.
- COOL RUNNINGS SPRING WATER COMPANY LTD., MONTEGO BAY, ST. JAMES, JAMAICA:
2,534,802, INT. CL. 32.
- COOLING COMPONENTS, INC., ST. LOUIS, MO, COOLING TOWERS INC., ST. LOUIS, MO:
1,661,101. REN. 12-18-01. INT. CL. 37.
- COOPER INDUSTRIES, INC., HOUSTON, TX:
1,657,167. REN. 12-19-01. INT. CL. 7.
- COOPERATIVE COMPUTING, INC., LIVERMORE, CA:
1,658,855. REN. 12-17-01. INT. CL. 9.
- COQUICO, INC., SPRINGFIELD, PA:
2,534,754, MULTIPLE CLASS, INT. CLS. 25 AND 28.
- CORBETT; SALLY, ATLANTA, GA:
1,142,908, CANC. INT. CL. 40.
- CORCORAN GROUP EAST SIDE, INC., NEW YORK, NY:
2,533,288, PUB. 11-6-2001. INT. CL. 36.
- CORDIS CORPORATION, MIAMI LAKES, FL:
2,534,786, INT. CL. 10.
- CORECO IMAGING, INC., WILMINGTON, DE TO IMAGING TECHNOLOGY INCORPORATED, BEDFORD, MA:
2,481,177, COR. INT. CL. 9.
- COREINTELLECT, INC., DALLAS, TX:
2,533,978, PUB. 11-6-2001. INT. CL. 35.
- CORN PRODUCTS INTERNATIONAL, INC., BEDFORD PARK, IL:
2,534,125, PUB. 11-6-2001. INT. CL. 1.
- CORNWELL QUALITY TOOL COMPANY, THE, WADSWORTH, OH:
2,533,695, PUB. 11-6-2001. MULTIPLE CLASS, INT. CLS. 7, 8, 9 AND 35.
- CORPORATE EXPRESS, INC., BROOMFIELD, CO:
2,534,023, PUB. 11-6-2001. INT. CL. 35.
- CORPOREX COMPANIES, INC., COVINGTON, KY:
2,534,264, PUB. 11-6-2001. INT. CL. 37.
2,534,265, PUB. 11-6-2001. INT. CL. 42.
- CORRIGO, INC., REDWOOD CITY, CA:
2,534,959, INT. CL. 42.
2,534,979, INT. CL. 9.
- COSMOS VACCUM TECHNOLOGY CORPORATION, TAIPEI, TAIWAN:
2,534,968, INT. CL. 7.
- COTT BEVERAGES INC., TAMPA, FL, COTT BEVERAGE CORPORATION, NEW HAVEN, CT:
540,457. REN. 12-17-01. U.S. CL. 45 (INT. CL. 32).
- COTT CORPORATION, MISSISSAUGA, ONTARIO, CANADA:
2,535,068, INT. CL. 32.
- COUNTER CULTURE COFFEE, INC., DURHAM, NC, NC:
2,533,827, PUB. 11-6-2001. INT. CL. 30.
- COUNTRY ARTISTS LIMITED, WARWICKSHIRE, CV37 OHR, ENGLAND:
1,865,809, CANC. INT. CL. 20.
- COUNTRY CLUB INDUSTRIES (USA) CORP., LOS ANGELES, CA:
1,858,693, CANC. INT. CL. 26.
- COUNTRY HEN, INC., THE, HUBBARDSTON, MA:
1,659,935, REN. 12-17-01. INT. CL. 29.
- COUNTRY RADIO BROADCASTERS, INC., NASHVILLE, TN:
2,533,201, PUB. 11-6-2001. INT. CL. 41.
- COVANCE RESEARCH PRODUCTS INC., DENVER, PA, HAZLETON RESEARCH PRODUCTS, INC., DENVER, PA:
1,668,723, REN. 12-18-01. INT. CL. 31.
- COVENTRY INSURANCE COMPANY, CINCINNATI, OH:
1,660,407, REN. 12-19-01. INT. CL. 36.
- COVERALL NORTH AMERICA, INC., SAN DIEGO, CA:
2,533,774, PUB. 11-6-2001. INT. CL. 37.
- COX, JOSEPH TIMOTHY, SILVER SPRING, MD:
1,866,138, CANC. MULTIPLE CLASS, INT. CLS. 37 AND 42.
- CPG PRODUCTS CORP., MINNEAPOLIS, MN:
708,046, CANC. U.S. CL. 22.
- CPL CARBON LINK CORPORATION, COLUMBUS, OH:
2,534,732, INT. CL. 42.
2,534,733, INT. CL. 11.
- CRABTREE & EVELYN, LTD., WOODSTOCK, CT:
1,866,161, CANC. INT. CL. 3.
- CRACKLE CREATIONS, INC., STOUGHTON, MA:
2,534,049, PUB. 11-6-2001. INT. CL. 9.
- CRAFT BILLFOLD CORP., NEW YORK, NY:
1,866,378, CANC. INT. CL. 18.
- CRAFTY'S FEATHERWORKS, INC., OVERTON, NV:
2,534,278, PUB. 11-6-2001. INT. CL. 28.
- CRANE CO., LTD., OKAYAMA, JAPAN:
1,866,490, CANC. INT. CL. 28.
- CREATIVE DATA SERVICES, INC., EARTH CITY, MO:
1,143,000, CANC. INT. CL. 42.
- CREATIVE MENUS, INC., CHICAGO, IL, DBA CREATIVE PRINTING COMPANY:
1,866,064, CANC. INT. CL. 42.
- CREATIVE PET PRODUCTS, INC., WAYZATA, MN:
2,534,639, INT. CL. 5.
- CREATIVE POINT, INC., FREMONT, CA:
1,625,815, CANC. INT. CL. 9.
- CREATIVE SOLUTIONS INTERNATIONAL, INC., HOCKESSIN, DE:
2,533,870, PUB. 11-6-2001. MULTIPLE CLASS, INT. CLS. 35 AND 42.
- CREDIT-BASED ASSET SERVICING AND SECURITIZATION LLC, NEW YORK, NY:
2,533,273, PUB. 11-6-2001. INT. CL. 36.
- CREDITGUARD CORPORATION, HAMDEN, CT:
2,533,487, PUB. 11-6-2001. INT. CL. 36.
- CREIGHTON UNIVERSITY, OMAHA, NE:
2,534,735, INT. CL. 41.
- CROSSPOINT CORPORATION, WOODSIDE, CA:
2,533,223, PUB. 11-6-2001. MULTIPLE CLASS, INT. CLS. 35, 36 AND 42.
- CROWN HOLDINGS, INC., CHICAGO, IL:
1,865,923, CANC. INT. CL. 33.
- CROWN NATURAL MEATS, CANTON, SD:
1,865,890, CANC. INT. CL. 29.
- CRS HOLDINGS, INC., WILMINGTON, DE, CARPENTER STEEL COMPANY, THE, READING, PA:
718,821. REN. 12-18-01. U.S. CL. 14 (INT. CL. 6).
719,874. REN. 12-18-01. U.S. CL. 14 (INT. CL. 6).
- CRUME, RICK, GLYNDON, MN:
2,534,641, INT. CL. 9.
- CRYSTAL DYNAMICS, INC., MENLO PARK, CA:
2,534,478, INT. CL. 9.
- CSI - CARR SERVICES, INC., CUMMING, GA:
2,534,118, PUB. 11-6-2001. INT. CL. 36.
- CSX TRANSPORTATION, INC., JACKSONVILLE, FL:
2,533,679, PUB. 11-6-2001. INT. CL. 39.

- CTI INDUSTRIES CORPORATION, BARRINGTON, IL:
1,626,116, CANC. INT. CL. 28.
- CTR PAYROLL COMPANY, WARRENDALE, PA:
2,533,543, PUB. 11-6-2001. INT. CL. 42.
- CUBICON CORPORATION, ST. LOUIS, MO:
2,533,940, PUB. 11-6-2001. INT. CL. 20.
- CULINARY AMUSEMENTS, INC., LINCOLN, MA:
2,534,592, INT. CL. 42.
- CULLIGAN INTERNATIONAL COMPANY, NORTH-
BROOK, IL:
1,841,280, CANC. INT. CL. 11.
2,533,772, PUB. 11-6-2001. INT. CL. 35.
- CULVER STAFFING RESOURCES, SAN DIEGO, CA:
2,534,837, INT. CL. 35.
- CUMBERLAND FARMS, INC., CANTON, MA:
1,865,997, CANC. INT. CL. 39.
- CUMBERLAND PACKING CORP., BROOKLYN, NY:
2,534,030, PUB. 11-6-2001. INT. CL. 29.
- CUMMINGS, URBAN, PALO ALTO, CA:
1,665,896, REN. 12-19-01. INT. CL. 25.
- CURANT COMMUNICATIONS, INC., LOS ANGELES, CA:
1,673,701, REN. 12-17-01. INT. CL. 41.
- CURB-TOP CO., CYNTHIANA, KY:
2,533,927, PUB. 11-6-2001. INT. CL. 22.
- CURTIS MANUFACTURING COMPANY, INC., JAFFREY,
NH:
1,865,636, CANC. INT. CL. 9.
- CURTIS 1000, INC., ATLANTA, GA:
2,534,618, INT. CL. 35.
- CURWOOD, INC., OSHKOSH, WI, HARGRO LAMCOTE,
INC., CHICAGO, IL:
1,659,405, REN. 12-17-01. INT. CL. 5.
- CUTTER & BUCK INC., SEATTLE, WA, JONES/RODOLFO
CORPORATION, SEATTLE, WA:
1,660,896, REN. 12-19-01. INT. CL. 25.
- CVC COMMUNICATIONS, INC., INDIANAPOLIS, IN:
1,866,122, CANC. MULTIPLE CLASS, INT. CLS. 35 AND
41.
- CVS VANGUARD, INC., SCARSDALE, NY, MELVILLE
SHOE CORPORATION, NEW YORK, NY:
919,941, REN. 12-18-01. U.S. CL. 101 (INT. CL. 35).
- CY DECOSSE INCORPORATED, MINNETONKA, MN:
1,866,362, CANC. INT. CL. 16.
- CYBERIA COMMUNICATIONS, INC., YORK, PA:
1,866,609, CANC. INT. CL. 42.
- CYBERSAFE CORPORATION, ISSAQUAH, WA:
2,534,162, PUB. 11-6-2001. INT. CL. 9.
- CYNOCOM CORPORATION, BOCA RATON, FL:
2,533,489, PUB. 11-6-2001. INT. CL. 42.
- CYPRESS MEDIA, LLC, SAN JOSE, CA:
2,533,330, PUB. 11-6-2001. INT. CL. 35.
- CYTEC TECHNOLOGY CORP., WILMINGTON, DE, AMER-
ICAN CYANAMID COMPANY, WAYNE, NJ:
1,704,034, REN. 12-17-01. INT. CL. 1.
- CYTYC CORPORATION, BOXBOROUGH, MA:
1,706,095, REN. 12-16-01. INT. CL. 1.
- D & I PRODUCTS, INC., HOBOKEN, NJ:
1,866,393, CANC. INT. CL. 21.
- D.J. DOTSON, HIGHLAND PARK, IL:
1,865,918, CANC. INT. CL. 32.
- D.L. MAHER COMPANY, NORTH READING, MA:
1,626,386, CANC. INT. CL. 42.
- DADE MICROSCAN INC., WEST SACRAMENTO, CA:
2,533,967, PUB. 11-6-2001. MULTIPLE CLASS, INT. CLS.
5, 9, 10 AND 16.
- DAHMEN, ANGELA M., HUNTINGTON BEACH, CA, DBA
LADY 'N WAITING:
1,866,065, CANC. INT. CL. 42.
- DAIICHI PHARMACEUTICAL CO., LTD., TOKYO, JAPAN:
1,865,555, CANC. INT. CL. 5.
- DAIMLER CHRYSLER CORPORATION, AUBURN HILLS,
MI, CHRYSLER CORPORATION, HIGHLAND PARK, MI:
722,175, REN. 12-17-01. U.S. CL. 19 (INT. CL. 12).
- DAIMLERCHRYSLER RAIL SYSTEMS GMBH, 13627 BER-
LIN, FED REP GERMANY:
2,442,208, COR. MULTIPLE CLASS, INT. CLS. 7, 9, 12, 16,
37 AND 39.
- DAIRY DELITE OF COLORADO, INC., LOVELAND, CO:
1,188,853, REN. 12-15-01. INT. CL. 30.
- DAKA DEVELOPMENT LTD., KOWLOON, HONG KONG,
CHINA:
2,534,893, INT. CL. 9.
- DAKA, INC., DANVERS, MA:
1,866,052, CANC. INT. CL. 42.
- DAKOTA JACKSON, INC., NEW YORK, NY:
1,715,800, REN. 12-18-01. INT. CL. 20.
- DALLAPE, DONALD A., SANTA ANA, CA FROM LAGUNA
APPAREL, INC., SANTA ANA, CA:
2,533,485, PUB. 11-6-2001. INT. CL. 25.
- DALUFE FOOD DISTRIBUTOR, INC., MIAMI, FL:
2,534,846, INT. CL. 30.
- DALY.COMMERCE, INC., PROVIDENCE, RI:
2,534,515, INT. CL. 9.
2,534,517, INT. CL. 9.
- DAMEL, S.A., ELCHE (ALICANTE), SPAIN:
1,142,764, CANC. INT. CL. 30.
- DAMIRUS CORPORATION, THE, BURLINGTON, MA:
1,865,645, CANC. INT. CL. 9.
1,865,646, CANC. INT. CL. 9.
- DAMRON CORPORATION, CHICAGO, IL:
1,659,944, REN. 12-18-01. INT. CL. 30.
- DANA DESIGN, LTD., BOZEMAN, MT:
2,534,350, INT. CL. 22.
- DANCA, PHILIP C., ADDISON, IL:
1,866,394, CANC. INT. CL. 21.
- DANEK MEDICAL, INC., MEMPHIS, TN:
1,866,309, CANC. INT. CL. 10.
- DANIELS EQUIPMENT, INC., AUBURN, NH, DBA COST
LESS PARTS:
2,534,994, INT. CL. 37.
- DANIELSON COMPANY, INC., THE, AUBURN, WA:
2,534,848, INT. CL. 28.
- DANISH RE (BERMUDA) LTD., HAMILTON, BERMUDA:
2,533,492, PUB. 10-31-2000. INT. CL. 36.
- DANNON COMPANY, INC., THE, TARRYTOWN, NY:
2,533,849, PUB. 11-6-2001. INT. CL. 29.
2,533,850, PUB. 11-6-2001. INT. CL. 29.
2,533,851, PUB. 11-6-2001. INT. CL. 29.
- DARBY DENTAL SUPPLY CO., INC., WESTBURY, NY:
2,534,750, INT. CL. 10.
- DATA SYSTEMS & MAPPING, INC., WILLOWBROOK, IL:
1,866,265, CANC. INT. CL. 9.
- DATA-CONNECTION, INC., IRVINE, CA:
1,865,668, CANC. INT. CL. 9.
- DATABASE SPECIALISTS, INC., SAN FRANCISCO, CA:
2,533,343, PUB. 11-6-2001. INT. CL. 42.
- DATALODE INC., WOODACRE, CA:
2,533,354, PUB. 11-6-2001. INT. CL. 9.
- DATATRAC INFORMATION SERVICES, INC., RICHARD-
SON, TX:
2,446,088, AM. MULTIPLE CLASS, INT. CLS. 35, 37, 41
AND 42.
- DATAWARE TECHNOLOGIES, INC., CAMBRIDGE, MA:
1,626,464, CANC. INT. CL. 9.
1,626,465, CANC. INT. CL. 9.
- DAVID L. HOWARD, INC., SHELBYVILLE, TN:
1,625,967, CANC. INT. CL. 16.
- DAWE'S, L.L.C., ARLINGTON HEIGHTS, IL, DAWE'S
LABORATORIES, INC., CHICAGO, IL:
725,840, REN. 12-18-01. U.S. CL. 18 (INT. CL. 5).
- DAZEY PRODUCTS COMPANY, INDUSTRIAL AIRPORT,
KS:
1,142,615, CANC. INT. CL. 22.
- DBS, INC., RANDOLPH, MA:
1,142,329, CANC. INT. CL. 9.
- DE FORREST; DAVID, RED BANK, NJ:
1,142,466, CANC. MULTIPLE CLASS, INT. CLS. 15, 37
AND 42.
- DE FRANCESCO & SONS, INC., FIREBAUGH, CA:
2,533,921, PUB. 11-6-2001. INT. CL. 29.
- DE LALUT MARKETING CORP., BLOOMINGDALE, NJ:
1,865,541, CANC. INT. CL. 5.
- DE VECCHI S.P.A., 72 COGNENTO (MO), ITALY:
1,866,422, CANC. INT. CL. 25.

- DEALS-NOTHING OVER A DOLLAR, LLC, BRIDGETON, MO TO GRAMEX CORPORATION, BRIDGETON, MO: 2,492,003, CANC. INT. CL. 35.
- DEAN CHILDERS; JACK STRELIOFF AND RALPH PIEPLENBOS PARTNERSHIP, THE:
See—CLICKSPIN.COM LLC.
- DEANO'S INC., KIRKLAND, WA: 1,866,464, CANC. INT. CL. 25.
- DEANO'S, INC., KIRKLAND, WA: 1,866,275, CANC. INT. CL. 9.
- DECISION RESOURCES, INC., WALTHAM, MA: 1,689,007, REN. 12-17-01. INT. CL. 16.
- DECK TECHS, INC., CINCINNATI, OH: 2,534,038, PUB. 11-6-2001. MULTIPLE CLASS, INT. CLS. 2, 3 AND 37.
- DECTRON INC., ST-LAURENT, QUEBEC, CANADA: 1,173,094, REN. 12-20-01. INT. CL. 11.
- DEEMS, INC., PHOENIX, AZ: 2,533,823, PUB. 11-6-2001. INT. CL. 35.
- DEL MAR AVIONICS, IRVINE, CA: 2,533,390, PUB. 11-6-2001. INT. CL. 9.
- DEL MONTE CORPORATION, SAN FRANCISCO, CA: 2,534,677, INT. CL. 29.
- DEL MONTE FRESH PRODUCE B.V, CORAL GABLES, FL: 2,533,502, PUB. 11-6-2001. INT. CL. 42.
- DEL-NAT TIRE CORPORATION, MEMPHIS, TN: 2,534,709, INT. CL. 12.
- DELAWARE CAPITAL FORMATION, INC., WILMINGTON, DE, SWF MACHINERY, INC., SANGER, CA: 1,163,453, REN. 12-19-01. INT. CL. 7.
1,165,261, REN. 12-20-01. INT. CL. 7.
- DELAWARE CAPITAL FORMATION, INC., WILMINGTON, DE: 2,533,216, PUB. 11-6-2001. INT. CL. 36.
- DELAWARE LICENSING CORP., WILMINGTON, DE, INSTITUTE FOR SCIENTIFIC INFORMATION, INC., PHILADELPHIA, PA: 1,158,329, REN. 12-17-01. INT. CL. 35.
- DELAWARE MANAGEMENT HOLDINGS, INC., WILMINGTON, DE: 1,626,270, CANC. INT. CL. 36.
- DELCAN GROUP INC., NORTH YORK, ONTARIO M3C 1K1, CANADA: 1,865,619, CANC. INT. CL. 9.
- DELICHEM, INC., WILMINGTON, DE: 1,188,649, REN. 12-19-01. INT. CL. 17.
- DELIVEREX ACQUISITION CORP., SAN JOSE, CA, DELIVEREX, INCORPORATED, SAN JOSE, CA: 1,172,589, REN. 12-16-01. INT. CL. 39.
- DELL COMPUTER CORPORATION, ROUND ROCK, TX: 2,535,122, INT. CL. 42.
- DELONG SPORTSWEAR, INC., GRINNELL, IA: 1,658,286, REN. 12-17-01. INT. CL. 25.
- DEMARS, ROBERT A., WOODLAND HILLS, CA AND PETERSON, CHRISTOPHER G., VENTURA, CA: 2,534,440, INT. CL. 16.
- DEMILLE RESEARCH, INC., LAKE FOREST, CA: 2,534,340, PUB. 11-6-2001. MULTIPLE CLASS, INT. CLS. 9 AND 42.
- DENHARCO INC., ST. HYACINTHE, QUEBEC, CANADA: 2,533,480, PUB. 11-6-2001. INT. CL. 35.
- DENSIMIX, INC., HOUSTON, TX: 1,866,158, CANC. INT. CL. 2.
- DENTBUSTERS, ADDISON, IL: 2,533,189, CON. USE, PUB. 6-20-2000. INT. CL. 37.
- DENTCO, INC., HUMACAO, PUERTO RICO: 2,534,209, PUB. 11-6-2001. INT. CL. 3.
- DENTSPLY INTERNATIONAL INC., YORK, PA: 2,534,059, PUB. 11-6-2001. INT. CL. 10.
- DENTSPLY RESEARCH & DEVELOPMENT CORP., LOS ANGELES, CA, L. D. CAULK COMPANY, THE, MILFORD, DE: 548,763, REN. 12-21-01. U.S. CL. 6 (INT. CL. 1).
- DENTSPLY RESEARCH AND DEVELOPMENT CORP., LOS ANGELES, CA, DENTSPLY INTERNATIONAL INC., YORK, PA: 1,659,380, REN. 12-20-01. INT. CL. 5.
- DEPAUL UNIVERSITY, CHICAGO, IL: 2,534,621, MULTIPLE CLASS, INT. CLS. 16, 24, 25 AND 41.
- DERIVUM CAPITAL, L.L.C., SAN FRANCISCO, CA FROM FIRST SECURITY CAPITAL, L.L.C., SAN FRANCISCO, CA: 2,534,645, INT. CL. 36.
- DERMOFARM, S.A., 08025 BARCELONA, SPAIN: 2,534,442, INT. CL. 3.
- DESIGN-BUILD INSTITUTE OF AMERICA, WASHINGTON, DC: 2,534,288, PUB. 11-6-2001. MULTIPLE CLASS, INT. CLS. 16, 41 AND 42.
2,534,289, PUB. 11-6-2001. MULTIPLE CLASS, INT. CLS. 16, 41 AND 42.
- DETROIT AUTOBODY EQUIPMENT, INC., TROY, MI: 1,142,247, CANC. INT. CL. 7.
- DETTSON INDUSTRIES, INC., SHERBROOKE, QUEBEC, CANADA: 1,142,262, CANC. INT. CL. 7.
- DEUTSCHE BANK A.G., FRANKFURT AM MAIN 1, FED REP GERMANY: 1,179,478, REN. 12-20-01. INT. CL. 36.
- DEUTSCHE GRAMMOPHON GESELLSCHAFT MBH, HAMBURG D-20148, FED REP GERMANY, DEUTSCHE GRAMMOPHON GESELLSCHAFT MBH, HAMBURG, FED REP GERMANY: 1,662,293, REN. 12-19-01. INT. CL. 9.
- DEVILBISS AIR POWER COMPANY, JACKSON, TN: 2,534,772, INT. CL. 7.
- DEWITT BROTHERS TOOL CO., INC., NEW YORK, NY: 1,662,215, REN. 12-18-01. INT. CL. 8.
- DFG FOODS, L.L.C., OKLAHOMA CITY, OK: 2,534,560, MULTIPLE CLASS, INT. CLS. 29 AND 30.
2,534,561, MULTIPLE CLASS, INT. CLS. 29 AND 30.
- DI FILIPPO, ANTONIO, FIRENZE, ITALY: 1,158,091, REN. 12-18-01. INT. CL. 18.
- DIAL CORP, THE, PHOENIX, AZ: 1,626,285, CANC. MULTIPLE CLASS, INT. CLS. 36 AND 37.
- DIAMOND V MILLS, INC., CEDAR RAPIDS, IA: 2,533,462, PUB. 11-6-2001. INT. CL. 5.
- DIAZ, RAFAEL, HIALEAH, FL: 2,533,500, PUB. 11-6-2001. INT. CL. 30.
- DICKEY-JOHN CORPORATION, AUBURN, IL, DICKEY-JOHN CORPORATION, AUBURN, IL: 923,503, REN. 12-16-01. U.S. CL. 26 (INT. CL. 9).
- DICTAPHONE CORPORATION, STRATFORD, CT: 2,534,658, INT. CL. 9.
2,534,659, INT. CL. 9.
- DIEDRICH COFFEE, INC., IRVINE, CA: 2,535,004, INT. CL. 30.
- DIEPHARMEX, CH-1207 GENEVE, SWITZERLAND: 2,533,830, PUB. 11-6-2001. INT. CL. 5.
- DIGITAL DOMAIN, INC., VENICE, CA: 2,534,088, PUB. 11-6-2001. INT. CL. 25.
2,534,100, PUB. 11-6-2001. INT. CL. 25.
- DIGITAL ONLINE TECHNOLOGIES, INC., WILMETTE, IL: 2,534,336, PUB. 11-6-2001. INT. CL. 42.
- DIGITALEPC.COM, INC., TULSA, OK: 2,533,569, PUB. 11-6-2001. INT. CL. 35.
- DIGITALEVE, SEATTLE, WA: 2,534,161, PUB. 11-6-2001. INT. CL. 42.
- DIMENGO, MARIA, CLEARWATER, FL: 2,535,015, INT. CL. 42.
- DIMENSIONS ACQUISITION LLC, READING, PA, SUNSET DESIGNS, INC., SAN RAMON, CA: 1,174,296, REN. 12-21-01. INT. CL. 24.
- DIPLOMAT JUVENILE CORPORATION, STONY POINT, NY: 1,866,347, CANC. INT. CL. 16.
- DIRECT MARKETING DE SANTA FE, RIO RANCHO, NM: 1,866,605, CANC. INT. CL. 42.
- DISTINCTIVE APPLIANCES, INC., PASADENA, CA, DBA DACOR: 2,533,596, PUB. 11-6-2001. INT. CL. 11.

- DISTINCTIVE DESIGNS INTERNATIONAL, INC., RUSSELLVILLE, AL:
2,533,789, PUB. 9-25-2001. MULTIPLE CLASS, INT. CLS. 26 AND 31.
- DITTO, FRANK ROBERT, SAN FRANCISCO, CA:
2,533,281, PUB. 11-6-2001. INT. CL. 31.
- DIVETTA ENTERPRISES, INC., NEW YORK, NY:
1,175,540. REN. 12-19-01. INT. CL. 42.
- DIVORCEINTERACTIVE.COM, INC., SMITHTOWN, NY:
2,535,125, INT. CL. 42.
- DIXIE USA, INC., HOUSTON, TX:
1,625,597, CANC. INT. CL. 5.
- DNA (HOUSEMARKS) LIMITED, LONDON SW1P 1BX, ENGLAND:
2,534,829, INT. CL. 28.
- DOCUMENT AUTHENTICATION SYSTEMS, INC., BALTIMORE, MD:
2,534,991, MULTIPLE CLASS, INT. CLS. 9, 38 AND 39.
- DODGE CITY STEAK COMPANY, L.L.C., DODGE CITY, KS:
2,534,720, INT. CL. 29.
- DOLLAR GENERAL INTELLECTUAL PROPERTY, L.P., BURLINGTON, VT:
2,534,603, INT. CL. 35.
- DOLLAR PARADISE, INC., MIAMI BEACH, FL:
2,533,598, PUB. 11-6-2001. INT. CL. 35.
- DOMINGUEZ, JOSEPH D., SANTA BARBARA, CA:
1,865,839, CANC. INT. CL. 25.
- DOMINION RESOURCES, INC., RICHMOND, VA:
2,533,493, PUB. 11-6-2001. MULTIPLE CLASS, INT. CLS. 37, 39, 40 AND 42.
2,533,693, PUB. 11-6-2001. INT. CL. 42.
- DOMO GASOLINE CORPORATION LTD., MANITOBA, R3C 1E5, CANADA:
1,866,044, CANC. INT. CL. 42.
- DONALD J PLINER CONCEPTS, INC., MIAMI BEACH, FL:
2,534,444, INT. CL. 25.
- DONALEX CORPORATION, LAGUNA HILLS, CA:
2,534,614, INT. CL. 5.
- DONOHUE INC., QUEBEC, CANADA:
1,142,493, CANC. MULTIPLE CLASS, INT. CLS. 16 AND 19.
- DONSUEMOR, INC., EMERYVILLE, CA:
2,533,342, PUB. 11-6-2001. INT. CL. 30.
- DORMAIER, CHRISTINE G., SEATTLE, WA:
2,534,855, INT. CL. 41.
- DOTMED.COM, INC., NEW YORK, NY:
2,533,361, PUB. 11-6-2001. MULTIPLE CLASS, INT. CLS. 9, 10, 35 AND 38.
- DOTRONIX, INC., NEW BRIGHTON, MN:
1,659,554. REN. 12-19-01. INT. CL. 9.
- DOUBLE-COLA CO.-USA, CHATTANOOGA, TN:
1,142,797, CANC. INT. CL. 32.
- DOUBLETWIST, INC., OAKLAND, CA:
2,534,856, INT. CL. 9.
- DOUGLAS C. SMITH SURVIVOR'S TRUST, THE, LOVELOCK, NV, TWO STIFFS COMPANY, RENO, NV:
904,028. REN. 12-20-01. U.S. CL. 100 (INT. CL. 42).
- DOUGLASS, ANDREW IAN, BOSTON, MA:
2,534,698, INT. CL. 42.
- DOVER DOWNS ENTERTAINMENT, INC., WASHINGTON, DE, DOVER DOWNS, INC., WILMINGTON, DE:
1,705,113. REN. 12-21-01. INT. CL. 25.
- DOVER DOWNS ENTERTAINMENT, INC., WILMINGTON, DE, DOVER DOWNS, INC., WILMINGTON, DE:
1,708,300. REN. 12-21-01. INT. CL. 25.
- DOVER FINDINGS INC., ST. JAMES, NY:
1,142,461, CANC. INT. CL. 14.
- DOW CHEMICAL COMPANY, THE, MIDLAND, MI:
707,952, CANC. U.S. CL. 6.
- DOW INDUSTRIES, INC., WILMINGTON, MA:
2,534,387, INT. CL. 42.
- DOW JONES & COMPANY, INC., NEW YORK, NY:
1,626,474, CANC. INT. CL. 16.
- DOX ELECTRONICS INC., ROCHESTER, NY:
2,533,433, PUB. 11-6-2001. INT. CL. 41.
- DR.-ING. RUDOLF HELL GMBH, KIEL, FED REP GERMANY:
708,026, CANC. U.S. CL. 21.
- DRAKE DESIGNS, INC., BLOWING ROCK, NC:
2,533,368, PUB. 11-6-2001. INT. CL. 14.
- DRAXIS PHARMA INC., KIRKLAND, QUEBEC, CANADA:
2,533,250, PUB. 11-6-2001. MULTIPLE CLASS, INT. CLS. 35, 39, 40 AND 42.
- DRAZGA, EDWARD A., CHERRY HILL, NJ:
1,659,365. REN. 12-21-01. INT. CL. 3.
- DREXEL CHEMICAL COMPANY, MEMPHIS, TN:
1,142,199, CANC. INT. CL. 5.
- DRISCOLL STRAWBERRY ASSOCIATES, INC., WATSONVILLE, CA:
1,174,443. REN. 12-20-01. INT. CL. 31.
1,659,992. REN. 12-21-01. INT. CL. 31.
- DROLL YANKEES, INC., FOSTER, RI:
1,173,317. REN. 12-18-01. INT. CL. 21.
- DROP SHIP EXPRESS, INC., LONG LAKE, MN:
2,534,185, PUB. 11-6-2001. INT. CL. 39.
- DRUDGE, ROBERT B, SALISBURY, MD:
2,534,970, INT. CL. 42.
- DRUMMOND COMPANY, INC., LAKELAND, FL:
1,660,099. REN. 12-20-01. INT. CL. 37.
- DSI TOYS, HOUSTON, TX FROM MERITUS INDUSTRIES, INC., FAIRFIELD, NJ:
2,534,523, INT. CL. 28.
- DTMC, INC., FRANKLIN PARK, IL, W. B. RODDENBERY CO., INC., CAIRO, GA:
721,412. REN. 12-19-01. U.S. CL. 46 (INT. CLS. 1, 5, 29, 30, 31 AND 32).
- DUCANE GAS GRILLS, INC., COLUMBIA, SC, DUCANE COMPANY, INC., THE, COLUMBIA, SC:
1,660,721. REN. 12-20-01. INT. CL. 11.
- DUCOLON, BRUCE E., MIAMIVILLE, OH, DBA JUST A MAILBOX:
2,534,674, INT. CL. 6.
- DUNDON, ELAINE, TORONTO ONTARIO, CANADA:
2,533,470, PUB. 11-6-2001. INT. CL. 35.
- DUNHILL TOBACCO OF LONDON LIMITED, DENHAM, UXBRIDGE, MIDDLESEX UB9 5BL, ENGLAND:
920,066. REN. 12-19-01. U.S. CL. 17 (INT. CL. 34).
- DUPHAR B.V., AMSTERDAM, NETHERLANDS:
707,999, CANC. U.S. CL. 18.
- DURVET, INC., BLUE SPRINGS, MO:
2,534,532, INT. CL. 5.
- DYNACRAFT INDUSTRIES INC., ENGLISHTOWN, NJ:
2,534,008, PUB. 11-6-2001. INT. CL. 3.
- E. I. DU PONT DE NEMOURS AND COMPANY, WILMINGTON, DE:
1,866,179, CANC. INT. CL. 5.
1,866,406, CANC. INT. CL. 24.
2,534,769, INT. CL. 27.
- E. L. KING & ASSOCIATES, INC, DES MOINES, IA:
1,866,628, CANC. INT. CL. 16.
- E.L.V.H., INC., BURBANK, CA:
2,534,131, PUB. 11-6-2001. INT. CL. 15.
- E! ENTERTAINMENT TELEVISION, INC., LOS ANGELES, CA:
2,534,409, INT. CL. 41.
- EAGLE RESEARCH, INC., SAN FRANCISCO, CA:
2,534,838, INT. CL. 9.
- EAGLEBROOK, INC., MATTESON, IL, EAGLEBROOK, INC., MATTESON, IL:
1,659,205. REN. 12-17-01. INT. CL. 1.
- EASTECH FLOW CONTROLS, INC., HACKENSACK, NJ, MCO EASTECH, INC., ATLANTIC HIGHLANDS, NJ:
1,656,140. REN. 12-20-01. INT. CL. 9.
- EASTERN PRESS, INC., BERKELEY, CA:
2,534,425, INT. CL. 42.
- EASTGATE HEALTH CARE CENTER, INC., CINCINNATI, OH:
2,533,244, PUB. 11-6-2001. INT. CL. 42.
- EASTMAN KODAK COMPANY, ROCHESTER, NY:
707,958, CANC. U.S. CL. 6.
1,865,659, CANC. INT. CL. 9.

- EATON AEROQUIP INC., CLEVELAND, OH, AEROQUIP CORPORATION, MAUMEE, OH:
551,042. REN. 12-20-01. U.S. CL. 35 (INT. CL. 17).
- EATON HYDRAULICS INC., CELEVELAND, OH, VICKERS INCORPORATED, DETROIT, MI:
551,076. REN. 12-17-01. U.S. CL. 13 (INT. CL. 7).
- EBELING & REUSS CO., PHILADELPHIA, PA:
708,087, CANC. U.S. CL. 30.
708,090, CANC. U.S. CL. 33.
- EBSCO INDUSTRIES, INC., BIRMINGHAM, AL:
2,534,472, INT. CL. 13.
- ECHO TOYS, LTD., TAI PO NT, HONG KONG:
2,534,824, INT. CL. 28.
- ECKART-WERKE STANDARD BRONZEPULVER-WERKE-CARL ECKART GMBH & CO., D-8510 FURTH/BAVARIA, FED REP GERMANY:
1,142,176, CANC. MULTIPLE CLASS, INT. CLS. 2 AND 6.
- ECO-LUBE CORPORATION, PALM BEACH GARDENS, FL:
2,534,936, INT. CL. 37.
- ECOSCIENCE CORPORATION, WORCESTER, MA:
1,866,188, CANC. INT. CL. 5.
- ECR PHARMACEUTICALS, RICHMOND, VA:
2,534,771, INT. CL. 5.
- EDDIE BAUER, INC., REDMOND, WA:
2,534,952, INT. CL. 21.
- EDGAR, PROCHAZKA, PRAHA 4, CZECH REPUBLIC:
2,534,374, INT. CL. 35.
- EDGE 21, INC., NEW YORK, NY:
2,534,758, INT. CL. 42.
- EDGEMATE, INC., ROARING SPRING, PA, WESTVACO CORPORATION, NEW YORK, NY:
922,166. REN. 12-21-01. U.S. CL. 12 (INT. CL. 19).
- EDITORIAL UNIVERS S.A., BUENOS AIRES, ARGENTINA:
383,295, CANC. U.S. CL. 38.
- EFFECTIVE MARKETING SYSTEM E.M.S. 2000 FITNESS-GERATE GMBH, 8900 AUGSBURG, FED REP GERMANY:
1,865,684, CANC. MULTIPLE CLASS, INT. CLS. 10, 28 AND 41.
- EISENBERG INTERNATIONAL SALES, LTD., OMAHA, NE:
1,142,792, CANC. INT. CL. 31.
- EKKO EIENDOM AS, 7434 TRONDHEIM, NORWAY:
2,534,204, PUB. 11-6-2001. INT. CL. 36.
- EKO SYSTEMS, INC., FAIRFAX, VA:
2,534,085, PUB. 11-6-2001. INT. CL. 9.
2,534,086, PUB. 11-6-2001. INT. CL. 9.
- EL GRECO INC., PORT WASHINGTON, NY:
1,142,664, CANC. INT. CL. 25.
- EL TORITO RESTAURANTS, INC., LONG BEACH, CA:
1,637,727. REN. 12-17-01. INT. CL. 30.
- ELDER MANUFACTURING COMPANY, INC, ST. LOUIS, MO:
2,535,008, INT. CL. 25.
- ELDER MANUFACTURING COMPANY, INC., ST. LOUIS, MO, MAURICES INCORPORATED, DULUTH, MN:
1,163,868. REN. 12-19-01. INT. CL. 25.
- ELECTRIC TRANSPORTATION COMPANY, LLC, THE, MONTECITO, CA:
2,534,197, PUB. 11-6-2001. INT. CL. 7.
- ELECTROGIG TECHNOLOGY B.V., AMSTERDAM, NETHERLANDS:
1,625,670, CANC. MULTIPLE CLASS, INT. CLS. 9, 16 AND 42.
- ELECTRONIC ARTS INC., REDWOOD CITY, CA:
2,534,851, INT. CL. 9.
- ELECTRONIC DATA SYSTEMS CORPORATION, PLANO, TX:
1,866,342, CANC. INT. CL. 16.
2,534,660, MULTIPLE CLASS, INT. CLS. 9, 16, 35, 38, 41 AND 42.
- ELECTRONIC TELE-COMMUNICATIONS, INC., WAUKESHA, WI:
1,625,707, CANC. INT. CL. 9.
- ELI'S CHEESECAKE COMPANY, THE, CHICAGO, IL FROM ELIMARC ASSOCIATES, INC., CHICAGO, IL:
2,534,558, INT. CL. 35.
- ELI'S CHEESECAKE COMPANY, THE, CHICAGO, IL:
2,534,743, INT. CL. 35.
- ELKIND+SWEET COMMUNICATIONS INC, SAN FRANCISCO, CA:
1,660,325. REN. 12-19-01. INT. CL. 9.
- ELLEDGE, ESTELLE WEBRE, HOUSTON, TX:
1,866,141, CANC. MULTIPLE CLASS, INT. CLS. 16, 25 AND 28.
- ELLIOT, CONRAD, PARK CITY, UT, DBA ESTATES WEST AND PETERSON, MARK, PARK CITY, UT, DBA ESTATES WEST:
2,533,544, PUB. 11-6-2001. INT. CL. 16.
- ELLIOTT, CRAIG, ASHEVILLE, NC:
2,533,863, PUB. 11-6-2001. INT. CL. 35.
- ELLMAN INTERNATIONAL, INC., HEWLETT, NY:
2,533,945, PUB. 11-6-2001. INT. CL. 10.
- ELVIS PRESLEY ENTERPRISES, INC., MEMPHIS, TN:
1,866,537, CANC. INT. CL. 32.
- EMERGING TECHNOLOGIES INC., LITTLE ROCK, AR:
1,865,623, CANC. INT. CL. 9.
- EMERSON ELECTRIC CO., ST. LOUIS, MO:
2,533,831, PUB. 11-6-2001. INT. CL. 7.
- EMPIRE CANDLE MANUFACTURING, LLC, KANSAS CITY, KS:
2,533,642, PUB. 11-6-2001. INT. CL. 4.
- EMPIRE ENTERPRISES, INC., SHELBYVILLE, TN:
1,142,525, CANC. INT. CL. 16.
1,142,526, CANC. INT. CL. 16.
- EMPIRE KOSHER POULTRY, INC., MIFFLINTOWN, PA:
1,142,748, CANC. INT. CL. 29.
1,142,749, CANC. INT. CL. 29.
- EMPLOYEE BENEFIT PLANS, INC., MINNEAPOLIS, MN:
1,866,562, CANC. INT. CL. 36.
- EMPLOYER SERVICES ASSURANCE COPORATION(ESAC), LITTLE ROCK, AR:
2,535,109, INT. CL. 42.
- EMPLOYERS TRUST, CINCINNATI, OH:
1,865,941, CANC. MULTIPLE CLASS, INT. CLS. 35 AND 36.
- EMSON RESEARCH, INC., STRATFORD, CT:
1,150,455. REN. 12-17-01. INT. CL. 21.
- ENCORA, LLC, RENO, NV:
2,534,773, INT. CL. 12.
- ENERGY EXPRESS, LTD., CHICAGO, IL:
1,866,032, CANC. INT. CL. 41.
- ENESCO GROUP, INC., ITASCA, IL FROM ENESCO CORPORATION, ITASCA, IL:
2,534,539, INT. CL. 16.
- ENEUTRAL, INC., ATLANTA, GA:
2,534,929, INT. CL. 42.
- ENSZ, MARIANNE, PRAIRIE VILLAGE, KS:
2,534,860, INT. CL. 16.
- ENTEK IRD INTERNATIONAL CORPORATION, MILFORD, OH:
2,534,696, INT. CL. 9.
- ENTERPRISE IG, INC., NEW YORK, NY:
2,535,081, INT. CL. 35.
- ENTERTAINMENT RESOURCE ASSOCIATES, INC., SEA BRIGHT, NJ:
1,665,007. REN. 12-17-01. INT. CL. 16.
- ENTERTAINMENT WEEKLY INC., NEW YORK, NY:
1,678,451. REN. 12-17-01. INT. CL. 16.
- ENTRE-NOUS FRAGRANCES LTD., VAN NUYS, CA:
1,865,514, CANC. INT. CL. 3.
- ENVIRONMENTAL LIGHTING CONCEPTS, INC., TAMPA, FL:
1,704,198, AM. INT. CL. 11.
- ENVIRONMENTAL TEST SYSTEMS, INC., ELKHART, IN:
2,534,101, PUB. 11-6-2001. INT. CL. 1.
- EO, INC., SANTA CLARA, CA:
1,866,299, CANC. INT. CL. 9.
- EORIGNAL, INC., BALTIMORE, MD FROM DOCUMENT AUTHENTICATION SYSTEMS, INC., BALTIMORE, MD:
2,534,432, MULTIPLE CLASS, INT. CLS. 9, 38 AND 39.
2,534,433, MULTIPLE CLASS, INT. CLS. 9, 38 AND 39.
2,534,434, MULTIPLE CLASS, INT. CLS. 9, 38 AND 39.
- EPAGOS, INC., AVENTURA, FL:
2,535,059, INT. CL. 42.

- EPISCOPAL MINISTRIES TO THE AGING, INC., SYKESVILLE, MD:
2,534,571, MULTIPLE CLASS, INT. CLS. 35 AND 42.
- EPIX, INC., LAKE MILLS, WI:
2,534,508, INT. CL. 28.
- EPO CAPITAL CORPORATION, WILKES BARRE, PA:
2,534,360, INT. CL. 36.
- EPOCH COMPANY LTD., TOKYO, JAPAN:
1,866,230, CANC. INT. CL. 9.
- EQUIPMENT SCIENCES, INC., NEWBURY PARK, CA:
1,714,822, CANC. MULTIPLE CLASS, INT. CLS. 1 AND 7.
- EQUISTAR CHEMICALS, LP, HOUSTON, TX, QUANTUM CHEMICAL CORPORATION, CINCINNATI, OH:
1,659,315, REN. 12-19-01. INT. CL. 1.
- ERMELLINI CONTRACTING LIMITED, TORONTO, ONTARIO, CANADA:
1,625,992, CANC. INT. CL. 19.
- ERNST & YOUNG U.S. LLP, NEW YORK, NY, ERNST & YOUNG U.S., NEW YORK, NY:
1,660,031, REN. 12-16-01. MULTIPLE CLASS, INT. CLS. 35 AND 36.
- ERNST EULENBURG LIMITED, LONDON, ENGLAND:
1,142,509, CANC. INT. CL. 16.
- ESCIENT, INC.:
See—OPENGLOBE, INC.
- ESCROW BANK USA, SALT LAKE CITY, UT:
2,535,079, INT. CL. 36.
- ESPE DENTAL AG, SEEFELD, FED REP GERMANY, ESPE FABRIK PHARMAZEUTISCHER PRAPARATE GMBH, SEEFELD, OBERBAYERN, FED REP GERMANY:
1,179,965, REN. 12-21-01. INT. CL. 10.
- ESPE DENTAL AG, SEEFELD, FED REP GERMANY, ESPE FABRIK PHARMAZEUTISCHER PRAPARATE GMBH & CO. KG, D-8031 SEEFELD, FED REP GERMANY:
1,659,381, REN. 12-20-01. INT. CL. 5.
- ESPE DENTAL AG, D 82229 SEEFELD, FED REP GERMANY:
2,533,268, PUB. 11-6-2001. MULTIPLE CLASS, INT. CLS. 5 AND 10.
- ESPN, INC., BRISTOL, CT:
2,533,984, PUB. 11-6-2001. INT. CL. 25.
2,533,985, PUB. 11-6-2001. INT. CL. 25.
2,534,222, PUB. 11-6-2001. INT. CL. 41.
- ESSELTE CORPORATION, GARDEN CITY, NY:
2,534,475, INT. CL. 16.
- ESTERHUIZEN, SEAN PETER, SEATTLE, WA:
1,865,629, CANC. INT. CL. 9.
- ETHOS MARKETING GROUP, INC., BOULDER, CO:
1,865,630, CANC. INT. CL. 9.
- ETI CANADA INC., NORTH BAY, ONTARIO, CANADA, ETI EXPLOSIVES TECHNOLOGIES INTERNATIONAL (CANADA) LTD., MISSISSAUGA, ONTARIO, CANADA:
1,639,673, REN. 12-21-01. INT. CL. 13.
- ETIME CAPTIAL, INC., SUNNYVALE, CA:
2,534,298, PUB. 11-6-2001. INT. CL. 36.
- ETTER, MATTHIAS, CH-6086 HASLIBERG REUTI, SWITZERLAND:
2,534,597, INT. CL. 28.
- ETW CORP., CLEVELAND, OH:
2,534,357, INT. CL. 20.
- EURAND MICROENCAPSULATION SA, CHIASSO, SWITZERLAND, EURAND S.P.A., CINISELLO BALSAMO, MILAN, ITALY:
924,111, REN. 12-20-01. U.S. CL. 18 (INT. CL. 5).
- EUREKA! INSTITUTE, INC., CINCINNATI, OH:
1,678,769, REN. 12-15-01. INT. CL. 35.
- EURO-AMERICAN BRANDS, LLC, PARAMUS, NJ:
2,533,584, PUB. 11-6-2001. INT. CL. 30.
- EVANGELICAL ALLIANCE MISSION, THE, WHEATON, IL:
2,534,066, PUB. 11-6-2001. INT. CL. 42.
- EVANS, KEVIN J., RENTON, WA:
1,866,574, CANC. INT. CL. 41.
- EVANS, SHANNON L., LAS VEGAS, NV AND GALE, LAWRENCE E., LAS VEGAS, NV:
2,533,506, PUB. 11-6-2001. MULTIPLE CLASS, INT. CLS. 36 AND 42.
- EVENTIDE INC., LITTLE FERRY, NJ:
1,142,342, CANC. INT. CL. 9.
- EVENTIVITY, INC., NEW YORK, NY:
2,534,203, PUB. 11-6-2001. INT. CL. 35.
- EVERGREEN AMERICA CORPORATION, TAIPEI, TAIWAN, EVERGREEN INTERNATIONAL (U.S.A.), JERSEY CITY, NJ:
1,630,356, REN. 12-20-01. INT. CL. 39.
- EVERGREEN INDUSTRIES.COM, EATONVILLE, WA:
2,534,725, INT. CL. 1.
- EVERGREEN INTERNATIONAL, INC., LEBANON, IN:
1,865,573, CANC. INT. CL. 7.
- EWING, WILLIAM D., TIVERTON, RI:
1,659,284, REN. 12-20-01. INT. CL. 35.
- EXECUTORS OF THE ESTATE OF OSCAR HAMMERSTEIN II, THE, NEW YORK, NY AND RODGERS FAMILY LLC, THE, NEW YORK, NY TO EXECUTORS OF THE ESTATE OF OSCAR HAMMERSTEIN II, THE, NEW YORK, NY AND RODGERS FAMILY LLC, THE, NEW YORK, NY:
2,441,501, COR. INT. CL. 28.
- EXECUTORS OF THE ESTATE OF OSCAR HAMMERSTEIN II, THE, NEW YORK, NY AND RODGERS FAMILY LLC, THE, NEW YORK, NY TO EXECUTORS OF THE ESTATE OF OSCAR HAMMERSTEIN II, THE, NEW YORK, NY AND RODGERS FAMILY LLC, THE, NEW YORK, NY:
2,476,317, COR. INT. CL. 9.
- EXPANDED TECHNOLOGIES CORP., KENOSHA, WI:
1,653,680, REN. 12-16-01. INT. CL. 20.
1,658,987, REN. 12-16-01. INT. CL. 20.
- EXPEDIA, INC., REDMOND, WA TO MICROSOFT CORPORATION, REDMOND, WA:
2,405,746, COR. INT. CL. 39.
- EXPLORATORIUM, THE, SAN FRANCISCO, CA, PALACE OF ARTS AND SCIENCE, THE, SAN FRANCISCO, CA:
936,318, REN. 12-17-01. U.S. CL. 107 (INT. CL. 41).
- EXTREME SPORTS, INC., VISTA, CA:
1,702,971, REN. 12-15-01. INT. CL. 9.
- EYESOFT SYSTEMS, INC., SAN DIEGO, CA, DBA EYECOM:
1,703,004, REN. 12-21-01. INT. CL. 9.
- EYEWONDER, INC., ATLANTA, GA:
2,534,119, PUB. 11-6-2001. INT. CL. 9.
- EZ-FLO INTERNATIONAL, INC., ONTARIO, CANADA, UNITED STATES BRASS CORPORATION, PLANO, TX:
1,179,985, REN. 12-20-01. INT. CL. 11.
- F. COUSTEAUX CO., INC., NEW ORLEANS, LA:
1,865,518, CANC. INT. CL. 3.
- F.B.P. INSURANCE SERVICES, INC., NEWPORT BEACH, CA:
2,533,576, PUB. 11-6-2001. INT. CL. 36.
- FABRENE INC., MISSISSAUGA, ONTARIO, CANADA:
1,866,367, CANC. INT. CL. 17.
- FABWEL, INC., ELKHART, IN:
1,625,980, CANC. INT. CL. 17.
- FACTS MANAGEMENT CO., LINCOLN, NE:
2,534,064, PUB. 11-6-2001. INT. CL. 35.
2,534,065, PUB. 11-6-2001. INT. CL. 9.
- FAGIEN, STEVEN, BOCA RATON, FL:
2,534,381, MULTIPLE CLASS, INT. CLS. 16 AND 41.
- FAHEY, PATRICK S., OMAHA, NE:
1,866,345, CANC. INT. CL. 16.
- FAIRMONT HOTELS & RESORTS (U.S.) INC., TORONTO, ONTARIO, CANADA, PRINCESS HOTELS INTERNATIONAL, INC., NEW YORK, NY:
1,173,718, REN. 12-19-01. INT. CL. 42.
- FAIRWAY SYSTEMS, INC., ENGLEWOOD, CO:
1,673,772, REN. 12-17-01. INT. CL. 42.
- FALSTROM COMPANY, PASSAIC, NJ:
1,142,330, CANC. INT. CL. 9.
- FANCY FEET, INC., OAK PARK, MI:
1,631,694, REN. 12-21-01. INT. CL. 25.
- FANCY PUBLICATIONS, INC., LOS ANGELES, CA:
1,754,657, CANC. INT. CL. 16.
- FARCA, EDUARDO COHEN, COLONIA GRANJAS MEXICO, MEXICO AND KAMAJI, ELIAS COHEN, COLONIA GRANJAS MEXICO, MEXICO:
2,533,309, PUB. 11-6-2001. MULTIPLE CLASS, INT. CLS. 24 AND 25.

- FARCA, EDUARDO COHEN, MEXICO, DISTRITO FEDERAL, C.P., MEXICO AND KAMAJI, ELIAS COHEN, MEXICO, DISTRITO FEDERAL, C.P., MEXICO:
2,533,322, PUB. 11-6-2001. MULTIPLE CLASS, INT. CLS. 24 AND 25.
- FARM PROGRESS COMPANIES, INC., CAROL STREAM, IL:
2,533,810, PUB. 11-6-2001. INT. CL. 35.
- FARMCO, INC., GREELEY, CO:
1,142,613, CANC. INT. CL. 22.
1,142,614, CANC. INT. CL. 22.
- FARMLAND INDUSTRIES, INC., KANSAS CITY, MO:
2,534,164, PUB. 11-6-2001. INT. CL. 30.
- FARNUM COMPANIES, INC, PHOENIX, AZ FROM HAPPY DOG TOYS, LLC, SCOTTSDALE, AZ:
2,534,777, INT. CL. 28.
- FASHION CARE LICENSING, INC., ATLANTA, GA, FASHION CARE, INC., ATLANTA, GA:
1,177,591, REN. 12-19-01. INT. CL. 37.
1,177,592, REN. 12-19-01. INT. CL. 37.
- FASHION CENTER DISTRICT MANAGEMENT ASSOCIATION, INC., NEW YORK, NY:
2,533,712, PUB. 11-6-2001. INT. CL. 36.
- FASTENERS FOR RETAIL, INC., CLEVELAND, OH, GERARD CONWAY AND COMPANY, INC., SHAKER HEIGHTS, OH, AKA FASTENERS FOR RETAIL:
1,189,736, REN. 12-17-01. INT. CL. 6.
- FASTENERS FOR RETAIL, INC., CLEVELAND, OH, GERARD CONWAY & COMPANY, INC., CLEVELAND, OH:
1,665,842, REN. 12-17-01. INT. CL. 16.
- FASTEST, INC., ST. PAUL, MN:
1,659,428, REN. 12-17-01. INT. CL. 6.
- FATBOY PRODUCTIONS, INC., NEW YORK, NY:
2,533,225, PUB. 11-6-2001. MULTIPLE CLASS, INT. CLS. 9 AND 41.
- FAUCET-QUEENS INC., THE, VERNON HILLS, IL, FAUCET-QUEENS, INC., THE, WHEELING, IL:
921,822, REN. 12-19-01. U.S. CL. 13 (INT. CL. 11).
- FAULKNER EXPORT PACKAGING LIMITED, DUBLIN 20, IRELAND:
2,534,575, INT. CL. 16.
- FAVORITE MEMORIES, INC., EAGAN, MN:
1,865,764, CANC. INT. CL. 16.
- FEDERAL HOME LOAN MORTGAGE CORPORATION, MCLEAN, VA:
2,534,126, PUB. 11-6-2001. INT. CL. 36.
- FEDERATED FOODS, INC., ARLINGTON HEIGHTS, IL:
1,142,755, CANC. INT. CL. 29.
- FEDERATED WESTERN PROPERTIES, INC., LAS VEGAS, NV:
2,534,007, PUB. 11-6-2001. INT. CL. 35.
- FEEDER ENTERPRISES, INC., HOUSTON, TX:
1,876,682, CANC. INT. CL. 21.
- FEHLING MEDICAL AG, D-8757 KARLSTEIN, FED REP GERMANY:
1,865,529, CANC. INT. CL. 5.
- FEI COMPANY, HILLSBORO, OR:
2,534,668, INT. CL. 9.
- FERGUSON, LINDA J., ABINGDON, MD:
2,533,567, PUB. 11-6-2001. INT. CL. 35.
- FERMODYL PROFESSIONALS INC., NEW YORK, NY:
1,663,134, REN. 12-15-01. INT. CL. 3.
- FERRARA PAN CANDY CO., INC., FOREST PARK, IL:
1,866,533, CANC. INT. CL. 32.
- FERRING PHARMACEUTICALS INC., TARRYTOWN, NY:
1,660,257, REN. 12-20-01. INT. CL. 5.
- FFSC, INC., DALLAS, TX:
1,865,822, CANC. INT. CL. 21.
- FIBER INDUSTRIES, INC., SHREWSBURY, NJ, FIBER INDUSTRIES, INC., CHARLOTTE, NC:
1,180,254, REN. 12-21-01. INT. CL. 23.
- FIBER-RESIN CORP., ST. PAUL, MN, HEXCEL CORPORATION, SAN FRANCISCO, CA:
1,210,134, REN. 12-15-01. INT. CL. 1.
- FIDELITY UNION LIFE INSURANCE COMPANY, DALLAS, TX:
1,273,061, CANC. INT. CL. 36.
- FIESTA SPORTFISHING & DIVING CO., GILBERT, AZ:
1,865,998, CANC. INT. CL. 39.
- FIESTAS MARKET SQUARE, INC., SAN ANTONIO, TX:
2,533,952, PUB. 11-6-2001. INT. CL. 25.
- FIFIELD LAND COMPANY, BRAWLEY, CA:
2,534,163, PUB. 11-6-2001. INT. CL. 31.
- FILA FOOTWEAR U.S.A., INC., HUNT VALLEY, MD:
1,866,431, CANC. INT. CL. 25.
- FILATURA E TESSITURA DI TOLLEGNO S.P.A., TOLLEGNO (VERCELLI), ITALY:
1,172,341, REN. 12-18-01. MULTIPLE CLASS, INT. CLS. 23, 24 AND 25.
- FINAMARK, INC., PLANO, TX:
2,533,261, PUB. 11-6-2001. INT. CL. 4.
- FINLINSON, GARY, MESA, AZ:
2,533,996, PUB. 11-6-2001. INT. CL. 35.
- FINN, FREDERICK N., RICHMOND, VA AND ANDERS, W. WOODROW, JR., RICHMOND, VA:
1,866,022, CANC. INT. CL. 41.
- FINNEX AGENCIES LTD., BURNABY, BRITISH COLUMBIA, CANADA:
2,533,229, PUB. 11-6-2001. MULTIPLE CLASS, INT. CLS. 35 AND 37.
- FIRE KING INTERNATIONAL, INC., NEW ALBANY, IN, MURPHY MANUFACTURING COMPANY, NEW ALBANY, IN:
1,173,902, REN. 12-19-01. INT. CL. 6.
- FIREMAN'S FUND INSURANCE COMPANY, NOVATO, CA:
2,534,688, INT. CL. 36.
- FIRESIDE COFFEE COMPANY, INC., SWARTZ CREEK, MI:
2,534,103, PUB. 11-6-2001. INT. CL. 30.
- FIRST CHICAGO CORPORATION, CHICAGO, IL:
1,866,577, CANC. INT. CL. 41.
- FIRST CHOICE PET PRODUCTS, INC., MIAMI, FL:
2,533,958, PUB. 11-6-2001. INT. CL. 35.
- FISHER & PAYKEL LIMITED, AUCKLAND, NEW ZEALAND:
1,638,987, REN. 12-19-01. INT. CL. 10.
- FISHER - PRICE, INC., EAST AURORA, NY, FISHER - PRICE, INC., EAST AURORA, NY:
1,658,849, REN. 12-17-01. MULTIPLE CLASS, INT. CLS. 9, 11, 12, 16, 18, 20, 21, 24 AND 28.
- FIST, CHARLES S., SARDINIA, OH:
1,865,808, CANC. INT. CL. 20.
- FLA ORTHOPEDICS, INC., MIRAMAR, FL:
2,534,909, INT. CL. 10.
- FLANIGAN FURNITURE, INC., ROCHESTER, NY:
1,142,960, CANC. INT. CL. 42.
- FLAPJACK SHACK, INC., LANSING, MI:
1,183,296, REN. 12-15-01. INT. CL. 42.
- FLASH VOS, INC., HOUSTON, TX:
2,535,027, INT. CL. 9.
- FLAVOR DYNAMICS, INC., SOUTH PLAINFIELD, NJ:
2,533,581, PUB. 11-6-2001. INT. CL. 30.
- FLEET ENGINEERS, INC., MUSKEGON, MI:
2,533,627, PUB. 11-6-2001. INT. CL. 12.
- FLEET NATIONAL BANK, BOSTON, MA FROM SMITH & NOBLE, LLC, CORONA, CA:
2,534,871, INT. CL. 35.
- FLEETBOSTON FINANCIAL CORPORATION, BOSTON, MA:
2,534,056, PUB. 11-6-2001. INT. CL. 36.
- FLEETGUARD, INC., COLUMBUS, IN:
1,865,575, CANC. INT. CL. 7.
- FLEXSTEEL INDUSTRIES, INC., DUBUQUE, IA:
1,670,275, REN. 12-21-01. INT. CL. 20.
- FLINT INK CORPORATION, ANN ARBOR, MI:
2,533,293, PUB. 11-6-2001. MULTIPLE CLASS, INT. CLS. 40 AND 42.
- FLOMERICS LIMITED, SURREY KT8 9HH, UNITED KINGDOM:
1,660,694, REN. 12-15-01. INT. CL. 9.
- FLORIDA GOLF SCHOOL, INC., THE, FORT PIERCE, FL, DBA UNITED STATES GOLF TEACHERS FEDERATION:
2,533,919, PUB. 11-6-2001. MULTIPLE CLASS, INT. CLS. 41 AND 42.

- FLORIDA LAND ACQUISITION GROUP, INC., NORTH FORT MYERS, FL:
1,626,303, CANC. INT. CL. 37.
- FLORIDA TOMATO COMMITTEE, ORLANDO, FL:
2,533,580, PUB. 11-6-2001. INT. CL. 35.
- FLORISTS' TRANSWORLD DELIVERY, INC., DOWNERS GROVE, IL:
2,534,819, MULTIPLE CLASS, INT. CLS. 16 AND 42.
- FLOWER TRADING CORPORATION, MIAMI, FL:
1,866,527, CANC. INT. CL. 31.
- FLYNN, JIM, SAN DIEGO, CA AND FLYNN, JACK, SAN DIEGO, CA:
2,534,220, PUB. 11-6-2001. INT. CL. 28.
- FMC CORPORATION, PHILADELPHIA, PA:
708,075, CANC. U.S. CL. 23.
- FNS, INC., WENDOVER, KY:
2,534,027, PUB. 11-6-2001. INT. CL. 41.
- FOAMPRO MFG INC, IRVINE, CA:
2,534,931, INT. CL. 16.
- FOCAS, INC., ALPHARETTA, GA:
1,866,246, CANC. INT. CL. 9.
- FOCUS ON THE FAMILY, COLORADO SPRINGS, CO:
1,612,697, REN. 12-19-01. MULTIPLE CLASS, INT. CLS. 9, 16 AND 41.
- FOGO DE CHAO CHURRASCARIA (DALLAS) LLP, ADDISON, TX:
2,534,254, PUB. 11-6-2001. INT. CL. 42.
- FOLK, MICHAEL R., MEMPHIS, TN:
2,533,637, PUB. 11-6-2001. INT. CL. 40.
- FOLKMANIS, INC., EMERYVILLE, CA:
1,654,419, REN. 12-19-01. INT. CL. 28.
- FOODSCIENCE CORPORATION, ESSEX JUNCTION, VT:
2,533,296, PUB. 11-6-2001. INT. CL. 5.
- FOORMAN, LENORE S., OAKLAND, CA, DBA THE RIDER'S GUIDE AND FOORMAN, CARL T., OAKLAND, CA:
1,625,675, CANC. MULTIPLE CLASS, INT. CLS. 9 AND 16.
- FOOT LEVELERS, INC., ROANOKE, VA:
2,534,070, PUB. 11-6-2001. INT. CL. 10.
- FOOTE MINERAL COMPANY, EXTON, PA:
707,949, CANC. U.S. CL. 6.
- FOR SALE BY OWNER.COM CORP., NEW YORK, NY:
2,535,133, INT. CL. 36.
- FORE SUPPLY COMPANY, ADDISON, IL:
1,625,543, CANC. INT. CL. 3.
- FOREAMERICA, INC., WILLIAMSBURG, VA:
2,533,857, PUB. 11-6-2001. INT. CL. 41.
- FOREMOST FARMS USA, COOPERATIVE, BARABOO, WI, WISCONSIN DAIRIES COOPERATIVE, BARABOO, WI:
1,657,537, REN. 12-16-01. INT. CL. 29.
- FOREST MEDICAL PRODUCTS, INC., HILLSBORO, OR:
1,192,052, REN. 12-17-01. INT. CL. 10.
- FORT JAMES CORPORATION, RICHMOND, VA, JAMES RIVER CORPORATION OF VIRGINIA, NORWALK, CT:
1,658,946, REN. 12-15-01. INT. CL. 16.
- FORT JAMES OPERATING COMPANY, RICHMOND, VA:
2,534,398, INT. CL. 16.
- FORTITECH, INC., SCHENECTADY, NY:
2,533,247, PUB. 11-6-2001. INT. CL. 5.
2,534,110, PUB. 11-6-2001. INT. CL. 42.
- FORTNER SOFTWARE, L.L.C.:
See— RESEARCH SYSTEMS, INC.
- FOSECO INTERNATIONAL LIMITED, SWINDON, WILTSHIRE, ENGLAND:
1,162,357, REN. 12-19-01. INT. CL. 1.
- FOSTER & SMITH, INC., RHINELANDER, WI:
2,533,421, PUB. 11-6-2001. INT. CL. 16.
- FOTOTYPE, INCORPORATED, CHICAGO, IL:
708,103, CANC. U.S. CL. 37.
- FOUNDATION FOR ALTERNATIVE CANCER THERAPIES, LTD., NEW YORK, NY:
1,170,516, REN. 12-16-01. INT. CL. 35.
- FOUNDSTONE, INC., IRVINE, CA FROM RAMPART SECURITY GROUP, LLC, PARSIPPANY, NJ:
2,534,783, MULTIPLE CLASS, INT. CLS. 9, 41 AND 42.
- FOUR ACES, THE, WEST CHESTER, PA:
2,534,063, PUB. 11-6-2001. INT. CL. 41.
- FOX FAMILY PROPERTIES, INC., LOS ANGELES, CA:
2,533,767, PUB. 11-6-2001. INT. CL. 41.
- FOX POOL CORPORATION, YORK, PA:
1,807,538, COR. INT. CL. 19.
- FOX VALLEY TRAVEL AGENCY, INC., OSHKOSH, WI:
2,533,752, PUB. 11-6-2001. INT. CL. 39.
- FRAMPTON, PETER, LOS ANGELES, CA:
2,534,297, PUB. 11-6-2001. INT. CL. 41.
- FRANK LLOYD WRIGHT FOUNDATION, THE, SCOTTS-DALE, AZ:
1,660,236, REN. 12-20-01. INT. CL. 42.
- FRANK RUSSELL COMPANY, TACOMA, WA:
2,533,922, PUB. 11-6-2001. INT. CL. 41.
- FRANKLIN RESOURCES, INC., SAN MATEO, CA:
2,284,378, AM. INT. CL. 36.
- FRATERNITY OF PHI GAMMA DELTA, INC., THE, LEXINGTON, KY, FRATERNITY OF PHI GAMMA DELTA, THE, WASHINGTON, DC:
921,356, REN. 12-15-01. U.S. CL. 200.
921,357, REN. 12-16-01. U.S. CL. 200.
- FREDERICK ATKINS INC., NEW YORK, NY:
1,142,638, CANC. INT. CL. 25.
1,866,474, CANC. INT. CL. 25.
- FREDERICK WARNE & COMPANY, INC., NEW YORK, NY:
1,183,929, REN. 12-19-01. INT. CL. 28.
1,185,687, REN. 12-19-01. INT. CL. 15.
- FREEDOM COMMUNICATIONS, INC., IRVINE, CA:
2,533,709, PUB. 11-6-2001. MULTIPLE CLASS, INT. CLS. 16, 38 AND 41.
- FREERIDE MOTOX, LLC, LARCHMONT, NY:
2,533,883, PUB. 11-6-2001. INT. CL. 41.
- FREIGHT BROKERS INTERNATIONAL, FAR ROCK-AWAY, NY:
1,865,952, CANC. MULTIPLE CLASS, INT. CLS. 36 AND 39.
- FRESH SAMANTHA, INC., SACO, ME:
2,533,298, PUB. 11-6-2001. INT. CL. 32.
- FRESH START MARKETING, INC., CANTON, OH:
2,533,735, PUB. 11-6-2001. INT. CL. 1.
- FREUDIANA HOLDINGS LIMITED, LONDON, ENGLAND:
1,866,008, CANC. INT. CL. 41.
- FRIENDLY NUTRITIONALS, L.L.C, MESA, AZ:
2,533,976, PUB. 11-6-2001. INT. CL. 5.
- FRIENDSHIP AMBASSADORS FOUNDATION, WHITE PLAINS, NY:
2,533,336, PUB. 11-6-2001. MULTIPLE CLASS, INT. CLS. 35 AND 41.
- FRITZ EICHENAUER GMBH & CO. KG, KANDEK, PFALZ, FED REP GERMANY, FIRMA FRITZ EICHENAUER, D-6744 KANDEL, PFALZ, FED REP GERMANY:
1,175,926, REN. 12-17-01. INT. CL. 9.
- FUJITEC CO., LTD., IBARAKI-SHI, OSAKA, JAPAN:
1,128,824, REN. 12-18-01. INT. CL. 7.
- FUJITSU GENERAL AMERICA, INC., FAIRFIELD, NJ:
2,534,710, INT. CL. 9.
2,534,711, INT. CL. 9.
- FUJITSU LIMITED, NAKAHARA-KU, KAWASAKI, JAPAN:
1,865,597, CANC. INT. CL. 9.
- FUJITSU LIMITED, NAKAHARA-KU, KAWASAKI-SHI, KANAGAWA-KEN, JAPAN:
1,866,210, CANC. INT. CL. 9.
- FULLER COMPANY, BETHLEHEM, PA:
137,790, CANC. U.S. CL. 23.
- FUN PUBLICATIONS, INC., FORT WORTH, TX:
2,534,762, INT. CL. 28.
- FUTZ FILE & TOOL CO., CINCINNATI, OH:
2,533,196, PUB. 11-6-2001. INT. CL. 8.
- G. LEBLANC CORPORATION, KENOSHA, WI:
2,534,268, PUB. 11-6-2001. INT. CL. 15.
- G. LOOMIS, INC., WOODLAND, WA:
2,534,036, PUB. 11-6-2001. INT. CL. 28.
- G.L.B., 06333 GRASSE, FRANCE:
1,625,530, CANC. INT. CL. 3.
- GABOR SHOES AKTIENGESELLSCHAFT, 83024 ROSENHEIM, FED REP GERMANY, B. & J. GABOR, ROSENHEIM, FED REP GERMANY:
1,170,769, REN. 12-21-01. INT. CL. 25.

- GAGE MARKETING GROUP, MINNEAPOLIS, MN:
1,866,130, CANC. MULTIPLE CLASS, INT. CLS. 35 AND 42.
- GALAGEN INC., ARDEN HILLS, MN:
2,533,302, PUB. 11-6-2001. INT. CL. 5.
- GALE GROUP, INC., WINTER PARK, FL:
1,865,827, CANC. INT. CL. 21.
- GALLEGOS, ELIGIO STEPHEN, VELARDE, NM, DBA MOON BEAR PRESS:
1,625,938, CANC. INT. CL. 16.
- GAMEDAY SPORTS SHOP, INC., CARY, NC:
2,534,326, PUB. 11-6-2001. INT. CL. 35.
- GAMMA MEDIZINISCH-WISSENSCHAFTLICHE FOR-
TBILDUNGSGESELLSCHAFT M.B.H., A-3400 KLOSTER-
NEUBURG, AUSTRIA:
2,533,398, PUB. 11-6-2001. MULTIPLE CLASS, INT. CLS. 9
AND 42.
- GARAN ENTERPRISES, INC., CHICOPEE FALLS, MA, DBA
MILLIE'S PIEROGI:
2,533,577, PUB. 11-6-2001. MULTIPLE CLASS, INT. CLS.
29 AND 30.
- GARDEN OF LIFE, INC., PALM BEACH GARDENS, FL:
2,534,003, PUB. 11-6-2001. INT. CL. 5.
- GARDNER DENVER, INC., QUINCY, IL, WALLACE MUR-
RAY CORPORATION, NEW YORK, NY:
1,170,923, REN. 12-17-01. INT. CL. 7.
- GARITECH SYSTEMS INC., AUSTIN, TX:
2,533,274, PUB. 11-6-2001. INT. CL. 6.
- GATA BOX LIMITED, NEW YORK, NY:
1,142,702, CANC. INT. CL. 28.
- GATES-MILLS, INC., JOHNSTOWN, NY:
2,534,492, INT. CL. 25.
- GAY & LESBIAN YELLOW PAGES, INC., HOUSTON, TX:
1,866,630, CANC. INT. CL. 16.
- GAYLON, INC., ARDMORE, PA:
1,142,633, CANC. MULTIPLE CLASS, INT. CLS. 25, 37
AND 39.
- GAZTECH INTERNATIONAL CORPORATION, GOLETA,
CA:
1,866,238, CANC. INT. CL. 9.
- GEBR. OTTO KG, D-57223 KREUZTAL, FED REP GER-
MANY:
2,533,324, PUB. 11-6-2001. MULTIPLE CLASS, INT. CLS.
12 AND 21.
- GEIER, PAULA, CAMDENTON, MO:
2,534,622, INT. CL. 21.
- GELCO PAYMENT SYSTEMS, INC., EDINA, MN:
1,866,296, CANC. INT. CL. 9.
- GEM OFFICE PRODUCTS CO., LLC, MT. VERNON, NY:
2,533,924, PUB. 11-6-2001. INT. CL. 9.
- GEM-DANDY, INC., MADISON, NC:
1,866,419, CANC. INT. CL. 25.
- GEMINI INDUSTRIES, INC., CLIFTON, NJ:
1,866,619, CANC. INT. CL. 9.
- GEMOLOGICAL INSTITUTE OF AMERICA, INC., CARLS-
BAD, CA:
2,533,956, PUB. 11-6-2001. INT. CL. 42.
- GENERAL ELECTRIC COMPANY, FAIRFIELD, CT, FAUL-
KNER PLASTICS, INC., TAMPA, FL:
1,143,380, REN. 12-16-01. MULTIPLE CLASS, INT. CLS.
17, 19 AND 20.
- GENERAL FOODS CORPORATION, WHITE PLAINS, NY:
383,316, CANC. U.S. CL. 46.
- GENERAL GROWTH MANAGEMENT, INC., MINNEAPOLIS,
MN, DBA CENTER ADVERTISING AGENCY:
1,866,633, CANC. INT. CL. 35.
- GENERAL HEALTH, INC., BATON ROUGE, LA:
1,865,953, CANC. MULTIPLE CLASS, INT. CLS. 36, 41
AND 42.
- GENERAL HOST CORPORATION, STAMFORD, CT:
1,142,738, CANC. INT. CL. 29.
- GENERAL MILLS RESTAURANTS, INC., ORLANDO, FL:
1,865,777, CANC. INT. CL. 16.
- GENERAL MILLS, INC., MINNEAPOLIS, MN:
1,192,840, REN. 12-20-01. INT. CL. 30.
1,676,933, AM. INT. CL. 30.
1,681,353, REN. 12-21-01. INT. CL. 30.
2,534,177, PUB. 11-6-2001. INT. CL. 29.
2,534,798, INT. CL. 41.
- GENERAL MOTORS ACCEPTANCE CORPORATION, DE-
TROIT, MI:
2,535,128, INT. CL. 36.
- GENERAL RE CORPORATION, STAMFORD, CT:
2,534,813, INT. CL. 36.
- GENESCO INC., NASHVILLE, TN:
1,142,643, CANC. INT. CL. 25.
- GENESIS PHARMACEUTICAL, INC., MORRISTOWN, NJ:
2,533,982, PUB. 11-6-2001. INT. CL. 5.
- GENETIC EVOLUTIONARY NUTRITION, LLC, MARINA
DEL REY, CA:
2,534,982, INT. CL. 5.
- GENEVA STEEL COMPANY, PROVO, UT, BASIC MANU-
FACTURING AND TECHNOLOGIES OF UTAH, INC.,
PROVO, UT, DBA GENEVA STEEL:
1,618,411, REN. 12-20-01. INT. CL. 6.
- GENLYTE THOMAS GROUP LLC, LOUISVILLE, KY:
2,534,905, INT. CL. 11.
- GENTNER COMMUNICATIONS CORPORATION, SALT
LAKE CITY, UT:
2,535,116, INT. CL. 38.
- GENUITY INC., BURLINGTON, MA FROM GENUITY INC.,
SAN FRANCISCO, CA:
2,534,362, INT. CL. 42.
- GEORGE E MEHLMAUER, HEMET, CA, DBA 3BUSY-
GUYS.COM:
2,534,984, MULTIPLE CLASS, INT. CLS. 36 AND 37.
- GEORGE GALUSTIAN, CHATSWORTH, CA:
2,534,944, INT. CL. 41.
- GEORGE LEE LUTZ, LAS VEGAS, NV:
2,534,312, PUB. 11-6-2001. INT. CL. 16.
- GEORGE OTIS CO., VISTA, CA:
1,658,904, REN. 12-17-01. INT. CL. 10.
- GEORGE, PETER, WARWICK, RI:
1,866,552, CANC. INT. CL. 36.
- GEORGIA-PACIFIC CORPORATION, ATLANTA, GA, HUD-
SON PULP & PAPER CORP., DARIEN, CT:
1,172,215, REN. 12-15-01. INT. CL. 16.
- GEORGIA-PACIFIC CORPORATION, ATLANTA, GA:
1,866,348, CANC. INT. CL. 16.
2,534,861, INT. CL. 16.
- GEOTRONICS AKTIEBOLAG, S-182 11 DANDERYD, SWE-
DEN:
1,866,209, CANC. INT. CL. 9.
- GERALD J. ENGELHARDT, YORKVILLE, IL, DBA TAR-
GETBALL:
1,865,874, CANC. INT. CL. 28.
- GERBER PLUMBING FIXTURES CORP., LINCOLNWOOD,
IL, GERBER PLUMBING FIXTURES CORP., CHICAGO,
IL:
1,172,156, REN. 12-17-01. INT. CL. 11.
- GERBER SCIENTIFIC PRODUCTS, INC., MANCHESTER,
CT:
1,647,928, REN. 12-20-01. INT. CL. 9.
- GEROTOGA INDUSTRIES, INC., SCOTCH PLAINS, NJ:
1,142,840, CANC. INT. CL. 35.
- GERTEIS, PAUL, CH-8645 JONA, SWITZERLAND:
2,533,539, PUB. 11-6-2001. INT. CL. 7.
- GERWECK, JENNIFER L., NORTHPORT, NY:
2,534,353, INT. CL. 28.
- GFY BEVERAGES COMPANY, NEW YORK, NY:
2,534,317, PUB. 11-6-2001. INT. CL. 33.
- GIBERT MARINE S.A., PERIGNY, LA ROCHELLE,
FRANCE:
1,173,124, REN. 12-21-01. INT. CL. 12.
- GIBSON GUITAR CORP., NASHVILLE, TN:
2,534,993, INT. CL. 15.
- GIESECKE & DEVRIENT GMBH, 81677 MUNICH, FED REP
GERMANY:
2,533,283, PUB. 11-6-2001. MULTIPLE CLASS, INT. CLS.
1, 9 AND 16.

- GIFFORD'S DAIRY, INC., SKOWHEGAN, ME:
2,533,732, PUB. 11-6-2001. INT. CL. 30.
2,533,733, PUB. 11-6-2001. INT. CL. 30.
- GILMORE, ELKA, SAN FRANCISCO, CA:
1,866,104, CANC. INT. CL. 42.
- GIRL SCOUTS OF THE UNITED STATES OF AMERICA,
NEW YORK, NY:
1,172,203, REN. 12-19-01. INT. CL. 16.
- GIRLS LIFE, INC., BALTIMORE, MD:
2,534,287, PUB. 11-6-2001. INT. CL. 16.
- GLAVIN, PAM, CHILMARK, MA:
1,662,663, REN. 12-20-01. INT. CL. 30.
- GLEASON CUTTING TOOLS CORPORATION, ROCHESTER,
NY:
2,534,165, PUB. 11-6-2001. INT. CL. 7.
- GLIDDEN COMPANY, THE FORMERLY ATKEMIX
EIGHT, INC., CLEVELAND, OH:
1,173,192, REN. 12-17-01. INT. CL. 16.
- GLOBAL BIZ DIRECTORY.COM, INC., PUNTA GORDA,
FL:
2,533,432, PUB. 11-6-2001. MULTIPLE CLASS, INT. CLS.
35 AND 42.
- GLOBAL BUSINESS DIALOGUE, INC., THE, WASHINGTON,
DC:
2,534,896, INT. CL. 16.
- GLOBAL CONSENSUS, INC., CARROLLTON, TX:
1,865,609, CANC. INT. CL. 9.
- GLOBAL INFORMATION SECURITY INC, TAMPA, FL:
2,535,110, INT. CL. 42.
- GLOBAL STYLE IMAGES, INC., SAN DIEGO, CA:
2,534,756, INT. CL. 28.
- GLOBAL UPHOLSTERY COMPANY, DOWNSVIEW ONTARIO,
CANADA TO GLOBAL UPHOLSTERY COMPANY, DOWNSVIEW ONTARIO,
CANADA:
2,479,012, COR. INT. CL. 20.
- GLOBAL-SUPPLY.COM, INC, CHICAGO, IL:
2,535,012, INT. CL. 35.
- GLOBE PEQUOT PRESS, INC., THE, OLD SAYBROOK, CT:
1,840,479, CANC. INT. CL. 16.
- GLORIA VANDERBILT TRADEMARK B.V., 1101 CJ AMSTERDAM
20, NETHERLANDS, G.V. LICENSING, INC., NEW YORK, NY:
1,586,875, REN. 12-20-01. INT. CL. 25.
- GODFREY HIRST AUSTRALIA PTY. LTD., VICTORIA 3220,
AUSTRALIA:
2,534,506, INT. CL. 27.
- GOI PEACE FOUNDATION, THE, TOKYO, JAPAN, BYAKO SHINKO
KAI, THE, ICHIKAWA-SHI, CHIBA-KEN, JAPAN:
1,657,352, REN. 12-20-01. MULTIPLE CLASS, INT. CLS.
16, 18, 21, 24, 25 AND 26.
- GOLD KIST INC., ATLANTA, GA:
2,107,480, CANC. INT. CL. 5.
- GOLD WIRE TECHNOLOGY INC., WALTHAM, MA:
2,534,922, INT. CL. 9.
- GOLDBERG ELLIOTT, SCARSDALE, NY:
2,533,933, PUB. 11-6-2001. MULTIPLE CLASS, INT. CLS.
10 AND 28.
- GOLDBERG, DAVID, BEVERLY HILLS, CA, DBA PETKIN
PET CARE SYSTEMS:
1,866,184, CANC. INT. CL. 5.
- GOLDBERG, DAVID, MARINA DEL REY, CA, DBA PETKIN
PET CARE SYSTEMS:
1,866,194, CANC. INT. CL. 5.
- GOLF COURSE, INC., THE, COPPELL, TX, DBA EPLAN-
GOLF.COM:
2,533,658, PUB. 11-6-2001. INT. CL. 35.
- GOLF SCHOOLS, INC., NORTH CANTON, OH:
1,673,713, REN. 12-21-01. INT. CL. 41.
- GOOD-LITE COMPANY, FOREST PARK, IL:
1,625,871, CANC. INT. CL. 11.
- GOODYEAR TIRE & RUBBER COMPANY, THE, AKRON,
OH:
1,142,437, CANC. INT. CL. 12.
2,534,261, PUB. 11-6-2001. INT. CL. 7.
- GOPHER ADVENTURES, LTD., COLUMBUS, OH:
2,533,869, PUB. 11-6-2001. MULTIPLE CLASS, INT. CLS.
39 AND 41.
- GORELL ENTERPRISES, INC., INDIANA, PA:
2,534,785, INT. CL. 19.
- GOULSTON & STORRS, P.C., BOSTON, MA:
2,534,226, PUB. 11-6-2001. INT. CL. 42.
- GOVERNMENT TECHNOLOGY SERVICES, INC., CHANTILLY,
VA:
2,535,019, MULTIPLE CLASS, INT. CLS. 41 AND 42.
- GOVERNOR AND COMPANY OF ADVENTURERS OF ENGLAND
TRADING INTO HUDSON'S BAY, THE, WINNIPEG 1, MANITOBA,
CANADA, AKA HUDSON'S BAY COMPANY:
1,142,561, CANC. INT. CL. 18.
1,142,825, CANC. INT. CL. 35.
- GP TECHNOLOGIES, INC., SOMERVILLE, NJ:
1,142,490, CANC. INT. CL. 16.
- GRAFFAGNINO, ROBERT, COLUMBUS, OH, DBA RKG
ENTERPRISES:
1,865,872, CANC. INT. CL. 27.
- GRAHAM WEBB INTERNATIONAL LIMITED PARTNERSHIP,
CARLSBAD, CA:
2,534,841, MULTIPLE CLASS, INT. CLS. 3 AND 21.
2,534,842, INT. CL. 3.
2,534,843, INT. CL. 3.
- GRAIS, MELVIN L., LOS GATOS, CA, DBA USEFUL
PRODUCTS:
1,865,790, CANC. INT. CL. 18.
- GRAND LABORATORIES, INC., LARCHWOOD, IA:
1,479,301, AM. INT. CL. 5.
- GRAND UNION COMPANY, THE, WAYNE, NJ:
1,866,538, CANC. INT. CL. 32.
- GRANT BECKSTRAND CANCER FOUNDATION, LONG BEACH,
CA:
2,535,069, INT. CL. 42.
- GRAPHIC SYSTEMS TECHNOLOGY, INC., FLORENCE,
KY:
1,865,651, CANC. INT. CL. 9.
- GRAYWOLF SENSING SOLUTIONS, L.T.D., NORWALK, CT:
2,534,642, INT. CL. 9.
- GREAT EARTH COMPANIES, INC., HICKSVILLE, NY:
2,533,209, PUB. 11-6-2001. INT. CL. 5.
- GREAT GULF HOMES AMERICAN CORP., DALLAS, TX:
1,910,430, CANC. INT. CL. 37.
- GREAT LAKES TRANSCARIBBEAN LINE, HAMBURG 2000,
FED REP GERMANY:
1,142,903, CANC. INT. CL. 39.
- GREAT NUMBERS! LLC, RED BANK, NJ:
2,534,839, MULTIPLE CLASS, INT. CLS. 35 AND 41.
- GREAT SOUTHERN CORPORATION, MEMPHIS, TN:
1,142,710, CANC. INT. CL. 28.
- GREATER CINCINNATI CHAMBER OF COMMERCE, CINCINNATI,
OH:
1,658,210, REN. 12-19-01. INT. CL. 16.
- GREATER RICHMOND CHAMBER OF COMMERCE, RICHMOND,
VA:
2,533,997, PUB. 11-6-2001. INT. CL. 35.
- GREB INTERNATIONAL AND COMPANY:
See—KODIAK GROUP INC..
- GREEN BAY PACKAGING INC., GREEN BAY, WI:
1,625,917, CANC. INT. CL. 16.
- GREEN CROSS CORPORATION, THE, CHUO-KU, OSAKA, JAPAN
TO GREEN CROSS CORPORATION, THE, CHUO-KU, OSAKA,
JAPAN:
1,865,546, CANC. INT. CL. 5.
- GREEN PHARMACEUTICALS, INC., WILSONVILLE, OR:
2,533,960, PUB. 11-6-2001. INT. CL. 5.
- GREEN, WILLIAM F., FORT PAYNE, AL:
2,534,026, PUB. 11-6-2001. INT. CL. 21.
- GREENE, RALPH F., RICHARDSON, TX, DBA SPICES-N-
STUFF:
2,534,797, INT. CL. 35.
- GREENLEES, JAY, DACULA, GA:
2,534,953, INT. CL. 35.
2,534,954, INT. CL. 35.
- GREENMAC PTY. LTD., CAPALABA, QUEENSLAND, 4157,
AUSTRALIA:
1,866,204, CANC. INT. CL. 7.

- GRIFFIN L.L.C., VALDOSTA, GA:
 2,534,892, INT. CL. 5.
- GRIFFIN, MICHAEL, AGUA DULCE, CA, DEVON INDUSTRIES, INC., NORTHRIDGE, CA:
 1,166,353, REN. 12-19-01. INT. CL. 10.
- GRIFFITH LABORATORIES U.S.A., INC., ALSIP, IL:
 708,154, CANC. U.S. CL. 46.
- GRINNELL CORPORATION, EXETER, NH, ANVIL PRODUCTS, INC., ALLISON PARK, PA:
 910,553, REN. 12-19-01. U.S. CL. 13 (INT. CL. 6).
- GROUND HEATERS, INC., CALUMET, MI:
 2,534,361, INT. CL. 11.
- GROUND ZERO PHARMACEUTICALS, NEWPORT BEACH, CA:
 2,533,846, PUB. 11-6-2001. INT. CL. 35.
- GROUPE PP HOLDING SA, GENEVA 2, SWITZERLAND:
 2,533,501, PUB. 11-6-2001. MULTIPLE CLASS, INT. CLS. 9, 10 AND 42.
- GRUMA CORPORATION, IRVING, TX:
 2,534,248, PUB. 11-6-2001. INT. CL. 30.
- GRUNAU COMPANY, MILWAUKEE, WI:
 2,533,402, PUB. 11-6-2001. INT. CL. 42.
- GRUNDFOS A/S, BJERRINGBRO, DENMARK:
 1,865,572, CANC. INT. CL. 7.
- GSL RECHARGEABLE PRODUCTS LTD., TSIM SHA TSUI EAST, KOWLOON, HONG KONG:
 1,865,631, CANC. INT. CL. 9.
- GTCO CORPORATION, COLUMBIA, MD:
 1,866,290, CANC. INT. CL. 9.
- GTE DIRECTORIES CORPORATION, D/FW AIRPORT, TX:
 1,625,927, CANC. INT. CL. 16.
- GUARDIAN LIFE INSURANCE COMPANY OF AMERICA, THE, NEW YORK, NY:
 1,662,742, REN. 12-15-01. INT. CL. 36.
- GUARDSMAN PRODUCTS, INC., GRAND RAPIDS, MI:
 1,866,631, CANC. INT. CL. 20.
- GUCCI SHOPS, INC., NEW YORK, NY:
 1,142,562, CANC. INT. CL. 18.
- GUERBET SA, 93420 VILLEPINTE, FRANCE:
 1,171,925, REN. 12-20-01. INT. CL. 5.
- GUILFORD MILLS, INC., GREENSBORO, NC:
 1,866,405, CANC. INT. CL. 24.
- GUILLEMOT INTERNATIONAL INC., MONTREAL, QUEBEC H2T 1S6, CANADA:
 2,534,464, INT. CL. 9.
- GUINNESS UNITED DISTILLERS & VINTNERS B.V., 1014 BG AMSTERDAM, NETHERLANDS:
 2,534,281, PUB. 11-6-2001. INT. CL. 33.
- GUINOT, PARIS, FRANCE, LABORATOIRE RENE GUINOT, 75002 PARIS, FRANCE:
 1,665,608, REN. 12-21-01. INT. CL. 3.
- GULF LITE & WIZARD, INC.:
See—GW, INC.
- GUTENBERG PRINTING PRESS COMPANY, ATLANTA, GA:
 2,533,895, PUB. 11-6-2001. INT. CL. 35.
- GW, INC., ROSWELL, GA FROM GULF LITE & WIZARD, INC., MEMPHIS, TN:
 2,533,238, PUB. 11-6-2001. INT. CL. 4.
- H. BELMER COMPANY, CINCINNATI, OH:
 1,866,197, CANC. INT. CL. 6.
- H. E. BUTT GROCERY COMPANY, SAN ANTONIO, TX:
 2,534,650, INT. CL. 29.
- H. J. LANGEN & SONS LIMITED, REXDALE, ONTARIO, CANADA:
 1,142,263, CANC. INT. CL. 7.
- H.H. BROWN SHOE TECHNOLOGIES, INC., GREENWICH, CT:
 2,533,701, PUB. 11-6-2001. INT. CL. 25.
- H&M FOOD SYSTEMS COMPANY, INC., DEERFIELD, IL:
 1,626,142, CANC. MULTIPLE CLASS, INT. CLS. 29 AND 30.
- H-D MICHIGAN, INC., ANN ARBOR, MI:
 2,534,583, INT. CL. 41.
- HAAS, KEN, BARRYVILLE, NY:
 2,534,373, INT. CL. 16.
- HAGE CONSTRUCTION COMPANY, ST. LOUIS PARK, MN:
 1,663,437, REN. 12-20-01. INT. CL. 19.
- HAHN, SOPHIE, SAN RAFAEL, CA, DBA SIGNIA FINE PAPERS AND BIRKHAHN, CHRISTIENNE DE TOUMAY, SAN RAFAEL, CA, DBA SIGNIA FINE PAPERS:
 2,533,546, PUB. 11-6-2001. INT. CL. 16.
- HAIN CELESTIAL GROUP, INC., THE, UNIONDALE, NY:
 2,533,842, PUB. 11-6-2001. INT. CL. 30.
- HALLIBURTON ENERGY SERVICES INC, CARROLLTON, TX, HALLIBURTON COMPANY, DUNCAN, OK:
 1,210,932, REN. 12-20-01. INT. CL. 40.
- HALLIBURTON ENERGY SERVICES, INC., CARROLLTON, TX, BAROID TECHNOLOGY, INC., HOUSTON, TX:
 1,721,030, REN. 12-20-01. INT. CL. 1.
- HALLINAN, JAMES D., GLEN MILLS, PA:
 2,534,601, INT. CL. 16.
- HALLMARK LICENSING, INC., KANSAS CITY, MO, HALL BROTHERS, INC., KANSAS CITY, MO:
 525,798, REN. 12-18-01. U.S. CL. 38 (INT. CLS. 9, 16 AND 28).
- HANDY ANDY HOME IMPROVEMENT CENTERS, INC., SCHAUMBURG, IL:
 1,866,093, CANC. INT. CL. 42.
- HANENFELD, JOHN, SEAFORD, DE:
 2,535,074, INT. CL. 35.
 2,535,075, INT. CL. 35.
- HANOLA INTERNATIONAL INC, COQUITON, BRITISH COLUMBIA, CANADA TO M&R ENTERPRISES INC., COQUITLAM, BRITISH COLUMBIA, CANADA:
 2,444,713, COR. MULTIPLE CLASS, INT. CLS. 9, 16 AND 35.
- HANSEN, ERIC C., ARLINGTON, TX:
 1,866,289, CANC. INT. CL. 9.
- HAPPY JACK, INC., SNOW HILL, NC:
 1,671,290, REN. 12-16-01. INT. CL. 31.
- HARBOR-UCLA RESEARCH & EDUCATION INSTITUTE, TORRANCE, CA:
 2,534,221, PUB. 11-6-2001. INT. CL. 42.
- HARCOURT, INC., ORLANDO, FL, HARCOURT BRACE JOVANOVIH, INC., ORLANDO, FL:
 1,718,098, REN. 12-15-01. INT. CL. 16.
- HARD ROCK HOTEL & CASINO, INC., LOS ANGELES, CA:
 2,534,438, MULTIPLE CLASS, INT. CLS. 41 AND 42.
- HARDCAP LLC, NEW YORK, NY FROM QUARTET PRODUCTS, LLC, NEW YORK, NY:
 2,534,406, INT. CL. 25.
- HARDING-STINE, BETH, SCOTTSDALE, AZ:
 1,865,973, CANC. INT. CL. 36.
- HARLEY HOTELS, INC., CLEVELAND, OH:
 1,142,878, CANC. INT. CL. 36.
- HARMONY HOLDINGS, INC., MINNEAPOLIS, MN:
 2,534,666, INT. CL. 35.
- HARMSCO, INC., WEST PALM BEACH, FL:
 2,534,260, PUB. 11-6-2001. INT. CL. 11.
- HARPER INDUSTRIES, INC., NEW YORK, NY:
 1,865,844, CANC. INT. CL. 25.
- HARPERCOLLINS PUBLISHERS INC., NEW YORK, NY:
 1,866,360, CANC. INT. CL. 16.
- HARRAH'S CLUB, RENO, NV:
 1,866,124, CANC. MULTIPLE CLASS, INT. CLS. 39, 41 AND 42.
- HARRIS CORPORATION, MELBOURNE, FL:
 2,534,253, PUB. 11-6-2001. INT. CL. 9.
- HARRIS PUBLICATIONS, INC., NEW YORK, NY:
 2,534,175, PUB. 11-6-2001. INT. CL. 20.
- HARRIS TRUST AND SAVINGS BANK, CHICAGO, IL:
 1,626,269, CANC. INT. CL. 36.
- HARRY ROSEN INC., TORONTO, ONTARIO, CANADA:
 1,626,045, CANC. INT. CL. 25.
- HARRY WINSTON, INC., NEW YORK, NY:
 1,678,085, REN. 12-17-01. INT. CL. 14.
- HARSCO CORPORATION, WORMLEYSBURG, PA TO HARSCO TECHNOLOGIES CORPORATION, FAIRMOUNT, MN:
 1,625,641, CANC. MULTIPLE CLASS, INT. CLS. 7 AND 9.
- HARSCO CORPORATION, WORMLEYSBURG, PA:
 1,649,049, CANC. INT. CL. 40.
- HARSCO CORPORATION, CAMP HILL, PA:
 1,661,724, CANC. MULTIPLE CLASS, INT. CLS. 17 AND 19.

- HARSCO CORPORATION, WORMLEYSBURG, PA:
1,665,654, CANC. MULTIPLE CLASS, INT. CLS. 7 AND 11.
- HARTFORD FIRE INSURANCE COMPANY, HARTFORD, CT:
1,626,268, CANC. INT. CL. 36.
- HARTFORD PROVISION CO., THE, STAMFORD, CT:
708,142, CANC. U.S. CL. 46.
- HARVARDNET, INC.:
See— HNI ACQUISITION, INC..
- HASBRO, INC., PAWTUCKET, RI, CBS INC., NEW YORK, NY:
1,188,784, REN. 12-17-01. INT. CL. 28.
- HASBRO, INC., PAWTUCKET, RI:
2,534,545, INT. CL. 28.
- HATTERAS GROUP, THE, GREENVILLE, NC:
1,866,403, CANC. INT. CL. 22.
- HAUGHEY, JAMES A., VENICE, CA:
2,533,999, PUB. 11-6-2001. INT. CL. 10.
- HAWAIIAN SUN PRODUCTS, INC., HONOLULU, HI, AKA HAWAIIAN SUN PRODUCTS:
1,142,756, CANC. MULTIPLE CLASS, INT. CLS. 29, 30 AND 32.
- HAWTHORNE PRODUCTS, INC., DUNKIRK, IN:
1,657,116, REN. 12-21-01. INT. CL. 5.
- HAYCO MANUFACTURING LIMITED, WANCHAI, HONG KONG:
2,533,601, PUB. 11-6-2001. INT. CL. 8.
- HAYES-SCOTT, FAIRY C., ANN ARBER, MI:
2,533,612, PUB. 11-6-2001. INT. CL. 28.
- HBH LIMITED PARTNERSHIP, CINCINNATI, OH:
2,534,573, MULTIPLE CLASS, INT. CLS. 35 AND 42.
- HDR POWER SYSTEMS, INC., COLOMBUS, OH:
2,534,556, INT. CL. 9.
- HEALTH PRODUCTS CORPORATION, YONKERS, NY:
2,534,117, PUB. 11-6-2001. INT. CL. 5.
- HEALTHDIRECTOR.COM, INCLINE VILLAGE, NV:
2,534,731, INT. CL. 16.
- HEALTHFUSION.COM INC., SOLANA BEACH, CA FROM TBIC LLC, SAN DIEGO, CA:
2,534,530, INT. CL. 9.
- HEARD, GREG, POTOMAC, MD:
2,534,134, PUB. 11-6-2001. INT. CL. 25.
- HEARTSHARE HUMAN SERVICES OF NEW YORK, ROMAN CATHOLIC DIOCESE OF BROOKLYN, BROOKLYN, NY:
2,534,316, PUB. 11-6-2001. INT. CL. 42.
- HEATHKIT COMPANY, INC., BENTON HARBOR, MI, HEATH COMPANY, BENTON HARBOR, MI:
919,802, REN. 12-16-01. U.S. CL. 38 (INT. CL. 16).
- HEBERT, JAMES P. DBA "SCHMOJOE":
See— SCHMOJOE, INC..
- HEINZE, FRANK D., INDIALANTIC, FL:
2,533,550, PUB. 11-6-2001. MULTIPLE CLASS, INT. CLS. 10 AND 28.
- HELEN OF TROY CORPORATION, EL PASO, TX:
1,866,117, CANC. MULTIPLE CLASS, INT. CLS. 9 AND 11.
- HELENA RUBINSTEIN, S.A., 75008 PARIS, FRANCE:
1,883,246, CANC. INT. CL. 3.
- HELENE CURTIS, INC., CHICAGO, IL:
1,142,521, CANC. INT. CL. 16.
- HELENE CURTIS, INC., WILMINGTON, DE:
2,534,895, INT. CL. 3.
2,534,924, INT. CL. 3.
- HELIX TECHNOLOGY CORPORATION, MANSFIELD, MA FROM GRANVILLE-PHILLIPS COMPANY, BOULDER, CO:
2,534,391, INT. CL. 9.
- HELP/SYSTEMS INCORPORATED, MINNETONKA, MN:
2,534,166, PUB. 11-6-2001. INT. CL. 9.
- HELPHORIZONS.COM, INC., BOSTON, MA:
2,534,751, INT. CL. 42.
- HEMINGWAY, LTD., NEW YORK, NY:
2,534,825, MULTIPLE CLASS, INT. CLS. 16, 20 AND 21.
- HENDERSON, JOHN D., DOVE CANYON, CA:
1,866,502, CANC. INT. CL. 28.
- HENDRY, DAVID W., JR., OAKLAND, CA, DBA JCRS:
2,534,584, INT. CL. 42.
- HENNESSEY INDUSTRIES, INC., SEATTLE, WA:
2,534,901, INT. CL. 35.
- HENNINGSEN FOODS, INC., PURCHASE, NY:
1,675,982, REN. 12-19-01. INT. CL. 29.
- HENRI STUDIO INC., WAUCONDA, IL:
2,533,839, PUB. 11-6-2001. MULTIPLE CLASS, INT. CLS. 6 AND 11.
- HENRICHS, MICHAEL H., ROCHESTER, NY:
2,535,047, INT. CL. 41.
- HENRY COOKE LIMITED, STAFFORDSHIRE, ST15 0SA, ENGLAND FROM BARLOW PAPER LIMITED, WALTON, STONE, STAFFORDSHIRE, ST15 0SA, ENGLAND:
2,534,430, MULTIPLE CLASS, INT. CLS. 16 AND 19.
- HENRY SILVERMAN JEWELERS, INC., EL PASO, TX:
1,625,904, CANC. INT. CL. 14.
1,625,905, CANC. INT. CL. 14.
- HERALD HOUSEWARE LIMITED, KWAI CHUNG, NEW TERRITORIES, HONG KONG, YUEN FUNG METAL WORKS LTD., KOWLOON, HONG KONG:
1,168,433, REN. 12-19-01. INT. CL. 21.
- HERBAL AIDE, INC., MONTEREY PARK, CA:
2,533,808, PUB. 11-6-2001. INT. CL. 5.
- HERBAL ANIMALS, INC., POTOMAC, MD:
2,533,457, PUB. 11-6-2001. MULTIPLE CLASS, INT. CLS. 20 AND 28.
- HERBERT WALDMANN GMBH & CO., D- 78056 VILLINGEN-SCHWENNINGEN, FED REP GERMANY:
2,534,378, INT. CL. 11.
- HERCULES ENERGY MFG. CORPORATION, OKLAHOMA CITY, OK:
1,625,647, CANC. INT. CL. 7.
- HERITAGE HUMIDORS INC., BRIGHTON, MI:
2,533,310, PUB. 11-6-2001. INT. CL. 34.
- HERITAGE MINT, LTD., SCOTTSDALE, AZ:
2,534,153, PUB. 11-6-2001. INT. CL. 21.
- HERNDON, SUSEN A., OOLTEWAH, TN:
2,534,234, PUB. 11-6-2001. INT. CL. 42.
- HERO ARTS RUBBER STAMPS, INC., EMERYVILLE, CA:
2,534,961, INT. CL. 16.
- HEROIC BARD, INC., THE, CHICAGO, IL:
2,534,566, MULTIPLE CLASS, INT. CLS. 9 AND 41.
- HERPES RELIEF, LTD, LAS VEGAS, NV:
2,533,340, PUB. 11-6-2001. INT. CL. 5.
- HERSHEY CHOCOLATE AND CONFECTIONERY CORPORATION, WHEAT RIDGE, CO, HERSHEY FOODS CORPORATION, HERSHEY, PA:
1,161,379, REN. 12-21-01. INT. CL. 41.
- HERVIG, DANA P., INVER GROVE HEIGHTS, MN:
1,866,383, CANC. INT. CL. 20.
- HESTER INDUSTRIES, INC., MOOREFIELD, WV:
1,866,510, CANC. INT. CL. 29.
- HEWLETT-PACKARD COMPANY, PALO ALTO, CA:
1,866,251, CANC. INT. CL. 9.
2,535,131, INT. CL. 42.
- HFP ACQUISITION CORPORATION, SHENANDOAH, PA:
2,534,251, PUB. 11-6-2001. INT. CL. 30.
- HI FI HUTCH, INC., MT. PROSPECT, IL:
1,142,307, CANC. INT. CL. 9.
- HICKORY HEAVEN, INC., BOLEY, OK:
1,142,775, CANC. MULTIPLE CLASS, INT. CLS. 30 AND 42.
- HICKS & RAGLAND ENGINEERING CO., INC., LUBBOCK, TX:
2,534,667, MULTIPLE CLASS, INT. CLS. 35 AND 42.
- HICKS, ERIC, SPRINGFIELD GARDENS, NY:
2,534,576, INT. CL. 41.
- HIGH FIVE ENTERTAINMENT, INC, NASHVILLE, TN FROM HIGH FIVE ENTERTAINMENT, INC, NASHVILLE, TN:
2,534,502, INT. CL. 25.
- HIGHLAND INDUSTRIES, INC., GREENSBORO, NC:
2,534,214, PUB. 11-6-2001. INT. CL. 24.
- HIGHMARK INC., CAMP HILL, PA:
1,667,851, REN. 12-20-01. INT. CL. 36.
- HIGHWAY IMPRESSIONS, INC., TOWSON, MD:
2,534,859, INT. CL. 35.

- HIGHWAY IMPRESSIONS, INC., TOWSON, MD:
2,534,827, INT. CL. 35.
- HILLERICH & BRADSBY CO., LOUISVILLE, KY:
2,534,014, PUB. 11-6-2001. INT. CL. 20.
2,534,015, PUB. 11-6-2001. INT. CL. 9.
- HILTON HOSPITALITY, INC., BEVERLY HILLS, CA:
2,534,139, PUB. 11-6-2001. INT. CL. 42.
- HINGES, INC., ENTERPRISE, AL:
1,612,648, REN. 12-20-01. INT. CL. 6.
- HINKLE, KAREN F., SAN JAUN CAPISTRANO, CA:
1,866,382, CANC. INT. CL. 20.
- HISPANIC BROADCASTING CORPORATION, DALLAS, TX:
2,534,625, INT. CL. 35.
- HISTORIC ANNAPOLIS, INC., ANNAPOLIS, MD:
1,171,693, REN. 12-19-01. INT. CL. 41.
- HITACHI MEDICAL SYSTEMS AMERICA, INC., TWINSBURG, OH:
1,865,706, CANC. INT. CL. 10.
- HLC PROPERTIES, LTD., CARSON CITY, NV, BERGEN, RICHARD C. EXECUTOR OF THE ESTATE OF HARRY L. CROSBY, BEVERLY HILLS, CA:
1,171,442, REN. 12-17-01. INT. CL. 28.
- HNI ACQUISITION, INC., LOMBARD, IL FROM HARVARDNET, INC., MEDFORD, MA:
2,533,341, PUB. 11-6-2001. INT. CL. 38.
- HOCHMAN, MITCHELL I., NEW YORK, NY, MEAT GARDEN FOODS, LTD., NEW YORK, NY:
1,639,429, REN. 12-21-01. INT. CL. 29.
- HOCKENBURY, RITA M., HOUSTON, TX:
2,534,902, INT. CL. 25.
- HODGES, JESSE T., RAMONA, CA AND BAKARICH, PETER A., RAMONA, CA AND BAKARICH, ALEXANDRA C., RAMONA, CA:
2,534,143, PUB. 11-6-2001. INT. CL. 30.
- HOECHST CELANESE CORPORATION, SOMERVILLE, NJ:
1,865,800, CANC. INT. CL. 20.
1,865,801, CANC. INT. CL. 20.
1,865,802, CANC. INT. CL. 20.
1,866,155, CANC. INT. CL. 1.
- HOFFINGER INDUSTRIES, INC., CUCAMONGA, CA, DOMAIN INDUSTRIES, INC., NEW RICHMOND, WI:
926,085, REN. 12-20-01. U.S. CL. 12 (INT. CL. 28).
- HOLDER, FRANCIS, 59110 LA MADELEINE, FRANCE:
2,533,329, PUB. 11-6-2001. MULTIPLE CLASS, INT. CLS. 30 AND 42.
- HOLIDAY CHANNEL, INC., SAN JOSE, CA:
2,533,529, PUB. 11-6-2001. INT. CL. 35.
- HOLLYWOOD ATHLETIC CLUB LICENSING CORP., HOLLYWOOD, CA:
1,866,056, CANC. INT. CL. 42.
- HOMASOTE COMPANY, WEST TRENTON, NJ:
1,705,007, REN. 12-21-01. INT. CL. 19.
- HOME NUTRITIONAL SERVICES, INC., MARIETTA, GA:
1,865,927, CANC. INT. CL. 35.
- HONEYBEE NATURAL, LLC, SANTA FE, NM:
2,534,327, PUB. 11-6-2001. INT. CL. 4.
- HONEYWELL INC., MINNEAPOLIS, MN:
1,142,320, CANC. INT. CL. 9.
- HONEYWELL POMS CORP., HERNDON, VA, INDUSTRIAL COMPUTING DESIGNS CORPORATION, HERNDON, VA:
1,639,556, REN. 12-19-01. INT. CL. 9.
- HOPE COTTAGE, INC., DALLAS, TX:
2,534,194, PUB. 11-6-2001. INT. CL. 42.
- HOPKINS MANUFACTURING CORPORATION, EMPORIA, KS, OLATHE AUTOMOTIVE WIRING COMPANY, INC., NEODESHA, KS:
1,181,915, REN. 12-16-01. INT. CL. 9.
- HORIZON MEDICAL PRODUCTS, INC., ATLANTA, GA:
2,534,233, PUB. 11-6-2001. INT. CL. 10.
- HORNET CONCRETE PUMPS, INC., ROCK HILL, SC:
1,625,651, CANC. INT. CL. 7.
- HORS D'OEUVRES UNLIMITED, NORTH BERGEN, NJ:
2,534,017, PUB. 11-6-2001. INT. CL. 42.
2,534,018, PUB. 11-6-2001. INT. CL. 29.
- HOT SOX COMPANY, INC., THE, NEW YORK, NY:
1,865,855, CANC. INT. CL. 25.
- HOTELECOPY, INC., MIAMI, FL:
1,866,041, CANC. INT. CL. 42.
- HOTTINGER BALDWIN MEASUREMENTS, INC., MARLBORO, MA, HOTTINGER BALDWIN MESSTECHNIK GMBH, DARMSTADT 1, FED REP GERMANY:
1,172,929, REN. 12-21-01. INT. CL. 9.
- HOUSEKEEPER, JOHN B., LANSDALE, PA, TA HERITAGE WOODWORKS:
1,865,811, CANC. INT. CL. 20.
- HOUSTON FEARLESS 76, INC., COMPTON, CA:
1,866,239, CANC. INT. CL. 9.
- HOWARD, GLENN, ENGLEWOOD, CO:
2,534,757, INT. CL. 3.
- HOWES, DANIEL, TUCKER, GA AND WEBBER, IAN, TUCKER, GA:
2,533,446, PUB. 11-6-2001. INT. CL. 41.
- HOWMEDICA OSTEONICS CORP., ALLENDALE, NJ:
2,534,888, INT. CL. 10.
- HOYT CATLIN, SOUTH NORWALK, CT:
707,955, CANC. U.S. CL. 6.
- HSBC AMERICAS, INC., BUFFALO, NY:
1,626,292, CANC. INT. CL. 36.
- HSBC AMERICAS, INC., BUFFALO, NY:
1,626,290, CANC. INT. CL. 36.
- HT RESEARCH, INC., CYPRESS, CA:
1,866,234, CANC. INT. CL. 9.
- HTV INDUSTRIES, INC., PEPPER PIKE, OH, ZOOK ENTERPRISES INC., CHAGRIN FALLS, OH:
1,172,977, REN. 12-15-01. INT. CL. 9.
- HUGGER-MUGGER YOGA PRODUCTS, LLC, SALT LAKE CITY, UT:
2,534,649, INT. CL. 25.
- HUMCO HOLDING GROUP, INC., TEXARKANA, TX:
2,533,483, PUB. 11-6-2001. MULTIPLE CLASS, INT. CLS. 1, 3 AND 5.
- HUNG HING PLASTIC FACTORY LIMITED, TOKWAWAN, KOWLOON, HONG KONG:
1,866,482, CANC. INT. CL. 28.
- HUNT HOLDINGS, INC., WILMINGTON, DE:
1,865,805, CANC. INT. CL. 20.
- HUNTER FAN COMPANY, MEMPHIS, TN:
2,534,447, INT. CL. 9.
- HUNTER PACIFIC LIMITED, TORTOLA, BR. VIRGIN ISLANDS:
2,534,681, INT. CL. 13.
- HURON CAPITAL PARTNERS LLC, DETROIT, MI:
2,534,615, MULTIPLE CLASS, INT. CLS. 35 AND 36.
- HY-KO PRODUCTS COMPANY, WALTON HILLS, OH:
2,534,721, INT. CL. 35.
- HYDROTEX PARTNERS, LTD., CARROLLTON, TX, HYDROTEX, INC., DALLAS, TX:
1,679,116, REN. 12-20-01. INT. CL. 1.
- H20 PLUS, L.P., CHICAGO, IL:
1,625,531, CANC. MULTIPLE CLASS, INT. CLS. 3 AND 5.
- I B NET, LTD, NEW YORK, NY:
2,535,038, INT. CL. 35.
- I. C. ISAACA & COMPANY L.P., BALTIMORE, MD:
1,142,654, CANC. INT. CL. 25.
- I.D.M. IMMUNO-DESIGNED MOLECULES, PARIS, FRANCE:
2,533,456, PUB. 11-6-2001. MULTIPLE CLASS, INT. CLS. 5 AND 10.
- I.E.L. MANUFACTURING LTD., DELTA, BRITISH COLUMBIA, CANADA:
2,534,451, INT. CL. 6.
2,534,452, INT. CL. 6.
- I.M. JAWDAT, M.D., P.A., HOUSTON, TX:
2,533,871, PUB. 11-6-2001. INT. CL. 42.
- I.V. ONE, INC., ALTAMONTE SPRINGS, FL:
1,865,537, CANC. INT. CL. 5.
- I INC., CHICAGO, IL:
2,534,046, PUB. 11-6-2001. INT. CL. 42.
- I-DNS.NET INTERNATIONAL, INC., MENLO PARK, CA:
2,535,033, MULTIPLE CLASS, INT. CLS. 9 AND 42.
2,535,034, MULTIPLE CLASS, INT. CLS. 9 AND 42.
- I-VALVE, INC., SAN FRANCISCO, CA:
2,535,098, INT. CL. 35.

- IAMS COMPANY, THE, DAYTON, OH:
1,866,529, CANC. INT. CL. 31.
- ICU ACCESSORIES INC., BROOKLYN, NY:
2,534,092, PUB. 11-6-2001. INT. CL. 9.
- IDAYO INVESTOR, INC., PHILADELPHIA, PA FROM
MUTUAL DISCOVERY NETWORK, L.L.C., THE, PHILA-
DELPHIA, PA:
2,534,450, INT. CL. 42.
- IFO SANITAR AKTIEBOLAG, S-295 00 BROMOLLA, SWE-
DEN:
1,142,403, CANC. INT. CL. 11.
- IGEN, INC., WILMINGTON, DE, EVSCO PHARMACEUTI-
CAL CORP., OCEANSIDE, NY:
921,031. REN. 12-17-01. U.S. CL. 18 (INT. CL. 5).
- IGOURMET, LLC, YORKTOWN HEIGHTS, NY:
2,533,349, PUB. 11-6-2001. INT. CL. 35.
- IGT, RENO, NV:
2,534,237, PUB. 11-6-2001. INT. CL. 9.
2,534,269, PUB. 11-6-2001. INT. CL. 9.
2,534,635, INT. CL. 9.
2,534,788, INT. CL. 9.
- IGYS SYSTEMS, INC., GARDEN GROVE, CA, INFO-
GRAPHIC SYSTEMS INC., KANATA, ONTARIO K2L
2P4, CANADA:
1,659,499. REN. 12-17-01. INT. CL. 9.
- IHTAB, INC, DENVER, CO, FORMERLY DIRECT COMMU-
NICATIONS, INC., INFINITE HORIZONS, INC., ST.
LOUIS, MO:
1,669,689. REN. 12-16-01. INT. CL. 35.
- IIG GROUP, INC., DALLAS, TX:
2,534,089, PUB. 11-6-2001. INT. CL. 42.
- ILLINOIS AGRICULTURAL ASSOCIATION, BLOOMING-
TON, IL:
1,173,155. REN. 12-15-01. INT. CL. 16.
- ILLINOIS TOOL WORK INC., GLENVIEW, IL, PANDUIT
CORPORATION, TINLEY PARK, IL:
1,169,964. REN. 12-19-01. INT. CL. 9.
- ILLINOIS TOOL WORKS INC., GLENVIEW, IL:
921,396. REN. 12-20-01. U.S. CL. 13 (INT. CLS. 6 AND 20).
- ILLINOIS TOOL WORKS INC., GLENVIEW, IL, UNICAN
CORP., SHREWSBURY, MA:
1,183,362. REN. 12-15-01. INT. CL. 1.
- ILLINOIS TOOL WORKS INC., CHICAGO, IL:
1,625,725, CANC. INT. CL. 9.
- ILLINOIS TOOL WORKS INC., GLENVIEW, IL:
2,534,004, PUB. 11-6-2001. INT. CL. 1.
- ILLUMINATION TECHNOLOGIES, INC., EAST SYRACUSE,
NY:
2,534,712, INT. CL. 9.
- IMAGENE INC., SHREWSBURY, MA:
2,534,419, MULTIPLE CLASS, INT. CLS. 1 AND 9.
- IMAGENIUS.COM INC., MARKHAM, ONTARIO, CANA-
DA:
2,534,133, PUB. 11-6-2001. INT. CL. 41.
- IMERYS KAOLIN INC, ROSWELL, GA, KAOPOLITE, INC.,
ROSWELL, GA:
921,774. REN. 12-19-01. U.S. CL. 1 (INT. CL. 1).
- IMMEDIANT 1 INC., DENVER, CO:
2,533,852, PUB. 11-6-2001. INT. CL. 35.
- IMMERSENCE INC., MONTREAL, QUEBEC, CANADA:
2,534,482, MULTIPLE CLASS, INT. CLS. 9 AND 16.
- IMMVAC, INCORPORATED, COLUMBIA, MO:
1,681,754. REN. 12-17-01. INT. CL. 5.
- IMPERIAL BANK, SAN JOSE, CA:
2,533,301, PUB. 11-6-2001. INT. CL. 42.
- IMPERIAL TOBACCO LIMITED, BRISTOL BS99 7UJ, ENG-
LAND:
2,533,548, PUB. 11-6-2001. INT. CL. 34.
- IMPLEMENT.COM, L.L.C., SEATTLE, WA:
2,533,746, PUB. 11-6-2001. INT. CL. 42.
- IMPLI, INC., SAN FRANCISCO, CA FROM INNOVENTRY,
SAN FRANCISCO, CA:
2,534,737, INT. CL. 9.
- IMPORT BRAKE COMPANY, CULVER CITY, CA:
1,865,724, CANC. INT. CL. 12.
- IMPROVITA, INC., CLEVELAND, OH:
2,533,844, PUB. 11-6-2001. INT. CL. 5.
- IMS COMERCIAL E INDUSTRIAL LTDA., RIO DE JA-
NEIRO 26033-220, BRAZIL:
2,533,350, PUB. 10-10-2000. INT. CL. 3.
- IN PHASE INTERNATIONAL, INC., TEMPE, AZ:
2,535,051, INT. CL. 42.
- IN STEREO LLC, NEWINGTON, CT:
2,534,840, INT. CL. 35.
- IN THE SPOTLIGHT, LLC, ROXBURY, CT:
2,533,591, PUB. 11-6-2001. INT. CL. 41.
- INA CORPORATION, PHILADELPHIA, PA:
713,192. REN. 12-15-01. U.S. CL. 38 (INT. CL. 16).
713,296. REN. 12-15-01. U.S. CL. 102 (INT. CL. 36).
713,297. REN. 12-15-01. U.S. CL. 102 (INT. CL. 36).
- INCENTECH, INC., ABILENE, TX:
2,533,582, PUB. 11-6-2001. INT. CL. 9.
- INCENTIA DESIGN SYSTEMS, INC., SANTA CLARA, CA:
2,534,548, INT. CL. 9.
- INCLAN ENTERPRISES, INC., LOUISVILLE, KY, DBA
BOURBON COUNTRY, INC.:
2,533,730, PUB. 11-6-2001. INT. CL. 30.
2,533,731, PUB. 11-6-2001. INT. CL. 35.
- INCLUSION FIRST L.L.C., NEWINGTON, CT:
2,533,947, PUB. 11-6-2001. INT. CL. 41.
- INCO ALLOYS INTERNATIONAL, INC., HUNTINGTON,
WV:
1,625,804, CANC. INT. CL. 9.
- INDIANA GLASS COMPANY, DUNKIRK, IN:
1,142,609, CANC. INT. CL. 21.
- INDIANAPOLIS MOTOR SPEEDWAY CORPORATION,
SPEEDWAY, IN:
1,661,675. REN. 12-20-01. MULTIPLE CLASS, INT. CLS.
16 AND 25.
- INDUSTRI AB THULE, S-330 33 HILLERSTORP, SWEDEN:
2,533,276, PUB. 11-6-2001. INT. CL. 12.
- INDUSTRIAL COATINGS GROUP, INC., CHICAGO, IL:
1,625,950, CANC. MULTIPLE CLASS, INT. CLS. 16 AND
17.
- INDUSTRIAL SAFETY EQUIPMENT ASSOCIATION, AR-
LINGTON, VA:
1,142,515, CANC. INT. CL. 16.
- INDUSTRIAL WELDING (OF SWEDEN), INC., VENTURA,
CA:
2,534,292, PUB. 11-6-2001. INT. CL. 37.
- INDUSTRIAS ALIMENTARIAS DE NAVARRA, S.A., SAN
ADRIAN NAVARRA, SPAIN:
2,354,485, COR. MULTIPLE CLASS, INT. CLS. 29 AND
30.
- INDUSTRIES LASSONDE INC., ROUGEMONT, QUEBEC,
JOL 1M0, CANADA:
2,533,616, PUB. 11-6-2001. MULTIPLE CLASS, INT. CLS.
32 AND 35.
- INDUSTRYSMARTS.COM, GLASTONBURY, CT:
2,533,603, PUB. 11-6-2001. MULTIPLE CLASS, INT. CLS.
37 AND 42.
- INDYMAC BANK, F.S.B., PASADENA, CA:
2,534,198, PUB. 11-6-2001. INT. CL. 36.
- INFINITE ENTERTAINMENT GROUP CORPORATION,
VANCOUVER, BRITISH COLUMBIA, CANADA:
2,534,280, PUB. 11-6-2001. INT. CL. 16.
- INFORMATIVE GRAPHICS CORPORATION, PHOENIX,
AZ:
1,866,259, CANC. INT. CL. 9.
- INFORMED ADVANTAGE, INC., THE, NORTH RIVER-
SIDE, IL:
1,718,653. REN. 12-15-01. INT. CL. 35.
- INFRAWORKS CORPORATION, AUSTIN, TX:
2,534,764, INT. CL. 9.
- INGRAM ENTERPRISES, INC., SPRINGFIELD, MO:
1,715,505. REN. 12-19-01. INT. CL. 13.
- INJURY SCIENCES LLC, SAN ANTONIO, TX:
2,535,048, INT. CL. 9.
- INLITEN, L.L.C., NORTHFIELD, IL:
2,493,030, COR. MULTIPLE CLASS, INT. CLS. 9, 11 AND
20.
- INMAGIC, INC., CAMBRIDGE, MA, WARNER-EDDISON
ASSOCIATES, INC., CAMBRIDGE, MA:
1,173,561. REN. 12-20-01. INT. CL. 35.

- INNOTEK TECHNOLOGY INC., TAIPEI, TAIWAN, CHINA:
2,533,472, PUB. 11-6-2001. INT. CL. 9.
- INNOTHERA TOPIC INTERNATIONAL, 94110 ARCUEIL, FRANCE:
2,533,417, PUB. 11-6-2001. INT. CL. 10.
- INNOTHERA TOPIC INTERNATIONAL, FRANCE:
2,533,418, PUB. 11-6-2001. INT. CL. 10.
- INNOTHERA TOPIC LINTERNATIONAL, FRANCE:
2,533,419, PUB. 11-6-2001. INT. CL. 10.
- INNOVA INC., DAVENPORT, IA:
2,534,142, PUB. 11-6-2001. INT. CL. 21.
2,534,145, PUB. 11-6-2001. INT. CL. 21.
- INNOVATIVE POLYMERS, INC., ST. JOHNS, MI:
2,533,636, PUB. 11-6-2001. INT. CL. 1.
- INSIGHT IMAGING, INC., SCOTTSDALE, AZ:
2,534,457, INT. CL. 9.
- INSIGHT PHARMACEUTICALS CORPORATION, SAN FRANCISCO, CA:
2,534,078, PUB. 11-6-2001. INT. CL. 5.
- INSIGHT TOOLS LLC, MINNEAPOLIS, MN:
2,534,920, INT. CL. 35.
- INSTITUT FUR AEROSOL-MEDIZIN INAMED GMBH, D-82131 GAUTING, FED REP GERMANY:
2,533,459, PUB. 11-6-2001. INT. CL. 10.
- INSTITUT STRAUMANN AG, 4437 WALDENBURG, SWITZERLAND:
2,533,252, PUB. 11-6-2001. MULTIPLE CLASS, INT. CLS. 5 AND 10.
- INSTITUTE OF EUROPEAN STUDIES, CHICAGO, IL:
2,533,199, PUB. 11-6-2001. INT. CL. 35.
- INSURACTIVE, INC., ALEXANDRIA, VA FROM SENIOR MARKET SALES, INC., OMAHA, NE:
2,533,426, PUB. 11-6-2001. INT. CL. 36.
2,533,427, PUB. 11-6-2001. INT. CL. 42.
- INSYNC SYSTEMS, INC., MILPITAS, CA:
2,534,376, INT. CL. 9.
- INTEGRATED HEALTH SERVICES, INC., SPARKS, MD:
2,533,858, PUB. 11-6-2001. INT. CL. 42.
- INTEGRATED OFFICE RESOURCES, L.L.C., KANSAS CITY, MO:
2,533,811, PUB. 11-6-2001. INT. CL. 35.
- INTELLISEEK INC., CINCINNATI, OH:
2,534,595, INT. CL. 9.
- INTELLISPARK INC., BETHESDA, DC:
2,478,095, COR. INT. CL. 35.
- INTELLITECH SYSTEMS, INC., LAWRENCEVILLE, GA:
2,349,846, CANC. INT. CL. 42.
- INTERACTIVE INTELLIGENCE, INC., INDIANAPOLIS, IN:
2,535,011, INT. CL. 9.
- INTERACTIVE VIDEO-DISC SYSTEMS, INC., HUNTSVILLE, AL:
1,142,291, CANC. INT. CL. 9.
- INTERFACE SOLUTIONS, INC., LANCASTER, PA, ARMSTRONG CORK COMPANY, LANCASTER, PA:
918,930. REN. 12-20-01. U.S. CL. 35 (INT. CL. 17).
- INTERGRAPH CORPORATION, HUNTSVILLE, AL:
2,534,951, INT. CL. 9.
- INTERMATCH SWEDEN AB, STOCKHOLM SE-11885, SWEDEN FROM TABACALERA EL CREDITO, INC., MIAMI, FL:
2,533,323, PUB. 11-6-2001. INT. CL. 34.
- INTERNATIONAL AMERICAN CERAMICS, INC., TULSA, OK:
2,534,815, INT. CL. 19.
- INTERNATIONAL ASSOCIATION OF ELECTRONICS RECYCLERS, INC., ALBANY, NY:
2,533,925, PUB. 11-6-2001. INT. CL. 42.
- INTERNATIONAL ASSOCIATION OF KNOWLEDGE ENGINEERS, GAITHERSBURG, MD:
1,866,624, CANC. INT. CL. 16.
- INTERNATIONAL BANCSHARES CORPORATION, LAREDO, TX:
2,533,950, PUB. 11-6-2001. INT. CL. 36.
- INTERNATIONAL BROADBAND INC, PORT JEFFERSON, NY:
2,533,697, PUB. 11-6-2001. INT. CL. 35.
- INTERNATIONAL BUSINESS MACHINES CORPORATION, ARMONK, NY:
1,866,119, CANC. MULTIPLE CLASS, INT. CLS. 9 AND 16.
- INTERNATIONAL CARPET CLASSIFICATION ORGANIZATION, ICCO, BELGIUM:
1,161,489, REN. 12-20-01. U.S. CL. A.
- INTERNATIONAL COMPUTERS LIMITED, LONDON SW15 1SW, ENGLAND:
1,866,133, CANC. MULTIPLE CLASS, INT. CLS. 9 AND 16.
- INTERNATIONAL DATA GROUP, INC., FRAMINGHAM, MA:
1,866,273, CANC. INT. CL. 9.
- INTERNATIONAL DATA, LLC, BLOOMINGTON, IN:
2,534,473, INT. CL. 35.
- INTERNATIONAL DRUM CORPORATION, DES MOINES, IA:
1,142,492, CANC. INT. CL. 16.
- INTERNATIONAL FAMILY ENTERTAINMENT, INC., VIRGINIA BEACH, VA:
1,866,567, CANC. INT. CL. 38.
- INTERNATIONAL FOUNDATION OF EMPLOYEE BENEFIT PLANS, INC., BROOKFIELD, WI:
2,534,095, PUB. 11-6-2001. INT. CL. 41.
- INTERNATIONAL NYLONS, INC., METAIRIE, LA:
2,534,366, INT. CL. 25.
- INTERNATIONAL PAPER COMPANY, TUXEDO, NY:
549,652. REN. 12-21-01. U.S. CL. 2 (INT. CL. 16).
922,397. REN. 12-21-01. U.S. CL. 37 (INT. CL. 16).
- INTERNATIONAL PAPER COMPANY, NEW YORK, NY:
1,142,353, CANC. INT. CL. 9.
- INTERNATIONAL PERMALITE, INC., ONTARIO, CA:
1,865,783, CANC. INT. CL. 17.
- INTERNATIONAL PLAYTEX, INC., STAMFORD, CT:
1,142,653, CANC. INT. CL. 25.
- INTERNATIONAL RAW MATERIALS LTD., PHILADELPHIA, PA:
2,533,726, PUB. 11-6-2001. MULTIPLE CLASS, INT. CLS. 1 AND 35.
- INTERNATIONAL SOCIETY OF OUTSTANDING PROFESSIONAL SALESMEN, LTD., CAPISTRANO BEACH, CA:
1,142,849, CANC. INT. CL. 35.
- INTERNATIONAL SPACE OPTICS, S.A., IRVINE, CA:
2,534,449, INT. CL. 9.
- INTERNATIONAL SUPREME COUNCIL ORDER OF DEMOLAY, THE, WEST BLOOMFIELD, MI:
1,142,944, CANC. INT. CL. 42.
- INTERNATIONAL TECHNIDYNE CORP., EDISON, NJ, DBA DIVISION OF INTERNATIONAL TECHNIDYNE CORP.:
1,865,689, CANC. INT. CL. 10.
- INTERNATIONAL TRADE ADMINISTRATION, WASHINGTON, DC:
2,534,651, INT. CL. 35.
- INTERNATIONALE DE LUNETTERIE, OYONNAX, FRANCE:
1,142,322, CANC. INT. CL. 9.
- INTERNET GOLDEN MARKET, 76705 REHOVOT, ISRAEL:
2,533,664, PUB. 11-6-2001. INT. CL. 35.
- INTERNET SECURITY SYSTEMS, INC., ATLANTA, GA:
2,534,219, PUB. 11-6-2001. INT. CL. 42.
- INTERNET SHOPPING NETWORK, LLC, CULVER CITY, CA:
2,533,894, PUB. 11-6-2001. INT. CL. 35.
- INTERNET.COM CORPORATION, DARIEN, CT:
2,534,045, PUB. 11-6-2001. INT. CL. 42.
- INTERNEXUS, INC., SALT LAKE CITY, UT:
2,534,258, PUB. 11-6-2001. INT. CL. 41.
2,534,259, PUB. 11-6-2001. INT. CL. 41.
- INTEROSA, INC., COLORADO SPRINGS, CO:
2,533,975, PUB. 11-6-2001. INT. CL. 9.
- INTERSCOPE COMMUNICATIONS, INC., LOS ANGELES, CA:
2,534,403, INT. CL. 36.

- INTERSIL AMERICAS INC., IRVINE, CA FROM HARRIS CORPORATION, MELBOURNE, FL:
2,534,582, INT. CL. 42.
2,534,606, INT. CL. 9.
- INTERSTATE BRANDS WEST CORPORATION, KANSAS CITY, MO, FUCHS BAKING CO., MEDLEY, FL:
1,686,591. REN. 12-17-01. INT. CL. 30.
- INTERTEK TESTING SERVICES NA INC., LOMBARD, IL:
2,534,849, INT. CL. 42.
- INTERTICKET INC., BEDFORD, MA:
2,533,306, PUB. 11-6-2001. INT. CL. 9.
- INTERVENTURE, LLC, SAN LUIS OBISPO, CA:
2,534,033, PUB. 11-6-2001. INT. CL. 35.
2,534,034, PUB. 11-6-2001. INT. CL. 35.
- INTEVIS CORPORATION, WESTFORD, MA:
2,533,993, PUB. 11-6-2001. INT. CL. 42.
- INTIMATE BEAUTY CORPORATION, NEW YORK, NY, DBA VICTORIA'S SECRET BEAUTY:
2,534,864, INT. CL. 3.
- INVACARE CORPORATION, ELYRIA, OH:
1,170,094. REN. 12-17-01. INT. CL. 12.
- INVENTION SUBMISSION CORPORATION, PITTSBURGH, PA:
2,533,595, PUB. 11-6-2001. INT. CL. 35.
- INVENTORY LOCATOR SERVICE, INC., MEMPHIS, TN:
2,534,097, PUB. 11-6-2001. INT. CL. 35.
2,534,099, PUB. 11-6-2001. INT. CL. 35.
- INVETECH OPERATIONS PTY LTD, MOUNT WAVERLEY VIC 3149, AUSTRALIA:
2,534,882, INT. CL. 42.
- IOWA PAINT MANUFACTURING COMPANY, INC., DES MOINES, IA:
2,534,341, PUB. 11-6-2001. INT. CL. 2.
- IPA SYSTEMS, INC., PHILADELPHIA, PA:
1,662,479. REN. 12-17-01. INT. CL. 19.
- IRISH CONSTRUCTION, ROSEMEAD, CA:
1,188,944. REN. 12-19-01. INT. CL. 37.
- IRM SERVICES, INC., CHARLOTTE, NC:
1,865,958, CANC. INT. CL. 36.
- IRON-A-WAY INC., MORTON, IL, IRON-A-WAY, INC., MORTON, IL:
1,183,801. REN. 12-20-01. INT. CL. 20.
- IRVING OIL CORPORATION, BANGOR, ME:
2,533,230, PUB. 11-6-2001. INT. CL. 4.
- IRWIN TOY LIMITED, TORONTO, ONTARIO, CANADA:
1,866,485, CANC. INT. CL. 28.
- ISCO, INC., LINCOLN, NE:
2,534,967, INT. CL. 9.
- ISLE OF CAPRI CASINOS, INC., BILOXI, MS:
2,533,966, PUB. 11-6-2001. INT. CL. 42.
- ISP INVESTMENTS, INC., WILMINGTON, DE:
1,866,297, CANC. INT. CL. 9.
- ISS INTERNATIONAL SERVICE SYSTEM A/S, DENMARK 2840, DENMARK:
1,626,294, CANC. MULTIPLE CLASS, INT. CLS. 37 AND 42.
- IT GLOBAL QUEST, AUSTIN, TX:
2,533,376, PUB. 6-5-2001. INT. CL. 35.
- ITALIAN CONNECTION, INC., LOS ANGELES, CA, DBA BILA OF CALIFORNIA:
1,658,222. REN. 12-20-01. MULTIPLE CLASS, INT. CLS. 18 AND 25.
- ITALIAN INN PIZZA, INC., JACKSONVILLE, FL:
2,533,681, PUB. 11-6-2001. INT. CL. 42.
- ITC ENTERTAINMENT GROUP LIMITED, LONDON, ENGLAND:
1,866,578, CANC. INT. CL. 41.
- ITOKIN CO., LTD., CHUO-KU, OSAKA, JAPAN:
1,865,601, CANC. MULTIPLE CLASS, INT. CLS. 9, 14, 18, 25 AND 34.
- ITS A WRAP, ENGLEWOOD, CO:
1,866,407, CANC. INT. CL. 24.
- ITT INDUSTRIES INC, NEW YORK, NY:
1,625,862, CANC. INT. CL. 11.
- IVFONLINE.COM, LLC, GUILFORD, CT:
2,534,250, PUB. 11-6-2001. INT. CL. 9.
- IVILLAGE INC., NEW YORK, NY:
2,533,312, PUB. 11-6-2001. INT. CL. 42.
- IXION BIOTECHNOLOGY, INC., ALACHUA, FL:
2,534,717, INT. CL. 5.
- IXL ENTERPRISES, INC., ATLANTA, GA:
2,533,725, PUB. 11-6-2001. INT. CL. 42.
- J J HOLAND LIMITED, ROAD TOWN, TORTOLA, BR. VIRGIN ISLANDS:
2,534,392, INT. CL. 34.
- J. D'ADDARIO & COMPANY, INC., FARMINGDALE, NY:
2,533,878, PUB. 11-6-2001. INT. CL. 15.
- J. P. STEVENS & CO., INC., NEW YORK, NY:
708,137, CANC. U.S. CL. 42.
- J.A. WOOLLAM CO. INC., LINCOLN, NE:
2,534,923, INT. CL. 9.
- J.B.R., INC., SAN LEANDRO, CA, DBA EAST INDIA TEA & COFFEE CO.:
1,660,998. REN. 12-21-01. INT. CL. 30.
- J.C. PENNEY PRIVATE BRANDS, INC., PLANO, TX, J. C. PENNEY COMPANY, INC., NEW YORK, NY:
1,174,285. REN. 12-15-01. INT. CL. 24.
- J.F. JEWELRY, NEW YORK, NY:
1,865,745, CANC. INT. CL. 14.
- J.J. KENNY CO., INC., NEW YORK, NY:
1,659,098. REN. 12-17-01. MULTIPLE CLASS, INT. CLS. 36 AND 42.
- J.R. JENSEN, SPANISH FORK, UT:
2,534,978, INT. CL. 9.
- J.T. INDUSTRIES, SANTA ANA, CA:
2,533,875, PUB. 11-6-2001. INT. CL. 5.
- J.W. JUNG SEED COMPANY, RANDOLPH, WI:
2,534,999, INT. CL. 35.
2,535,000, INT. CL. 31.
- J&R ELECTRONICS, INC., NEW YORK, NY, DBA J&R MUSIC WORLD:
2,533,786, PUB. 11-6-2001. INT. CL. 35.
- J'S MAINTENANCE SERVICE, INC., GLENDALE, CA:
1,663,826. REN. 12-17-01. INT. CL. 37.
- JACKSON NATIONAL LIFE INSURANCE COMPANY, LANSING, MI:
2,534,852, INT. CL. 36.
- JACOBY, JOHN J., HUNTINGDON VALLEY, PA:
1,689,578. REN. 12-20-01. INT. CL. 21.
1,693,075. REN. 12-20-01. INT. CL. 21.
- JACUZZI UK GROUP PLC, BRADFORD, WEST YORKSHIRE, UNITED KINGDOM FROM SPRING RAM HOLDINGS PLC, BRADFORD, WEST YORKSHIRE, UNITED KINGDOM:
2,534,988, MULTIPLE CLASS, INT. CLS. 11 AND 17.
- JADO BATHROOM AND HARDWARE MANUFACTURING CORPORATION, CAMARILLO, CA:
1,871,812, CANC. INT. CL. 6.
1,874,688, CANC. INT. CL. 20.
- JAMDOWN RECORDS, ATLANTA, GA:
2,533,203, PUB. 11-6-2001. INT. CL. 9.
- JAMES DAWSON ENTERPRISES LTD., LACHINE, QUEBEC, CANADA:
2,533,304, PUB. 11-6-2001. INT. CL. 17.
- JAMES INDUSTRIES, INC., HOLLIDAYSBURG, PA:
2,534,216, PUB. 11-6-2001. INT. CL. 9.
- JAMES RICHARDSON INTERNATIONAL LIMITED/JAMES RICHARDSON INTERNATIONAL LIMITEE, WINNIPEG, MANITOBA, CANADA:
2,533,200, PUB. 11-6-2001. MULTIPLE CLASS, INT. CLS. 35 AND 39.
- JAMIESON/WILLIAMS GROUP, INC., THE, MISSISSAUGA, ONTARIO, CANADA:
1,865,598, CANC. INT. CL. 9.
- JB I, INC., READVILLE, MA:
1,866,456, CANC. INT. CL. 25.
- JEAN CHARLES, INCORPORATED, THERMAL, CA:
2,534,567, INT. CL. 3.
- JEAN GESTAS S-A., FRANCE:
2,533,464, PUB. 11-6-2001. INT. CL. 20.
- JELT SOFTWARE EXPRESS, INC., EVERGLADES CITY, FL:
2,534,310, PUB. 11-6-2001. MULTIPLE CLASS, INT. CLS. 9 AND 42.
- JENNINGS, KERRY A., AUSTIN, TX:
2,534,271, PUB. 11-6-2001. INT. CL. 41.

- JET AIR, INC., EL CAJON, CA:
1,142,896, CANC. INT. CL. 37.
- JET BLAST INC., BALTIMORE, MD:
1,661,944, REN. 12-17-01. INT. CL. 37.
- JIM HENSON COMPANY, INC., THE, LOS ANGELES, CA:
2,534,794, INT. CL. 28.
- JIM N' JOHNNYS' RESTAURANT, CHICAGO, IL:
1,866,090, CANC. INT. CL. 42.
- JIN SHIN JYUTSU, INC., SCOTTSDALE, AZ:
1,142,911, CANC. INT. CL. 41.
- JINGLE-NET.COM, INC., FOSTER CITY, CA:
2,533,804, PUB. 11-6-2001. INT. CL. 16.
- JOANNE FABRICS INC., MISSISSAUGA, ONTARIO L4W 1Y5, CANADA:
1,865,786, CANC. MULTIPLE CLASS, INT. CLS. 18 AND 24.
- JOCHUM, DARRELL W., MERCER ISLAND, WA:
2,534,908, INT. CL. 28.
- JOHN F. COPE CO., INC., EAST PETERSBURG, PA:
708,149, CANC. U.S. CL. 46.
- JOHN HEWITT & ASSOCIATES, INC., PORTLAND, ME:
2,310,753, COR. MULTIPLE CLASS, INT. CLS. 36 AND 41.
- JOHN PAUL MITCHELL SYSTEMS, SANTA CLARITA, CA:
2,534,937, INT. CL. 3.
- JOHN Q. COOK, CHICAGO, IL:
2,533,439, PUB. 11-6-2001. INT. CL. 42.
2,533,440, PUB. 11-6-2001. INT. CL. 42.
- JOHN T'S PIPES & FINE TOBACCOS, BAKERSFIELD, CA,
JOHN T'S PIPES & FINE TOBACCOS, BAKERSFIELD, CA:
1,175,433, REN. 12-20-01. INT. CL. 34.
- JOHNS MANVILLE INTERNATIONAL, INC., DENVER, CO:
2,534,151, PUB. 11-6-2001. INT. CL. 17.
- JOHNSON & JOHNSON, NEW BRUNSWICK, NJ:
921,425, REN. 12-16-01. U.S. CL. 18 (INT. CL. 5).
1,660,335, REN. 12-16-01. INT. CL. 9.
2,534,418, INT. CL. 21.
- JOHNSON HOSIERY MILLS, INC., HICKORY, NC:
1,865,842, CANC. INT. CL. 25.
- JOHNSON MATTHEY INC., VALLEY FORGE, PA:
1,866,316, CANC. INT. CL. 11.
- JOHNSON; JERRY LYNN, POTRERO, CA:
1,142,584, CANC. INT. CL. 20.
- JOHNSON, WAYNE A., MUNISING, MI:
2,534,962, INT. CL. 11.
- JONES & VINING, INCORPORATED, BRAINTREE, MA:
1,866,271, CANC. INT. CL. 9.
- JONES, ALAN L., FRISCO, TX:
2,533,311, PUB. 11-6-2001. INT. CL. 5.
- JONES, DONALD K., NEW DURHAM, NH:
2,534,067, PUB. 11-6-2001. INT. CL. 32.
- JONES, WILLIAM S., TAFT, CA, DBA AIR ADVENTURES:
1,866,020, CANC. INT. CL. 41.
- JONMOR INVESTMENTS, INC., WILMINGTON, DE, JOHN MORRELL & CO., CHICAGO, IL:
1,177,506, REN. 12-17-01. INT. CL. 29.
- JORH FRAME AND MOULDING COMPANY LTD, MATTESON, IL:
1,175,223, COR. INT. CL. 20.
- JOSEPH CAMPAGNA & SONS, INC., BROOKLYN, NY:
1,626,143, CANC. INT. CL. 29.
- JOY MANUFACTURING COMPANY, PITTSBURGH, PA:
1,142,237, CANC. INT. CL. 7.
- JPS CONVERTER AND INDUSTRIAL CORPORATION, SLATER, SC:
2,534,422, INT. CL. 24.
- JUDY BERGSMAN GALLERIES, INC., BELLINGHAM, WA:
2,534,934, INT. CL. 16.
- JUDY'S CANDY COMPANY, BERKELEY, CA:
2,533,954, PUB. 11-6-2001. INT. CL. 30.
- JUN ASHIDA CO., LTD., TOKYO, JAPAN:
2,533,397, PUB. 10-9-2001. MULTIPLE CLASS, INT. CLS. 3, 14, 18, 24 AND 25.
- JUNGJOHANN, KENNETH, HUNTINGTON BEACH, CA:
1,866,343, CANC. INT. CL. 16.
- JUNIOR VOLLEYBALL ASSOCIATION OF AUSTIN, AUSTIN, TX:
2,533,338, PUB. 11-6-2001. INT. CL. 25.
- JUNIPER GROVE, INC., REDMOND, OR, DBA JUNIPER GROVE FARM:
2,449,104, COR. INT. CL. 29.
- JUSTWISE LIMITED, SAFFRON WALDEN, ESSEX CB11 3AP, ENGLAND:
1,866,481, CANC. INT. CL. 28.
- JYH LIANG INDUSTRIAL CO., LTD., SAN CHUNG CITY, TAIPEI HSIEN, TAIWAN:
1,866,319, CANC. INT. CL. 11.
- K & K FLYFISHERS' SUPPLY, OVERLAND PARK, KS:
1,660,198, REN. 12-19-01. INT. CL. 42.
- KABUSHIKI KAISHA HATTORI SEIKO, TOKYO, JAPAN, TA SEIKO CORPORATION:
1,866,337, CANC. INT. CL. 14.
- KABUSHIKI KAISHA HITACHI SEISAKUSHO, CHIYODA-KU, TOKYO, JAPAN, DBA HITACHI, LTD.:
931,710, REN. 12-18-01. U.S. CL. 23 (INT. CL. 7).
- KABUSHIKI KAISHA HUDSON, TOYOHIRA-KU, SAPPORO-SHI, JAPAN:
1,866,489, CANC. INT. CL. 28.
- KABUSHIKI KAISHA MASUICHI ICHIMURA SYUZOJOYU, KAMITAKAI-GUN, NAGANO 381-0201, JAPAN:
2,534,557, INT. CL. 33.
- KABUSHIKI KAISHA MEIDENSHA, TOKYO, JAPAN:
1,866,211, CANC. INT. CL. 9.
- KABUSHIKI KAISHA PILOT, CHUO-KU, TOKYO, JAPAN, TA PILOT CORPORATION, PAIROTTO MAN-NEN-HITSU KABUSHIKI KAISHA, CHUO-KU, TOKYO-TO, JAPAN, DBA THE PILOT PEN CO., LTD., AKA THE PILOT PEN CO., LTD.:
716,701, REN. 12-20-01. U.S. CL. 11 (INT. CL. 16).
- KABUSHIKI KAISHA RITTOR MUSIC, CHIYODA-KU, TOKYO, JAPAN, TA RITTOR MUSIC, INC.:
2,534,552, MULTIPLE CLASS, INT. CLS. 9 AND 16.
- KAHLE ENGINEERING CORPORATION, SUMMIT, NJ:
1,674,790, REN. 12-17-01. INT. CL. 7.
- KAMINSKI, BASIA, WOODSTOCK, NY:
2,533,868, PUB. 11-6-2001. INT. CL. 21.
- KANBAY INCORPORATED, ROSEMONT, IL:
2,534,759, INT. CL. 42.
- KAO KABUSHIKI KAISHA, TOKYO 103-8210, JAPAN, TA KAO CORPORATION:
2,533,801, PUB. 11-6-2001. INT. CL. 3.
- KAPLAN FUNDING CORPORATION, DALLAS, TX:
1,865,966, CANC. INT. CL. 36.
- KARELIA TOBACCO COMPANY INC., KALAMATA, GREECE:
2,534,495, INT. CL. 34.
- KASPRZAK, PETER A., CANOGA PARK, CA:
1,866,439, CANC. INT. CL. 25.
- KATHRYN MOSBACHER DESIGNS, INC., HOUSTON, TX:
1,626,064, CANC. INT. CL. 25.
- KATTUS, JOHANN, 1010 VIENNA, AUSTRIA:
1,982,066, COR. INT. CL. 33.
- KAUFMAN, HARLEY, NEW YORK, NY:
2,535,102, INT. CL. 42.
2,535,105, INT. CL. 42.
- KAWASAKI JUKOGYO KABUSHIKI KAISHA, CHUO-KU, KOBE, JAPAN, DBA KAWASAKI HEAVY INDUSTRIES, LTD.:
2,534,463, INT. CL. 12.
- KAY CHEMICAL COMPANY, GREENSBORO, NC:
2,534,976, INT. CL. 3.
- KAYE INSTRUMENTS, INC., BILLERICA, MA:
1,168,192, REN. 12-15-01. INT. CL. 9.
- KAZEL, MICHAEL, THOUSAND OAKS, CA:
1,866,391, CANC. INT. CL. 20.
- KEEFE REAL ESTATE, INC., LAKE GENEVA, WI:
2,533,905, PUB. 11-6-2001. INT. CL. 36.
- KEEFER CONSULTING, INC., PHILADELPHIA, PA:
2,534,634, INT. CL. 42.
- KELATY INTERNATIONAL, INC., SECAUCUS, NJ:
1,866,134, CANC. MULTIPLE CLASS, INT. CLS. 27 AND 42.
- KELLERMANN, GUIDO, 52062 AACHEN, FED REP GERMANY:
2,534,421, MULTIPLE CLASS, INT. CLS. 12 AND 42.

- KELLEY, JASON, PRESCOTT, AZ:
2,534,995, INT. CL. 42.
- KELLOGG COMPANY, BATTLE CREEK, MI:
2,534,149, PUB. 11-6-2001. INT. CL. 30.
- KENDRO LABORATORY PRODUCTS, L.P., NEWTOWN, CT:
2,534,599, INT. CL. 7.
- KENMARK OPTICAL COMPANY, LOUISVILLE, KY:
2,534,184, PUB. 11-6-2001. INT. CL. 35.
- KENNEDY COVINGTON LOBDELL & HICKMAN, L.L.P., CHARLOTTE, NC:
2,534,176, PUB. 11-6-2001. INT. CL. 42.
- KENSINGTON PUBLISHING CORP., NEW YORK, NY:
2,534,818, INT. CL. 16.
2,534,927, INT. CL. 16.
- KENT COMPUTER CONSULTANTS LIMITED, HADLOW, TONBRIDGE, KENT TN11 0EF, UNITED KINGDOM:
2,534,477, INT. CL. 9.
- KERSTEN, HERBERT, SYDNEY, NEW SOUTH WALES 2000, AUSTRALIA:
1,865,592, CANC. MULTIPLE CLASS, INT. CLS. 9 AND 20.
- KEST, BRYAN, SANTA MONICA, CA:
2,535,056, INT. CL. 25.
- KEVIN C. BRYANT, SHELDON A. BUCKLER, GARY L. COUNTRYMAN, THOMAS G. DIGNAN, JR., CHARLES K. GIFFORD, NELSON S. GIFFORD, MATINA S. HORN-ER, FRANKLIN M. HUNDLEY, PAUL A. LA CAMERA, THOMAS J. MAY, SHERRY H. PENNEY, GERALD L. WILSON, AND RUSSELL D. WRIGHT, ALL U.S. CITI-ZENS, AS TRUSTEES OF THE TRUSTEES OF NSTAR, BOSTON, MA:
2,535,095, INT. CL. 39.
- KEYSTONE FOOD PRODUCTS, INC., EASTON, PA:
1,665,519, REN. 12-18-01. INT. CL. 30.
- KEYSTONE MARKETING SERVICES, INC., LAS VEGAS, NV FROM KEYAUTOPARTS.COM, INC., MAYNARD, MA:
2,534,817, INT. CL. 35.
- KEYSTONE SCIENTIFIC, INC., BELLEFONTE, PA:
1,625,496, CANC. INT. CL. 1.
- KIDDE RECREATION PRODUCTS, INC., NORTHBROOK, IL:
756,782, CANC. U.S. CL. 22.
- KIDEPO INVESTMENTS, PTY LTD, YALLINGUP, AUS-TRALIA:
2,534,114, PUB. 11-6-2001. INT. CL. 33.
- KIDSNET, INC., TALLAHASSEE, FL:
2,534,943, INT. CL. 9.
- KIDZ CAB, INC., HOUSTON, TX:
2,533,872, PUB. 11-6-2001. INT. CL. 39.
- KIM LIGHTING INC., CITY OF INDUSTRY, CA:
2,534,736, INT. CL. 11.
- KIM, JUNG PIL, CERRITOS, CA:
2,534,554, INT. CL. 35.
- KIM, YOUNGMI, SANTA CLARA, CA:
2,533,829, PUB. 11-6-2001. INT. CL. 38.
- KIMBERLY-CLARK CORPORATION, NEENAH, WI:
554,685, REN. 12-17-01. U.S. CL. 1 (INT. CL. 17).
1,142,539, CANC. INT. CL. 16.
1,142,541, CANC. INT. CL. 16.
- KIMBERTON ENTERPRISES, INC., WILMINGTON, DE, MONSEY PRODUCTS COMPANY, KIMBERTON, PA:
1,668,948, REN. 12-15-01. INT. CL. 2.
- KINETIC SPORTS INTERACTIVE, INC., BUFORD, GA:
2,535,097, INT. CL. 9.
- KING EDWARD TECHNOLOGY, INC., WILMINGTON, DE, A. SENSENBRENNER SONS, LOS ANGELES, CA:
396,981, REN. 12-17-01. U.S. CL. 17 (INT. CL. 34).
- KING EDWARD TECHNOLOGY, INC., WILMINGTON, DE, HELME TOBACCO COMPANY, STAMFORD, CT:
1,712,068, REN. 12-17-01. INT. CL. 34.
- KING KOIL LICENSING COMPANY, INC., ST. PAUL, MN:
1,865,818, CANC. INT. CL. 20.
- KING KUTTER II INCORPORATED, GALLIPOLIS, OH:
2,533,271, PUB. 11-6-2001. INT. CL. 7.
- KING, MICHELLE, IRVINE, CA:
2,534,706, INT. CL. 35.
- KINGDOM VACATIONS, INC., PLAINS, PA, TENEN-BAUM'S TRAVEL SERVICE, INC., KINGSTON, PA, DBA USA AIRTOURS:
1,607,697, REN. 12-21-01. INT. CL. 39.
- KINNEY SHOE CORPORATION, NEW YORK, NY:
1,866,473, CANC. INT. CL. 25.
- KIRST COMPANY, FRIDLEY, MN:
2,533,971, PUB. 11-6-2001. INT. CL. 13.
- KITAMURA VALVE SEIZO KABUSHIKI KAISHA, TAITO-KU, TOKYO, JAPAN, DBA KITAMURA VALVE MFG. CO., LTD.:
916,146, REN. 12-17-01. U.S. CL. 13 (INT. CLS. 6 AND 11).
- KLA-TENCOR CORPORATION, SAN JOSE, CA:
2,534,460, INT. CL. 9.
- KLOCHKO EQUIPMENT RENTAL COMPANY, INC., MEL-VINDALE, MI:
1,173,612, REN. 12-21-01. INT. CL. 37.
- KLOPP INTERNATIONAL, INC., OLDSMAR, FL:
1,192,038, REN. 12-17-01. INT. CL. 9.
- KLOSTERMAN BAKING CO., CINCINNATI, OH:
1,626,169, CANC. INT. CL. 30.
- KNIGHT BROS., INC., BENTON, IL:
1,630,776, REN. 12-17-01. INT. CL. 12.
- KNOMARK, INC., AURORA, IL:
2,534,760, INT. CL. 6.
- KNOPP, MICHAEL R., SAN DIEGO, CA:
1,866,418, CANC. INT. CL. 25.
- KNOUSE FOODS COOPERATIVE, INC., PEACH GLEN, PA:
1,718,436, REN. 12-17-01. MULTIPLE CLASS, INT. CLS. 29 AND 32.
- KNOWLEDGE KIDS ENTERPRISES, INC., LOS ANGELES, CA FROM LEAPFROG L.L.C., EMERYVILLE, CA:
2,534,369, INT. CL. 9.
- KNOWLEDGE KIDS ENTERPRISES, INC., LOS ANGELES, CA FROM LEAPFROG, L.L.C., EMERYVILLE, CA:
2,534,370, MULTIPLE CLASS, INT. CLS. 9 AND 28.
- KOCH AGRICULTURE, INC., WICHITA, KS:
1,626,009, CANC. INT. CL. 20.
- KOCOLENE MARKETING, LLC, SEYMOUR, IN, KOCO-LENE OIL CORPORATION, SEYMOUR, IN:
1,670,014, REN. 12-18-01. INT. CL. 4.
- KODIAK GROUP INC., MISSISSAUGA, PROVINCE OF ONTARIO, CANADA FROM GREB INTERNATIONAL AND COMPANY, QUEBEC JOH 1AO, CANADA:
2,533,213, PUB. 11-6-2001. INT. CL. 25.
- KOERBER PAPERLINK-GMBH, D-22529 HAMBURG, FED REP GERMANY:
2,533,299, PUB. 11-6-2001. INT. CL. 7.
- KOLLER ENTERPRISES, INC., FENTON, MO, KOLLER CRAFT PLASTIC PRODUCTS, INC., ST. LOUIS, MO:
1,148,823, REN. 12-15-01. INT. CL. 11.
- KOMISAR TRAINING CONSULTANTS, NEW YORK, NY:
2,534,998, MULTIPLE CLASS, INT. CLS. 35 AND 41.
- KOREA PNEUMATIC SYSTEM CO., LTD., SEOUL, 153-030, REPUBLIC OF KOREA:
2,534,486, INT. CL. 7.
- KOWA AMERICAN CORP., NEW YORK, NY:
1,865,851, CANC. INT. CL. 25.
- KRAFT FOODS HOLDINGS, INC., NORTHFIELD, IL, GENERAL FOODS CORPORATION, NEW YORK, NY:
552,243, REN. 12-21-01. U.S. CL. 46 (INT. CL. 30).
- KRAFT FOODS, INC., NORTHFIELD, IL:
1,625,969, CANC. INT. CL. 16.
- KRAUSE PUBLICATIONS, INC., IOLA, WI:
2,534,202, PUB. 11-6-2001. INT. CL. 16.
- KREMEN, GARY, SCOTTSDALE, AZ:
1,865,769, CANC. MULTIPLE CLASS, INT. CLS. 16 AND 25.
- KREMER, REINER G., FRANKTOWN, CO:
2,535,050, INT. CL. 5.
- KROGER CO., THE, CINCINNATI, OH:
1,142,741, CANC. MULTIPLE CLASS, INT. CLS. 29 AND 30.
- KRUGLER, DAVID E., EULESS, TX:
1,866,428, CANC. INT. CL. 25.
- KSL DESERT RESORTS, INC., LA QUINTA, CA:
2,533,245, PUB. 11-6-2001. INT. CL. 42.

- KUBIK, TERRY, GLENDALE, AZ:
2,533,188, PUB. 8-3-1993. INT. CL. 37.
- KURASZ, BILL, SCOTTSDALE, AZ:
2,534,887, INT. CL. 41.
- KWIK INDUSTRIES, INC., DALLAS, TX:
2,534,602, INT. CL. 37.
- KWIKEE KWIVER COMPANY, INC., ACME, MI:
1,699,214. REN. 12-19-01. INT. CL. 28.
- KYOTO KIKAI KOGU KABUSHIKI KAISHA, FUSHIMI-KU, KYOTO-SHI, KYOTO-FU, JAPAN, TA KYOTO TOOL CO., LTD.:
1,663,191. REN. 12-18-01. INT. CL. 8.
- L' OREAL, 75008 PARIS, FRANCE:
2,534,805, INT. CL. 3.
- L. L. BEAN, INC., FREEPORT, ME:
1,181,235. REN. 12-17-01. INT. CL. 25.
1,185,896. REN. 12-16-01. INT. CL. 25.
2,534,339, PUB. 11-6-2001. INT. CL. 18.
- L. R. OLIVER AND COMPANY, INC., FAIR HAVEN, MI:
1,168,057. REN. 12-17-01. INT. CL. 7.
- L.C. LICENSING, INC., NEW YORK, NY:
1,866,375, CANC. INT. CL. 18.
- L.J. SAMPSON'S PLEASING PASTRIES & GOURMET GIFT BASKETS, INC., WEST PALM BEACH, FL:
2,533,918, PUB. 11-6-2001. MULTIPLE CLASS, INT. CLS. 30 AND 35.
- L.L. BEAN, INC., FREEPORT, ME:
2,534,703, INT. CL. 28.
- L&P PROPERTY MANAGEMENT COMPANY, SOUTH GATE, CA, WESTERN TEXTILE CO., INC., CHICAGO, IL:
1,180,255. REN. 12-19-01. INT. CL. 24.
- L&P PROPERTY MANAGEMENT COMPANY, SOUTH GATE, CA, LEGGETT & PLATT, INCORPORATED, CARTHAGE, MO:
1,686,459. REN. 12-19-01. INT. CL. 20.
- L&P PROPERTY MANAGEMENT COMPANY, SOUTH GATE, CA:
2,534,549, INT. CL. 20.
- L-3 COMMUNICATIONS CORPORATION, NEW YORK, NY:
2,533,206, PUB. 11-6-2001. INT. CL. 9.
- L'AMOUR, KATHERINE E., LOS ANGELES, CA, DBA TRUSTEE OF THE LOUIS D. AND KATHERINE E. L'AMOUR 1983 TRUST, A TRUST OF CALIFORNIA:
1,866,363, CANC. INT. CL. 16.
- LA COMPAGNIE VITICOLE ET FERMIERE EDMOND ET BENJAMIN DE ROTHSCHILD S.A., GENEVE, SWITZERLAND:
1,626,205, CANC. INT. CL. 33.
- LA COSTA COMPANY LP, THE, ROCKVILLE, MD:
2,533,896, PUB. 11-6-2001. INT. CL. 21.
- LA TABACALERA, C. POR A., SANTO DOMINGO, DOMINICAN REP:
2,533,854, PUB. 11-6-2001. INT. CL. 34.
- LA TONDENA DISTILLERS, INC., SAN MIGUEL, MANILA, PHILIPPINES:
1,626,210, CANC. INT. CL. 33.
- LABFUSION, INC., TUCSON, AZ:
1,625,796, CANC. INT. CL. 9.
- LABORATOIRE INDUSTRIEL DE BIOLOGIE:
See— LIBIOL.
- LABSTAFFERS, INC., GREENSBORO, NC:
1,865,929, CANC. INT. CL. 35.
- LACOSTE ALLIGATOR S.A., 1207 GENEVA, SWITZERLAND:
1,866,413, CANC. INT. CL. 25.
1,866,414, CANC. INT. CL. 25.
1,866,415, CANC. INT. CL. 25.
1,866,416, CANC. INT. CL. 25.
- LACQUER-MAT INC., SYRACUSE, NY:
1,142,311, CANC. INT. CL. 9.
- LAFITTE SPORTMAN'S LODGE, INC., NEW ORLEANS, LA:
2,534,633, INT. CL. 42.
- LAGOS, INC., PHILADELPHIA, PA:
2,534,804, MULTIPLE CLASS, INT. CLS. 14, 20, 21 AND 30.
- LAGOSTINA S.P.A., OMEGNA (NOVARA), ITALY:
1,142,604, CANC. INT. CL. 21.
- LAGUNA APPAREL, INC.:
See— DALLAPE, DONALD A.
- LAIRD TECHNOLOGIES, INC., DELAWARE WATER GAP, PA, INSTRUMENT SPECIALTIES CO., INC., DELAWARE WATER GAP, PA:
1,660,311. REN. 12-19-01. INT. CL. 9.
- LAKESHORE EQUIPMENT COMPANY, CARSON, CA:
1,866,086, CANC. INT. CL. 42.
- LAKEWOOD PUBLICATIONS, INC., MINNEAPOLIS, MN:
1,142,516, CANC. INT. CL. 16.
- LAMARK, FRANK M., SR., ITASCA, IL:
1,865,773, CANC. INT. CL. 16.
- LAMB COMPONENTS, INC., UPLAND, CA:
1,645,920. REN. 12-19-01. INT. CL. 12.
- LAMB-WESTON, INC., KENNEWICK, WA:
2,535,032, INT. CL. 30.
- LAMONTS APPAREL, INC., BELLEVUE, WA:
1,866,465, CANC. INT. CL. 25.
- LANCASTER GROUP AG, LUDWIGSHAFEN D-67059, FED REP GERMANY:
1,866,172, CANC. INT. CL. 3.
- LANCE MFG. LLC, CHARLOTTE, NC FROM LANCE, INC., CHARLOTTE, NC:
2,534,380, MULTIPLE CLASS, INT. CLS. 29 AND 30.
- LANDWASTER BOOKS, INC., FREDERICK, MD, YENDIE BOOX PUBLISHING, INC., INDIANAPOLIS, IN:
1,659,718. REN. 12-20-01. INT. CL. 16.
- LANE, DON W., HOUSTON, TX:
2,046,265, CANC. INT. CL. 6.
- LANGER BIOMECHANICS GROUP, INC., THE, DEER PARK, NY:
1,674,130. REN. 12-19-01. INT. CL. 10.
- LANIER BUSINESS PRODUCTS, INC., ATLANTA, GA:
1,142,326, CANC. INT. CL. 9.
- LASERMASTER CORPORATION, EDEN PRAIRIE, MN:
1,865,611, CANC. INT. CL. 9.
- LASS, INC., GERING, NE:
1,650,551. REN. 12-17-01. INT. CL. 5.
- LASTRETO, INC., SAN FRANCISCO, CA:
707,940, CANC. U.S. CL. 2.
- LATELCO INCORPORATED, SAN ANTONIO, TX:
1,865,992, CANC. INT. CL. 38.
- LATHOT'S, INC., BALTIMORE, MD:
1,866,580, CANC. INT. CL. 41.
- LAUREL ENTERTAINMENT, INC., NEW YORK, NY:
1,866,017, CANC. INT. CL. 41.
- LAW, BONNIE E., BETHEL, CT:
2,533,448, PUB. 11-6-2001. INT. CL. 41.
- LAWYER'S WEEKLY, INC, BOSTON, MA:
2,535,045, INT. CL. 42.
- LAWYER-PILOTS BAR ASSOCIATION, POOLESVILLE, MD:
922,602. REN. 12-15-01. U.S. CL. 200.
- LC GREEN, INC., CITY OF INDUSTRY, CA:
2,534,057, PUB. 11-6-2001. INT. CL. 1.
- LDDS COMMUNICATIONS, INC., JACKSON, MS:
1,866,597, CANC. INT. CL. 42.
- LE BOEUF, RONNIE, JOSEPH, BATON ROUGE, LA:
2,535,132, INT. CL. 16.
- LE SPORTSAC, INC., NEW YORK, NY:
1,184,195. REN. 12-17-01. INT. CL. 42.
- LEA HALLER INTERNATIONAL, INC., SAN ANTONIO, TX:
1,865,519, CANC. INT. CL. 3.
- LEADERSHIP WORKSHOPS FOUNDATION FOR YOUTH AND FAMILY, SCOTTSDALE, AZ, LEADERSHIP WORKSHOPS, INC., SCOTTSDALE, AZ:
1,660,154. REN. 12-16-01. INT. CL. 41.
- LEAF, INC., LAKE FOREST, IL:
1,626,184, CANC. INT. CL. 30.
- LEAPFROG ENTERPRISES, INC., EMERYVILLE, CA FROM LEAPFROG, L.L.C., EMERYVILLE, CA:
2,534,367, INT. CL. 18.
- LEAPFROG ENTERPRISES, INC., EMERYVILLE, CA FROM LEAPFROG, L.L.C., EMERYVILLE, CA:
2,534,368, INT. CL. 9.

- LEAPFROG ENTERPRISES, INC., EMERYVILLE, CA FROM KNOWLEDGE KIDS ENTERPRISES, INC., EMERYVILLE, CA:
2,534,765, INT. CL. 28.
- LEASEFORUM, INC., BOSTON, MA:
2,467,866, COR. INT. CL. 36.
- LEGREG COMPANY, MERCED, CA:
2,535,085, INT. CL. 20.
- LEINER HEALTH SERVICES CORP., CARSON, CA, VITA-FRESH VITAMIN CO., INC., GARDEN GROVE, CA:
1,152,085, REN. 12-17-01. INT. CL. 5.
- LEISURE MERCHANDISING CORPORATION, NEW YORK, NY:
1,865,787, CANC. INT. CL. 18.
- LEISURETECH ELECTRONICS PTY LTD., NEW SOUTH WALES, 2015, AUSTRIA:
2,534,691, MULTIPLE CLASS, INT. CLS. 9 AND 37.
- LEK TECHNOLOGIES, INC., AMARILLO, TX:
2,533,234, PUB. 11-6-2001. INT. CL. 9.
- LEMPERT, PHILLIP, SANTA MONICA, CA:
2,534,120, PUB. 11-6-2001. INT. CL. 41.
- LENOX, INCORPORATED, LAWRENCEVILLE, NJ:
1,625,658, CANC. INT. CL. 8.
- LEON, RAYMOND, INDIO, CA:
2,533,560, PUB. 11-6-2001. INT. CL. 8.
- LEPORE PUBLISHING COMPANY, DOWNERS GROVE, IL:
1,865,779, CANC. INT. CL. 16.
- LES ENTREPRISES MICHEL CORBEIL INC., QUEBEC, CANADA:
2,533,332, PUB. 8-22-2000. INT. CL. 12.
- LES PRODUITS ASSOCIES LPA-BROXO S.A., GENEVA, SWITZERLAND:
2,533,499, PUB. 11-6-2001. INT. CL. 10.
- LES VETEMENTS S&P INC., GRANDBY, QUEBEC, CANADA FROM CANSTAR SPORTS GROUP INC., MONTREAL, QUEBEC, CANADA:
2,534,348, MULTIPLE CLASS, INT. CLS. 24 AND 25.
- LESCO TECHNOLOGIES LLC, STRONGSVILLE, OH FROM LESCO, INC., ROCKY RIVER, OH:
2,534,814, INT. CL. 1.
- LESLIE'S JEWELRY MANUFACTURING CORP., GREENWICH, CT:
1,658,934, REN. 12-21-01. INT. CL. 14.
1,664,055, REN. 12-15-01. INT. CL. 14.
- LEVEL 3 COMMUNICATIONS, INC., OMAHA, NE, FORMERLY KIEWIT DIVERSIFIED GROUP INC.:
2,534,807, MULTIPLE CLASS, INT. CLS. 37 AND 38.
- LEVINE, LARRY M., BLACKLICK, OH, DBA IMPULSE WEAR:
1,659,714, REN. 12-15-01. INT. CL. 16.
- LEVINSON MEDICAL CENTER FOR LEARNING DISABILITIES, INC., GREAT NECK, NY:
2,535,088, INT. CL. 10.
2,535,090, INT. CL. 10.
- LEVITON MANUFACTURING CO., INC., LITTLE NECK, NY:
2,485,575, COR. INT. CL. 9.
- LEWIS AND CLARK BICENTENNIAL MARKETING GROUP, INC., LAKESIDE, MN:
2,534,906, INT. CL. 29.
- LEWIS AND CLARK BICENTENNIAL MARKETING GROUP, INC., LAKESIDE, MT:
2,534,907, INT. CL. 30.
- LEXINGTON FURNITURE INDUSTRIES, INC., LEXINGTON, NC:
1,866,381, CANC. INT. CL. 20.
- LEXINGTON PROFESSIONAL BASEBALL COMPANY, LLC, LEXINGTON, KY:
2,534,916, INT. CL. 41.
- LF CORPORATION, WILMINGTON, DE, LOWE'S COMPANIES, INC., WILKESBORO, NC:
1,168,799, REN. 12-18-01. INT. CL. 42.
- LG ELECTRONICS INC., SEOUL, REPUBLIC OF KOREA:
2,534,714, INT. CL. 9.
- LH RESEARCH, IRVINE, CA:
1,142,366, CANC. INT. CL. 9.
- LIBERTY DIVERSIFIED INDUSTRIES, MINNEAPOLIS, MN:
1,663,424, REN. 12-18-01. INT. CL. 17.
- LIBERTY FINANCIAL COMPANIES, INC., BOSTON, MA:
2,534,775, INT. CL. 36.
- LIBERTY HARDWARE MFG. CORP., BOCA RATON, FL:
2,534,512, MULTIPLE CLASS, INT. CLS. 6 AND 20.
- LIBERTY LIFE ASSURANCE COMPANY OF BOSTON, BOSTON, MA:
2,534,112, PUB. 11-6-2001. INT. CL. 36.
- LIBERTY WANGER ASSET MANAGEMENT L.P., CHICAGO, IL:
2,533,345, PUB. 11-6-2001. INT. CL. 36.
- LIBIOL, MONTMORENCY, FRANCE FROM LABORATOIRE INDUSTRIEL DE BIOLOGIE, 95230 SOISY SOUS MONTMORENCY, FRANCE:
2,533,235, PUB. 11-6-2001. INT. CL. 1.
- LIDL STIFTUNG & CO. KG, 74172 NECKARSULM, FED REP GERMANY:
2,534,025, PUB. 11-6-2001. INT. CL. 29.
- LIFE SCIENCES CORPORATION, MT. LAUREL, NJ:
1,866,055, CANC. INT. CL. 42.
- LIFETIME COSMETICS, INC., DALLAS, TX:
1,866,120, CANC. MULTIPLE CLASS, INT. CLS. 3 AND 11.
- LIFETIME PRODUCTS, INC., CLEARFIELD, UT:
1,865,883, CANC. INT. CL. 28.
- LIFEWAY CHRISTIAN RESOURCES OF THE SOUTHERN BAPTIST CONVENTION, NASHVILLE, TN:
2,534,913, INT. CL. 16.
- LIGHTHOUSE COMPLIANCE, INC., LITTLE ROCK, AR:
2,533,792, PUB. 11-6-2001. INT. CL. 9.
- LIKEGLUE.COM, L.L.C., ST. CLAIR SHORES, MI:
2,533,396, PUB. 11-6-2001. INT. CL. 9.
- LILLY SOFTWARE ASSOCIATES, INC., HAMPTON, NH:
2,534,550, INT. CL. 9.
- LINA, THERESA M., ATLANTA, GA:
1,866,019, CANC. INT. CL. 41.
- LINDA DENNIS CREATIVE SERVICES, GREENVILLE, SC:
2,534,379, INT. CL. 16.
- LINDEN CORPORATION, WILMINGTON, DE, STERLING DRUG INC., NEW YORK, NY:
918,737, REN. 12-21-01. U.S. CL. 4 (INT. CL. 3).
- LINE ART, INC., HOLLYWOOD, FL:
2,534,171, PUB. 11-6-2001. INT. CL. 25.
- LINKTEK CORPORATION, OTTAWA, ONTARIO, CANADA:
1,625,752, CANC. MULTIPLE CLASS, INT. CLS. 9 AND 42.
- LINVATEC CORPORATION, LARGO, FL:
1,866,305, CANC. INT. CL. 10.
- LIP SERVICE COMMUNICATIONS, INCORPORATED, TROY, MI:
2,534,351, MULTIPLE CLASS, INT. CLS. 16 AND 24.
- LITEGLOW INDUSTRIES, INC., POMPANO BEACH, FL:
2,533,935, PUB. 11-6-2001. INT. CL. 11.
- LITTON SYSTEMS, INC., MORRIS PLAINS, NJ:
1,626,466, CANC. INT. CL. 14.
- LIVESTOCK MARKETING SERVICES CORPORATION, KANSAS CITY, MO:
1,865,612, CANC. INT. CL. 9.
1,865,613, CANC. INT. CL. 9.
- LOCAL 20408 OF THE UNITED WAREHOUSE INDUSTRIAL AND AFFILIATED TRADES EMPLOYEES, NEW YORK, NY:
1,142,990, CANC. INT. CL. 42.
- LOCKERMATE CORPORATION, MINNETONKA, MN, J. B. GOODHOUSE, INC., BLOOMINGTON, MN:
1,636,557, REN. 12-19-01. INT. CL. 20.
- LOGAN, CLINTON M., PORTSMOUTH, NH:
1,866,635, CANC. INT. CL. 36.
- LOGIC CONCEPTS INC., FAIRFIELD, OH:
1,866,300, CANC. INT. CL. 9.
- LOJO PRODUCTIONS, LAKE MARY, FL:
2,534,873, INT. CL. 28.
- LOMNITZ, FEDERICO B., D-61352 BAD HOMBURG, FED REP GERMANY:
2,533,703, PUB. 11-6-2001. INT. CL. 29.

- LONE STAR CONSOLIDATED FOODS, INC., DALLAS, TX,
LONE STAR DONUT FLOUR CORPORATION, DALLAS,
TX:
921,207. REN. 12-18-01. U.S. CL. 46 (INT. CL. 30).
- LONZA INC., FAIR LAWN, NJ:
1,680,897. REN. 12-15-01. INT. CL. 1.
- LOPEZ, EDUARDO, LOS ANGELES, CA, DBA POCHO
PRODUCTION AND ZUL, ESTEBAN, LOS ANGELES,
CA, DBA POCHO PRODUCTION AND ZAMORA, DEL,
LOS ANGELES, CA, DBA POCHO PRODUCTION:
2,533,239, PUB. 11-6-2001. INT. CL. 41.
- LORDS OF LOYALTY MOTORCYCLE CLUB, SUDIO CITY,
CA:
2,533,799, PUB. 11-6-2001. U.S. CL. 200.
- LORENZO BANFI DIFFUSION S.P.A., GALLARATE, VAR-
ESE, ITALY. DIFFUSION LORENZO BANFI BANFI
RENZO & FERRUCCIO ROSSETTI, PARABIAGO, MI-
LAN, ITALY:
1,155,675. REN. 12-16-01. INT. CL. 25.
- LOS ANGELES AUTO SALVAGE, INC., NORTH HOLLY-
WOOD, CA:
1,866,639. CANC. INT. CL. 42.
- LOS ANGELES COUNTY METROPOLITAN TRANSPORTA-
TION AUTHORITY, LOS ANGELES, CA:
1,866,569. CANC. INT. CL. 39.
- LOS ANGELES KINGS HOCKEY CLUB, L.P., THE, LOS
ANGELES, CA, CALIFORNIA SPORTS INCORPORATED,
INGLEWOOD, CA:
921,756. REN. 12-15-01. U.S. CL. 107 (INT. CL. 41).
921,757. REN. 12-15-01. U.S. CL. 107 (INT. CL. 41).
- LOS SOMBREROS, INC., DOWNERS GROVE, IL:
1,866,070. CANC. INT. CL. 42.
- LOTTO DESIGN GROUP, THE, WESTLAKE VILLAGE, CA:
2,534,945, INT. CL. 20.
2,534,946, INT. CL. 42.
- LOUISIANA ONLINE, INC., BATON ROUGE, LA:
2,534,977, INT. CL. 35.
- LOVABLE COMPANY, THE, BUFORD, GA:
1,626,059. CANC. INT. CL. 25.
- LOVELL-SCHENCK, INC., CHARLOTTE, NC:
1,625,840. CANC. INT. CL. 10.
- LOWELL, RACHELLE D., ATLANTA, GA, DBA SHELLEY
LOWELL AND SHELLEY LOWELL DESIGN:
1,142,939. CANC. INT. CL. 42.
- LOWER PACKING CO., INC., RICHMOND, UT:
2,533,614, PUB. 11-6-2001. INT. CL. 29.
- LTG, LTD., FARGO, ND:
2,534,793, INT. CL. 11.
- LUCA, VALENTIN, FAIRFIELD, CT:
2,533,353, PUB. 11-6-2001. INT. CL. 6.
- LUCAS LICENSING LTD., NICASIO, CA FROM LUCAS-
FILM LTD., NICASIO, CA:
2,534,384, INT. CL. 28.
- LUCASFILM LTD., NICASIO, CA:
2,534,385, INT. CL. 25.
2,534,386, INT. CL. 20.
- LUCENT TECHNOLOGIES INC., MURRAY HILL, NJ:
2,534,730, INT. CL. 9.
- LUCILLE FARMS, INC., MONTVILLE, NJ:
1,859,827. CANC. INT. CL. 29.
- LUCK; MICHAEL A. J., ST. LOUIS, MO, DBA PLANNED
FUTURES:
1,172,549. REN. 12-20-01. INT. CL. 36.
- LUCK, MICHAEL A.J., ST LOUIS, MO, DBA PLANNED
FUTURES:
1,176,485. REN. 12-20-01. INT. CL. 36.
- LUIGI'S PIZZA FACTORY, LTD, CEDAR GROVE, WI:
2,534,276, PUB. 11-6-2001. INT. CL. 30.
- LUMBER FINISHERS INCORPORATED, GRAFTON, MA:
2,533,624, PUB. 11-6-2001. INT. CL. 2.
- LUXO LABORATORIES LIMITED, TORONTO, ONTARIO,
M5G 1C3, CANADA:
2,533,475, PUB. 11-6-2001. INT. CL. 3.
- LXE INC., NORCROSS, GA:
2,534,546, INT. CL. 9.
- LYN, DAVID, WESTCHESTER, CA:
2,534,564, INT. CL. 41.
- LYNRUS ALUMINUM PRODUCTS, L.L.C., SALT LAKE
CITY, UT:
2,534,147, PUB. 11-6-2001. INT. CL. 11.
- LYON METAL PRODUCTION, L.L.C., MONTGOMERY, IL,
LYON METAL PRODUCTS, INCORPORATED, AURORA,
IL:
545,042. REN. 12-20-01. U.S. CL. 2 (INT. CL. 6).
- M & C TOY CENTRE LTD., TSMISHATSUI EAST, KOW-
LOON, HONG KONG:
2,534,883, INT. CL. 28.
2,534,885, INT. CL. 28.
2,534,886, INT. CL. 28.
- M MODELS INC., LAS VEGAS, NV:
2,533,826, PUB. 11-6-2001. INT. CL. 35.
- M. BLAIS CO., INC., NAPLES, FL:
1,625,621. CANC. INT. CL. 6.
1,625,622. CANC. INT. CL. 6.
- M. E. SHAW & SONS, LOS ANGELES, CA:
707,934. CANC. U.S. CL. 2.
- M. W. SAMARA, INC., HAWTHORNE, NY:
1,172,197. REN. 12-20-01. INT. CL. 14.
- M.N.P.M., L.L.C., TRAVERSE CITY, MI:
2,534,462, INT. CL. 42.
- MACK TRUCKS, INC., ALLENTOWN, PA:
1,142,252. CANC. MULTIPLE CLASS, INT. CLS. 7, 9 AND
12.
- MACRO INTERNATIONAL INC., BETHESDA, MD:
2,533,930, PUB. 11-6-2001. INT. CL. 9.
- MACSFORMS, INC., FOREST HILLS, NY:
1,665,542. REN. 12-15-01. INT. CL. 42.
- MAD ABOUT YOU, INC., NEW YORK, NY:
1,865,841. CANC. INT. CL. 25.
- MADAUS MURDOCK, INC., SPRINGVILLE, UT:
1,866,177. CANC. INT. CL. 5.
- MADIFIDE, INC., CAGUAS, PUERTO RICO, CENTURY-ML
RADIO VENTURE, NEW YORK, NY:
1,607,730. REN. 12-19-01. INT. CL. 41.
- MADISON GROUP, THE, HUNTINGTON BEACH, CA:
2,535,118, INT. CL. 16.
- MAGELANG INSTITUTE, LTD., MENLO PARK, CA:
2,534,671, INT. CL. 42.
- MAGIC SOFTWARE ENTERPRISES LTD., OR-YEHUDA
60218, ISRAEL:
2,533,372, PUB. 11-6-2001. INT. CL. 42.
- MAHARISHI AYURVEDA PRODUCTS INTERNATIONAL
INC., LANCASTER, MA:
1,866,615. CANC. INT. CL. 5.
- MAIER & CO. FABRIK FUR SPEZIALMASCHINEN, HAL-
LEIN, SALZBURG, AUSTRIA:
1,142,234. CANC. INT. CL. 7.
- MAIL SORT, INC., NORTHBROOK, IL:
2,533,973, PUB. 11-6-2001. INT. CL. 42.
- MAINE NUTRITIONALS, INC., HOULTON, ME:
2,534,330, PUB. 11-6-2001. INT. CL. 5.
- MAJESTIC ATHLETIC WEAR, LTD., PEN ARGYL, PA:
1,866,441. CANC. INT. CL. 25.
- MAJOR MARKETING, INC., CHICAGO, IL:
2,534,074, PUB. 11-6-2001. INT. CL. 30.
- MAKE-UP ART COSMETICS INC., NEW YORK, NY:
2,534,719, INT. CL. 3.
- MALIBU COMICS ENTERTAINMENT, INC., WESTLAKE
VILLAGE, CA:
1,866,294. CANC. INT. CL. 9.
- MALIBU COMICS ENTERTAINMENT, INC., CALABASAS,
CA:
1,866,349. CANC. INT. CL. 16.
- MALONE, MICHAEL DENNIS, ALLSTON, MA:
1,866,021. CANC. INT. CL. 41.
- MAMISON CO., LTD., KYUNGKI-DO, REPUBLIC OF KOR-
EA:
2,533,334, PUB. 11-6-2001. INT. CL. 21.
- MAN FOR THE JOB, THE, SHENANDOAH, IA:
2,533,677, PUB. 11-6-2001. INT. CL. 37.
- MANLEY TOYS U.S.A., LTD., NEW YORK, NY:
2,534,987, INT. CL. 28.
- MANN, BOB, ARROYO GRANDE, CA:
1,866,493. CANC. INT. CL. 28.

- MANNA PRO CORPORATION, ST. LOUIS, MO:
1,701,362. REN. 12-17-01. MULTIPLE CLASS, INT. CLS. 5 AND 31.
- MANOR HEALTHCARE CORP., SILVER SPRING, MD:
1,866,608. CANC. INT. CL. 42.
- MANUFACTURAS ANTONIO GASSOL, S.A., BARCELONA, SPAIN:
1,865,847. CANC. INT. CL. 25.
- MANUFACTURING TECHNOLOGY STRATEGIES, INC., ST. LOUIS, MO:
1,626,341. CANC. INT. CL. 41.
- MAPA PIONEER CORPORATION, WILLARD, OH, DBA PIONEER INDUSTRIAL PRODUCTS:
1,659,591. REN. 12-16-01. INT. CL. 9.
- MARAHON INTERNATIONAL LIMITED, KOWLOON, HONG KONG:
1,866,377. CANC. INT. CL. 18.
- MARATHON ASHLAND PETROLEUM LLC, FINDLAY, OH, MARATHON OIL COMPANY, FINDLAY, OH:
1,186,341. REN. 12-19-01. INT. CL. 4.
- MARCH OF DIMES BIRTH DEFECTS FOUNDATION, WHITE PLAINS, NY:
2,534,098. PUB. 11-6-2001. INT. CL. 42.
- MARCHON EYEWEAR INC., MELVILLE, NY:
1,866,272. CANC. INT. CL. 9.
- MARCO'S INC., TOLEDO, OH, MARCO'S INC., TOLEDO, OH:
1,172,629. REN. 12-21-01. INT. CL. 42.
- MARI TELECOM, CO. LTD., SAN JOSE, CA:
2,534,800. MULTIPLE CLASS, INT. CLS. 25 AND 41.
- MARIETTA CORPORATION, CORTLAND, NY:
1,659,351. REN. 12-21-01. MULTIPLE CLASS, INT. CLS. 3, 21, 23 AND 25.
- MARINE INDUSTRIES ASSOCIATION OF SOUTH FLORIDA, INC., FORT LAUDERDALE, FL:
1,626,241. CANC. MULTIPLE CLASS, INT. CLS. 35 AND 42.
- MARINE MIDLAND BANKS, INC., BUFFALO, NY:
1,626,291. CANC. INT. CL. 36.
- MARINO LIVING TRUST, HOLBROOK, NY, S.M.B. CELSIUS COMPANY, INC., PLAINVIEW, NY:
1,612,800. REN. 12-19-01. INT. CL. 9.
- MARIO VALENTINO S.P.A., 85, NAPOLI, ITALY:
1,621,113. REN. 12-17-01. MULTIPLE CLASS, INT. CLS. 14 AND 26.
- MARJHAN, INC., LA JOLLA, CA:
1,865,986. CANC. INT. CL. 37.
- MARKET DAY CORPORATION, ITASCA, IL:
2,533,562. PUB. 10-31-2000. INT. CL. 16.
- MARKET FACTS, INC., ARLINGTON HEIGHTS, IL:
2,197,591. AM. INT. CL. 35.
- MARLYN NUTRACEUTICALS, INC., SCOTTSDALE, AZ, DBA NATURALLY VITAMINS:
2,534,516. INT. CL. 42.
- MARNEL PHARMACEUTICAL, INC., LAFAYETTE, LA:
922,219. REN. 12-19-01. U.S. CL. 18 (INT. CL. 5).
- MARQUETTE UNIVERSITY, MILWAUKEE, WI:
2,533,880. PUB. 11-6-2001. INT. CL. 41.
- MARR GROUP LIMITED, OAKVILLE, ONTARIO, CANADA:
1,866,276. CANC. INT. CL. 9.
1,866,277. CANC. INT. CL. 9.
1,866,278. CANC. INT. CL. 9.
1,866,279. CANC. INT. CL. 9.
1,866,280. CANC. INT. CL. 9.
1,866,281. CANC. INT. CL. 9.
- MARRIOTT INTERNATIONAL, INC., BETHESDA, MD:
2,534,673. INT. CL. 36.
- MARS, INCORPORATED, MCLEAN, VA:
1,660,960. REN. 12-18-01. INT. CL. 28.
2,533,660. PUB. 11-6-2001. INT. CL. 9.
2,533,665. PUB. 11-6-2001. INT. CL. 21.
2,533,666. PUB. 11-6-2001. INT. CL. 21.
2,533,667. PUB. 11-6-2001. INT. CL. 21.
2,533,668. PUB. 11-6-2001. INT. CL. 21.
2,533,683. PUB. 11-6-2001. INT. CL. 21.
2,533,684. PUB. 11-6-2001. INT. CL. 16.
2,533,685. PUB. 11-6-2001. INT. CL. 21.
2,533,686. PUB. 11-6-2001. INT. CL. 21.
2,533,687. PUB. 11-6-2001. INT. CL. 21.
2,533,688. PUB. 11-6-2001. INT. CL. 21.
2,533,689. PUB. 11-6-2001. INT. CL. 21.
- MARTHA A. GOTTFRIED, INC., PALM BEACH, FL:
2,533,885. PUB. 11-6-2001. INT. CL. 36.
- MARTIN YALE INDUSTRIES, INC., WABASH, IN:
2,534,394. INT. CL. 16.
- MARTUCCI, THOMAS V., BETHANY, CT:
2,533,605. PUB. 11-6-2001. INT. CL. 35.
- MARUHACHI CERAMICS OF AMERICA, INC., CORONA, CA:
1,670,268. REN. 12-18-01. INT. CL. 19.
- MARUSICH, ED, SANTA MONICA, CA, DBA INLINE WEAR:
1,865,860. CANC. INT. CL. 25.
- MARY KAY INC., DALLAS, TX:
2,534,808. INT. CL. 3.
- MASEK, RICHARD T., LA MESA, CA:
2,533,327. PUB. 11-6-2001. INT. CL. 41.
- MASIMO CORPORATION, IRVINE, CA:
2,533,974. PUB. 11-6-2001. INT. CL. 10.
- MASLEY, FRANCIS, J., WILMINGTON, DE:
2,534,986. INT. CL. 40.
- MASS CONFUSION, ORLANDO, FL:
1,865,837. CANC. INT. CL. 25.
- MASTER COATING TECHNOLOGIES, INC., MINNEAPOLIS, MN:
2,533,941. PUB. 11-6-2001. INT. CL. 2.
- MASTER LOCK COMPANY, MILWAUKEE, WI:
1,660,260. REN. 12-16-01. INT. CL. 6.
- MASTER PNEUMATIC-DETROIT, INC., STERLING HEIGHTS, MI, MASTER PNEUMATIC, INC., DETROIT, MI:
696,278. REN. 12-19-01. U.S. CL. 13 (INT. CL. 6).
- MASTERCARD INTERNATIONAL INCORPORATED, NEW YORK, NY:
1,865,944. CANC. INT. CL. 35.
- MATHIS, MIMI L., FAYETTEVILLE, AR:
2,534,966. INT. CL. 28.
- MATRICES CORPORATION:
See—CONCENTRIX CORPORATION.
- MATTEL, INC., EL SEGUNDO, CA, IDEAL TOY CORPORATION, HOLLIS, NY:
921,518. REN. 12-19-01. U.S. CL. 22 (INT. CL. 28).
- MATTEL, INC., EL SEGUNDO, CA:
2,534,580. INT. CL. 28.
2,534,588. INT. CL. 28.
- MATTHEWS STUDIO EQUIPMENT, INC., BURBANK, CA:
1,664,883. REN. 12-15-01. INT. CL. 9.
- MATTIOLI ENGINEERING LTD., LONDON, UNITED KINGDOM FROM MATTIOLI ENGINEERING S.R.L., 50125 FLORENCE, ITALY:
2,534,382. INT. CL. 10.
- MAUI MEDICINAL HERBS, INC., MAKAWAO, HI:
2,535,065. INT. CL. 30.
- MAULHARDT, ANDREAS, WEST VANCOUVER, BRITISH COLUMBIA, CANADA, DBA O'MY PRODUCTS AND UNCYNK, MURRAY, BRITISH COLUMBIA, CANADA, DBA O'MY PRODUCTS:
2,533,391. PUB. 11-6-2001. INT. CL. 5.
- MAUNA LOA MACADAMIA NUT CORPORATION, HILO, HI:
2,533,504. PUB. 11-6-2001. INT. CL. 35.
- MAURO, JOHN J., COS COB, CT:
1,866,553. CANC. INT. CL. 36.
- MAYBELLINE CO., NORTH LITTLE ROCK, AR:
1,142,184. CANC. INT. CL. 3.

- MAYO FOUNDATION FOR MEDICAL EDUCATION AND RESEARCH, ROCHESTER, MN:
2,534,282, PUB. 11-6-2001. INT. CL. 42.
- MAYTAG CORPORATION, NEWTON, IA, ADMIRAL CORPORATION, CHICAGO, IL:
549,908. REN. 12-20-01. U.S. CL. 21 (INT. CL. 9).
- MBBC VERMONT, LLC, WINDSOR, VT:
2,533,961, PUB. 11-6-2001. INT. CL. 32.
- MCCLELLAN INDUSTRIES, INC., TRAVERSE CITY, MI:
1,142,696, CANC. INT. CL. 28.
- MCCLURE, CINDY M., CAMAS, WA:
2,534,596, INT. CL. 28.
- MCGRAW-HILL COMPANIES, INC., THE, NEW YORK, NY, MCGRAW-HILL PUBLISHING COMPANY, INC., NEW YORK, NY:
549,742. REN. 12-21-01. U.S. CL. 38 (INT. CL. 16).
- MCGRAW-HILL COMPANIES, INC., THE, NEW YORK, NY FROM EVERYDAY LEARNING CORPORATION, CHICAGO, IL:
2,534,734, INT. CL. 16.
- MCGREW.NET INC., OLYMPIA, WA:
2,533,990, PUB. 11-6-2001. MULTIPLE CLASS, INT. CLS. 41 AND 42.
- MCGUIRE, PAUL, A., URBANA, OH:
2,534,322, PUB. 11-6-2001. INT. CL. 9.
- MCI COMMUNICATIONS CORPORATION, WASHINGTON, DC:
1,660,102. REN. 12-18-01. INT. CL. 38.
1,865,995, CANC. INT. CL. 38.
- MCKEE FOODS CORPORATION, COLLEGEDALE, TN, BETTER FOODS, INC., OOLTEWAH, TN, AKA SUNRISE FARM PRODUCTS:
1,149,968. REN. 12-20-01. INT. CL. 29.
- MCKESSON CORPORATION, SAN FRANCISCO, CA:
1,865,713, CANC. INT. CL. 11.
- MCWHORTER TECHNOLOGIES, INC., CARPENTERSVILLE, IL:
2,534,620, INT. CL. 2.
- MDC COMMUNICATIONS CORPORATION:
See—MDC CORPORATION INC..
- MDC CORPORATION INC., TORONTO, CANADA FROM MDC COMMUNICATIONS CORPORATION, TORONTO, ONTARIO, CANADA:
2,533,280, PUB. 11-6-2001. INT. CL. 42.
- MDI GUAM CORPORATION, AGANA, GUAM:
1,866,568, CANC. INT. CL. 39.
- ME AND GIA, INC., ELMWOOD PARK, IL:
2,533,825, PUB. 11-6-2001. MULTIPLE CLASS, INT. CLS. 30 AND 42.
- MEAD CORPORATION, THE, DAYTON, OH, DBA GILBERT PAPER COMPANY:
1,142,489, CANC. INT. CL. 16.
- MEAD CORPORATION, THE, DAYTON, OH:
1,625,974, CANC. INT. CL. 16.
2,534,899, INT. CL. 16.
- MEAD JOHNSON & COMPANY, EVANSVILLE, IN:
2,534,471, INT. CL. 5.
- MEADOW, SCOTT F., CHICAGO, IL:
1,866,602, CANC. INT. CL. 42.
- MEASUREMENT CONCEPT CORPORATION, ROME, NY:
1,142,936, CANC. INT. CL. 42.
- MECHANICAL MFG. CORPORATION, SUNRISE, FL:
1,865,717, CANC. INT. CL. 11.
- MECHLIN, DAVID W., WASHINGTON, DC, TA DAVID MECHLIN:
1,659,176. REN. 12-20-01. INT. CL. 42.
- MEDCAM U.S.A., INC., BOCA RATON, FL:
1,865,705, CANC. INT. CL. 10.
- MEDIAADDICT, INC., JERSEY CITY, NJ:
2,534,144, PUB. 11-6-2001. INT. CL. 41.
- MEDIAMAP, INC., CAMBRIDGE, MA, CAMBRIDGE COMMUNICATIONS, BEDFORD, MA:
1,642,070. REN. 12-16-01. INT. CL. 16.
- MEDIASMITT, INC., SAN FRANCISCO, CA:
2,533,625, PUB. 11-6-2001. MULTIPLE CLASS, INT. CLS. 35 AND 42.
- MEDICAL BENEFITS ADMINISTRATORS, INC., NEWARK, OH:
2,534,272, PUB. 11-6-2001. INT. CL. 42.
- MEDICAL CARBON RESEARCH INSTITUTE, LLC, AUSTIN, TX:
2,533,890, PUB. 11-6-2001. INT. CL. 10.
- MEDICAL DOCTOR ASSOCIATES, INC., NORCROSS, GA:
2,535,014, INT. CL. 35.
- MEDICAL SPECIALTIES INCORPORATED, CHARLOTTE, NC:
1,180,983. REN. 12-21-01. INT. CL. 10.
- MEDICHEM RESEARCH, INC., LEMONT, IL:
2,534,141, PUB. 11-6-2001. INT. CL. 42.
- MEDICO SPORTS FASHION GMBH, 72461 ALBSTADT, FED REP GERMANY, MEDICO AMMANN & BITZER KG, ALBSTADT-TAILFINGEN, FED REP GERMANY:
1,173,398. REN. 12-17-01. INT. CL. 25.
- MEDIVISIONS, INC., SEATTLE, WA:
1,877,512, CANC. INT. CL. 10.
- MEDPANEL, INC., CAMBRIDGE, MA:
2,535,044, MULTIPLE CLASS, INT. CLS. 38 AND 42.
- MEDPERKS, INC., ALPHARETTA, GA:
2,534,499, MULTIPLE CLASS, INT. CLS. 35 AND 42.
- MEGA PRO, INC., ARVADA, CO:
1,866,488, CANC. INT. CL. 28.
- MEGNAPOINT CORPORATION, ROOSEVELT, NY:
2,534,035, PUB. 11-6-2001. INT. CL. 42.
- MEL BAY PUBLICATIONS, INC., PACIFIC, MO:
1,704,976. REN. 12-17-01. INT. CL. 16.
- MELALEUCA, INC., IDAHO FALLS, ID:
2,535,089, MULTIPLE CLASS, INT. CLS. 3 AND 4.
- MELITA INTERNATIONAL CORPORATION, NORCROSS, GA:
1,866,214, CANC. INT. CL. 9.
- MELLON FINANCIAL CORPORATION, PITTSBURGH, PA:
2,534,877, INT. CL. 36.
- MELMAR CONCESSIONS, INC., LAKE ELMO, MN:
2,533,891, PUB. 11-6-2001. INT. CL. 35.
- MEM COMPANY, INC., NORTHVALE, NJ:
1,865,525, CANC. INT. CL. 3.
- MENASHA CORPORATION, NEENAH, WI:
1,625,977, CANC. INT. CL. 17.
- MERCER, TODD, BRYANT, CHEBOYGAN, MI:
2,534,955, INT. CL. 16.
- MERCHANTS FAST MOTOR LINES, INC., ABILENE, TX:
1,865,614, CANC. INT. CL. 9.
- MERCK-MEDCO MANAGED CARE, L.L.C., FRANKLIN LAKES, NJ:
2,533,721, PUB. 8-28-2001. INT. CL. 42.
2,533,722, PUB. 2-13-2001. INT. CL. 16.
- MERCURY ENTERPRISES, INC., CLEARWATER, FL:
1,865,694, CANC. INT. CL. 10.
- MEREDITH CORPORATION, DES MOINES, IA:
2,534,509, INT. CL. 42.
- MERIDIAN DIAGNOSTICS, INC., CINCINNATI, OH:
2,533,289, PUB. 11-6-2001. INT. CL. 5.
- MERIT MEDICAL SYSTEMS, INC., SOUTH JORDAN, UT:
2,533,621, PUB. 11-6-2001. INT. CL. 10.
- MERRILL LYNCH & CO., INC., NEW YORK, NY:
1,626,403, CANC. INT. CL. 42.
- MERSE, JO ANN, METAIRIE, LA:
1,700,821. REN. 12-19-01. INT. CL. 36.
- MESA AUTO X-CHANGE, INC., MESA, AZ:
2,535,052, INT. CL. 35.
- MESA WEST MEDICAL, A PRIMARY CARE MEDICAL GROUP, INC., BAKERSFIELD, CA:
2,534,020, PUB. 11-6-2001. INT. CL. 42.
- MESERVE, PAUL J., GORHAM, ME:
2,534,132, PUB. 11-6-2001. INT. CL. 29.
- MESIROW FINANCIAL HOLDINGS, INC., CHICAGO, IL:
1,865,974, CANC. INT. CL. 36.
- METAGENICS, INC., SAN CLEMENTE, CA:
2,534,753, INT. CL. 5.
- METAL WARE CORPORATION, TWO RIVERS, WI, NATIONAL ENAMELING & STAMPING COMPANY, MILWAUKEE, WI:
392,958. REN. 12-20-01. U.S. CL. 21 (INT. CL. 11).

- METAMOR SOFTWARE SOLUTIONS, INC.:
See— VANTEON CORPORATION.
- METASYS PRODUKTIONSGES.M.B.H, 6020 INNSBRUCK, AUSTRIA:
1,866,318, CANC. INT. CL. 11.
- METRIS DIRECT, INC., ST. LOUIS PARK, MN:
2,534,811, INT. CL. 36.
- METRO-GOLDWYN-MAYER LION CORP., SANTA MONICA, CA:
2,534,227, PUB. 11-6-2001. INT. CL. 41.
- METROCALL, INC., ALEXANDRIA, VA:
2,533,467, PUB. 11-6-2001. INT. CL. 38.
- METROPOLITAN MUSEUM OF ART, THE, NEW YORK, NY:
1,660,156. REN. 12-18-01. INT. CL. 41.
1,661,733. REN. 12-18-01. INT. CL. 18.
1,666,757. REN. 12-20-01. INT. CL. 20.
- METTS, RODNEY H., COLUMBIA, SC:
1,659,141. REN. 12-20-01. INT. CL. 41.
- METZGER/MCGUIRE CO., CONCORD, NH:
1,625,483, CANC. INT. CL. 1.
- MEXICAN CULTURAL INSTITUTE OF HOUSTON, INC., HOUSTON, TX:
2,534,055, PUB. 11-6-2001. INT. CL. 41.
- MEYER MANUFACTURING COMPANY LIMITED, KWUN TONG, KOWLOON, HONG KONG:
1,866,398, CANC. INT. CL. 21.
- MEYER PLASTICS, INC., INDIANAPOLIS, IN:
1,142,417, CANC. INT. CL. 12.
- MGRR, INC., WILMINGTON, DE:
1,866,051, CANC. INT. CL. 42.
- MICHAEL G. HEILMANN P.C., SOUTHFIELD, MI:
2,534,160, PUB. 11-6-2001. INT. CL. 42.
- MICHELIN NORTH AMERICA, INC., GREENVILLE, SC:
2,534,665, INT. CL. 12.
- MICHIGAN BREWING COMPANY, INC., WEBBERVILLE, MI:
2,533,420, PUB. 11-6-2001. INT. CL. 32.
- MICHIGAN ECONOMIC DEVELOPMENT CORPORATION, LANSING, MI:
2,535,054, INT. CL. 41.
- MICHIGAN WHEEL CORPORATION, GRAND RAPIDS, MI, MICHIGAN WHEEL CORPORATION, GRAND RAPIDS, MI:
921,456. REN. 12-19-01. U.S. CL. 19 (INT. CL. 12).
- MICRO-MIRROR CORPORATION, FARMINGTON HILLS, MI:
1,142,248, CANC. INT. CL. 7.
1,142,249, CANC. INT. CL. 7.
- MICROBURST, INC., ROCKVILLE, MD:
2,534,446, MULTIPLE CLASS, INT. CLS. 41 AND 42.
- MICROPLEX SYSTEMS LTD., VANCOUVER, B.C., CANADA:
1,625,673, CANC. INT. CL. 9.
- MICROSOFT CORPORATION, REDMOND, WA:
2,534,778, INT. CL. 36.
- MIDAMERICA FEDERAL SAVINGS BANK, CLARENDON HILLS, IL:
1,946,754, CANC. INT. CL. 36.
- MIDDLEBY MARSHALL, INC., ELGIN, IL:
1,670,790. REN. 12-20-01. INT. CL. 11.
- MIDDLEBY-MARSHALL OVEN COMPANY, INC., MORTON GROVE, IL:
708,091, CANC. U.S. CL. 34.
- MIDICA ESTABLISHMENT, 9490 VADUZ, LIECHTENSTEIN, LALAOUNIS, ELIE, PARIS (LER), FRANCE:
918,893. REN. 12-19-01. U.S. CL. 28 (INT. CL. 14).
- MIDWAY AMUSEMENT GAMES, LLC, CHICAGO, IL:
2,534,749, INT. CL. 28.
- MIDWEST INSTITUTE FOR CLINICAL RESEARCH, INC., INDIANAPOLIS, IN:
1,659,190. REN. 12-19-01. INT. CL. 42.
- MIDWEST RESEARCH INSTITUTE, INC., KANSAS CITY, MO:
920,883. REN. 12-15-01. U.S. CL. 100 (INT. CL. 42).
- MIDWEST TELEVISION, INC., SAN DIEGO, CA:
2,534,052, PUB. 11-6-2001. INT. CL. 41.
- MILLENNIUM CUSTOM FOODS, INC., ARLINGTON HEIGHTS, IL:
2,534,155, PUB. 11-6-2001. INT. CL. 29.
- MILLER BREWING COMPANY, MILWAUKEE, WI:
1,866,536, CANC. INT. CL. 32.
- MILLER, CATHERINE, SAN DIEGO, CA, DBA CATHERINE MILLER & ASSOCIATES:
2,534,170, PUB. 11-6-2001. INT. CL. 35.
- MILLER, MARK D., LIBERTY, MO:
2,533,699, PUB. 11-6-2001. INT. CL. 36.
- MILLER, RUSSELL, NEW YORK, NY:
2,534,652, INT. CL. 16.
- MILLIKEN & COMPANY, NEW YORK, NY:
1,142,674, CANC. INT. CL. 27.
- MILLIMAN & ROBERTSON, INC., SEATTLE, WA:
2,535,009, INT. CL. 35.
2,535,010, INT. CL. 16.
- MILLIPORE CORPORATION, BEDFORD, MA:
1,142,400, CANC. INT. CL. 11.
- MILLIPORE INVESTMENT HOLDINGS LIMITED, WILMINGTON, DE:
2,533,607, PUB. 11-6-2001. INT. CL. 9.
- MILWAUKEE ELECTRIC TOOL CORPORATION, BROOKFIELD, WI:
917,618. REN. 12-19-01. U.S. CL. 23 (INT. CL. 7).
- MILWAUKEE PUBLIC LIBRARY BOARD OF TRUSTEES, MILWAUKEE, WI:
2,534,239, PUB. 11-6-2001. INT. CL. 41.
- MILWAUKEE WORLD FESTIVAL, INC., MILWAUKEE, WI:
1,659,291. REN. 12-15-01. INT. CL. 41.
- MINDBRIDGE.COM, INC., FORT WASHINGTON, PA:
2,534,453, INT. CL. 9.
- MINNESOTA MINING AND MANUFACTURING COMPANY, ST. PAUL, MN, POLAROID CORPORATION, CAMBRIDGE, MA:
1,660,322. REN. 12-18-01. INT. CL. 9.
- MINNESOTA PUBLIC RADIO, ST. PAUL, MN:
2,534,182, PUB. 11-6-2001. INT. CL. 41.
2,534,183, PUB. 11-6-2001. INT. CL. 41.
- MIREILLE'S INFLIGHT CATERING, LAKEWOOD, CA:
2,533,734, PUB. 11-6-2001. INT. CL. 42.
- MISSOURI EMPLOYERS MUTUAL INSURANCE, COLUMBIA, MO:
2,533,564, PUB. 11-6-2001. INT. CL. 9.
2,533,565, PUB. 11-6-2001. INT. CL. 35.
- MISSOURI STATE EMPLOYEES' RETIREMENT SYSTEM, JEFFERSON CITY, MO:
2,533,796, PUB. 11-6-2001. INT. CL. 36.
- MITSUBISHI ELECTRIC CORPORATION, CHIYODA-KU, TOKYO, JAPAN:
1,173,977. REN. 12-19-01. INT. CL. 9.
- MITSUI FOODS, INC., HACKENSACK, NJ, ALGARVE EXPORTADOR, LDA., LISBON, PORTUGAL:
548,515. REN. 12-17-01. U.S. CL. 46 (INT. CL. 29).
- MITSUTOYO CO., LTD., LOS ANGELES, CA:
2,534,069, PUB. 11-6-2001. INT. CL. 29.
- MIXER SYSTEMS, INC., PEWAUKEE, WI:
1,666,454. REN. 12-17-01. INT. CL. 7.
- MIZUNO KABUSHIKI KAISHA (MIZUNO CORPORATION), CHUO-KU, OSAKA, JAPAN:
2,534,716, INT. CL. 28.
- MJP BOTANICALS, INC., TUCSON, AZ:
2,534,511, MULTIPLE CLASS, INT. CLS. 5 AND 42.
- MKS INSTRUMENTS, INC., ANDOVER, MA:
1,197,782. REN. 12-19-01. INT. CL. 9.
- MMC HEALTH SYSTEMS, INC., MEADVILLE, PA, EXCEPTIONAL CANCER PATIENTS, INC., WOODBRIDGE, CT:
1,177,626. REN. 12-19-01. INT. CL. 41.
- MOBIL OIL CORPORATION, FAIRFAX, VA:
2,533,473, PUB. 11-6-2001. INT. CL. 4.
- MOBILESPRING, INC., NEW YORK, NY:
2,534,880, INT. CL. 38.
2,534,881, INT. CL. 35.
- MODULARLS, INC., CHICAGO, IL:
2,533,876, PUB. 11-6-2001. MULTIPLE CLASS, INT. CLS. 9 AND 42.
- MOHN ELECTRIC COMPANY, MINNEAPOLIS, MN:
1,142,893, CANC. MULTIPLE CLASS, INT. CLS. 37 AND

42.
MOHR GRAPHICS AND PUBLISHING, INC., PALM CITY, FL:
 2,535,117, INT. CL. 16.
- MOLECULAR BIO-PRODUCTS, INC., SAN DIEGO, CA, CONTINENTAL LABORATORY PRODUCTS, SAN DIEGO, CA:**
 1,662,294, REN. 12-17-01, INT. CL. 9.
- MOLLIKA, DAVID, HUNTINGTON BEACH, CA:**
 2,534,087, PUB. 11-6-2001, INT. CL. 41.
- MOLSON BREWERIES, TORONTO, ONTARIO, CANADA:**
 2,533,190, PUB. 2-22-1994, INT. CL. 32.
- MOMONOYA HONPO, CO., LTD., OKAYAMA 702, JAPAN:**
 2,534,043, PUB. 11-6-2001, INT. CL. 30.
- MONEY-PASS.COM CORP., SCARSDALE, NY:**
 2,534,972, INT. CL. 36.
- MONICA CECILE ANGULO, SAN JOSE, CA, DBA TEASERS ONLINE:**
 2,533,887, PUB. 11-6-2001, INT. CL. 35.
- MONK, ELMER, W., CINCINNATI, OH:**
 2,534,002, PUB. 11-6-2001, INT. CL. 9.
- MONOGRAM AEROSPACE FASTENERS, INC., LOS ANGELES, CA, MAG AEROSPACE INDUSTRIES, INC., LOS ANGELES, CA:**
 1,719,817, REN. 12-17-01, INT. CL. 6.
- MONSANTO TECHNOLOGY LLC, ST. LOUIS, MO, MONSANTO COMPANY, ST. LOUIS, MO:**
 915,850, REN. 12-21-01, U.S. CL. 6 (INT. CL. 5).
- MONTEFIORE MEDICAL CENTER, BRONX, NY:**
 1,866,067, CANC. INT. CL. 42.
- MOODY BIBLE INSTITUTE, CHICAGO, IL:**
 2,534,718, INT. CL. 16.
- MOOSEHEAD BREWERIES LIMITED, SAINT JOHN, NEW BRUNSWICK, CANADA:**
 2,533,482, PUB. 11-6-2001, INT. CL. 32.
- MOOSEHEAD BREWERIES LIMITED, SAINT JOHN, NEW BRUNSWICK, CANADA FROM LANG FAMILY DISTILLERIES INC., PORT MOODY, BRITISH COLUMBIA, CANADA:**
 2,534,345, INT. CL. 33.
- MORAMARCO, GREGG, WESTBURY, NY:**
 2,535,100, MULTIPLE CLASS, INT. CLS. 16 AND 25.
- MOREHEAD, INC., BALDWIN, KS:**
 1,625,956, CANC. INT. CL. 16.
- MORGAN CONSTRUCTION COMPANY, WORCESTER, MA:**
 2,534,470, INT. CL. 11.
- MORRILTON AREA CHAMBER OF COMMERCE, MORRILTON, AR:**
 2,533,787, PUB. 11-6-2001, INT. CL. 35.
- MORRY'S MEN'S WEAR, INC., NORTHBROOK, IL:**
 1,142,658, CANC. INT. CL. 25.
 1,142,659, CANC. INT. CL. 25.
- MORSE SHOE, INC., CANTON, MA:**
 1,866,440, CANC. INT. CL. 25.
- MORTGAGE SHOPPE, LLC, THE, EDINA, MN:**
 1,865,971, CANC. INT. CL. 36.
- MORTGAGES LTD., PHOENIX, AZ:**
 2,535,072, INT. CL. 36.
 2,535,073, INT. CL. 36.
- MORTON INTERNATIONAL, INC., CHICAGO, IL, SCIENTIFIC OIL COMPOUNDING COMPANY, INC., CHICAGO, IL:**
 550,448, REN. 12-17-01, U.S. CL. 6 (INT. CL. 5).
- MORTON SIDING CO., INC., MORTON, IL, DBA MORTON REMODELING:**
 2,533,856, PUB. 11-6-2001, INT. CL. 37.
- MOSBY, INC., ST. LOUIS, MO:**
 2,535,082, INT. CL. 16.
 2,535,083, INT. CL. 16.
- MOSS; PAUL B., TULSA, OK, DBA QALL'S ENTERPRISES:**
 1,172,076, REN. 12-17-01, INT. CL. 9.
- MOTHERS POLISHES WAXES CLEANERS, HUNTINGTON BEACH, CA:**
 1,625,539, CANC. INT. CL. 3.
- MOTO PHOTO, INC., DAYTON, OH:**
 1,660,121, REN. 12-17-01, INT. CL. 40.
- MOTORCYCLE ASSOCIATION OF NEW YORK STATE, INC., THE, NEW YORK, NY:**
 2,534,180, PUB. 11-6-2001, INT. CL. 41.
 2,534,181, PUB. 11-6-2001, INT. CL. 41.
- MOTOROLA INC., SCHAUMBURG, IL:**
 1,656,676, REN. 12-21-01, INT. CL. 9.
- MOUAWAD USA, INC., NEW YORK, NY:**
 2,535,134, INT. CL. 14.
- MOULTRIE FEEDERS SECOND CORP., INC., ALABASTER, AL:**
 2,535,119, INT. CL. 28.
- MOUNT MAYA, INC., FT. MYERS, FL:**
 1,865,898, CANC. INT. CL. 30.
- MOUNT VERNON MILLS, INC., GREENVILLE, SC, LA FRANCE INDUSTRIES, NEW YORK, NY:**
 548,918, REN. 12-19-01, U.S. CL. 2 (INT. CL. 24).
- MOUNTAIN DEVELOPMENT CORPORATION, WEST PATTERSON, NJ:**
 2,534,037, PUB. 11-6-2001, INT. CL. 36.
- MOUNTAIN ENTERPRISES, INC., LEXINGTON, KY:**
 2,534,997, INT. CL. 37.
- MOUNTAIN MUDD, LLC, BILLINGS, MT:**
 2,534,948, INT. CL. 32.
- MOUNTAIN TRAVEL, EL CERRITO, CA:**
 1,866,293, CANC. INT. CL. 9.
- MOVENPICK HOLDING, 8002 ZURICH, SWITZERLAND:**
 1,866,603, CANC. INT. CL. 42.
- MPHI SA, 68510 SIERENTZ, FRANCE:**
 2,534,465, INT. CL. 19.
- MR. CONTAINER, MIAMI, FL:**
 2,533,812, PUB. 11-6-2001, INT. CL. 29.
- MR. SPOUTING, INC., FISHERTOWN, PA:**
 2,533,486, PUB. 11-6-2001, INT. CL. 37.
- MTI INFORMATION TECHNOLOGIES, LLC, LANGHORNE, PA:**
 2,534,156, PUB. 11-6-2001, INT. CL. 35.
- MUELLER CO., DECATUR, IL:**
 735,901, REN. 12-17-01, U.S. CL. 13 (INT. CL. 6).
 937,392, REN. 12-16-01, U.S. CL. 13 (INT. CL. 6).
- MUGLER, ALFRED, 82362 WEILHEIM, FED REP GERMANY:**
 2,534,487, INT. CL. 9.
 2,534,488, INT. CL. 9.
- MULTIBUYER, INC., PEARL RIVER, NY:**
 2,535,040, INT. CL. 41.
- MUNICH REINSURANCE COMPANY OF CANADA, TORONTO, ONTARIO, CANADA:**
 1,908,203, CANC. INT. CL. 9.
- MURPHY CAP & GOWN COMPANY, ST. PETERSBURG, FL:**
 2,535,046, INT. CL. 24.
- MURPHY, MICHAEL, EDGEMONT, PA:**
 1,661,943, REN. 12-21-01, INT. CL. 37.
- MURRAY OHIO MANUFACTURING CO., THE, BRENTWOOD, TN:**
 1,142,454, CANC. INT. CL. 12.
 1,142,455, CANC. INT. CL. 12.
 1,142,456, CANC. INT. CL. 12.
- MUSICPLAYGROUND INC., ANDOVER, MA:**
 2,534,224, PUB. 11-6-2001, INT. CL. 9.
- MUSICTIME SPECIALTIES CORP., PEARL CITY, HI:**
 1,866,436, CANC. INT. CL. 25.
- MVS SOLUTIONS INC., MARKHAM, ONTARIO, CANADA:**
 1,659,514, REN. 12-17-01, INT. CL. 9.
- MYOJOYO RUBBER INDUSTRY CO., LTD., NISHI-KU, HIROSHIMA-SHI, HIROSHIMA-KEN, JAPAN:**
 1,183,102, REN. 12-17-01, INT. CL. 28.
- MYPRIMETIME, INC., SAN FRANCISCO, CA:**
 2,533,707, PUB. 11-6-2001, INT. CL. 36.
- NA-CHURS PLANT FOOD COMPANY, MARION, OH:**
 2,533,760, PUB. 11-6-2001, INT. CL. 1.
- NABISCO BRANDS COMPANY, WILMINGTON, DE:**
 2,534,344, PUB. 11-6-2001, INT. CL. 28.
- NABISCO, INC., PARSIPPANY, NJ:**
 1,866,523, CANC. INT. CL. 30.
- NADING; LEE, BLOOMINGTON, IN:**
 1,171,451, REN. 12-17-01, INT. CL. 28.

- NAKAMURA, MICHAEL TOSHIO, BURLINGAME, CA:
2,535,093, INT. CL. 29.
- NANODEVICES, SANTA BARBARA, CA:
2,535,022, INT. CL. 9.
- NATIONAL ASSOCIATION OF LEGAL SECRETARIES,
TULSA, OK, DBA NALS:
1,640,869, REN. 12-17-01, INT. CL. 42.
- NATIONAL ASSOCIATION OF PERSONAL FINANCIAL
ADVISORS, INC., BUFFALO GROVE, IL:
2,534,331, PUB. 11-6-2001, INT. CL. 42.
- NATIONAL ASSOCIATION OF WATERPROOFING &
STRUCTURAL REPAIR CONTRACTORS, CLEVELAND,
OH:
2,535,106, INT. CL. 42.
- NATIONAL CENTER OF NUTRITION, INC., NEWINGTON,
VA:
1,866,513, CANC. INT. CL. 30.
- NATIONAL CENTER ON EDUCATION AND THE ECONOMY,
WASHINGTON, DC:
2,534,441, MULTIPLE CLASS, INT. CLS. 9, 16 AND 41.
- NATIONAL CONFERENCE OF CHRISTIANS AND JEWS,
INC., THE, NEW YORK, NY:
1,866,587, CANC. INT. CL. 42.
- NATIONAL DISTRIBUTION AND CONTRACTING, INC.,
NASHVILLE, TN, ABCO DEALERS, INC., NASHVILLE,
TN:
1,670,958, REN. 12-21-01, INT. CL. 5.
- NATIONAL EQUIPMENT DISTRIBUTORS, INC., FRANK-
LIN, OH:
2,533,759, PUB. 11-6-2001, INT. CL. 12.
- NATIONAL EXECUTIVE SERVICE CORPS., NEW YORK,
NY:
1,165,062, REN. 12-19-01, INT. CL. 42.
- NATIONAL FEDERATION OF COFFEE GROWERS OF
COLOMBIA, THE, NEW YORK, NY:
1,568,759, REN. 12-20-01, INT. CL. 35.
- NATIONAL FEDERATION OF STATE HIGH SCHOOL
ASSOCIATIONS, KANSAS CITY, MO:
2,534,504, U.S. CL. A.
- NATIONAL FLUID POWER ASSOCIATION, MILWAUKEE,
WI:
1,866,641, CANC. INT. CL. 42.
- NATIONAL HEALTH ENHANCEMENT SYSTEMS, INC.,
PHOENIX, AZ:
1,626,261, CANC. INT. CL. 35.
- NATIONAL INSTRUMENT COMPANY, INC., BALTIMORE,
MD:
1,142,309, CANC. INT. CL. 9.
- NATIONAL MANUFACTURING CO., STERLING, IL:
2,534,806, INT. CL. 8.
- NATIONAL ORGANIZATION OF BLACK LAW ENFORCE-
MENT EXECUTIVES, ALEXANDRIA, VA:
2,533,711, PUB. 11-6-2001, INT. CL. 42.
- NATIONAL SAFETY COUNCIL, ITASCA, IL:
2,534,600, U.S. CL. B.
- NATIONAL SEMICONDUCTOR CORPORATION, SANTA
CLARA, CA:
1,866,005, CANC. INT. CL. 40.
- NATIONAL SERVICE INDUSTRIES, INC., ATLANTA, GA:
1,625,809, CANC. INT. CL. 9.
- NATIONAL SHOOTING SPORTS FOUNDATION, INC.,
NEWTOWN, CT:
2,535,108, INT. CL. 42.
- NATIONAL SOCIETY OF PROFESSIONAL ENGINEERS,
ALEXANDRIA, VA, DBA NATIONAL INSTITUTE FOR
CERTIFICATION IN ENGINEERING TECHNOLOGIES:
1,920,535, COR. U.S. CL. B.
1,926,040, COR. INT. CL. 42.
- NATIONAL STARCH AND CHEMICAL INVESTMENT
HOLDING CORPORATION, BRIDGEWATER, NJ, SPS
TECHNOLOGIES, INC., JENKINTOWN, PA:
1,191,934, REN. 12-17-01, INT. CL. 1.
- NATIONS PRIDE DISTRIBUTORS INC., PLANT CITY, FL:
1,866,509, CANC. INT. CL. 29.
- NATIONWIDE TRANSMISSION PARTS, INC., CULVER
CITY, CA:
1,142,449, CANC. INT. CL. 12.
- NATURAL ORGANICS INC., MELVILLE, NY:
2,533,243, PUB. 11-6-2001, INT. CL. 5.
2,533,517, PUB. 11-6-2001, INT. CL. 5.
2,533,518, PUB. 11-6-2001, INT. CL. 5.
2,533,519, PUB. 11-6-2001, INT. CL. 10.
2,533,520, PUB. 11-6-2001, INT. CL. 5.
2,533,521, PUB. 11-6-2001, INT. CL. 5.
- NATURAL SUPPLEMENT ASSOCIATION, INC., GOLDEN,
CO, DBA EXPERIMENTAL AND APPLIED SCIENCES,
INC.:
2,534,911, INT. CL. 5.
- NATURAL SUPPLEMENT ASSOCIATION, INC., GOLDEN,
CO, DBA EXPERIMENTAL AND APPLIED SCIENCES:
2,534,912, INT. CL. 5.
- NAUTEX, INC., EAST LAYTON, UT:
2,533,936, PUB. 11-6-2001, INT. CL. 2.
- NAVAJO SHOPPING CENTER, GAMERCO, NM:
1,865,744, CANC. INT. CL. 14.
- NCR CORPORATION, DAYTON, OH:
2,534,654, INT. CL. 42.
- NEC AMERICA, INC., MELVILLE, NY:
2,534,529, INT. CL. 9.
- NEDICK'S STORES, INC., YONKERS, NY:
1,142,743, CANC. INT. CL. 29.
- NEED SUPPLY COMPANY, L.L.C., RICHMOND, VA TO
BLUES, L.C., RICHMOND, VA:
2,322,498, COR. INT. CL. 35.
- NEETZ, JOHN, C, BAY CITY, MI:
2,534,940, INT. CL. 30.
- NELSON INDUSTRIES, INC., NEW YORK, NY:
1,865,741, CANC. INT. CL. 14.
- NELSON, MICHAEL TODD, CHESAPEAKE, VA:
1,866,424, CANC. INT. CL. 25.
- NEMETH, STEPHEN, LOS ANGELES, CA:
2,534,514, INT. CL. 28.
- NEOGEN CORPORATION, LANSING, MI, AGRI-DIAG-
NOSTICS ASSOCIATES, CINNAMINSON, NJ:
1,671,511, REN. 12-21-01, INT. CL. 1.
- NESAK INTERNATIONAL, FLORHAM PARK, NJ:
1,625,739, CANC. INT. CL. 9.
- NESTE OIL SERVICES, INC., SAN DIEGO, CA:
1,865,791, CANC. INT. CL. 19.
- NEUMAN, BARBARA, MENLO PARK, CA, DBA THE
VENERABLE BEAD:
1,865,743, CANC. INT. CL. 14.
- NEW BERRY, INC., HARMONY, PA, PULLMAN BERRY
COMPANY, HARMONY, PA:
1,172,837, REN. 12-19-01, MULTIPLE CLASS, INT. CLS. 6,
7 AND 11.
- NEW EAST RECORDS, INC., GOLDSBORO, NC:
1,866,011, CANC. INT. CL. 41.
- NEW ENGLAND LOG HOMES, INC., NEW HAVEN, CT:
1,142,568, CANC. INT. CL. 19.
- NEW JERSEY MACHINE INC., LEBANON, NH:
1,659,459, REN. 12-17-01, INT. CL. 7.
- NEW ORLEANS BAPTIST SEMINARY, NEW ORLEANS, LA:
2,534,308, PUB. 11-6-2001, INT. CL. 42.
- NEW PARADIGM RESOURCES GROUP, INC., CHICAGO,
IL:
2,535,087, INT. CL. 16.
- NEW PENDULUM CORP., WILMINGTON, DE:
2,533,818, PUB. 11-6-2001, INT. CL. 17.
- NEW PRODUCT SPECIALTIES GROUP, FREEHOLD, NJ:
2,534,091, PUB. 11-6-2001, INT. CL. 16.
- NEW YORK INDEPENDENT SYSTEM OPERATOR, SCHE-
NECTADY, NY:
2,535,018, INT. CL. 36.
- NEW YORK STATE BUSINESS GROUP, INC., LATHAM,
NY:
1,865,955, CANC. INT. CL. 36.
- NEWAYS, INC., SALEM, UT:
2,533,545, PUB. 11-6-2001, INT. CL. 5.
- NEWGROUND RESOURCES, INC., MANCHESTER, MO:
2,534,334, PUB. 11-6-2001, INT. CL. 35.
2,534,335, PUB. 11-6-2001, INT. CL. 41.
- NEWARK DRILLING FLUIDS, INC., HOUSTON, TX:
2,533,378, PUB. 11-6-2001, MULTIPLE CLASS, INT. CLS.
37 AND 40.

- NEWPORT NEWS SHIPBUILDING AND DRY DOCK COMPANY, NEWPORT NEWS, VA:
2,534,791, MULTIPLE CLASS, INT. CLS. 37 AND 39.
- NEWSPAPER ENTERPRISE ASSOCIATION, INC., NEW YORK, NY:
733,800, REN. 12-17-01. U.S. CL. 38 (INT. CL. 16).
- NEXCOMM CAPITAL PARTNERS, LLC, SOUTHPORT, CT:
2,534,232, PUB. 11-6-2001. INT. CL. 36.
- NEXEN GROUP, INC., VADNASI HEIGHTS, MN FROM HORTON, INC., MINNEAPOLIS, MN:
2,534,479, INT. CL. 7.
- NEXTJET, INC., DALLAS, TX:
2,534,740, INT. CL. 39.
2,534,741, INT. CL. 39.
- NIEDNER LIMITED, COATICOOK, QUEBEC, CANADA:
2,533,568, PUB. 11-6-2001. INT. CL. 17.
- NIEDNER LIMITED, COATICOOK, PQ, CANADA:
2,534,796, INT. CL. 17.
- NIELSEN MEDIA RESEARCH, INC, NEW YORK, NY:
2,533,399, PUB. 11-6-2001. INT. CL. 16.
- NIELSEN MEDIA RESEARCH, INC., NEW YORK, NY, A. C. NIELSEN COMPANY, NORTHBROOK, IL:
1,188,037, REN. 12-17-01. INT. CL. 35.
- NIKE, INC., BEAVERTON, OR:
1,142,628, CANC. INT. CL. 25.
2,534,358, INT. CL. 14.
- NIN JIOM MEDICINE MANUFACTORY (HK) LTD., TSUEN WAN, NEW TERRITORIES, HONG KONG:
2,534,590, INT. CL. 30.
- NINE MILE ROAD VETERINARY CLINIC P.C., NOVI, MI:
2,533,195, PUB. 11-6-2001. INT. CL. 42.
- NINTENDO OF AMERICA INC., REDMOND, WA:
2,534,437, INT. CL. 30.
- NIVIN INC., BROOKFIELD, WI:
2,534,935, INT. CL. 38.
- NKOK, INC., LOS ANGELES, CA:
2,534,533, INT. CL. 28.
- NLC, INC., JACKSON, MO:
2,533,651, PUB. 11-6-2001. INT. CL. 8.
- NLP AWARENESS, INC., TOMS RIVER, NJ:
1,866,023, CANC. INT. CL. 41.
- NOCTURNUS, LUTZ, FL:
2,533,370, PUB. 11-6-2001. MULTIPLE CLASS, INT. CLS. 9 AND 41.
- NOMINUM, INC., REDWOOD CITY, CA:
2,534,752, INT. CL. 9.
- NONU INC., ST. GEORGE, UT:
2,533,294, PUB. 11-6-2001. INT. CL. 30.
- NORDICTRACK, INC., CHASKA, MN:
1,866,592, CANC. INT. CL. 42.
- NORFOLK INVESTMENTS, INC., WILMINGTON, DE, LENOX, INCORPORATED, LAWRENCEVILLE, NJ:
1,179,465, REN. 12-20-01. INT. CL. 35.
- NORM THOMPSON OUTFITTERS, INC., HILLSBORO, OR:
2,533,750, PUB. 11-6-2001. INT. CL. 35.
- NORMARK CORPORATION, MINNETONKA, MN:
2,534,844, INT. CL. 28.
- NORMERICA INC., RICHMOND HILL, ONTARIO, CANADA:
1,865,907, CANC. INT. CL. 31.
- NORTH AMERICAN MONTESSORI-CHILD CARE, INC., ST. LOUIS, MO, CASA DIA MONTESSORI SOUTH, ST. LOUIS, MO, AKA CASA DIA MONTESSORI, INC.:
1,177,618, REN. 12-19-01. MULTIPLE CLASS, INT. CLS. 41 AND 42.
- NORTH AMERICAN PHARMACAL/NATURAL PRODUCTS, INC., NORWALK, CT:
2,534,863, INT. CL. 5.
- NORTHEAST PHOENIX PARTNERS, SCOTTSDALE, AZ:
2,534,648, INT. CL. 42.
- NORTHERN CALIFORNIA IMAGE LABORATORY INC, RANCHO SANTA MARGARITA, CA:
2,533,911, PUB. 11-6-2001. INT. CL. 5.
- NORTHERN RESEARCH AND ENGINEERING CORPORATION, WOBURN, MA FROM NORTHERN RESEARCH AND ENGINEERING CORPORATION, WOBURN, MA:
2,534,388, MULTIPLE CLASS, INT. CLS. 7 AND 11.
- NORTHPORT APPAREL, INC., NEW YORK, NY:
2,533,773, PUB. 3-6-2001. INT. CL. 25.
- NORTHWEST AIRLINES, INC., ST. PAUL, MN:
2,535,120, INT. CL. 35.
- NORTHWEST PODIATRIC LABORATORY, INC., BLAINE, WA:
1,658,118, REN. 12-19-01. INT. CL. 10.
- NORTON-LAMBERT CORP., SANTA BARBARA, CA:
1,866,266, CANC. INT. CL. 9.
- NOVAFON ELEKTROMEDIZINISCHE GERATE GMBH, D-70736 FELLBACH, FED REP GERMANY:
2,534,723, INT. CL. 10.
- NOVASYS HEALTH NETWORK, LLC, LITTLE ROCK, AR:
2,534,744, MULTIPLE CLASS, INT. CLS. 35 AND 36.
- NOVEMBER RECORDS, INC., NEW YORK, NY:
1,866,287, CANC. INT. CL. 9.
- NOVOTECHNIK STIFTUNG & CO. MESSWERTAUFNEHMER, D-7302 OSTFILDERN 1 (RUIT), FED REP GERMANY:
1,665,675, REN. 12-19-01. INT. CL. 9.
- NOVUS CREDIT SERVICES INC., RIVERWOODS, IL:
1,865,950, CANC. MULTIPLE CLASS, INT. CLS. 35, 36 AND 39.
- NOVUS GROUP, INC., THE, WASHINGTON, DC:
1,866,541, CANC. INT. CL. 35.
- NUARC COMPANY, INC., THE, NILES, IL:
1,142,394, CANC. INT. CL. 11.
- NUCAP INDUSTRIES INC., SCARBOROUGH, ONTARIO M1W 3K4, CANADA:
2,533,659, PUB. 11-6-2001. INT. CL. 12.
- NUESOFT TECHNOLOGIES, INC., ATLANTA, GA:
2,534,928, INT. CL. 9.
- NUTRASWEET COMPANY, THE, DEERFIELD, IL:
1,866,516, CANC. INT. CL. 30.
- NUTRITECH, INC., VERNON HILLS, IL:
2,534,152, PUB. 11-6-2001. INT. CL. 5.
- NUTRITION FOR LIFE INTERNATIONAL, INC., HOUSTON, TX:
2,535,003, INT. CL. 5.
- NY DANCE STUDIOS, INC., NEW YORK, NY:
2,534,638, INT. CL. 41.
- NYB FOODS, INC., MESA, AZ:
2,534,795, INT. CL. 35.
- NYCOMED, INC., PRINCETON, NJ:
2,533,741, PUB. 11-6-2001. INT. CL. 20.
- O. AMES CO., PARKERSBURG, WV:
1,142,270, CANC. INT. CL. 8.
- OAK CREEK WATER AND SEWER UTILITY, OAK CREEK, WI:
2,533,923, PUB. 11-6-2001. INT. CL. 32.
- OAKLEY, INC., FOOTHILL RANCH, CA:
2,534,767, INT. CL. 9.
- OASIS INDUSTRIES, INCORPORATED, AURORA, IL, WATERJET CORPORATION, CANOGA PARK, CA:
1,177,058, REN. 12-21-01. INT. CL. 10.
- OBJECTIVITY, INC., MOUNTAIN VIEW, CA:
1,712,608, REN. 12-19-01. INT. CL. 9.
- OBOLDING SA, PARIS, FRANCE, BELTRAMI, FRANCIS G., DR., 13002 MARSEILLE, FRANCE:
1,139,593, REN. 12-21-01. INT. CL. 16.
- OCEAN ISLE SOFTWARE LIMITED PARTNERSHIP, VERO BEACH, FL:
1,865,675, CANC. INT. CL. 9.
- OCEANWIDE MARINE NETWORK INC., MONTREAL, QUEBEC H3A 1R8, CANADA:
2,533,381, PUB. 11-6-2001. INT. CL. 36.
- ODWALLA, INC., HALF MOON BAY, CA TO ODWALLA, INC., HALF MOON BAY, CA:
2,445,781 NEW CERT. 1-29-2002. INT. CL. 32.
- OFFICER, KENDAL H., SANTA ROSA, CA AND OFFICER, MICHAEL R., SANTA ROSA, CA:
2,533,618, PUB. 11-6-2001. INT. CL. 33.
- OFFICIAL PAYMENTS CORPORATION, NEW YORK, NY:
2,533,394, PUB. 11-6-2001. INT. CL. 36.
- OHARA, MICHIKO, ARCADIA, CA:
2,534,563, INT. CL. 25.
- OI PARTNERS, INC., PARSIPPANY, NJ:
2,533,704, PUB. 11-6-2001. INT. CL. 35.

- OLD NAVY (APPAREL) INC., SAN BRUNO, CA:
2,534,579, INT. CL. 25.
- OLD WILLIAMSBURGH CANDLE CORP., BROOKLYN, NY:
2,533,363, PUB. 11-6-2001. INT. CL. 4.
- OLD WORLD MERCHANT.COM, INC., GLEN ALLEN, VA:
2,534,875, INT. CL. 35.
- OLIN CORPORATION, NORWALK, CT, WESTERN CARTRIDGE COMPANY, EAST ALTON, IL:
153,053, REN. 12-20-01. U.S. CL. 9 (INT. CL. 13).
- OLIVE OIL'S, LTD., WETHERSFIELD, CT:
1,866,054, CANC. INT. CL. 42.
- OLIVER BRYAN THAMES, MCCLELLANVILLE, SC, DBA BULLS BAY SUPPLY, INC.:
2,534,664, INT. CL. 25.
- OLSON COMMUNICATIONS, INC., CHICAGO, IL:
2,533,953, PUB. 11-6-2001. INT. CL. 41.
- OMB S.P.A., 24069 CENATE SOTTO (BERGAMO), ITALY:
2,533,587, PUB. 11-6-2001. INT. CL. 6.
- OMS INVESTMENTS, INC., WILMINGTON, DE:
2,533,728, PUB. 11-6-2001. INT. CL. 1.
2,533,745, PUB. 11-6-2001. INT. CL. 1.
- OMX, INC., LAS VEGAS, NV, OFFICEMAX, INC., SHAKER HEIGHTS, OH:
1,715,669, REN. 12-20-01. INT. CL. 16.
- OMX, INC., LAS VEGAS, NV:
2,533,928, PUB. 11-6-2001. INT. CL. 38.
- ON-DEMAND TECHNOLOGIES, INC., AUSTIN, TX:
1,865,647, CANC. INT. CL. 9.
- ON-SITE MEDIA, INC., LAS VEGAS, NV:
2,533,673, PUB. 11-6-2001. INT. CL. 35.
2,533,674, PUB. 11-6-2001. INT. CL. 35.
- ONECHANNEL.NET, INC., MOUNTAIN VIEW, CA:
2,534,157, PUB. 11-6-2001. INT. CL. 35.
- ONTARIO FOODS, INCORPORATED, MEDINA, NY, TKI FOODS, INC., SPRINGFIELD, IL:
1,658,781, REN. 12-20-01. INT. CL. 5.
- OPAL BEVERAGES PTY. LTD., AIRPORT WEST, MELBOURNE, VICTORIA 3042, AUSTRALIA:
1,866,534, CANC. INT. CL. 32.
- OPENGLOBE, INC., INDIANAPOLIS, IN FROM ESCIENT, INC., CARMEL, IN:
2,535,017, INT. CL. 9.
- OPERATIONS SECURITY INTERNATIONAL, INC., LIBURN, GA:
2,533,337, PUB. 11-6-2001. INT. CL. 42.
- OPHTHALMIC PUBLISHING COMPANY, INC., NEWTON, MA:
1,177,155, REN. 12-19-01. INT. CL. 16.
- OPINIONLAB, INC., HIGHLAND PARK, IL:
2,533,902, PUB. 11-6-2001. MULTIPLE CLASS, INT. CLS. 35 AND 42.
- OPTICAL RADIATION CORPORATION, AZUSA, CA:
1,866,620, CANC. INT. CL. 9.
- OPTIMAL ENGINEERING SOLUTIONS, INC., EAST HARTFORD, CT:
1,865,650, CANC. INT. CL. 9.
- OPTIMOX CORPORATION, TORRANCE, CA:
1,625,587, CANC. INT. CL. 5.
- OPTRONICS, INC., FT. GIBSON, OK:
1,142,432, CANC. INT. CL. 12.
- OPTUS SOFTWARE, INC., SOMERSET, NJ:
1,658,643, REN. 12-20-01. INT. CL. 9.
- OPUS, INCORPORATED, BELLINGHAM, MA:
1,865,826, CANC. INT. CL. 21.
- ORACLE CORPORATION, REDWOOD CITY, CA:
1,866,617, CANC. INT. CL. 9.
- ORAFI NORTH AMERICA, INC., MALVERN, PA:
2,533,934, PUB. 11-6-2001. INT. CL. 5.
- ORION FOOD SYSTEMS, INC., SIOUX FALLS, SD:
2,533,845, PUB. 11-6-2001. INT. CL. 42.
- ORION TIRE CORPORATION, SAN CLEMENTE, CA:
1,866,327, CANC. INT. CL. 12.
- ORISON MARKETNG, L.L.C., ABILENE, TAYLOR COUNTY, TX:
2,533,884, PUB. 11-6-2001. INT. CL. 1.
- OROZCO, SERGIO, WEST NEW YORK, NJ:
2,534,217, PUB. 11-6-2001. INT. CL. 42.
- ORTHODONTIC CENTERS OF AMERICA, PONTE VEDRA BEACH, FL:
2,533,962, PUB. 11-6-2001. INT. CL. 42.
- OS ASSET, INC., TAMPA, FL, OUTBACK STEAKHOUSE OF FLORIDA, INC., TAMPA, FL:
1,720,493, REN. 12-21-01. INT. CL. 29.
- OSSBERGER-TURBINENFABRIK GMBH + CO., WEISSENBURG, FED REP GERMANY:
1,625,635, CANC. MULTIPLE CLASS, INT. CLS. 7 AND 9.
- OTG SOFTWARE, INC., BETHESDA, MD:
2,534,300, PUB. 11-6-2001. INT. CL. 9.
- OUR PRODUCTS GROUP, INC., BUDA, TX, TEXXSTAR RESOURCES (USA), INC., BUDA, TX, DBA JARDINE'S TEXAS FOODS:
1,659,914, REN. 12-20-01. INT. CL. 29.
- OUTBACK STEAKHOUSE OF FLORIDA, INC., TAMPA, FL:
1,716,098, REN. 12-19-01. INT. CL. 29.
- OVERFLOW COUNSEL, LLC, NEW YORK, NY:
2,534,187, PUB. 11-6-2001. INT. CL. 42.
- OWENSBORO MESSENGER-INQUIRER, INC., OWENSBORO, KY:
2,534,005, PUB. 11-6-2001. INT. CL. 16.
- OXYGEN MEDIA, LLC, NEW YORK, NY:
2,533,655, PUB. 11-6-2001. INT. CL. 42.
- OXYGEN TECH, INC., TOMS RIVER, NJ:
2,534,263, PUB. 11-6-2001. INT. CL. 5.
- OY JUVANTIA PHARMA LTD., FIN 20520 TURKU, FINLAND:
2,533,320, PUB. 11-6-2001. MULTIPLE CLASS, INT. CLS. 1, 5 AND 42.
- OZWEST IMPORTS, INC., BEAVERTON, OR:
1,865,885, CANC. INT. CL. 28.
- P.J. BEAN CO., INC., OZONE PARK, NY:
2,534,068, PUB. 11-6-2001. MULTIPLE CLASS, INT. CLS. 29, 30 AND 32.
- P.J. WHELihan'S PUB, INC., HADDONFIELD, NJ:
2,533,424, PUB. 11-6-2001. INT. CL. 42.
- P.S.W. INC., CHINO, CA:
2,533,865, PUB. 11-6-2001. INT. CL. 32.
- P.T.C. BRAND, INC., WILMINGTON, DE:
2,316,275, COR. INT. CL. 41.
- PACIFIC GAS AND ELECTRIC COMPANY, SAN FRANCISCO, CA:
2,533,269, PUB. 11-6-2001. INT. CL. 41.
- PACIFIC INTERNATIONAL TOOL & SHEAR, LTD., KINGSTON, WA:
2,534,484, INT. CL. 7.
- PACKAGING INDUSTRIES GROUP INC., HYANNIS, MA:
1,142,556, CANC. INT. CL. 17.
- PAGES SOFTWARE, INC., SAN DIEGO, CA:
1,866,232, CANC. INT. CL. 9.
- PAGING NETWORK, INCORPORATED, PLANO, TX:
1,866,565, CANC. INT. CL. 38.
- PAJ, INC., DALLAS, TX:
2,534,569, INT. CL. 14.
- PALADIN COMPANIES, INC., CHICAGO, IL:
2,533,841, PUB. 11-6-2001. INT. CL. 42.
- PALL CORPORATION, EAST HILLS, NY:
1,625,665, CANC. INT. CL. 9.
1,865,622, CANC. MULTIPLE CLASS, INT. CLS. 9, 10, 40 AND 42.
- PAN AMERICAN LABORATORIES, INC., COVINGTON, LA:
2,534,941, INT. CL. 5.
- PANGEA SOFTWARE, INC., AUSTIN, TX:
2,534,925, INT. CL. 9.
- PANHANDLE EASTERN PIPE LINE COMPANY, HOUSTON, TX:
2,533,393, PUB. 11-6-2001. INT. CL. 35.
- PANTROPIC, SEBASTOPOL, CA:
1,865,857, CANC. INT. CL. 25.
- PARADIGM PLUS, INC., ALLENTOWN, PA:
1,670,236, REN. 12-17-01. INT. CL. 16.
- PARADOCX VINEYARD, LTD., KEMBLESVILLE, PA:
2,534,436, MULTIPLE CLASS, INT. CLS. 29 AND 31.
- PARALLAX PICTURES, PHILADELPHIA, PA:
2,534,305, PUB. 11-6-2001. INT. CL. 41.

- PARAMOUNT PICTURES CORPORATION, LOS ANGELES, CA:
1,722,155. REN. 12-19-01. INT. CL. 28.
- PARBEL OF FLORIDA, INC., MIAMI, FL:
1,866,171. CANC. INT. CL. 3.
- PARDESHI.COM, INC., NORCROSS, GA:
2,533,536. PUB. 11-6-2001. INT. CL. 42.
- PARDUCCI WINE ESTATES, LLC:
See— THOMA, MARILYNN.
- PARENT RESOURCE, SAN FRANCISCO, CA:
1,865,758. CANC. INT. CL. 16.
- PARENT, DAVE, ROCHDALE, MA, DBA PUDDLE:
1,866,015. CANC. INT. CL. 41.
- PARK AVENUE FURNITURE CORPORATION, CALGARY ALBERTA, T2A 4X8, CANADA:
1,682,972. REN. 12-19-01. INT. CL. 20.
- PARK, WAN HONG, GLENDALE, CA:
1,865,766. CANC. INT. CL. 16.
- PARKER, EDDIE, UNIVERSAL CITY, TX:
2,533,251. PUB. 11-6-2001. MULTIPLE CLASS, INT. CLS. 9 AND 41.
- PARSADAIAN, SEROGE M., CITY OF INDUSTRY, CA, DBA LASER TECH:
1,866,196. CANC. INT. CL. 6.
- PARTNER PLUS, LLC, MINNEAPOLIS, MN:
2,534,612. INT. CL. 36.
- PARTNERSHIP FOR A HEALTHY MISSISSIPPI, JACKSON, MS:
2,533,335. PUB. 11-6-2001. INT. CL. 42.
- PASSIONWORKS, LLC, SAMMAMISH, WA FROM ALDER-TON, CHARLOTTE, REDMOND, WA:
2,534,655. INT. CL. 35.
- PATAZIO & PATAZIO, JACKSONVILLE, FL:
1,626,407. CANC. INT. CL. 42.
- PATHWAYS, INC., WEST DES MOINES, IA:
2,533,706. PUB. 11-6-2001. MULTIPLE CLASS, INT. CLS. 41 AND 42.
- PATHWORK FOUNDATION, THE, CHARLOTTESVILLE, VA, CENTER FOR THE LIVING FORCE, INC., PHOENIX, CA, NY:
1,173,666. REN. 12-21-01. INT. CL. 41.
- PAUL SMITH LIMITED, COVENT GARDEN, LONDON WC2E 9DJ, ENGLAND:
1,661,631. REN. 12-16-01. MULTIPLE CLASS, INT. CLS. 14 AND 18.
- PAULIST PRESS, MAHWAH, NJ:
2,533,589. PUB. 11-6-2001. INT. CL. 16.
- PAVIS VARESE S.R.L. VARESE, ITALY:
2,533,708. PUB. 11-6-2001. INT. CL. 10.
- PAYPOWER LIMITED PARTNERSHIP, PORTLAND, ME:
1,626,284. CANC. INT. CL. 36.
- PC MARKETING, INC., RIDGFIELD, NJ:
2,486,014. COR. INT. CL. 11.
- PDK LABS, INC., HAUPPAUGE, NY:
1,866,191. CANC. INT. CL. 5.
- PEABODY ENGINEERING CORPORATION, SHELTON, CT, PEABODY INTERNATIONAL CORPORATION, STAMFORD, CT:
1,169,932. REN. 12-19-01. INT. CL. 9.
- PEARCE, JAMES T., SAN ANTONIO, TX:
2,533,702. PUB. 11-6-2001. INT. CL. 35.
- PEBBLE BEACH COMPANY, PEBBLE BEACH, CA:
1,866,438. CANC. INT. CL. 25.
- PEEK TRAFFIC B.V., 3821 BR AMERSFOORT, NETHERLANDS:
2,533,469. PUB. 11-6-2001. INT. CL. 9.
- PEER FOOD PRODUCTS COMPANY, CHICAGO, IL:
1,658,344. REN. 12-21-01. INT. CL. 29.
- PEER PARTNERSHIPS, INC., CAMBRIDGE, MA, DBA WORKING CAPITAL:
2,533,672. PUB. 11-6-2001. INT. CL. 36.
- PEERLESS CARPET CORPORATION, WESTMOUNT, QUEBEC, CANADA:
1,865,869. CANC. MULTIPLE CLASS, INT. CLS. 27 AND 42.
- PEERLESS DESIGNS LIMITED, LONDON, UNITED KINGDOM:
2,533,770. PUB. 11-6-2001. INT. CL. 20.
- PEERLESS INDUSTRIES, INC., MELROSE PARK, IL:
1,866,616. CANC. INT. CL. 6.
- PEL-FREEZ CLINICAL SYSTEMS, LLC, BROWN DEER, WI:
2,533,819. PUB. 11-6-2001. INT. CL. 1.
- PELLE PELLE, INC., AUBURN HILLS, MI:
2,534,799. MULTIPLE CLASS, INT. CLS. 6, 18, 20 AND 25.
- PENERGY, INC., PALO ALTO, CA:
1,866,231. CANC. INT. CL. 9.
- PENINSULA INTERNATIONAL LIMITED, PEMBROKE, BERMUDA:
2,533,316. PUB. 11-6-2001. MULTIPLE CLASS, INT. CLS. 35, 41 AND 42.
- PENN TRAFFIC COMPANY, THE, SYRACUSE, NY:
1,865,523. CANC. MULTIPLE CLASS, INT. CLS. 3, 4, 5, 6, 10, 16, 21, 29, 30, 31 AND 32.
- PENNSYLVANIA MFR ASSOC INSURANCE COMPANY, BLUE BELL, PA:
2,534,303. PUB. 11-6-2001. INT. CL. 36.
2,534,304. PUB. 11-6-2001. INT. CL. 36.
- PENNWELL CORPORATION, TULSA, OK:
2,533,438. PUB. 11-6-2001. INT. CL. 38.
- PENTECH INTERNATIONAL INC., EDISON, NJ:
1,625,972. CANC. INT. CL. 16.
- PENTON MEDIA, INC., CLEVELAND, OH, PENTON/INDUSTRIAL PUBLISHING COMPANY, INC., CLEVELAND, OH:
1,169,251. REN. 12-21-01. INT. CL. 16.
- PEPSICO, INC., PURCHASE, NY:
2,534,252. PUB. 11-6-2001. INT. CL. 32.
- PERDUE HOLDINGS, INC., WILMINGTON, DE:
2,533,970. PUB. 11-6-2001. INT. CL. 30.
2,534,256. PUB. 11-6-2001. INT. CL. 29.
- PEREGO-PINES S.P.A., ARCORE, ITALY:
1,142,436. CANC. INT. CL. 12.
- PEREGRINE PRESS, LTD., MARBLEHEAD, MA:
1,865,772. CANC. INT. CL. 16.
- PERETZ, HOWARD G., WATCHUNG, NJ:
2,534,884. INT. CL. 28.
- PERFECTOW TRAILER MFG., INC., INDEPENDENCE, MO:
1,142,428. CANC. INT. CL. 12.
- PERFORMANCE FOODS, INC., BROOMFIELD, CO:
2,535,037. INT. CL. 31.
- PERKINS PAPERS LTD/PAPIERS PERKINS LTEE, CANDIAC (QUEBEC), CANADA:
2,401,366. COR. INT. CL. 16.
- PERMA FOAM LIMITED, SCARBOROUGH, ONTARIO M1P 3A6, CANADA:
1,865,799. CANC. INT. CL. 20.
- PERMAFUSE CORP., THE, WESTBURY, NY:
540,407. REN. 12-17-01. U.S. CL. 5 (INT. CL. 1).
- PEROT SYSTEMS CORPORATION, DALLAS, TX:
2,534,669. MULTIPLE CLASS, INT. CLS. 35, 36 AND 42.
- PERSONAL MARKETING COMPANY, THE, SHAWNEE MISSION, KS:
2,533,413. PUB. 11-6-2001. INT. CL. 35.
- PET MATE LIMITED, HERSHAM SURREY, UNITED KINGDOM:
1,947,956. CANC. INT. CL. 11.
- PET METRO, INC., IRVINE, CA:
1,866,606. CANC. INT. CL. 42.
- PETROFERM INC, FERNANDINA BEACH, FL, E. I. DU PONT DE NEMOURS AND COMPANY, WILMINGTON, DE, DBA DU PONT:
1,678,957. REN. 12-20-01. INT. CL. 3.
- PFEIFFER PHARMACEUTICALS, INC., ATLANTA, GA, PFEIFFER CO., THE, ST. LOUIS, MO:
1,171,916. REN. 12-15-01. INT. CL. 5.
1,171,919. REN. 12-16-01. INT. CL. 5.
1,175,559. REN. 12-19-01. INT. CL. 5.
- PFIZER INC., NEW YORK, NY:
1,865,547. CANC. INT. CL. 5.
- PHARMA MEDICA RESEARCH INC., MISSISSAUGA, ONTARIO L4W 2S1, CANADA:
2,416,922. COR. INT. CL. 42.
- PHARMACIA & UPJOHN S.A., L-1470, LUXEMBOURG:
2,534,682. INT. CL. 5.
- PHARMACYCLICS, INC., MOUNTAIN VIEW, CA:
1,866,193. CANC. INT. CL. 5.

- PHASE-1 MOLECULAR TOXICOLOGY, INC., SANTA FE, NM:
2,535,070, INT. CL. 42.
- PHAT FASHIONS LLC, NEW YORK, NY:
2,535,028, INT. CL. 14.
- PHELPS DODGE INDUSTRIES, INC., PHOENIX, AZ:
2,534,090, PUB. 11-6-2001. INT. CL. 9.
- PHENOMENEX, INC., TORRANCE, CA:
2,535,031, INT. CL. 9.
- PHH VEHICLE MANAGEMENT SERVICES, LLC, HUNT VALLEY, MD:
2,533,410, PUB. 11-6-2001. INT. CL. 35.
- PHILANTHROGROUP, INC., WEST CHESTER, PA:
1,865,975, CANC. INT. CL. 36.
- PHILIP LAW INCORPORATED, NEW YORK, NY:
2,533,534, PUB. 11-6-2001. MULTIPLE CLASS, INT. CLS. 35 AND 41.
- PHILIPS ELECTRONICS N.V., EINDHOVEN, NETHERLANDS:
1,865,710, CANC. INT. CL. 11.
- PHILIPS ELECTRONICS NORTH AMERICA CORPORATION, NEW YORK, NY FROM VOICE CONTROL SYSTEMS, INC., DALLAS, TX:
2,534,396, INT. CL. 9.
- PHILLIPS SON & NEALE LIMITED, LONDON, ENGLAND, PHILLIPS, SON & NEALE, LONDON, ENGLAND:
1,640,429, REN. 12-17-01. MULTIPLE CLASS, INT. CLS. 16, 35 AND 36.
- PHOENIX FORGING COMPANY, INC., CATASAUQUA, PA:
1,865,569, CANC. INT. CL. 6.
- PHOENIX II, INC., MILWAUKEE, WI, PHOENIX PRODUCTS COMPANY, MILWAUKEE, WI:
533,142, REN. 12-21-01. U.S. CL. 21 (INT. CL. 11).
- PHOENIX SALES & SERVICE COMPANY, SAN RAFAEL, CA:
1,142,846, CANC. INT. CL. 35.
- PHOENIX SOLUTIONS INC., EDMONTON, ALBERTA, CANADA:
1,865,588, CANC. INT. CL. 9.
- PHONAK HOLDING AG, CH-8712 STAFA, SWITZERLAND:
2,533,207, PUB. 11-6-2001. MULTIPLE CLASS, INT. CLS. 10 AND 42.
- PHOTO-TECH, INC. SARASOTA, FL:
2,534,623, INT. CL. 40.
- PHOTOVOLT INSTRUMENTS, INC., ST. LOUIS PARK, MN, PHOTOVOLT CORPORATION, NEW YORK, NY:
911,501, REN. 12-15-01. U.S. CL. 26 (INT. CL. 9).
- PHYSICIANS WORLD COMMUNICATIONS GROUP, SECAUCUS, NJ:
2,533,503, PUB. 11-6-2001. INT. CL. 41.
- PHYSIODYNAMICS, INC., ENGLEWOOD, CO:
2,533,561, PUB. 11-6-2001. INT. CL. 10.
- PIERRE FABRE DERMO-COSMETIQUE, 92100 BOULOGNE, FRANCE:
1,930,669, CANC. MULTIPLE CLASS, INT. CLS. 3 AND 5.
- PIG IMPROVEMENT COMPANY, INC., FRANKLIN, KY:
1,142,344, CANC. INT. CL. 9.
- PIGGLY WIGGLY COMPANY, MEMPHIS, TN, PIGGLY WIGGLY CORPORATION, JACKSONVILLE, TN:
921,719, REN. 12-18-01. U.S. CL. 101 (INT. CL. 35).
- PILLSBURY COMPANY, THE, MINNEAPOLIS, MN:
1,671,946, REN. 12-17-01. INT. CL. 30.
2,533,383, PUB. 11-6-2001. INT. CL. 35.
2,533,540, PUB. 11-6-2001. INT. CL. 29.
2,533,541, PUB. 11-6-2001. INT. CL. 30.
2,533,542, PUB. 11-6-2001. INT. CL. 30.
- PINETTE, SUZANNE, AUSTIN, TX:
2,533,428, PUB. 11-6-2001. INT. CL. 41.
- PINNACLE RAWHIDE, L.L.C., SCOTTSDALE, AZ, RAWHIDE, SCOTTSDALE, AZ:
1,169,697, REN. 12-21-01. INT. CL. 42.
- PIONEER ECLIPSE CORPORATION, SPARTA, NC:
2,534,969, INT. CL. 3.
- PITA CAFE, INC., THE, BIRMINGHAM, AL:
2,535,086, INT. CL. 42.
- PITANIELLO, KRISTINA, BOSTON, MA:
2,534,547, INT. CL. 16.
- PIZZA INN, INC., DALLAS, TX:
2,533,313, PUB. 11-6-2001. MULTIPLE CLASS, INT. CLS. 30, 35 AND 42.
- PLANET TOYS INTERNATIONAL, INC., SARASOTA, FL:
2,534,738, INT. CL. 28.
- PLANT HEALTH CARE, INC., PITTSBURGH, PA:
2,533,255, PUB. 11-6-2001. INT. CL. 1.
2,533,256, PUB. 11-6-2001. INT. CL. 1.
- PLASPACK U.S.A., INC., ANTIGO, WI:
2,533,491, PUB. 11-6-2001. MULTIPLE CLASS, INT. CLS. 19 AND 22.
- PLAYBOY ENTERPRISES, INC., CHICAGO, IL:
721,987, REN. 12-20-01. U.S. CL. 38 (INT. CL. 16).
- PLAYTIME U.S.A., INC., CHEEKTOWAGA, NY:
1,142,569, CANC. INT. CL. 19.
- PLEKO SYSTEMS INTERNATIONAL, INC., TACOMA, WA, KERN-TAC INC., TACOMA, WA:
1,180,179, REN. 12-19-01. INT. CL. 19.
- PLUM HALL INC., KAMUELA, HI:
1,866,243, CANC. INT. CL. 9.
- PLUTUS CREATIONS, INC., MONTREAL, QUEBEC, CANADA:
1,866,459, CANC. INT. CL. 25.
- PMCV TECHNOLOGIES LLC, CHICAGO, IL:
2,534,784, INT. CL. 9.
- PMG HEALTHCOM, INC., ASHEVILLE, NC:
2,534,021, PUB. 11-6-2001. INT. CL. 41.
2,534,022, PUB. 11-6-2001. INT. CL. 42.
- PODIUM SPORTS MARKETING, INC., MINNEAPOLIS, MN:
2,533,437, PUB. 11-6-2001. INT. CL. 36.
- POLA CHEMICAL INDUSTRIES, INC., SHIZUOKA-SHI, SHIZUOKA-KEN, JAPAN:
2,534,763, INT. CL. 3.
- POLAR BARROW, INC., STANCHFIELD, MN FROM ESQUARED, INC., STANCHFIELD, MN:
2,534,947, INT. CL. 12.
- POLARTRUST LTD OY, 00100 HELSINKI, FINLAND:
2,533,435, PUB. 11-6-2001. INT. CL. 33.
- POLLAND, RICK, SEVERNA PARK, MD:
2,533,466, PUB. 11-6-2001. INT. CL. 35.
- POLY-CLIP SYSTEM GMBH & CO. KG, D-60489 FRANKFURT, FED REP GERMANY, NIEDECKER-VERSCHLUSSTECHNIK GMBH, FRANKFURT AM MAIN RODELHEIM, FED REP GERMANY:
715,725, REN. 12-17-01. U.S. CL. 23 (INT. CLS. 6, 7, 8, 9, 11, 12, 16, 21 AND 28).
- POLY-OPTICAL PRODUCTS, INC., SANTA ANA, CA:
1,866,308, CANC. INT. CL. 10.
- POLYGRAM RECORDS, INC., NEW YORK, NY:
1,625,805, CANC. INT. CL. 9.
1,625,806, CANC. INT. CL. 9.
- POLYMER CHEMISTRY INNOVATIONS, INC., STATE COLLEGE, PA:
1,866,148, CANC. INT. CL. 1.
- POLYMER ENTERPRISES CORP., WILMINGTON, DE:
1,660,350, REN. 12-21-01. INT. CL. 12.
- POLYMERIC SYSTEMS, INC., PHOENIXVILLE, PA:
1,192,113, REN. 12-17-01. INT. CL. 17.
- POLYNESIAN CULTURAL CENTER, LAIE, HI:
2,534,526, INT. CL. 35.
- POLYSCIENCES, INC., WARRINGTON, PA:
1,866,192, CANC. INT. CL. 5.
- POMPEII FURNITURE CO., INC., MIAMI, FL, MIAMI METAL PRODUCTS, INC., MIAMI, FL:
1,642,837, REN. 12-21-01. INT. CL. 20.
- POOF PRODUCTS, INC., PLYMOUTH, MI, POOF TOY PRODUCTS, INC., PLYMOUTH, MI:
1,705,191, REN. 12-20-01. INT. CL. 28.
1,705,192, REN. 12-21-01. INT. CL. 28.
- POOL SITTER, INC., LARGO, FL:
2,533,873, PUB. 11-6-2001. INT. CL. 19.
- POPULAR, INC., SAN JUAN, PUERTO RICO:
2,533,443, PUB. 11-6-2001. INT. CL. 36.
- PORTADAM, INC., WILLIAMSTOWN, NJ:
2,533,604, PUB. 11-6-2001. INT. CL. 19.
2,533,611, PUB. 11-6-2001. INT. CL. 19.

- PORTMEIRION POTTERIES LIMITED, STOKE-ON-TRENT, ENGLAND:
1,656,295. REN. 12-17-01. INT. CL. 24.
- POSITIVE PERSONNEL, INC., TYLER, TX:
1,866,543, CANC. INT. CL. 35.
- POSTALSOFT, INC., LACROSSE, WI:
1,865,589, CANC. MULTIPLE CLASS, INT. CLS. 9, 37 AND 41.
- POTENZA, JOHN J., STATEN ISLAND, NY:
2,533,998, PUB. 11-6-2001. INT. CL. 41.
- POTLATCH CORPORATION, SPOKANE, WA:
2,534,459, INT. CL. 16.
- POTTER, CHERYL, BARTON, VT:
2,534,192, PUB. 11-6-2001. INT. CL. 41.
- POWELL, GEORGE A., GOLETA, CA, POWELL CORPORATION, THE, SANTA BARBARA, CA:
1,680,453. REN. 12-17-01. INT. CL. 25.
1,681,312. REN. 12-17-01. INT. CL. 28.
- POWERMED, INC., NEW HOPE, PA:
2,534,917, INT. CL. 10.
- POWERS, MARGARET FISHBACK, COQUITLAM, BC, CANADA:
2,534,574, MULTIPLE CLASS, INT. CLS. 14 AND 21.
- POWERWARE CORPORATION, RALEIGH, NC, EXIDE ELECTRONICS CORPORATION, RALEIGH, NC:
1,667,406. REN. 12-15-01. INT. CL. 9.
- PPG ARCHITECTURAL FINISHES, INC., PITTSBURGH, PA, PITTSBURGH PLATE GLASS COMPANY, PITTSBURGH, PA:
287,505. REN. 12-17-01. U.S. CL. 16 (INT. CL. 2).
- PQ CORPORATION, VALLEY FORGE, PA, PHILADELPHIA QUARTZ COMPANY, PHILADELPHIA, PA:
929,404. REN. 12-19-01. U.S. CL. 6 (INT. CL. 1).
- PQ CORPORATION, VALLEY FORGE, PA:
1,196,032. REN. 12-15-01. INT. CL. 1.
- PRATT & LAMBERT, INC., BUFFALO, NY:
1,803,571, CANC. INT. CL. 1.
- PRAXAIR TECHNOLOGY, INC., DANBURY, CT:
2,534,553, INT. CL. 7.
- PRECISE FLIGHT, INC., BEND, OR:
1,679,277. REN. 12-20-01. INT. CL. 9.
- PRECISION FOODS, INC., ST. LOUIS, MO, LOUIS MILANI FOODS, INC., LOS ANGELES, CA:
722,337. REN. 12-18-01. U.S. CL. 46 (INT. CL. 30).
- PRECISION FOODS, INC., ST. LOUIS, MO:
2,367,988, CANC. INT. CL. 30.
- PRECISION INTERCONNECT CORPORATION, PORTLAND, OR:
2,534,228, PUB. 11-6-2001. INT. CL. 9.
- PREDICTION SYSTEMS, INC., MANASQUAN, NJ:
1,866,618, CANC. INT. CL. 9.
- PREMARK WB HOLDINGS, INC., WILMINGTON, DE, WEST BEND COMPANY, THE, WEST BEND, WI:
1,660,860. REN. 12-18-01. INT. CL. 21.
- PREMARK WB HOLDINGS, INC., WILMINGTON, DE:
2,533,308, PUB. 11-6-2001. INT. CL. 11.
- PREMIUM PRODUCTS, INC., MOUNT VERNON, VA:
2,534,729, INT. CL. 28.
- PRENTICE-HALL PROFESSIONAL SOFTWARE, INC., NEW YORK, NY:
1,142,312, CANC. INT. CL. 9.
- PRESIDENT COMPANY, GOLDEN, CO:
1,142,864, CANC. INT. CL. 36.
1,142,865, CANC. INT. CL. 36.
- PRESTIGE ENTERPRISES, INC., THE, LOS ANGELES, CA:
1,865,740, CANC. INT. CL. 14.
- PRESTIGE TOY CORPORATION, NEW YORK, NY:
2,534,821, INT. CL. 28.
- PREVENTIVE MEDICAL TECHNOLOGIES, INC., PHOENIXVILLE, PA:
2,534,528, INT. CL. 10.
- PREVOST CAR, INC., SAINT CLAIRE, QUEBEC, CANADA:
1,172,166. REN. 12-17-01. INT. CL. 12.
- PRICE COMPANY, THE, SAN DIEGO, CA:
1,865,926, CANC. INT. CL. 33.
- PRIELA S.A., JORDI CAMP, 25, SPAIN:
2,533,272, PUB. 11-6-2001. INT. CL. 42.
- PRIME CAPITAL CORP., ROSEMONT, IL:
2,533,559, PUB. 11-6-2001. INT. CL. 36.
- PRIMEDIA ENTHUSIAST PUBLICATIONS, INC., STAMFORD, CT, COWLES MAGAZINES, INC., HARRISBURG, PA:
1,661,696. REN. 12-16-01. INT. CL. 16.
- PRINCESS HOUSE, INC., NORTH DIGHTON, MA:
1,865,733, CANC. INT. CL. 14.
- PRINCIPAL MUTUAL LIFE INSURANCE COMPANY, DES MOINES, IA:
1,865,970, CANC. INT. CL. 36.
- PRIORITIES, INC., RICHMOND, VA:
2,534,816, INT. CL. 3.
- PRL USA HOLDINGS, INC., WILMINGTON, DE, LAUREN, RICKY, NEW YORK, NY, DBA TRUSTEE OF THE RALPH LAUREN TRUST, A TRUST OF NEW YORK AND KAPLAN, MARK N., NEW YORK, NY, DBA TRUSTEE OF THE RALPH LAUREN TRUST, A TRUST OF NEW YORK:
1,698,679. REN. 12-17-01. INT. CL. 3.
- PRO GOLF OF AMERICA, INC., FARMINGTON HILLS, MI:
1,992,571, CANC. INT. CL. 28.
- PRO-TINT, INC., KANNAPOLIS, NC:
2,533,558, PUB. 11-6-2001. MULTIPLE CLASS, INT. CLS. 35 AND 37.
- PROCIDA, 13011 MARSEILLE, FRANCE:
1,865,542, CANC. INT. CL. 5.
- PROCTER & GAMBLE COMPANY, THE, CINCINNATI, OH:
2,534,724, INT. CL. 3.
- PRODIGY COMMUNICATIONS CORPORATION, WHITE PLAINS, NY:
2,533,365, PUB. 11-6-2001. INT. CL. 42.
- PRODUCTS UNLIMITED, INC., OMAHA, NE:
2,534,745, INT. CL. 20.
- PROFESSIONAL DISTRIBUTION SYSTEMS, INC., HEATHROW, FL:
2,094,853, CANC. INT. CL. 10.
- PROFESSIONAL LIABILITY UNDERWRITING SOCIETY, MINNEAPOLIS, MN:
2,533,352, PUB. 11-6-2001. U.S. CL. B.
- PROFESSOR NAZLI CHOUCRI AND WALLACE R. BAKER JOINT VENTURE, THE, CHESNUT HILL, MA:
2,534,375, MULTIPLE CLASS, INT. CLS. 9, 16 AND 41.
- PROFIT DEVELOPMENT GROUP, INC., WESTLAKE, OH:
2,533,382, PUB. 11-6-2001. INT. CL. 35.
- PROGENICS PHARMACEUTICALS, INC., TARRYTOWN, NY:
1,661,327. REN. 12-18-01. INT. CL. 1.
- PROJECT EXPLORATION, CHICAGO, IL:
2,534,790, INT. CL. 16.
- PROJECT OFFICE FURNITURE PLC, HAVERHILL, SUFFOLK CB9 8QJ, UNITED KINGDOM:
1,865,797, CANC. INT. CL. 20.
- PROJECTIONS UNLIMITED, INC., TUSTIN, CA:
1,660,225. REN. 12-17-01. INT. CL. 42.
- PROMAC, INC., ELGIN, IL:
2,534,179, PUB. 11-6-2001. INT. CL. 35.
- PROMARK INTERNATIONAL, INC., BOISE, ID:
2,533,828, PUB. 11-6-2001. INT. CL. 31.
2,534,461, INT. CL. 31.
- PROMOCHEM GMBH, 46485 WESEL, FED REP GERMANY:
2,533,258, PUB. 11-6-2001. MULTIPLE CLASS, INT. CLS. 1 AND 9.
- PROPLAS HOLDINGS INC., MISSISSAUGA, PROVINCE OF ONTARIO, CANADA:
2,533,284, PUB. 11-6-2001. INT. CL. 39.
- PROSKAUER ROSE LLP, NEW YORK, NY:
2,534,933, INT. CL. 16.
- PRUDENTIAL INSURANCE COMPANY OF AMERICA; THE, NEWARK, NJ:
1,176,480. REN. 12-20-01. INT. CL. 36.
- PRUDENTIAL INSURANCE COMPANY OF AMERICA, THE, NEWARK, NJ:
1,660,076. REN. 12-17-01. INT. CL. 36.
1,660,212. REN. 12-17-01. INT. CL. 42.
- PRUDHOMME; DON, GRANADA HILLS, CA:
1,142,484, CANC. INT. CL. 16.

- PUBLIC CITIZEN, INC., WASHINGTON, DC:
1,145,346, REN. 12-19-01. INT. CL. 42.
- PUBLIC KNOWLEDGE SYSTEMS, LLC, ANCHORAGE, AK:
2,533,463, PUB. 11-6-2001. MULTIPLE CLASS, INT. CLS.
38 AND 42.
- PUBLIC RISK DATABASE PROJECT, COLUMBIA, MD:
2,533,779, PUB. 11-6-2001. INT. CL. 9.
- PUERTO RICO COMPUTER SERVICES CORPORATION,
SAN JUAN, PUERTO RICO:
2,533,411, PUB. 11-6-2001. MULTIPLE CLASS, INT. CLS.
35 AND 37.
- PUGLIN, MICHAEL J., ZELIENOPLE, PA:
2,534,474, INT. CL. 36.
- PURCELL, DAVID L., PALM SPRINGS, CA:
2,534,238, PUB. 11-6-2001. INT. CL. 19.
- PURE INSTINCT SPORTSWEAR, INC., BAYTOWN, TX:
1,865,821, CANC. MULTIPLE CLASS, INT. CLS. 21 AND
25.
- PURE OXYGEN, L.L.C., ABITA SPRINGS, LA:
2,535,064, INT. CL. 3.
- PURINA MILLS, INC., ST. LOUIS, MO, RALSTON PURINA
COMPANY, ST. LOUIS, MO:
1,178,685, REN. 12-17-01. INT. CL. 5.
- PURSELL TECHNOLOGIES, INC., SYLACAUGA, AL:
2,534,697, MULTIPLE CLASS, INT. CLS. 1 AND 40.
- PUSH PERFORMANCE INC., LOS ANGELES, CA:
1,865,545, CANC. INT. CL. 5.
- PUTT-PUTT GOLF COURSES OF AMERICA, INC., FAYET-
TEVILLE, NC:
1,626,349, CANC. INT. CL. 41.
- Q K CORPORATION, BATON ROUGE, LA:
2,534,077, PUB. 11-6-2001. INT. CL. 32.
- Q.C. CUTTING CORP., BROOKLYN, NY:
2,534,672, INT. CL. 25.
- Q-SPORT, LLC, SANTA BARBARA, CA:
2,534,713, INT. CL. 41.
- QIAGEN GMBH, 40724 HILDEN, FED REP GERMANY:
2,533,291, PUB. 11-6-2001. MULTIPLE CLASS, INT. CLS. 1
AND 5.
- QIAGEN GMBH, D-40724 HILDEN, FED REP GERMANY:
2,533,586, PUB. 11-6-2001. MULTIPLE CLASS, INT. CLS. 1
AND 5.
- QUAD/GRAPHICS, INC., PEWAUKEE, WI:
1,865,755, CANC. INT. CL. 16.
- QUADION CORPORATION, MINNEAPOLIS, MN, MINNE-
SOTA RUBBER COMPANY, MINNEAPOLIS, MN:
926,775, REN. 12-21-01. U.S. CL. 23 (INT. CL. 7).
- QUAKER CHEMICAL CORPORATION, WILMINGTON,
DE:
1,625,484, CANC. INT. CL. 1.
- QUAKER CHEMICAL CORPORATION, CONSHOHOCKEN,
PA:
1,625,485, CANC. INT. CL. 1.
- QUAKER OATS COMPANY, THE, CHICAGO, IL:
549,523, REN. 12-17-01. U.S. CL. 46 (INT. CL. 30).
549,524, REN. 12-18-01. U.S. CL. 46 (INT. CL. 30).
- QUALCOMM INCORPORATED, SAN DIEGO, CA:
1,626,233, CANC. MULTIPLE CLASS, INT. CLS. 35 AND
36.
- QUANEX CORPORATION, JACKSON, MI:
1,661,953, REN. 12-19-01. INT. CL. 37.
- QUANTEL LIMITED, NEWBURY, BERKS, UNITED KING-
DOM:
1,625,671, CANC. INT. CL. 9.
- QUANTUM TECHNOLOGIES, INC., TWINSBURG, OH:
1,625,630, CANC. INT. CL. 7.
- QUEEN BEE GARDENS, LTD., LOVELL, WY:
2,534,148, PUB. 11-6-2001. INT. CL. 30.
- QUEENS FLOWERS, INC., THE, MIAMI, FL:
2,533,882, PUB. 11-6-2001. INT. CL. 31.
- QUEENWOOD DEVELOPMENT INC., TAO-YUAN, TAI-
WAN:
2,533,794, PUB. 11-6-2001. INT. CL. 21.
- QUICK COM AG, ZUG, SWITZERLAND:
2,534,939, INT. CL. 9.
- QUICKLY U.S.A. SNACK BAR, INC., ALHAMBRA, CA:
2,533,412, PUB. 11-6-2001. MULTIPLE CLASS, INT. CLS.
29 AND 32.
- QUINTESSENT COMMUNICATIONS, INC., REDMOND,
WA:
2,535,013, INT. CL. 9.
- R D B S.P.A., VIGANO BRIANZA (COMO), ITALY:
1,140,833, REN. 12-15-01. INT. CL. 22.
- R. H. MACY & CO., INC., NEW YORK, NY:
1,142,651, CANC. INT. CL. 25.
- R.D.C. SRL, 20010 BAREGGIO MILANO, ITALY:
2,533,228, PUB. 6-6-2000. INT. CL. 1.
- R.M. PALMER COMPANY, WEST READING, PA:
2,534,247, PUB. 11-6-2001. INT. CL. 30.
- R&M FABRICS, INC., CAPE GIRARDEAU, MO:
2,533,979, PUB. 11-6-2001. INT. CL. 40.
- RAABE CORPORATION, MENOMONEE FALLS, WI:
2,533,862, PUB. 11-6-2001. INT. CL. 2.
2,534,109, PUB. 11-6-2001. INT. CL. 2.
- RACHELS, LEM, SHELBY, NC, DBA UNCLE LEM'S:
2,533,507, PUB. 11-6-2001. INT. CL. 29.
- RADAR PICTURES, INC., LOS ANGELES, CA:
2,533,663, PUB. 11-6-2001. INT. CL. 41.
- RADEMAKER B.V., 1047 BA AMSTERDAM, NETHER-
LANDS:
2,535,043, INT. CL. 30.
- RADIAN CORPORATION, AUSTIN, TX:
1,866,270, CANC. INT. CL. 9.
- RADIATOR SPECIALTY COMPANY, CHARLOTTE, NC,
TRAFFIC SAFETY SERVICES, INC., NAPA, CA, AKA
HIGHWAY SAFETY PRODUCTS:
1,184,514, REN. 12-17-01. INT. CL. 9.
- RADIO & RECORDS, INC., LOS ANGELES, CA:
2,533,357, PUB. 9-4-2001. INT. CL. 35.
- RADIOCENTRAL, INC., SAN FRANCISCO, CA FROM
RHOADS, BRUCE ERIC, WEST PALM BEACH, FL:
2,534,647, MULTIPLE CLASS, INT. CLS. 35, 38 AND 41.
- RADIOTHERAPEUTICS CORPORATION, SUNNYVALE,
CA:
2,533,821, PUB. 11-6-2001. INT. CL. 10.
- RAF INDUSTRIES, INC., NEW YORK, NY:
1,866,468, CANC. INT. CL. 25.
- RAFFINERIE TIRLEMontoise S.A., EN NEERLANDAIS
TIENSE SUIKERRAFFINADERIJ N.V., 1150 BRUXELLES
(WOLUWE-SAINT-PIERRE), BELGIUM:
2,533,218, PUB. 11-6-2001. INT. CL. 1.
- RAGO FOUNDATIONS INC., LONG ISLAND CITY, NY:
1,142,649, CANC. INT. CL. 25.
- RAIMONDI VALVOLE S.P.A., I 20027 RESCALDINA MI,
ITALY:
1,866,200, CANC. INT. CL. 6.
- RAINEY & RAINEY ENTERPRISES, INC., INGLEWOOD,
NJ:
2,534,349, INT. CL. 41.
- RAISON PURE INTERNATIONAL, LLC., NEW YORK, NY:
2,533,599, PUB. 11-6-2001. MULTIPLE CLASS, INT. CLS.
35 AND 42.
- RALPH, ROBERT J., PLEASANTON, CA:
2,534,411, INT. CL. 18.
- RALSTON PURINA COMPANY, ST. LOUIS, MO:
1,865,910, CANC. INT. CL. 31.
- RAM PRODUCTS, CHESHIRE, CT:
1,865,813, CANC. INT. CL. 20.
- RAMP SYSTEMS, INC., PROVO, UT:
1,866,199, CANC. INT. CL. 6.
- RANDOLPH ENGINEERING, INC., RANDOLPH, MA:
2,534,894, INT. CL. 9.
- RANDOM HOUSE, INC., NEW YORK, NY:
2,534,904, INT. CL. 16.
- RANDOM WALK COMPUTING, INC., NEW YORK, NY:
2,534,107, PUB. 11-6-2001. INT. CL. 42.
- RAPELJE, STEVEN, KALISPELL, MT:
2,533,675, PUB. 11-6-2001. INT. CL. 42.
- RAUCH, BLAIR D., TINLEY PARK, IL:
1,866,495, CANC. INT. CL. 28.
- RAVE REVIEWS, INC., DENVER, CO:
2,533,951, PUB. 11-6-2001. INT. CL. 41.
- RAVEN'S HOARD, LTD., THE, AUGUSTA, GA, RAVEN'S
HOARD, THE, GRANITEVILLE, SC:
1,658,157, REN. 12-19-01. INT. CL. 14.

- RAVN, PENNY L., SPRINGFIELD, IL:
2,533,716, PUB. 11-6-2001. INT. CL. 42.
- RAWKUS ENTERTAINMENT LLC, NEW YORK, NY:
2,533,362, PUB. 11-6-2001. INT. CL. 9.
- RAYLON CORPORATION, THE, NEW YORK, NY:
2,533,738, PUB. 11-6-2001. INT. CL. 24.
- RAYTHEON COMPANY, LEXINGTON, MA:
2,533,848, PUB. 11-6-2001. INT. CL. 42.
- REA ART INC., NORVELT, PA:
1,865,512, CANC. INT. CL. 2.
- REACTIVE NETWORKING, INC., PLANO, TX:
2,533,781, PUB. 11-6-2001. MULTIPLE CLASS, INT. CLS. 9 AND 42.
- READING INVESTMENT COMPANY, INC., NEW YORK, NY, ANGELIKA FILMS, INC., NEW YORK, NY:
1,661,157, REN. 12-19-01. INT. CL. 41.
- REAL ESTATE MEDIA, INC., NEW YORK, NY:
2,535,067, INT. CL. 16.
- REALVIZ, 06560 SOPHIA ANTIPOLIS, FRANCE:
2,533,333, PUB. 11-6-2001. INT. CL. 9.
- RECIPROCAL, INC., BUFFALO, NY:
2,533,743, PUB. 11-6-2001. INT. CL. 42.
- RECKITT & COLMAN (OVERSEAS) LIMITED, HULL HUS 7DS, ENGLAND:
1,094,923, COR. INT. CL. 5.
- RECKITT BENCKISER INC., WAYNE, NJ:
2,534,323, PUB. 11-6-2001. MULTIPLE CLASS, INT. CLS. 29 AND 30.
- RECORD INDUSTRIAL COMPANY, KING OF PRUSSIA, PA:
1,142,652, CANC. INT. CL. 25.
- RECORD PRESS, INC., NEW YORK, NY:
2,533,867, PUB. 11-6-2001. INT. CL. 42.
- RECOT, INC., DALLAS, TX:
1,626,039, CANC. INT. CL. 25.
- RECOTON CORPORATION, LONG ISLAND CITY, NY:
1,142,333, CANC. INT. CL. 9.
- RED CARPET INNS INTERNATIONAL, INC., TUCKER, GA, MASTER HOSTS INTERNATIONAL, INC., BEVERLY HILLS, CA:
923,617, REN. 12-19-01. U.S. CL. 100 (INT. CL. 42).
- RED DEVIL INC., UNION, NJ:
921,393, REN. 12-15-01. U.S. CL. 12 (INT. CL. 17).
- RED GIANT, INC., ELWOOD, IN:
1,626,338, CANC. INT. CL. 40.
- RED RAM PET NUTRITION, LLC, ST. LOUIS, MO FROM RED RAM MOUNTAIN, LLC, ST. LOUIS, MO:
2,534,918, INT. CL. 5.
- RED SPOT PAINT & VARNISH CO., INC., EVANSVILLE, IN:
1,866,156, CANC. INT. CL. 2.
- REDNECK FOODS, INC., ASHEVILLE, NC:
2,533,237, PUB. 11-6-2001. INT. CL. 29.
- REDTAGOUTLET.COM, INC., EDEN PRAIRIE, MN:
2,535,096, INT. CL. 35.
- REDVECTOR.COM, INC., TAMPA, FL:
2,533,909, PUB. 11-6-2001. INT. CL. 41.
2,533,910, PUB. 11-6-2001. INT. CL. 41.
- REED AND BARTON CORPORATION, TAUNTON, MA:
1,153,856, REN. 12-20-01. INT. CL. 14.
1,156,143, REN. 12-20-01. INT. CL. 8.
1,156,144, REN. 12-20-01. INT. CL. 8.
- REED ELSEVIER INC., NEWTON, MA:
2,533,714, PUB. 11-6-2001. INT. CL. 16.
- REEMTSMA CIGARETTENFABRIKEN GMBH, 22605 HAMBURG, FED REP GERMANY:
2,533,217, PUB. 11-6-2001. INT. CL. 34.
- REES, JON, PONTE VEDRA BEACH, FL:
2,533,615, PUB. 11-6-2001. MULTIPLE CLASS, INT. CLS. 9 AND 41.
- REFEREE'S CALL, THE, OKLAHOMA CITY, OK:
2,533,270, PUB. 11-6-2001. MULTIPLE CLASS, INT. CLS. 25 AND 28.
- REFERENCE N.V., THE, 9000 GENT, BELGIUM:
2,533,328, PUB. 11-6-2001. INT. CL. 42.
- REFRACTIVE EDGE, INC., THE, COLORADO SPRINGS, CO:
2,533,634, PUB. 11-6-2001. INT. CL. 42.
2,533,635, PUB. 11-6-2001. INT. CL. 42.
- REFRIGERATION RESEARCH, INC., BRIGHTON, MI:
727,488, REN. 12-17-01. U.S. CL. 31 (INT. CL. 11).
- REGAL CHEMICAL COMPANY, ALPHARETTA, GA:
2,534,294, PUB. 11-6-2001. INT. CL. 5.
2,534,296, PUB. 11-6-2001. INT. CL. 5.
- REGIONAL ECONOMIC RESEARCH, INC., SAN DIEGO, CA:
2,533,939, PUB. 11-6-2001. INT. CL. 9.
- REHAB CHOICE INCORPORATED, ST. CHARLES, MO:
1,662,860, REN. 12-19-01. INT. CL. 42.
- REITECH CORPORATION, LAURELDALE, PA:
1,168,840, REN. 12-15-01. INT. CL. 2.
- RELAGS R. TRINKL GMBH, D-8201 TUNTENHAUSEN/HHT., FED REP GERMANY:
1,866,322, CANC. INT. CL. 11.
- RELATED PRODUCTS, INC., DAYTON, OH:
1,172,146, REN. 12-17-01. INT. CL. 11.
- RELIABILITY, INC., HOUSTON, TX:
1,173,973, REN. 12-21-01. INT. CL. 9.
- REMARK-ABLE PRODUCTS, INC., ORLANDO, FL:
2,534,704, INT. CL. 28.
- REMEMORY CORPORATION, COSTA MESA, CA:
1,866,285, CANC. INT. CL. 9.
- REMNANT, STEUBENVILLE, OH:
1,626,354, CANC. INT. CL. 41.
- REMNANT OF ISRAEL, INCORPORATED, SAVANAH, GA:
2,534,000, PUB. 11-6-2001. INT. CL. 42.
2,534,001, PUB. 11-6-2001. INT. CL. 42.
- REMOTEPPIPES, INC., HOPKINS, MN:
2,533,843, PUB. 11-6-2001. INT. CL. 42.
- RENAISSANCE GREETING CARDS, INC., SANFORD, ME, W K G & ASSOCIATES, INC., SPRINGVALE, ME, DBA RENAISSANCE GREETING CARDS:
1,703,193, REN. 12-21-01. INT. CL. 16.
- RENEW SYSTEMS, INC., BAY CITY, MI:
2,533,286, PUB. 11-6-2001. INT. CL. 1.
2,533,742, PUB. 11-6-2001. INT. CL. 41.
- RENTALMAX L.L.C., DOWNERS GROVE, IL:
2,533,836, PUB. 11-6-2001. INT. CL. 42.
- REPEL'M DISTRIBUTORS, INC., WESTPORT, CT:
1,659,392, REN. 12-19-01. INT. CL. 5.
- REPLOGLE GLOBES, INC., BROADVIEW, IL, MEREDITH CORPORATION, DES MOINES, IA:
921,551, REN. 12-20-01. U.S. CL. 26 (INT. CL. 16).
- RESCO PRODUCTS, INC., NORRISTOWN, PA, GENERAL REFRACTORIES COMPANY, VALLEY FORGE, PA:
1,640,495, REN. 12-19-01. INT. CL. 19.
- RESEARCH PRODUCT DEVELOPMENT, INC., MALVERN, PA:
1,866,385, CANC. INT. CL. 20.
- RESEARCH PROS, INC., CHICAGO, IL:
1,660,406, REN. 12-20-01. INT. CL. 35.
- RESEARCH SYSTEMS, INC., BOULDER, CO FROM FORTNER SOFTWARE, L.L.C., STERLING, VA:
2,533,395, PUB. 11-6-2001. INT. CL. 9.
- RESNICK, ERIC SHAWN, SIMI VALLEY, CA:
2,534,242, PUB. 11-6-2001. INT. CL. 36.
- RESOURCE ENTERPRISE COLLECTIVE, INC., BROOKLYN, NY:
1,866,511, CANC. INT. CL. 29.
- RESOURCE INTERNATIONAL, INC., WESTERVILLE, OH:
2,533,656, PUB. 11-6-2001. INT. CL. 42.
- RESOURCE PARTNERS, INC., WAKEFIELD, NH:
1,865,624, CANC. INT. CL. 9.
- RESOURCES ENTERPRISES INC, SLAT LAKE CITY, UT:
1,660,484, REN. 12-19-01. MULTIPLE CLASS, INT. CLS. 4 AND 42.
- RESTAURANT PROPERTIES, INC., BRONX, NY, DBA GRAND PRIX PIZZA:
1,866,512, CANC. INT. CL. 30.
1,866,583, CANC. INT. CL. 42.
- REVLON CONSUMER PRODUCTS CORPORATION, NEW YORK, NY:
1,866,167, CANC. INT. CL. 3.
- REXOLIN CHEMICALS AB, S251 06 HELSINGBORG, SWEDEN:
1,865,491, CANC. MULTIPLE CLASS, INT. CLS. 1 AND 5.

- REYES, MANUEL, FREMONT, CA, DBA REVISTAS MEXICANAS ESPECIALIZADAS:
1,865,760, CANC. INT. CL. 16.
- RHEE BROS., INC., COLUMBIA, MD:
2,534,218, PUB. 11-6-2001. INT. CL. 29.
- RHEEM MANUFACTURING COMPANY, NEW YORK, NY:
1,142,401, CANC. INT. CL. 11.
1,865,719, CANC. INT. CL. 11.
1,865,720, CANC. INT. CL. 11.
- RHEIN CHEMIE RHEINAU GMBH, D-68219 MANNHEIM, FED REP GERMANY:
2,534,050, PUB. 11-6-2001. INT. CL. 1.
- RICE, MARK, CUMMING, GA:
2,534,485, INT. CL. 28.
- RICH-MAR CORPORATION, INOLA, OK:
1,181,974, REN. 12-15-01. INT. CL. 10.
- RICHARD S. CARSON & ASSOCIATES, INC., BETHESDA, MD:
2,534,903, INT. CL. 9.
- RICHARD SAUNDERS INTERNATIONAL, INC., CINCINNATI, OH:
1,865,904, CANC. INT. CL. 30.
- RICHARDSON BRANDS COMPANY, SOUTH MIAMI, FL:
2,533,906, PUB. 11-6-2001. INT. CL. 30.
- RICHMOND TECHNOLOGY, INC., NEWPORT, CA:
1,142,544, CANC. INT. CL. 16.
- RIDGEFIELD, INC., FORT LEE, NJ:
1,865,856, CANC. INT. CL. 25.
- RINNAI AMERICA CORPORATION, PEACHTREE CITY, GA:
1,701,091, REN. 12-21-01. INT. CL. 11.
- RIOSTAR CORPORATION, HOUSTON, TX:
1,866,611, CANC. INT. CL. 42.
- RIPE DESIGN, INC., MANHATTAN BEACH, CA:
1,866,518, CANC. INT. CL. 30.
- RIVER NETWORK, PORTLAND, OR:
2,533,623, PUB. 11-6-2001. INT. CL. 42.
- RIVERSIDE PARK ENTERPRISES, INC., AGAWAM, MA:
1,853,861, CANC. INT. CL. 41.
- RIVIANA FOODS INC., HOUSTON, TX:
2,534,255, PUB. 11-6-2001. INT. CL. 30.
- RMO, INC., DENVER, CO:
2,534,774, INT. CL. 10.
- ROADWAY GLOBAL AIR, INC., INDIANAPOLIS, IN:
1,866,573, CANC. INT. CL. 39.
- ROBERT BOSCH GMBH, D-70839 GERLINGEN, FED REP GERMANY:
2,533,211, PUB. 11-6-2001. MULTIPLE CLASS, INT. CLS. 9 AND 41.
- ROBERT C. DAVIS, ROBERT V. DAVIS, BEVERLY DAVIS, AND BARBARA DAVIS, SPOKANE, WA, DBA D & D INVESTMENTS:
1,660,202, REN. 12-19-01. INT. CL. 42.
- ROBERT HALF INCORPORATED, MENLO PARK, CA:
2,533,798, PUB. 11-6-2001. INT. CL. 35.
- ROBERTS, JEFFREY J., ANAHEIM, CA:
1,866,412, CANC. INT. CL. 25.
- ROBIN'S EGG BLUE, INC., HINSDALE, IL:
2,533,652, PUB. 11-6-2001. INT. CL. 35.
- ROBINSON HOXTON PUBLISHING, LLC, SHEPHERDSTOWN, WV:
2,533,949, PUB. 11-6-2001. INT. CL. 36.
- ROBINSON, CLEOPHAS, OMAHA, NE, DBA RBACS, INC.:
1,866,476, CANC. INT. CL. 25.
- ROCK-IT CARGO, U S A, INC., SAN FERNANDO, CA:
1,625,989, CANC. INT. CL. 18.
- ROCKLAND INDUSTRIES, INC., BALTIMORE, MD:
1,174,281, REN. 12-18-01. INT. CL. 24.
- ROCKLAND INDUSTRIES, INC., BROOKLANDVILLE, MD:
1,183,840, REN. 12-18-01. INT. CL. 24.
- ROCKWOOL LAPINUS B.V., MELICK-HERKENBOSCH, NETHERLANDS:
1,659,752, REN. 12-19-01. INT. CL. 17.
- ROCKY MOUNTAIN CENTER FOR MUSICAL ARTS, LAFAYETTE, CO:
2,534,324, PUB. 11-6-2001. INT. CL. 41.
- ROCKY SHOES & BOOTS, INC., NELSONVILLE, OH:
1,865,849, CANC. INT. CL. 25.
- RODALE INC., EMMAUS, PA:
2,534,662, MULTIPLE CLASS, INT. CLS. 35, 41 AND 42.
- RODALE INSTITUTE, THE, EMMAUS, PA:
2,533,593, PUB. 11-6-2001. MULTIPLE CLASS, INT. CLS. 41 AND 42.
- RODI POWER SYSTEMS, INC., MAPLE VALLEY, WA:
2,533,454, PUB. 11-6-2001. INT. CL. 7.
- ROH, JAE KYONG, BELMONT, CA:
2,533,676, PUB. 11-6-2001. INT. CL. 42.
- ROHM AND HAAS COMPANY, PHILADELPHIA, PA:
2,533,633, PUB. 11-6-2001. MULTIPLE CLASS, INT. CLS. 41 AND 42.
- ROHSEN TECHNOLOGY & MARKETING, INC., ORANGE, CA:
2,534,932, INT. CL. 35.
- ROKEACH FOOD CORPORATION, NEWARK, NJ, I. ROKEACH & SONS, INC., NEWARK, NJ:
1,684,552, REN. 12-17-01. INT. CL. 29.
- ROLITE, INC., WAYNE, PA:
1,625,996, CANC. INT. CL. 19.
- ROLLERBLADE, INC., BORDENTOWN, NJ:
2,533,886, PUB. 11-6-2001. INT. CL. 28.
- ROLOX CORPORATION, THE, TUCKER, GA:
2,534,121, PUB. 11-6-2001. INT. CL. 8.
- ROMAC & ASSOCIATES, INC., PORTLAND, ME:
1,142,848, CANC. INT. CL. 35.
- ROMAN COMPANY, ST. LOUIS, MO, ROMAN COMPANY, ST. LOUIS, MO:
1,176,810, REN. 12-17-01. MULTIPLE CLASS, INT. CLS. 6, 14 AND 26.
- ROMAN COMPANY, ST. LOUIS, MO:
1,670,797, REN. 12-17-01. INT. CL. 14.
- ROMEO'S, INC., OMAHA, NE:
1,708,946, REN. 12-17-01. INT. CL. 42.
- ROPA GROUP CORPORATION, THE, HAUPPAUGE, NY:
2,533,629, PUB. 11-6-2001. INT. CL. 35.
2,533,630, PUB. 11-6-2001. INT. CL. 35.
- ROSCOE; LINDSEY, WATSONVILLE, CA:
1,190,791, REN. 12-17-01. INT. CL. 25.
- ROSE, ANDREW, DAVID, SCOTTSDALE, AZ:
2,534,980, INT. CL. 21.
- ROSENBERG, EVA, ENCINO, CA AND CORDELL, RICKY G., ENCINO, CA:
2,533,262, PUB. 11-6-2001. INT. CL. 42.
- ROSENFELD, RICHARD, NEW YORK, NY AND ROSENFELD, GARY, NEW YORK, NY:
2,533,597, PUB. 11-6-2001. INT. CL. 9.
- ROSSWIL LLC, CHICAGO, IL, CONWOOD CORPORATION, MEMPHIS, TN:
1,202,276, REN. 12-20-01. INT. CL. 34.
- ROUSSEL UCLAF CORPORATION, MONTVALE, NJ:
1,866,181, CANC. INT. CL. 5.
- ROUX, MICHEL P., PALM COAST, FL:
2,534,150, PUB. 11-6-2001. INT. CL. 33.
- ROYAL AMERICAN INDUSTRIES INC., WESTBORO, MA:
1,142,379, CANC. INT. CL. 10.
- ROYAL BLUNTS, INC., CORONA, CA:
2,534,012, PUB. 11-6-2001. INT. CL. 34.
- ROYAL CANIN U.S.A., INC., ST. PETERS, MO, ROYAL CANIN U.S.A., INC., ST. CHARLES, MO:
1,661,299, REN. 12-19-01. INT. CL. 31.
- ROYAL CHEMICAL, INC., ADDISON, TX:
2,533,736, PUB. 11-6-2001. MULTIPLE CLASS, INT. CLS. 35, 37 AND 39.
- ROYAL OAK SALES, INC., ROSWELL, GA:
2,534,029, PUB. 11-6-2001. INT. CL. 4.
- ROYAL PACIFIC INDUSTRIES LLC, SAN DIEGO, CA:
2,533,285, PUB. 11-6-2001. INT. CL. 16.
- ROZA, MIKE, SAN CARLOS, CA:
2,534,524, INT. CL. 41.
- RPS PRODUCTS INC., HAMPSHIRE, IL:
1,668,152, REN. 12-17-01. INT. CL. 1.
- RSCHOOL.COM INC., PENNSAUKEN, NJ:
2,533,592, PUB. 11-6-2001. INT. CL. 41.
- RUBBER TRIM PRODUCTS, INC., BUENA PARK, CA:
2,533,384, PUB. 11-6-2001. INT. CL. 40.

- RUBBERMAID COMMERCIAL PRODUCTS INC., WINCHESTER, VA:
1,142,605, CANC. INT. CL. 21.
- RUBIO'S RESTAURANTS, INC., CARLSBAD, CA:
2,534,295, PUB. 11-6-2001. INT. CL. 42.
- RUCKSTUHL AG, 4901 LANGENTHAL, SWITZERLAND:
2,535,115, INT. CL. 27.
- RUDOLPH/LIBBE INC., WALBRIDGE, OH:
2,533,833, PUB. 11-6-2001. INT. CL. 37.
2,533,834, PUB. 11-6-2001. INT. CL. 37.
- RUMBERA STEREO 101.9 F.M., C.A., VENZUELA CODIGO, VENEZUELA:
2,534,412, INT. CL. 41.
- RUPP CO., LLC, FAYETTEVILLE, NC, DBA GROUND CONTROL:
2,534,075, PUB. 11-6-2001. INT. CL. 42.
- RUSHMORE CORPORATION, VERDI:
1,625,702, CANC. INT. CL. 9.
- RUSSELL STOVER CANDIES, INC., KANSAS CITY, MO:
1,716,209, REN. 12-15-01. INT. CL. 30.
- RUSTICS OF LINDBERGH LAKE, INC., THE, CONDON, MT:
1,142,894, CANC. INT. CL. 37.
- RUTGERS, THE STATE UNIVERSITY OF NEW JERSEY, NEW BRUNSWICK, NJ:
2,450,289, COR. INT. CL. 41.
- RWD TECHNOLOGIES, INC., COLUMBIA, MD:
2,533,232, PUB. 11-6-2001. MULTIPLE CLASS, INT. CLS. 41 AND 42.
- RWE-DEA AKTIENGESELLSCHAFT FUR MINERALOEL UND CHEMIE, 2000 HAMBURG, FED REP GERMANY:
1,865,490, CANC. MULTIPLE CLASS, INT. CLS. 1 AND 2.
- RWE-DEA AKTIENGESELLSCHAFT FUR MINERALOEL UND CHEMIE, D-22297 HAMBURG, FED REP GERMANY:
2,534,534, INT. CL. 1.
- RYCENGA BUILDING CENTER, GRAND HAVEN, MI:
1,666,744, REN. 12-17-01. MULTIPLE CLASS, INT. CLS. 19 AND 42.
- RYMARK HOLDINGS, INC., WILMINGTON, DE, RYAN'S FAMILY STEAK HOUSE SYSTEMS, GREENVILLE, SC:
1,182,501, REN. 12-18-01. INT. CL. 42.
- RYZMAN FAMILY PARTNERSHIP, THE, CITY OF COMMERCE, CA, MAJESTIC DRUG CO., INC., BRONX, NY:
1,171,878, REN. 12-20-01. INT. CL. 3.
- S & J RESEARCH, INC., MONTROSE, NY, DBA INFOLINK:
1,865,945, CANC. INT. CL. 35.
- S & S LEARNING MATERIALS LIMITED, WHITBY, ONTARIO LIN 5S1, CANADA:
1,865,747, CANC. INT. CL. 16.
- S D H ENTERPRISES, INC., CORDELIA, CA:
1,643,667, REN. 12-20-01. INT. CL. 24.
- S. M. FLICKINGER CO., INC., BUFFALO, NY:
708,151, CANC. U.S. CL. 46.
- S.A. CASTEL FRERES, SOCIETE ANONYME AU CAPITAL, BORDEAUX, FRANCE:
1,142,813, CANC. INT. CL. 33.
- S.A. DES ETABLISSEMENTS JEAN BAGNIS ET FILS, 83460 LES ARCS SUR ARGENS, FRANCE, JEAN BAGNIS & FILS, NICE, ALPES-MARITIMES, FRANCE:
923,583, REN. 12-19-01. U.S. CL. 47 (INT. CL. 33).
- S.A. SPA MONOPOLE, COMPAGNIE FERMIERE DE SPA, 4900 SPA, BELGIUM:
2,533,822, PUB. 11-6-2001. INT. CL. 32.
- S.A.E.S. GETTERS S.P.A., MILAN, ITALY:
922,291, REN. 12-16-01. U.S. CL. 21 (INT. CL. 9).
- S.W. (RED) SMITH, INC., DAVIE, FL:
1,148,466, AM. INT. CL. 29.
- S-T-N HOLDINGS, INC., LAS VEGAS, NV:
2,534,910, MULTIPLE CLASS, INT. CLS. 1 AND 19.
- S/Y ASSOCIATES, LTD., MIAMI LAKES, FL:
2,533,898, PUB. 11-6-2001. INT. CL. 30.
- SAATI S.P.A., 22070 APPIANO GENTILE (COMO), ITALY:
1,654,355, REN. 12-17-01. INT. CL. 24.
- SACHS PROPERTIES, INC., CHESTERFIELD, MO:
2,533,495, PUB. 11-6-2001. INT. CL. 37.
- SAES PURE GAS, INC., SAN LUIS OBISPO, CA:
1,866,244, CANC. INT. CL. 9.
- SAFE T JACK, INC., HUNTINGTON BEACH, CA:
1,625,631, CANC. INT. CL. 7.
- SAFEGUARD BUSINESS SYSTEMS, INC., FORT WASHINGTON, PA:
1,658,948, REN. 12-20-01. INT. CL. 16.
- SAFESKIN CORPORATION, SAN DIEGO, CA:
2,533,260, PUB. 11-6-2001. MULTIPLE CLASS, INT. CLS. 9 AND 10.
- SAFETY REMEDY, INC., HARRISONVILLE, MO:
2,533,747, PUB. 11-6-2001. MULTIPLE CLASS, INT. CLS. 5 AND 41.
- SAFETY 4 A/S, LYNGBY, DENMARK:
1,625,678, CANC. MULTIPLE CLASS, INT. CLS. 9, 10 AND 17.
- SAFETY-KLEEN SYSTEMS, INC., COLUMBIA, SC, SAFETY-KLEEN CORPORATION, ELGIN, IL:
939,055, REN. 12-19-01. U.S. CL. 100 (INT. CL. 42).
- SAFLINK CORPORATION, TAMPA, FL:
2,533,522, PUB. 11-6-2001. INT. CL. 9.
2,533,528, PUB. 11-6-2001. INT. CL. 9.
- SAIN-GOBAIN PERFORMANCE PLASTICS CORPORATION, WAYNE, NJ, DIXON CORPORATION, BRISTOL, RI:
922,772, REN. 12-21-01. U.S. CL. 23 (INT. CL. 7).
- SAINT-GOBAIN PERFORMANCE PLASTICS CORPORATION, WAYNE, NJ, DIXON CORPORATION, BRISTOL, RI:
922,117, REN. 12-21-01. U.S. CL. 1 (INT. CL. 17).
- SAINT-GOBAIN PERFORMANCE PLASTICS CORPORATION, WAYNE, NJ, DIXON INDUSTRIES CORPORATION, BRISTOL, RI:
1,208,354, REN. 12-15-01. INT. CL. 17.
- SALIX PHARMACEUTICALS, INC., RALEIGH, NC:
2,534,845, INT. CL. 5.
- SALON SUCCESS LIMITED, BUCKS, ENGLAND:
2,533,533, PUB. 11-6-2001. MULTIPLE CLASS, INT. CLS. 16 AND 35.
- SALVATION ARMY, THE, CLEVELAND, OH:
1,625,556, CANC. INT. CL. 3.
- SALVATORE FERRAGAMO ITALIA S.P.A., FLORENCE, ITALY:
2,534,401, INT. CL. 3.
- SAN ANTONIO SPURS, L.L.C., SAN ANTONIO, TX:
2,534,168, PUB. 11-6-2001. INT. CL. 35.
- SAN TELMO, INC., BARRINGTON, IL:
2,534,890, INT. CL. 3.
- SANBON, INC., EL CENTRO, CA:
1,163,989, REN. 12-18-01. INT. CL. 31.
- SANCO CHEMICALS, INC., FORT WAYNE, IN:
2,534,122, PUB. 11-6-2001. INT. CL. 37.
- SANCTUM, LTD., HERZELIA 46733, ISRAEL:
2,535,094, INT. CL. 42.
- SANDBERG & SIKORSKI DIAMOND CORPORATION, NEW YORK, NY:
1,865,742, CANC. INT. CL. 14.
- SANDELLA, DEBORAH, DR., ENGLEWOOD, CO:
2,533,525, PUB. 11-6-2001. INT. CL. 41.
- SANDISK CORPORATION, SUNNYVALE, CA:
2,534,229, PUB. 11-6-2001. INT. CL. 9.
2,534,230, PUB. 11-6-2001. INT. CL. 9.
- SANDLER, HECTOR ERNESTO, 1070 BUENOS AIRES, ARGENTINA:
2,534,372, MULTIPLE CLASS, INT. CLS. 16 AND 41.
- SANDMOLD SYSTEMS, INC., NEWAYGO, MI:
1,205,931, REN. 12-20-01. MULTIPLE CLASS, INT. CLS. 6 AND 7.
- SANTA ROSA TROPICALS, SANTA ROSA, CA:
2,534,191, PUB. 11-6-2001. INT. CL. 31.
- SANTANA LTD., E. RUTHERFORD, NJ:
1,866,447, CANC. INT. CL. 25.
1,866,448, CANC. INT. CL. 25.
- SAPPI LIMITED, BRAAMFONTEIN JOHANNESBURG, SOUTH AFRICA:
2,533,297, PUB. 11-6-2001. INT. CL. 1.
- SAR-FAM, INC., BROOKVILLE, PA, DBA GILBERT'S FAMILY RESTAURANT:
2,534,314, PUB. 11-6-2001. INT. CL. 42.

- SARA LEE CORPORATION, WINSTON SALEM, NC, SYNERGY ENTERPRISES, INC., FRANKLIN, TN:
1,640,589. REN. 12-20-01. INT. CL. 25.
- SARA LEE CORPORATION, WINSTON-SALEM, NC, SYNERGY ENTERPRISES, INC., FRANKLIN, TN:
1,641,686. REN. 12-20-01. INT. CL. 42.
- SARAH SMITH'S OLD FASHIONED COOKIES, INC., PARKSTON, SD:
2,534,104, PUB. 11-6-2001. INT. CL. 30.
2,534,105, PUB. 11-6-2001. INT. CL. 30.
- SARAMAR, L.L.C., CHICAGO, IL:
2,533,766, PUB. 11-6-2001. INT. CL. 29.
- SAV-RITE, INC., WHEELING, WV:
1,626,427, CANC. INT. CL. 42.
- SAVE-A-LOT FOOD STORES, INC., EARTH CITY, MO:
2,535,080, INT. CL. 29.
- SAVIN CORPORATION, VALHALLA, NY:
1,142,368, CANC. INT. CL. 9.
- SAVVI INTERNATIONAL MARKETING, HUNTINGTON BEACH, CA:
2,533,429, PUB. 11-6-2001. INT. CL. 35.
- SB PHARMCO PUERTO RICO INC., CIDRA, PUERTO RICO:
2,534,127, PUB. 11-6-2001. INT. CL. 42.
- SBICCA OF CALIFORNIA, SOUTH EL MONTE, CA:
1,142,661, CANC. INT. CL. 25.
- SBK SUPERBIKE INTERNATIONAL LTD., TORTOLA, BR. VIRGIN ISLANDS:
2,535,104, INT. CL. 41.
- SCA HYGIENE PRODUCTS AB, S-405 03 GOTEBOG, SWEDEN:
2,534,801, INT. CL. 5.
- SCANLAN INTERNATIONAL, INC., ST. PAUL, MN:
1,625,842, CANC. INT. CL. 10.
- SCHACHTER, LAUREN, RIVERDALE, NY:
1,626,149, CANC. MULTIPLE CLASS, INT. CLS. 29 AND 42.
- SCHAFFER SYSTEMS INC., ADAIR, IA:
2,534,891, INT. CL. 21.
- SCHARCH MFG., INC., SALIDA, CO:
2,534,113, PUB. 11-6-2001. INT. CL. 13.
- SCHERER, BETH, BIRMINGHAM, AL AND RIZZUTO, RICHARD, BIRMINGHAM, AL:
2,533,782, PUB. 11-6-2001. INT. CL. 42.
- SCHERING CORPORATION, KENILWORTH, NJ:
1,866,195, CANC. INT. CL. 5.
- SCHLESINGER ASSOCIATES, INC., CHICAGO, IL:
2,534,299, PUB. 11-6-2001. INT. CL. 36.
- SCHMIDT, THOMAS M., COLUMBUS, OH:
2,533,498, PUB. 11-6-2001. INT. CL. 42.
- SCHMOJOE, INC., BORNE, TX FROM HEBERT, JAMES P., WOODLANDS, TX, DBA "SCHMOJOE":
2,533,460, PUB. 11-6-2001. INT. CL. 30.
- SCHRADER-BRIDGEPORT INTERNATIONAL, INC., DEERFIELD, IL:
2,534,435, INT. CL. 9.
- SCHU'S RESTAURANTS, INC., STEVENSVILLE, MI, SCHULER'S, INC., MARSHALL, MI:
1,670,912. REN. 12-21-01. INT. CL. 42.
- SCHULTHEISS-BRAUERREI GMBH, 13053 BERLIN, FED REP GERMANY:
2,535,001, INT. CL. 32.
- SCHULTZ, DONALD F. JR., HUNTINGTON BEACH, CA, DBA WILD 1 AND BEEKS, MARK E., HUNTINGTON BEACH, CA TO SCHULTZ, JR., DONALD F., HUNTINGTON BEACH, CA:
2,304,039, AM. INT. CL. 20.
- SCHURMAN FINE PAPERS, FAIRFIELD, CA, MARCEL SCHURMAN COMPANY, INC., OAKLAND, CA:
1,178,636. REN. 12-21-01. INT. CL. 42.
- SCHWAN'S IP, LLC, MARSHALL, MN, SCHWAN'S SALES ENTERPRISES, INC., MARSHALL, MN:
1,663,810. REN. 12-19-01. INT. CL. 30.
- SCIENTIFIC-ATLANTA, INC., ATLANTA, GA:
1,625,695, CANC. INT. CL. 9.
- SCIMUS INFORMATION SYSTEMS, LTD., COLUMBUS, OH:
2,533,570, PUB. 11-6-2001. MULTIPLE CLASS, INT. CLS. 36 AND 42.
- SCOTIA HOLDINGS PLC., GUILDFORD, SURREY GUI 1BA, ENGLAND:
1,865,531, CANC. INT. CL. 5.
- SCOTT CAO VIOLINS, CAMPBELL, CA:
2,535,114, INT. CL. 15.
- SCOTT HEATH, GREENWICH, CT, M.M. & R., INC., NEW YORK, NY:
1,659,844. REN. 12-19-01. INT. CL. 25.
- SCOTT, DAVID, M, LEXINGTON, MA:
2,534,958, INT. CL. 16.
- SCOVILL INC., WATERBURY, CT:
1,142,231, CANC. MULTIPLE CLASS, INT. CLS. 7, 9, 11, 14 AND 20.
- SD&M SOFTWARE DESIGN & MANAGEMENT AG, 81737 MUNCHEN, FED REP GERMANY:
2,533,356, PUB. 11-6-2001. MULTIPLE CLASS, INT. CLS. 41 AND 42.
- SEA EDUCATION ASSOCIATION, INC., WOODS HOLE, MA:
1,176,566. REN. 12-15-01. INT. CL. 41.
1,716,712. REN. 12-15-01. INT. CL. 41.
- SEABOOK WALLCOVERINGS, INC., MEMPHIS, TN:
1,866,364, CANC. INT. CL. 16.
- SEABROOK WALLCOVERINGS, INC., MEMPHIS, TN:
1,866,357, CANC. INT. CL. 16.
- SEALED AIR CORPORATION (US), SADDLE BROOK, NJ:
2,534,715, MULTIPLE CLASS, INT. CLS. 10 AND 17.
- SEALRIGHT COMPANY, INC., DESOTO, KS:
2,533,277, PUB. 11-6-2001. INT. CL. 20.
2,533,278, PUB. 11-6-2001. INT. CL. 20.
- SEARCH CACTUS, L.L.C., TROY, MI:
2,534,768, INT. CL. 42.
- SEARS MORTGAGE CORPORATION, VERNON HILLS, IL:
1,866,554, CANC. INT. CL. 36.
- SEARS, ROEBUCK AND CO., CHICAGO, IL:
1,142,583, CANC. INT. CL. 20.
- SECOND HARVEST FOOD BANK OF WISCONSIN, INC., MILWAUKEE, WI:
2,534,898, INT. CL. 42.
- SECURIFY INTERNATIONAL, INC., PALO ALTO, CA FROM KROL-O'GARA COMPANY, THE, FAIRFIELD, OH:
2,534,500, INT. CL. 42.
- SELECTMARK, INC., WILMINGTON, DE:
2,534,032, PUB. 11-6-2001. INT. CL. 42.
- SEMINAR RESOURCES, INC., LODI, CA:
2,533,524, PUB. 11-6-2001. MULTIPLE CLASS, INT. CLS. 38 AND 42.
- SEMINIS VEGETABLE SEDDS, INC., OXNARD, CA, PETO SEED COMPANY, INC., SATICOY, CA:
916,946. REN. 12-19-01. U.S. CL. 1 (INT. CL. 31).
- SENIOR MARKET SALES, INC.:
See—INSURACTIVE, INC..
- SENIOR MARKET SALES, INC.:
See—INSURACTIVE, INC..
- SEQUENCE CO., LTD., CHIBA, JAPAN:
2,534,862, INT. CL. 28.
- SERAC, INC., SEATTLE, WA:
1,142,631, CANC. INT. CL. 25.
- SEROYAL U.S.A., INC., WOODDALE, IL:
2,533,314, PUB. 11-6-2001. MULTIPLE CLASS, INT. CLS. 3 AND 5.
- SERVICE AMERICA CORPORATION, STAMFORD, CT:
1,626,381, CANC. INT. CL. 42.
- SERVICO, INC., ALBANY, NY:
2,534,822, INT. CL. 42.
- SG COWEN SECURITIES CORPORATION, NEW YORK, NY:
2,533,351, PUB. 11-6-2001. INT. CL. 42.
- SG LICENSING CORPORATION, THE, GREAT NECK, NY:
2,533,879, PUB. 11-6-2001. INT. CL. 3.
- SGM BIOTECH, INC., BOZEMAN, MT:
1,660,494. REN. 12-19-01. INT. CL. 5.
- SHADOW LAKE, INC.:
See—CITRA-SOLV LLC.
- SHAFFER, CLARKE & CO., INC., DARIEN, CT:
1,865,897, CANC. INT. CL. 30.

- SHAH, CHETAN, PORTLAND, OR AND SHAH, SONAL, PORTLAND, OR:
2,533,662, PUB. 11-6-2001. INT. CL. 35.
- SHAKER COMPUTER & MANAGEMENT SERVICES, INC., LATHAM, NY:
1,657,241. REN. 12-17-01. INT. CL. 9.
- SHANE-HUNTER, INC., SAN FRANCISCO, CA, DBA AQUA BLUES:
2,534,690, INT. CL. 25.
- SHANNAN LEATHERMAN, TRUSTEE FOR THE MORDECAI TRUST, CHULA VISTA, CA:
2,533,339, PUB. 11-6-2001. INT. CL. 41.
- SHARFMAN, WILLIAM L., NEW YORK, NY, DBA SHARFMAN & CO.:
1,865,933, CANC. INT. CL. 35.
- SHAW INDUSTRIES, INC., DALTON, GA:
2,534,628, INT. CL. 27.
- SHAW, MIMI BISSONNETTE, TALLAHASSEE, FL:
2,533,425, PUB. 11-6-2001. INT. CL. 41.
- SHEFFIELD, DAVID A., IRVINGTON, NJ:
2,534,338, PUB. 11-6-2001. INT. CL. 25.
- SHELDON, KRISTIN, BOULDER, CO:
2,534,448, INT. CL. 16.
- SHELDON, ROBERT, VIRGINIA BEACH, VA:
2,534,963, INT. CL. 16.
- SHICHMAN, DAVID, GREAT NECK, NY:
1,866,223, CANC. INT. CL. 9.
- SHIMANO INC., OSAKA, JAPAN, SHIMANO INDUSTRIAL COMPANY, LIMITED, OSAKA PREFECTURE, JAPAN:
1,149,728. REN. 12-17-01. INT. CL. 12.
- SHIMANO INC., SAKAI OSAKA 590-77, JAPAN:
2,534,531, INT. CL. 28.
- SHIRE INTERNATIONAL LICENSING B.V., 1017 XN AMSTERDAM, NETHERLANDS:
2,533,240, PUB. 11-6-2001. MULTIPLE CLASS, INT. CLS. 5 AND 42.
- SHOE SHOW, INC., KANNAPOLIS, NC:
1,670,839. REN. 12-15-01. INT. CL. 25.
1,670,840. REN. 12-15-01. INT. CL. 25.
1,670,841. REN. 12-15-01. INT. CL. 25.
- SHONEY'S INC., NASHVILLE, TN:
1,865,866, CANC. INT. CL. 25.
- SHONEY'S, INC., NASHVILLE, TN:
1,865,906, CANC. INT. CL. 30.
- SHOPKO STORES, INC., GREEN BAY, WI:
2,535,002, INT. CL. 35.
- SHORTWALK PTY LTD, SYDNEY NSW, AUSTRALIA:
2,534,656, INT. CL. 35.
- SHOWBIZ PIZZA TIME, INC., IRVING, TX:
1,626,342, CANC. INT. CL. 41.
- SHUERT INDUSTRIES SALES INC., STERLING HEIGHTS, MI:
1,676,376. REN. 12-19-01. INT. CL. 20.
- SHUR-VALU STAMPS, INC., LITTLE ROCK, AR:
911,062. REN. 12-18-01. U.S. CL. 101 (INT. CL. 35).
- SHURFLO PUMP MANUFACTURING COMPANY, SANTA ANA, CA:
2,535,024, INT. CL. 7.
- SIERRA CORPORATION, MINNETONKA, MN:
2,533,259, PUB. 11-6-2001. INT. CL. 2.
- SIG MFG. CO., INC., MONTEZUMA, IA:
931,071. REN. 12-17-01. MULTIPLE CLASS, U.S. CLS. 12 (INT. CL. 19), 16 (INT. CL. 2) AND 22 (INT. CL. 28).
- SIGMA FINANCE CORPORATION, GEORGE TOWN, GRAND CAYMAN, CAYMAN ISLANDS:
2,533,476, PUB. 11-6-2001. INT. CL. 36.
- SILVA, THOMAS, MATTAPOISETT, MA:
2,533,386, PUB. 11-6-2001. INT. CL. 28.
- SILVER DOLLAR CITY, INC., BRANSON, MO:
1,866,604, CANC. INT. CL. 42.
- SILVER, JARED, NEIL, BARRINGTON, IL:
2,534,301, PUB. 11-6-2001. INT. CL. 42.
- SIMAO & CA. COMERCIO E INDUSTRIAS, S.A., ALFERREDE, ABRANTES, PORTUGAL:
1,659,911. REN. 12-17-01. INT. CL. 29.
- SINGLES SOURCE, INC., PALM DESERT, CA:
2,533,531, PUB. 11-6-2001. INT. CL. 41.
- SIX FLAGS THEME PARKS INC., PARSIPPANY, NJ:
2,533,192, PUB. 11-6-2001. INT. CL. 30.
- SJI, INC., ST. LOUIS, MO:
2,533,532, PUB. 11-6-2001. INT. CL. 39.
- SKALNY GROUP INC, BATAVIA, NY, SKALNY BASKET CO., INC., ROCHESTER, NY:
1,172,316. REN. 12-20-01. INT. CL. 20.
- SKATE 2000 (U.S.A.) INC., MIAMI BEACH, FL:
1,866,059, CANC. INT. CL. 42.
- SKC AMERICA, INC., MOUNT OLIVE, NJ:
1,860,702, CANC. INT. CL. 9.
- SKI DAZZLE LLC, LAGUNA BEACH, CA, GEMINI PRODUCTIONS, INC., IRVINE, CA:
1,170,502. REN. 12-21-01. INT. CL. 35.
- SKILLSVILLAGE, INC., SUNNYVALE, CA:
2,533,496, PUB. 11-6-2001. INT. CL. 35.
- SKS.COM, LLC, ALBUQUERQUE, NM:
2,533,969, PUB. 11-6-2001. INT. CL. 42.
- SKYEPHARMA INC., SAN DIEGO, CA AND CHIRON CORPORATION, EMERYVILLE, CA TO CHIRON CORPORATION, EMERYVILLE, CA AND DEPOTECH CORPORATION, SAN DIEGO, CA:
2,390,316, COR. INT. CL. 5.
- SLOAN VALVE COMPANY, FRANKLIN PARK, IL:
1,142,413, CANC. INT. CL. 11.
1,178,947. REN. 12-15-01. INT. CL. 9.
- SLOSMAN CORPORATION, THE, ASHEVILLE, NC:
1,172,343. REN. 12-17-01. INT. CL. 24.
- SMART CITY NETWORKS, MONTVALE, NJ FROM FACILITIES COMMUNICATION INTERNATIONAL LIMITED, MONTVALE, NJ, DBA US TELCOM:
2,534,653, INT. CL. 38.
- SMARTHEALTH, INC., PHOENIX, AZ, DBA SMARTPRACTICE:
2,534,513, INT. CL. 35.
- SMARTPORTFOLIO.COM, INC., NEW YORK, NY FROM SMARTPORTFOLIO.COM, INC., LAKELAND, FL:
2,533,556, PUB. 11-6-2001. INT. CL. 35.
- SMARTPORTFOLIO.COM, INC.:
See—SMARTPORTFOLIO.COM, INC..
2,533,557, PUB. 11-6-2001. INT. CL. 35.
- SMARTPORTFOLIO.COM, INC.:
See—SMARTPORTFOLIO.COM, INC..
- SMASHITS.COM, LLC., WYNWOOD, PA:
2,533,606, PUB. 11-6-2001. INT. CL. 41.
- SMED, OLE, DENVER, CO, JAMES METAL PRODUCTS CO., CHICAGO, IL:
1,188,682. REN. 12-20-01. INT. CL. 20.
- SMITH & NEPHEW TOILETRIES LIMITED, BIRMINGHAM B8 3DZ, UNITED KINGDOM:
1,625,533, CANC. INT. CL. 3.
- SMITH & NOBLE, LLC, CORONA, CA:
2,534,870, INT. CL. 35.
2,534,872, INT. CL. 35.
- SMITH & WESSON CORP., SPRINGFIELD, MA:
1,660,123. REN. 12-19-01. INT. CL. 40.
- SMITH CORONA CORPORATION, NEW CANAAN, CT:
1,625,761, CANC. MULTIPLE CLASS, INT. CLS. 9 AND 16.
- SMITH-LEE CO., INC., ONEIDA, NY:
921,777. REN. 12-15-01. U.S. CL. 2 (INT. CL. 21).
- SMITH, GWENDOLYN K., NORTH HOLLYWOOD, CA:
2,534,971, INT. CL. 16.
- SMITH, TREVOR AUGUSTINE, KNOXVILLE, TN:
2,534,333, PUB. 11-6-2001. INT. CL. 41.
- SMITHS INDUSTRIES AEROSPACE & DEFENSE SYSTEMS, INC., WALLINGFORD, CT:
2,533,578, PUB. 11-6-2001. INT. CL. 9.
- SMOKERS CHOICE OF PA., INC., LIBERTY, NY:
2,535,113, INT. CL. 34.
- SNAK KING CORP., CITY OF INDUSTRY, CA:
2,533,644, PUB. 11-6-2001. INT. CL. 30.
- SNET PAGING, INC., NEW HAVEN, CT:
1,836,654, CANC. INT. CL. 9.
- SOCBOX LIMITED, TWICKENHAM, MIDDLESEX, ENGLAND:
1,142,230, CANC. INT. CL. 7.

- SOCCER STRATEGIES, LLC, ST. PAUL, MN TO SOCCER STRATEGIES, LLC, ST. PAUL, MN:
2,451,350, COR. INT. CL. 9.
- SOCIETE DE CONSEILS DE RECHERCHES ET D'APPLICATIONS SCIENTIFIQUES (S.C.R.A.S.), 75016 PARIS, FRANCE:
2,533,995, PUB. 11-6-2001. INT. CL. 5.
- SOCIETE EUROPEENNE DES PRODUITS REFRACTAIRES, 92400 COURBEVOIE, FRANCE:
2,533,955, PUB. 11-6-2001. INT. CL. 19.
- SOCIETY FOR HUMAN RESOURCE MANAGEMENT, ALEXANDRIA, VA:
1,660,176, REN. 12-19-01. INT. CL. 42.
2,533,654, PUB. 11-6-2001. INT. CL. 16.
- SOCPRESSE, 75116 PARIS, FRANCE:
1,865,753, CANC. INT. CL. 16.
- SOFT TRACKS ENTERPRISES LTD., RICHMOND, BRITISH COLUMBIA V6V 2X7, CANADA:
2,534,708, INT. CL. 9.
- SOFTWARE OF THE FUTURE, INC., ARLINGTON, TX:
2,533,505, PUB. 11-6-2001. INT. CL. 9.
- SOLA INTERNATIONAL INC., MENLO PARK, CA, SOLA (U.S.A.), INC., SUNNYVALE, CA:
1,168,980, REN. 12-17-01. INT. CL. 9.
- SOLARAY, INC., PARK CITY, UT:
1,659,208, REN. 12-18-01. INT. CL. 5.
- SOLBERG, CHRIS, RESEDA, CA:
1,866,035, CANC. INT. CL. 41.
- SOLUTIA INC., ST. LOUIS, MO:
2,533,835, PUB. 11-6-2001. MULTIPLE CLASS, INT. CLS. 17 AND 19.
- SOLUTION ARCHITECTS, INC., SAN FRANCISCO, CA:
2,534,279, PUB. 11-6-2001. INT. CL. 42.
- SONAFI S.A., FRANCE:
2,533,479, PUB. 11-6-2001. INT. CL. 30.
- SONAGE, INC., CHATSWORTH, CA:
2,533,783, PUB. 11-6-2001. INT. CL. 10.
- SONNENSCHN NATH & ROSENTHAL, CHICAGO, IL:
2,533,526, PUB. 11-6-2001. INT. CL. 42.
2,533,527, PUB. 11-6-2001. INT. CL. 42.
- SONY CORPORATION, TOKYO, JAPAN:
1,866,237, CANC. INT. CL. 9.
- SOUTH CAROLINA AQUARIUM, CHARLESTON, SC:
2,534,249, PUB. 11-6-2001. INT. CL. 16.
- SOUTHERN STATES COOPERATIVE INCORPORATED, RICHMOND, VA:
2,534,283, PUB. 11-6-2001. INT. CL. 1.
2,534,284, PUB. 11-6-2001. INT. CL. 1.
- SOUTHWEST SPECIALTY PRODUCTS, LLC, PHOENIX, AZ:
2,535,076, INT. CL. 6.
- SOUTHWESTERN BELL TELECOMMUNICATIONS, INC., ST. LOUIS, MO:
1,865,987, CANC. INT. CL. 38.
- SP MANAGEMENT, INC., WICHITA, KS:
2,533,407, PUB. 11-6-2001. INT. CL. 35.
- SPACECOM SYSTEMS, INC., TULSA, OK:
1,660,104, REN. 12-18-01. INT. CL. 38.
- SPARKLES GROUP INC., THE, BURLINGAME, CA:
2,534,106, PUB. 11-6-2001. INT. CL. 35.
- SPARTAN MILLS, SPARTANBURG, SC:
1,142,618, CANC. INT. CL. 24.
- SPARTAN STORES, INC., GRAND RAPIDS, MI:
1,659,080, REN. 12-18-01. MULTIPLE CLASS, INT. CLS. 35 AND 42.
- SPECIALIZED BICYCLE COMPONENTS, INC., MORGAN HILL, CA:
1,657,330, REN. 12-19-01. INT. CL. 12.
- SPECIALTY DEPARTMENT STORES, INC., NEW YORK, NY:
1,866,470, CANC. INT. CL. 25.
- SPECIALTY PRODUCTS & SERVICES, INC., SAN JOSE, CA:
2,534,604, INT. CL. 19.
- SPECIFIC SYSTEMS, LTD., TULSA, OK:
2,534,342, PUB. 11-6-2001. INT. CL. 11.
- SPECTROSPIN AG, CH-8117 FAELLANDEN, SWITZERLAND:
1,865,638, CANC. INT. CL. 9.
- SPEEDWAY MOTORS, INC., LINCOLN, NE:
2,533,619, PUB. 11-6-2001. INT. CL. 35.
2,533,641, PUB. 11-6-2001. INT. CL. 12.
- SPEEDWAY SUPERAMERICA LLC, ENON, OH, MARATHON OIL COMPANY, FINDLAY, OH:
1,168,689, REN. 12-19-01. INT. CL. 37.
- SPENCER PRODUCTS COMPANY, BEDFORD HEIGHTS, OH:
1,142,214, CANC. INT. CL. 6.
- SPORTIF USA, INC., SPARKS, NV:
2,534,337, PUB. 11-6-2001. INT. CL. 25.
- SPORTIME, LLC, ATLANTA, GA, SELECT SERVICE AND SUPPLY CO., INC., ATLANTA, GA:
1,665,914, REN. 12-17-01. INT. CL. 28.
- SPORTING GOODS MANUFACTURERS ASSOCIATION, NORTH PALM BEACH, FL:
1,660,207, REN. 12-20-01. INT. CL. 42.
- SPORTS AMERICA, INC., ROCKVILLE, MD:
1,183,193, REN. 12-19-01. MULTIPLE CLASS, INT. CLS. 35 AND 41.
- SPORTS LICENSING, INC., HANOVER, NH:
2,534,787, INT. CL. 28.
- SPORTSWATCHER, LLC, WILTON, CT:
2,533,282, PUB. 11-6-2001. INT. CL. 35.
- SPRI MEDICAL & REHAB, NORTHBROOK, IL:
2,534,415, INT. CL. 28.
- SPRING FORD INDUSTRIES, SPRING CITY, PA:
2,534,992, INT. CL. 25.
- SPRING RAM HOLDINGS PLC:
See—JACUZZI UK GROUP PLC.
- SPRINGS INDUSTRIES, INC., FORT MILL, SC:
2,534,680, INT. CL. 24.
- SPURS PROFESSIONAL BASKETBALL CLUB, LTD., SAN ANTONIO, TX:
1,866,449, CANC. INT. CL. 25.
- SQUARE CO., LTD., MEGURO-KU, TOKYO, JAPAN:
2,534,365, INT. CL. 28.
- SRA INTERNATIONAL, INC., FAIRFAX, VA:
2,533,388, PUB. 11-6-2001. INT. CL. 42.
- SRDS, INC., DES PLAINES, IL:
2,534,201, PUB. 11-6-2001. INT. CL. 35.
- SRITEX (HONG KONG) LIMITED, TSUEN WAN, N.T., HONG KONG:
2,533,981, PUB. 11-6-2001. INT. CL. 26.
- ST. FRANCIS HEALTH FOUNDATION, PITTSBURGH, PA:
1,661,804, REN. 12-19-01. INT. CL. 25.
- ST. JOHNSBURY CANDLES, INC., IMPERIAL, PA:
2,534,010, PUB. 11-6-2001. MULTIPLE CLASS, INT. CLS. 4, 21 AND 35.
- STACHOWSKI, BARBARA C., ORINDA, CA:
2,534,617, INT. CL. 26.
- STAIRMASTER SPORTS/MEDICAL PRODUCTS, INC., KIRKLAND, WA:
2,534,518, MULTIPLE CLASS, INT. CLS. 9 AND 41.
- STANDARD FITTINGS COMPANY, OPELOUSAS, LA:
1,142,225, CANC. INT. CL. 6.
- STANDARD FRUIT & STEAMSHIP COMPANY, SAN FRANCISCO CA:
708,162, CANC. U.S. CL. 46.
- STANDARD GOLF COMPANY, CEDAR FALLS, IA:
1,680,977, REN. 12-21-01. INT. CL. 8.
- STANDARD OIL COMPANY, THE, CLEVELAND, OH:
708,099, CANC. U.S. CL. 37.
- STANDARD PLYWOODS, INC., CLINTON, SC, DBA ANDERSON HARDWOOD FLOORS:
2,534,455, INT. CL. 19.
- STANLEY LOGISTICS, INC., NEW BRITAIN, CT:
2,534,454, MULTIPLE CLASS, INT. CLS. 6, 8 AND 19.
- STARBUCKS U.S. BRANDS CORPORATION, BURLINGAME, CA, STARBUCKS CORPORATION, SEATTLE, WA:
1,599,775, REN. 12-18-01. INT. CL. 30.
- STARKEY & ASSOCIATES, INC., DENVER, CO:
2,534,206, PUB. 11-6-2001. INT. CL. 41.
- STARWOOD HOTELS & RESORTS WORLDWIDE, INC., WHITE PLAINS, NY, CAESARS WORLD, INC., LOS ANGELES, CA:
1,173,637, REN. 12-20-01. MULTIPLE CLASS, INT. CLS.

- 39, 41 AND 42.
1,174,566. REN. 12-20-01. MULTIPLE CLASS, INT. CLS.
39, 41 AND 42.
- STATE INDUSTRIAL PRODUCTS CORPORATION, CLEVELAND, OH, STATE CHEMICAL MANUFACTURING COMPANY, THE, CLEVELAND, OH:
1,706,088. REN. 12-21-01. INT. CL. 1.
- STAYER, CANDICE WILSON DBA MERIDIAN LEGAL SEARCH, LAKE OSWEGO, OR:
2,534,328. PUB. 11-6-2001. INT. CL. 35.
- STEED MEDIA GROUP, ATLANTA, GA:
2,534,243. PUB. 11-6-2001. INT. CL. 16.
2,534,244. PUB. 11-6-2001. INT. CL. 16.
2,534,245. PUB. 11-6-2001. INT. CL. 16.
- STEELCASE DEVELOPMENT CORPORATION, GRAND RAPIDS, MI, STEELCASE INC., GRAND RAPIDS, MI:
1,673,873. REN. 12-20-01. INT. CL. 20.
- STEPHANI, SCOTT P., ONEIDA, WI:
2,535,127. INT. CL. 35.
- STEPHENS, JAMES A., TALLAHASSEE, FL:
1,688,208. REN. 12-17-01. INT. CL. 42.
- STEPPER, INC., OLATHE, KS:
2,534,820. INT. CL. 7.
- STEREO CORPORATION OF AMERICA, BROOKLYN, NY:
1,142,974. CANC. INT. CL. 42.
- STERLING COMMERCE, INC., DALLAS, TX:
1,568,152. REN. 12-19-01. INT. CL. 9.
- STERN ELECTRONICS, INC., CHICAGO, IL:
708,217. CANC. U.S. CL. 36.
- STERN PINBALL, INC., MELROSE PARK, IL:
2,534,684. INT. CL. 28.
2,534,685. INT. CL. 28.
- STEVENS, KAREN M., BRADLEY BEACH, NJ:
2,534,919. MULTIPLE CLASS, INT. CLS. 16 AND 35.
- STEWART, TRICIA, SANTA MONICA, CA:
2,534,559. INT. CL. 41.
- STINGER WELLHEAD PROTECTION, INC., ALLEN, TX:
2,534,496. INT. CL. 7.
- STONE BOARDWEAR, INC., COSTA MESA, CA:
2,534,210. PUB. 11-6-2001. INT. CL. 25.
- STRADLING YOCCA CARLSON & RAUTH, NEWPORT BEACH, CA:
2,534,207. PUB. 11-6-2001. INT. CL. 42.
2,534,208. PUB. 11-6-2001. INT. CL. 42.
- STRALSER, STEVEN, TUCSON, AZ:
2,534,663. INT. CL. 41.
- STRANGE ORDNANCE INC., GLENVIEW, IL:
1,865,728. CANC. INT. CL. 13.
- STRATTON INDUSTRIES, INC., CARTERSVILLE, GA:
1,142,901. CANC. INT. CL. 39.
- STRATTON INDUSTRIES, INC., CARTERSVILLE, GA:
1,142,902. CANC. INT. CL. 39.
- STRIDE RITE CORPORATION, THE, CAMBRIDGE, MA:
1,866,452. CANC. INT. CL. 25.
- STROMBECKER CORPORATION, CHICAGO, IL:
920,598. REN. 12-19-01. U.S. CL. 22 (INT. CL. 28).
- STROUSE, ADLER COMPANY, THE, NEW HAVEN, CT:
1,142,650. CANC. INT. CL. 25.
- STRUCTURAL BIOINFORMATICS INC., SAN DIEGO, CA:
2,534,211. PUB. 11-6-2001. INT. CL. 42.
- STRYKER MEDICAL, KALAMAZOO, MI:
2,534,096. PUB. 11-6-2001. INT. CL. 20.
- STUART SPECTOR DESIGNS, LTD., SAUGERTIES, NY:
1,717,957. REN. 12-20-01. INT. CL. 15.
- STUDIO PON, RANCHO SANTA MARGARITA, CA:
2,533,377. PUB. 11-6-2001. INT. CL. 9.
- STUTTON CORPORATION, BILOXI, MS:
2,533,987. PUB. 11-6-2001. INT. CL. 5.
- SUCCESSFUL MONEY MANAGEMENT SEMINARS, INC., TUALATIN, OR:
2,533,585. PUB. 11-6-2001. MULTIPLE CLASS, INT. CLS.
16 AND 41.
- SUMINOE TEXTILE CO., LTD., OSAKA, JAPAN:
2,534,675. MULTIPLE CLASS, INT. CLS. 24 AND 27.
- SUMMIT LABORATORIES, INC., CHICAGO HEIGHTS, IL, GALENOL COMPANY, ATLANTA, GA:
549,398. REN. 12-21-01. U.S. CL. 51 (INT. CL. 3).
- SUN 'N FUN EAA FLY-IN, INC., LAKELAND, FL:
1,626,346. CANC. INT. CL. 41.
- SUN VALLEY FLORAL FARMS:
See— SUN VALLEY FLORAL FARMS, LLC.
- SUN VALLEY FLORAL FARMS, LLC, ARCATA, CA FROM SUN VALLEY FLORAL FARMS, ARCATA, CA:
2,533,415. PUB. 11-6-2001. MULTIPLE CLASS, INT. CLS.
35 AND 36.
- SUNBURST PRODUCTS, INC., VENTURA, CA, DBA FREE STYLE U.S.A.:
1,640,415. REN. 12-21-01. INT. CL. 14.
- SUNDANCE DIGITAL INC., IRVING, TX:
2,533,355. PUB. 11-6-2001. INT. CL. 9.
- SUNDANCE INSTITUTE, SALT LAKE CITY, UT:
2,533,931. PUB. 11-6-2001. MULTIPLE CLASS, INT. CLS.
35 AND 41.
- SUNDT COMPANIES, INC., THE, TUCSON, AZ:
2,533,622. PUB. 11-6-2001. INT. CL. 37.
- SUNGARD NETWORK SOLUTIONS INC., PHILADELPHIA, PA:
2,533,458. PUB. 11-6-2001. INT. CL. 42.
- SUPER CLEAN YACHT SERVICE FRANCHISING, INC., NEWPORT BEACH, CA:
2,534,483. INT. CL. 37.
- SUPERIOR FLORALS, INC., MIAMI, FL:
1,856,383. CANC. INT. CL. 31.
- SUPERIOR MANUFACTURING GROUP, INC., CHICAGO, IL:
1,866,480. CANC. INT. CL. 27.
- SUPERIOR PRODUCTS, INC., CLEVELAND, OH:
2,534,878. INT. CL. 35.
- SUPERTUNER.COM, SANTA MONICA, CA FROM MEDIA & TRANSACTIONS, INC., SANTA MONICA, CA:
2,534,591. INT. CL. 38.
- SURFMARK L.L.C., OVERLAND PARK, KS:
2,533,816. PUB. 10-9-2001. INT. CL. 1.
- SURVEILLANCE DATA, INC., PLYMOUTH MEETING, PA:
2,534,290. PUB. 11-6-2001. INT. CL. 42.
- SUSQUEHANNA CABLE INVESTMENT CO., YORK, PA:
2,534,200. PUB. 11-6-2001. INT. CL. 38.
- SWANSON ANALYSIS SYSTEMS, INC., HOUSTON, PA:
1,142,994. CANC. INT. CL. 42.
- SWANSON, ANGELA, VISTA, CA:
1,865,865. CANC. INT. CL. 25.
- SWANSON, MARY CATHERINE, SAN DIEGO, CA:
2,533,626. PUB. 11-6-2001. INT. CL. 9.
- SWIMC, INC., WILMINGTON, DE, MARTIN-SENOUR COMPANY, THE, CLEVELAND, OH:
287,467. REN. 12-17-01. U.S. CL. 16 (INT. CL. 2).
- SYMONS INTERNATIONAL GROUP, INC., INDIANAPOLIS, IN:
2,534,609. INT. CL. 36.
- SYNDICATE SALES, INC., KOKOMO, IN:
2,534,079. PUB. 11-6-2001. INT. CL. 1.
- SYNTEGTECH, INC., BOW, NH:
2,533,358. PUB. 11-6-2001. INT. CL. 9.
- T & H FINE FOODS, INC., SAN DIEGO, CA:
1,865,901. CANC. INT. CL. 30.
- T.A. SHORTHILLS INCORPORATED, MILLBURN, NJ:
1,865,932. CANC. INT. CL. 35.
- T.C. HIGH TECH HERB, INC., NEW YORK, NY:
2,534,039. PUB. 11-6-2001. INT. CL. 5.
- T.R.O.O. GAMERZ, FRESNO, CA:
2,533,461. PUB. 11-6-2001. INT. CL. 41.
- T.W. ENTERPRISES, LTD., ST.CLOUD, MN:
2,534,632. INT. CL. 3.
- TABACALERA EL CREDITO, INC.:
See— INTERMATCH SWEDEN AB.
- TABLEAU SYSTEMS, INC., ATLANTA, GA:
1,866,221. CANC. INT. CL. 9.
- TAI SHENG ELECTRICAL MACHINERY CO., LTD., CHANG HUA HSIEN, TAIWAN:
2,533,379. PUB. 11-6-2001. INT. CL. 10.
- TAKARA SAKE USA, INC., BERKELEY, CA:
2,534,410. INT. CL. 33.
- TALENT ENTERTAINMENT GROUP, LLC, BEVERLY HILLS, CA:
2,535,042. MULTIPLE CLASS, INT. CLS. 35 AND 41.

- TALON AUDIO TECHNOLOGIES, DRAPER, UT:
2,534,644, INT. CL. 9.
- TAMRAC, INC., CHATSWORTH, CA, TAMRAC, VAN NUYS, CA:
1,172,053, REN. 12-15-01. MULTIPLE CLASS, INT. CLS. 9 AND 18.
- TANA-JYRA KY, 40450 JYVASKYLA 45, FINLAND:
1,142,261, CANC. MULTIPLE CLASS, INT. CLS. 7 AND 12.
- TAOSK, INC., INCLINE VILLAGE, NV:
2,533,929, PUB. 11-6-2001. INT. CL. 35.
- TARGET MARKETING, INC., LIBERTY, MO:
2,533,249, PUB. 5-29-2001. INT. CL. 42.
- TASTE, RONNIE L., BLOOMFIELD, NJ:
1,780,703, CANC. INT. CL. 42.
- TASTYFOOD INDUSTRIES (S) PTE LTD, #06-04 THYE HONG CENTRE, SINGAPORE:
1,866,515, CANC. INT. CL. 30.
- TATUNG COMPANY OF AMERICA, INC., LONG BEACH, CA:
1,865,709, CANC. INT. CL. 11.
- TAYLOR CORPORATION, NORTH MANKATO, MN, NU-ART, INC., BEDFORD PARK, IL:
1,172,213, REN. 12-16-01. INT. CL. 16.
- TAYLOR; STEWART ALAN, KINGSPORT, TN:
1,160,673, REN. 12-19-01. INT. CL. 8.
- TAYLOR, JEAN S., GEORGETOWN, CA:
1,865,991, CANC. INT. CL. 38.
- TAYLOR, LESLIE, COSTA MESA, CA:
1,863,789, CANC. INT. CL. 25.
- TBC CORPORATION, MEMPHIS, TN, TBC CORPORATION, MEMPHIS, TN:
1,655,035, REN. 12-18-01. INT. CL. 37.
- TBG INC., NEW YORK, NY:
1,142,986, CANC. INT. CL. 42.
- TEALUXE, INC., FRANKLIN, MA:
2,533,771, PUB. 11-6-2001. MULTIPLE CLASS, INT. CLS. 21, 30, 35 AND 42.
- TEAM AIR EXPRESS, INC., WINNSBORO, TX, TEAM AIR FREIGHT, INC., DFW AIRPORT, TX:
1,170,590, REN. 12-17-01. INT. CL. 39.
- TECART INDUSTRIES, INC., FARMINGTON HILLS, MI:
2,533,552, PUB. 11-6-2001. INT. CL. 9.
2,533,553, PUB. 11-6-2001. INT. CL. 9.
- TECDCO INFORMATIONS SYSTEM GMBH, 51503 ROS-RATH, FED REP GERMANY:
2,533,246, PUB. 11-6-2001. MULTIPLE CLASS, INT. CLS. 35, 38 AND 42.
- TECHNOLOGIES I, INC., HENDERSON, NV:
2,534,404, INT. CL. 16.
- TECHSONIC INDUSTRIES, INC., EUFAULA, AL:
1,866,261, CANC. INT. CL. 9.
- TEDMANN CONSULTING LTD., EDMONTON, ALBERTA T6R 1Z1, CANADA:
1,866,563, CANC. INT. CL. 37.
- TEKTEST, INC., ARCADIA, CA:
1,142,282, CANC. INT. CL. 9.
- TELECTRONICS PTY. LIMITED, LANE COVE, NEW SOUTH WALES, AUSTRALIA:
1,625,819, CANC. INT. CL. 10.
- TELEDYNE INDUSTRIES, INC., LOS ANGELES, CA:
1,142,550, CANC. INT. CL. 16.
- TELESENSORY CORPORATION, MOUNTAIN VIEW, CA:
1,866,249, CANC. INT. CL. 9.
- TELESUITE CORPORATION, ENGLEWOOD, OH:
2,535,023, INT. CL. 38.
- TELEVISION FOOD NETWORK, G.P., NEW YORK, NY:
2,534,739, INT. CL. 41.
- TEMPLE-INLAND FOREST PRODUCTS CORPORATION, DIBOLL, TX:
2,535,066, INT. CL. 17.
- TEMTEX PRODUCTS, INC., NASHVILLE, TN:
708,076, CANC. U.S. CL. 24.
- TEMUKA DIAGNOSTICS LIMITED, SALCOMBE, SOUTH DEVON, ENGLAND:
1,142,166, CANC. INT. CL. 1.
- TEN REN TEA CO., LTD., TAIPEI, TAIWAN:
2,534,683, INT. CL. 30.
2,534,695, INT. CL. 21.
- TENCOR INSTRUMENTS, MOUNTAIN VIEW, CA:
1,142,341, CANC. INT. CL. 9.
- TENFOLD CORP., DRAPER, UT:
2,533,367, PUB. 11-6-2001. INT. CL. 9.
- TENNESSEE VALLEY AUTHORITY, KNOXVILLE, TN:
1,865,858, CANC. INT. CL. 25.
- TERGRUP, S.L., 46870 ONTENIENTE (VALENCIA), SPAIN:
1,928,929, AM. INT. CL. 24.
- TERRABROOK VISTA LAKES, L.P., DALLAS, TX:
2,534,587, MULTIPLE CLASS, INT. CLS. 36 AND 37.
- TERZI, NICHOLAS, NEW YORK, NY:
2,533,932, PUB. 11-6-2001. INT. CL. 41.
- TEX-FURN, HIGH POINTE, NC:
1,865,939, CANC. INT. CL. 35.
- TEXACO INC., WHITE PLAINS, NY, TEXAS COMPANY, THE, HOUSTON, TX:
84,279, REN. 12-19-01. U.S. CL. 15 (INT. CL. 4).
- TEXACO INC., WHITE PLAINS, NY, TEXAS COMPANY, THE, NEW YORK, NY:
84,282, REN. 12-19-01. U.S. CL. 15 (INT. CL. 4).
- TEXACO INC., WHITE PLAINS, NY, TEXAS COMPANY, THE, HOUSTON, TX:
84,285, REN. 12-19-01. U.S. CL. 15 (INT. CL. 4).
84,347, REN. 12-19-01. U.S. CL. 15 (INT. CL. 4).
84,418, REN. 12-19-01. U.S. CL. 15 (INT. CL. 4).
84,432, REN. 12-19-01. U.S. CL. 15 (INT. CL. 4).
84,437, REN. 12-19-01. U.S. CL. 15 (INT. CL. 4).
- TEXACO INC., WHITE PLAINS, NY:
1,663,097, REN. 12-19-01. INT. CL. 1.
- TEXAS DAIRY QUEEN OPERATORS' COUNCIL, BED-FORD, TX:
1,693,643, REN. 12-18-01. INT. CL. 42.
- THC SYSTEMS, INC., MELVILLE, NY:
1,866,396, CANC. INT. CL. 21.
- THE ACTIVE NETWORK, INC., LA JOLLA, CA, HARLAN, DUANE A., SACRAMENTO, CA, DBA SIERRA DIGITAL:
1,694,181, REN. 12-17-01. INT. CL. 9.
- THE HOLLAND, INC., VANCOUVER, WA, BURGERSVILLE U.S.A. INC., VANCOUVER, WA:
922,942, REN. 12-17-01. U.S. CL. 100 (INT. CL. 42).
- THE PNC FINANCIAL SERVICES GROUP, INC., PITTSBURGH, PA, PNC FINANCIAL CORP, PITTSBURGH, PA:
1,659,247, REN. 12-19-01. INT. CL. 36.
- THE QUIKRETE COMPANIES, ATLANTA, GA, SOUTHERN STATES PORTLAND CEMENT COMPANY, ROCKMART, GA:
391,990, REN. 12-15-01. U.S. CL. 12 (INT. CL. 19).
- THE SELMER COMPANY, INC., ELKHART, IN, H. & A. SELMER, INC., ELKHART, IN:
506,089, REN. 12-17-01. U.S. CL. 38 (INT. CL. 16).
- THERADYNE CORPORATION, LAKEVILLE, MN:
1,142,424, CANC. INT. CL. 12.
- THERMAGE, HAYWARD, CA:
2,534,746, INT. CL. 10.
- THERMO TRILOGY CORPORATION, COLUMBIA, MD:
2,534,094, PUB. 11-6-2001. INT. CL. 5.
- THERMOFLOW, INC., WELLESLEY, MA:
1,865,653, CANC. INT. CL. 9.
1,865,658, CANC. INT. CL. 9.
- THERMOSEAL GLASS CORPORATION LLC, GLOUCESTER CITY, NJ:
2,533,279, PUB. 11-6-2001. INT. CL. 19.
- THISTLE COMPANY OF CALEDONIA LIMITED, THE, GLASGOW G3 8QU, SCOTLAND:
2,533,442, PUB. 11-6-2001. INT. CL. 5.
- THOMA, MARILYNN, WILMETTE, IL FROM PARDUCCI WINE ESTATES, LLC, UKIAH, CA:
2,535,091, INT. CL. 33.
- THOMAS & BETTS CORPORATION, RARITAN, NJ:
1,175,881, REN. 12-20-01. INT. CL. 9.
- THOMAS COOK HOLDINGS LTD., PETERBOROUGH PE3 6SB, UNITED KINGDOM:
2,533,881, PUB. 11-6-2001. INT. CL. 42.
- THOMAS PUBLISHING COMPANY, NEW YORK, NY:
2,534,687, INT. CL. 42.

- THOMAS SCHREDER LIGHTING, MILAN, IL:
1,865,616, CANC. INT. CL. 9.
- THOMPSON, ERNEST J., ST. PETERSBURG, FL, DBA THOMPSON FOOD COMPANY:
2,533,579, PUB. 11-6-2001. INT. CL. 30.
- THOMSON LEARNING LICENSING CORPORATION, CLAYMONT, DE, PETERSON'S GUIDES, INCORPORATED, PRINCETON, NJ:
1,661,700, REN. 12-17-01. INT. CL. 16.
- THOR TECH, INC., IMLAY CITY, MI, AIRSTREAM, INC., JACKSON CENTER, OH:
1,182,011, REN. 12-15-01. INT. CL. 12.
- THORCO INDUSTRIES, INC, LAMAR, DE, F. M. THORPE MANUFACTURING CO., LAMAR, MO:
1,657,431, REN. 12-17-01. INT. CL. 20.
- THOREN CAGING SYSTEMS, INC., HAZLETON, PA:
1,173,297, REN. 12-21-01. INT. CL. 21.
- THOROUGHbred CLASSICS, LLC, ALABASTER, AL:
2,534,309, PUB. 11-6-2001. INT. CL. 25.
- THOROUGHbred REMEDIES MANUFACTURING LIMITED, NEWBRIDGE, COUNTY KILDARE, IRELAND:
1,625,589, CANC. INT. CL. 5.
- THOROUGHbred SPORTS MARKETING CONCEPTS, EDMOND, OK:
1,866,024, CANC. INT. CL. 41.
- THRIGE AGRO A/S, DK 5260 ODENSE S, DENMARK, ROTARY HOES LIMITED, EAST HORNDON, ENGLAND:
544,058, REN. 12-19-01. U.S. CL. 23 (INT. CL. 7).
- THRONEBURG, JAMES L., STATESVILLE, NC:
2,533,292, PUB. 11-6-2001. INT. CL. 25.
- TIGER TESTING INC., NEW YORK, NY:
2,535,041, INT. CL. 42.
- TIGRETT, CHARLES, MEMPHIS, TN:
1,865,803, CANC. INT. CL. 20.
- TIMBER HILL RANCH, LLC, CAZEDERO, CA, DBA TIMBER HILL:
2,533,892, PUB. 11-6-2001. INT. CL. 42.
- TIME INC.:
1,678,513, REN. 12-17-01. INT. CL. 16.
- TIME INC., NEW YORK, NY:
2,534,897, INT. CL. 16.
- TIME SYSTEMS, INC., PHOENIX, AZ:
1,866,258, CANC. INT. CL. 9.
- TIME WARNER ENTERTAINMENT COMPANY, L.P., NEW YORK, NY:
2,473,248, COR. INT. CL. 41.
- TIMEX CORPORATION, MIDDLEBURY, CT:
2,534,826, INT. CL. 41.
- TINKER'S DEN, TORRANCE, CA:
2,534,407, INT. CL. 20.
- TIOXIDE EUROPE LIMITED, LONDON W14 0QL, ENGLAND:
1,866,157, CANC. INT. CL. 2.
- TISCHER, JR., RAYMOND L., BELLBROOK, OH, DBA TISCHER'S GREEN VELVET SOD FARMS:
1,659,982, REN. 12-21-01. INT. CL. 31.
- TISHCON CORP., WESTBURY, NY:
2,534,876, INT. CL. 5.
- TITAN CONSULTING SERVICES, INC., DALLAS, TX:
1,866,599, CANC. INT. CL. 42.
- TITAN CORPORATION, THE, SAN DIEGO, CA:
1,866,267, CANC. INT. CL. 9.
- TIVOL PLAZA, INC., KANSAS CITY, KS:
2,533,720, PUB. 11-6-2001. INT. CL. 14.
- TJR, INC., WHEELING, WV:
1,866,048, CANC. INT. CL. 42.
- TODD MCFARLANE PRODUCTIONS, INC., WEST LINN, OR:
1,793,662, CANC. INT. CL. 16.
- TOHO CO., LTD., LOS ANGELES, CA:
1,174,377, REN. 12-18-01. INT. CL. 28.
- TOKYO SEIMITSU CO., LTD., TOKYO, JAPAN:
921,556, REN. 12-17-01. U.S. CL. 26 (INT. CL. 9).
921,557, REN. 12-17-01. U.S. CL. 26 (INT. CL. 9).
- TOLERANS INGOL, WANAMASSA, NJ:
2,533,257, PUB. 11-6-2001. INT. CL. 7.
- TOMASSETTI, LOUIS D., ROCHESTER, NY, DBA CELLX PRODUCTS:
1,865,605, CANC. INT. CL. 9.
- TOMORROW'S TREASURES, INC., WOODBURY HEIGHTS, NJ:
1,936,999, COR. INT. CL. 40.
- TONEJET CORPORATION PTY LTD, SOUTH AUSTRALIA 5063, AUSTRALIA:
2,533,325, PUB. 11-6-2001. INT. CL. 2.
- TONERZONE.COM INC., LOS ANGELES, CA:
2,534,054, PUB. 11-6-2001. INT. CL. 2.
- TOO, INC., COLUMBUS, OH:
2,534,830, INT. CL. 3.
- TOOLING SPECIALISTS, INC., HOUSTON, TX, THREADING SYSTEMS, INC., HOUSTON, TX:
1,645,803, REN. 12-21-01. INT. CL. 7.
- TOPCO ASSOCIATES, INC., SKOKIE, IL FROM ALBERTSON'S, INC., BOISE, ID:
2,533,214, PUB. 11-6-2001. INT. CL. 4.
- TORAND PRODUCTIONS INC., LOS ANGELES, CA:
1,866,475, CANC. INT. CL. 25.
- TORRENT SYSTEMS, INC., CAMBRIDGE, MA:
2,534,212, PUB. 11-6-2001. INT. CL. 9.
- TORTILLA, INC., ALBUQUERQUE, NM:
1,950,385, CANC. INT. CL. 33.
- TOSHIBA AMERICA INFORMATION SYSTEMS, INC., IRVINE, CA:
2,533,275, PUB. 11-6-2001. INT. CL. 35.
- TOTER, INCORPORATED, STATESVILLE, NC:
1,866,108, CANC. MULTIPLE CLASS, INT. CLS. 7 AND 12.
- TOUCH TONE TECHNOLOGIES, INC., BOCA RATON, FL:
2,339,903, COR. MULTIPLE CLASS, INT. CLS. 35, 37, 38, 41 AND 42.
- TOUCHBET U.S.A., INC., SPARKS, NV:
1,865,633, CANC. INT. CL. 9.
- TOVA CORPORATION, BEVERLY HILLS, CA:
2,534,456, INT. CL. 3.
- TOWN PUMP, INC., BUTTE, MT:
2,534,319, PUB. 11-6-2001. MULTIPLE CLASS, INT. CLS. 41 AND 42.
- TOYOSHA CO., LTD., KADOMA-CITY, OSAKA, 571, JAPAN:
1,142,420, CANC. INT. CL. 12.
- TRADE SHOWS, INC., CLAREMONT, NC:
2,535,099, INT. CL. 35.
- TRADE TECH, INC., RANCHO CORDOVA, CA:
2,535,061, INT. CL. 41.
- TRADEMARKS LLC, NEW YORK, NY:
2,533,375, PUB. 11-6-2001. INT. CL. 34.
- TRADER PUBLISHING COMPANY, NORFOLK, VA:
2,534,551, MULTIPLE CLASS, INT. CLS. 35 AND 42.
- TRADITIONS OF AMERICA, PHILADELPHIA, PA:
2,533,497, PUB. 11-6-2001. INT. CL. 37.
- TRANS USA CORPORATION, EAST BRUNSWICK, NJ:
1,142,314, CANC. INT. CL. 9.
- TRANSAMERICA CORPORATION, SAN FRANCISCO, CA:
1,865,960, CANC. INT. CL. 36.
- TRANSCAL CORPORATION, ROLLING MEADOWS, IL:
1,865,681, CANC. INT. CL. 9.
- TRANSITION AUTOMATION, INC., CHELMSFORD, MA:
1,865,825, CANC. INT. CL. 21.
- TRANSPARENT CONTAINER CO., INC., BERKELEY, IL:
1,668,541, REN. 12-19-01. MULTIPLE CLASS, INT. CLS. 20 AND 37.
- TRANSPORTATION COMPONENTS, INC., HOUSTON, TX:
2,533,267, PUB. 11-6-2001. INT. CL. 12.
- TRAVEL INDUSTRIES, INC., LOUISVILLE, CO, DBA THOR 24; THOR 24, INC.; AND THOR, INC:
2,533,290, PUB. 11-6-2001. INT. CL. 42.
- TRAVERSE CITY STATE BANK, TRAVERSE CITY, MI:
2,534,949, INT. CL. 36.
- TREE OF LIFE, INC., ST. AUGUSTINE, FL, UNIVERSAL FOODS CORPORATION, MILWAUKEE, WI:
1,146,252, REN. 12-21-01. MULTIPLE CLASS, INT. CLS. 29 AND 30.
- TREEBOX INC., NEW YORK, NY:
2,534,748, INT. CL. 42.

- TRENDMASTERS, INC., ST. LOUIS, MO:
2,534,610, INT. CL. 28.
- TRENDS CLOTHING CORP., HIALEAH GARDENS, FL:
2,534,507, INT. CL. 25.
- TRENWYTH INDUSTRIES, INC., EMIGSVILLE, PA TO
TRENWYTH INDUSTRIES, INC., EMIGSVILLE (YORK),
PA:
1,760,689, COR. INT. CL. 19.
- TRIANGLE LABORATORIES, INC., CHAPEL HILL, NC:
1,866,061, CANC. INT. CL. 42.
1,866,062, CANC. INT. CL. 42.
- TRIBECA FILM CENTER, INC., NEW YORK, NY:
2,533,514, PUB. 11-6-2001. INT. CL. 41.
- TRIEBOLD PALEONTOLOGY, INC., WOODLAND PARK,
CO:
2,534,537, INT. CL. 41.
- TRIOLOGY COMMUNICATIONS, INC., PEARL, MS:
2,533,210, PUB. 11-6-2001. INT. CL. 9.
- TRINITY CHRISTIAN CENTER OF SANTA ANA, INC.,
TUSTIN, CA:
2,533,248, PUB. 11-6-2001. INT. CL. 38.
- TRIPLE PLAY SPORTS, PHILADELPHIA, PA:
1,663,866, REN. 12-20-01. INT. CL. 25.
- TRIPLE PLAY SPORTS, PHILADELPHIA, PA, LA ROSA,
FRANK, PHILADELPHIA, PA:
1,670,921, REN. 12-20-01. INT. CL. 25.
- TROTT, MICHAEL W., POTOMAC FALLS, VA:
2,534,136, PUB. 11-6-2001. INT. CL. 21.
- TROTTA, JAMES, FLAGTOWN, NJ:
1,660,221, REN. 12-17-01. INT. CL. 42.
- TRUE NORTH COMMUNICATIONS INC., CHICAGO, IL:
2,534,637, MULTIPLE CLASS, INT. CLS. 35 AND 42.
- TRUTH HARDWARE CORPORATION, OWATONNA, MN:
2,534,364, INT. CL. 6.
- TSGL HOLDING, INC., FORT WORTH, TX:
2,533,231, PUB. 11-6-2001. MULTIPLE CLASS, INT. CLS.
35, 39 AND 42.
- TSIYONI, JOSEPH, TEMPE, AZ, DBA SHAIRON INTERNA-
TIONAL TRADE CO.:
1,661,818, REN. 12-20-01. INT. CL. 28.
- TU, JUDY, ALHAMBRA, CA:
2,533,744, PUB. 11-6-2001. INT. CL. 4.
- TUCKER FARMS, INC., GREENVILLE, NC:
2,533,303, PUB. 11-6-2001. INT. CL. 35.
- TUCKER INTERNATIONAL, BOULDER, CO:
2,535,036, MULTIPLE CLASS, INT. CLS. 16 AND 35.
- TURNER COMMUNICATIONS CORP., MIAMI, FL:
2,535,039, MULTIPLE CLASS, INT. CLS. 16 AND 42.
- TURNER, DEBORAH A., CAVE CREEK, AZ:
2,534,266, PUB. 11-6-2001. INT. CL. 10.
- TURNER, DENNIS, VENTURA, CA, DBA TURNER MAN-
AGEMENT GROUP:
1,660,037, REN. 12-18-01. INT. CL. 35.
- TURNER, JEFFREY G., LEAVENWORTH, KS:
2,533,690, PUB. 11-6-2001. INT. CL. 35.
- TURTLE WAX, INC., CHICAGO, IL:
1,625,493, CANC. INT. CL. 1.
- TWD ENTERPRISES, INC., EDEN PRAIRIE, MN:
2,533,444, PUB. 11-6-2001. INT. CL. 41.
- TWEEDIE, REBECCA HALE, SAN ANSELMO, CA, DBA
HISTORIC GRAND PRIX:
2,535,112, INT. CL. 41.
- TWO WHEELS, INC., FERNDALE, MI:
2,534,480, MULTIPLE CLASS, INT. CLS. 25 AND 42.
- TWO-TEN COMMUNICATIONS LIMITED, LONDON EC1V
9UN, ENGLAND:
1,865,750, CANC. MULTIPLE CLASS, INT. CLS. 16, 35, 36,
38, 41 AND 42.
- TYCO INDUSTRIES, INC., MOUNT LAUREL, NJ:
1,866,288, CANC. INT. CL. 9.
- TYLER STEEL COMPANY, TYLER, TX:
2,534,466, INT. CL. 6.
- TZEMET - RUBBER INDUSTRY AND SOLID TYRES,
HALUZA, ISRAEL:
1,587,655, REN. 12-20-01. INT. CL. 12.
- U L CANADA INC., TORONTO, ONTARIO M4W 3R2,
CANADA:
2,533,727, PUB. 11-6-2001. INT. CL. 30.
- U.S. GRIPS, INC., VISTA, CA:
1,866,492, CANC. INT. CL. 28.
- U-HAUL INTERNATIONAL, INC., PHOENIX, AZ, ARCOA,
INC., PHOENIX, AZ:
921,692, REN. 12-20-01. U.S. CL. 101 (INT. CL. 35).
- UBS AG:
See—BRINSON PARTNERS, INC..
- UCHU KAIHATSU JIGYODAN, MINATO-KU, TOKYO,
JAPAN, DBA NATIONAL SPACE DEVELOPMENT
AGENCY OF JAPAN:
1,866,118, CANC. MULTIPLE CLASS, INT. CLS. 9 AND
16.
- UCI, INC., ALGONQUIN, IL:
2,534,013, PUB. 11-6-2001. INT. CL. 11.
- UHLSPORT GMBH, BALINGEN, FED REP GERMANY,
SPORTARTIKELFABRIK KARL UHL GMBH, BALINGEN
1, FED REP GERMANY:
1,173,041, REN. 12-20-01. MULTIPLE CLASS, INT. CLS.
10, 25 AND 28.
- ULLICO INC., WASHINGTON, DC:
1,705,404, REN. 12-19-01. INT. CL. 36.
2,534,835, INT. CL. 36.
- ULTIMA ELECTRONICS CORPORATION, FREMONT, CA:
1,866,240, CANC. INT. CL. 9.
- ULTRACHEM, INC., NEW CASTLE, DE:
2,533,573, PUB. 11-6-2001. INT. CL. 4.
- ULTRAFLEX SYSTEMS, INC., ROCKAWAY, NJ:
2,533,694, PUB. 11-6-2001. INT. CL. 24.
- UNCLE BEN'S, INCORPORATED, HOUSTON, TX:
1,171,238, REN. 12-17-01. INT. CL. 17.
- UNCLE BIRTHDAY LIMITED, NORTH HUMBERSIDE
HU15 1NB, ENGLAND:
1,865,513, CANC. MULTIPLE CLASS, INT. CLS. 3, 9, 16,
28 AND 35.
- UNI-CHARM CORPORATION, KAWANOE-SHI, EHIME-
KEN, JAPAN:
1,865,527, CANC. INT. CL. 3.
- UNION CARBIDE CHEMICALS & PLASTICS TECHNOL-
OGY CORPORATION, DANBURY, CT:
1,657,907, REN. 12-21-01. INT. CL. 1.
- UNION METALS CO., LTD., 727 - 15, KOJAN-DONG
NAMDONG-GU, INCHEON, REPUBLIC OF KOREA:
2,534,586, INT. CL. 6.
- UNION VITINICOLA, S.A. VINEDOS EN CENICERO, 26350
CENICERO (LA RIOJA), SPAIN:
2,533,511, PUB. 11-6-2001. INT. CL. 33.
- UNIQUELIFE, INC., LOS ALTOS, CA:
2,533,359, PUB. 11-6-2001. INT. CL. 5.
- UNISCRIBE PROFESSIONAL SERVICES, INC, NORWALK,
CT:
2,534,416, MULTIPLE CLASS, INT. CLS. 35, 38, 39, 40
AND 42.
- UNITED AMERICAN VIDEO CORPORATION, FORT MILL,
SC:
1,866,421, CANC. INT. CL. 25.
- UNITED COMMUNICATIONS GROUP LIMITED PART-
NERSHIP, ROCKVILLE, MD:
2,534,510, INT. CL. 16.
- UNITED DELTA, INC., ONTARIO, CA:
2,533,509, PUB. 11-6-2001. INT. CL. 5.
- UNITED PROPANE GAS COMPANIES, INC., PADUCAH,
KY:
2,533,263, PUB. 11-6-2001. MULTIPLE CLASS, INT. CLS.
4, 35 AND 39.
- UNITED SERVICES AUTOMOBILE ASSOCIATION, SAN
ANTONIO, TX:
1,712,134, REN. 12-19-01. MULTIPLE CLASS, INT. CLS.
35, 36, 39 AND 42.
1,712,135, REN. 12-19-01. MULTIPLE CLASS, INT. CLS.
35, 36, 39 AND 42.
- UNITED STATES DISTANCE LEARNING ASSOCIATION,
NEEDHAM, MA:
2,533,847, PUB. 11-6-2001. MULTIPLE CLASS, INT. CLS.
41 AND 42.
- UNITED STATES FILTER CORPORATION, PALM DESERT,
CA, LINK-BELT COMPANY, CHICAGO, IL:
286,793, REN. 12-20-01. U.S. CL. 23 (INT. CL. 11).

- UNITED STATES PIPE AND FOUNDRY COMPANY, BIRMINGHAM, AL:
1,142,409, CANC. INT. CL. 11.
- UNITED STATES SURGICAL CORPORATION, NORWALK, CT:
1,661,282. REN. 12-21-01. INT. CL. 10.
1,661,283. REN. 12-21-01. INT. CL. 10.
- UNIVERSAL AGENCIES, INC. (UAI), ROSWELL, GA:
2,534,950, INT. CL. 6.
- UNIVERSAL CITY STUDIOS, INC., UNIVERSAL CITY, CA:
1,866,560, CANC. INT. CL. 36.
2,534,494, INT. CL. 41.
- UNIVERSAL COOPERATIVES, INC., EAGAN, MN:
2,533,959, PUB. 11-6-2001. INT. CL. 5.
- UNIVERSAL LIGHTING TECHNOLOGIES, INC., NASHVILLE, TN FROM MAGNETEK, INC., NASHVILLE, TN:
2,534,476, INT. CL. 9.
- UNIVERSAL SKYTURNS, INC., NEW YORK, NY:
1,142,900, CANC. INT. CL. 39.
- UNIVERSITY OF NOTRE DAME DU LAC, NOTRE DAME, IN:
1,667,014. REN. 12-16-01. INT. CL. 41.
- UNIVERSITY OF NOTRE DAME DU LAC, THE, NOTRE DAME, IN:
1,662,783. REN. 12-16-01. INT. CL. 38.
- UNIVERSITY OF TENNESSEE, THE, KNOXVILLE, TN:
1,626,075, CANC. INT. CL. 25.
- UNIVEST CORPORATION OF PENNSYLVANIA, SOUDERTON, PA:
2,533,441, PUB. 11-6-2001. INT. CL. 36.
- UNPLUGI, INC., NEW YORK, NY FROM CADMUS JOURNAL SERVICES, INC., RICHMOND, VA:
2,535,026, INT. CL. 9.
- UNUM CORPORATION, PORTLAND, ME:
1,865,959, CANC. INT. CL. 36.
- UPJOHN COMPANY, THE, KALAMAZOO, MI:
708,010, CANC. U.S. CL. 18.
708,012, CANC. U.S. CL. 18.
708,015, CANC. U.S. CL. 18.
- UPPER ROOM, THE, NASHVILLE, TN:
2,534,572, MULTIPLE CLASS, INT. CLS. 9, 16, 41 AND 42.
- URASEAL, INC., DOVER, NH:
2,535,063, INT. CL. 17.
- US JESCO INTERNATIONAL LTD. INC., CARROLLTON, TX:
2,534,565, INT. CL. 21.
- US THIN FILM PRODUCTS INC., CAMPBELL, CA:
1,865,643, CANC. INT. CL. 9.
- USA COOKS, INC., CHICAGO, IL:
2,535,101, INT. CL. 42.
- USERLAND SOFTWARE, INC., PALO ALTO, CA:
1,866,220, CANC. INT. CL. 9.
- V. MARIOTTI S.R.L., I-10095 GRUGLIASCO (TORINO), ITALY:
2,535,062, INT. CL. 12.
- VAIL ASSOCIATES, INC., VAIL, CO TO VAIL TRADEMARKS, INC., VAIL, CO:
1,139,021, CANC. MULTIPLE CLASS, INT. CLS. 35 AND 37.
- VAIL TRADEMARKS, INC., VAIL, CO, VAIL ASSOCIATES, INC., VAIL, CO:
1,139,021. REN. 12-20-01. MULTIPLE CLASS, INT. CLS. 39 AND 41.
- VALLEY TELEPHONE COOPERATIVE, INC., WILLCOX, AZ:
2,534,031, PUB. 11-6-2001. INT. CL. 38.
- VALMONT INDUSTRIES, INC., OMAHA, NE:
1,172,144. REN. 12-21-01. MULTIPLE CLASS, INT. CLS. 11 AND 37.
- VALSPAR CORPORATION, THE, MINNEAPOLIS, MN:
1,663,112. REN. 12-20-01. INT. CL. 2.
- VALUE SMART PRODUCTS, LLC, CHESTERFIELD, MO:
2,534,700, INT. CL. 3.
2,534,781, INT. CL. 3.
- VAN VOORHIS, JOHN DANIEL, SAN JOSE, CA:
1,866,045, CANC. INT. CL. 42.
- VANGUARD AIRLINES, INC., KANSAS CITY, MO:
2,534,277, PUB. 11-6-2001. INT. CL. 39.
- VANGUARD GROUP, INC., THE, VALLEY FORGE, PA:
1,866,556, CANC. INT. CL. 36.
- VANPRAAG, RAY, TUSTIN, CA:
2,533,942, PUB. 11-6-2001. INT. CL. 42.
- VANPRAGG, RAY, TUSTIN, CA:
2,533,943, PUB. 11-6-2001. INT. CL. 42.
- VANTEON CORPORATION, PITTSFORD, NY FROM METAMOR SOFTWARE SOLUTIONS, INC., PITTSFORD, NY:
2,533,406, PUB. 11-6-2001. INT. CL. 42.
- VAPORTEK, INC., SUSSEX, WI:
2,534,605, INT. CL. 11.
- VARIOBOARD GMBH, D-39126 MAGDEBURG, FED REP GERMANY:
2,533,510, PUB. 11-6-2001. MULTIPLE CLASS, INT. CLS. 19 AND 20.
- VARTA BATTERIES, INC., ELMSFORD, NY:
1,154,641. REN. 12-19-01. INT. CL. 9.
1,160,712. REN. 12-19-01. INT. CL. 9.
- VAST RESOURCES, INC., SAN FERNANDO, CA:
2,534,965, INT. CL. 10.
- VELCERO, LLC, MOORESTOWN, NJ:
2,533,994, PUB. 11-6-2001. INT. CL. 42.
- VENT TECH LEATHERS, INC., GLENDALE, CA:
1,866,432, CANC. INT. CL. 25.
- VERBEX VOICE SYSTEMS, INC., EDISON, NJ:
1,841,710, CANC. INT. CL. 9.
- VERMEER MANUFACTURING COMPANY, PELLA, IA:
2,535,049, INT. CL. 16.
- VIACOM HA! HOLDING COMPANY, NEW YORK, NY:
2,533,788, PUB. 11-6-2001. MULTIPLE CLASS, INT. CLS. 38 AND 41.
- VIACOM INTERNATIONAL INC., NEW YORK, NY:
2,534,359, INT. CL. 16.
- VIBA FIMA, INC., BUFFALO GROVE, IL:
2,534,726, INT. CL. 35.
2,534,727, INT. CL. 35.
2,534,728, INT. CL. 35.
- VICTOREEN, INC., CLEVELAND, OH:
1,142,382, CANC. INT. CL. 10.
- VIDEO UPDATE, INC., ST. PAUL, MN:
1,663,728. REN. 12-17-01. INT. CL. 42.
- VIDEOTRONIC INTERNATIONAL GMBH, D-76437 RAS-TATT, FED REP GERMANY:
2,533,371, PUB. 11-6-2001. MULTIPLE CLASS, INT. CLS. 9, 35, 37 AND 41.
- VIDITEC, INC., PLANO, TX:
2,534,938, INT. CL. 9.
- VIEWPOINT INTERNATIONAL, INC., NEW YORK, NY:
2,535,136, INT. CL. 25.
- VILLAGE OF SCHILLER PARK, SCHILLER PARK, IL:
2,534,041, PUB. 11-6-2001. INT. CL. 42.
- VILLAGE VENTURES, INC., WILLIAMSTOWN, MA:
2,534,146, PUB. 11-6-2001. INT. CL. 36.
- VINCENT, ROBERT C., NORTH WALES, PA:
1,866,494, CANC. INT. CL. 28.
- VIRANIM TECHNOLOGIES, INC., SALT LAKE CITY, UT:
2,533,920, PUB. 11-6-2001. INT. CL. 42.
- VIRBAC AH, INC., FORT WORTH, TX, ALLERDERM INC., HURST, TX:
1,209,484. REN. 12-17-01. INT. CL. 5.
- VIRGINIA INDUSTRIES, INC., ROCKY HILL, CT:
2,533,946, PUB. 11-6-2001. INT. CL. 7.
- VIRIDIEN TECHNOLOGIES, INC., BOXBOROUGH, MA:
2,533,555, PUB. 11-6-2001. INT. CL. 35.
- VIRTUAL EDGE U.S., L.L.C., YARDLEY, PA:
2,535,084, MULTIPLE CLASS, INT. CLS. 35, 38, 39 AND 42.
- VIRTUAL SILICON TECHNOLOGY, INC., SUNNYVALE, CA:
2,533,471, PUB. 11-6-2001. INT. CL. 9.
- VISHAL GROVER R, ROWLAND HEIGHTS, CA:
2,534,313, PUB. 11-6-2001. INT. CL. 42.
- VISION ENTERTAINMENT, INC., SANTA MONICA, CA:
2,533,989, PUB. 11-6-2001. INT. CL. 42.
- VISIONUNLIMITED.NET, INC., GEORGETOWN, OH:
2,534,676, MULTIPLE CLASS, INT. CLS. 36 AND 38.

- VISTEON CORPORATION, DEARBORN, MI, FORD MOTOR COMPANY, DEARBORN, MI:
721,812. REN. 12-18-01. U.S. CL. 19 (INT. CL. 12).
- VITAQUEST INTERNATIONAL, INC., WEST CALDWELL, NJ, WINDMILL MARKETING SERVICES, INC., FAIRFIELD, NJ:
1,654,161. REN. 12-15-01. INT. CL. 5.
- VITO MARCELLO'S GOURMET FOOD PRODUCTS, INC., NO. CONWAY, NH:
1,606,547. REN. 12-19-01. INT. CL. 29.
- VITRO CORPORATION, SILVER SPRING, MD:
1,866,012. CANC. INT. CL. 41.
- VIVIDENCE CORPORATION, SAN MATEO, CA FROM FACILITAS, INC., SAN MATEO, CA:
2,534,661. INT. CL. 35.
- VO-TOYS, INC., HARRISON, NJ:
1,190,389. REN. 12-18-01. INT. CL. 3.
1,190,389. CANC. INT. CL. 5.
- VOCALSOFT CORPORATION, RICHARDSON, TX:
2,533,698. PUB. 11-6-2001. INT. CL. 42.
- VOGUE TYRE & RUBBER COMPANY, MT. PROSPECT, IL:
2,534,865. INT. CL. 12.
- VOICESTREAM WIRELESS CORPORATION, BELLEVUE, WA:
2,533,785. PUB. 11-6-2001. INT. CL. 38.
2,533,805. PUB. 11-6-2001. INT. CL. 35.
- VOLK ENTERPRISES, INC., TURLOCK, CA:
1,865,580. CANC. INT. CL. 7.
- VOLKSWAGEN OF AMERICA, INC., AUBURN HILLS, MI:
2,534,235. PUB. 11-6-2001. INT. CL. 16.
- VOLZ, PATRICIA STUART, DARIEN, CT:
1,142,937. CANC. INT. CL. 42.
- VONS COMPANIES, INC., THE, ARCADIA, CA:
2,533,571. PUB. 11-6-2001. INT. CL. 5.
2,533,572. PUB. 11-6-2001. INT. CL. 30.
- VOTE.COM, INC., STAMFORD, CT:
2,533,380. PUB. 11-6-2001. MULTIPLE CLASS, INT. CLS. 38 AND 42.
- VV PUBLISHING CORPORATION, NEW YORK, NY:
1,865,778. CANC. INT. CL. 16.
- VYMURA PLC., HYDE, CHESHIRE, SK14 4EJ, ENGLAND:
1,866,341. CANC. INT. CL. 16.
- W SOLUTIONS, INCORPORATED, MINNEAPOLIS, MN:
2,534,267. PUB. 11-6-2001. INT. CL. 9.
- W.W. GRAINGER, INC., LAKE FOREST, IL:
2,534,306. PUB. 11-6-2001. INT. CL. 37.
- WACHOVIA BANK AND TRUST COMPANY, N.A., WINSTON-SALEM, NC:
1,284,567. CANC. INT. CL. 36.
- WADE CERAMICS LIMITED, STOKE-ON-TRENT, STAFFORDSHIRE, ST6 4AE, UNITED KINGDOM:
2,533,474. PUB. 11-6-2001. INT. CL. 21.
- WADE, DIANE, FRANKLIN, TN:
2,534,355. INT. CL. 16.
- WAHLER, BRYAN R, WEST HILLS, CA:
2,533,715. PUB. 11-6-2001. INT. CL. 10.
- WALKER, SCOTT, ENCINITAS, CA, DBA NEURO-EMOTIONAL TECHNIQUE:
1,675,427. REN. 12-18-01. INT. CL. 41.
- WALKER, VERNON, ST. LOUIS, MO, DBA MASTER PLAY ENTERTAINMENT:
2,534,439. INT. CL. 28.
- WALLACE & TIERNAN, INC., BELLEVILLE, NJ:
1,625,856. CANC. INT. CL. 11.
- WALLEY RESOURCES, INC., PHILADELPHIA, PA:
2,533,566. PUB. 11-6-2001. INT. CL. 35.
- WALLIS ARNOLD ENTERPRISES, INC., BOULDER, CO:
1,866,100. CANC. INT. CL. 42.
- WALLOVER OIL COMPANY INCORPORATED, STRONGSVILLE, OH:
2,533,780. PUB. 11-6-2001. MULTIPLE CLASS, INT. CLS. 4 AND 42.
- WALSH DISTRIBUTION, INC., TEXARKANA, TX:
2,533,537. PUB. 11-6-2001. MULTIPLE CLASS, INT. CLS. 35 AND 42.
- WALSH, EVAN S., DOVER, MA:
2,533,608. PUB. 11-6-2001. INT. CL. 3.
- WALTCO TRUCK EQUIPMENT CO., TALLMADGE, OH:
2,534,780. INT. CL. 12.
- WALTER, JOHN C., GRAND SALINE, TX, DBA KIMBREW-WALTER ROSES:
1,865,915. CANC. INT. CL. 31.
- WALTHER SCHOENENBERGER PFLANZENSFTWERK GMBH & CO., D-71106 MAGSTADT, FED REP GERMANY, HENSELWERK, GMBH, MAGSTADT, FED REP GERMANY:
1,641,012. REN. 12-19-01. INT. CL. 5.
- WARD, DALE, NEWNAN, GA:
1,866,224. CANC. INT. CL. 9.
- WARRICK CONTROLS, INC., ROYAL OAK, MI:
1,625,714. CANC. INT. CL. 9.
- WASATCH PHARMACEUTICAL INC., MIDVALE, UT:
2,533,645. PUB. 11-6-2001. INT. CL. 5.
2,533,646. PUB. 11-6-2001. INT. CL. 5.
2,533,648. PUB. 11-6-2001. INT. CL. 5.
2,533,649. PUB. 11-6-2001. INT. CL. 5.
2,533,650. PUB. 11-6-2001. MULTIPLE CLASS, INT. CLS. 5 AND 42.
- WATANGAA, INC., PORT TOWNSEND, WA, DBA COYOTE FOUND CANDLES:
2,533,205. PUB. 11-6-2001. INT. CL. 4.
- WATER PIK TECHNOLOGIES, INC., NEWPORT BEACH, CA FROM TELEDYNE INDUSTRIES, INC., LOS ANGELES, CA, DBA TELEDYNE WATER PIK:
2,534,594. INT. CL. 11.
- WATER REFINING INDUSTRIAL, INC., MIDDLETOWN, OH:
1,142,397. CANC. INT. CL. 11.
- WAV, INC., WEST CHICAGO, IL:
2,533,445. PUB. 11-6-2001. INT. CL. 35.
- WAVE TECH INTERNATIONAL, INC.:
See—BESTNET COMMUNICATIONS CORP.
- WEALTHKNOWLEDGE.COM, FALLS CHURCH, VA:
2,533,404. PUB. 11-6-2001. INT. CL. 35.
- WEALTHKNOWLEDGE.COM, INC., FALLS CHURCH, VA:
2,533,405. PUB. 11-6-2001. INT. CL. 35.
- WEATHER BARRIER, INC., CONSHOHOCKEN, PA:
2,533,300. PUB. 11-6-2001. INT. CL. 2.
- WEATHERILL, NEIL KENNETH, ALWOODLEY, LEEDS, LS17 7QZ, W YORKSHIRE, UNITED KINGDOM:
1,865,748. CANC. INT. CL. 16.
- WEBER-STEPHEN PRODUCTS CO., PALATINE, IL:
2,534,195. PUB. 11-6-2001. INT. CL. 11.
- WEBEX, INC., NEENAH, WI:
2,533,763. PUB. 11-6-2001. INT. CL. 7.
- WEBUILDERS CORPORATION, PLYMOUTH MEETING, PA:
2,533,369. PUB. 11-6-2001. INT. CL. 35.
- WEDECO UMWELTTECHNOLOGIE WASSER-BODENLUFT GMBH, D-4000 DUSSELDORF, FED REP GERMANY TO WBL HOLDING GMBH, D-DUSSELDORF, FED REP GERMANY:
1,858,501. CANC. INT. CL. 42.
- WEHAH FARM, INC., RICHVALE, CA:
1,658,377. REN. 12-18-01. INT. CL. 30.
- WEHOCHURCH.COM, LOS ANGELES, CA:
2,533,791. PUB. 10-9-2001. INT. CL. 41.
- WEIN PRODUCTS, INC., LOS ANGELES, CA:
2,534,611. INT. CL. 11.
- WEINBERGER GROUP, L.L.C., THE, EAST BRUNSWICK, NJ:
2,535,030. INT. CL. 9.
- WEINER, JOEL, MARINA DEL REY, CA:
2,534,377. INT. CL. 35.
- WEINGARTEN, JEFFREY, LONDON W8 4RP, ENGLAND:
2,534,593. INT. CL. 36.
- WELCH, WARREN W., COLORADO SPRINGS, CO, DBA WIL-AREN ORIGINALS:
1,142,458. CANC. MULTIPLE CLASS, INT. CLS. 14 AND 26.
- WELLBORE NAVIGATION, INC., TUSTIN, CA:
2,533,465. PUB. 11-6-2001. MULTIPLE CLASS, INT. CLS. 9, 37, 40 AND 42.

- WELLNESS COMMUNITY-NATIONAL, THE, SANTA MONICA, CA:
1,866,135, CANC. MULTIPLE CLASS, INT. CLS. 41 AND 42.
- WELLS FARGO & COMPANY, MINNEAPOLIS, MN, NORWEST CORPORATION, MINNEAPOLIS, MN:
1,708,617. REN. 12-17-01. INT. CL. 36.
- WENDIN, INC., SPOKANE, WA, M. M. MEASON, INC., ROCKVILLE, MD:
924,272. REN. 12-21-01. U.S. CL. 36 (INT. CL. 15).
- WERLEIN, KENNETH, HOUSTON, TX:
2,534,262, PUB. 11-6-2001. INT. CL. 9.
- WERNER ENTERPRISES, INC.:
See— WERNER MANAGEMENT, INC.
- WERNER MANAGEMENT, INC., OMAHA, NE FROM WERNER ENTERPRISES, INC., OMAHA, NE:
2,533,908, PUB. 7-31-2001. MULTIPLE CLASS, INT. CLS. 35 AND 37.
- WERNER PUBLISHING CORPORATION, LOS ANGELES, CA:
2,535,060, INT. CL. 16.
- WEST SALEM MACHINERY COMPANY, SALEM, OR:
2,534,985, INT. CL. 7.
- WEST TEC. INDUSTRIES, INC., SALT LAKE CITY, UT:
1,142,299, CANC. INT. CL. 9.
- WEST, RICHARD E., TOPANGA, CA:
1,865,672, CANC. INT. CL. 9.
- WESTBROOK, GREG, CHANDLER, AZ:
2,534,178, PUB. 11-6-2001. INT. CL. 41.
- WESTELCOM COMMUNICATIONS, INC., WESTPORT, NY:
2,533,809, PUB. 11-6-2001. INT. CL. 42.
- WESTERN DRESSING, INC., GRUNDY CENTER, IA:
1,866,504, CANC. INT. CL. 29.
- WESTERN INTEGRATED NETWORKS, LLC, DENVER, CO:
2,534,866, INT. CL. 38.
2,534,867, INT. CL. 38.
2,534,868, INT. CL. 38.
2,534,869, INT. CL. 38.
- WESTERN OILFIELDS SUPPLY COMPANY, BAKERSFIELD, CA:
886,177. REN. 12-20-01. U.S. CL. 13 (INT. CLS. 6, 7, 11, 17, 20 AND 21).
- WESTERN UNION FINANCIAL SERVICES, INC., PARAMUS, NJ:
1,865,965, CANC. INT. CL. 36.
- WESTERN UNION HOLDINGS, INC., ENGLEWOOD, CO, I. C. SYSTEM, INC., VADNAIS HEIGHTS, MN:
1,677,844. REN. 12-19-01. INT. CL. 36.
- WESTGATE FURNITURE, INC., COLUMBUS, OH TO SOFA EXPRESS, INC., GROVEPORT, OH:
1,514,110, AM. INT. CL. 42.
- WESTPORT FINANCIAL LLC, WESTPORT, CT:
2,533,765, PUB. 11-6-2001. INT. CL. 36.
- WEYCO GROUP, INC., MILWAUKEE, WI:
2,534,522, INT. CL. 25.
- WGBH EDUCATIONAL FOUNDATION, BOSTON, MA:
2,533,957, PUB. 11-6-2001. INT. CL. 41.
2,534,469, MULTIPLE CLASS, INT. CLS. 9 AND 16.
2,534,742, INT. CL. 28.
- WHAM-O, INC., SAN FRANCISCO, CA, NATIONAL HACKY SACK CO., OREGON CITY, OR:
1,183,855. REN. 12-19-01. MULTIPLE CLASS, INT. CLS. 25, 28 AND 41.
- WHATABURGER, INC., CORPUS CHRISTI, TX:
2,534,527, INT. CL. 42.
- WHEAT FIRST SECURITIES, INC., RICHMOND, VA:
2,488,159, COR. INT. CL. 36.
- WHIRLPOOL PROPERTIES, INC., ST. JOSEPH, MI, WHIRLPOOL CORPORATION, BENTON HARBOR, MI:
713,434. REN. 12-20-01. U.S. CL. 21 (INT. CL. 7).
918,422. REN. 12-21-01. MULTIPLE CLASS, U.S. CLS. 21 (INT. CLS. 7 AND 9), 24 (INT. CL. 7), 31 (INT. CL. 11) AND 34 (INT. CL. 11).
- WHIRLPOOL PROPERTIES, INC., BENTON HARBOR, MI:
2,533,678, PUB. 11-6-2001. INT. CL. 21.
- WHITE CASTLE SYSTEM, INC., COLUMBUS, OH:
2,534,525, INT. CL. 42.
- WHITE CONSOLIDATED INDUSTRIES, INC., CLEVELAND, OH:
2,534,921, INT. CL. 7.
- WHITE, WILLIAM T., JR., ABBEVILLE, AL:
1,836,279, CANC. INT. CL. 28.
- WHITTIER WOOD PRODUCTS CO., EUGENE, OR:
1,865,804, CANC. INT. CL. 20.
- WHOLE FOODS MARKET SERVICES, INC., AUSTIN, TX:
2,534,810, MULTIPLE CLASS, INT. CLS. 29 AND 30.
- WIGWAM MILLS, INC., SHEBOYGAN, WI:
1,190,773. REN. 12-21-01. INT. CL. 25.
- WILCOR INTERNATIONAL, INC., NAPLES, FL:
2,534,424, MULTIPLE CLASS, INT. CLS. 35 AND 41.
- WILDBRAIN.COM, INC., SAN FRANCISCO, CA:
2,533,414, PUB. 11-6-2001. INT. CL. 41.
- WILES, SCOTT, INCLINE VILLAGE, NV:
2,534,964, INT. CL. 30.
- WILLIAM MARSH RICE UNIVERSITY, HOUSTON, TX:
2,534,138, PUB. 11-6-2001. INT. CL. 28.
- WILLIAM PHILLIP ASSOCIATES LTD., WYNNEWOOD, PA:
1,866,038, CANC. INT. CL. 41.
- WILLIAMS, MARK THOMAS, VALENCIA, CA:
2,533,713, PUB. 11-6-2001. INT. CL. 42.
- WILLIFORD, LAWRENCE RICHARD, YORBA LINDA, CA:
2,534,520, INT. CL. 25.
- WILLIS MARKETING, GIG HARBOR, WA, DBA KAFE FOODS, INC.:
2,534,081, PUB. 11-6-2001. INT. CL. 30.
- WILSON SPORTING GOODS CO., CHICAGO, IL:
1,866,496, CANC. INT. CL. 28.
- WILSON, COLLEEN G., SAN DIEGO, CA:
2,534,914, INT. CL. 5.
2,534,915, INT. CL. 5.
- WILSON, RAVINELL, BIRMINGHAM, AL:
2,533,242, PUB. 11-6-2001. INT. CL. 35.
- WILSON'S GUN SHOP, INC., BERRYVILLE, AR, DBA WILSON COMBAT, WILSON, BILLY JAMES, BERRYVILLE, AR, DBA WILSON'S GUN SHOP, INC.:
1,674,154. REN. 12-17-01. INT. CL. 13.
- WILTON COMPANY, THE, COLUMBIA, PA:
1,142,599, CANC. INT. CL. 20.
1,142,607, CANC. INT. CL. 21.
1,142,819, CANC. INT. CL. 34.
- WIMEX, INC, PHILADELPHIA, PA:
1,865,543, CANC. MULTIPLE CLASS, INT. CLS. 5 AND 10.
- WINDMERE CORPORATION, MIAMI LAKES, FL:
1,866,143, CANC. MULTIPLE CLASS, INT. CLS. 7 AND 11.
- WINDSOR ACQUISITION LLC, MILAN, TN FROM KAPMAN AB, S-811 81 SANDVIKEN, SWEDEN:
2,534,630, INT. CL. 7.
- WINE INDUSTRY SYMPOSIUM GROUP LLC, NAPA, CA:
2,533,944, PUB. 11-6-2001. INT. CL. 35.
- WING ON INTERNATIONAL HOLDINGS LIMITED, HAMILTON HM12, BERMUDA:
2,533,484, PUB. 11-6-2001. INT. CL. 35.
- WIREMOLD COMPANY, THE, WEST HARTFORD, CT, BUTLER MANUFACTURING COMPANY, KANSAS CITY, MO:
1,661,513. REN. 12-17-01. INT. CL. 9.
- WIREMOLD COMPANY, THE, WEST HARTFORD, CT:
1,661,519. REN. 12-21-01. INT. CL. 9.
- WISE GUYS, INC., COLUMBIA, MO:
2,533,508, PUB. 11-6-2001. INT. CL. 42.
- WITCO CORPORATION, NEW YORK, NY:
1,625,567, CANC. INT. CL. 4.
- WITN-TV, INC., WASHINGTON, NC:
1,865,765, CANC. INT. CL. 16.
- WIZ, INC., THE, CARTERET, NJ:
1,866,099, CANC. INT. CL. 42.
- WJL, INC., FORT LEE, NJ:
1,866,354, CANC. INT. CL. 16.
- WKI HOLDING COMPANY, INC., ELMIRA, NY:
2,534,193, PUB. 11-6-2001. INT. CL. 21.
- WM. F. RENK & SONS CO., INC., SUN PRAIRIE, WI:
1,659,981. REN. 12-19-01. INT. CL. 31.

WMS GAMING INC., CHICAGO, IL:
2,534,857, INT. CL. 9.

WNBA ENTERPRISES, LLC, SECAUCUS, NJ:
2,534,215, PUB. 11-6-2001. INT. CL. 35.

WNS, INC., HOUSTON, TX:
1,142,191, CANC. INT. CL. 4.

WOLF, DONALD G., SALINAS, CA, DBA THE STEINBECK
COUNTRY GENERAL STORE:
1,142,479, CANC. MULTIPLE CLASS, INT. CLS. 16 AND
41.

WOMAN'S WAY, INC., SILVER SPRING, MD:
1,866,034, CANC. INT. CL. 41.

WONDERCLICK.COM, INC., WASHINGTON, DC FROM
ABOVECABLE.COM, INC., WASHINGTON, DC:
2,534,692, INT. CL. 35.

WONG, HILDA CHOY, LOS ALTOS HILLS, CA:
1,866,395, CANC. INT. CL. 21.

WOODALL PUBLICATIONS CORPORATION, VENTURA,
CA, WOODALL PUBLISHING COMPANY, CHICAGO, IL:
711,273, REN. 12-19-01. U.S. CL. 38 (INT. CL. 16).

WOODEN THUMB INCORPORATED, OAK CREEK, WI:
1,865,981, CANC. INT. CL. 37.

WOODHEAD INDUSTRIES, INC., DEERFIELD, IL, DANIEL
WOODHEAD COMPANY, CHICAGO, IL:
550,729, REN. 12-20-01. U.S. CL. 21 (INT. CL. 17).

WOODY DEVELOPMENT CORPORATION, TAMPA, FL:
2,533,449, PUB. 11-6-2001. INT. CL. 42.

WOOJIN MACHINERY CO., LTD., NEWPORT BEACH, CA:
2,533,680, PUB. 11-6-2001. INT. CL. 7.

WORLD ART SERVICES, INC., TULSA, OK:
1,142,822, CANC. MULTIPLE CLASS, INT. CLS. 35 AND
42.

WORLD CHAMPIONSHIP WRESTLING, INC., ATLANTA,
GA:
2,533,208, PUB. 11-6-2001. INT. CL. 9.

WORLD COMMERCE ONLINE, INC., ORLANDO, FL:
2,535,058, INT. CL. 35.

WORLD NETWORK TRADING CORPORATION, ROCK-
VILLE, MD:
1,866,373, CANC. INT. CL. 18.

WOW TRANSPORT, INC., EVANS, GA:
2,533,739, PUB. 11-6-2001. INT. CL. 39.

WRIGHT CHEMICAL CORPORATION, WILMINGTON, NC:
2,533,583, PUB. 11-6-2001. INT. CL. 2.

W3 MARKETING CORP., MIAMI, FL:
1,866,166, CANC. INT. CL. 3.

X-I-M PRODUCTS, INC., WESTLAKE, OH, X-I-M PRO-
DUCTS, INC., WESTLAKE, OH:
1,135,973, REN. 12-18-01. INT. CL. 2.

XENAS COMMUNICATIONS CORPORATION, CINCINNA-
TI, OH:
1,865,586, CANC. INT. CL. 9.

XEROX CORPORATION, STAMFORD, CT:
1,658,883, REN. 12-15-01. INT. CL. 9.
1,658,885, REN. 12-15-01. INT. CL. 9.
1,658,886, REN. 12-15-01. INT. CL. 9.
1,658,899, REN. 12-15-01. INT. CL. 9.
1,658,900, REN. 12-15-01. INT. CL. 9.

XERXES COMPUTER CORPORATION, MINNETONKA,
MN:
1,625,933, CANC. INT. CL. 16.

XIAMEN TEA IMP. & EXP. CO., LTD., XIAMEN, CHINA,
CHINA NATIONAL NATIVE PRODUCE AND ANIMAL-
BY-PRODUCTS IMPORT AND EXPORT CORPORATION,
PEKING, CHINA:
1,172,478, REN. 12-15-01. INT. CL. 30.

XTENIT, INC., NEW YORK, NY:
2,534,445, INT. CL. 42.

XTREME RIDERZ, ANAHEIM, CA:
2,533,861, PUB. 11-6-2001. INT. CL. 28.

XULU ENTERTAINMENT INC., SAN JOSE, CA:
2,534,397, MULTIPLE CLASS, INT. CLS. 35 AND 42.

YAEGAKI SHUZO KABUSHIKI KAISHA, HIMEJI, HYOGO,
JAPAN:
1,626,212, CANC. INT. CL. 33.

YAMAHA CORPORATION, SHIZUOKA, JAPAN, NIPPON
GAKKI SEIZO KABUSHIKI KAISHA, HAMAMATSU-SHI,
SHIZUOKA-KEN, JAPAN, AKA NIPPON GAKKI CO.,
LTD.:
1,170,106, REN. 12-19-01. MULTIPLE CLASS, INT. CLS.
15, 18 AND 25.

YAMAHA CORPORATION, HAMAMATSU-SHI, SHIZUO-
KA-KEN, JAPAN:
1,661,643, REN. 12-19-01. INT. CL. 15.

YAMAHA HATSUDOKI KABUSHIKI KAISHA, 2500 SHIN-
GAI, IWATA-SHI, SHIZUOKA-KEN, JAPAN:
1,670,174, REN. 12-20-01. INT. CL. 12.

YAMATO-SHOKAI, INC., MIAMI, FL, NIKKO HEAVY
INDUSTRIES, INC., MIAMI, FL:
1,659,442, REN. 12-20-01. INT. CL. 7.

YOGA WORLD, INC., COSTA MESA, CA, DBA AGE IN
REVERSE:
2,534,428, INT. CL. 28.

YOHAY BAKING COMPANY INC., BROOKLYN, NY:
2,534,053, PUB. 11-6-2001. INT. CL. 30.

YOUNG LIFE, COLORADO SPRINGS, CO:
2,534,607, INT. CL. 16.

YOUR PIZZA SHOP, INC., CANTON, OH:
1,142,989, CANC. INT. CL. 42.

YZ ENTERPRISES, INC., MAUMEE, OH:
2,533,197, PUB. 11-6-2001. INT. CL. 30.

Z/I IMAGING CORPORATION, HUNTSVILLE, AL:
2,533,575, PUB. 11-6-2001. INT. CL. 9.

ZAP DEVELOPMENT CORPORATION, LITTLE ROCK, AR:
1,866,233, CANC. INT. CL. 9.

ZEAGER BROTHERS, INC., MIDDLETOWN, PA:
2,533,671, PUB. 11-6-2001. INT. CL. 31.

ZENECA LIMITED, LONDON, ENGLAND:
2,533,360, PUB. 11-6-2001. INT. CL. 5.

ZENITECH LLC, DACULA, GA:
2,534,047, PUB. 11-6-2001. INT. CL. 4.

ZENITH GOLDLINE PHARMACEUTICALS, INC., MIAMI,
FL:
2,533,385, PUB. 11-6-2001. INT. CL. 5.

ZEWA, INC., MIAMI, FL:
2,533,859, PUB. 11-6-2001. INT. CL. 10.

ZIGOR, S.A., VITORIA (ALAVA), SPAIN:
1,661,490, REN. 12-17-01. MULTIPLE CLASS, INT. CLS. 9,
11 AND 13.

ZOOMERS, INC., BROOKLYN, NY:
2,534,493, INT. CL. 25.

ZORN'S POULTRY FARMS, INC., BETHPAGE, NY:
1,866,053, CANC. INT. CL. 42.

ZUTANO, INC., CABOT, VT:
2,534,850, INT. CL. 28.

01 INC, NEW YORK, NY:
2,535,103, INT. CL. 35.

1GLOBALCITY.COM, INC., LARGO, FL:
2,535,029, INT. CL. 9.

100 BLACK MEN OF ATLANTA, INC., ATLANTA, GA:
1,865,976, CANC. INT. CL. 36.

110 LIMITED, LONDON WC2N 5NJ, UNITED KINGDOM:
2,534,257, PUB. 11-6-2001. INT. CL. 9.

1615 - LLL, LIMITED PARTNERSHIP, WASHINGTON, DC:
2,533,837, PUB. 11-6-2001. INT. CL. 42.

3D LEARNER, INC., CORAL SPRINGS, FL:
2,534,990, MULTIPLE CLASS, INT. CLS. 41 AND 42.

638755 ONTARIO INC., O/A RED LINE PRODUCTS, SEA-
FORTH, ONTARIO, CANADA:
1,625,990, CANC. INT. CL. 19.

671 WASHINGTON AVENUE CORP., MIAMI BEACH, FL:
2,533,431, PUB. 11-6-2001. INT. CL. 42.