

MARKS PUBLISHED FOR OPPOSITION

The following marks are published in compliance with section 12(a) of the Trademark Act of 1946. Applications for the registration of marks in more than one class have been filed as provided in section 30 of said act as amended by Public Law 772, 87th Congress, approved Oct. 9, 1962, 76 Stat. 769. Opposition under section 13 may be filed within thirty days of the date of this publication. See rules 2.101 to 2.105.

A separate fee of two hundred dollars for opposing each mark in each class must accompany the opposition.

SECTION 1.— INTERNATIONAL CLASSIFICATION

The short titles associated below with the international class numbers are terms designed merely for quick identification and are not an official part of the international classification. The full names of international classes are given in section 6.1 of the trademark rules of practice.

The designation "U.S. Cl." appearing in this section refers to the U.S. class in effect prior to Sep. 1, 1973 rather than the international class which applies to applications filed on or after that date. For adoption of international classification see notice in the OFFICIAL GAZETTE of Jun. 26, 1973 (911 O.G. TM 210).

Application in more than one class

SN 74-556,553. SEENERGY FOODS INC., WOODBRIDGE, ONTARIO, CANADA, FILED 8-2-1994.



CLASS 30—STAPLE FOODS

FOR PASTA, PASTA SAUCES, RICE, PROCESSED GRAINS, NAMELY WHEAT, RYE, BARLEY AND COUS-COUS, PREPARED MEALS AND ENTREES CONSISTING PRIMARILY OF PASTA, VEGETARIAN BURGER SANDWICHES, PIZZA, CHOCOLATES, ICE CREAM, CUSTARDS, PUDDINGS, PROCESSED OR BREAKFAST CEREALS, SALAD DRESSINGS; SAUCES, SEASONINGS, GRAVIES, YEAST, MUSTARD, PEPPER, VINEGAR, CHOCOLATE SYRUP, CORN SYRUP, FLAVORING SYRUP, MAPLE SYRUP, PANCAKE SYRUP, TABLE SYRUP AND TOPPING SYRUP, PROCESSED HERBS, SPICES; BISCUITS, CAKES, PASTRIES, BREADS, BUNS, ROLLS, AND COOKIES; CORN CHIPS, TEAS, COFFEES, AND HERBAL FOOD BEVERAGE MIXES (U.S. CL. 46).

CLASS 31—NATURAL AGRICULTURAL PRODUCTS

FOR UNPROCESSED GRAINS AND CEREALS; FRESH FRUITS AND VEGETABLES; RAW BEANS; LIVE OYSTERS (U.S. CLS. 1 AND 46).

PRIORITY CLAIMED UNDER SEC. 44(D) ON CANADA APPLICATION NO. 750255, FILED 3-22-1994, REG. NO. TMA510200, DATED 3-29-1999, EXPIRES 3-29-2014.

NO CLAIM IS MADE TO THE EXCLUSIVE RIGHT TO USE "FOODS INC.", APART FROM THE MARK AS SHOWN.

CLASS 29—MEATS AND PROCESSED FOODS

FOR VEGETABLE BASED MEAT SUBSTITUTES, PREPARED VEGETARIAN MEALS AND ENTREES CONSISTING PRIMARILY OF PROCESSED VEGETABLES, VEGETARIAN BURGER PATTIES, SOUPS, SOUP MIXES, EDIBLE OILS, YOGURT, FROZEN AND CANNED FRUITS AND VEGETABLES; LENTILS, DRIED BEANS, NAMELY BLACK BEANS, GREEN BEANS, YELLOW BEANS AND FAVA BEANS, JELLIES, JAMS, PICKLES, PROCESSED NUTS, PROCESSED EDIBLE SEEDS, FRIED FAVA BEANS; SEAFOOD PRODUCTS, NAMELY PROCESSED OYSTERS, CLAMS, MUSSELS, SCALLOPS, SALMON; POTATO WEDGES, HOME FRIES, HASH BROWN PATTIES, PROCESSED POTATOES, PROCESSED BABY ROAST POTATOES, POTATO PUFFS (U.S. CL. 46).

CLASS 40—MATERIAL TREATMENT

FOR MANUFACTURE OF GENERAL PRODUCT LINES IN THE FIELD OF FOOD PRODUCTS AND BEVERAGES TO THE ORDER AND SPECIFICATION OF OTHERS (U.S. CLS. 100, 103 AND 106).

SN 75-367,068. TSI HOLDINGS (IP), INC., NEW YORK, NY. BY ASSIGNMENT TOWN SPORTS INTERNATIONAL, INC., NEW YORK, NY. FILED 10-2-1997.



NO CLAIM IS MADE TO THE EXCLUSIVE RIGHT TO USE "SPORTS CLUBS" (CL 41), APART FROM THE MARK AS SHOWN.

SEC. 2(F) AS TO "WASHINGTON".

CLASS 25—CLOTHING

FOR CLOTHING, NAMELY, T-SHIRTS, TANK TOPS, SWEATSHIRTS AND HATS (U.S. CLS. 22 AND 39). FIRST USE 4-1-1996; IN COMMERCE 4-1-1996.

CLASS 41—EDUCATION AND ENTERTAINMENT

FOR PROVISION OF HEALTH, FITNESS, RACQUET AND ATHLETIC CLUB SERVICES (U.S. CLS. 100, 101 AND 107).

FIRST USE 11-30-1990; IN COMMERCE 11-30-1990.

SN 75-384,711. EMANUEL UNGARO, PARIS, FRANCE, FILED 11-4-1997.

EMANUEL
EMANUEL UNGARO

OWNER OF U.S. REG. NOS. 1,258,303 AND 1,736,424. THE NAME "EMANUEL UNGARO" IDENTIFIES A LIVING INDIVIDUAL WHOSE CONSENT IS OF RECORD.

CLASS 14—JEWELRY

FOR JEWELRY; COSTUME JEWELRY; WATCHES; CLOCKS AND WATCH BANDS (U.S. CLS. 2, 27, 28 AND 50).

CLASS 18—LEATHER GOODS

FOR TOTE BAGS; HANDBAGS; SHOULDER BAGS; CLUTCH BAGS; COSMETIC BAGS SOLD EMPTY; ATTACHE CASES; BRIEFCASES; PURSES; WALLETS; KEY CASES; BUSINESS AND CREDIT CARD CASES; TRUNKS; SUITCASES; TRAVELLING BAGS; RUCKSACKS; AND UMBRELLAS (U.S. CLS. 1, 2, 3, 22 AND 41).

SN 75-385,181. BIG CITY RADIO, INC., HAWTHORNE, NY. BY CHANGE OF NAME ODYSSEY COMMUNICATIONS, HAWTHORNE, NY. FILED 11-5-1997.

Y-107 ROADSHOW

NO CLAIM IS MADE TO THE EXCLUSIVE RIGHT TO USE "ROADSHOW", APART FROM THE MARK AS SHOWN.

CLASS 38—COMMUNICATION

FOR RADIO BROADCASTING SERVICES (U.S. CLS. 100, 101 AND 104).

FIRST USE 3-12-1997; IN COMMERCE 3-12-1997.

CLASS 41—EDUCATION AND ENTERTAINMENT

FOR ENTERTAINMENT SERVICES IN THE NATURE OF PERSONAL APPEARANCES BY RADIO PERSONALITIES (U.S. CLS. 100, 101 AND 107).

FIRST USE 3-12-1997; IN COMMERCE 3-12-1997.

SN 75-438,438. BUILD-A-BEAR WORKSHOP, L.L.C., ST. LOUIS, MO. FILED 2-23-1998.

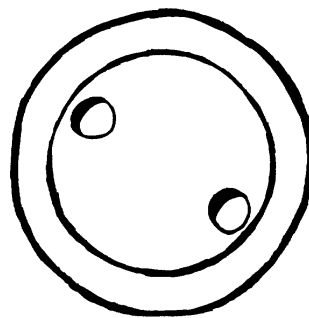

THE MARK COMPRISES THE DESIGN OF A CLOTHING BUTTON.

CLASS 28—TOYS AND SPORTING GOODS

FOR PLUSH TOY ANIMALS AND STUFFED TOY ANIMALS AND ACCESSORIES THEREFOR (U.S. CLS. 22, 23, 38 AND 50).

FIRST USE 10-26-1997; IN COMMERCE 10-26-1997.

CLASS 35—ADVERTISING AND BUSINESS

FOR RETAIL STORE SERVICES IN THE FIELDS OF STUFFED TOY ANIMALS AND PLUSH TOY ANIMALS AND ACCESSORIES THEREFOR, CD ROMS AND AUDIO CASSETTES RELATING TO OR REGARDING TEDDY BEARS AND OTHER STUFFED TOY ANIMALS AND PLUSH TOY ANIMALS AND CANDIES (U.S. CLS. 100, 101 AND 102).

FIRST USE 10-26-1997; IN COMMERCE 10-26-1997.

SN 75-454,335. X122 COMPANY (UK) LIMITED, BRISTOL, ENGLAND, FILED 3-20-1998.



PRIORITY CLAIMED UNDER SEC. 44(D) ON UNITED KINGDOM APPLICATION NO. 000639856, FILED 9-22-1997, REG. NO. 000639856, DATED 3-26-1999, EXPIRES 9-22-2007.

THE LINING SHOWN IN THE DRAWING IS A FEATURE OF THE MARK IS NOT INTENDED TO INDICATE COLOR. THE STIPPLING SHOWN IN THE DRAWING IS A FEATURE OF THE MARK AND IS NOT INTENDED TO INDICATE COLOR.

CLASS 9—ELECTRICAL AND SCIENTIFIC APPARATUS

FOR COMPUTER PROGRAMS AND SOFTWARE USED FOR THE ESTABLISHMENT, MANAGEMENT, AND CONTROL OF TELECOMMUNICATIONS SERVICES AND FOR THE TRANSMISSION OF TELEPHONY, VIDEO AND DATA, FOR USE IN COMMERCIAL, RESIDENTIAL, GOVERNMENT, ACADEMIC AND SCIENTIFIC ENVIRONMENTS; BLANK COMPUTER MAGNETIC AND OPTICAL DATA CARRIER DISC AND TAPES; COMPUTER APPARATUS AND INSTRUMENTS, NAMELY, MICROPROCESSORS, ELECTRIC LUMINESCENT DISPLAY PANELS; COMPUTER HARDWARE, NAMELY STORAGE UNITS FOR DATA STORAGE AND RETRIEVAL; AND TRANSMISSION FACILITIES, NAMELY, TELECOMMUNICATIONS SERVICE PROVIDER ACCESS AND BACKBONE NETWORKS, ALL RELATING TO TELECOMMUNICATIONS AND DATA COMMUNICATIONS (U.S. CLS. 21, 23, 26, 36 AND 38).

CLASS 16—PAPER GOODS AND PRINTED MATTER

FOR COMPUTER PROGRAMS IN PRINTED FORM USED FOR THE ESTABLISHMENT, MANAGEMENT, AND CONTROL OF TELECOMMUNICATIONS SERVICES AND FOR THE TRANSMISSION OF TELEPHONY, VIDEO AND DATA; PRINTED USER MANUALS FOR THE INSTALLATION, OPERATION AND MAINTENANCE OF TELECOMMUNICATIONS AND DATA COMMUNICATIONS PRODUCTS, SYSTEMS, AND COMPONENTS; PRINTED INSTRUCTION MATERIALS, NAMELY, BROCHURES, MANUALS AND TRAINING COURSE PUBLICATIONS FOR USE IN THE FIELDS OF TELECOMMUNICATIONS AND DATA COMMUNICATIONS; PRINTED FLOWCHARTS AND GUIDES FOR INSTRUCTION IN THE FIELDS OF TELECOMMUNICATIONS AND DATA COMMUNICATIONS; PRINTED MATTER, NAMELY, BOOKS, ESSAYS, AND TECHNICAL PAPERS IN THE FIELDS OF TELECOMMUNICATIONS AND DATA COMMUNICATIONS; AND PERIODICAL PUBLICATIONS RELATING TO TELECOMMUNICATIONS AND DATA COMMUNICATIONS (U.S. CLS. 2, 5, 22, 23, 29, 37, 38 AND 50).

CLASS 35—ADVERTISING AND BUSINESS

FOR BUSINESS MANAGEMENT SERVICES IN THE NATURE OF TELECOMMUNICATION AND DATA COMMUNICATION SUBSCRIBER MANAGEMENT SERVICES, NAMELY, PROVISIONING, CONTROLLING, MONITORING, BILLING AND MANAGING THE DELIVERY OF TELEPHONE AND DATA COMMUNICATION SERVICES (U.S. CLS. 100, 101 AND 102).

CLASS 38—COMMUNICATION

FOR COMMUNICATIONS AND TELECOMMUNICATIONS SERVICES, NAMELY, ELECTRONIC TRANSMISSION OF MESSAGES AND DATA; PROVIDING MULTIPLE USER ACCESS TO THE INTERNET; AND SWITCHING SERVICES FOR THE ELECTRONIC AND OPTICAL TRANSMISSION OF VOICE DATA AND VIDEO; PROVIDING TELECOMMUNICATION SERVICES FOR THE COLLECTION, TRANSMISSION AND DISTRIBUTION OF TELECOMMUNICATIONS SIGNALS; PROVISION OF NETWORK INTERFACE SERVICES, NAMELY, BASIC, PRIMARY, SUB-RATE, AND MULTIRATE CHANNEL SERVICES TO ALLOW THE ESTABLISHMENT, TERMINATION AND MANAGEMENT OF TELECOMMUNICATIONS SERVICES (U.S. CLS. 100, 101 AND 104).

SN 75-493,226. DANIELI & C. OFFICINE MECCANICHE SPA, 33042 BUTTRIO, ITALY, FILED 5-29-1998.

EIM

PRIORITY CLAIMED UNDER SEC. 44(D) ON ERPNCMNTY TM OFC APPLICATION NO. 736546, FILED 2-2-1998, REG. NO. 000736546, DATED 5-2-2001, EXPIRES 2-2-2008.

CLASS 7—MACHINERY

FOR MACHINES, MACHINES MOTORS, MACHINE ENGINES AND MACHINE PARTS THEREFOR, NAMELY, MACHINES AND PARTS THEREFOR FOR THE PRODUCTION AND ROLLING OF METAL PRODUCTS IN THE NATURE OF NOZZLES, OSCILLATING ASSEMBLIES, EXTRACTOR ASSEMBLIES, SHEARS, STRAIGHTENERS, ROLLING BOXES FOR ROLLING, ROLLING MILLS, ROLLING STANDS, COOLING BEDS AND DESCALERS (U.S. CLS. 13, 19, 21, 23, 31, 34 AND 35).

CLASS 9—ELECTRICAL AND SCIENTIFIC APPARATUS

FOR ELECTRONIC USED IN THE PRODUCTION AND ROLLING OF METAL PRODUCTS, NAMELY, ELECTRIC COMMAND PANELS, ADJUSTMENT AND CONTROL SWITCHES AND CONTROL FOR ELECTRIC MOTORS AND GENERATORS, RELAY PANELS FOR AUTOMATION, ELECTRICAL AND ELECTRONIC DIAGRAMS, PROCESS PROGRAMMING AND CONTROL UNITS, ELECTRONIC MEASURING MECHANISMS TO MEASURE AND INDICATE PHYSICAL AND CHEMICAL PROPERTIES (U.S. CLS. 21, 23, 26, 36 AND 38).

CLASS 11—ENVIRONMENTAL CONTROL APPARATUS

FOR APPARATUS USED IN PRODUCTION AND ROLLING OF METAL PRODUCTS, NAMELY, MINERAL TREATMENT PLANTS COMPRISED OF A REACTOR AND FURNACE, MINERAL REDUCTION PLANTS COMPRISED OF A REACTOR AND FURNACE, RECTANGULAR SHAPED TROUGHS USED IN THE PROCESS OF TEEMING STEEL ALSO KNOWN AS TUNDISHES, INGOT MOLDS, HEATING INDUCTION FURNACES AND HEATING FURNACES, RETORTS, HEAT EXCHANGERS, AND FUME AND GAS PURIFIERS USED IN THE PRODUCTION OF METAL PRODUCTS, ALL OF WHICH ARE USED FOR THE TREATMENT AND MELTING OF METALS (U.S. CLS. 13, 21, 23, 31 AND 34).

SN 75-496,748. AMB PROPERTY CORPORATION, SAN FRANCISCO, CA. FILED 6-5-1998.

SN 75-532,031. ARES TRADING S.A., 2028 VAUMARCUS, SWITZERLAND, FILED 8-6-1998.

STRATEGIC ALLIANCE PARTNERS

NO CLAIM IS MADE TO THE EXCLUSIVE RIGHT TO USE "PARTNERS", APART FROM THE MARK AS SHOWN.

CLASS 36—INSURANCE AND FINANCIAL

FOR REAL ESTATE BROKERAGE SERVICES THROUGH INDEPENDENT THIRD-PARTY REAL ESTATE BROKERS; REAL ESTATE MANAGEMENT SERVICES THROUGH INDEPENDENT THIRD-PARTY REAL ESTATE MANAGEMENT COMPANIES; REAL ESTATE LEASING SERVICES TO TENANTS THROUGH INDEPENDENT THIRD-PARTY REAL LEASING AGENTS (U.S. CLS. 100, 101 AND 102).

FIRST USE 6-30-1998; IN COMMERCE 6-30-1998.

CLASS 37—CONSTRUCTION AND REPAIR

FOR REAL ESTATE DEVELOPMENT SERVICES THROUGH INDEPENDENT THIRD-PARTY REAL ESTATE DEVELOPERS (U.S. CLS. 100, 103 AND 106).

FIRST USE 6-30-1998; IN COMMERCE 6-30-1998.

SN 75-528,234. ASTIER DE VILLATTE, 75012 PARIS, FRANCE, FILED 7-30-1998.

ASTIER DE VILLATTE



OWNER OF FRANCE REG. NO. 97/694247, DATED 9-9-1997, EXPIRES 9-9-2007.

CLASS 11—ENVIRONMENTAL CONTROL APPARATUS

FOR CHANDELIERS (U.S. CLS. 13, 21, 23, 31 AND 34).

CLASS 20—FURNITURE AND ARTICLES NOT OTHERWISE CLASSIFIED

FOR WOOD FURNITURE, NAMELY, CHAIRS, TABLES, HEADBOARDS FOR BEDS, BASES OF LAMPS, FLOWER POT PEDESTALS AND PICTURE FRAMES (U.S. CLS. 2, 13, 22, 25, 32 AND 50).

CLASS 21—HOUSEWARES AND GLASS

FOR CERAMIC, TERRA COTTA, AND GLASS DISHES, PLATES, CUPS, FLOWER POTS, VASES, JUGS AND PITCHERS (U.S. CLS. 2, 13, 23, 29, 30, 33, 40 AND 50).



SERONO SYMPOSIA

NO CLAIM IS MADE TO THE EXCLUSIVE RIGHT TO USE "SYMPOSIA", APART FROM THE MARK AS SHOWN.

CLASS 16—PAPER GOODS AND PRINTED MATTER

FOR SCIENTIFIC PUBLICATIONS IN THE FIELDS OF REPRODUCTIVE MEDICINE, GENERAL ENDOCRINOLOGY, NEUROLOGY, IMMUNOLOGY AND ONCOLOGY (U.S. CLS. 2, 5, 22, 23, 29, 37, 38 AND 50).

CLASS 36—INSURANCE AND FINANCIAL

FOR PROVIDING EDUCATIONAL GRANTS, FELLOWSHIPS AND SCIENTIFIC AWARDS IN THE FIELDS OF SCIENCE AND MEDICINE (U.S. CLS. 100, 101 AND 102).

CLASS 41—EDUCATION AND ENTERTAINMENT

FOR EDUCATIONAL SERVICES, NAMELY, CONDUCTING SYMPOSIA COURSES, LECTURESHIPS, WORKSHOPS, EMPOWERMENT PROGRAMS AND TRAINING IN THE FIELDS OF MEDICAL AND SCIENTIFIC EDUCATIONAL, HEALTH PROFESSIONAL EDUCATION AND CONSUMER EDUCATION (U.S. CLS. 100, 101 AND 107).

SN 75-547,362. PRECISION BEEF ALLIANCE, LEWIS, IA. FILED 9-3-1998.



NO CLAIM IS MADE TO THE EXCLUSIVE RIGHT TO USE "BEEF ALLIANCE", APART FROM THE MARK AS SHOWN.

CLASS 35—ADVERTISING AND BUSINESS

FOR COMPUTERIZED DATABASE MANAGEMENT FOR THE PRODUCERS OF BEEF CATTLE, AND CO-OPERATIVE ADVERTISING OR MARKETING RENDERED TO BEEF CATTLE PRODUCTS (U.S. CLS. 100, 101 AND 102).

FIRST USE 7-0-1995; IN COMMERCE 7-0-1995.

CLASS 42—SCIENTIFIC, COMPUTER AND LEGAL SERVICES

FOR ASSOCIATION SERVICES, NAMELY PROMOTING THE INTERESTS OF BEEF CATTLE PRODUCERS; AND AGRICULTURAL ADVISE RENDERED TO BEEF CATTLE PRODUCERS (U.S. CLS. 100 AND 101).
FIRST USE 7-0-1995; IN COMMERCE 7-0-1995.

SN 75-548,066. J&H MARSH & MCLENNAN LIMITED, LONDON EC3P 3BE, ENGLAND, FILED 9-4-1998.

**J&H MARSH & MCLENNAN
SMART**

OWNER OF UNITED KINGDOM REG. NO. 240398, DATED 3-7-1980, RENEWED AS REG. NO. 240398, DATED 3-7-1995, EXPIRES 3-7-2010.

NO CLAIM IS MADE TO THE EXCLUSIVE RIGHT TO USE "SMART", APART FROM THE MARK AS SHOWN.

CLASS 9—ELECTRICAL AND SCIENTIFIC APPARATUS

FOR COMPUTER PROGRAMS FOR USE IN RISK MANAGEMENT ANALYSIS FOR INSURANCE PURPOSES (U.S. CLS. 21, 23, 26, 36 AND 38).

CLASS 36—INSURANCE AND FINANCIAL

FOR RISK MANAGEMENT AND INSURANCE CONSULTATION, NAMELY, THE ASSESSMENT AND ANALYSIS OF RISK COVERAGE AND RISK PROFILING (U.S. CLS. 100, 101 AND 102).

SN 75-549,333. FOX ENTERPRISES, INC., DBA FOX ELECTRONICS, FORT MYERS, FL. FILED 9-8-1998.

**JUST-IN-TIME
OSCILLATORS**

NO CLAIM IS MADE TO THE EXCLUSIVE RIGHT TO USE "OSCILLATORS", APART FROM THE MARK AS SHOWN.

CLASS 9—ELECTRICAL AND SCIENTIFIC APPARATUS

FOR ELECTRONIC COMPONENTS AND PASSIVE ELECTRONIC COMPONENTS, NAMELY, QUARTZ CRYSTALS, MICROPROCESSOR CRYSTALS, CRYSTAL CLOCK OSCILLATORS, CRYSTAL FILTERS, CERAMIC RESONATORS, FREQUENCY CONTROL DEVICES USED WITH SUCH ELECTRONIC COMPONENTS AND COMPUTER CHIPS (U.S. CLS. 21, 23, 26, 36 AND 38).
FIRST USE 5-1-1997; IN COMMERCE 5-1-1997.

CLASS 39—TRANSPORTATION AND STORAGE

FOR EXPEDITED DELIVERY OF MICROPROCESSOR CRYSTALS, OSCILLATORS, AND CLOCK OSCILLATORS, COMPUTER CHIPS, OSCILLATORS, FREQUENCY CONTROL DEVICES, TEMPERATURE COMPENSATED CRYSTAL OSCILLATORS, VOLTAGE CONTROLLED CRYSTAL OSCILLATORS, AND OTHER ELECTRONIC PRODUCTS BY VARIOUS MEANS OF GROUND AND AIR TRANSPORT (U.S. CLS. 100 AND 105).

FIRST USE 5-1-1997; IN COMMERCE 5-1-1997.

CLASS 40—MATERIAL TREATMENT

FOR CUSTOM MANUFACTURE OF MICROPROCESSOR CRYSTALS, OSCILLATORS, AND CLOCK OSCILLATORS, COMPUTER CHIPS, OSCILLATORS, FREQUENCY CONTROL DEVICES, TEMPERATURE COMPENSATED CRYSTAL OSCILLATORS, AND VOLTAGE CONTROLLED CRYSTAL OSCILLATORS (U.S. CLS. 100, 103 AND 106).

FIRST USE 5-1-1997; IN COMMERCE 5-1-1997.

SN 75-556,505. SONY COMMUNICATIONS NETWORK KABUSHIKI KAISHA, TA SONY COMMUNICATION NETWORK CORPORATION, TOKYO, JAPAN, FILED 9-21-1998.

POSTPET

PRIORITY CLAIMED UNDER SEC. 44(D) ON UNITED KINGDOM APPLICATION NO. 782920, FILED 3-23-1998, REG. NO. 4458902, DATED 3-9-2001, EXPIRES 3-9-2011.

CLASS 9—ELECTRICAL AND SCIENTIFIC APPARATUS

FOR ANTENNAS; ARM RESTS FOR USE WITH COMPUTERS; AUDIO CASSETTE RECORDERS; AUDIO SPEAKERS; AUDIO TAPE RECORDERS; BATTERIES; BATTERY CHARGERS; BLANK MAGNETIC COMPUTER TAPES; CABINETS FOR LOUDSPEAKERS, CALCULATORS; CAMERA CASES; CAMERA FILTERS; 35MM CAMERAS ; COMPACT DISC PLAYERS FOR MUSIC; COMPUTER CABLES; COMPUTER CARRYING CASES; COMPUTER DISC DRIVES; COMPUTER FAX MODEM CARDS; COMPUTER GAME CARTRIDGES; COMPUTER GAME CASSETTES; COMPUTER GAME DISCS; COMPUTER GAME EQUIPMENT CONTAINING MEMORY DEVICES NAMELY, CD-ROM; COMPUTER GAME JOYSTICKS; COMPUTER GAME SOFTWARE; COMPUTER MEMORIES; COMPUTER MOUSE; COMPUTER UTILITY PROGRAMS; COMPUTERS; DIGITAL AUDIO TAPE PLAYERS; EYEGLASS CASES; EYEGLASS CHAINS; EYEGLASS FRAMES; EYEGLASSES; HEADPHONES; HOLDERS FOR COMPACT DISCS; INTERACTIVE MULTIMEDIA COMPUTER GAME PROGRAM; INTERACTIVE VIDEO GAME PROGRAMS; INTERACTIVE VIDEO GAMES OF VIRTUAL REALITY COMPRISED OF COMPUTER HARDWARE AND SOFTWARE; JACKETS FOR COMPUTER DISKS; JACKETS FOR VIDEO CASSETTES; JOYSTICKS FOR VIDEO GAMES; KEYBOARDS FOR COMPUTER; LASER POINTERS; LOUDSPEAKERS; MODEMS; MOUSE PADS AS A COMPUTER PERIPHERAL; PRE-PAID TELEPHONE CALLING CARDS, MAGNETICALLY ENCODED; RADIOS; SUNGLASSES; TELEPHONES; TELEVISION ANTENNAS; VIDEO GAME CARTRIDGES; VIDEO GAME DISCS; VIDEO GAME INTERACTIVE CONTROL FLOOR PADS OR MATS; VIDEO GAME INTERACTIVE REMOTE CONTROL UNITS; VIDEO GAME JOYSTICKS; VIDEO GAME MACHINES FOR USE WITH TELEVISIONS; VIDEO GAME SOFTWARE; VIRTUAL REALITY GAME SOFTWARE; COMPUTER FURNITURE (U.S. CLS. 21, 23, 26, 36 AND 38).

CLASS 14—JEWELRY

FOR ALARM CLOCKS; ANKLE BRACELETS; BELT BUCKLES OF PRECIOUS METAL FOR CLOTHING; BRACELETS OF PRECIOUS METAL; BROOCHES; BUCKLES OF PRECIOUS METAL FOR CLOTHING; PAPER EMBLEMS; CHARMS; CHRONOGRAPHS FOR USE AS WATCHES; CHRONOMETERS; CIGARETTE CASES MADE OF PRECIOUS METAL; CLOCKS; COSTUME JEWELRY; CUFF-LINKS; EAR CLIPS; EARRINGS; HAT ORNAMENTS OF PRECIOUS METAL; HAT PINS OF PRECIOUS METAL; JEWELRY CASES OF PRECIOUS METAL; JEWELRY PINS FOR USE ON HATS; JEWELRY; NAPKIN RINGS OF PRECIOUS METAL; NECKLACES; NECKTIE FASTENERS; PENDANTS; PINS BEING JEWELRY; POCKET WATCHES; RINGS BEING JEWELRY; SERVIETTE RINGS OF PRECIOUS METAL; SHOE ORNAMENTS OF PRECIOUS METAL; STOP WATCHES; TIE CLIPS; TIE FASTENERS; TIE PINS; TIE TACKS; WALL CLOCKS; WATCH BANDS; WATCH CASES; WATCH CHAINS; WATCH FOBS; WATCH MOVEMENTS; WATCH STRAPS; WATCHES CONTAINING A GAME FUNCTION; WATCHES; WRISTWATCHES (U.S. CLS. 2, 27, 28 AND 50).

CLASS 16—PAPER GOODS AND PRINTED MATTER

FOR ADHESIVE TAPE DISPENSERS FOR HOUSEHOLD OR STATIONERY USE; ADHESIVE TAPES FOR STATIONERY OR HOUSEHOLD PURPOSES; ADHESIVES FOR STATIONERY OR HOUSEHOLD PURPOSES; ANNOUNCEMENT CARDS; BALL POINT PENS; BOOK BINDINGS; BOOK COVERS; BOOK HOLDERS; BOOK ENDS; BUSINESS CARDS; CALENDAR DESK PADS; CALENDAR DESK STANDS; CALENDAR STANDS; CALENDARS; CARDBOARD; CARDS BEARING UNIVERSAL GREETINGS; CHALK; CHARCOAL PENCILS; CHRISTMAS CARDS; CLIP BOARDS; COMIC BOOKS; COMPUTER RIBBONS; COPY PAPER; COPY; COSMETIC PENCIL SHARPENERS; CROSSWORD PUZZLES; CUSHIONING OR PADDING MADE OF PAPER FOR PACKING PURPOSES; DESK BASKETS FOR DESK ACCESSORIES; DESK CALENDARS; DESK FILE TRAYS; DESK MOUNTED STATIONERY CABINETS; DESK PADS; DESK SETS; DESK STANDS AND HOLDERS FOR PENS, PENCILS, AND INK; DESK TOP DOCUMENT RACKS; DESK TOP DOCUMENT STANDS; DESK TOP ORGANIZERS; DESK TOP STATIONERY CABINETS; DIARIES; DISPLAY BOARDS; DISPOSABLE TRAINING PANTS; DOCUMENT FILE RACKS; DOCUMENT FILES; DOCUMENT HOLDERS; ELECTRIC PENCIL SHARPENERS; ENVELOPES; ERASERS; FELT PENS; FELT TIP MARKERS; FIBERTIP PENS; FILE CARDS; FILE FOLDERS; FILE TRAYS; FILTER PAPER; FLUID INK ERADICATOR; FOLDERS; FOOD BAG TAPE FOR FREEZER USE; FOUNTAIN PEN INK CARTRIDGES; FOUNTAIN PENS; GIFT CARDS; GIFT WRAPPING PAPER; GLUE FOR STATIONERY OR HOUSEHOLD USE; GREETING CARDS; HOLOGRAMS; INK RIBBONS; LETTER OPENERS; LETTER RACKS; LETTER TRAYS; LETTERING GUIDES; MAGNETIC BOARDS; MAGNETIC PAPER; MANIFOLD PAPER; MARKERS; MARKING PENS; MECHANICAL PENCILS; MEMO PADS; METALLIC GIFT WRAPPING PAPER; MUSICAL GREETING CARDS; NOTE BOOKS; NOTE CARDS; ORGANIZERS FOR STATIONERY USE; PACK; PACKING PAPER; PAPER BAGS; PAPER CLIPS; PAPER CUTTERS; PAPER EMBLEMS; PAPER NAPKINS; PAPER PILLOWCASES; PAPER POUCHES FOR PACKAGING; PAPER TAGS; PAPER TOWELS; PEN AND PENCIL TRAYS; PEN CASES; PEN INK CARTRIDGES; PEN INK REFILLS; PEN OR PENCIL HOLDERS; PENCIL BOXES; PENCIL CASES; PENCIL LEADS; PENCIL OR PEN BOXES; PENCIL SHARPENERS; PENCILS; PENS; PHOTOGRAPH ALBUMS; PICTURES; PLASTIC BAGS FOR PACKAGING; PLASTIC BAGS FOR UNDERGARMENT DISPOSAL; PLASTIC BUBBLE PACKS FOR WRAPPING OR PACKAGING; PLASTIC DISPOSABLE DIAPER BAGS; PLASTIC FOOD STORAGE BAGS FOR HOUSEHOLD USE; PLASTIC OR PAPER BAGS FOR HOUSEHOLD USE; PLASTIC SANDWICH BAGS; PLAYING CARD CASES; PLAYING CARDS; POSTCARDS; POSTERS; PRICE TICKETS; PRINTED LABELS NOT OF TEXTILE; SANDWICH BAGS; SKETCH BOOKS; STAMP ALBUMS; STAMP PADS; STAPLE REMOVERS; STAPLES; STATIONERY BOXES; STATIONERY FOLDERS; STATIONERY TYPE PORTFOLIOS; STATIONERY

WRITING PAPER AND ENVELOPES; STATIONERY; STICKERS; STRAIGHT EDGES; TABLE CLOTHS OF PAPER; TABLE LINENS OF PAPER; TABLE MATS OF PAPER; TABLE NAPKINS OF PAPER; TELEPHONE INDEXES; TISSUE PAPER; TOILET PAPER; VACUUM CLEANER BAGS; WRAPPING PAPER (U.S. CLS. 2, 5, 22, 23, 29, 37, 38 AND 50).

CLASS 25—CLOTHING

FOR ASCOTS; ATHLETIC FOOTWEAR; ATHLETIC SHOES; BALLOON PANTS; BANDANAS; BANDEAUX; BASEBALL CAPS; BATHROBES; BEACHWEAR; BLAZERS; BLOUSES; BOOTS; BOW TIES; BRASSIERES; CAPEES; CARDIGANS; CLOTH DIAPERS; COATS; CUFFS; DRESSES; EAR MUFFS; FOOTWEAR; GLOVES; GOLF SHIRTS; GOLF SHOES; HATS; HEAD BANDS; HEAD WEAR; INFANTWEAR; JACKETS; JEANS; JUMPERS; LOUNGEWEAR; MITTENS; MUFFS; NECK BANDS; NECKERCHIEFS; NECKTIES; NECKWEAR; OVERALLS; OVERCOATS; OVERSHOES; PAJAMAS; PANTS; POLO SHIRTS; RAINWEAR; SHIRTS; SHOES; SHORTS; SKI WEAR; SKIRTS; SLACKS; SLEEPWEAR; SLIPPERS; SOCKS; SUITS; SUN VISORS; SUSPENDERS; SWEATERS; SWIM WEAR; T-SHIRTS; TROUSERS; UNDERCLOTHES; UNDERWEAR; VESTS; VISORS (U.S. CLS. 22 AND 39).

CLASS 28—TOYS AND SPORTING GOODS

FOR ARCADE GAMES; ATHLETIC TAPE; BALLOONS; CARD GAMES; COIN-OPERATED VIDEO GAMES; DOLLS; ELECTRIC ACTION TOYS; ELECTRIC TOY TRAIN TRANSFORMERS; ELECTRONIC DART GAMES; ELECTRONIC EDUCATIONAL GAME MACHINES FOR CHILDREN; ELECTRONIC GAME EQUIPMENT WITH A WATCH FUNCTION; MAH JONG GAMES; PULL TOYS; TALKING TOYS; TEDDY BEARS; TOSSING DISC TOYS; TOY WATCHES; VIDEO OUTPUT GAMES (U.S. CLS. 22, 23, 38 AND 50).

CLASS 36—INSURANCE AND FINANCIAL

FOR AGENCIES IN THE FIELD OF CREDIT FOR FARMING; BILL PAYMENT SERVICES; BONDING SERVICES; BUSINESS BROKERAGE; BUSINESS LIQUIDATION SERVICES; CASH MANAGEMENT; CASH REPLACEMENT RENDERED BY CREDIT CARD; CHECK CASHING; COLLECTION AGENCIES; CREDIT AGENCIES; CREDIT RECOVERY AND COLLECTION; ELECTRONIC CASH TRANSACTIONS; ELECTRONIC CREDIT CARD TRANSACTIONS; ELECTRONIC DEBIT TRANSACTIONS; ELECTRONIC PAYMENT, NAMELY, ELECTRONIC PROCESSING AND TRANSMISSION OF BILL PAYMENT DATA; PAYMENT SERVICES (BILL); PROVIDING MULTIPLE PAYMENT OPTIONS BY MEANS OF CUSTOMER-OPERATED ELECTRONIC TERMINALS AVAILABLE ON-SITE IN RETAIL STORES; RENT COLLECTION AGENCIES; SAVINGS ACCOUNT SERVICES; SAVINGS AND LOAN ASSOCIATIONS; SAVINGS AND LOAN SERVICES (U.S. CLS. 100, 101 AND 102).

CLASS 38—COMMUNICATION

FOR BROADCASTING PROGRAMS VIA A GLOBAL COMPUTER NETWORK; CABLE CASTING SERVICES; CABLE TELEVISION BROADCASTING; CABLE TELEVISION TRANSMISSION; DELIVERY OF MESSAGES BY ELECTRONIC TRANSMISSION; ELECTRONIC MAIL SERVICES; FACSIMILE TRANSMISSION; NETWORK CONFERENCING SERVICES; PROVIDING TELECOMMUNICATIONS CONNECTIONS TO A GLOBAL COMPUTER NETWORK; RADIO BROADCASTING; RADIO COMMUNICATION; SATELLITE TRANSMISSION SERVICES; SUBSCRIPTION TELEVISION BROADCASTING; TELECOMMUNICATION GATEWAY SERVICES,

NAMELY, PERSONAL COMMUNICATION SERVICES; TELECOMMUNICATIONS SERVICES, NAMELY, ISDN SERVICES; TELECOMMUNICATIONS SERVICES, NAMELY, PERSONAL COMMUNICATION SERVICES; TELEPHONE COMMUNICATION SERVICES; TELEPHONE VOICE MESSAGING SERVICES; TELEVISION BROADCASTING; TELEVISION TRANSMISSION BY CABLE; ELECTRONIC TRANSMISSION OF DATA AND DOCUMENTS VIA COMPUTER TERMINALS; ELECTRONIC TRANSMISSION OF MESSAGES AND DATA; VIDEO-ON-DEMAND TRANSMISSION SERVICES; VOICE MAIL SERVICES (U.S. CLS. 100, 101 AND 104).

CLASS 41—EDUCATION AND ENTERTAINMENT

FOR EDUCATIONAL SERVICES, NAMELY, CONDUCTING SEMINARS AND WORKSHOPS IN THE FIELD OF TELECOMMUNICATIONS, CONNECTIONS TO A GLOBAL COMPUTER NETWORK, NAMELY VIA ELECTRONIC MAIL (U.S. CLS. 100, 101 AND 107).

SN 75-558,639. SCHENK, CHRISTINE, A-L010 WIEN, AUSTRIA, FILED 9-24-1998.



OWNER OF AUSTRIA REG. NO. 174134, DATED 2-17-1998, EXPIRES 2-17-2008.
THE STIPPLING IN THE DRAWING IS FOR SHADING PURPOSES ONLY.

CLASS 16—PAPER GOODS AND PRINTED MATTER

FOR PRINTED MATTER, NAMELY, INSTRUCTIONAL, EDUCATIONAL, TEACHING MATERIALS, AND BROCHURES, IN THE FIELDS OF PSYCHOPHYSIOLOGY, EXTRA-SENSORY PERCEPTION, SELF-AWARENESS, SELF-HELP, HOLISTIC AND TRADITIONAL MEDICINE, MASSAGE, PSYCHOTHERAPY, PSYCHOLOGY, PSYCHOPHYSICS, AND BIOPHYSICS, NONE OF WHICH PRINTED MATTER INVOLVES WEIGHT MANAGEMENT (U.S. CLS. 2, 5, 22, 23, 29, 37, 38 AND 50).

FIRST USE 1-0-1996; IN COMMERCE 11-0-1997.

CLASS 41—EDUCATION AND ENTERTAINMENT

FOR WORKSHOPS AND SEMINARS IN THE FIELDS OF PSYCHOPHYSIOLOGY, EXTRA-SENSORY PERCEPTION, SELF-AWARENESS, SELF-HELP, HOLISTIC AND TRADITIONAL MEDICINE, MASSAGE, PSYCHOTHERAPY, PSYCHOLOGY, PSYCHOPHYSICS AND BIOPHYSICS, NONE OF WHICH INVOLVE WEIGHT MANAGEMENT (U.S. CLS. 100, 101 AND 107).

FIRST USE 1-0-1996; IN COMMERCE 11-0-1997.

CLASS 42—SCIENTIFIC, COMPUTER AND LEGAL SERVICES

FOR SCIENTIFIC RESEARCH; MEDICAL SERVICES; HEALTH CARE; CONSULTANCY IN THE FIELDS OF PSYCHOPHYSIOLOGY, EXTRA-SENSORY PERCEPTION, SELF-AWARENESS, SELF-HELP, HOLISTIC AND TRADITIONAL MEDICINE, MASSAGE, PSYCHOPHYSICS AND BIOPHYSICS; PSYCHOTHERAPY, NONE OF WHICH INVOLVE WEIGHT MANAGEMENT; AND PSYCHOLOGICAL CONSULTATION (U.S. CLS. 100 AND 101).

FIRST USE 1-0-1996; IN COMMERCE 11-0-1997.

SN 75-562,759. CILLIT WASSERTECHNIK GMBH & CO., D-69198 SCHRIESHEIM, FED REP GERMANY, FILED 10-1-1998.



CLASS 1—CHEMICALS

FOR CHEMICALS FOR THE TREATMENT, CLARIFYING, SOFTENING, DESALINATION, DEACIDIFICATION, DECHLORINATION AND DISINFECTING (STERILIZING) OF WATER; CALCIUM PROTECTANT, NAMELY, CHEMICAL AGENTS FOR REMOVING INCrustATIONS, CALCIUM DEPOSITS AND RUST INCrustATIONS ESPECIALLY FOR HOT WATER HEATING SYSTEMS; CHEMICAL AGENTS FOR CONTROLLING PH VALUES IN SWIMMING POOLS; FLOCCULANTS FOR THE TREATMENT OF WASTE WATER; FILTER MATERIALS, NAMELY, LIQUID QUARTZ, DOLOMITE, ACTIVATED COAL FOR WATER; AND CHEMICAL ADDITIVES THAT ARE ADDED TO WATER TO PREVENT RUST AND CORROSION (U.S. CLS. 1, 5, 6, 10, 26 AND 46).

CLASS 5—PHARMACEUTICALS

FOR ALGAEICIDES AND BACTERICIDES FOR SWIMMING POOLS (U.S. CLS. 6, 18, 44, 46, 51 AND 52).

CLASS 6—METAL GOODS

FOR METAL SWIMMING POOL EQUIPMENT AND SWIMMING POOL ACCESSORIES, NAMELY, SWIMMING POOL BASINS, FLOOR DRAINS, WATER PIPES, LADDERS AND THEIR SUPPORT BRACKETS, SOLD TOGETHER AS A UNIT JUMPING BOARDS, ROPE ANCHORS AND HOOKS, SUPPORT RODS; METAL CLOSURE VANES FOR INLET COMPONENTS AND SUCTION CONNECTORS FOR USE IN SWIMMING POOLS; METAL SWILL WATER COLLECTING CONTAINERS FOR USE IN SWIMMING POOLS, METAL SAUNA EQUIPMENT, NAMELY, METAL HAND RAILS; METAL SUBMERSIONS BASINS FOR SAUNAS; AND PARTS FOR ALL OF THE PREVIOUS GOODS (U.S. CLS. 2, 12, 13, 14, 23, 25 AND 50).

CLASS 7—MACHINERY

FOR SWIMMING POOL EQUIPMENT, NAMELY, RECIRCULATION PUMP HAVING VALVES; AND PARTS THEREFOR (U.S. CLS. 13, 19, 21, 23, 31, 34 AND 35).

CLASS 9—ELECTRICAL AND SCIENTIFIC APPARATUS

FOR APPARATUS FOR ANALYZING WATER, NAMELY, PH METERS; WATER METERS; HEAT PROTECTION APPARATUS, NAMELY, THERMOSTATS FOR HOT WATER HEATERS, SWIMMING POOL EQUIPMENT AND SWIMMING POOL ACCESSORIES, NAMELY, WATER LEVEL REGULATORS, AUTOMATIC ELECTROLYTIC CELLS FOR CHLORINATING WATER; ELECTRICAL APPARATUS FOR MEASURING AND MONITORING QUANTITY, VELOCITY, PRESSURE, LEVEL, TEMPERATURE, VISCOSITY, ION CONCENTRATION, SALINITY AND RADIOACTIVITY OF SWIMMING POOL WATER, AND PARTS THEREFOR (U.S. CLS. 21, 23, 26, 36 AND 38).

CLASS 11—ENVIRONMENTAL CONTROL APPARATUS

FOR OZONE GENERATORS; APPARATUS FOR TREATING, CLARIFYING, SOFTENING, DESALINATING, CLEANING DEACIDIFYING, DECHLORINATING AND DISINFECTING (STERILIZING) WATER, FILTER APPARATUS FOR FILTERING WATER; DESALINATION EQUIPMENT, NAMELY, EVAPORATORS OPERATED BY FOSSIL FUELS AND/OR SOLAR ENERGY; SWIMMING POOL EQUIPMENT, NAMELY, PLUMBING VALVES AND WATER CONDUITS, UNDERWATER FLOODLIGHTS; AUTOMATIC HOT WATER HEATERS; APPARATUS, NAMELY, WATER HEATERS FOR DISINFECTING AND ALGAE INHIBITION; SAUNA STOVES; SAUNA HEATERS; AND PARTS FOR ALL THE GOODS (U.S. CLS. 13, 21, 23, 31 AND 34).

CLASS 19—NON-METALLIC BUILDING MATERIALS

FOR NON-METAL SWIMMING POOLS; NON-METAL SWIMMING POOL PARTS AND ACCESSORIES, NAMELY SWIMMING BASINS, WALL OPENINGS; AND NON-METAL SUBMERSION BASINS FOR SAUNAS AND PARTS THEREFOR (U.S. CLS. 1, 12, 33 AND 50).

SN 75-563,021. CENTEX CONSTRUCTION PRODUCTS, INC., DALLAS, TX. BY ASSIGNMENT REPUBLIC GROUP INCORPORATED, HUTCHINSON, KS. FILED 10-2-1998.

REPUBLIC FIBER COMPANY

NO CLAIM IS MADE TO THE EXCLUSIVE RIGHT TO USE "FIBER COMPANY", APART FROM THE MARK AS SHOWN.

CLASS 35—ADVERTISING AND BUSINESS

FOR WHOLESALE DISTRIBUTORSHIPS FEATURING RECLAIMED PAPER FIBER (U.S. CLS. 100, 101 AND 102).

FIRST USE 9-21-1998; IN COMMERCE 9-21-1998.

CLASS 40—MATERIAL TREATMENT

FOR RECYCLING SERVICES, NAMELY, RECLAMATION OF PAPER FIBER (U.S. CLS. 100, 103 AND 106).
FIRST USE 9-21-1998; IN COMMERCE 9-21-1998.

SN 75-576,672. LENNAR CORPORATION, MIAMI, FL. FILED 10-27-1998.



THE LINING SHOWN IN THE DRAWING IS A FEATURE OF THE MARK AND NOT INTENDED TO INDICATE COLOR.

CLASS 36—INSURANCE AND FINANCIAL

FOR REAL ESTATE CONSULTING SERVICES, NAMELY, REAL ESTATE MANAGEMENT AND REAL ESTATE BROKERAGE SERVICES OF UNDEVELOPED PROPERTY, RESIDENTIAL COMMUNITIES AND INDIVIDUAL RESIDENCES (U.S. CLS. 100, 101 AND 102).

FIRST USE 5-0-1973; IN COMMERCE 5-0-1973.

CLASS 37—CONSTRUCTION AND REPAIR

FOR REAL ESTATE DEVELOPMENT AND PLANNING SERVICES, NAMELY, DEVELOPING, LAYING OUT, CONSTRUCTING RESIDENTIAL COMMUNITIES AND INDIVIDUAL RESIDENCES (U.S. CLS. 100, 103 AND 106).

FIRST USE 5-0-1973; IN COMMERCE 5-0-1973.

SN 75-607,570. ESPA INTERNATIONAL (UK) LIMITED, FARNHAM, SURREY, UNITED KINGDOM, FILED 12-17-1998.

The logo for ESPA, featuring the word "ESPA" in a large, bold, serif font.

CLASS 3—COSMETICS AND CLEANING PREPARATIONS

FOR NON-MEDICATED TOILET PREPARATIONS, NAMELY, SKIN CARE CREAMS, LOTIONS, OILS, GELS, MOISTURIZERS, TONERS FOR HANDS, FEET, EYES, BODY AND LEGS, BATH AND BODY OILS, SOAP SCRUB, BATH AND BODY SKIN SCRUB, BODY GELS, FACIAL AND BODY MASKS AND EXFOLIATORS, FOAM BATH, HAIR PRODUCTS, NAMELY, CONDITIONERS, SHAMPOOS, HAIR GELS AND DEODORANTS; ESSENTIAL OILS FOR PERSONAL USE; HAIR AND NAIL CARE PREPARATIONS; AND SKIN SOAPS (U.S. CLS. 1, 4, 6, 50, 51 AND 52).

CLASS 24—FABRICS

FOR TOWELS, BED AND TABLE LINEN (U.S. CLS. 42 AND 50).

CLASS 35—ADVERTISING AND BUSINESS

FOR BUSINESS MANAGEMENT OF HEALTH SPAS, HEALTH HYDROS, HEALTH FARMS, HEALTH CLUBS, LEISURE CLUBS AND RESORT HOTELS (U.S. CLS. 100, 101 AND 102).

CLASS 41—EDUCATION AND ENTERTAINMENT

FOR HEALTH CLUBS (U.S. CLS. 100, 101 AND 107).

CLASS 42—SCIENTIFIC, COMPUTER AND LEGAL SERVICES

FOR ARCHITECTURAL DESIGN OF HEALTH SPAS, HEALTH CLUBS AND RESORT HOTELS; HEALTH SPAS, AND RESORT HOTELS (U.S. CLS. 100 AND 101).

SN 75-608,626. MULTIACTIVE TECHNOLOGIES INC., VANCOUVER, BRITISH COLUMBIA, CANADA, FILED 12-18-1998.

ECPARTNER

PRIORITY CLAIMED UNDER SEC. 44(D) ON CANADA APPLICATION NO. 882,997, FILED 6-30-1998, REG. NO. TMA539,297, DATED 1-8-2001, EXPIRES 1-8-2016.

CLASS 9—ELECTRICAL AND SCIENTIFIC APPARATUS

FOR COMPUTER SOFTWARE FOR USE AND CREATION OF WEBSITES (U.S. CLS. 21, 23, 26, 36 AND 38).

CLASS 42—SCIENTIFIC, COMPUTER AND LEGAL SERVICES

FOR TECHNICAL SUPPORT SERVICES, NAMELY, TROUBLESHOOTING OF COMPUTER SOFTWARE PROBLEMS VIA TELEPHONE, EMAIL, FACSIMILE, REGULAR MAIL AND IN PERSON (U.S. CLS. 100 AND 101).

SN 75-620,723. INFORMATION DELIVERY SYSTEMS CONSULTING AB, S-118 63 STOCKHOLM, SWEDEN, FILED 1-14-1999.

VISUAL SERVICES

NO CLAIM IS MADE TO THE EXCLUSIVE RIGHT TO USE "SERVICES", APART FROM THE MARK AS SHOWN.

CLASS 9—ELECTRICAL AND SCIENTIFIC APPARATUS

FOR COMPUTER HARDWARE; COMPUTER SOFTWARE PROGRAMS FOR DECISION SUPPORT, NAMELY, SOFTWARE FOR USE IN DATABASE MANAGEMENT AND ANALYSIS OF CALL DETAIL RECORDS IN THE TELECOMMUNICATIONS FIELD; BLANK MAGNETIC COMPUTER TAPES AND OPTICAL DISCS; ELECTRICAL APPARATUS, NAMELY, TELECOMMUNICATION SWITCHES FOR REGISTRATION, CONTROL AND PROCESSING OF STATISTICAL INFORMATION AND OBSERVATION FOR THE TELECOM AND COMPUTER INDUSTRY (U.S. CLS. 21, 23, 26, 36 AND 38).

CLASS 35—ADVERTISING AND BUSINESS

FOR BUSINESS MANAGEMENT AND INDUSTRIAL MANAGEMENT ASSISTANCE; CONDUCTING BUSINESS AND MARKET RESEARCH; COMPUTERIZED MANAGEMENT OF DATABASES FOR REGISTERS AND STATISTICS (U.S. CLS. 100, 101 AND 102).

CLASS 42—SCIENTIFIC, COMPUTER AND LEGAL SERVICES

FOR CREATING, UPDATING AND MAINTAINING OF COMPUTER SOFTWARE; COMPUTER PROGRAMMING FOR OTHERS; TECHNICAL CONSULTATION REGARDING COMPUTER HARDWARE, SOFTWARE AND THE COMPILATION AND ANALYSIS OF STATISTICS, REGISTERS AND INFORMATION IN THE FIELD OF TELECOMMUNICATIONS (U.S. CLS. 100 AND 101).

SN 75-622,978. INTERNATIONAL SKATING UNION, CH 1007 LAUSANNE, SWITZERLAND, FILED 1-19-1999.

WORLD JUNIOR FIGURE SKATING CHAMPIONSHIPS

NO CLAIM IS MADE TO THE EXCLUSIVE RIGHT TO USE "JUNIOR FIGURE SKATING CHAMPIONSHIPS", APART FROM THE MARK AS SHOWN.
SEC. 2(F).

CLASS 9—ELECTRICAL AND SCIENTIFIC APPARATUS

FOR PRE-RECORDED VIDEO TAPES AND AUDIO TAPES FEATURING THE SPORT OF SKATING; FILMS REGARDING THE SPORT OF SKATING (U.S. CLS. 21, 23, 26, 36 AND 38).

CLASS 16—PAPER GOODS AND PRINTED MATTER

FOR PRINTED MATTER, NAMELY, MAGAZINES; PERIODICALS; NAMELY, BROCHURES, NEWSLETTERS, NEWSPAPERS, AND BOOKS REGARDING THE SPORT OF SKATING, CATALOGUES, CARDS, NAMELY, NOTE CARDS, POST CARDS, GIFT CARDS; POSTERS, MOUNTED AND UNMOUNTED PHOTOGRAPHS AND PICTURES, ALL REGARDING THE SPORT OF SKATING (U.S. CLS. 2, 5, 22, 23, 29, 37, 38 AND 50).

CLASS 41—EDUCATION AND ENTERTAINMENT

FOR PROVIDING FACILITIES FOR FIGURE AND SPEED SKATING COMPETITIONS AND SHOWS (U.S. CLS. 100, 101 AND 107).

SN 75-622,979. INTERNATIONAL SKATING UNION, CH 1007 LAUSANNE, SWITZERLAND, FILED 1-19-1999.

WORLD FIGURE SKATING CHAMPIONSHIPS

NO CLAIM IS MADE TO THE EXCLUSIVE RIGHT TO USE "FIGURE SKATING CHAMPIONSHIPS", APART FROM THE MARK AS SHOWN.
SEC. 2(F).

CLASS 9—ELECTRICAL AND SCIENTIFIC APPARATUS

FOR PRE-RECORDED VIDEO TAPES AND AUDIO TAPES FEATURING THE SPORT OF SKATING; FILMS REGARDING THE SPORT OF SKATING (U.S. CLS. 21, 23, 26, 36 AND 38).

CLASS 16—PAPER GOODS AND PRINTED MATTER

FOR PRINTED MATTER, NAMELY, MAGAZINES; PERIODICALS; NAMELY, BROCHURES, NEWSLETTERS, NEWSPAPERS, AND BOOKS REGARDING THE SPORT OF SKATING, CATALOGUES, CARDS, NAMELY, NOTE CARDS, POST CARDS, GIFT CARDS; POSTERS, MOUNTED AND UNMOUNTED PHOTOGRAPHS AND PICTURES, ALL REGARDING THE SPORT OF SKATING (U.S. CLS. 2, 5, 22, 23, 29, 37, 38 AND 50).

CLASS 41—EDUCATION AND ENTERTAINMENT

FOR PROVIDING FACILITIES FOR FIGURE AND SPEED SKATING COMPETITIONS AND SHOWS (U.S. CLS. 100, 101 AND 107).

SN 75-622,982. INTERNATIONAL SKATING UNION, CH 1007 LAUSANNE, SWITZERLAND, FILED 1-19-1999.



OWNER OF SWITZERLAND REG. NO. 449075, DATED 10-7-1997, EXPIRES 10-7-2007.

NO CLAIM IS MADE TO THE EXCLUSIVE RIGHT TO USE "SKATING", APART FROM THE MARK AS SHOWN. SEC. 2(F) "INTERNATIONAL" AND "UNION".

CLASS 9—ELECTRICAL AND SCIENTIFIC APPARATUS

FOR PRE-RECORDED VIDEO TAPES AND AUDIO TAPES FEATURING THE SPORT OF SKATING; FILMS REGARDING THE SPORT OF SKATING (U.S. CLS. 21, 23, 26, 36 AND 38).

CLASS 16—PAPER GOODS AND PRINTED MATTER

FOR PRINTED MATTER, NAMELY, MAGAZINES; PERIODICALS, NAMELY, BROCHURES, NEWSLETTERS, NEWSPAPERS, AND BOOKS REGARDING THE SPORT OF SKATING; CATALOGUES; CARDS, NAMELY, NOTE CARDS, POST CARDS, GIFT CARDS; POSTERS; MOUNTED AND UNMOUNTED PHOTOGRAPHS AND PICTURES, ALL REGARDING THE SPORT OF SKATING (U.S. CLS. 2, 5, 22, 23, 29, 37, 38 AND 50).

CLASS 41—EDUCATION AND ENTERTAINMENT

FOR FIGURE AND SPEED SKATING COMPETITIONS RENDERED LIVE AND THROUGH A SERIES OF TELEVISION AND RADIO BROADCASTS; ORGANIZING AND CONDUCTING WORKSHOPS, SEMINARS, CONFERENCES AND EXHIBITS REGARDING FIGURE AND SPEED SKATING; INSTRUCTION IN THE FIELD OF SKATING; PROVIDING FACILITIES FOR FIGURE AND SPEED SKATING COMPETITIONS AND SHOWS (U.S. CLS. 100, 101 AND 107).

SN 75-627,888. ALLINA HEALTH SYSTEM, MINNEAPOLIS, MN. FILED 1-26-1999.

MEDFORMATION

OWNER OF U.S. REG. NO. 1,866,042.

CLASS 35—ADVERTISING AND BUSINESS

FOR PHYSICIAN, HOSPITAL AND CLINIC AND PHARMACY REFERRAL SERVICES PROVIDED VIA A GLOBAL COMPUTER NETWORK (U.S. CLS. 100, 101 AND 102).

CLASS 38—COMMUNICATION

FOR PROVIDING ON-LINE MODERATED AND UN-MODERATED CHAT FOR TRANSMISSION OF MESSAGES AMONG COMPUTER USERS CONCERNING HEALTH AND MEDICAL INFORMATION; PROVIDING ON-LINE MESSAGING BOARDS FOR TRANSMISSION OF MESSAGES AMONG COMPUTER USERS CONCERNING HEALTH AND MEDICAL INFORMATION; PROVIDING TRANSMISSION OF ON-LINE SECURE MESSAGING AMONG PHYSICIANS AND PATIENTS; AND PROVIDING ON-LINE TRANSMISSION OF MEDICAL RECORDS (U.S. CLS. 100, 101 AND 104).

CLASS 42—SCIENTIFIC, COMPUTER AND LEGAL SERVICES

FOR PROVIDING A WEB SITE ON GLOBAL COMPUTER NETWORKS FEATURING, MEDICAL AND HEALTH INFORMATION, NAMELY, DIAGNOSTIC ADVICE, SYMPTOMS, CONDITIONS, TREATMENT, PREVENTION, MEDICAL NEWS, TIPS AND ADVICE ON HEALTH TOPICS, HEALTH AND MEDICAL COURSE DESCRIPTIONS, LOCATIONS, DATES, AND TIMES, AND COURSE REGISTRATION, FITNESS EXERCISES, NUTRITION, IMMUNIZATION, COMPLEMENTARY AND ALTERNATIVE MEDICINE, CALENDAR OF MEDICAL AND HEALTH RELATED EVENTS, AND DRUG INFORMATION (U.S. CLS. 100 AND 101).

SN 75-648,889. DYEABLES, INC., BREWSTER, NY. FILED 2-26-1999.

DYEABLES

SEC. 2(F).

CLASS 18—LEATHER GOODS

FOR HANDBAGS (U.S. CLS. 1, 2, 3, 22 AND 41). FIRST USE 11-12-1982; IN COMMERCE 11-12-1982.

CLASS 25—CLOTHING

FOR WOMEN'S SHOES (U.S. CLS. 22 AND 39).
FIRST USE 11-12-1982; IN COMMERCE 11-12-1982.

SN 75-654,470. WESTFIELD CORPORATION, INC., LOS ANGELES, CA. FILED 3-5-1999.



OWNER OF U.S. REG. NOS. 1,441,465 AND 2,148,842.

CLASS 36—INSURANCE AND FINANCIAL

FOR REAL PROPERTY LEASING, OPERATION AND MANAGEMENT SERVICES (U.S. CLS. 100, 101 AND 102).
FIRST USE 4-1-1977; IN COMMERCE 11-3-1986.

CLASS 37—CONSTRUCTION AND REPAIR

FOR REAL PROPERTY DEVELOPMENT SERVICES (U.S. CLS. 100, 103 AND 106).
FIRST USE 4-1-1977; IN COMMERCE 11-3-1986.

SN 75-656,667. REVANA TELCOM, INC., HOUSTON, TX. FILED 3-10-1999.

CENTALK

CLASS 9—ELECTRICAL AND SCIENTIFIC APPARATUS

FOR PREPAID CALLING CARDS MAGNETICALLY ENCODED (U.S. CLS. 21, 23, 26, 36 AND 38).

CLASS 36—INSURANCE AND FINANCIAL

FOR TELEPHONE CARD SERVICES (U.S. CLS. 100, 101 AND 102).

SN 75-671,379. FINN-POWER INTERNATIONAL, INC., SCHAUMBURG, IL. FILED 3-30-1999.

FOUR-IN-ONE

CLASS 7—MACHINERY

FOR PUNCH PRESS INCLUDING TURRET PUNCH PRESSES; METAL SHEET FABRICATION SYSTEM COMPRISING COMBINATION LASER/PUNCH MACHINES AND OTHER METAL SHEET FABRICATION MACHINES FOR USE IN PUNCHING, FORMING AND TAPPING AND LASER CUTTING SHEET METAL FOR INDUSTRIAL USE (U.S. CLS. 13, 19, 21, 23, 31, 34 AND 35).

CLASS 9—ELECTRICAL AND SCIENTIFIC APPARATUS

FOR COMPUTER FIRMWARE, SOFTWARE, AND OPERATION PROGRAMS USED TO OPERATE THE PROCESSORS OF PUNCH PRESSES, TURRET PUNCH PRESSES, METAL SHEET FABRICATION SYSTEMS COMPRISING COMBINATION LASER/PUNCH MACHINES, AND OTHER METAL SHEET FABRICATION MACHINES USED IN PUNCHING, FORMING, TAPPING AND LASER CUTTING SHEET METAL FOR INDUSTRIAL USE (U.S. CLS. 21, 23, 26, 36 AND 38).

SN 75-678,044. INTERNATIONAL DATA GROUP, INC., FRAMINGHAM, MA. FILED 4-9-1999.



NO CLAIM IS MADE TO THE EXCLUSIVE RIGHT TO USE "CONFERENCE & EXPO", APART FROM THE MARK AS SHOWN.

CLASS 35—ADVERTISING AND BUSINESS

FOR ARRANGING AND CONDUCTING TRADE SHOWS, EXPOSITIONS, EXHIBITIONS, AND CONFERENCES IN THE FIELDS OF COMPUTERS, COMPUTER SOFTWARE, ONLINE SERVICES, HIGH TECHNOLOGY COMMUNICATIONS, INFORMATION TECHNOLOGY AND INFORMATION SERVICES, PROVIDING INTEGRATED MARKETING SERVICES AND ADVERTISING SERVICES, NAMELY PROMOTING THE GOODS AND SERVICES OF OTHERS BY PREPARING AND PLACING ADVERTISEMENTS ON A WEBSITE ACCESSED THROUGH A GLOBAL COMPUTER NETWORK AND ON NEWSLETTERS DELIVERED ON A COMPUTER NETWORK BY E-MAIL (U.S. CLS. 100, 101 AND 102).
FIRST USE 10-23-1998; IN COMMERCE 10-23-1998.

CLASS 42—SCIENTIFIC, COMPUTER AND LEGAL SERVICES

FOR COMPUTER SERVICES, NAMELY PROVIDING ONLINE PUBLICATIONS, NAMELY NEWSLETTERS, MAGAZINES AND SUPPLEMENTS SOLD THEREWITH JOURNALS, NEWSPAPERS AND BOOKS IN THE FIELDS OF COMPUTERS, COMPUTER SOFTWARE, ONLINE SERVICES, HIGH TECHNOLOGY, COMMUNICATIONS, INFORMATION TECHNOLOGY AND INFORMATION SERVICES; PROVIDING INFORMATION IN THE FIELDS OF COMPUTERS, COMPUTER SOFTWARE, ONLINE SERVICES, HIGH TECHNOLOGY, COMMUNICATIONS, INFORMATION TECHNOLOGY AND INFORMATION SERVICES BY MEANS OF A WEBSITE ACCESSIBLE VIA A GLOBAL COMPUTER NETWORK, INFORMATION SERVICES IN THE NATURE OF NEWSLETTERS IN THE FIELDS OF COMPUTERS, COMPUTER SOFTWARE, ONLINE SERVICES, HIGH TECHNOLOGY, COMMUNICATIONS, INFORMATION TECHNOLOGY AND INFORMATION SERVICES DELIVERED ON A COMPUTER NETWORK BY E-MAIL (U.S. CLS. 100 AND 101).
FIRST USE 9-30-1998; IN COMMERCE 9-30-1998.

SN 75-686,837. HUFFMAN VENTURES, INC., HUNTINGTON BEACH, CA. FILED 4-19-1999.



CLASS 16—PAPER GOODS AND PRINTED MATTER

FOR PRINTED PUBLICATIONS, NAMELY MAGAZINES, NEWSLETTERS AND BROCHURES ON THE SUBJECT OF ALTERNATIVE SPORTS (U.S. CLS. 2, 5, 22, 23, 29, 37, 38 AND 50).

CLASS 41—EDUCATION AND ENTERTAINMENT

FOR ON-LINE PUBLICATIONS, NAMELY WEB PAGES, NEWSLETTERS, ADVERTISEMENTS AND ARTICLES ON THE SUBJECT OF ALTERNATIVE SPORTS, PROVIDED BY MEANS OF A GLOBAL COMPUTER NETWORK (U.S. CLS. 100, 101 AND 107).

SN 75-691,453. KNURR-MECHANIK FUR DIE ELEKTRONIK AG, D 81829 MUNCHEN, FED REP GERMANY, FILED 4-27-1999.

RAPOMOS

PRIORITY CLAIMED UNDER SEC. 44(D) ON FED REP GERMANY APPLICATION NO. 398680809, FILED 11-25-1998, REG. NO. 39868080, DATED 4-30-1999, EXPIRES 11-30-2008.

CLASS 9—ELECTRICAL AND SCIENTIFIC APPARATUS

FOR ELECTRICAL AND ELECTRONIC APPARATUS, INSTRUMENTS, AND SUBASSEMBLIES, NAMELY, DIGITAL MULTIMETER, FUNCTION GENERATOR, FREQUENCY COUNTER, AND R/C-DECADE RESISTOR ELECTRICAL PLUG-IN POWER SUPPLY UNITS, ELECTRICAL POWER SUPPLY UNITS, ELECTRICAL REGULATING AND DISCONNECTING TRANSFORMERS, ELECTRONIC SUBASSEMBLIES, NAMELY ELECTRICAL POWER CONTROL SWITCHING PANELS; DATA PROCESSING AND COMMUNICATION APPARATUS IN THE NATURE OF COMPUTER AND COMPUTER MONITORS AND PARTS THEREFOR FOR ALL OF THE AFORESAID GOODS (U.S. CLS. 21, 23, 26, 36 AND 38).

CLASS 20—FURNITURE AND ARTICLES NOT OTHERWISE CLASSIFIED

FOR FURNITURE FOR ELECTRICAL, ELECTRONIC AND LABORATORY WORKSTATIONS COMPRISED OF CABINETS, RACKS, WORK TABLES AND CONSOLES (U.S. CLS. 2, 13, 22, 25, 32 AND 50).

SN 75-691,645. WORLDSPORT NETWORKS LIMITED, DUBLIN 2, IRELAND, FILED 4-27-1999.

SPIRIT OF SPORT AWARDS

PRIORITY CLAIMED UNDER SEC. 44(D) ON MONACO APPLICATION NO. 98.20035, FILED 10-27-1998, REG. NO. 98.20035, DATED 12-23-1998, EXPIRES 10-27-2008.

NO CLAIM IS MADE TO THE EXCLUSIVE RIGHT TO USE "SPORT AWARDS", APART FROM THE MARK AS SHOWN.

CLASS 41—EDUCATION AND ENTERTAINMENT

FOR SPORTING SERVICES, NAMELY, ARRANGING AND CONDUCTING ATHLETIC COMPETITIONS AND RECREATIONAL EVENTS FEATURING TRACK AND FIELD, RACQUET SPORTS, WATER SPORTS, MECHANIZED RACING, GYMNASTICS, MARTIAL ARTS, AND SPORTS PLAYED ON A COURT OR FIELD; PUBLISHING SERVICES, NAMELY, PUBLICATION OF BOOKS AND PERIODICALS IN THE FIELD OF SPORTS AND RECREATION, ELECTRONIC PUBLISHING, NAMELY PUBLICATION OF TEXT AND GRAPHIC WORKS OF OTHERS ON CD-ROMS AND ELECTRONIC DATABASES IN THE FIELDS OF SPORTS AND RECREATION; EDUCATIONAL SERVICES, NAMELY, CONDUCTING CLASSES, WORKSHOPS SEMINAR AND CONFERENCES FEATURING INSTRUCTION ON SPORTS, RECREATIONAL EVENTS, NAMELY, TRACK AND FIELD, RACQUET SPORTS, WATER SPORTS, MECHANIZED RACING, GYMNASTICS, MARTIAL ARTS, AND SPORTS PLAYED ON A COURT OR FIELD AND SPORTS HEALTH; ORGANIZATION OF ATHLETIC COMPETITIONS AND GAMES AND RECREATIONAL EVENTS FEATURING TRACK AND FIELD, RACQUET SPORTS, WATER SPORTS, MECHANIZED RACING, GYMNASTICS, MARTIAL ARTS, AND SPORTS PLAYED ON A COURT OR FIELD; ON-LINE SERVICES, NAMELY, PROVIDING INFORMATION ABOUT SPORTS AND RECREATION VIA A GLOBAL COMPUTER NETWORK (U.S. CLS. 100, 101 AND 107).

CLASS 42—SCIENTIFIC, COMPUTER AND LEGAL SERVICES

FOR COMPUTER SERVICES, NAMELY, PROVIDING ON-LINE CALENDARS, NEWSLETTERS AND PERIODICALS IN THE FIELDS OF SPORTS AND RECREATION VIA A GLOBAL COMPUTER NETWORK (U.S. CLS. 100 AND 101).

SN 75-692,180. WORLDSPORT NETWORKS LIMITED, DUBLIN 2, IRELAND, FILED 4-27-1999.

SPIRIT OF SPORT

PRIORITY CLAIMED UNDER SEC. 44(D) ON MONACO APPLICATION NO. 20173, FILED 10-27-1998, REG. NO. 98.20037, DATED 12-23-1998, EXPIRES 10-27-2008.

NO CLAIM IS MADE TO THE EXCLUSIVE RIGHT TO USE "SPORT", APART FROM THE MARK AS SHOWN.

CLASS 41—EDUCATION AND ENTERTAINMENT

FOR SPORTING SERVICES, NAMELY, ARRANGING AND CONDUCTING ATHLETIC COMPETITIONS AND RECREATIONAL EVENTS FEATURING TRACK AND FIELD, RACQUET SPORTS, WATER SPORTS, MECHANIZED RACING, GYMNASTICS, MARTIAL ARTS, AND SPORTS PLAYED ON A COURT OR FIELD; PUBLISHING SERVICES, NAMELY, PUBLICATION OF BOOKS AND PERIODICALS IN THE FIELD OF SPORTS AND RECREATION, ELECTRONIC PUBLISHING, NAMELY PUBLICATION OF TEXT AND GRAPHIC WORKS OF OTHERS ON CD-ROMS AND ELECTRONIC DATABASES IN THE FIELDS OF SPORTS AND RECREATION; EDUCATIONAL SERVICES, NAMELY, CONDUCTING CLASSES, WORKSHOPS SEMINAR AND CONFERENCES FEATURING INSTRUCTION ON SPORTS, RECREATIONAL EVENTS, NAMELY, TRACK AND FIELD, RACQUET SPORTS, WATER SPORTS, MECHANIZED RACING, GYMNASTICS, MARTIAL ARTS, AND SPORTS PLAYED ON A COURT OR FIELD AND SPORTS HEALTH; ORGANIZATION OF ATHLETIC COMPETITIONS AND GAMES AND RECREATIONAL EVENTS FEATURING TRACK AND FIELD, RACQUET SPORTS, WATER SPORTS, MECHANIZED RACING, GYMNASTICS, MARTIAL ARTS, AND SPORTS PLAYED ON A COURT OR FIELD; ON-LINE SERVICES, NAMELY, PROVIDING INFORMATION ABOUT SPORTS AND RECREATION VIA A GLOBAL COMPUTER NETWORK (U.S. CLS. 100, 101 AND 107).

CLASS 42—SCIENTIFIC, COMPUTER AND LEGAL SERVICES

FOR COMPUTER SERVICES, NAMELY, PROVIDING ON-LINE CALENDARS, NEWSLETTERS AND PERIODICALS IN THE FIELDS OF SPORTS AND RECREATION VIA A GLOBAL COMPUTER NETWORK (U.S. CLS. 100 AND 101).

SN 75-692,994. L.A. FITNESS INTERNATIONAL LLC, NEWPORT BEACH, CA. FILED 4-28-1999.

LA FITNESS

OWNER OF U.S. REG. NO. 1,806,464.
NO CLAIM IS MADE TO THE EXCLUSIVE RIGHT TO USE "FITNESS", APART FROM THE MARK AS SHOWN.
SEC. 2(F).

CLASS 25—CLOTHING

FOR CLOTHING, NAMELY T-SHIRTS AND OTHER WORKOUT APPAREL, NAMELY LEOTARDS, SWEATSHIRTS, SWEATPANTS AND SHORTS (U.S. CLS. 22 AND 39).
FIRST USE 7-0-1988; IN COMMERCE 9-0-1998.

CLASS 28—TOYS AND SPORTING GOODS

FOR ATHLETIC SPORTING GOODS, NAMELY KNEE PADS FOR ATHLETIC USE, ATHLETIC WRIST SUPPORTS, AND WEIGHTLIFTING GLOVES AND BELTS (U.S. CLS. 22, 23, 38 AND 50).
FIRST USE 7-0-1988; IN COMMERCE 9-0-1998.

SN 75-697,170. MUSIC FOR YOUNG CHILDREN BY FRANCES BALODIS LTD., KANATA, ONTARIO, CANADA, FILED 5-4-1999.

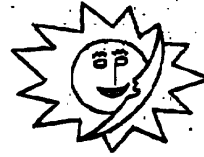

PRIORITY CLAIMED UNDER SEC. 44(D) ON CANADA APPLICATION NO. 1008773, FILED 3-15-1999, REG. NO. 544072, DATED 4-24-2001, EXPIRES 4-24-2016.

CLASS 9—ELECTRICAL AND SCIENTIFIC APPARATUS

FOR AUDIOVISUAL PRE-RECORDED TAPES AND DISCS DIRECTED TO TEACHERS CONCERNING THE TEACHING OF MUSIC; AUDIOVISUAL PRE-RECORDED TAPES AND DISCS THE SUBJECT MATTER OF WHICH IS THE TEACHING AND LEARNING OF MUSIC (U.S. CLS. 21, 23, 26, 36 AND 38).

CLASS 16—PAPER GOODS AND PRINTED MATTER

FOR PRINTED PUBLICATIONS, NAMELY, BOOKS, BOOKLETS, PAMPHLETS, MANUALS, GUIDES, NEWSLETTERS, TEACHING AND INSTRUCTIONAL MATERIALS, AND EDUCATIONAL COURSE MATERIALS, ALL DIRECTED TO TEACHERS AND STUDENTS OF MUSIC; PRINTED SHEET MUSIC; MUSIC BOOKS (U.S. CLS. 2, 5, 22, 23, 29, 37, 38 AND 50).

CLASS 41—EDUCATION AND ENTERTAINMENT

FOR EDUCATIONAL SERVICES, NAMELY CONDUCTING CLASSES DEALING WITH MUSIC; PROVIDING EDUCATIONAL TRAINING TO TEACHERS OF MUSIC; PROVIDING EDUCATIONAL SUPPORT SERVICES TO TEACHERS OF MUSIC, NAMELY, THE DEVELOPMENT AND DISSEMINATION OF EDUCATIONAL MATERIALS IN THE FIELD OF MUSIC INSTRUCTION; EDUCATIONAL SERVICES, NAMELY TEACHING AND PROVIDING COURSES OF INSTRUCTION PERTAINING TO ALL ASPECTS OF MUSIC FOR BOTH STUDENTS AND TEACHERS OF MUSIC (U.S. CLS. 100, 101 AND 107).

SN 75-699,318. COVANCE INC., PRINCETON, NJ. BY ASSIGNMENT PROLIANCE PHARMACEUTICALS INC., MALVERN, PA. FILED 5-7-1999.

**PROLIANCE
PHARMACEUTICALS INC.**

NO CLAIM IS MADE TO THE EXCLUSIVE RIGHT TO USE "PHARMACEUTICALS INC.", APART FROM THE MARK AS SHOWN.

CLASS 35—ADVERTISING AND BUSINESS

FOR PROVIDING PROJECT MANAGEMENT SERVICES TO PHARMACEUTICAL COMPANIES IN THE FIELD OF PHARMACEUTICAL RESEARCH AND DEVELOPMENT (U.S. CLS. 100, 101 AND 102).

FIRST USE 5-30-1997; IN COMMERCE 5-30-1997.

CLASS 36—INSURANCE AND FINANCIAL

FOR FINANCIAL MANAGEMENT SERVICES TO PHARMACEUTICAL COMPANIES, NAMELY, PROVIDING FINANCING SERVICES TO PHARMACEUTICAL COMPANIES IN THE FIELD OF PHARMACEUTICAL RESEARCH AND DEVELOPMENT (U.S. CLS. 100, 101 AND 102).

FIRST USE 5-30-1997; IN COMMERCE 5-30-1997.

CLASS 42—SCIENTIFIC, COMPUTER AND LEGAL SERVICES

FOR PROVIDING PHARMACEUTICAL COMPANIES WITH CONTRACT RESEARCH IN THE FIELD OF PHARMACEUTICAL RESEARCH AND DEVELOPMENT (U.S. CLS. 100 AND 101).

FIRST USE 5-30-1997; IN COMMERCE 5-30-1997.

SN 75-701,759. NATURAL FORMULAS LIMITED, TORTOLA, BR. VIRGIN ISLANDS, FILED 5-10-1999.



NO CLAIM IS MADE TO THE EXCLUSIVE RIGHT TO USE "HEALTH FOODS", APART FROM THE MARK AS SHOWN.

CLASS 5—PHARMACEUTICALS

FOR VITAMINS AND MINERAL SUPPLEMENTS, AND A FULL SELECTION OF INDIVIDUAL VITAMINS, MIXED VITAMINS, ESSENTIAL FATTY ACIDS FOR USE AS NUTRITIONAL SUPPLEMENTS AND HERBAL SUPPLEMENTS, IN TABLET AND CAPSULE FORM (U.S. CLS. 6, 18, 44, 46, 51 AND 52).

CLASS 30—STAPLE FOODS

FOR TEA (U.S. CL. 46).

SN 75-703,788. 3SOFT GMBH, D-91058, ERLANGEN, FED REP GERMANY, FILED 5-12-1999.

3SOFT

OWNER OF FED REP GERMANY REG. NO. 39518574, DATED 3-6-1996, EXPIRES 5-31-2005.

CLASS 9—ELECTRICAL AND SCIENTIFIC APPARATUS

FOR COMPUTER SOFTWARE WHICH ALLOWS THE CONTROL AND MONITORING OF SAFETY CRITICAL APPLICATIONS IN EMBEDDED SYSTEMS IN THE FIELD OF IN-CAR COMPUTING, MEDICAL EQUIPMENT, INDUSTRIAL AUTOMATION (U.S. CLS. 21, 23, 26, 36 AND 38).

CLASS 42—SCIENTIFIC, COMPUTER AND LEGAL SERVICES

FOR DESIGN OF COMPUTER SOFTWARE FOR OTHERS WHICH IS USED IN EMBEDDED AND REAL TIME OPERATING SYSTEMS (U.S. CLS. 100 AND 101).

SN 75-713,573. DAWSON, MARTY, PORTLAND, OR. FILED 5-25-1999.

Cloud Productions

NO CLAIM IS MADE TO THE EXCLUSIVE RIGHT TO USE "PRODUCTIONS", APART FROM THE MARK AS SHOWN.

CLASS 9—ELECTRICAL AND SCIENTIFIC APPARATUS

FOR AUDIO CASSETTE TAPES, COMPACT DISCS AND VIDEO CASSETTE TAPES FOR TEACHING RELAXATION TECHNIQUES, MULTIMEDIA SOFTWARE RECORDED ON CD-ROM AND DVD FOR TEACHING RELAXATION TECHNIQUES, MOTION PICTURE FILMS FEATURING RELAXATION TECHNIQUES (U.S. CLS. 21, 23, 26, 36 AND 38).

CLASS 16—PAPER GOODS AND PRINTED MATTER

FOR SERIES OF NON-FICTION BOOKS, FEATURING RELAXATION TECHNIQUES (U.S. CLS. 2, 5, 22, 23, 29, 37, 38 AND 50).

CLASS 41—EDUCATION AND ENTERTAINMENT

FOR EDUCATIONAL SERVICES, NAMELY CLASSES, IN THE FIELD OF RELAXATION AND DISTRIBUTING CLASS MATERIALS IN CONNECTION THEREWITH; ONGOING TELEVISION SEGMENTS ABOUT RELAXATION TECHNIQUES; PROVIDING A GLOBAL COMPUTER NETWORK WEBSITE WHICH PROVIDES EDUCATIONAL INSTRUCTION IN RELAXATION TECHNIQUES (U.S. CLS. 100, 101 AND 107).

SN 75-737,837. RODALE INC., EMMAUS, PA. BY CHANGE OF NAME RODALE PRESS, INC., EMMAUS, PA. FILED 6-15-1999.

GUY GUIDE

NO CLAIM IS MADE TO THE EXCLUSIVE RIGHT TO USE "GUIDE", APART FROM THE MARK AS SHOWN.

CLASS 16—PAPER GOODS AND PRINTED MATTER

FOR PUBLICATIONS, NAMELY, MAGAZINES, BOOKS, BULLETINS AND NEWSLETTERS IN THE FIELDS OF HEALTH, FITNESS, DIET, EXERCISE, LIFESTYLE, TELECOMMUNICATIONS, E-COMMERCE, ELECTRONICS AND ENTERTAINMENT (U.S. CLS. 2, 5, 22, 23, 29, 37, 38 AND 50).

CLASS 35—ADVERTISING AND BUSINESS

FOR PROMOTING THE GOODS AND SERVICES OF OTHERS VIA AN INTERACTIVE WEB SITE ON THE WORLDWIDE WEB; AND ADVERTISING SERVICES, NAMELY PROVIDING ADVERTISING SPACE ON AN INTERACTIVE WEB SITE VIA THE WORLDWIDE WEB; AND BUSINESS INFORMATION IN THE FIELD OF E-COMMERCE PROVIDED ELECTRONICALLY VIA WEB SITE ON A MULTI-USER GLOBAL COMPUTER INFORMATION NETWORK (U.S. CLS. 100, 101 AND 102).

CLASS 41—EDUCATION AND ENTERTAINMENT

FOR LIFESTYLE ENTERTAINMENT INFORMATION IN THE FIELD OF ENTERTAINMENT PROVIDED ELECTRONICALLY VIA A WEB SITE ON A MULTI-USER GLOBAL COMPUTER INFORMATION NETWORK (U.S. CLS. 100, 101 AND 107).

CLASS 42—SCIENTIFIC, COMPUTER AND LEGAL SERVICES

FOR HEALTH, FITNESS, DIET, EXERCISE, AND LIFESTYLE INFORMATION PROVIDED ELECTRONICALLY VIA A WEB SITE ON A MULTI-USER GLOBAL COMPUTER INFORMATION NETWORK; AND COMPUTER SERVICES, NAMELY, PROVIDING ELECTRONIC MAGAZINES VIA THE WORLD WIDE WEB CONTAINING COLUMNS AND ARTICLES IN THE FIELDS OF HEALTH, FITNESS, DIET, EXERCISE, LIFESTYLE, TELECOMMUNICATIONS, E-COMMERCE, ELECTRONICS AND ENTERTAINMENT (U.S. CLS. 100 AND 101).

SN 75-738,739. MARTINA GEBHARDT NATURKOSMETIK GMBH, 86935 ROTT-PESSENHAUSEN, FED REP GERMANY, FILED 6-28-1999.

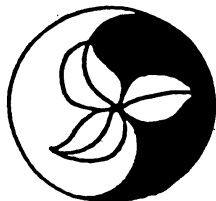

PRIORITY CLAIMED UNDER SEC. 44(D) ON FED REP GERMANY APPLICATION NO. 39902084.5, FILED 1-15-1999, REG. NO. 39902084, DATED 7-19-1999, EXPIRES 1-31-2009.

THE MARK CONSISTS OF A STYLIZED VERSION OF THE YIN AND YANG SYMBOL IN THE BACKGROUND AND A BRANCH IN THE FRONT.

CLASS 3—COSMETICS AND CLEANING PREPARATIONS

FOR BLEACHING PREPARATIONS FOR LAUNDRY AND HAIR, SOAPS, NAMELY, SKIN AND DEODORANT SOAPS, PERFUMERY, ESSENTIAL OILS FOR PERSONAL USE, SCENTED AND UNSCENTED COSMETIC PREPARATIONS, NAMELY, SKIN LOTION, FACIAL MAKE-UP, SKIN POWDER, BLUSH, MASCARA, EYE SHADOW, LIPSTICKS, AROMA THERAPY OILS, HAIR OILS, FOR PERSONAL USE, NAMELY, HAIR MOUSSE, HAIR GEL AND HAIR SPRAY, HAIR LOTION, DENTRIFICES, ANTIPERSPIRANTS, COSMETIC BATH WATER ADDITIVES, NAMELY SCENTED AND UNSCENTED BATH OIL, BATH PEARLS, BATH POWDER, BATH GEL, BATH FOAM, BATH CRYSTALS AND BATH BEADS, AROMATIC SUBSTANCES FOR LAUNDRY, NAMELY, DETERGENT, DEPILATORY PREPARATIONS, NAMELY, DEPILATORY WAX, SHAMPOOS, PERFUMERY OILS, POMADES FOR COSMETIC PURPOSES, CLEANSING MILK FOR BODY AND BEAUTY CARE, CLEANSING OILS, NON-MEDICATED BATH SALTS, BEAUTY MASKS AND SUNSCREEN PREPARATIONS (U.S. CLS. 1, 4, 6, 50, 51 AND 52).

CLASS 29—MEATS AND PROCESSED FOODS

FOR DIETARY BEVERAGES, NAMELY, VEGETABLE-BASED FOOD BEVERAGES, DIETARY FOODS AND FOODSTUFF, NAMELY, MEAT, FISH, POULTRY AND GAME, MEAT EXTRACTS, PRESERVED, DRIED AND COOKED FRUIT AND VEGETABLES, JELLIES, JAMS, DRIED, CANNED AND BOTTLED FRUIT, EGGS, DAIRY PRODUCTS, EXCLUDING ICE CREAM, ICE MILK AND FROZEN YOGURT, EDIBLE OILS AND FATS (U.S. CL. 46).

CLASS 39—TRANSPORTATION AND STORAGE

FOR TRANSPORT BY AIR, RAIL AND TRUCK AND STORAGE OF COSMETICS AND FOODSTUFF (U.S. CLS. 100 AND 105).

SN 75-741,212. EVER AMERICA CORP., WATERLOO ONTARIO, CANADA, BY CHANGE OF NAME JPH INTERNATIONAL INC., TORONTO, ONTARIO, CANADA, FILED 7-1-1999.



PRIORITY CLAIMED UNDER SEC. 44(D) ON CANADA APPLICATION NO. 1,001,172, FILED 1-5-1999, REG. NO. TMA534323, DATED 10-11-2000, EXPIRES 10-11-2015.

CLASS 9—ELECTRICAL AND SCIENTIFIC APPARATUS

FOR INFORMATION MANAGEMENT SOFTWARE FOR CUSTOMER SERVICE SYSTEMS, BILLING AND ACCOUNTING, FOR USE BY GOVERNMENT AND UTILITIES, AND USER DOCUMENTATION SOLD THEREWITH (U.S. CLS. 21, 23, 26, 36 AND 38).

CLASS 41—EDUCATION AND ENTERTAINMENT

FOR EDUCATIONAL SERVICES, NAMELY, CONDUCTING SEMINARS AND TRAINING IN THE FIELD OF INFORMATION MANAGEMENT SOFTWARE (U.S. CLS. 100, 101 AND 107).

CLASS 42—SCIENTIFIC, COMPUTER AND LEGAL SERVICES

FOR CONSULTING SERVICES IN THE FIELD OF INFORMATION MANAGEMENT SOFTWARE (U.S. CLS. 100 AND 101).

SN 75-743,898. EMAP PLC., CAMBRIDSESHIRE PE1 2RF, UNITED KINGDOM, FILED 7-6-1999.

EMAP

OWNER OF UNITED KINGDOM REG. NO. 2160901, DATED 3-5-1999, EXPIRES 3-13-2008.

OWNER OF UNITED KINGDOM REG. NO. 1464359, DATED 6-26-1992, EXPIRES 5-16-2008.

OWNER OF UNITED KINGDOM REG. NO. 1448244, DATED 12-20-1991, EXPIRES 11-23-2007.

OWNER OF UNITED KINGDOM REG. NO. 1448243, DATED 6-12-1992, EXPIRES 11-23-2007.

OWNER OF UNITED KINGDOM REG. NO. 1448242, DATED 5-8-1992, EXPIRES 11-23-2007.

CLASS 9—ELECTRICAL AND SCIENTIFIC APPARATUS

FOR COMPUTER SOFTWARE AND COMPUTER PROGRAMS, USED TO SUPPLY INFORMATION VIA ON-LINE COMMUNICATIONS NETWORK RELATING TO LIFESTYLE INFORMATION DIRECTED TO BOTH MEN AND WOMEN, MUSIC, FINANCE AND INSURANCE, BUSINESS AND RETAIL SERVICES, CARS AND MOTORCYCLES, FASHION, MEDICINE AND NURSING, EDUCATION, ARCHITECTURE, CIVIL ENGINEERING, FILM, TELEVISION AND CINEMA, BROADCASTING, AND LOCAL GOVERNMENT; PRE-RECORDED CD-ROMS, CD-IS, COMPUTER DISKS AND MAGNETIC TAPE FEATURING DATABASES IN THE FIELDS OF ENTERTAINMENT AND RECREATION DIRECTED TO MEN AND WOMEN, MUSIC, FINANCE AND INSURANCE, BUSINESS AND RETAIL SERVICES, CARS AND MOTORCYCLES, FASHION, MEDICINE AND NURSING, EDUCATION, ARCHITECTURE, CIVIL ENGINEERING, FILM, TELEVISION AND CINEMA, BROADCASTING, AND LOCAL GOVERNMENT; AUDIO, VISUAL, AND/OR AUDIO-VISUAL RECORDINGS ON CD-ROMS, CD-IS, COMPUTER DISKS AND MAGNETIC TAPE IN THE FIELDS OF ENTERTAINMENT AND RECREATION DIRECTED TO MEN AND WOMEN, MUSIC, FINANCE AND INSURANCE, BUSINESS AND RETAIL SERVICES, CARS AND MOTORCYCLES, FASHION, MEDICINE AND NURSING, EDUCATION, ARCHITECTURE, CIVIL ENGINEERING, FILM, TELEVISION AND CINEMA, BROADCASTING, AND LOCAL GOVERNMENT (U.S. CLS. 21, 23, 26, 36 AND 38).

CLASS 35—ADVERTISING AND BUSINESS

FOR DISSEMINATION OF ADVERTISING AND PROMOTIONAL PRODUCT INFORMATION FOR OTHERS VIA AN ON-LINE ELECTRONIC COMMUNICATIONS NETWORK; ON-LINE BUSINESS SERVICES IN THE NATURE OF PROVIDING BUSINESS MARKETING CONSULTING SERVICES; BUSINESS INFORMATION SERVICES, NAMELY PROVIDING BUSINESS MARKETING CONSULTING SERVICES; PROVIDING BUSINESS AND COMMERCIAL INFORMATION PERTAINING TO TRADE INFORMATION, PRODUCT INFORMATION, RESEARCH AND COMPETITOR INTELLIGENCE, AND STATISTICAL INFORMATION RELATING TO ENTERTAINMENT AND RECREATION DIRECTED TO MEN AND WOMEN, MUSIC, FINANCE AND INSURANCE, BUSINESS AND RETAIL SERVICES, CARS AND MOTORCYCLES, FASHION, MEDICINE AND NURSING, EDUCATION, ARCHITECTURE, CIVIL ENGINEERING, FILM, TELEVISION AND CINEMA, BROADCASTING, AND LOCAL GOVERNMENT; PREPARING ADVERTISEMENTS FOR OTHERS AND PLACING ON-LINE ADVERTISEMENTS FOR OTHERS; AND ORGANIZATION OF TRADE EXHIBITIONS AND OF BUSINESS CONFERENCES IN RELATION TO BUSINESS AND RETAIL SERVICES, NAMELY, HEALTH AND BEAUTY SERVICES, THE FASHION BUSINESS, MEDICINE AND NURSING SERVICES, THE ENTERTAINMENT INDUSTRY NAMELY MUSIC, FILMS, THE CINEMA, THE THEATER, VIDEOS, RADIO AND TELEVISION BROADCASTING, AND PRODUCTION AND SYNDICATION OF TELEVISION AND RADIO ENTERTAINMENT, LOCAL GOVERNMENT, EDUCATION, ARCHITECTURE AND CIVIL ENGINEERING, FINANCIAL SERVICES, THE AUTOMOTIVE INDUSTRY, TRAVEL AND TOURISM SERVICES AND SPORTS AND RECREATIONAL SERVICES; DATA PROCESSING, NAMELY, UPDATING INFORMATION ON COMPUTER DATABASES (U.S. CLS. 100, 101 AND 102).

CLASS 38—COMMUNICATION

FOR RADIO, TELEVISION AND CABLE BROADCASTING SERVICES (U.S. CLS. 100, 101 AND 104).

CLASS 41—EDUCATION AND ENTERTAINMENT

FOR PUBLICATION OF BOOKS, MAGAZINES AND PERIODICALS; PROVIDING ON-LINE INFORMATION IN THE FIELD OF ENTERTAINMENT AND RECREATION DIRECTED TO MEN AND WOMEN, MUSIC, BUSINESS AND RETAIL SERVICES, CARS AND MOTORCYCLES, FASHION, MEDICINE AND NURSING, EDUCATION, ARCHITECTURE, CIVIL ENGINEERING, FILM, TELEVISION AND CINEMA, BROADCASTING, AND LOCAL GOVERNMENT; RADIO ENTERTAINMENT PRODUCTION AND TELEVISION SHOW PRODUCTION (U.S. CLS. 100, 101 AND 107).

CLASS 42—SCIENTIFIC, COMPUTER AND LEGAL SERVICES

FOR COMPUTER SERVICES, NAMELY, PROVIDING AN ON-LINE COMPUTER DATABASE FEATURING GENERAL AND LOCAL NEWS, INFORMATION OF INTEREST TO SPECIFIC GEOGRAPHIC AREAS, ENTERTAINMENT AND RECREATION DIRECTED TO MEN AND WOMEN, MUSIC, BUSINESS AND RETAIL SERVICES, CARS AND MOTORCYCLES, FASHION, MEDICINE AND NURSING, EDUCATION, ARCHITECTURE, CIVIL ENGINEERING, FILM, TELEVISION AND CINEMA, BROADCASTING, AND LOCAL GOVERNMENT; COMPUTER SERVICES, NAMELY, PROVIDING ON-LINE BOOKS, MAGAZINES AND PERIODICALS IN

THE FIELDS OF ENTERTAINMENT AND RECREATION DIRECTED TO MEN AND WOMEN, MUSIC, FINANCE AND INSURANCE, BUSINESS AND RETAIL SERVICES, CARS AND MOTORCYCLES, FASHION, MEDICINE AND NURSING, EDUCATION, ARCHITECTURE, CIVIL ENGINEERING, FILM, TELEVISION AND CINEMA, BROADCASTING, AND LOCAL GOVERNMENT; ARRANGING FOR EXHIBITION AND CONFERENCE FACILITIES FOR OTHERS; LEASING, RENTAL AND HIRE OF COMPUTER HARDWARE, DATABASES, COMPUTER SOFTWARE AND COMPUTER PROGRAMS OF OTHERS (U.S. CLS. 100 AND 101).

SN 75-749,889. SENSTAR-STELLAR CORPORATION, KANATA, ONTARIO, FILED 7-14-1999.



SN 75-746,052. APEX INTERNATIONAL, 75017 PARIS, FRANCE, FILED 7-9-1999.



PRIORITY CLAIMED UNDER SEC. 44(D) ON ERPNTY TM OFC APPLICATION NO. 001199884, FILED 5-25-1999, REG. NO. 1199884, DATED 7-26-2000, EXPIRES 7-26-2010.

NO CLAIM IS MADE TO THE EXCLUSIVE RIGHT TO USE "INTERNATIONAL", APART FROM THE MARK AS SHOWN.

CLASS 12—VEHICLES

FOR APPARATUS FOR LOCOMOTION BY AIR, NAMELY AIRPLANES (U.S. CLS. 19, 21, 23, 31, 35 AND 44).

CLASS 37—CONSTRUCTION AND REPAIR

FOR AIRCRAFT REPAIR AND MAINTENANCE (U.S. CLS. 100, 103 AND 106).

SN 75-746,966. INEA CORPORATION, TORONTO, ONTARIO M5B 2E7, CANADA, FILED 7-9-1999.

INEA ADVANTAGE

PRIORITY CLAIMED UNDER SEC. 44(D) ON CANADA APPLICATION NO. 1019139, FILED 6-16-1999, REG. NO. 542739, DATED 3-20-2001, EXPIRES 3-20-2016.
OWNER OF U.S. REG. NO. 2,229,305.

CLASS 9—ELECTRICAL AND SCIENTIFIC APPARATUS

FOR COMPUTER SOFTWARE FOR FINANCIAL ANALYSIS AND REPORTING, FINANCIAL PLANNING AND FORECASTING (U.S. CLS. 21, 23, 26, 36 AND 38).

CLASS 42—SCIENTIFIC, COMPUTER AND LEGAL SERVICES

FOR UPDATING OF COMPUTER SOFTWARE; COMPUTER SOFTWARE DESIGN FOR OTHERS; AND MAINTENANCE OF COMPUTER SOFTWARE (U.S. CLS. 100 AND 101).

PRIORITY CLAIMED UNDER SEC. 44(D) ON CANADA APPLICATION NO. 1,002,091, FILED 1-15-1999, REG. NO. TMA533872, DATED 9-29-2000, EXPIRES 9-29-2015.

CLASS 9—ELECTRICAL AND SCIENTIFIC APPARATUS

FOR INTRUSION DETECTORS, NAMELY BURIED OR AERIAL CABLE SENSORS, MICROPHONIC CABLE DISTURBANCE SENSORS, FENCE MOUNTED DETECTION SENSORS, ELECTROSTATIC FIELD DISTURBANCE SENSORS, VIDEO MOTION SENSORS, MICROWAVE SENSORS, NETWORKING AND DISPLAY/CONTROL DEVICES; PARTS FOR INTRUSION DETECTION SYSTEMS, NAMELY, SENSOR CABLES, CONNECTORS, TRANSPONDERS, TRANSDUCERS, TRANSCEIVERS, MULTIPLEX ALARM MONITORS AND PROCESSORS, KEYPADS, KEYBOARDS, DISPLAY MONITORS, VIDEO DISPLAY TERMINALS, SIGNAL PROCESSORS, CENTRAL PROCESSING UNITS, CONTROL SWITCHES, POWER SUPPLIES, LIGHTNING ARRESTORS, WEATHER STATION SENSORS, ENCRYPTION SYSTEMS, INFRARED ILLUMINATORS, DISPLAY PANELS (U.S. CLS. 21, 23, 26, 36 AND 38).

CLASS 42—SCIENTIFIC, COMPUTER AND LEGAL SERVICES

FOR DESIGN OF INTRUSION DETECTION SYSTEMS (U.S. CLS. 100 AND 101).

SN 75-754,913. PNC FINANCIAL SERVICES GROUP, INC., THE, PITTSBURGH, PA. BY CHANGE OF NAME PNC BANK CORP., PITTSBURGH, PA. FILED 7-20-1999.

PNC E-NABLED

OWNER OF U.S. REG. NOS. 2,062,937, 2,248,590 AND OTHERS.

NO CLAIM IS MADE TO THE EXCLUSIVE RIGHT TO USE "E-NABLED", APART FROM THE MARK AS SHOWN.

CLASS 36—INSURANCE AND FINANCIAL

FOR BANKING SERVICES (U.S. CLS. 100, 101 AND 102).

CLASS 42—SCIENTIFIC, COMPUTER AND LEGAL SERVICES

FOR COMPUTER CONSULTATION SERVICES, NAMELY CONSULTATION SERVICES IN THE FIELDS OF DESIGN, IMPLEMENTATION, AND USE OF COMPUTER HARDWARE AND SOFTWARE SYSTEMS AND WEBSITES FOR OTHERS; COMPUTER SERVICES, NAMELY, DESIGNING SOFTWARE SYSTEMS FOR OTHERS AND DESIGNING AND IMPLEMENTING WEBSITES FOR OTHERS IN THE FIELD OF E-COMMERCE (U.S. CLS. 100 AND 101).

SN 75-757,786. FILGATE, LEONARD, CARMEL-BY-THE-SEA, CA. FILED 6-30-1999.

RIP SQUEAK**CLASS 9—ELECTRICAL AND SCIENTIFIC APPARATUS**

FOR MOTION PICTURES, SLIDES, FILM STRIPS, AUDIO TAPES, VIDEO TAPES, AND ELECTRONIC DISCS CONTAINING CARTOON ANIMATION AND PRE-RECORDED SOUNDTRACKS; COMPUTER SCREEN SAVER PROGRAMS, COMPUTER MOUSE PADS, AND REFRIGERATOR MAGNETS (U.S. CLS. 21, 23, 26, 36 AND 38).

CLASS 16—PAPER GOODS AND PRINTED MATTER

FOR PRINTED MATERIAL, NAMELY, CHILDREN'S PICTURE BOOKS, ART BOOKS, AND POSTCARD BOOKS; POSTERS; PAPER GOODS, NAMELY, WRAPPING PAPER, ORIGINAL ARTWORK, NAMELY, ART PRINTS, ART REPRODUCTIONS, AND LITHOGRAPHS; PAPER NAME BADGES; RUBBER STAMPS, PRE-PRINTED AND PREPAID TELEPHONE CALLING CARDS, NOT MAGNETICALLY ENCODED; BOOK MARKS; GIFT WRAP; GIFT TAGS; GIFT BOXES; GREETING CARDS; POSTCARDS; CALENDARS; SCHOOL AND OFFICE SUPPLIES, NAMELY, ERASERS, DRAFTING AND DRAWING RULERS, PENCILS, PENS, MARKERS, GLUE FOR STATIONERY OR HOUSEHOLD PURPOSES, CLIP BOARDS, STATIONERY, ORGANIZERS FOR STATIONERY USE, PENCIL CASES; PENCIL SHARPENERS, STATIONERY PORTFOLIOS, DESK PADS AND STATIONERY SETS COMPRISING STATIONERY PAPER AND ENVELOPES (U.S. CLS. 2, 5, 22, 23, 29, 37, 38 AND 50).

CLASS 18—LEATHER GOODS

FOR TOTE BAGS (U.S. CLS. 1, 2, 3, 22 AND 41).

CLASS 21—HOUSEWARES AND GLASS

FOR HOUSEWARES, NAMELY, MUGS, PLATES, BOWLS, LUNCH BOXES, THERMAL INSULATED CONTAINERS FOR FOOD AND BEVERAGE, DRINKING GLASSES AND CUPS, PITCHERS, FIGURES, FIGURINES, SCULPTURES, ORNAMENTS, AND STATUETTES MADE OF TERRA COTTA, EARTHENWARE, GLASS, PORCELAIN, RESIN, CRYSTAL AND CHINA; COMMEMORATIVE PLATES; ALL PURPOSE PORTABLE HOUSEHOLD CONTAINERS; AND PAPER PLATES, BOWLS, DRINKING GLASSES AND CUPS (U.S. CLS. 2, 13, 23, 29, 30, 33, 40 AND 50).

CLASS 24—FABRICS

FOR PRINTED CLOTH, NAMELY, FOR BED, BATH, TABLE, AND HOUSEHOLD LINENS; CLOTH DECORATIVE ORNAMENTS; AND POTPOURRI BAGS (U.S. CLS. 42 AND 50).

CLASS 25—CLOTHING

FOR MEN'S, WOMEN'S, CHILDREN'S, AND BABIES' CLOTHING, NAMELY, UNDERWEAR, RAINWEAR, SLEEPWEAR, HOSIERY, FOOTWEAR, BELTS, HEAD WEAR, BATHROBES, T-SHIRTS, SWEATERS, SPORTSWEAR, GLOVES, MITTENS, PAJAMAS, SWIM WEAR, TIES, SCARVES, MASQUERADE COSTUMES AND MASKS SOLD IN CONNECTION THEREWITH (U.S. CLS. 22 AND 39).

CLASS 28—TOYS AND SPORTING GOODS

FOR TOYS, GAMES AND PLAYTHINGS, NAMELY, JIGSAW PUZZLES, TOY ACTION FIGURES AND ACCESSORIES THEREFOR, PLUSH TOYS; CHRISTMAS TREE ORNAMENTS (U.S. CLS. 22, 23, 38 AND 50).

SN 75-766,677. MERCY MEDICAL CENTER, CEDAR RAPIDS, IOWA, CEDAR RAPIDS, IA. FILED 8-3-1999.

THE MERCY TOUCH**CLASS 16—PAPER GOODS AND PRINTED MATTER**

FOR MAGAZINES ABOUT HEALTH AND FITNESS (U.S. CLS. 2, 5, 22, 23, 29, 37, 38 AND 50).
FIRST USE 3-31-1999; IN COMMERCE 3-31-1999.

CLASS 42—SCIENTIFIC, COMPUTER AND LEGAL SERVICES

FOR HOSPITALS, CONVALESCENT AND EXTENDED CARE FACILITIES, INPATIENT AND OUTPATIENT HEALTH CARE, MEDICAL CLINICS, PHYSICIAN SERVICES, HOME HEALTH CARE SERVICES, PHYSICAL THERAPY SERVICES, NURSING SERVICES, HOSPICE CARE SERVICES, HEALTH COUNSELING, TREATMENT OF DRUG AND ALCOHOL ADDICTED PATIENTS, PHYSICAL FITNESS CONSULTATION CENTERS, RENTAL OF HEALTH CARE EQUIPMENT AND SUPPLIES (U.S. CLS. 100 AND 101).
FIRST USE 6-1-1998; IN COMMERCE 4-25-1995.

SN 75-775,358. TREGA BIOSCIENCES, INC., SAN DIEGO, CA. FILED 9-8-1999.

EADME**CLASS 9—ELECTRICAL AND SCIENTIFIC APPARATUS**

FOR COMPUTER SOFTWARE NAMELY, SOFTWARE FOR PREDICTING THE PHARMACOKINETIC PROPERTIES OF DRUG COMPOUNDS; COMPUTER HARDWARE (U.S. CLS. 21, 23, 26, 36 AND 38).

CLASS 42—SCIENTIFIC, COMPUTER AND LEGAL SERVICES

FOR SCIENTIFIC AND INDUSTRIAL RESEARCH IN THE FIELD OF PHARMACEUTICALS, BIOTECHNOLOGY, AGRICULTURE, AND LIFE SCIENCES (U.S. CLS. 100 AND 101).

SN 75-778,294. LOS ANGELES POLICE REVOLVER AND ATHLETIC CLUB, INC., LOS ANGELES, CA. FILED 8-17-1999.

LOS ANGELES POLICE REVOLVER AND ATHLETIC CLUB

NO CLAIM IS MADE TO THE EXCLUSIVE RIGHT TO USE "POLICE REVOLVER AND ATHLETIC CLUB", APART FROM THE MARK AS SHOWN.

SEC. 2(F) AS TO "LOS ANGELES".

CLASS 25—CLOTHING

FOR CLOTHING, HEADWEAR AND FOOTWEAR, NAMELY POLICE AND PUBLIC SAFETY UNIFORMS, VESTS, JACKETS, COATS, FOUL WEATHER GEAR, RAINCOATS, OVERCOATS, GLOVES, GYM SUITS, JERSEYS, SOCKS, T-SHIRTS, SHIRTS, SHORTS, PANTS, SWEAT SUITS, TIES, SWIMWEAR, TROUSERS, SWEATERS, PULLOVERS, RAINCOATS, BOOTS, SHOES, BELTS, CAPS, SUN VISORS, AND HEADBANDS (U.S. CLS. 22 AND 39).

FIRST USE 0-0-1975; IN COMMERCE 0-0-1978.

CLASS 41—EDUCATION AND ENTERTAINMENT

FOR ARRANGING AND CONDUCTING ATHLETIC COMPETITIONS, POLICE EDUCATIONAL CONFERENCES, AND COMPETITIONS IN THE FIELD OF MARKSMANSHIP, THE DEVELOPMENT AND DISSEMINATION OF EDUCATIONAL MATERIALS IN THE FIELD OF POLICE TRAINING AND MARKSMANSHIP, PROVIDING FACILITIES FOR RECREATION ACTIVITIES, GUN FIRING RANGES, AND PHYSICAL FITNESS; PHYSICAL FITNESS AND TRAINING CLUB FOR MEMBERS OF LOS ANGELES POLICE DEPARTMENT FEATURING POLICE TRAINING AND FITNESS (U.S. CLS. 100, 101 AND 107).

FIRST USE 11-10-1969; IN COMMERCE 9-0-1986.

SN 75-785,727. ROSS, RENAE L., SANTA MONICA, CA. FILED 8-26-1999.

PEOPLEPORT

CLASS 38—COMMUNICATION

FOR TELECOMMUNICATIONS SERVICES, NAMELY, PROVIDING ELECTRONIC TRANSMISSION OF DATA OVER LOCAL OR GLOBAL COMPUTER NETWORKS (U.S. CLS. 100, 101 AND 104).

CLASS 42—SCIENTIFIC, COMPUTER AND LEGAL SERVICES

FOR PROVIDING AN ON-LINE ELECTRONIC DATABASE ON GLOBAL COMPUTER NETWORKS IN THE FIELD OF BIOGRAPHICAL INFORMATION (U.S. CLS. 100 AND 101).

SN 75-790,783. ICG RESEARCH INCORPORATED, TORONTO, ONTARIO, CANADA, FILED 9-3-1999.

PartnerSERVER

PRIORITY CLAIMED UNDER SEC. 44(D) ON CANADA APPLICATION NO. 1009483, FILED 3-23-1999, REG. NO. TMA547056, DATED 6-22-2001, EXPIRES 6-22-2016.

CLASS 9—ELECTRICAL AND SCIENTIFIC APPARATUS

FOR (BASED ON 44(E) (BASED ON USE IN COMMERCE) SOFTWARE, NAMELY, COST RECOVERY AND EXPENSE MANAGEMENT SOFTWARE TO TRACK AND RECORD BILLABLE USAGE ON OFFICE EQUIPMENT SUCH AS PHOTOCOPIERS, FAX MACHINES, POSTAGE METERS, TELEPHONES AND PRINTERS (U.S. CLS. 21, 23, 26, 36 AND 38).

FIRST USE 10-0-1997; IN COMMERCE 10-0-1997.

CLASS 42—SCIENTIFIC, COMPUTER AND LEGAL SERVICES

FOR (BASED ON 44(E) COMPUTER SOFTWARE DESIGN FOR OTHERS IN THE FIELD OF COST RECOVERY AND EXPENSE MANAGEMENT SOFTWARE FOR PHOTOCOPIERS, FAX MACHINES, POSTAGE METERS, TELEPHONES AND PRINTERS (U.S. CLS. 100 AND 101).

SN 75-801,952. PIVOT INTERNATIONAL, INC., LENEXA, KS. FILED 9-20-1999.



OWNER OF U.S. REG. NOS. 2,016,377 AND 2,139,185.
NO CLAIM IS MADE TO THE EXCLUSIVE RIGHT TO USE "INTERNATIONAL", APART FROM THE MARK AS SHOWN.

CLASS 9—ELECTRICAL AND SCIENTIFIC APPARATUS

FOR PERSONAL SECURITY ALARMS; ELECTRONIC CONTROLLERS FOR COMMERCIAL AND DOMESTIC FACILITIES; PRINTED CIRCUIT BOARDS (U.S. CLS. 21, 23, 26, 36 AND 38).

CLASS 28—TOYS AND SPORTING GOODS

FOR PLASTIC MOLDED PARTS, NAMELY, MONITOR AND CONTROLLER HOUSINGS FOR FITNESS PRODUCTS (U.S. CLS. 22, 23, 38 AND 50).

CLASS 40—MATERIAL TREATMENT

FOR CUSTOM MANUFACTURE OF ELECTRONIC EQUIPMENT FOR OTHERS; CUSTOMER MANUFACTURE FOR OTHERS OF FITNESS PRODUCTS, MOTOR CONTROLLERS FOR EXERCISE EQUIPMENT, AND PULSE MONITORING DEVICES (U.S. CLS. 100, 103 AND 106).

CLASS 42—SCIENTIFIC, COMPUTER AND LEGAL SERVICES

FOR DESIGN AND DEVELOPMENT OF ELECTRONIC EQUIPMENT FOR OTHERS; DESIGN AND DEVELOPMENT FOR OTHERS OF FITNESS PRODUCTS, MOTOR CONTROLLERS FOR EXERCISE EQUIPMENT, AND PULSE MONITORING DEVICES (U.S. CLS. 100 AND 101).

SN 75-807,277. SALT LAKE ORGANIZING COMMITTEE FOR THE OLYMPIC WINTER GAMES OF 2002, SALT LAKE CITY, UT. FILED 9-23-1999.

POWDER**CLASS 14—JEWELRY**

FOR JEWELRY; PINS BEING JEWELRY; BELT BUCKLES OF PRECIOUS METAL; TIE CLIPS; CHARMS; PENDANTS; NECKLACES; EARRINGS; MEDALLIONS; PRECIOUS GEMSTONES; WATCHES; CHRONOGRAPHS FOR USE AS WATCHES; STOP WATCHES; POCKET WATCHES (U.S. CLS. 2, 27, 28 AND 50).

CLASS 25—CLOTHING

FOR ATHLETIC FOOTWEAR; ATHLETIC SHOES; ATHLETIC UNIFORMS; LEOTARDS; TIGHTS; JACKETS; SKIRTS; SHIRTS; JEANS; SWIM WEAR; STOCKINGS; OVERALLS; COVERALLS; DUNGAREES; T-SHIRTS; SWEAT SHIRTS; INNER SOLES AND HEELS ALL FOR FOOTWEAR; HEAD WEAR; HATS; HEAD BANDS; SOCKS; WRIST BANDS; GLOVES; SCARVES; SHAWLS; LEG WARMERS; AFTER SKI BOOTS; SKI BIBS; SKI BOOTS; SKI GLOVES; SKI PANTS; SKI MASKS; SKI SUITS; SKI WEAR; DANCE WEAR, NAMELY, LEOTARDS AND LEGGINGS; BATHING SUITS; BATHING SARONGS; BLAZERS; ANORAKS; PARKAS; JOGGING SUITS AND TRACK SUITS; FOOTWEAR; CLOTHING BELTS; NECKTIES; SUSPENDERS; BANDANAS; BATHROBES; PLAY SUITS; SHORTS; MATERNITY WEAR, NAMELY, DRESSES, BLOUSES AND PANTS; HOSIERY; RAINWEAR; EVENING GOWNS; TUXEDOS; SUN VISORS (U.S. CLS. 22 AND 39).

CLASS 41—EDUCATION AND ENTERTAINMENT

FOR ARRANGING AND CONDUCTING LARGE SPORTING EVENTS AND ENTERTAINMENT IN THE NATURE OF INTERNATIONAL SPORT GAMES; PUBLICATION OF BOOKS, NEWSPAPERS AND MAGAZINES; CONDUCTING ENTERTAINMENT EXHIBITIONS IN THE NATURE OF PARADES; ORGANIZING SPORT COMPETITIONS AND GAMES; ORGANIZING CULTURAL EVENTS, NAMELY, MUSICAL, THEATRICAL AND DANCE EXHIBITIONS, ART EXHIBITS AND CRAFT EXHIBITIONS; ENTERTAINMENT SERVICES, NAMELY, THE PRODUCTION AND DISTRIBUTION OF RADIO AND TELEVISION PROGRAMS IN THE FIELD OF INTERNATIONAL ATHLETIC EVENTS AND SUBJECT MATTER RELATED THERETO; MOTION PICTURE FILM PRODUCTION SERVICES (U.S. CLS. 100, 101 AND 107).

SN 75-807,482. API-AR INTERNATIONAL, 1180 BRUSSELS, BELGIUM, FILED 9-24-1999.

KILVIR

PRIORITY CLAIMED UNDER SEC. 44(D) ON BENELUX APPLICATION NO. 935223, FILED 3-25-1999, REG. NO. 0649430, DATED 3-25-1999, EXPIRES 3-25-2009.

CLASS 3—COSMETICS AND CLEANING PREPARATIONS

FOR COSMETICS, NAMELY, SOAPS, PERFUMES, ESSENTIAL OILS FOR PERSONAL USE, CREAMS FOR SKINS SENSITIVE TO VIRUSES (U.S. CLS. 1, 4, 6, 50, 51 AND 52).

CLASS 5—PHARMACEUTICALS

FOR MEDICATED SKIN CARE PREPARATIONS FOR THE TREATMENT OF VIRUSES, NAMELY, CREAMS, EMULSIONS, ESSENCES, ESSENTIAL OILS, OINTMENTS, GELS, CAPSULES, HANDWASHES, SUPPOSITORIES, LOTIONS, ELIXIRS, SPRAYS, CATAPLASMS, POWDERS, EMOLLIENTS, MOISTURIZERS, AND MASKS; DIETETIC SUBSTANCES, NAMELY, FOOD SUPPLEMENTS, HERBAL SUPPLEMENTS, MINERAL SUPPLEMENTS, NUTRITIONAL SUPPLEMENTS, DIETARY SUPPLEMENTS; BEE HIVE PRODUCTS, NAMELY, BEE POLLEN, HONEY, BEE BREAD, PROPOLIS, ROYAL JELLY, BEE VENOM, BEESWAX, AND BEE LARVAE, ALL ADAPTED FOR MEDICAL USE FOR THE TREATMENT OF VIRUSES, IN THE FORM OF CAPSULES, PILLS, TABLETS, GRANULES, POWDERS, DROPS, PORTIONS, SYRUPS, TINCTURES, AND ELIXIRS; MATERIALS FOR DRESSING WOUNDS AND BURNS INFECTED BY VIRUSES; ALL PURPOSE DISINFECTANTS (U.S. CLS. 6, 18, 44, 46, 51 AND 52).

SN 75-811,351. NETJEWELS.COM INC., NORTH YORK, ON M3J 2X7, CANADA, FILED 9-29-1999.

SEC. 2(F).

CLASS 14—JEWELRY

FOR JEWELRY MADE OF PRECIOUS, SEMI-PRECIOUS, SIMULATED OR SYNTHETIC STONES AND JEWELRY MADE OF PRECIOUS AND NON-PRECIOUS METALS, WITH AND WITHOUT PRECIOUS, SEMI-PRECIOUS, SIMULATED OR SYNTHETIC STONES, NAMELY, RINGS, EARRINGS, PENDANTS, BROOCHES, ORNAMENTAL LAPEL PINS, BRACELETS, ANKLE BRACELETS, CHAINS, NECKLACES, CUFF LINKS, TIE TACKS, AND TIE CLIPS, AND WATCHES (U.S. CLS. 2, 27, 28 AND 50).

FIRST USE 8-7-1999; IN COMMERCE 8-7-1999.

CLASS 35—ADVERTISING AND BUSINESS

FOR COMPUTERIZED ON-LINE RETAIL SERVICES IN THE FIELD OF JEWELRY; DISSEMINATION OF ADVERTISING FOR OTHERS VIA ON-LINE ELECTRONIC COMMUNICATIONS NETWORK (U.S. CLS. 100, 101 AND 102).

FIRST USE 8-7-1999; IN COMMERCE 8-7-1999.

SN 75-815,748. SONICAGENT.COM, INC., DEL MAR, CA.
FILED 10-5-1999.

SONICAGENT.COM

CLASS 9—ELECTRICAL AND SCIENTIFIC APPARATUS

FOR COMPUTER SOFTWARE TO MANAGE, SORT AND ORGANIZE DIGITAL MUSIC COLLECTIONS VIA GLOBAL COMPUTER NETWORKS (U.S. CLS. 21, 23, 26, 36 AND 38).

CLASS 35—ADVERTISING AND BUSINESS

FOR ONLINE RETAIL STORE SERVICES FEATURING MEDIA RELATED PRODUCTS, NAMELY, MUSICAL SOUND RECORDINGS, VIDEO RECORDINGS, DIGITAL MEDIA DOWNLOADS, AUDIO RECORDINGS AND MEDIA RECOMMENDATIONS (U.S. CLS. 100, 101 AND 102).

SN 75-818,282. UPAQ AG, 8008 ZURICH, SWITZERLAND,
FILED 10-8-1999.



PRIORITY CLAIMED UNDER SEC. 44(D) ON SWITZERLAND APPLICATION NO. 0690011999, FILED 8-2-1999, REG. NO. 469027, DATED 8-2-1999, EXPIRES 8-2-2009.
THE MARK CONSISTS OF THE WORD "UPAQ" IN SCRIPT.

CLASS 9—ELECTRICAL AND SCIENTIFIC APPARATUS

FOR COMPUTER PROGRAMS FOR USE IN THE DELIVERY, EXCHANGE AND STORAGE OF ELECTRONIC DATA; COMPUTERS, COMPUTER PERIPHERALS, BLANK MAGNETIC AND OPTICAL DATA CARRIERS (U.S. CLS. 21, 23, 26, 36 AND 38).

CLASS 35—ADVERTISING AND BUSINESS

FOR COMPUTERIZED DATABASE MANAGEMENT (U.S. CLS. 100, 101 AND 102).

CLASS 38—COMMUNICATION

FOR TELECOMMUNICATIONS SERVICES, NAMELY, ELECTRONIC TRANSMISSION OF DATA AND DOCUMENTS VIA COMPUTER TERMINALS (U.S. CLS. 100, 101 AND 104).

CLASS 39—TRANSPORTATION AND STORAGE

FOR ELECTRONIC STORAGE OF DATA (U.S. CLS. 100 AND 105).

CLASS 42—SCIENTIFIC, COMPUTER AND LEGAL SERVICES

FOR COMPUTER CONSULTATION IN THE FIELD OF ELECTRONIC TRADE (U.S. CLS. 100 AND 101).

SN 75-819,464. WHOLE FOODS MARKET GROUP, INC., AUSTIN, TX. BY MERGER WHOLEPEOPLE.COM, BOULDER, CO. FILED 10-12-1999.

WHOLEMEDICA.COM

THE ENGLISH TRANSLATION OF "MEDICA" IN SPANISH IS, A "PRESCRIPTION", "DOCTOR" OR "PHYSICIAN".

CLASS 16—PAPER GOODS AND PRINTED MATTER

FOR PRINTED MATTER, NAMELY, FICTION AND NON-FICTION BOOKS FOR CHILDREN, ADULTS AND ADOLESCENTS, INSTRUCTIONAL AND TEACHING MATERIAL IN THE FIELD OF HEALTHY LIVING, EDUCATIONAL PAMPHLETS IN THE FIELD OF HEALTHY LIVING (U.S. CLS. 2, 5, 22, 23, 29, 37, 38 AND 50).

CLASS 35—ADVERTISING AND BUSINESS

FOR PROVIDING A WEBSITE USED TO PLACE ONLINE ORDERS IN THE FIELDS OF NATURAL FOODS, HEALTH FOODS, VITAMINS AND DIETARY SUPPLEMENTS, MEDICAL DEVICES, HOME FURNISHINGS, FOOD, COSMETICS AND CLOTHING, ALL PROVIDED VIA A GLOBAL COMPUTER NETWORK (U.S. CLS. 100, 101 AND 102).

CLASS 36—INSURANCE AND FINANCIAL

FOR PROVIDING INFORMATION VIA A GLOBAL COMPUTER NETWORK IN THE FIELD OF CHARITABLE AND PHILANTHROPIC ORGANIZATIONS AND FUND-RAISING ACTIVITIES (U.S. CLS. 100, 101 AND 102).

CLASS 38—COMMUNICATION

FOR HOSTING ON-LINE CHAT ROOMS FOR TRANSMISSION OF MESSAGES AMONG COMPUTER USERS CONCERNING HEALTHY LIVING; NATURAL AND HEALTH FOODS, HEALTH AND FITNESS, THE ENVIRONMENT AND AGRICULTURE (U.S. CLS. 100, 101 AND 104).

CLASS 41—EDUCATION AND ENTERTAINMENT

FOR PROVIDING INFORMATION VIA A GLOBAL COMPUTER NETWORK IN THE FIELDS OF EDUCATIONAL AND CULTURAL EXHIBITIONS AND ACTIVITIES, MUSICAL PERFORMANCES AND ENTERTAINMENT (U.S. CLS. 100, 101 AND 107).

CLASS 42—SCIENTIFIC, COMPUTER AND LEGAL SERVICES

FOR COMPUTER SERVICES, NAMELY, PROVIDING ON-LINE PUBLICATIONS IN THE FIELDS OF NUTRITION, HEALTHY LIVING, ALTERNATIVE HEALTH, MEDICINE, FITNESS, HEALTHY LIFESTYLES, PARENTING, PERSONAL RELATIONSHIPS, SPIRITUALITY, THE ENVIRONMENT, SCIENCE, MUSIC, ART, ANIMAL HEALTH AND NUTRITION (U.S. CLS. 100 AND 101).

SN 75-820,667. WHOLE FOODS MARKET GROUP, INC., AUSTIN, TX. BY MERGER WHOLEPEOPLE.COM, BOULDER, CO. FILED 10-12-1999.

SN 75-821,577. MOUNTAIN SAFETY RESEARCH, INC., SEATTLE, WA. FILED 10-13-1999.

FAST & LIGHT

WHOLE MEDICA

THE ENGLISH TRANSLATION OF "MEDICA", FROM SPANISH, IS A "PRESCRIPTION", "DOCTOR" OR "PHYSICIAN".

CLASS 16—PAPER GOODS AND PRINTED MATTER

FOR PRINTED MATTER, NAMELY, FICTION AND NON-FICTION BOOKS FOR CHILDREN, ADULTS AND ADOLESCENTS, INSTRUCTIONAL AND TEACHING MATERIAL IN THE FIELD OF HEALTHY LIVING, EDUCATIONAL PAMPHLETS IN THE FIELD OF HEALTHY LIVING (U.S. CLS. 2, 5, 22, 23, 29, 37, 38 AND 50).

CLASS 35—ADVERTISING AND BUSINESS

FOR PROVIDING A WEBSITE USED TO PLACE ON-LINE ORDERS IN THE FIELDS OF NATURAL FOODS, HEALTH FOODS, VITAMINS AND DIETARY SUPPLEMENTS, MEDICAL DEVICES, HOME FURNISHINGS, FOOD, COSMETICS AND CLOTHING, ALL PROVIDED VIA A GLOBAL COMPUTER NETWORK (U.S. CLS. 100, 101 AND 102).

CLASS 36—INSURANCE AND FINANCIAL

FOR PROVIDING INFORMATION VIA A GLOBAL COMPUTER NETWORK IN THE FIELD OF CHARITABLE AND PHILANTHROPIC ORGANIZATIONS AND FUND-RAISING ACTIVITIES (U.S. CLS. 100, 101 AND 102).

CLASS 38—COMMUNICATION

FOR HOSTING ON-LINE CHAT ROOMS FOR THE TRANSMISSION OF MESSAGES AMONG COMPUTER USERS CONCERNING HEALTHY LIVING; NATURAL AND HEALTH FOODS, HEALTH AND FITNESS, THE ENVIRONMENT AND AGRICULTURE (U.S. CLS. 100, 101 AND 104).

CLASS 41—EDUCATION AND ENTERTAINMENT

FOR PROVIDING INFORMATION VIA A GLOBAL COMPUTER NETWORK IN THE FIELDS OF EDUCATIONAL AND CULTURAL EXHIBITIONS AND ACTIVITIES, MUSICAL PERFORMANCES AND ENTERTAINMENT (U.S. CLS. 100, 101 AND 107).

CLASS 42—SCIENTIFIC, COMPUTER AND LEGAL SERVICES

FOR COMPUTER SERVICES, NAMELY, PROVIDING ON-LINE PUBLICATIONS IN THE FIELDS OF NUTRITION, HEALTHY LIVING, ALTERNATIVE HEALTH, MEDICINE, FITNESS, HEALTHY LIFESTYLES, PARENTING, PERSONAL RELATIONSHIPS, SPIRITUALITY, THE ENVIRONMENT, SCIENCE, MUSIC, ART, ANIMAL HEALTH AND NUTRITION (U.S. CLS. 100 AND 101).

CLASS 8—HAND TOOLS

FOR TABLEWARE, NAMELY, FORKS AND SPOONS (U.S. CLS. 23, 28 AND 44).

CLASS 11—ENVIRONMENTAL CONTROL APPARATUS

FOR BACKPACKING EQUIPMENT, NAMELY, GAS STOVES, AND WATER FILTERS USED TO PRODUCE POTABLE WATER (U.S. CLS. 13, 21, 23, 31 AND 34).

CLASS 21—HOUSEWARES AND GLASS

FOR BACKPACKING EQUIPMENT, COOKWARE, NAMELY, POTS, COOKWARE, NAMELY, POT LIFTERS AND POT GRIPPERS, COOKING FRYING PANS, NON-ELECTRIC KETTLES SOLD EMPTY, BOTTLES SOLD EMPTY, LIQUID FUEL BOTTLES SOLD EMPTY, MIXING AND SERVING SPOONS, AND TEAPOTS NOT OF PRECIOUS METAL (U.S. CLS. 2, 13, 23, 29, 30, 33, 40 AND 50).

CLASS 22—CORDAGE AND FIBERS

FOR BACKPACKING EQUIPMENT, NAMELY, TENTS (U.S. CLS. 1, 2, 7, 19, 22, 42 AND 50).

SN 75-827,147. TECSEC, INCORPORATED, VIENNA, VA. FILED 10-19-1999.

CKM ENABLED

OWNER OF U.S. REG. NO. 2,272,655.

CLASS 9—ELECTRICAL AND SCIENTIFIC APPARATUS

FOR COMPUTER PROGRAMS FOR USE IN ENCRYPTING DATA AND CONTROLLING ACCESS TO DATA AND PROGRAMS; COMPUTER SOFTWARE FOR USE IN ENCRYPTING DATA AND CONTROLLING ACCESS TO DATA AND PROGRAMS; AND COMPUTER UTILITY PROGRAMS (U.S. CLS. 21, 23, 26, 36 AND 38).

CLASS 42—SCIENTIFIC, COMPUTER AND LEGAL SERVICES

FOR DESIGN, PROVISION, IMPLEMENTATION, MAINTENANCE, UPGRADE, AND REPAIR OF COMPUTER SOFTWARE FOR USE IN ENCRYPTING DATA AND CONTROLLING ACCESS TO DATA AND PROGRAMS; AND CONSULTATION AND EXPERT SERVICES IN THE FIELD OF ELECTRONIC ENCRYPTION AND ACCESS CONTROL (U.S. CLS. 100 AND 101).

SN 75-827,371. AMERICAN HOMECARE SUPPLY LLC,
CONSHOHOCKEN, PA. FILED 10-19-1999.

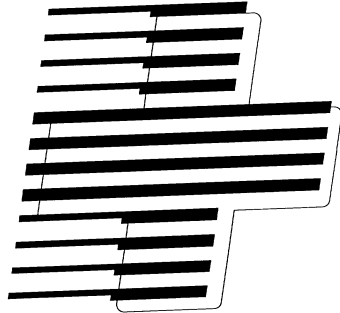

NO CLAIM IS MADE TO THE EXCLUSIVE RIGHT TO USE A SOLID RED OR SOLID ORANGE GREEK CROSS, A CROSS IN SHADES OF RED OR ORANGE, AN OUTLINED RED OR ORANGE GREEK CROSS, A GREEK CROSS OUTLINED IN SHADES OF RED OR ORANGE, A SOLID BLUE GREEK CROSS, OR A CROSS IN THE COLOR WHITE OR A SUBSTANTIALLY SIMILAR COLOR SUCH AS OFF-WHITE, IN CONNECTION WITH THE MARK AS SHOWN., APART FROM THE MARK AS SHOWN.

CLASS 5—PHARMACEUTICALS

FOR MEDICAL PRODUCTS, NAMELY, WOUND CARE DRESSINGS, MEDICATIONS AND AEROSOLS FOR USE IN TREATING RESPIRATORY DISEASES AND ASTHMA, ENTERAL FORMULAE, INTRAVENOUS FLUIDS, NAMELY CHEMOTHERAPY DRUGS, ANTIBIOTICS, PARENTERAL, NUTRITION FLUIDS, HYDRATION FLUIDS, PAIN MEDICATIONS, BLOOD FACTORS, HERAPIN FLUSHES, AND COLONY STIMULATING GROWTH FACTORS, ALL FOR HOME USE (U.S. CLS. 6, 18, 44, 46, 51 AND 52).

CLASS 10—MEDICAL APPARATUS

FOR MEDICAL EQUIPMENT, NAMELY, CANES, CRUTCHES, WALKERS, COMMODOES, BATH BENCHES, HANDRAILS, BED PANS, WASH PANS, PITCHERS, FLUID COLLECTION DEVICES, SHARPS CONTAINERS, SYRINGES, NEEDLES, PORTABLE LIQUID OXYGEN EQUIPMENT; BANDAGES, NAMELY COMPRESSION BANDAGES, ELASTIC BANDAGES, ORTHOPEDIC SUPPORT BANDAGES AND BANDAGES FOR ANATOMICAL JOINTS; SLEEP DIAGNOSTIC AND THERAPEUTIC EQUIPMENT, NAMELY FOR SUPPLYING SLEEP MEDICATION, MASKS AND HEADGEAR FOR TREATING SLEEP APNEA, NAMELY PRESSURE AND BI-LEVEL DEVICES BY RESPIRONICS AND RESUMED, AND INFANT MONITORS FOR APNEA; RESPIRATORY THERAPY EQUIPMENT, NAMELY, OXYGEN MONITORS AND SENORS, BREATHING AND VENTILATOR CIRCUIT MONITORS, RESPIRATORY MASKS AND HEADGEAR, VENTILATORS, NEBULIZERS AND ADAPTERS FOR DELIVERING RESPIRATORY MEDICATIONS, HUMIDIFIERS, MIST THERAPY DEVICES AND OXYGEN CONCENTRATORS, TUBINGS AND PULSE OXIMETERS; PHYSICAL REHABILITATION EQUIPMENT AND INTRAVENOUS EQUIPMENT, ALL FOR HOME USE (U.S. CLS. 26, 39 AND 44).

CLASS 12—VEHICLES

FOR WHEELCHAIRS, STAIR LIFTS, HOYER LIFTS AND LIFT CHAIRS (U.S. CLS. 19, 21, 23, 31, 35 AND 44).

CLASS 20—FURNITURE AND ARTICLES NOT OTHERWISE CLASSIFIED

FOR HOSPITAL BEDS AND BEDS FOR BURN PATIENTS (U.S. CLS. 2, 13, 22, 25, 32 AND 50).

SN 75-830,985. COLT TELECOM GROUP PLC, LONDON,
UNITED KINGDOM, BY ASSIGNMENT ADERO, INC.,
CAMBRIDGE, MA. FILED 10-25-1999.

GEOTRAFFIC MANAGER

NO CLAIM IS MADE TO THE EXCLUSIVE RIGHT TO USE "MANAGER", APART FROM THE MARK AS SHOWN.

CLASS 38—COMMUNICATION

FOR ELECTRONIC TRANSMISSION OF DATA AND DOCUMENTS VIA COMPUTER TERMINALS AND SERVERS; COMPUTER COMMUNICATIONS SERVICES, NAMELY, FACILITATING AND MANAGING HIGH SPEED MULTIPLE USER ACCESS TO A GLOBAL COMMUNICATIONS AND COMPUTER INFORMATION NETWORK; AND PROVIDING AND ROUTING TELECOMMUNICATIONS CONNECTIONS TO A GLOBAL COMMUNICATIONS AND COMPUTER INFORMATION NETWORK (U.S. CLS. 100, 101 AND 104).

CLASS 42—SCIENTIFIC, COMPUTER AND LEGAL SERVICES

FOR PROVIDING TEMPORARY USE OF ON-LINE NON-DOWNLOADABLE SOFTWARE AND THE LEASING OF COMPUTER HARDWARE WHICH FACILITATES AND MANAGES HIGH SPEED ACCESS TO A GLOBAL COMMUNICATIONS AND COMPUTER NETWORK (U.S. CLS. 100 AND 101).

SN 75-831,879. I.G.T. (AUSTRALIA) PTY LTD (ACN 002 904 690), NEW SOUTH WALES 2018, AUSTRALIA, FILED 10-25-1999.

CASHABLANCA

PRIORITY CLAIMED UNDER SEC. 44(D) ON AUSTRALIA APPLICATION NO. 792244, FILED 4-23-1999, REG. NO. 792244, DATED 4-23-1999, EXPIRES 4-23-2009.

CLASS 9—ELECTRICAL AND SCIENTIFIC APPARATUS

FOR GAMING MACHINES, NAMELY, ELECTRONIC GAMING MACHINES, SLOT MACHINES WITH OR WITHOUT A VIDEO OUTPUT, VIDEO GAME MACHINES FOR USE WITH TELEVISIONS, OPERATING SOFTWARE FOR INSTRUCTING AND MANIPULATING GAMING FEATURES OF GAMING, SLOT, AND VIDEO MACHINES, AND PARTS THEREFOR; GAMING SYSTEMS, NAMELY COMPUTER HARDWARE AND COMPUTER SOFTWARE FOR CONTROLLING SELECTION OF MACHINE UNITS FOR WINNING JACKPOTS; GAMING CONTROL SYSTEMS, NAMELY, COMPUTER HARDWARE AND COMPUTER SOFTWARE FOR TRACKING, CALCULATING, AND PAYING OUT DETERMINISTIC AND NON-DETERMINISTIC JACKPOTS; COMPUTER GAME SOFTWARE FOR USE IN GAMING MACHINE, NAMELY, ELECTRONIC GAMING MACHINES AND SLOT MACHINES WITH OR WITHOUT VIDEO OUTPUT (U.S. CLS. 21, 23, 26, 36 AND 38).

CLASS 28—TOYS AND SPORTING GOODS

FOR STAND ALONE VIDEO GAME MACHINES (U.S. CLS. 22, 23, 38 AND 50).

CLASS 41—EDUCATION AND ENTERTAINMENT

FOR ENTERTAINMENT SERVICES IN THE NATURE OF CASINO SERVICES FEATURING GAMING MACHINES, NAMELY, ELECTRONIC GAMING MACHINES, SLOT MACHINES WITH OR WITHOUT A VIDEO OUTPUT, AND VIDEO GAME MACHINES; ENTERTAINMENT SERVICES IN THE NATURE OF CASINOS SERVICES FEATURING A PROGRESSIVE AND BONUS JACKPOT GAME; ENTERTAINMENT SERVICES IN THE NATURE OF CASINO SERVICES FEATURING SIMULTANEOUS GAMES OF CHANCE AT MULTIPLE INDEPENDENT GAMING ESTABLISHMENTS; ENTERTAINMENT SERVICES, NAMELY, THE RENTAL OF COMPUTER GAME SOFTWARE AND VIDEO GAMES FOR GAMING MACHINES AND SLOT MACHINES (U.S. CLS. 100, 101 AND 107).

SN 75-833,282. KINECTA CORPORATION, SAN FRANCISCO, CA. BY CHANGE OF NAME SHIFTKEY, INC., SAN FRANCISCO, CA. FILED 10-27-1999.

KINECTA**CLASS 9—ELECTRICAL AND SCIENTIFIC APPARATUS**

FOR COMPUTER SOFTWARE FOR ENABLING, MANAGING AND SUPPORTING THIRD PARTY ORGANIZATIONS' INTERACTIONS WITH CUSTOMERS, PARTNERS AND SUPPLIERS BY AUTOMATING DIGITAL INTERACTIONS AND INFORMATION EXCHANGE OVER LOCAL AND GLOBAL COMPUTER NETWORKS (U.S. CLS. 21, 23, 26, 36 AND 38).

CLASS 38—COMMUNICATION

FOR PROVIDING MULTIPLE-USER ACCESS TO A GLOBAL COMPUTER INFORMATION NETWORK (U.S. CLS. 100, 101 AND 104).

CLASS 42—SCIENTIFIC, COMPUTER AND LEGAL SERVICES

FOR COMPUTER SERVICES, NAMELY, PROVIDING FOR THE TRANSFER, EXCHANGE, AND MANAGEMENT OF THIRD PARTY ORGANIZATIONS' INTERACTIONS WITH CUSTOMERS, PARTNERS AND SUPPLIERS BY AUTOMATING DIGITAL INTERACTIONS AND INFORMATION EXCHANGE OVER LOCAL AND GLOBAL COMPUTER NETWORKS; COMPUTER SOFTWARE DESIGN AND DEVELOPMENT SERVICES FOR OTHERS; CONSULTING SERVICES RELATING TO DIGITAL INFORMATION EXCHANGE AND MANAGEMENT; PROVIDING TECHNICAL AND CUSTOMER SUPPORT SERVICES FOR DIGITAL INFORMATION EXCHANGE AND MANAGEMENT VIA TELEPHONE, ELECTRONICALLY AND IN PERSON (U.S. CLS. 100 AND 101).

SN 75-835,653. CLARKSON, PHILIP JOHN, LONDON, SW29 4EU, UNITED KINGDOM, AND WALKER, GUY PETER WOLF, LONDON, SW29 4EU, UNITED KINGDOM, FILED 10-28-1999.

SPACE MILES

PRIORITY CLAIMED UNDER SEC. 44(D) ON UNITED KINGDOM APPLICATION NO. 2196031, FILED 4-29-1999, REG. NO. 2196031, DATED 6-29-2001, EXPIRES 4-29-2009.

NO CLAIM IS MADE TO THE EXCLUSIVE RIGHT TO USE "SPACE", APART FROM THE MARK AS SHOWN.

CLASS 36—INSURANCE AND FINANCIAL

FOR INSURANCE AND INVESTMENT BROKERAGE FOR PERSONS INTERESTED IN OUTER SPACE TOURISM AND RELATED ACTIVITIES (U.S. CLS. 100, 101 AND 102).

CLASS 39—TRANSPORTATION AND STORAGE

FOR TRAVEL BOOKING AGENCIES RELATED TO OUTER SPACE TOURISM (U.S. CLS. 100 AND 105).

SN 75-836,680. FOODEX CORPORATION, NEW YORK, NY. FILED 10-29-1999.

FOODEX**CLASS 35—ADVERTISING AND BUSINESS**

FOR RETAIL STORE SERVICES FEATURING GROCERIES, DRUGS, AND PREPARED FOODS AND FRANCHISING, NAMELY, OFFERING TECHNICAL ASSISTANCE IN THE ESTABLISHMENT AND/OR OPERATION OF FOOD, GROCERY AND DRUG STORES (U.S. CLS. 100, 101 AND 102).

CLASS 39—TRANSPORTATION AND STORAGE

FOR DELIVERY OF GROCERIES, DRUGS AND PREPARED FOODS (U.S. CLS. 100 AND 105).

SN 75-837,241. INTRAWEST/SQUAW CORPORATION, OLYMPIC VALLEY, CA. FILED 11-1-1999.



THE MARK CONSISTS OF THE OUTLINE OF A TOWER WITH MOUNTAINS IN THE BACKGROUND.

CLASS 14—JEWELRY

FOR JEWELRY, NAMELY, LAPEL PINS (U.S. CLS. 2, 27, 28 AND 50).

CLASS 16—PAPER GOODS AND PRINTED MATTER

FOR PAPER PRODUCTS, NAMELY, ART PICTURES; POSTCARDS, POSTERS, CALENDARS AND BOOKS, NAMELY, TRAVEL BOOKS, ADDRESS BOOKS, DATE BOOKS (U.S. CLS. 2, 5, 22, 23, 29, 37, 38 AND 50).

CLASS 21—HOUSEWARES AND GLASS

FOR BEVERAGE GLASSWARE AND COFFEE MUGS (U.S. CLS. 2, 13, 23, 29, 30, 33, 40 AND 50).

CLASS 25—CLOTHING

FOR CLOTHING, NAMELY, T-SHIRTS, HATS, VISORS, SWEATSHIRTS, HEADBANDS; MEN'S, WOMEN'S AND CHILDREN'S SPORTSWEAR, NAMELY, SHIRTS, PANTS, OVERALLS, AND JUMPERS; MEN'S, WOMEN'S AND CHILDREN'S OUTERWEAR, NAMELY, JACKETS, COATS, SWEATERS, VESTS, GLOVES, MITTENS, AND SCARVES (U.S. CLS. 22 AND 39).

CLASS 35—ADVERTISING AND BUSINESS

FOR ADVERTISING AND PROMOTING THE SKI RESORT AND SUMMER RESORT SERVICES AND GOODS OF OTHERS THROUGH THE DISTRIBUTION OF PRINTED, ELECTRONIC, AND PROMOTIONAL MATERIALS; COOPERATIVE ADVERTISING AND MARKETING SERVICES; CHAMBER OF COMMERCE SERVICES, NAMELY, PROMOTING BUSINESS AND TOURISM IN THE MOUNTAINS OF CALIFORNIA; BUYING CLUB SERVICES; RETAIL STORE, MAIL ORDER AND ONLINE ORDERING SERVICES IN THE FIELDS OF SPORTS AND RECREATIONAL EQUIPMENT, CLOTHING, JEWELRY, STATIONERY, AND SOUVENIRS (U.S. CLS. 100, 101 AND 102).

CLASS 36—INSURANCE AND FINANCIAL

FOR LEASING AND MANAGING RESIDENTIAL AND COMMERCIAL REAL ESTATE; REAL ESTATE BROKERAGE SERVICES FOR RESIDENTIAL AND COMMERCIAL REAL ESTATE; LISTING AND OFFERING FOR SALE RESIDENTIAL AND COMMERCIAL REAL ESTATE; PROVIDING REAL ESTATE AND FINANCIAL INFORMATION SERVICES VIA A GLOBAL COMPUTER NETWORK (U.S. CLS. 100, 101 AND 102).

CLASS 37—CONSTRUCTION AND REPAIR

FOR REAL ESTATE DEVELOPMENT SERVICES, NAMELY BUILDING RESIDENTIAL AND COMMERCIAL SPACE (U.S. CLS. 100, 103 AND 106).

CLASS 41—EDUCATION AND ENTERTAINMENT

FOR PROVIDING WINTER RESORT AND SUMMER RESORT SERVICES; PROVIDING ADVENTURE CONCIERGE SERVICES; PROVIDING FACILITIES FOR RECREATIONAL AND SPORTING ACTIVITIES; EDUCATION SERVICES; GOLF CLUB SERVICES; ENTERTAINMENT SERVICES IN THE NATURE OF LIVE MUSICAL, ARTISTIC, AND THEATRICAL PERFORMANCES, LIVE CONCERTS AND LIVE PERFORMANCES BY ROCK GROUPS, CONDUCTING SPORTS EXHIBITIONS AND TOURNAMENTS IN THE FIELDS OF SKIING, GOLFING, SNOWBOARDING, INLINE SKATING, SKATE BOARDING, CYCLING, AND TENNIS; CONDUCTING BRIDGE AND CHESS TOURNAMENTS; PROVIDING INFORMATION ABOUT SPORTS AND ATHLETIC COMPETITIONS VIA A GLOBAL COMPUTER NETWORK; EDUCATIONAL SERVICES, NAMELY, SEMINARS, CLASSES AND WORKSHOPS IN THE FIELDS OF SKIING, GOLFING, SNOWBOARDING, PHYSICAL FITNESS INSTRUCTION, INLINE SKATING, SKATEBOARDING, CYCLING AND TENNIS (U.S. CLS. 100, 101 AND 107).

CLASS 42—SCIENTIFIC, COMPUTER AND LEGAL SERVICES

FOR HOTEL LODGING, HOTEL RESORT, RESTAURANT, AND HEALTH SPA SERVICES; NIGHT CLUB SERVICES; CHARITABLE SERVICES, NAMELY PROVIDING FOOD, LODGING, CLOTHING, AND MEDICINE FOR OTHERS; PROVIDING INFORMATION ABOUT HOTELS, RESTAURANTS AND LODGING VIA A GLOBAL COMPUTER NETWORK (U.S. CLS. 100 AND 101).

SN 75-839,074. MEDICAL INDUSTRIES AMERICA, INC., DALLAS COUNTY, IA. FILED 11-3-1999.

TERRATEK**CLASS 7—MACHINERY**

FOR ENGINES NOT FOR LAND VEHICLES AND ELECTRIC MOTORS FOR MACHINES (U.S. CLS. 13, 19, 21, 23, 31, 34 AND 35).

CLASS 11—ENVIRONMENTAL CONTROL APPARATUS

FOR HEATERS, NAMELY, COMBUSTION HEATERS FOR CONVERTING FUEL INTO MECHANICAL MOTION (U.S. CLS. 13, 21, 23, 31 AND 34).

CLASS 12—VEHICLES

FOR ENGINES FOR LAND VEHICLES (U.S. CLS. 19, 21, 23, 31, 35 AND 44).

SN 75-839,505. 55 ENTERTAINMENT, INC., LOS ANGELES, CA. FILED 11-3-1999.

**CLASS 9—ELECTRICAL AND SCIENTIFIC APPARATUS**

FOR PRERECORDED AUDIO AND VIDEO TAPES, COMPACT DISCS (CDS), DIGITAL VIDEO DISCS (DVDS) AND PRERECORDED AUDIO CASSETTES, FEATURING MUSIC, RHYTHM AND BLUES, RAP, JAZZ, BLUES, CLASSICAL MUSIC, POP, ROCK, SPOKEN WORD, SOUND TRACKS FOR FILMS AND TELEVISION, LIVE PERFORMANCES, NEWS, SPORTS, ENTERTAINMENT, COMEDY, ROMANCE, RELIGION AND TRAVEL (U.S. CLS. 21, 23, 26, 36 AND 38).

CLASS 25—CLOTHING

FOR CLOTHING, NAMELY, HEADWEAR, FOOTWEAR, T-SHIRTS, SWEATSHIRTS, BLOUSES, SWEATERS, SPORT SHIRTS, JERSEYS, SHORTS, TROUSERS, PANTS, SWEATPANTS, SKI PANTS, RACING PANTS, JEANS, COATS, VESTS, JACKETS, SWIMWEAR, HATS, VISORS, CAPS, GLOVES, BELTS, SOCKS, SANDALS AND SHOES (U.S. CLS. 22 AND 39).

CLASS 35—ADVERTISING AND BUSINESS

FOR PROMOTING CONCERTS, TOURS, PERSONAL APPEARANCES, MUSICAL RECORDINGS AND MOTION PICTURE FILM APPEARANCES OF OTHERS (U.S. CLS. 100, 101 AND 102).

CLASS 41—EDUCATION AND ENTERTAINMENT

FOR ENTERTAINMENT SERVICES, NAMELY, ORGANIZING CONCERTS, PERSONAL APPEARANCES, MUSICAL RECORDINGS, AND MOTION PICTURE FILM APPEARANCES FOR OTHERS; MOTION PICTURE FILM PRODUCTION; AUDIO RECORDING AND PRODUCTION (U.S. CLS. 100, 101 AND 107).

VICES FOR DOMESTIC USE, NAMELY VACUUM CLEANERS AND HIGH PRESSURE WATER CLEANER (U.S. CLS. 13, 19, 21, 23, 31, 34 AND 35).

SN 75-839,692. REXROTH INDRAMAT GMBH, D-9781 6 LOHR, FED REP GERMANY, FILED 11-3-1999.



PRIORITY CLAIMED UNDER SEC. 44(D) ON FED REP GERMANY APPLICATION NO. 39926796, FILED 5-8-1999, REG. NO. 39926796, DATED 9-1-1999, EXPIRES 5-31-2009.

THE MARK LINED FOR THE COLORS BLUE AND YELLOW.

CLASS 7—MACHINERY

FOR MACHINE TOOLS, NAMELY, CHUCKING TOOLS, CLAMPING SYSTEMS COMPRISED OF CLAMPING CHUCKS AND CLAMPING JAWS; LATHES AND TURNING CENTERS, COLLETS, POWER DRAW BARS, DRILLING PRESSES AND MACHINING CENTERS; MOTORS, NAMELY, ELECTRIC MOTORS FOR USE IN MACHINES AND INTERNAL COMBUSTION ENGINES FOR MACHINE OPERATION, STEPPER MOTORS, FANS FOR MOTORS, CLUTCHES FOR MACHINES, DRIVING BELTS FOR MACHINES; DRIVING AXLES, DRIVING LINKAGES, DRIVING CHAINS, DRIVING WHEELS, WHEELWORKS, CLUTCHES, DRIVE SHAFTS, RODS, BARS, GEARING, ECCENTRICS AND CAMS FOR FORCE TRANSMISSION FOR USE IN MACHINES, NAMELY IN FILLING MACHINES OR IN SEAMING MACHINES FOR USE IN THE CHEMICAL OR PHARMACEUTICAL INDUSTRY OR IN CAPPING MACHINES FOR USE IN THE CHEMICAL OR PHARMACEUTICAL INDUSTRY OR IN CAPPING MACHINES FOR USE IN THE CHEMICAL OR PHARMACEUTICAL INDUSTRY OR IN PRINTING MACHINES AND PAPER CONVERTING MACHINES OR IN MILLING MACHINES OR IN DRILLING MACHINES OR IN GRINDING MACHINES; MACHINES FOR THE CHEMICAL AND PHARMACEUTICAL INDUSTRIES, NAMELY FILLING MACHINES, SEAMING MACHINES, CAPPING MACHINES, LABELLING MACHINES, PACKAGING MACHINES, FOR FILLING AND PACKAGING OF CHEMICAL AND PHARMACEUTICAL SUBSTANCES; MACHINES FOR FORMING, FILLING AND CLOSING CONTAINERS, THERMOFORMING MACHINES FOR MANUFACTURING, FILLING AND SEALING OF BLISTER PACKAGING, MACHINES FOR COLLECTING AND PALETIZING ARTICLES FOR THEIR SUBSEQUENT TRANSPORTATION; MACHINES FOR THE AUTOMOBILE INDUSTRY AND ITS SUPPLIERS, NAMELY MILLING MACHINES, DRILLING MACHINES, GRINDING MACHINES, MACHINING CENTERS; PRINTING MACHINES, NAMELY HIGH SPEED SINGLE AND MULTICOLOR OFFSET PRESSES AND PHOTOGRAPHURE MACHINES, PAPER PROCESSING MACHINES, NAMELY CORRUGATORS, PRINTER SLOTTERS, PAPER CONVERTING MACHINES, BAG PRODUCTION MACHINES, COLLAPSIBLE FOLDING BOX PRODUCTION MACHINES, ROTARY DIE CUTTERS AND SLIT-TER SCORERS; PACKAGING MACHINES; MACHINES FOR THE FOOD INDUSTRIES, NAMELY, ELECTRIC FOOD PROCESSORS; MACHINES FOR THE TEXTILE INDUSTRY, NAMELY, SPINNING MACHINES, TEXTILE PRINTING, BLEACHING, DYEING, FINISHING, SPINNING AND TREATING MACHINES; ELECTRIC KITCHEN APPLIANCES FOR CHOPPING, GRINDING, AND PRESSING, NAMELY, FOOD PROCESSORS FOR DOMESTIC USE; CLOTHES WASHING MACHINES, AUTOMATIC DISH WASHING MACHINES; ELECTRIC CURRENT GENERATOR; ELECTRIC CLEANING DE-

CLASS 9—ELECTRICAL AND SCIENTIFIC APPARATUS

FOR ELECTRIC AND ELECTRONIC DEVICES FOR THE REMOTE CONTROL OF INDUSTRIAL WORK PROCESSES, NAMELY, DIGITAL AND ELECTRONIC DRIVE AND CONTROL SYSTEMS FOR THE REGULATION AND OPERATION OF MACHINES COMPRISING ELECTRONIC DRIVE CONTROL UNITS, DIGITAL AND ANALOGUE INTERFACE MODULES, MOTORS, OPERATOR CONTROLS, SENSORS AND MEASURING, SIGNAL AND CONTROL LINES; TIME SWITCHES; SOLAR CELLS FOR SOLAR INSTALLATIONS; DIGITAL CONTROL AND ACTUATION SYSTEMS, ALSO FOR DRIVING MACHINE AXLES, COMPRISED OF CONTROL UNITS, ELECTRONIC ACTUATION CONTROL DEVICES, DIGITAL AND ANALOG INTERFACE UNITS, SERVICE UNITS, SENSORS FOR MEASURING SIGNAL AND CONTROL CIRCUITS, ELECTRIC AND ELECTRONIC CONTROL, ADJUSTMENT, SWITCHING AND MONITORING DEVICES, NAMELY POSITION CONTROLS, SPEED CONTROLS, TORQUE CONTROLS, FORCE CONTROLS, CURRENTS CONTROLS, FOR USE WITH ELECTRIC MOTORS AND FOR DRIVING MACHINE AXLES; DEVICES FOR RECORDING, TRANSMISSION AND REPRODUCTION OF IMAGE, SOUND AND DATA, NAMELY, AUDIO TAPE RECORDERS, VIDEO TAPE RECORDERS, CAMERAS; VIDEO CAMERAS, VIDEO PLAYERS; COMPACT DISC PLAYERS; SLIDE PROJECTORS; PHOTOGRAPHIC EQUIPMENT, NAMELY AN ENLARGER, CAMERA STANDS, PHOTOCOPYING MACHINES; BLANK COMPUTER HARD DISKS, BLANK FLOPPY DISKS, BLANK COMPUTER TAPES; ELECTRICAL CABLES, ELECTRICAL WIRING, ELECTRICAL CONDUCTORS AND CONNECTION FIXTURES THEREFOR, NAMELY, CABLES, CLIPS AND BOXES AND ELECTRICAL SWITCHES, ELECTRICAL DISTRIBUTION SWITCHBOARDS AND ELECTRICAL CABINETS, AUTOMATIC VENDING MACHINES AND MECHANISMS FOR COIN-OPERATED APPARATUS, CASH REGISTERS, CALCULATING MACHINES, DATA PROCESSING MACHINES AND COMPUTERS, COMPUTER SOFTWARE USED FOR OPERATING CONTROL AND ADJUSTMENT DEVICES IN FINISHING MACHINES AND FOR REPRESENTING PROGRAM FLOW AND PROCESSING FLOW THROUGH THE USE OF COMPUTER GRAPHICS (U.S. CLS. 21, 23, 26, 36 AND 38).

CLASS 42—SCIENTIFIC, COMPUTER AND LEGAL SERVICES

FOR SCIENTIFIC AND INDUSTRIAL RESEARCH FOR OTHERS IN THE FIELD OF CNC METALWORKING AND METAL FORMING, HIGH SPEED PACKAGING, SHAFTLESS NEWSPAPER AND COMMERCIAL PRINTING, KINEMATIC ROBOTICS; DESIGNING DATA PROCESSING PROGRAMS FOR USE BY THIRD PARTIES; TECHNICAL CONSULTING IN THE FIELD OF MACHINE CONTROL AND ACTUATION; DESIGNING AND DEVELOPING CONTROL AND ACTUATION COMPONENTS AND SYSTEMS COMPOSED THEREOF, FOR THIRD PARTIES FOR THE AUTOMATION OF FINISHING OPERATIONS (U.S. CLS. 100 AND 101).

SN 75-843,096. GILBARCO, INC., GREENSBORO, NC. FILED 11-6-1999.

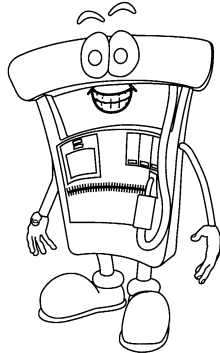

CLASS 9—ELECTRICAL AND SCIENTIFIC APPARATUS

FOR POINT-OF-SALE SYSTEM USER INTERFACE CONSISTING OF COMPUTER HARDWARE AND COMPUTER SOFTWARE FOR PROVIDING HELP SERVICES TO USERS IN THE RETAIL INDUSTRY (U.S. CLS. 21, 23, 26, 36 AND 38).

CLASS 42—SCIENTIFIC, COMPUTER AND LEGAL SERVICES

FOR COMPUTER HELP SERVICES AND TECHNICAL SUPPORT SERVICES FOR USERS OF RETAIL PINT-OF-SALE SYSTEMS THAT CONSIST OF COMPUTER HARDWARE AND COMPUTER SOFTWARE, NAMELY, TROUBLESHOOTING OF COMPUTER HARDWARE AND SOFTWARE PROBLEMS VIA IN-PERSON INSTRUCTIONS DISPLAYED IN HUMAN PERCEPTIBLE FORM (U.S. CLS. 100 AND 101).

SN 75-848,117. MAJOR WIRE INDUSTRIES LIMITED/LES INDUSTRIES FIL METALLIQUE MAJOR LIMITEE, CANADIAC, QUEBEC, FILED 11-12-1999.

OptimumWire

CLASS 6—METAL GOODS

FOR WIRES MADE OF METAL AND WIRES MADE PRIMARILY OF METAL ALLOYS, PLASTICS AND COMPOSITES, NAMELY, STRAIGHT WIRES, PRE CRIMPED WIRES AND METAL SECTIONS FOR USE IN THE MANUFACTURE OF WIRE NETTING, WIRE MESH, SIFTING SCREENS, SIEVES AND FILTERS FOR SIFTING, FILTERING AND SIEVING THE ROCK, SABLE, GRAVEL, MINERALS, AND FOR USE IN THE MANUFACTURE OF VARIOUS INDUSTRIAL PRODUCTS; WOVEN WIRE SCREENS OF STRAIGHT WIRE, PRE-CRIMPED WIRE, METAL SECTION MADE OF METAL AND WIRES MADE PRIMARILY METAL ALLOYS, PLASTICS AND COMPOSITES, NAMELY, WIRE NETTING AND WIRE MESH, SIFTING SCREENS, SIEVES, FILTERS FOR USE OF SIFTING, FILTERING AND SIEVING THE ROCK, SABLE, GRAVEL, MINERALS USED IN THE COMPOSITION OF VARIOUS INDUSTRIAL PRODUCTS (U.S. CLS. 2, 12, 13, 14, 23, 25 AND 50).

FIRST USE 1-15-1999; IN COMMERCE 1-15-1999.

CLASS 42—SCIENTIFIC, COMPUTER AND LEGAL SERVICES

FOR CUSTOM MANUFACTURE OF WOVEN WIRE SCREENS OF STRAIGHT WIRES, PRE-CRIMPED WIRE, METAL SECTION; WIRE NETTING, WIRE MESH, SIFTING SCREENS, SIEVES, AND FILTERS FOR USE IN SIFTING, FILTERING OR SIEVING THE ROCK, SABLE, GRAVEL, MINERALS, AND USED IN THE COMPOSITION OF VARIOUS INDUSTRIAL PRODUCTS (U.S. CLS. 100 AND 101).

FIRST USE 1-15-1999; IN COMMERCE 1-15-1999.

SN 75-854,533. GURREN, EDWARD J., DBA GOLDEN BOY RECORDS, PINE MOUNTAIN CLUB, CA. FILED 11-22-1999.

GOLDEN BOY RECORDS

NO CLAIM IS MADE TO THE EXCLUSIVE RIGHT TO USE "RECORDS", APART FROM THE MARK AS SHOWN.

CLASS 9—ELECTRICAL AND SCIENTIFIC APPARATUS

FOR PRE-RECORDED PHONOGRAPH RECORDS, AUDIO CASSETTES, VIDEO CASSETTES AND COMPACT DISCS, ALL PRIMARILY FEATURING MUSIC AND MUSICIANS (U.S. CLS. 21, 23, 26, 36 AND 38).

FIRST USE 4-14-1984; IN COMMERCE 4-14-1984.

CLASS 41—EDUCATION AND ENTERTAINMENT

FOR ENTERTAINMENT SERVICES, NAMELY, MUSIC PUBLISHING SERVICES, AUDIO AND VIDEO RECORDING AND PRODUCTION SERVICES, IN THE FIELD OF MUSIC, MANAGEMENT SERVICES RELATING TO MUSICIANS, MUSICAL ARTISTS OR MUSICAL PERFORMERS AND PROMOTIONAL SERVICES IN THE NATURE OF PROMOTING MUSICIANS OR MUSIC-RELATED GOODS OR SERVICES (U.S. CLS. 100, 101 AND 107).

FIRST USE 4-14-1984; IN COMMERCE 4-14-1984.

SN 75-854,975. CARL M. FREEMAN ASSOCIATES, INC., POTOMAC, MD. FILED 11-22-1999.

CLASS 36—INSURANCE AND FINANCIAL

FOR REAL ESTATE BROKERAGE SERVICES; MORTGAGE BROKERAGE SERVICES; MANAGEMENT, LEASING AND BROKERAGE OF RESIDENTIAL HOUSING AND COMMERCIAL SPACES (U.S. CLS. 100, 101 AND 102).

FIRST USE 8-1-1999; IN COMMERCE 8-1-1999.

CLASS 37—CONSTRUCTION AND REPAIR

FOR DEVELOPMENT, CONSTRUCTION AND MAINTENANCE OF RESIDENTIAL HOUSING AND COMMUNITIES, DEVELOPMENT, CONSTRUCTION AND MAINTENANCE OF COMMERCIAL SPACES; DEVELOPMENT, CONSTRUCTION AND MAINTENANCE OF GOLF COURSES AND RESORTS (U.S. CLS. 100, 103 AND 106).

FIRST USE 8-1-1999; IN COMMERCE 8-1-1999.

SN 75-855,771, DOFASCO INC., HAMILTON, ONTARIO, CANADA, FILED 11-23-1999.

DOFASCO

PRIORITY CLAIMED UNDER SEC. 44(D) ON CANADA APPLICATION NO. 1019609, FILED 6-18-1999, REG. NO. TMA547521, DATED 7-3-2001, EXPIRES 7-3-2016.

CLASS 1—CHEMICALS

FOR CHEMICAL PRODUCTS FOR USE IN INDUSTRY AND SCIENCE, NAMELY IRON OXIDE PRODUCED AS A BY-PRODUCT OF HYDROCHLORIC ACID REGENERATION AND USED AS A RAW MATERIAL IN THE MANUFACTURE OF PERMANENT MAGNETS; AMMONIUM SULPHATE FOR USE IN INDUSTRIAL MANUFACTURING; ANHYDROUS AMMONIA FOR USE AS AN AGRICULTURAL FERTILIZER; COAL TAR; BENZENE, TOLUENE AND XYLENE; SCRAP GRAPHITE ELECTRODES USED AS A FEED STOCK IN PRODUCING NEW GRAPHITE ELECTRODES; DUST AND SLUDGE SOLID MATTER RECOVERED FROM IRON AND STEELMAKING PROCESSES AND USED AS A RAW MATERIAL IN THE PRODUCTION OF SINTERED IRON BASED BLAST FURNACE FEEDSTOCKS; NON-FERROUS SCRAP NAMELY ZINC, ALUMINUM AND COPPER AND USED AS A RAW MATERIAL IN THE NON-FERROUS METAL REFINING INDUSTRY, AND IRON OXIDE "MILL SCALE" CREATED DURING THE ANNEALING AND PROCESSING OF STEEL IN ROLLING MILLS AND USED AS A RAW MATERIAL IN FERROUS INDUSTRIAL PROCESSES (U.S. CLS. 1, 5, 6, 10, 26 AND 46).

CLASS 4—LUBRICANTS AND FUELS

FOR LIGHT OIL FOR INDUSTRIAL USE; FUELS, NAMELY METALLURGICAL COKE, FOR USE AS A FUEL IN BLAST FURNACES; AND METALLURGICAL COKE SCREENINGS, NAMELY NUT COKE, PEA COKE, WET BREEZE AND COKE BREEZE SOLD COMMERCIALY AS A LOW GRADE CARBON BASED FUEL FOR USE IN IRON OXIDE BRIQUETTING OPERATIONS (U.S. CLS. 1, 6 AND 15).

CLASS 6—METAL GOODS

FOR UNWROUGHT AND PARTIALLY WROUGHT COMMON METALS AND THEIR ALLOYS, NAMELY CARBON AND ALLOY STEEL PLATE, AND HOT ROLLED STEEL, FLAT STEEL IN COIL AND SHEET FORM; COLD ROLLED FLAT STEEL IN COIL AND SHEET FORM; FLAT ROLLED STEEL IN COIL AND SHEET FORM, NAMELY TIN PLATED STEEL AND TIN MILL "BLACK PLATE"; FLAT ROLLED STEEL IN COIL AND SHEET FORM, NAMELY ZINC COATED "GALVANIZED STEEL" AND ZINC/ALUMINUM ALLOY COATED STEEL; FLAT ROLLED STEEL IN COIL AND SHEET FORM, NAMELY VITREOUS ENAMELING STEEL; FLAT ROLLED STEEL IN COIL AND SHEET FORM, NAMELY CHROMIUM COATED "TINFREE STEEL"; FLAT ROLLED STEEL IN COIL AND SHEET FORM, NAMELY ZINC/ZINC ALLOY COATED STEEL; FLAT ROLLED STEEL IN COIL AND SHEET FORM, NAMELY SURFACE TEXTURED, ROLL EMBOSSED STEEL; HOT, COLD ROLLED, ZINC COATED AND ZINC/ALUMINUM ALLOY COATED STEEL TUBES FOR USE IN SUBSEQUENT FORMING AND FABRICATING SUCH AS AUTOMOTIVE FRAMES AND THE LIKE; CAST PIG IRON; CAST IRON SCRAP, NAMELY BEACH IRON, COLD IRON, RUNNER SCRAP AND FERROUS SCRAP USED AS A RAW MATERIAL IN IRON AND STEEL REFINING PROCESSES; ZINC AND ZINC/ALUMINUM OXIDE USED AS A FEED STOCK IN NON-FERROUS METAL PRODUCTION; AND SOLID RESIDUE FROM TIN PLATING COMPOSED PRIMARILY OF TIN AND USED AS FEED STOCK IN THE MANUFACTURE OF TIN PLATING ELECTRODES (U.S. CLS. 2, 12, 13, 14, 23, 25 AND 50).

CLASS 19—NON-METALLIC BUILDING MATERIALS

FOR BUILDING PRODUCTS NAMELY, BULK SLAG MATERIALS PRODUCED FROM AIR QUENCHED, WATER QUENCHED OR EXPANDED IRON AND STEELMAKING SLAGS FOR USE IN ROAD BUILDING, RESIDENTIAL OR COMMERCIAL CONSTRUCTION OR AS AN ADDITIVE IN PORTLAND CEMENT AND CONCRETE FORMULATIONS (U.S. CLS. 1, 12, 33 AND 50).

SN 75-856,502, SAATCHI & SAATCHI HOLDINGS LTD, LONDON W1A 4XA, UNITED KINGDOM, FILED 11-23-1999.

**SAATCHI & SAATCHI
HEALTHCARE**

OWNER OF U.S. REG. NOS. 2,026,495 AND 2,053,885.
NO CLAIM IS MADE TO THE EXCLUSIVE RIGHT TO USE "HEALTHCARE", APART FROM THE MARK AS SHOWN.

CLASS 35—ADVERTISING AND BUSINESS

FOR PREPARING AND PLACING ADVERTISEMENTS FOR OTHERS; PREPARING AUDIO VISUAL PRESENTATIONS FOR USE IN ADVERTISING; ADVERTISING AGENCY SERVICES; CONSULTING SERVICES IN THE FIELD OF MARKETING AND ADVERTISING; MARKET RESEARCH; CONDUCTING BUSINESS AND MARKET RESEARCH SURVEYS; MARKET ANALYSIS; PUBLIC RELATIONS; PERSONNEL PLACEMENT AND RECRUITMENT; BUSINESS MANAGEMENT PLANNING; PERSONNEL MANAGEMENT CONSULTATION; COST MANAGEMENT FOR THE HEALTH BENEFIT PLANS OF OTHERS; BUSINESS MANAGEMENT; PROMOTING HEALTHCARE ACTIVITIES OF OTHERS BY THE DISTRIBUTION OF PRINTED, AUDIO AND AUDIO-VIDEO PROMOTIONAL MATERIALS AND BY RENDERING SALES PROMOTION ADVICE (U.S. CLS. 100, 101 AND 102).

CLASS 41—EDUCATION AND ENTERTAINMENT

FOR PUBLISHING OF BOOKS, MAGAZINES, REPORTS, BROCHURES, AND PROMOTIONAL LITERATURE FOR OTHERS IN THE FIELD OF HEALTHCARE AND HEALTHCARE BENEFIT PLANS; ELECTRONIC PUBLISHING SERVICES, NAMELY, PUBLICATION OF TEXT AND GRAPHICS ON CD-ROMS FOR OTHERS IN THE FIELD OF HEALTHCARE AND HEALTHCARE BENEFIT PLANS; PRODUCTION OF RADIO AND TELEVISION PROGRAMS (U.S. CLS. 100, 101 AND 107).

CLASS 42—SCIENTIFIC, COMPUTER AND LEGAL SERVICES

FOR COMMERCIAL AND PACKAGING DESIGN FOR OTHERS; PRINTING AND GRAPHIC ARTS DESIGN; PORTRAIT PHOTOGRAPHY; TYPE-SETTING; COMPUTER PROGRAMMING; COMPUTER SERVICES, NAMELY, PROVIDING ON-LINE MAGAZINES, BROCHURES, REPORTS, NEWSLETTERS AND INFORMATIONAL LITERATURE IN THE FIELD OF HEALTHCARE AND HEALTHCARE BENEFIT PLANS (U.S. CLS. 100 AND 101).

SN 75-862,645. GOLDEN BOY ENTERPRISES, LLC, LOS ANGELES, CA. FILED 12-2-1999.



OWNER OF U.S. REG. NOS. 2,210,496, 2,371,374 AND OTHERS.

THE SILHOUETTE PORTRAIT APPEARING IN THE MARK IS THAT OF "OSCAR DE LA HOYA", A LIVING INDIVIDUAL, WHOSE WRITTEN CONSENT TO THE REGISTRATION OF HIS LIKENESS IS OF RECORD.

CLASS 25—CLOTHING

FOR CLOTHING, NAMELY, BELTS, BOXER SHORTS, GLOVES, JACKETS, JEANS, JERSEYS, MUSCLE SHIRTS, PANTS, SHIRTS, SHORTS, SPORTS SHIRTS, SWEATERS, SWEATPANTS, SWEATSHIRTS, SWIMWEAR AND T-SHIRTS; FOOTWEAR, NAMELY, SOCKS AND SHOES; HEADWEAR, NAMELY, CAPS, HATS AND VISORS (U.S. CLS. 22 AND 39).

CLASS 35—ADVERTISING AND BUSINESS

FOR PROMOTING THE CONCERTS OF OTHERS (U.S. CLS. 100, 101 AND 102).

CLASS 36—INSURANCE AND FINANCIAL

FOR CHARITABLE SERVICES, NAMELY, PROVIDING FUNDRAISING SERVICES FOR CHILDREN'S CHARITIES; AND PROVIDING EDUCATIONAL SCHOLARSHIPS (U.S. CLS. 100, 101 AND 102).

CLASS 41—EDUCATION AND ENTERTAINMENT

FOR RECREATIONAL SERVICES FOR CHILDREN IN THE NATURE OF PROVIDING FACILITIES AND ORGANIZATION FOR CHILDREN TO GATHER AND PARTICIPATE IN SPORTS, GAMES, ART AND CRAFTS; EDUCATIONAL SERVICES FOR CHILDREN, NAMELY PROVIDING TUTORING SERVICES IN GRADE SCHOOL AND HIGH SCHOOL LEVEL SUBJECTS, PROVIDING STUDY PROGRAMS AND STUDYING FACILITIES, AND PROVIDING COMPUTER TRAINING; ENTERTAINMENT SERVICES, NAMELY, PROVIDING LIVE PROFESSIONAL BOXING EXHIBITIONS FOR OTHERS; AUDIO RECORDING AND PRODUCTION OF TELEVISION AND FILM MUSIC AND COMEDY PROGRAMS (U.S. CLS. 100, 101 AND 107).

CLASS 42—SCIENTIFIC, COMPUTER AND LEGAL SERVICES

FOR ELEEMOSYNARY SERVICES, NAMELY, PROVIDING ATHLETIC, SOCIAL, AND EDUCATIONAL OPPORTUNITIES FOR CHILDREN, NAMELY, PROVIDING ATHLETIC, SPORTS AND WEIGHT TRAINING; RECREATIONAL ACTIVITIES; SPORTS TOURNAMENTS AND EXHIBITIONS; SCHOLARSHIPS; STUDY PROGRAMS; TUTORING; STUDYING FACILITIES; AND EDUCATIONAL PROGRAMS FOR CHILDREN (U.S. CLS. 100 AND 101).

SN 75-856,667. GATEWAY LEARNING CORPORATION, SANTA ANA, CA. FILED 11-23-1999.

HOOKED ON VOCABULARY

NO CLAIM IS MADE TO THE EXCLUSIVE RIGHT TO USE "VOCABULARY", APART FROM THE MARK AS SHOWN.

CLASS 9—ELECTRICAL AND SCIENTIFIC APPARATUS

FOR EDUCATIONAL INSTRUCTIONAL MATERIALS IN THE FIELD OF EDUCATION AND TEACHING LEARNING SKILLS, NAMELY, PRE-RECORDED TAPES, CD ROMS AND/OR DISCS, BOOKS AND PRINTED LEARNING CARDS, SOLD AS A UNIT (U.S. CLS. 21, 23, 26, 36 AND 38).

CLASS 42—SCIENTIFIC, COMPUTER AND LEGAL SERVICES

FOR PROVIDING ON-LINE BOOKS, NEWSLETTERS, ARTICLES, MAGAZINES AND STORIES, ALL IN THE FIELDS OF EDUCATION, TEACHING LEARNING SKILLS AND CURRENT EVENTS; AND PROVIDING INFORMATION IN THE FIELD OF CURRENT EVENTS (U.S. CLS. 100 AND 101).

SN 75-863,742. CROSSGENERATION COMICS, INC., OLDSMAR, FL. FILED 12-3-1999.

MERIDIAN

CLASS 9—ELECTRICAL AND SCIENTIFIC APPARATUS

FOR INTERACTIVE VIDEO GAME PROGRAMS (U.S. CLS. 21, 23, 26, 36 AND 38).

CLASS 16—PAPER GOODS AND PRINTED MATTER

FOR PRINTED MATERIALS AND PUBLICATIONS, NAMELY, POSTERS, ACTION AND PICTURE STORIES CONTAINING MEMORABILIA RELATING TO FICTIONAL CHARACTERS, COMIC BOOKS AND PRINTED STORIES IN ILLUSTRATED FORM FEATURED IN BOOKS AND MAGAZINES (U.S. CLS. 2, 5, 22, 23, 29, 37, 38 AND 50).

CLASS 28—TOYS AND SPORTING GOODS

FOR GAMES AND TOYS, NAMELY, HAND HELD UNIT FOR PLAYING VIDEO GAMES, TOY ACTIONS FIGURES AND ACCESSORIES THEREFOR; CHILDREN'S MULTIPLE ACTIVITY TOYS; ACTION SKILL GAMES; PET TOYS; CARD GAMES; JIGSAW PUZZLES; LATEX SQUEEZE TOY FIGURES; PLUSH TOYS; FABRIC DOLLS, SOFT SCULPTURE INFANT TOYS; POP-UP TOYS; MECHANICAL RUBBER ACTION TOYS; MUSICAL TOYS; ACTION FIGURE CLOTHING; PARTY FAVORS IN THE NATURE OF SMALL TOYS; BALLOONS; AND BEAN BAGS (U.S. CLS. 22, 23, 38 AND 50).

SN 75-869,073. GERMAIN GROUP INC., SAINTE-FOY, QUEBEC, CANADA, BY CHANGE OF NAME DEVELOPEMENT GERMAIN DES PRES INC, SAINTE-FOY, QUEBEC, CANADA, FILED 12-10-1999.

H₂OTEL

PRIORITY CLAIMED UNDER SEC. 44(D) ON CANADA APPLICATION NO. 1027902, FILED 9-3-1999, REG. NO. TMA546939, DATED 6-21-2001, EXPIRES 6-21-2016.

CLASS 32—LIGHT BEVERAGES

FOR NON-ALCOHOLIC BEVERAGES, NAMELY CARBONATED WATER AND NATURAL SPRING WATER (U.S. CLS. 45, 46 AND 48).

CLASS 42—SCIENTIFIC, COMPUTER AND LEGAL SERVICES

FOR HOTEL SERVICES; CONVENTION AND MEETING SERVICES, NAMELY, THE PROVIDING OF SERVICES IN CONNECTION WITH THE HOLDING OF CONVENTIONS AND MEETINGS INCLUDING MEETING SPACE, FOOD AND BEVERAGE FACILITIES, AND ROOM ACCOMMODATIONS; RESTAURANT SERVICES AND BAR SERVICES (U.S. CLS. 100 AND 101).

SN 75-871,358. TELEDYNE LIGHTING AND DISPLAY PRODUCTS, INC., HAWTHORNE, CA. FILED 12-14-1999.

BLACKHOLE

CLASS 9—ELECTRICAL AND SCIENTIFIC APPARATUS

FOR LCD DISPLAYS AND LED OPTICAL ENHANCEMENTS THAT SHAPE AND DIRECT LIGHT IN COMMERCIAL, INDUSTRIAL AND RESIDENTIAL LIGHTING SYSTEMS (U.S. CLS. 21, 23, 26, 36 AND 38).

CLASS 11—ENVIRONMENTAL CONTROL APPARATUS

FOR BACKLIGHT ILLUMINATORS, DECORATIVE LIGHTING, LINEAR LIGHTING AND COMMERCIAL, INDUSTRIAL AND RESIDENTIAL ELECTRICAL LIGHTING FIXTURES FOR GENERAL ILLUMINATION (U.S. CLS. 13, 21, 23, 31 AND 34).

SN 75-871,900. DIRECTECH, INC., LEXINGTON, MA. FILED 12-15-1999.

DIRECTECH/EMERGE

OWNER OF U.S. REG. NOS. 1,294,873 AND 2,075,143.

CLASS 35—ADVERTISING AND BUSINESS

FOR ADVERTISING AGENCY SERVICES; DIRECT MAIL ADVERTISING VIA THE GLOBAL COMPUTER NETWORK (U.S. CLS. 100, 101 AND 102).

CLASS 42—SCIENTIFIC, COMPUTER AND LEGAL SERVICES

FOR DATABASE DEVELOPMENT SERVICES (U.S. CLS. 100 AND 101).

SN 75-872,419. JOCK TAMSON'S INTERNATIONAL LIMITED, ABERDEEN AB11 6JE, UNITED KINGDOM, FILED 12-15-1999.

JOCK TAMSON'S WE'RE A JOCK TAMSON'S BAIRNS

"JOCK TAMSON" IS A FICTITIOUS INDIVIDUAL.

CLASS 24—FABRICS

FOR TEA TOWELS, DISH CLOTHS (U.S. CLS. 42 AND 50).

CLASS 25—CLOTHING

FOR T-SHIRTS, SWEATERS, SHORTS, UNDERWEAR, JACKETS, COATS, HATS, CAPS, KILTS, TIES, SHIRTS, SKIRTS (U.S. CLS. 22 AND 39).

CLASS 26—FANCY GOODS

FOR WIGS (U.S. CLS. 37, 39, 40, 42 AND 50).

CLASS 33—WINES AND SPIRITS

FOR WHISKEY (U.S. CLS. 47 AND 49).

SN 75-872,799. DURON, INC., BELTSVILLE, MD. FILED 12-16-1999.

CLASS 42—SCIENTIFIC, COMPUTER AND LEGAL SERVICES

FOR BAR AND RESTAURANT SERVICES (U.S. CLS. 100 AND 101).



OWNER OF U.S. REG. NOS. 1,197,587 AND 1,293,664.
THE STIPPLING IN THE DRAWING IS FOR SHADING PURPOSES ONLY AND IS INTENDED TO ILLUSTRATE THE DEMARCATIONS BETWEEN THE COLORS IN THE MARK. THE MARK INCLUDES THE COLORS BLUE, RED, ORANGE AND GREEN.

SN 75-872,675. YESHIVAT AISH HATORAH, JERUSALEM 91141, ISRAEL, FILED 12-15-1999.

AISH HATORAH

THE ENGLISH TRANSLATION OF "AISH HATORAH" IS "THE FLAME OF TORAH".

CLASS 9—ELECTRICAL AND SCIENTIFIC APPARATUS

FOR PRE-RECORDED AUDIO CASSETTE FEATURING INFORMATION ABOUT TORAH AND JUDAISM (U.S. CLS. 21, 23, 26, 36 AND 38).
FIRST USE 0-0-1974; IN COMMERCE 0-0-1979.

CLASS 16—PAPER GOODS AND PRINTED MATTER

FOR PRINTED MATTER NAMELY, BOOKS, CLASS OUTLINES, WORKBOOKS, MANUALS, REPORTS, BROCHURES, PAMPHLETS AND NEWSLETTERS FEATURING INFORMATION ABOUT TORAH AND JUDAISM (U.S. CLS. 2, 5, 22, 23, 29, 37, 38 AND 50).
FIRST USE 0-0-1974; IN COMMERCE 0-0-1979.

CLASS 39—TRANSPORTATION AND STORAGE

FOR ARRANGING AND CONDUCTING RELIGIOUS TRIPS (U.S. CLS. 100 AND 105).
FIRST USE 0-0-1974; IN COMMERCE 0-0-1979.

CLASS 41—EDUCATION AND ENTERTAINMENT

FOR OFFERING EDUCATIONAL PROGRAMS SPECIFICALLY PROGRAMS FOR POST-COLLEGE YOUNG PEOPLE, EXECUTIVES AND PROFESSIONALS, TRAVELERS, AND STUDENTS RELATING TO ISRAEL AND JUDAISM (U.S. CLS. 100, 101 AND 107).
FIRST USE 0-0-1974; IN COMMERCE 0-0-1979.

CLASS 42—SCIENTIFIC, COMPUTER AND LEGAL SERVICES

FOR SERVICES IN THE NATURE OF OFFERING RELIGIOUS WORSHIP PROGRAMS (U.S. CLS. 100 AND 101).
FIRST USE 0-0-1974; IN COMMERCE 0-0-1979.

CLASS 2—PAINTS

FOR EXTERIOR AND INTERIOR PAINTS; WOOD STAINS; INDUSTRIAL COATINGS, NAMELY, COATINGS IN THE NATURE OF PAINTS FOR FLOORS, INDUSTRIAL MACHINERY, PIPES AND INDUSTRIAL PLANTS; PAINT THINNERS; PAINT PRIMERS AND PAINT SEALERS (U.S. CLS. 6, 11 AND 16).
FIRST USE 7-0-1984; IN COMMERCE 7-0-1984.

CLASS 16—PAPER GOODS AND PRINTED MATTER

FOR PAINT BRUSHES; PAINT APPLICATOR ROLLERS; PAINT STIRRERS AND PADDLERS; AND PAINT TRAYS (U.S. CLS. 2, 5, 22, 23, 29, 37, 38 AND 50).
FIRST USE 7-0-1984; IN COMMERCE 7-0-1984.

CLASS 17—RUBBER GOODS

FOR CAULKING (U.S. CLS. 1, 5, 12, 13, 35 AND 50).
FIRST USE 7-0-1984; IN COMMERCE 7-0-1984.

CLASS 35—ADVERTISING AND BUSINESS

FOR RETAIL STORE SERVICES FOR PAINTS, WALLCOVERINGS AND ACCESSORIES; NAMELY, WALLCOVERINGS AND PAINT ACCESSORIES (U.S. CLS. 100, 101 AND 102).
FIRST USE 7-0-1984; IN COMMERCE 7-0-1984.

SN 75-874,664. ACHACHE, RAQUEL, 75006, PARIS, FRANCE, FILED 12-17-1999.

OCABA

PRIORITY CLAIMED UNDER SEC. 44(D) ON FRANCE APPLICATION NO. 99803406, FILED 7-12-1999, REG. NO. 99803406, DATED 7-12-1999, EXPIRES 7-12-2009.

CLASS 18—LEATHER GOODS

FOR BAGS MADE OF LEATHER OR IMITATION LEATHER, NAMELY, HANDBAGS, CLUTCH BAGS, SHOULDER BAGS, TOTE BAGS, TRAVEL BAGS, SHOPPING BAGS; PURSES, VALISES; LUGGAGE, SUITCASES, TRAVELING TRUNKS, UMBRELLAS (U.S. CLS. 1, 2, 3, 22 AND 41).
FIRST USE 9-2-1999; IN COMMERCE 3-9-2000.

CLASS 25—CLOTHING

FOR CLOTHING, NAMELY, BELTS, FOOTWEAR, HEAD WEAR, COATS, JACKETS, DRESSES, GLOVES, NECKWEAR, SLACKS, PANTS, SHIRTS, BLOUSES, SHORTS, SKIRTS, SLEEPWEAR, SOCKS, STOCKINGS, SUITS, SWEATERS, SUSPENDERS, UNDERGARMENTS (U.S. CLS. 22 AND 39).

SN 75-877,674. TV FILES S.P.A., ROMA, ITALY, FILED 12-22-1999.



PRIORITY CLAIMED UNDER SEC. 44(D) ON ITALY APPLICATION NO. RM99C004163, FILED 8-19-1999, REG. NO. 842895, DATED 3-28-2001, EXPIRES 8-19-2019.

NO CLAIM IS MADE TO THE EXCLUSIVE RIGHT TO USE "TV", APART FROM THE MARK AS SHOWN.

CLASS 38—COMMUNICATION

FOR VIDEO BROADCASTING; BROADCASTING PROGRAMS VIA A GLOBAL COMPUTER NETWORK; VIDEO-ON-DEMAND TRANSMISSION SERVICES (U.S. CLS. 100, 101 AND 104).

CLASS 41—EDUCATION AND ENTERTAINMENT

FOR SCHEDULING OF PROGRAMS ON A GLOBAL COMPUTER NETWORK; TELEVISION SCHEDULING AND PROGRAMMING (U.S. CLS. 100, 101 AND 107).

CLASS 42—SCIENTIFIC, COMPUTER AND LEGAL SERVICES

FOR NEWS SYNDICATION FOR THE BROADCASTING INDUSTRY (U.S. CLS. 100 AND 101).

SN 75-879,507. VANTAGE MOTORWORKS, INC., MIAMI, FL. FILED 12-23-1999.

VANTAGE MOTORWORKS

NO CLAIM IS MADE TO THE EXCLUSIVE RIGHT TO USE "MOTORWORKS", APART FROM THE MARK AS SHOWN.

CLASS 35—ADVERTISING AND BUSINESS

FOR AUTOMOBILE DEALERSHIP SERVICES FEATURING VINTAGE, ANTIQUE AND FINE IMPORTED AUTOMOBILES (U.S. CLS. 100, 101 AND 102).
FIRST USE 12-18-1974; IN COMMERCE 12-18-1974.

CLASS 37—CONSTRUCTION AND REPAIR

FOR SERVICING, REPAIR AND RESTORATION OF AUTOMOBILES, NAMELY, VINTAGE, ANTIQUE AND FINE IMPORTED AUTOMOBILES (U.S. CLS. 100, 103 AND 106).
FIRST USE 12-18-1974; IN COMMERCE 12-18-1974.

SN 75-882,122. KRESTA BLINDS LIMITED, MALAGA, WESTERN AUSTRALIA, AUSTRALIA, FILED 12-28-1999.

KRESTA

OWNER OF AUSTRALIA REG. NO. 711564, DATED 6-26-1996, EXPIRES 6-26-2006.

CLASS 6—METAL GOODS

FOR METAL AWNINGS, BLINDS, DOORS AND PARTS THEREFOR (U.S. CLS. 2, 12, 13, 14, 23, 25 AND 50).

CLASS 19—NON-METALLIC BUILDING MATERIALS

FOR NON-METAL DOORS AND PARTS THEREFOR (U.S. CLS. 1, 12, 33 AND 50).

CLASS 20—FURNITURE AND ARTICLES NOT OTHERWISE CLASSIFIED

FOR OUTDOOR WINDOW BLINDS; DOOR AND WINDOW TREATMENTS, NAMELY VENETIAN BLINDS, WINDOW BLINDS, VERTICAL BLINDS, PLEATED BLINDS, HOLLAND BLINDS, ROLLER BLINDS; AND PARTS THEREFOR (U.S. CLS. 2, 13, 22, 25, 32 AND 50).

CLASS 22—CORDAGE AND FIBERS

FOR AWNINGS AND PARTS THEREFOR (U.S. CLS. 1, 2, 7, 19, 22, 42 AND 50).

CLASS 24—FABRICS

FOR DOOR AND WINDOW TREATMENTS, NAMELY CURTAINS AND PARTS THEREFOR, ROMAN BLINDS, VERTICAL BLINDS, PLEATED BLINDS, HOLLAND BLINDS, ALL MADE OF FABRIC, AND PARTS THEREFOR; AND TEXTILE GOODS, NAMELY ROLLS OF COTTON, POLYESTER, NYLON, ACRYLIC, RAYON OR POLYESTER/COTTON MIX FABRIC (U.S. CLS. 42 AND 50).

SN 75-883,111. WATSON-MARLOW LIMITED, CORNWALL TR11 4RU, UNITED KINGDOM, FILED 12-17-1999.

FLAWSIL

PRIORITY CLAIMED UNDER SEC. 44(D) ON ERPNTY TM OFC APPLICATION NO. 1223411, FILED 6-23-1999, REG. NO. 1223411, DATED 8-3-2000, EXPIRES 6-23-2009.

CLASS 7—MACHINERY

FOR PERISTALTIC PUMPS FOR INDUSTRIAL PURPOSES (U.S. CLS. 13, 19, 21, 23, 31, 34 AND 35).

CLASS 9—ELECTRICAL AND SCIENTIFIC APPARATUS

FOR TUBES, PIPEWORK AND TUBING FOR SCIENTIFIC AND LABORATORY PURPOSES AS WELL AS FOR USE IN BIOTECHNOLOGY AND BIO-MEDICINE; FLEXIBLE TUBES, PIPEWORK AND TUBING FOR PERISTALTIC PUMPS FOR SCIENTIFIC, LABORATORY AND BIOTECHNOLOGY PURPOSES (U.S. CLS. 21, 23, 26, 36 AND 38).

CLASS 17—RUBBER GOODS

FOR NON-METAL HOSE AND TUBES AND NON-METAL FLEXIBLE PIPES, ALL FOR THE DELIVERY OF LIQUIDS; PLASTIC HOSE AND TUBING FOR THE DELIVERY OF LIQUIDS FOR SCIENTIFIC AND LABORATORY USE AND FOR USE IN THE FOOD, BEVERAGE, BIOTECHNOLOGY AND PHARMACEUTICAL INDUSTRIES (U.S. CLS. 1, 5, 12, 13, 35 AND 50).

SN 75-889,297. MGI COUTIER, CHEZERY, FRANCE, FILED 1-6-2000.

SN 75-885,255. VAZIRANI, MINAL, ANAHEIM HILLS, CA. FILED 1-7-2000.

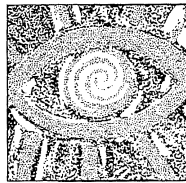

saffronsoul.com

THE MARK CONSISTS, IN PART, OF A STYLIZED VERSION OF AN EYE.

CLASS 35—ADVERTISING AND BUSINESS

FOR COMPUTERIZED ON-LINE DISTRIBUTORSHIPS AND RETAIL SERVICES IN THE FIELD OF HOLISTIC HEALTH AND ALTERNATIVE PREVENTATIVE CARE PRODUCTS, NAMELY, DIETARY SUPPLEMENTS, SPICES, BOOKS, PRE-RECORDED CASSETTE TAPES AND MULTIMEDIA SOFTWARE RECORDED ON CD-ROMS IN THE FIELD OF DIET AND NUTRITION, SPICES AND COOKING SUPPLIES (U.S. CLS. 100, 101 AND 102).

CLASS 42—SCIENTIFIC, COMPUTER AND LEGAL SERVICES

FOR COMPUTER SERVICES, NAMELY, PROVIDING DATABASES FEATURING GENERAL AND LOCAL COMMUNITY NEWS INFORMATION OF INTEREST TO SPECIFIC GEOGRAPHIC AREAS; PROVIDING HOLISTIC HEALTH CARE AND ALTERNATIVE MEDICINE INFORMATION VIA A GLOBAL COMPUTER INFORMATION NETWORK, NAMELY, INFORMATION ON CONDITIONS, PREVENTATIVE CARE, NUTRITION, EXERCISES, INSTITUTIONS AND EXPERTS (U.S. CLS. 100 AND 101).

SN 75-888,403. KENOVER MARKETING CORPORATION, BROOKLYN, NY. FILED 1-6-2000.

EMZEE

CLASS 29—MEATS AND PROCESSED FOODS

FOR POTATO CHIPS, AND FLAVORED PUFFED POTATO SNACKS (U.S. CL. 46).
FIRST USE 8-0-2000; IN COMMERCE 8-0-2000.

CLASS 30—STAPLE FOODS

FOR FLAVORED PUFFED CORN SNACKS, FLAVORED CORN CHIPS, FLAVORED PUFFED RICE SNACKS, FLAVORED RICE CAKES, PRETZELS, CHOCOLATES, WAFERS AND SALSA (U.S. CL. 46).
FIRST USE 8-0-2000; IN COMMERCE 8-0-2000.

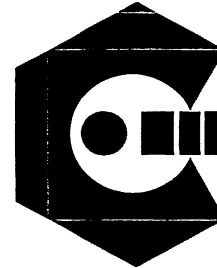

OWNER OF FRANCE REG. NO. 97688411, DATED 7-17-1997, EXPIRES 7-17-2007.

THE MARK CONSISTS OF THE FANCIFUL DEPICTION OF THE LETTERS "MGI".

CLASS 6—METAL GOODS

FOR GOODS OF COMMON METAL, NAMELY, COMMON METALS AND THEIR ALLOYS; NON-ELECTRIC CABLES AND WIRES OF COMMON METAL; IRON-MONGERY, NAMELY, DOOR STRIKERS, DOOR STOPS, AXLES FOR DOOR STOPS, SCREWS FOR TRUNK OR DOOR STRIKERS; NON-ELECTRIC CENTERING CABLES, IN PARTICULAR, BRAKE CABLES, COAXIAL CABLES, ACCELERATOR CABLES, CLUTCH CABLES, SPEEDOMETER CABLES, CONNECTING RODS, METAL INSERTS, METAL RINGS, HOLDING TABS, BRACKETS, PIPE CLAMPS, PIPE AND FITTING SUPPORTS, CLIPS; METAL NOZZLES FOR WINDSCREEN WIPERS ON VEHICLES, SOLD SEPARATELY; METAL DOOR STOPS, DOOR HINGES AND LOCKS FOR DOORS; METAL HOUSINGS FOR USE ON VEHICLES; METAL SUPPORTS FOR PLASTIC OR METAL HOUSINGS, NAMELY, WINDSHIELD WASHER TANK SUPPORTS, DEHUMIDIFIER TANK SUPPORTS, ELECTRONIC BOX SUPPORTS, WATER HEATING CASING SUPPORTS, SOLENOID VALVE CASING SUPPORTS, INTERCONNECTION BOX SUPPORTS, PREHEATING BOX SUPPORTS, AIRBAG BOX SUPPORTS; METAL COUPLINGS; METAL LOCKS, DOOR HINGES, DOOR STOPS FOR USE ON VEHICLES; METAL ELECTRICAL WIRE SUPPORTS; METALLIC SUPPORTS FOR VEHICLE BATTERIES (U.S. CLS. 2, 12, 13, 14, 23, 25 AND 50).

CLASS 7—MACHINERY

FOR FUEL INJECTORS FOR INTERNAL COMBUSTION ENGINES; INJECTORS FOR ENGINES; CYLINDER HEADS FOR ENGINES AND CYLINDER HEAD COVERS FOR ENGINES; ENGINE PARTS, NAMELY, MECHANICAL, UNIVERSAL OR FITTED ELECTRIC PUMPS; CRANKCASES FOR ENGINES; WATER PUMPS FOR USE IN MOTORS AND ENGINES AND DIAPHRAGMS THEREFOR; ENGINE COMPONENTS, NAMELY, FUEL ECONOMIZERS FOR ENGINES; CRANK SHAFTS FOR ENGINES; LAND VEHICLE ENGINE PARTS, NAMELY, AIR INTAKE DUCTS, AIR CLEANERS, ELECTRONIC AND MECHANICAL THROTTLE BODIES, AIR INTAKE MANIFOLDS, INTEGRATED AIR FUEL MODULES, KNOWN AS IAFM, WHICH ARE INTEGRATED SYSTEMS INCLUDING AIR INTAKE MANIFOLDS, RESONATORS, CAM COVER HEADS OR CYLINDER HEAD COVERS FOR ENGINES, FUEL RAILS, FUEL LINES, ENGINE BELT COVERS OR ENGINE CRANKCASE COVERS, NYH COVERS, WATER COOLING DEVICES, AIR PUMPS FOR LAND VEHICLE ENGINES (U.S. CLS. 13, 19, 21, 23, 31, 34 AND 35).

CLASS 9—ELECTRICAL AND SCIENTIFIC APPARATUS

FOR ELECTRONIC CONTROLS FOR VEHICLE ENGINES; ELECTRIC DEVICES FOR VEHICLES, NAMELY, BRANCH BOXES AND JUNCTION BOXES, PUSH/PULL SWITCHES, TOGGLE SWITCHES, ROCKER SWITCHES, ON/OFF SWITCHES, ROTARY SWITCHES, DIESEL ENGINE STOPS, VARIABLE SPEED DIESEL IDLERS, HEATING RESISTANCES, FUSE BOXES, DIODE HOLDERS, BATTERY MAIN SWITCHES, FUSE HOLDERS, LAMP SOCKETS, CABLE CONNECTORS, PLUGS AND SOCKETS, STOP LIGHTS SWITCHES, RADIATOR FAN SWITCHES, OIL PRESSURE SWITCHES, ELECTRONICALLY CONTROLLED WINDSHIELD WASHER FLUID JETS, ELECTRONIC SPIRALLY WOUND TUBES, ELECTRIC SENSORS, ACTUATORS; ELECTRIC AND ELECTRONIC EQUIPMENT FOR VEHICLES, NAMELY, DEAD POINT SENSORS, DIESEL HEATER PLUG RELAYS, RHEOSTATS, INDICATORS FOR RECORDING STRETCHES OF ROAD, FOR RECORDING THE DISTANCE OF THE CAR IN FRONT, ELECTRONIC CONTROLLERS FOR HEADLIGHT ADJUSTMENT; ELECTRIC MOTORIZED DOOR LOCKS FOR VEHICLES (U.S. CLS. 21, 23, 26, 36 AND 38).

CLASS 11—ENVIRONMENTAL CONTROL APPARATUS

FOR VENTILATION UNITS FOR USE IN VEHICLES COMPRISING HEATING AND COOLING UNITS, HEATERS AND STRUCTURAL PARTS THEREOF, AIR CONDITIONERS, AIR DUCTS, VENTS AND COLLECTORS FOR VEHICLES, VENTILATION GRIDS FOR VEHICLES; LIGHTING UNITS FOR VEHICLES, NAMELY, HEADLIGHTS, FOG LAMPS, DASH BOARD LIGHTING, INTERNAL DOOR SWITCH LIGHTING; VEHICLE COOLANT RECOVERY SYSTEMS COMPRISED OF PIPES, NOZZLES, WATER PUMPS, PIPE AND TUBE COUPLINGS, RESERVOIRS, CLEANERS AND FILTER, SOLD SEPARATELY OR AS A UNIT; LIGHTS FOR DASHBOARD GAUGES FOR VEHICLES, INCLUDING SPECIFIC LIGHTS FOR THE ARMY, MINIRELAYS, CENTRAL WARNING RELAY SYSTEMS, MAP READER LIGHTS, HEATING DEVICES, NAMELY, FAST PREHEATING RODS FOR VEHICLES, PLASTIC HEATING CONDUITS (U.S. CLS. 13, 21, 23, 31 AND 34).

CLASS 12—VEHICLES

FOR VEHICLES, NAMELY, APPARATUS FOR LOCOMOTION BY LAND, AIR OR WATER, NAMELY, AUTOMOBILES, OFF-ROAD ALL TERRAIN MOTOR VEHICLES, TRUCKS, MOTOR LORRIES, VANS, BUSES, AIRPLANES, HELICOPTERS, SEAPLANES, GLIDERS, HANG GLIDERS, BOATS; TRANSMISSIONS FOR LAND VEHICLES AND CRANKCASES THEREFOR; ENGINES FOR VEHICLES; ACCESSORIES FOR VEHICLES, NAMELY, MUDGUARDS, WINDSCREENS AND NOZZLES THEREFOR SOLD AS A UNIT; TANKS, PUMPS, NOZZLES AND PLASTIC CONNECTORS FOR WINDSCREEN WASHING UNITS, BUMPERS FOR VEHICLES, WINDSCREEN WIPER AIR-FLOW WEIGHING, BUMPERS, HORNS, MUD FLAPS FOR VEHICLES, GASOLINE TANK CAPS AND TRAIN PLUGS, STRIPS FOR VEHICLE BODIES; ASHTRAYS FOR VEHICLES, ROOF CONSOLES FOR VEHICLES; NON-METALLIC FITTINGS FOR DOORS, NAMELY, PLASTIC PANELING FOR PASSENGER CELL, INTERIOR AND EXTERIOR DOOR HANDLES; NON-METALLIC FITTINGS FOR OTHER VEHICLE PARTS, NAMELY, SEAT COVERS (U.S. CLS. 19, 21, 23, 31, 35 AND 44).

CLASS 20—FURNITURE AND ARTICLES NOT OTHERWISE CLASSIFIED

FOR PLASTIC SUPPORTS FOR USE ON VEHICLES, NON-METALLIC SUPPORTS FOR ELECTRIC AND ELECTRONIC BEAMS ON VEHICLES; NON-METAL ELECTRICAL WIRE SUPPORTS; NON-METAL SUPPORTS FOR VEHICLE BATTERIES; NONMETALLIC STORAGE TANKS CONTAINING WATER FOR VEHICLES OR OIL FOR SCOOTERS; NON-METALLIC NOZZLES, PIPE AND TUBE COUPLINGS FOR WINDSCREEN WIPERS ON VEHICLES, SOLD SEPARATELY, PLASTIC CONTROL BUTTON CAPS; PLASTIC KNOBS; NON-METALLIC LOCKS FOR VEHICLES, NAMELY, LOCK STOPS, LOCK PROTECTION COVERS, LOCK DEFLECTING COVERS; PLASTIC SCREWS; PLASTIC DOOR STOPS AND PLASTIC DOOR HINGES (U.S. CLS. 2, 13, 22, 25, 32 AND 50).

CLASS 21—HOUSEWARES AND GLASS

FOR UNFINISHED GLASS FOR VEHICLE WINDOWS (U.S. CLS. 2, 13, 23, 29, 30, 33, 40 AND 50).

CLASS 40—MATERIAL TREATMENT

FOR CUSTOM MANUFACTURE OF PLASTICS FOR USE IN THE FIELD OF MOTOR VEHICLES (U.S. CLS. 100, 103 AND 106).

CLASS 42—SCIENTIFIC, COMPUTER AND LEGAL SERVICES

FOR RESEARCH, DEVELOPMENT AND DESIGN OF NEW PRODUCTS FOR OTHERS IN THE FIELD OF VEHICLE SPECIFICALLY, NEW TECHNOLOGIES APPLIED TO LAND, AIR AND WATER VEHICLES AND THE EQUIPMENT USED THEREFORE (U.S. CLS. 100 AND 101).

SN 75-889,552. TRUDELL MEDICAL INTERNATIONAL, LONDON, ONTARIO, CANADA, FILED 1-7-2000.

**CLASS 10—MEDICAL APPARATUS**

FOR MEDICAL APPARATUS, NAMELY, HOLDING CHAMBERS USED IN CONJUNCTION WITH AEROSOL DISPENSING DEVICES, PEAK FLOW METERS, AND NEBULIZERS USED TO ATOMIZE A LIQUID IN AEROSOL FORM (U.S. CLS. 26, 39 AND 44).

CLASS 16—PAPER GOODS AND PRINTED MATTER

FOR PAMPHLETS, NEWSLETTERS, POSTERS, AND PRINTED TEACHING MATERIALS IN THE FIELDS OF RESPIRATORY DISEASES (U.S. CLS. 2, 5, 22, 23, 29, 37, 38 AND 50).

CLASS 41—EDUCATION AND ENTERTAINMENT

FOR EDUCATIONAL SERVICES, NAMELY, CONDUCTING CONFERENCES, SEMINARS, WORKSHOPS, AND CLASSES IN THE FIELDS OF RESPIRATORY DISEASES DIRECTED AT PATIENTS, PATIENTS' FAMILIES, HEALTH CARE PROVIDERS, HOSPITALS, AND PHARMACIES; AND CONFERENCES, SEMINARS, WORKSHOPS, AND CLASSES ON THE PROPER USE OF HOLDING CHAMBERS, PEAK FLOW METERS, NEBULIZERS, AND OTHER RELATED DEVICES USED TO TREAT OR MANAGE RESPIRATORY DISEASES (U.S. CLS. 100, 101 AND 107).

SN 75-889,695. IKON OFFICE SOLUTIONS WEST, INC., PORTLAND, OR. FILED 1-6-2000.

THE WAY BUSINESS GETS COMMUNICATED

CLASS 35—ADVERTISING AND BUSINESS

FOR DISTRIBUTORSHIP SERVICES IN THE FIELD OF OFFICE EQUIPMENT; LICENSING OF COMPUTER SOFTWARE; BUSINESS CONSULTATION SERVICES IN THE FIELD OF TEMPORARY EMPLOYMENT AND OUTSOURCING; PHOTOCOPYING, FINISHING AND BINDING DOCUMENTS (U.S. CLS. 100, 101 AND 102).
FIRST USE 12-27-1999; IN COMMERCE 12-27-1999.

CLASS 37—CONSTRUCTION AND REPAIR

FOR SERVICING OF OFFICE EQUIPMENT (U.S. CLS. 100, 103 AND 106).
FIRST USE 12-27-1999; IN COMMERCE 12-27-1999.

CLASS 39—TRANSPORTATION AND STORAGE

FOR ELECTRONIC STORAGE OF DATA AND DOCUMENTS (U.S. CLS. 100 AND 105).
FIRST USE 12-27-1999; IN COMMERCE 12-27-1999.

CLASS 40—MATERIAL TREATMENT

FOR DIGITAL IMAGING SERVICES, ELECTRONIC IMAGING, SCANNING, DIGITIZING, ALTERATION OF DOCUMENTS AND IMAGES (U.S. CLS. 100, 103 AND 106).
FIRST USE 12-27-1999; IN COMMERCE 12-27-1999.

CLASS 42—SCIENTIFIC, COMPUTER AND LEGAL SERVICES

FOR COMPUTER PROGRAMMING FOR OTHERS; COMPUTER SOFTWARE DESIGN AND DEVELOPMENT SERVICES FOR OTHERS (U.S. CLS. 100 AND 101).
FIRST USE 12-27-1999; IN COMMERCE 12-27-1999.

SN 75-890,979. CIGARETTE RACING TEAM, INC., AVENTURA, FL. FILED 1-7-2000.

CIGARETTE

CLASS 6—METAL GOODS

FOR BASED ON USE IN COMMERCE; METAL KEY CHAINS AND METAL LICENSE PLATES (U.S. CLS. 2, 12, 13, 14, 23, 25 AND 50).
FIRST USE 0-0-1969; IN COMMERCE 0-0-1969.

CLASS 8—HAND TOOLS

FOR BASED ON INTENT TO USE; POCKET KNIVES (U.S. CLS. 23, 28 AND 44).

CLASS 9—ELECTRICAL AND SCIENTIFIC APPARATUS

FOR BASED ON INTENT TO USE; SUNGLASSES (U.S. CLS. 21, 23, 26, 36 AND 38).

CLASS 14—JEWELRY

FOR BASED ON INTENT TO USE; WATCHES, CLOCKS, JEWELRY, LIGHTERS (U.S. CLS. 2, 27, 28 AND 50).

CLASS 16—PAPER GOODS AND PRINTED MATTER

FOR BASED ON USE IN COMMERCE; PRIORITY APPLICATION PICTORIAL PRINTS (U.S. CLS. 2, 5, 22, 23, 29, 37, 38 AND 50).
FIRST USE 0-0-1969; IN COMMERCE 0-0-1969.

CLASS 18—LEATHER GOODS

FOR BASED ON USE IN COMMERCE; BACK PACKS, SPORT BAGS, LUGGAGE (U.S. CLS. 1, 2, 3, 22 AND 41).
FIRST USE 0-0-1969; IN COMMERCE 0-0-1969.

CLASS 21—HOUSEWARES AND GLASS

FOR BASED ON USE IN COMMERCE; MUGS, GLASSES, DECANTERS (U.S. CLS. 2, 13, 23, 29, 30, 33, 40 AND 50).
FIRST USE 0-0-1969; IN COMMERCE 0-0-1969.

CLASS 24—FABRICS

FOR BASED ON USE IN COMMERCE; TOWELS (U.S. CLS. 42 AND 50).
FIRST USE 0-0-1969; IN COMMERCE 0-0-1969.

CLASS 25—CLOTHING

FOR BASED ON USE IN COMMERCE; MEN'S, WOMEN'S AND CHILDREN'S APPAREL, NAMELY, PLAY-SUITS, SHIRTS, T-SHIRTS, SWEATSHIRTS, TOPS, TANK TOPS, SHORTS, BOTTOMS, PANTS, JEANS, JACKETS, LEATHER JACKETS, COATS, SKIRTS, BLOUSES, DRESSES, BODY SUITS, JUMPERS, BATHING SUITS, SUITS, SLEEPWEAR, PAJAMAS, LINGERIE, NIGHT GOWNS, UNDERWEAR, BRAS, BRIEFS, PANTIES, HOSIERY, BELTS, GLOVES, SOCKS, TROUSERS, SCARVES, FOOTWEAR, CAPS, AND HATS (U.S. CLS. 22 AND 39).
FIRST USE 0-0-1969; IN COMMERCE 0-0-1969.

CLASS 28—TOYS AND SPORTING GOODS

FOR BASED ON INTENT TO USE ; MODEL RADIO CONTROLLED BOATS (U.S. CLS. 22, 23, 38 AND 50).

SN 75-894,804. JOYFUL HEART MINISTRIES, ROCKLIN, CA. FILED 1-8-2000.

JESUSWALK

CLASS 16—PAPER GOODS AND PRINTED MATTER

FOR STUDY BOOKS, PRINTED SERIAL PUBLICATIONS, NAMELY, MAGAZINES AND NEWSPAPERS, BOOKLETS, NEWSPAPER COLUMNS, PRINTED ART REPRODUCTIONS, BIBLES, STATIONERY, GREETING CARDS, HYMN BOOKS, POSTCARDS, RELIGIOUS BOOKS, ALL IN REGARD TO A BIBLE AND RELIGIOUS STUDY PROGRAM (U.S. CLS. 2, 5, 22, 23, 29, 37, 38 AND 50).

FIRST USE 12-1-1999; IN COMMERCE 12-1-1999.

CLASS 41—EDUCATION AND ENTERTAINMENT

FOR EDUCATIONAL SERVICES, NAMELY, A BIBLE AND RELIGIOUS STUDY PROGRAM (U.S. CLS. 100, 101 AND 107).

FIRST USE 12-1-1999; IN COMMERCE 12-1-1999.

SN 75-897,538. NAZIONALE, DAVID J., TA D. J. NAZIONALE, NORRISTOWN, PA. FILED 1-15-2000.



CLASS 16—PAPER GOODS AND PRINTED MATTER

FOR PRINTED NOTE PADS, PRINTED POSTERS SUITABLE FOR FRAMING GREETING CARDS AND CHRISTMAS CARDS (U.S. CLS. 2, 5, 22, 23, 29, 37, 38 AND 50).

CLASS 25—CLOTHING

FOR CLOTHING FOR MEN, WOMEN AND CHILDREN, NAMELY, BRAS, PANTYHOSE, TENNIS WEAR, TENNIS SHOES, SOCKS, BELTS, T-SHIRTS, AND SHOES (U.S. CLS. 22 AND 39).

CLASS 28—TOYS AND SPORTING GOODS

FOR TENNIS BALLS (U.S. CLS. 22, 23, 38 AND 50).

SN 75-899,206. NETYOU COMPUTER COMMUNICATION CORPORATION, ORLANDO, FL. FILED 1-19-2000.

NETYOU

CLASS 9—ELECTRICAL AND SCIENTIFIC APPARATUS

FOR SELF-CONTAINED UNIT FOR PROVIDING PUBLIC ACCESS TO A GLOBAL COMPUTER NETWORK COMPRISED OF A COMPUTER, KEYBOARD, MONITOR AND CREDIT CARD READER (U.S. CLS. 21, 23, 26, 36 AND 38).

FIRST USE 10-0-1998; IN COMMERCE 10-0-1998.

CLASS 38—COMMUNICATION

FOR PROVIDING PUBLIC ACCESS TO A GLOBAL COMPUTER NETWORK (U.S. CLS. 100, 101 AND 104).

FIRST USE 10-0-1998; IN COMMERCE 10-0-1998.

SN 75-905,910. ALTAMODA LTDA., BARRANQUILLA, ATLANTICO, COLOMBIA, FILED 1-31-2000.

SILVIA TCHERASSI

PRIORITY CLAIMED UNDER SEC. 44(D) ON COLOMBIA APPLICATION NO. 9039253, FILED 6-23-1999.

PRIORITY CLAIMED UNDER SEC. 44(D) ON COLOMBIA APPLICATION NO. 99039254, FILED 6-23-1999.

THE NAME "SILVIA TCHERASSI" IDENTIFIES A LIVING INDIVIDUAL WHOSE CONSENT IS OF RECORD.

CLASS 25—CLOTHING

FOR CLOTHING, NAMELY, JACKETS, PANTS, SKIRTS, DRESSES, SOCKS, SHOES, AND HATS (U.S. CLS. 22 AND 39).

FIRST USE 12-14-1999; IN COMMERCE 12-14-1999.

CLASS 35—ADVERTISING AND BUSINESS

FOR RETAIL STORE SERVICES IN THE FIELD OF CLOTHING (U.S. CLS. 100, 101 AND 102).

FIRST USE 12-14-1999; IN COMMERCE 12-14-1999.

SN 75-907,805. TATUM CFO PARTNERS, LLP, ATLANTA, GA. FILED 2-2-2000.

4 M'S

CLASS 35—ADVERTISING AND BUSINESS

FOR BUSINESS SERVICES, NAMELY CONSULTATION WITH BUSINESSES TO PROVIDE A CONCEPTUAL FRAMEWORK FOR ANALYZING AND COMMUNICATING A BUSINESS'S PARTICULAR ISSUES, OPPORTUNITIES AND CURRENT STATE BY FOCUSING ON FOUR ASPECTS OF THE BUSINESS - MARKET, MANAGEMENT, BUSINESS MODEL AND FINANCES (U.S. CLS. 100, 101 AND 102).

CLASS 41—EDUCATION AND ENTERTAINMENT

FOR EDUCATIONAL SEMINARS RELATED TO BUSINESS MANAGEMENT AND PRINTED MATERIAL RELATED THERETO (U.S. CLS. 100, 101 AND 107).

SN 75-910,795. HEALTHVISION, INC., IRVING, TX. FILED 2-2-2000.

HEALTHVISION.MD

OWNER OF U.S. REG. NO. 1,849,025.

CLASS 9—ELECTRICAL AND SCIENTIFIC APPARATUS

FOR COMPUTER SOFTWARE TO BE USED BY HOSPITALS AND HEALTH CARE PROVIDERS FOR USE IN FINANCIAL MANAGEMENT, FINANCIAL ADMINISTRATION, CLINICAL MANAGEMENT, PATIENT ASSESSMENT, RECORD ABSTRACTION, RESOURCE PLANNING AND ALLOCATION, PATIENT ADMISSION, DISCHARGE, AND TRANSFER FUNCTIONS, ENTERPRISE-WIDE IDENTIFICATION OF PATIENTS, DOCTORS AND STAFF, FOR THE PURPOSE OF FACILITATING THE DAY-TO-DAY OPERATIONS OF HOSPITALS AND OTHER HEALTH CARE PROVIDERS, NAMELY, PATIENT CARE, PATIENT SCHEDULING AND REGISTRATION, PATIENT BILLING, AND FINANCIAL AND RESOURCE MANAGEMENT, AND INSTRUCTION MANUALS SOLD AS A UNIT THEREWITH (U.S. CLS. 21, 23, 26, 36 AND 38).

CLASS 35—ADVERTISING AND BUSINESS

FOR COMPUTERIZED DATABASE MANAGEMENT SERVICES, NAMELY PROVIDING CUSTOMERS WITH SERVICES FOR PROCESSING AND MANAGING DATA THROUGH GLOBAL COMPUTER NETWORKS (U.S. CLS. 100, 101 AND 102).

CLASS 42—SCIENTIFIC, COMPUTER AND LEGAL SERVICES

FOR TECHNICAL CONSULTATION AND SUPPORT SERVICES, NAMELY, TROUBLESHOOTING OF COMPUTER HARDWARE AND SOFTWARE PROBLEMS VIA TELEPHONE, E-MAIL, AND IN PERSON IN THE FIELDS OF PATIENT CARE, PATIENT SCHEDULING AND REGISTRATION, PATIENT BILLING, AND FINANCIAL AND RESOURCE MANAGEMENT, INCLUDING CONSULTING SERVICES IN HOW TO USE AUTOMATION, NAMELY, COMPUTER SOFTWARE, COMPUTER SYSTEMS AND GLOBAL COMPUTER NETWORKS TO FACILITATE THE COMMUNICATION AND STORAGE OF INFORMATION USED BY HEALTH CARE PROVIDERS IN THE COURSE OF ADMINISTRATION AND PATIENT CARE (U.S. CLS. 100 AND 101).

SN 75-911,412. ARAMARK CORPORATION, PHILADELPHIA, PA. FILED 2-7-2000.

EOFFICECOFFEE

CLASS 30—STAPLE FOODS

FOR TEA; COFFEE; COFFEE SUBSTITUTES; SUGAR; COOKIES; CAKES; PASTRIES; AND CONFECTIONERIES, NAMELY, CANDY, CANDY BARS, CRACKERS, CORN CHIPS, CHEWING GUM, AND BUBBLE GUM (U.S. CL. 46).

CLASS 35—ADVERTISING AND BUSINESS

FOR VENDING MACHINE SERVICES (U.S. CLS. 100, 101 AND 102).

CLASS 42—SCIENTIFIC, COMPUTER AND LEGAL SERVICES

FOR CONTRACT BEVERAGE SERVICES; COFFEE SUPPLY SERVICES FOR OFFICES; AND RESTAURANTS (U.S. CLS. 100 AND 101).

SN 75-911,487. SALVAS SUB S.P.A., 15053 CASTELNUOVO SCRIVIA (AL), ITALY, FILED 2-3-2000.



PRIORITY CLAIMED UNDER SEC. 44(D) ON ITALY APPLICATION NO. SV99C000044, FILED 10-18-1999, REG. NO. 000044, DATED 10-18-1999, EXPIRES 10-18-2009.

CLASS 9—ELECTRICAL AND SCIENTIFIC APPARATUS

FOR SCIENTIFIC, NAUTICAL, GEODETIC, ELECTRICAL, ELECTRONIC, PHOTOGRAPHIC, CINEMATOGRAPHIC, OPTICAL, WEIGHING, MEASURING, SIGNALING, CONTROL RESCUE, EMERGENCY AND TEACHING INSTRUMENTS, WITH PARTICULAR REFERENCE TO NAUTICAL, MARINE, SWIMMING AND UNDERWATER DIVING, NAMELY DEPTH AND PRESSURE GAUGES, DIRECTIONAL COMPASSES, DIVE TIMERS, ELAPSE TIME INDICATORS, TANK AND REGULATOR PRESSURE GAUGES, BREATHING RATE INDICATORS, UNDERWATER DIVING CHRONOMETERS, MAGNETOMETERS, UNDERWATER STILL, MOTION PICTURE, DIGITAL AND VIDEO CAMERAS, SOUND RECORDERS, UNDERWATER BEACON LIGHTS AND EMERGENCY LIGHTS, STROBES, UNDERWATER LANTERNS AND TORCHES, WEIGHING SCALES, MEASURING STICKS AND TAPES, TWO-WAY UNDERWATER, TRANSMITTERS AND RECEIVERS, MICROPHONES AND EARPHONES, AIR TANKS, OXYGEN TANKS, AIR AND OXYGEN REGULATORS AND AIR AND OXYGEN TANK MOUTH PIECES (U.S. CLS. 21, 23, 26, 36 AND 38).

CLASS 25—CLOTHING

FOR CLOTHING FOR NAUTICAL, MARINE, SWIMMING AND DIVING ACTIVITIES, NAMELY DIVING SUITS, WETSUITS AND DRY SUITS, GLOVES, HATS, HEAD WEAR, CAPS, BOOTS, SHOES, BOOTIES, SOCKS, UNDERGARMENTS, SUITS, SHORTS, JACKETS AND PANTS (U.S. CLS. 22 AND 39).

CLASS 28—TOYS AND SPORTING GOODS

FOR SPORTS GOODS, PARTICULARLY ALL GOODS AND ACCESSORIES BEING PART OF THE EQUIPMENT FOR DIVING AND SWIMMING, NAMELY, FLIPPERS, SWIM FINS, UNDERWATER MASKS, UNDERWATER GOGGLES, SNORKELS, UNDERWATER WEIGHT BELTS, SCUBA TANK HARNESSSES, ANIMAL AND MINERAL COLLECTION PUMPGUNS FOR PROFESSIONAL AND RECREATIONAL USE, SPRING OPERATED SPEAR GUNS AND SPEARFISHING HARPOON GUNS, UNDERWATER RIFLES FOR RECREATIONAL USE, UNDERWATER SPECIMEN COLLECTION BAGS, MARKER AND LIFTING BUOYS AND BUOYANT ATTACHMENTS, GAS BUOYANCY INFLATORS, FLOATERS AND DIVING EQUIPMENT BAGS (U.S. CLS. 22, 23, 38 AND 50).

SN 75-912,595. NEWMARKET COMPANY, INC., THE, WASHINGTON, DC. FILED 2-9-2000.

INTELLIBRIDGE

CLASS 35—ADVERTISING AND BUSINESS

FOR BUSINESS RESEARCH SERVICES; BUSINESS INTELLIGENCE GATHERING, INVESTIGATION AND ANALYSIS; AND MANAGING COMPUTER DATABASES (U.S. CLS. 100, 101 AND 102).

CLASS 41—EDUCATION AND ENTERTAINMENT

FOR EDUCATIONAL SERVICES, NAMELY, PROVIDING SEMINARS, CLASSES, CONFERENCES AND WORKSHOPS IN THE FIELD OF BUSINESS TO INCLUDE BUSINESS INTELLIGENCE, ECONOMICS, U.S. AND FOREIGN POLITICS, GLOBAL ISSUES AND THE BUSINESS SECTOR (U.S. CLS. 100, 101 AND 107).

CLASS 42—SCIENTIFIC, COMPUTER AND LEGAL SERVICES

FOR PROVIDING ONLINE CUSTOM DAILY BRIEFS ON CURRENT EVENTS, BUSINESS NEWS, INTELLIGENCE INFORMATION, ECONOMIC, POLITICAL AND FINANCIAL MATTERS AND BUSINESS INFORMATION; PROVIDING LINKS TO THIRD-PARTY WEB SITES FEATURING INFORMATION OF INTEREST TO BUSINESSES; DEVELOPING COMPUTERIZED DATABASES FOR OTHERS; AND PROVIDING WEB SITES FEATURING INFORMATION IN THE FIELD OF CURRENT EVENTS, BUSINESS NEWS, INTELLIGENCE, ECONOMIC, POLITICAL AND FINANCIAL MATTERS, U.S. AND FOREIGN POLITICS, GLOBAL ISSUES, THE BUSINESS SECTOR, AND OTHER INFORMATION OF INTEREST TO BUSINESSES; AND PROVIDING LINKS TO THIRD-PARTY WEB SITES FEATURING RELATED INFORMATION (U.S. CLS. 100 AND 101).

SN 75-914,708. MOORINGS, INCORPORATED, THE, NAPLES, FL. FILED 2-10-2000.

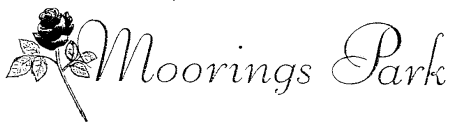

CLASS 41—EDUCATION AND ENTERTAINMENT

FOR PROVIDING EXERCISE FACILITIES; EDUCATIONAL SERVICES, NAMELY, PROVIDING A LEARNING CENTER FEATURING HIGHER EDUCATION COURSES, RECREATIONAL ACTIVITIES, AND SPECIAL PROGRAMS DESIGNED FOR OLDER ADULTS AND RETIREES (U.S. CLS. 100, 101 AND 107).

FIRST USE 9-0-1997; IN COMMERCE 9-0-1997.

CLASS 42—SCIENTIFIC, COMPUTER AND LEGAL SERVICES

FOR LIFE CARE RETIREMENT SERVICES, NAMELY PROVIDING INDEPENDENT LIVING FACILITIES, ASSISTED LIVING FACILITIES, SKILLED NURSING FACILITIES, REHABILITATION FACILITIES, MEDICAL ALERT ASSISTANCE DINING FACILITIES, CATERING SERVICES, LICENSED NURSING, PHYSICIANS ON CALL, DENTIST, AND PODIATRIST; AND INFORMATION SERVICES FOR ALL OF THE FOREGOING PROVIDED VIA A GLOBAL COMPUTER NETWORK (U.S. CLS. 100 AND 101).

FIRST USE 9-0-1997; IN COMMERCE 9-0-1997.

SN 75-918,990. CE-MA CO., LTD., TAIPEI, TAIWAN, FILED 2-16-2000.



NO CLAIM IS MADE TO THE EXCLUSIVE RIGHT TO USE "24HPOLL", APART FROM THE MARK AS SHOWN.

CLASS 35—ADVERTISING AND BUSINESS

FOR POLLING OF PUBLIC OPINION FOR BUSINESS AND/OR ADVERTISING PURPOSES; POLLING OF PUBLIC OPINION FOR BUSINESS AND/OR ADVERTISING PURPOSES THROUGH A COMPUTER NETWORK; MARKET RESEARCH SERVICES; JOB MARKET RESEARCH SERVICES IN THE FIELD OF PERSONNEL SELECTION; MARKET RESEARCH FOR COMPILING INFORMATION ON THE VIEWS OF TELEVISION VIEWERS AND RADIO LISTENERS; AND BUSINESS MANAGEMENT AND ORGANIZATION CONSULTANCY SERVICES (U.S. CLS. 100, 101 AND 102).

CLASS 42—SCIENTIFIC, COMPUTER AND LEGAL SERVICES

FOR COMPUTER SERVICES, NAMELY CREATING INDEXES ON A WIDE VARIETY OF INFORMATION OF INTEREST TO THE CONSUMING PUBLIC AND THE BUSINESS COMMUNITY, SITES, AND OTHER RESOURCES AVAILABLE ON COMPUTER NETWORKS; COMPUTER SERVICES, NAMELY SEARCHING AND RETRIEVING INFORMATION, SITES, AND OTHER RESOURCES AVAILABLE ON COMPUTER NETWORKS FOR OTHERS; PROVIDING INFORMATION IN THE FORM OF LINKS IN THE FIELDS OF OPINION POLLING, NEWS AND WEATHER, CURRENT EVENTS, AND REFERENCE MATERIALS (U.S. CLS. 100 AND 101).

SN 75-920,410. RADIANCY (ISRAEL) LTD., REHOVOT, ISRAEL, FILED 2-6-2000.



NO CLAIM IS MADE TO THE EXCLUSIVE RIGHT TO USE "PHOTOEPILATION SYSTEM", APART FROM THE MARK AS SHOWN.

CLASS 9—ELECTRICAL AND SCIENTIFIC APPARATUS

FOR LIGHT BASED HAIR REMOVAL SYSTEM COMPRISING BROAD BAND LIGHT SOURCE FOR NON-MEDICAL PURPOSES (U.S. CLS. 21, 23, 26, 36 AND 38).

CLASS 10—MEDICAL APPARATUS

FOR LIGHT BASED HAIR REMOVAL SYSTEM COMPRISING BROAD BAND LIGHT SOURCE FOR MEDICAL PURPOSES (U.S. CLS. 26, 39 AND 44).

SN 75-920,584. JOYCE, PETER, J., PORT ANGELES, WA. FILED 2-7-2000.

POLICEWORLD.COM

CLASS 35—ADVERTISING AND BUSINESS

FOR ELECTRONIC BILLBOARD ADVERTISING; OPINION POLLS FOR ADVERTISING PURPOSES; COOPERATIVE ADVERTISING AND MARKETING; RENTAL OF ADVERTISING SPACE; DISSEMINATION OF ADVERTISING FOR OTHERS VIA AN ON-LINE ELECTRONIC COMMUNICATIONS NETWORKS (U.S. CLS. 100, 101 AND 102).

CLASS 38—COMMUNICATION

FOR PROVIDING ON-LINE CHAT ROOMS FOR TRANSMISSION OF MESSAGES AMONG COMPUTER USERS CONCERNING POLICE TOPICS; PROVIDING ACCESS TO A COMPUTER NETWORK BY PROVIDING THE LINKS TO WEB SITES CONCERNING LAW ENFORCEMENT RESOURCES, EQUIPMENT, EDUCATION, TRAINING, AND RETAIL STORES FEATURING POLICE SUPPLIES AND NON-LETHAL WEAPONS (U.S. CLS. 100, 101 AND 104).

SN 75-921,256. ANGELO PO GRANDI CUCINE - SOCIETA' PER AZIONI, CARPI (MODENA), ITALY, FILED 2-16-2000.

ANGELO PO

THE NAME "ANGELO PO" IN THE MARK DOES NOT IDENTIFY A LIVING INDIVIDUAL.
THE ENGLISH TRANSLATION OF THE WORD "ANGELO" IN THE MARK IS "ANGEL".

CLASS 7—MACHINERY

FOR ELECTRIC VEGETABLE SLICING MACHINES, ELECTRIC FOOD MILLING MACHINES, ELECTRIC COFFEE GRINDER FOR DOMESTIC AND COMMERCIAL USE, ELECTRICALLY OPERATED MEAT GRINDERS, ELECTRIC FOOD MIXERS, ELECTRIC FOOD BLENDERS FOR DOMESTIC USE, CENTRIFUGES, ELECTRIC WHISKS, ELECTRIC GRATERS, ELECTRIC JUICERS FOR HOUSEHOLD USE, ELECTRIC FRUIT AND VEGETABLE PEELERS, REDUCERS FOR NON-VEHICULAR MOTORS, ELECTRICALLY OPERATED VEGETABLE PROCESSORS, ELECTRICALLY OPERATED FOOD PROCESSORS; FRONT LOADING DISHWASHING MACHINES, AUTOMATIC PASS-THROUGH DISHWASHING MACHINES, GLASS WASHING MACHINES, DISHWASHING MACHINE RACKS, CONVEYED BASKET DISHWASHING MACHINES, PAN WASHING MACHINES, LOOSE ROLL CONVEYOR UNITS FOR DISHWASHING MACHINES; MACHINES FOR MOVING TRAYS AND DISHES IN SELF-SERVICE RESTAURANTS, PASTA ROLLING MACHINES, PASTA CUTTING MACHINES (U.S. CLS. 13, 19, 21, 23, 31, 34 AND 35).

FIRST USE 12-31-1972; IN COMMERCE 9-30-1999.

CLASS 11—ENVIRONMENTAL CONTROL APPARATUS

FOR ELECTRIC VEGETABLE WASHING AND DRYING UNITS, ELECTRIC STOVES, GAS STOVES, ELECTRIC RANGES, GAS RANGES, DOMESTIC AND COMMERCIAL COOKING OVENS, CERAMIC AND GLASS PLATES SOLD AS PARTS OF OVENS AND STOVES, REFRIGERATED BEVERAGE DISPENSING UNITS, DOUBLE SIDED GLASS AND ELECTRIC ISLAND FOOD COOKING UNITS, GAS RANGES WITH OPEN BURNERS, GAS AND ELECTRIC DEEP FRYERS, GAS AND ELECTRIC FRY-TOP UNITS, ELECTRIC RANGES, GAS AND ELECTRIC CHROMIUM PLATED GRIDDLE, COUNTER-TOP GAS AND ELECTRIC GRIDDLES, GAS AND ELECTRIC PASTA MAKING PANS, GAS SOLID TOP RANGES, ELECTRICALLY HEATED COUNTER-TOP BAIN MARIE, GAS GRIDDLES, ELECTRIC GRIDDLES; GAS, STEAM AND ELECTRIC BOILING PANS; GAS AND ELECTRIC TILTING BRAISING PANS, GAS AND ELECTRIC BAIN MARIE UNIT, ELECTRIC PRESSURE COOKERS, ELECTRIC STEAM COOKERS, STEAM BOILING KETTLES, GAS AND ELECTRIC SALAMANDERS, NAMELY, A PARTICULAR KIND OF COOKING/GRILLING MACHINE, STEAM CONVECTION COMBINATION COOKING OVENS FOR DOMESTIC AND COMMERCIAL USE, REFRIGERATORS, WINE BOTTLE REFRIGERATED DISPLAYS, CHILLER CABINETS, REFRIGERATED SALAD COUNTERS, CHILLED COUNTERS, CHILLED TABLES WITH CHILLER CABINETS, FREEZERS, WALK-IN-FREEZERS, BLAST CHILLERS, BLAST CHILLERS AND FREEZERS, COLD AND FREEZER ROOMS, ICE MAKING MACHINES, REFRIGERATED MERCHANDISE DISPLAY CASES; OVEN VENTILATOR HOODS, RANGE HOODS, EXHAUST HOODS AND COMPENSATED EXHAUST HOODS FOR RANGES, AIR EXTRACTORS; SINKS, PRE-WASH SINKS, REMOVABLE SHOWERS, RINSE SPRAY ARMS; SELF SERVICE WARMING AND CHILLED UNITS FOR FOOD AND BEVERAGE; BARBECUE GRILLS (U.S. CLS. 13, 21, 23, 31 AND 34).

FIRST USE 12-31-1972; IN COMMERCE 9-30-1999.

CLASS 20—FURNITURE AND ARTICLES NOT OTHERWISE CLASSIFIED

FOR SHELVES, DISPLAY RACKS; DRAWERS, CHESTS OF DRAWERS, BENCHES, WORK BENCHES, TABLES, WORK TABLES, WORK TOPS AS PART OF WORK TABLES, CROCKERY STORAGE CABINETS, CUPBOARDS, CABINETS, SHELVING UNITS, WOODEN CHOPPING BLOCKS, HANGING CUPBOARD UNITS, SIDE TABLE FOR DISHWASHERS, PLATE RACKS; SELF SERVICE FOOD AND BEVERAGE COUNTERS (U.S. CLS. 2, 13, 22, 25, 32 AND 50).

FIRST USE 12-31-1972; IN COMMERCE 9-30-1999.

SN 75-923,277. QUANTE AG, WUPPERTAL, FED REP GERMANY, FILED 2-18-2000.



OWNER OF FED REP GERMANY REG. NO. 39944809, DATED 9-16-1999, EXPIRES 7-31-2009.

OWNER OF U.S. REG. NO. 1,985,084.

THE MARK CONSISTS OF A STYLIZED DEPICTION OF THE LETTER "Q".

CLASS 6—METAL GOODS

FOR TELEPHONE BOOTHS AND CUBICLES MADE PRIMARILY OF METAL (U.S. CLS. 2, 12, 13, 14, 23, 25 AND 50).

CLASS 9—ELECTRICAL AND SCIENTIFIC APPARATUS

FOR PHYSICAL, OPTICAL, ELECTRICAL AND ELECTRONIC APPARATUS AND INSTRUMENTS, IN EACH CASE IN THE FIELDS OF TELECOMMUNICATION TECHNOLOGY, DATA TECHNOLOGY, LASER TECHNOLOGY, OPTICAL TRANSMISSION TECHNOLOGY, VIDEO TRANSMISSION TECHNOLOGY, AS WELL AS PARTS THEREOF, NAMELY TERMINATORS, CABLE DISTRIBUTORS, LEADS, CONNECTING ELEMENTS, ISOLATORS, CONNECTORS AND ARRESTERS; TESTING AND MEASURING EQUIPMENT, NAMELY, CABLE CORE TESTERS, DAMPING MEASURING BRIDGES, INSULATION RESISTANCE MEASURING DEVICE, RADIO AND TELEPHONE TRANSMITTERS; CATHODIC ANTI-CORROSION SYSTEMS CONSISTING OF ADJUSTABLE ELECTRIC SAFETY UNITS WITH AND WITHOUT CURRENT LIMITERS, EXTERNALLY CONTROLLED ELECTRONIC DRAIN SWITCHGEARS, MEASURING, CONTROLLING AND PERMANENT PROBES, ANODES FOR EXTERNAL CURRENT SUPPLY, TEST RECTIFIERS, POTENTIAL MEASURING EQUIPMENT, NAMELY, MEASURING KITS FOR DETERMINING CONSTANT VOLTAGE POTENTIALS, CHARGE INDICATORS, VOLTMETERS; TIME CONTROL UNITS, SWITCHES, SURFACE-MOUNTED MEASURING COLUMNS, MONITORING EQUIPMENT, NAMELY, DEVICES FOR SETTING GUARD CIRCUITS, RECTIFIERS; RECTIFIERS AND MEASURING PROBES; OVERVOLTAGE PROTECTION APPARATUSES, NAMELY SURGE ARRESTERS, FUSES, SINGLE HOLDERS AND MAGAZINES FOR FUSES AND ARRESTERS, OVERVOLTAGE PROTECTION TERMINALS, MULTIPLE OVERVOLTAGE PROTECTION CONTACT STRIPS, OVERVOLTAGE COUPLERS FOR COAXIAL CABLES, TESTING EQUIPMENT, NAMELY, SURGE ARRESTERS; TELECOMMUNICATIONS AND MOBILE RADIO COMMUNICATION EQUIPMENT, NAMELY TRANSMITTERS AND RECEIVERS; CABLING MATERIAL FOR TELECOMMUNICATION APPLICATIONS, NAMELY ELECTRIC OR OPTICAL LINES OR CABLES WITH TERMINATORS, CABLE AND LINE ROUTERS; ELECTRIC CONNECTORS, NAMELY, CONNECTION AND ISOLATING STRIPS WITH SOLDERED, SCREWED OR INSULATION DISPLACEMENT CONTACTS FOR TERMINAL EQUIPMENT, FOR BRANCH EXCHANGE SYSTEMS, FOR THE INTERIOR INSTALLATION AS WELL AS FOR THE OUTDOOR INSTALLATION OF TELECOMMUNICATION EQUIPMENT; DISTRIBUTION CABINETS, CABLE TERMINAL SETS, NAMELY CABLE END PIECES, CABLE DISTRIBUTOR PLUGS, CONNECTING BLOCKS, CONNECTOR PANELS, ELECTRIC COUPLERS, CABINETS FOR TELECOMMUNICATION EQUIPMENT, ELECTRIC AND OPTICAL LINES; ELEC-

TRONIC MEASURING AND TESTING EQUIPMENT, NAMELY, TESTING FREQUENCY LIMITERS, CABLE MONITORS, LEAKAGE INDICATORS, FRAME LEAKAGE INDICATORS, CABLE TESTERS TO INSPECT CABLES FOR CONTINUITY, FOR MISTAKING AND GROUNDING OF CABLES WITH INTERCOM SYSTEM; OVERVOLTAGE PROTECTION UNITS; RAILWAY INTERCOM EQUIPMENT, CONSISTING OF FLOOR OR WALL-MOUNTED HOUSINGS COMPRISING MICROPHONES, LOUDSPEAKERS, AMPLIFIERS, POWER SUPPLY EQUIPMENT, CABLE TERMINALS, BRANCHING AND COUPLING SLEEVES; OPTICAL TRANSMITTERS AND RECEIVERS WITH POWER SUPPLIES AND MONITORING UNITS FOR THESE OPTICAL TRANSMITTERS AND RECEIVERS; LASER UNITS FOR OVERGROUND, CIVIL AND UNDERGROUND CONSTRUCTION ENGINEERING AND FOR THE COMPLETION OF THE INTERIOR EQUIPMENT, POWER SUPPLY; UNITS FOR CATHODIC ANTI-CORROSION, NAMELY PROTECTIVE CURRENT UNITS AND MONITORS, ANODES, RECTIFIERS AND MEASURING PROBES (U.S. CLS. 21, 23, 26, 36 AND 38).

CLASS 42—SCIENTIFIC, COMPUTER AND LEGAL SERVICES

FOR PRODUCT DEVELOPMENT FOR OTHERS, DESIGN ENGINEERING, AND TECHNICAL CONSULTING IN THE FIELDS OF PHYSICAL, OPTICAL, ELECTRICAL AND ELECTRONIC APPARATUS AND INSTRUMENTS, CATHODIC ANTI-CORROSION SYSTEMS AND OPTICAL TELECOMMUNICATIONS SYSTEMS AND THEIR COMPONENTS IN THE FIELDS OF TELECOMMUNICATION TECHNOLOGY, DATA TECHNOLOGY, LASER TECHNOLOGY, OPTICAL TRANSMISSION TECHNOLOGY AND VIDEO TRANSMISSION TECHNOLOGY (U.S. CLS. 100 AND 101).

SN 75-927,739. INTERLIANCE, LLC, COSTA MESA, CA. FILED 2-24-2000.

UNLOCKING A WORLD OF BUSINESS OPPORTUNITIES

CLASS 35—ADVERTISING AND BUSINESS

FOR BUSINESS MANAGEMENT AND CONSULTING SERVICES IN THE FIELDS OF BROAD-BASED MANAGEMENT, MARKETING AND OPERATIONAL SOLUTIONS, ANALYSIS, STRATEGY AND IMPLEMENTATION PROGRAMS FOR COMPANIES IN START-UP, TRANSITION, GROWTH, RESTRUCTURE, DOWNSIZING OR MERGER AND ACQUISITION, STRATEGIC BUSINESS PLANNING AND MARKETING INCLUDING PRODUCT DESIGN AND DEVELOPMENT, ADVERTISING, TECHNICAL SERVICES, CORPORATE COMMUNICATIONS, SALES DISTRIBUTION AND CHANNELING SERVICES, SALES DEVELOPMENT AND CUSTOMER SERVICES, MARKET AND PRODUCT ENTRANCE STRATEGIES, SETTING PROFESSIONAL OPERATIONAL AND MANAGEMENT STRATEGIES, SYSTEMS DEVELOPMENT AND IMPLEMENTATION INCLUDING HUMAN RESOURCES AND PERSONNEL MANAGEMENT, BENEFITS AND CAREER PLANNING, TRAINING, AND DEVELOPMENT SYSTEMS, PROCESS MANAGEMENT SYSTEMS, LEADERSHIP AND MANAGEMENT DEVELOPMENT, STATISTICAL MANAGEMENT SYSTEMS, INFORMATION SYSTEMS, COMMUNICATION SYSTEMS, GOVERNMENTAL AND REGULATORY SYSTEMS AND APPROVALS, COMPENSATION MODELS AND SYSTEMS, INNOVATION AND PRODUCTIVITY IMPROVEMENT SYSTEMS, INTERNATIONAL MARKETING AND OPERATIONS, AND CULTURAL INTEGRATION, AND FORMATION, OPERATION, FINANCING AND MANAGEMENT OF BUSINESSES (U.S. CLS. 100, 101 AND 102).

CLASS 41—EDUCATION AND ENTERTAINMENT

FOR EDUCATION AND TRAINING SERVICES, NAMELY CONDUCTING CLASSES, SEMINARS, CONFERENCES, WORKSHOPS, CONTINUING EDUCATION AND INDIVIDUAL TRAINING IN THE FIELD OF DESIGN, DEVELOPMENT AND DELIVERY OF BUSINESS AND CORPORATE SERVICES, FINANCIAL INVESTMENTS FINANCIAL MANAGEMENT AND BUSINESS MANAGEMENT, SOFTWARE DEVELOPMENT, COMPUTER AND ELECTRONIC SKILLS, ELECTRONIC-COMMERCE, MULTIMEDIA DEVELOPMENT AND USE OF BUSINESS PLANS AND REPORTS, SEMINAR PREPARATION AND PRESENTATION, PRINT PREPARATION AND USE OF BUSINESS PLANS AND REPORTS, MULTIMEDIA PREPARATION AND USE OF BUSINESS PLANS AND REPORTS, DEVELOPMENT AND IMPLEMENTATION OF DISTANCE LEARNING PROGRAMS, ENGINEERING AND TECHNICAL SKILLS, PERSONAL SKILLS DEVELOPMENT, MANAGEMENT AND LEADERSHIP SKILLS, SYSTEMS SOLUTIONS FOR BUSINESS AND EDUCATION, AND PRINTED MATERIALS DISTRIBUTED THEREWITH (U.S. CLS. 100, 101 AND 107).

SN 75-931,548. PANACYA, INC., ANNAPOLIS, MD. FILED 2-29-2000.

AWARE**CLASS 9—ELECTRICAL AND SCIENTIFIC APPARATUS**

FOR COMPUTER SOFTWARE FOR MANAGING, MONITORING AND OPERATING OTHER COMPUTER SOFTWARE, COMPUTER SYSTEMS AND TELECOMMUNICATIONS NETWORKS, AND MANUALS SOLD AS A UNIT THEREWITH (U.S. CLS. 21, 23, 26, 36 AND 38).

CLASS 42—SCIENTIFIC, COMPUTER AND LEGAL SERVICES

FOR COMPUTER SERVICES, NAMELY, REMOTE AND ON-SITE MONITORING OF COMPUTER SYSTEMS AND NETWORKS FOR OTHERS; REMOTE AND ON-SITE MANAGING AND OPERATING COMPUTER SYSTEMS AND NETWORKS FOR OTHERS (U.S. CLS. 100 AND 101).

SN 75-931,558. CORPORATE GAMEWARE LLC, DBA GAMES2TRAIN.COM, NEW YORK, NY. FILED 2-29-2000.

TWITCH SPEED

NO CLAIM IS MADE TO THE EXCLUSIVE RIGHT TO USE "SPEED", APART FROM THE MARK AS SHOWN.

CLASS 9—ELECTRICAL AND SCIENTIFIC APPARATUS

FOR COMPUTER GAME SOFTWARE FOR USE IN THE FIELD OF BUSINESS AND PROFESSIONAL TRAINING AND CONTINUING EDUCATION (U.S. CLS. 21, 23, 26, 36 AND 38).

CLASS 16—PAPER GOODS AND PRINTED MATTER

FOR PRINTED BOOKS FEATURING INFORMATION THE FIELD OF BUSINESS AND PROFESSIONAL TRAINING AND CONTINUING EDUCATION (U.S. CLS. 2, 5, 22, 23, 29, 37, 38 AND 50).

CLASS 41—EDUCATION AND ENTERTAINMENT

FOR PRODUCTION OF MOTION PICTURE AND TELEVISION PROGRAMS AND PROVIDING EDUCATIONAL SERVICES, NAMELY, PROVIDING ONLINE EDUCATIONAL INTERACTIVE COMPUTER GAMES ON A GLOBAL COMPUTER NETWORK FOR USE IN THE FIELD OF BUSINESS AND PROFESSIONAL TRAINING AND CONTINUING EDUCATION (U.S. CLS. 100, 101 AND 107).

SN 75-931,686. GENOME THERAPEUTICS CORPORATION, WALTHAM, MA. FILED 2-29-2000.

PARAPHARMA**CLASS 1—CHEMICALS**

FOR CHEMICALS, NAMELY, THERAPEUTIC AGENTS IN THE NATURE OF GENOMIC DRUGS, POLYPEPTIDES, PROTEINS AND GENES FOR USE IN THE PHARMACEUTICAL INDUSTRY (U.S. CLS. 1, 5, 6, 10, 26 AND 46).

CLASS 5—PHARMACEUTICALS

FOR THERAPEUTIC AGENTS, NAMELY, DRUGS, POLYPEPTIDES, DEOXYRIBONUCLEIC ACID (DNA), PROTEINS AND GENES FOR USE IN THE TREATMENT OF HUMAN DISEASES AND DISORDERS (U.S. CLS. 6, 18, 44, 46, 51 AND 52).

CLASS 9—ELECTRICAL AND SCIENTIFIC APPARATUS

FOR COMPUTER SOFTWARE, FEATURING A DATABASE USED FOR GENETIC OR PROTEIN ANALYSIS; COMPUTER HARDWARE AND COMPUTER PERIPHERALS (U.S. CLS. 21, 23, 26, 36 AND 38).

CLASS 42—SCIENTIFIC, COMPUTER AND LEGAL SERVICES

FOR BIOTECHNOLOGY RESEARCH AND DEVELOPMENT SERVICES IN THE FIELD OF GENOMIC RESEARCH, NAMELY DRUG DEVELOPMENT AND REPOSITIONING; DESIGNING CLINICAL TRIALS; GENOMIC SEQUENCING AND FINISHING, SINGLE NUCLEOTIDE POLYMORPHISM (SNP) DETECTION AND HAPLOTYPING, PROVIDING GENOMIC, POLYPEPTIDE AND PROTEIN INFORMATION; GENERATING GENOMES; PHARMOCOGENOMICS, DIAGNOSTICS AND THERAPEUTICS PERTAINING TO DISEASE STATES AND CONDITIONS (U.S. CLS. 100 AND 101).

SN 75-936,070. WESTA-HOLDING GMBH & CO. KG, D-33334 GUTERSLOH, FED REP GERMANY, FILED 3-6-2000.

WESTAFLEX

PRIORITY CLAIMED UNDER SEC. 44(D) ON FED REP GERMANY APPLICATION NO. 399573666/06, FILED 9-16-1999, REG. NO. 39957366, DATED 3-13-2000, EXPIRES 9-30-2009.

CLASS 6—METAL GOODS

FOR BUILDING MATERIALS OF METAL, NAMELY, AIR TRANSFER DUCTS AND DUCT LINERS; NON-ELECTRIC CABLES AND WIRES OF COMMON METAL; IRONMONGERY, NAMELY, SMALL ITEMS OF METAL HARDWARE, NAMELY, WIRE CLAMPS AND BAND CLAMPS; TUBES OF METAL, NAMELY, FLEXIBLE, SEMI-FLEXIBLE AND RIGID TUBES OF METAL; GOODS OF COMMON METAL, NAMELY, UNION COUPLINGS FOR PIPES AND TUBES, NAMELY, SLEEVES, MUFFS, FLANGES, FLANGE SLEEVES, FLANGE MUFFS; PARTS OF VENTILATION INSTALLATIONS, NAMELY, METAL DUCTS AND FITTINGS, NAMELY, FLEXIBLE, SEMI-FLEXIBLE AND RIGID DUCTS; STAINLESS-STEEL DUCTS AND VENTILATION DUCTS FOR OIL TANKS; GOODS MADE OF METAL, NAMELY, CONNECTIONS FOR DUCTS, NAMELY, CLAMPS, SPIGOTS, CASINGS, MUFFS, FLANGES, FLANGE SLEEVES AND FLANGE MUFFS, RIGID, SEMI-FLEXIBLE AND FLEXIBLE DUCT SECTIONS, NOISE SUPPRESSION ELEMENTS, NAMELY, DUCT-LIKE SILENCERS FOR AIR CONDITIONING SYSTEMS; AIR-SOURCE OUTLETS, CHIMNEYS, EXHAUST DUCTS (U.S. CLS. 2, 12, 13, 14, 23, 25 AND 50).

CLASS 11—ENVIRONMENTAL CONTROL APPARATUS

FOR WEATHER PROTECTION LOUVERS; WEATHER PROTECTION VENTILATING LOUVERS (U.S. CLS. 13, 21, 23, 31 AND 34).

SN 75-938,284. PHYSICIANS' TELECOM, LLC, POUND RIDGE, NY. FILED 3-8-2000.

NOTIFYHEALTH**CLASS 38—COMMUNICATION**

FOR COMMUNICATION SERVICES, NAMELY, ELECTRONIC MAIL SERVICES, PAGING SERVICES, VIDEO TELECONFERENCING SERVICES, PROVIDING MULTIPLE-USER ACCESS TO GLOBAL COMPUTER NETWORKS, CELLULAR TELEPHONE SERVICES, ELECTRONIC VOICE MESSAGING, NAMELY, THE RECORDING, STORAGE AND SUBSEQUENT TRANSMISSION OF VOICE MESSAGES BY TELEPHONE; PROVIDING TELECOMMUNICATIONS CONNECTIONS TO A GLOBAL COMPUTER NETWORK INCLUDING PERSONAL COMMUNICATIONS SERVICES, WIRELESS COMMUNICATIONS SERVICES, ISDN AND OTHER COMMODITY TRANSPORT SERVICES, DOCTOR TO DOCTOR/ MEDICAL PERSONNEL/ MEDICAL FACILITY/ PATIENT/ PHYSICIANS' OFFICE COMMUNICATIONS SERVICES; PERFORMING ALL OF THE ABOVE COMMUNICATIONS SERVICES WITH PROVISIONS FOR LIMITING ACCESS OR TYPES OF ACCESS TO APPROVED PERSONS OR CLASSES OF PERSONS (U.S. CLS. 100, 101 AND 104).

CLASS 41—EDUCATION AND ENTERTAINMENT

FOR ON-LINE SERVICES, NAMELY, PROVIDING A WIDE RANGE OF GENERAL INTEREST MEDICAL EDUCATIONAL INFORMATION VIA GLOBAL COMPUTER INFORMATION NETWORKS; PROVIDING WEB SITES FEATURING A WIDE RANGE OF GENERAL INTEREST INFORMATION ON CONFERENCE SITES, SEMINAR LOCALES, CONTINUING EDUCATION CENTERS AND MEDICAL EDUCATIONAL SERVICES VIA GLOBAL COMPUTER INFORMATION NETWORKS (U.S. CLS. 100, 101 AND 107).

SN 75-936,188. PRIMEDIA BUSINESS MAGAZINES & MEDIA INC., OVERLAND PARK, KS. BY CHANGE OF NAME INTERTEC PUBLISHING CORPORATION, OVERLAND PARK, KS. FILED 3-6-2000.

NETMEDIA**CLASS 16—PAPER GOODS AND PRINTED MATTER**

FOR MAGAZINES ABOUT THE PRODUCTION OF AUDIO AND VIDEO MULTIMEDIA FOR A GLOBAL COMMUNICATIONS NETWORK (U.S. CLS. 2, 5, 22, 23, 29, 37, 38 AND 50).

FIRST USE 6-7-2000; IN COMMERCE 6-7-2000.

CLASS 42—SCIENTIFIC, COMPUTER AND LEGAL SERVICES

FOR COMPUTER SERVICES, NAMELY AN ONLINE MAGAZINE ABOUT THE PRODUCTION OF AUDIO AND VIDEO MULTIMEDIA FOR A GLOBAL COMMUNICATIONS NETWORK (U.S. CLS. 100 AND 101).

FIRST USE 2-1-2001; IN COMMERCE 2-1-2001.

SN 75-939,227. ANANDA DESIGN, LTD., NEW YORK, NY. FILED 3-9-2000.



THE WORD "ANANDA" IS A HINDU WORD, MEANING "A STATE OF BLISS CONSCIOUSNESS".

CLASS 14—JEWELRY

FOR JEWELRY, NAMELY, NECKLACES, BRACELETS, AND EAR RINGS (U.S. CLS. 2, 27, 28 AND 50).

FIRST USE 5-21-1999; IN COMMERCE 5-21-1999.

CLASS 18—LEATHER GOODS

FOR HANDBAGS, EVENING BAGS, AND COSMETICS BAGS SOLID EMPTY (U.S. CLS. 1, 2, 3, 22 AND 41).

FIRST USE 5-21-1999; IN COMMERCE 5-21-1999.

CLASS 20—FURNITURE AND ARTICLES NOT OTHERWISE CLASSIFIED

FOR PILLOWS AND CUSHIONS (U.S. CLS. 2, 13, 22, 25, 32 AND 50).
FIRST USE 5-21-1999; IN COMMERCE 5-21-1999.

CLASS 24—FABRICS

FOR BEDDING, NAMELY, BEDSPREADS, DUVET COVERS, BED BLANKET THROWS, BED BLANKETS, BABY BED BLANKETS, BEDSKIRTS, SHAMS AND PILLOWS CASES; WINDOW CURTAINS, TABLECLOTHS NOT OF PAPER, TEXTILE NAPKINS, FABRIC TABLE RUNNERS, AND TEXTILE PLACE MATS (U.S. CLS. 42 AND 50).
FIRST USE 5-21-1999; IN COMMERCE 5-21-1999.

CLASS 25—CLOTHING

FOR CLOTHING, NAMELY SHAWLS, STOLES, SCARVES, MUFFLERS, WRAPS, AND BELTS; BRIDAL WEAR, NAMELY, WRAPS (U.S. CLS. 22 AND 39).
FIRST USE 5-21-1999; IN COMMERCE 5-21-1999.

SN 75-939,511. FEDERAL NATIONAL MORTGAGE ASSOCIATION, DBA FANNIE MAE, WASHINGTON, DC. FILED 3-9-2000.



OWNER OF U.S. REG. NO. 1,932,886.

CLASS 35—ADVERTISING AND BUSINESS

FOR HOMEOWNER AND HOMEBUYER REFERRAL SERVICES (U.S. CLS. 100, 101 AND 102).

CLASS 36—INSURANCE AND FINANCIAL

FOR PROVIDING FINANCIAL INFORMATION, NAMELY A WEBSITE ON THE INTERNET FEATURING INTERACTIVE DATABASES OF INFORMATION ON FINANCIAL SERVICES AND SUBJECTS, NAMELY, PROVIDING INFORMATION IN THE FIELDS OF MORTGAGES, REVERSE MORTGAGES, MORTGAGE LENDERS, CREDIT, HOUSING AND CREDIT COUNSELING, MORTGAGE AND HOUSING COST CALCULATIONS, MORTGAGE AND HOUSING AFFORDABILITY CALCULATIONS, MORTGAGE PRE-QUALIFICATION, DOWN PAYMENTS, CLOSING COSTS, MORTGAGE INTEREST, PROPERTY TAXES, HOMEOWNER'S INSURANCE, HOME BUYING, REFINANCING, HOME IMPROVEMENT LOANS AND LENDERS, ASSESSING AND MEETING FINANCIAL NEEDS, INCLUDING CREATION OF FINANCIAL STATEMENTS, CASH FLOW STATEMENTS AND BUDGETS, FINANCIAL SELF-EVALUATION, AND PROVIDING A GLOSSARY OF DEFINITIONS OF REAL ESTATE, MORTGAGE AND FINANCIAL TERMS, AND ON MORTGAGE SERVICES; FINANCIAL AND MORTGAGE-RELATED SUPPORT SERVICES PROVIDED OVER A GLOBAL COMMUNICATIONS NETWORK, NAMELY PROVIDING ASSISTANCE TO HOMEOWNERS AND PROSPECTIVE HOME BUYERS IN LOCATING AND SELECTING A HOME, BUYING A HOME, LOCATING AND SELECTING MORTGAGES AND REFINANCING OPTIONS, LOCATING AND SELECTING MORTGAGE LENDERS AND HOME IMPROVEMENT LENDERS, LOCATING AND SELECTING HOUSING AND CREDIT COUNSELORS, LOCATING AND SELECTING CONTRACTORS FOR HOME IMPROVEMENT PROJECTS, LOCATING PROPERTIES FOR SALE, LOCATING AND SELECTING REAL ESTATE PROFESSIONAL SERVICES, CALCULATING MORTGAGE AND REFINANCING COSTS, PREPARING AND KEEPING A HOME OWNERSHIP BUDGET, CONDUCTING A FINANCIAL SELF-EVALUATION AND PROVIDING A SUBSCRIPTION SERVICE WHEREBY SUBSCRIBERS ARE ALERTED TO MORTGAGE AND RELATED FINANCIAL AND REAL ESTATE INFORMATION VIA EMAIL (U.S. CLS. 100, 101 AND 102).

SN 75-939,679. PULITZER, INC., ST. LOUIS, MO. FILED 3-9-2000.

THE ARIZONA DAILY STAR

NO CLAIM IS MADE TO THE EXCLUSIVE RIGHT TO USE "ARIZONA DAILY", APART FROM THE MARK AS SHOWN.

CLASS 16—PAPER GOODS AND PRINTED MATTER

FOR NEWSPAPERS FOR GENERAL CIRCULATION (U.S. CLS. 2, 5, 22, 23, 29, 37, 38 AND 50).
FIRST USE 0-0-1879; IN COMMERCE 0-0-1879.

CLASS 42—SCIENTIFIC, COMPUTER AND LEGAL SERVICES

FOR COMPUTER SERVICES, NAMELY AN ON-LINE NEWSPAPER (U.S. CLS. 100 AND 101).
FIRST USE 0-0-1995; IN COMMERCE 0-0-1995.

SN 75-977,753. MISSOURI BASIN MUNICIPAL POWER AGENCY, SIOUX FALLS, SD. FILED 4-15-1998.



CLASS 36—INSURANCE AND FINANCIAL

FOR BILL PAYMENT SERVICES (U.S. CLS. 100, 101 AND 102).
FIRST USE 5-1-1998; IN COMMERCE 5-1-1998.

CLASS 37—CONSTRUCTION AND REPAIR

FOR MAINTENANCE OF UTILITY DISTRIBUTION LINES (U.S. CLS. 100, 103 AND 106).
FIRST USE 5-1-1998; IN COMMERCE 5-1-1998.

CLASS 39—TRANSPORTATION AND STORAGE

FOR PUBLIC UTILITY SERVICES (U.S. CLS. 100 AND 105).
FIRST USE 5-1-1998; IN COMMERCE 5-1-1998.

CLASS 42—SCIENTIFIC, COMPUTER AND LEGAL SERVICES

FOR ENERGY MANAGEMENT, NAMELY, ENERGY ENGINEERING AND TECHNICAL CONSULTATION SERVICES RELATING TO DEVELOPMENT, CONTROL, PRODUCTION, USE, PURCHASE AND CONSERVATION OF ENERGY; LEGISLATIVE CONSULTING AND LOBBYING SERVICES IN THE UTILITY FIELD (U.S. CLS. 100 AND 101).
FIRST USE 5-1-1998; IN COMMERCE 5-1-1998.

SN 75-980,214. WILLIAM CARTER COMPANY, THE, MORROW, GA. FILED 1-11-1999.

carter's

OWNER OF U.S. REG. NOS. 153,906, 2,070,568 AND OTHERS.
SEC. 2(F).

CLASS 8—HAND TOOLS

FOR NAIL CLIPPERS FOR INFANTS AND CHILDREN; TABLEWARE FOR CHILDREN, NAMELY, KNIVES, FORKS AND SPOONS MADE OF PLASTIC OR NON-PRECIOUS METAL (U.S. CLS. 23, 28 AND 44).

CLASS 9—ELECTRICAL AND SCIENTIFIC APPARATUS

FOR PRE-RECORDED AUDIO TAPES FEATURING MUSIC OR STORIES FOR INFANTS AND CHILDREN; PRE-RECORDED VIDEO TAPES FOR INFANTS AND CHILDREN; PRE-RECORDED INSTRUCTIONAL VIDEO TAPES RELATING TO INFANTS, CHILDREN AND PARENTING IN GENERAL (U.S. CLS. 21, 23, 26, 36 AND 38).

CLASS 12—VEHICLES

FOR BABY CARRIAGES; INFANT'S AND CHILDREN'S CAR SEATS AND INFANT STROLLERS (U.S. CLS. 19, 21, 23, 31, 35 AND 44).

CLASS 15—MUSICAL INSTRUMENTS

FOR MUSICAL INSTRUMENTS FOR CHILDREN (U.S. CLS. 2, 21 AND 36).

CLASS 16—PAPER GOODS AND PRINTED MATTER

FOR BABY ANNOUNCEMENT CARDS, CHILDREN'S BOOKS, TALKING CHILDREN'S BOOKS, CHILDREN'S ACTIVITY BOOKS AND CALENDARS, CHILDREN'S STATIONERY, CHILDREN'S PHOTO ALBUMS AND SCRAPBOOK ALBUMS, BABY BOOKS, AND GIFT WRAPPING PAPER FOR CHILDREN (U.S. CLS. 2, 5, 22, 23, 29, 37, 38 AND 50).

CLASS 20—FURNITURE AND ARTICLES NOT OTHERWISE CLASSIFIED

FOR CHILDREN'S FURNITURE, NAMELY, PLAY YARDS, PLASTIC BIBS, BOOSTER SEATS, TOY CHESTS AND SLEEPING BAGS; PLAY PENS, CLOTHES HANGERS AND HIGH CHAIRS (U.S. CLS. 2, 13, 22, 25, 32 AND 50).

CLASS 21—HOUSEWARES AND GLASS

FOR BOTTLES SOLD EMPTY, CHILDREN'S DRINKING CUPS, CHILDREN'S DISHES, HAIR BRUSHES AND HAIR COMBS (U.S. CLS. 2, 13, 23, 29, 30, 33, 40 AND 50).

CLASS 24—FABRICS

FOR DECORATIVE TEXTILE WALL COVERINGS, BATH TOWELS, HOODED BATH TOWELS, WASH CLOTHS, WASH MITTS; BEDDING, NAMELY, BLANKETS, COMFORTERS, BED SHEETS, MATTRESS PADS, CRIB BUMPERS AND CRIB CANOPIES (U.S. CLS. 42 AND 50).

CLASS 25—CLOTHING

FOR BABY BUNTING, BATHING SUITS, BATH ROBES, CLOTH BIBS, BONNETS, BOOTIES, COVERALLS, CREEPERS, COATS, DRESSES, DRESSING GOWNS, JACKETS, JEANS, JUMPERS, JUMPSUITS, NIGHTGOWNS, PAJAMAS, PANTS, ROMPERS, SHIRTS, SHORTS, SHORTALLS, SOCKS, SNOW SUITS, SUN SUITS, TEE SHIRTS AND UNDERWEAR (U.S. CLS. 22 AND 39).

CLASS 27—FLOOR COVERINGS

FOR RUGS, DECORATIVE PLASTIC WALL COVERINGS AND DECORATIVE VINYL WALL COVERINGS (U.S. CLS. 19, 20, 37, 42 AND 50).

CLASS 28—TOYS AND SPORTING GOODS

FOR STUFFED TOY ANIMALS, BABY RATTLES, BATH TOYS, CRIB MOBILES, INFANT CRIB TOYS, DOLLS, PLUSH TOYS, STUFFED TOYS AND WIND-UP TOYS; MULTIPLE ACTIVITY TOYS FOR BABIES, ACTION SKILL GAMES, CARD GAMES, BOARD GAMES, TOY BUILDING BLOCKS, DOLL CLOTHING, DOLL HOUSES, MUSICAL TOYS, MUSIC BOX TOYS, MANIPULATIVE PUZZLES MADE OF WOOD FOR INFANTS AND CHILDREN, TOY PUZZLES MADE OF WOOD FOR INFANTS AND CHILDREN, PULL/PUSH TOYS AND PUPPETS (U.S. CLS. 22, 23, 38 AND 50).

CLASS 36—INSURANCE AND FINANCIAL

FOR INVESTMENT BROKERAGE AND FINANCIAL AND MARKET SERVICES, NAMELY, PROVIDING QUOTES ON SECURITIES AND COMMODITIES, ECONOMIC RESEARCH, ECONOMIC NEWS, SECURITIES AND INVESTMENT INFORMATION; ELECTRONIC FINANCIAL INFORMATION SERVICES, NAMELY, PROVIDING OVER GLOBAL COMPUTER NETWORK QUOTES ON SECURITIES AND COMMODITIES, ECONOMIC RESEARCH, ECONOMIC NEWS, MORTGAGE PAYMENT CALCULATIONS AND INVESTMENT INFORMATION (U.S. CLS. 100, 101 AND 102).

FIRST USE 9-0-2000; IN COMMERCE 9-0-2000.

SN 75-980,276. SWEETSIDES CO., INC., GRANADA HILLS, CA. FILED 2-1-1999.

SN 75-981,362. KIRKBI AG, CH-6340 BAAR, SWITZERLAND, FILED 9-28-1998.

SWEETSIDES**CLASS 29—MEATS AND PROCESSED FOODS**

FOR BERRY JELLIES, FRUIT JELLIES, JAMS, SPREADS, NAMELY CHEESE SPREADS, FRUIT BASED SPREADS, AND VEGETABLE BASED SPREADS, AND FRUIT PRESERVES (U.S. CL. 46).

CLASS 32—LIGHT BEVERAGES

FOR SYRUPS FOR MAKING FRUIT DRINKS AND SOFT DRINKS (U.S. CLS. 45, 46 AND 48).

just imagine...**CLASS 9—ELECTRICAL AND SCIENTIFIC APPARATUS**

FOR REFLECTING SAFETY TAGS USED ON CLOTHING TO PREVENT TRAFFIC ACCIDENTS; SUNGLASSES (U.S. CLS. 21, 23, 26, 36 AND 38).

SN 75-981,172. AMERITRADE, (INC.), OMAHA, NE. FILED 5-24-2000.

**IT'S HOW YOU GET
SOMEWHERE ON WALL
STREET**

CLASS 16—PAPER GOODS AND PRINTED MATTER

FOR BOOKS, CURRICULUM GUIDES AND ACTIVITY CARDS FOR USE IN TEACHING PRE-SCHOOL PROGRAM SUBJECTS INCLUDING PROBLEM SOLVING, MOTOR SKILLS, LANGUAGE DEVELOPMENT, NUMBER CONCEPTS, CONSTRUCTION TOY PLAY, EDUCATIONAL GAMES INVOLVING CONSTRUCTION TOYS AND TOY MODEL FIGURES AND FOR USE IN TEACHING READING, MATHEMATICS, GEOMETRY, SCIENCE AND TECHNOLOGY; COMPUTER MANUALS FOR USE WITH EDUCATIONAL SOFTWARE PROGRAMS (U.S. CLS. 2, 5, 22, 23, 29, 37, 38 AND 50).

CLASS 18—LEATHER GOODS

FOR TOTE BAGS, DUFFEL BAGS, SHOULDER BAGS, SCHOOL BAGS AND SATCHELS, TODDLER'S BAGS, ALL-PURPOSE SPORTS BAGS, WAIST PACKS, BAGS FOR CARRYING BABIES AND MESH AND/OR TEXTILE SHOPPING BAGS, RUCKSACKS, LUGGAGE TRUNKS AND TRAVEL BAGS, PURSES, WALLETTS AND UMBRELLAS (U.S. CLS. 1, 2, 3, 22 AND 41).

CLASS 9—ELECTRICAL AND SCIENTIFIC APPARATUS

FOR COMPUTER SOFTWARE FOR FINANCIAL INVESTMENT (U.S. CLS. 21, 23, 26, 36 AND 38).
FIRST USE 5-15-2001; IN COMMERCE 5-15-2001.

CLASS 41—EDUCATION AND ENTERTAINMENT

FOR ENTERTAINMENT SERVICES IN THE NATURE OF THEME PARKS AND AMUSEMENT PARKS FOR CHILDREN AND FOR TOY BUILDING BRICK ENTHUSIASTS, PROVIDING FACILITIES FOR PLAYING COMPUTER GAMES, CONDUCTING EXHIBITIONS OF MODELS MADE FROM TOY BUILDING MATERIALS, CONDUCTING TOY MODEL BUILDING CONTESTS AND ORGANIZING CLUBS FEATURING THE BUILDING OF TOY MODELS; EDUCATIONAL SERVICES PROVIDED FOR CHILDREN AND FOR TEACHERS OF CHILDREN, NAMELY, CONDUCTING SEMINARS AND WORKSHOPS IN THE FIELDS OF TOY MODEL BUILDING AND COMPUTER-ASSISTED DESIGN AND CONTROL OF TOY MODELS AND STRUCTURES (U.S. CLS. 100, 101 AND 107).

CLASS 16—PAPER GOODS AND PRINTED MATTER

FOR PUBLICATIONS, NAMELY, PRINTED INSTRUCTIONAL MATERIALS, PAMPHLETS, GUIDES, AND NEWSLETTERS REGARDING PERSONAL INVESTING, THE STOCK MARKET, AND FINANCIAL MANAGEMENT (U.S. CLS. 2, 5, 22, 23, 29, 37, 38 AND 50).
FIRST USE 10-0-2000; IN COMMERCE 10-0-2000.

CLASS 25—CLOTHING

FOR CLOTHING, NAMELY, T-SHIRTS; HEADGEAR, NAMELY, HATS; AND FOOTWEAR (U.S. CLS. 22 AND 39).
FIRST USE 9-0-2000; IN COMMERCE 9-0-2000.

SN 75-981,427. MICROSOFT CORPORATION, REDMOND, WA. FILED 11-10-1999.

SN 75-982,027. DIZOGLIO, FRANK P., III, JAMESTOWN, RI. FILED 8-22-2000.

VIRTUAL GOLF ASSOCIATION

NO CLAIM IS MADE TO THE EXCLUSIVE RIGHT TO USE "VIRTUAL GOLF" AS TO THE GOODS IN INTERNATIONAL CLASS 9 AND "GOLF" AS TO THE GOODS IN INTERNATIONAL CLASSES 25 AND 28, APART FROM THE MARK AS SHOWN.

CLASS 9—ELECTRICAL AND SCIENTIFIC APPARATUS

FOR COMPUTER PROGRAMS, NAMELY, GAME SOFTWARE (U.S. CLS. 21, 23, 26, 36 AND 38).

CLASS 25—CLOTHING

FOR CLOTHING, NAMELY, VESTS, SHIRTS, T-SHIRTS, HATS, VISORS, GLOVES, SWEATSHIRTS, SWEATERS, SWEATPANTS, SHORTS, JACKETS, COATS, SWEATBANDS, WRIST BANDS, SCARVES, MITTENS, SOCKS AND GOLF RAINWEAR (U.S. CLS. 22 AND 39).

CLASS 28—TOYS AND SPORTING GOODS

FOR GOLF BALLS, GOLF TEES, GOLF BALL MARKERS, GOLF BAGS, GOLF GLOVES, GOLF CLUBS, GOLF AND PUTTER HEAD COVERS, TOSSING DISC TOYS, YO-YOS, TENNIS BAGS, BASKETBALL BAGS, LACROSSE BAGS, BASEBALL BAGS, BOWLING BAGS, ARCHERY BAGS, SOCCER BAGS, HOCKEY BAGS, FOOTBALL BAGS, SKATE BAGS, AND VARIOUS TYPES OF BALLS, NAMELY, TENNIS BALLS, BASEBALLS, FOOTBALLS, BASKETBALLS, RUBBER ACTION BALLS AND PLAYGROUND BALLS (U.S. CLS. 22, 23, 38 AND 50).

CLASS 35—ADVERTISING AND BUSINESS

FOR PLACEMENT OF ADVERTISEMENTS FOR OTHERS (U.S. CLS. 100, 101 AND 102).

SN 75-981,521. FLUENT BABY, INC., PALO ALTO, CA. FILED 9-22-2000.

BABY CZECH

NO CLAIM IS MADE TO THE EXCLUSIVE RIGHT TO USE "BABY", APART FROM THE MARK AS SHOWN.

CLASS 18—LEATHER GOODS

FOR BABY-ORIENTED TOTE BAGS AND BACKPACKS (U.S. CLS. 1, 2, 3, 22 AND 41).

CLASS 25—CLOTHING

FOR CLOTHING FOR BABIES, INFANTS AND TODDLERS, NAMELY, T-SHIRTS, SWEATSHIRTS AND HATS (U.S. CLS. 22 AND 39).

DELVECCHIO

SEC. 2(F).

CLASS 29—MEATS AND PROCESSED FOODS

FOR TOMATO PUREE; CANNED TOMATOES; PROCESSED CANNED AND BOTTLED VEGETABLES; OLIVE OIL; VEGETABLE OIL; LUNCHEON MEATS; AND SHORTENING (U.S. CL. 46).

FIRST USE 4-1-1993; IN COMMERCE 4-1-1993.

CLASS 30—STAPLE FOODS

FOR VINEGAR; SPICES; SALAD DRESSINGS; AND TOMATO SAUCE (U.S. CL. 46).

FIRST USE 4-1-1993; IN COMMERCE 4-1-1993.

SN 76-000,283. SIEMENS AG OSTERREICH, WIEN, AUSTRIA, FILED 3-15-2000.

FINCAST

PRIORITY CLAIMED UNDER SEC. 44(D) ON AUSTRIA APPLICATION NO. AM6179/99, FILED 9-28-1999, REG. NO. 184959, DATED 10-27-1999, EXPIRES 10-31-2009.

CLASS 9—ELECTRICAL AND SCIENTIFIC APPARATUS

FOR DATA PROCESSING COMPUTER PROGRAMS FOR USE BY INVESTORS AND FINANCIAL ADVISORS TO FORECAST THE DEVELOPMENT OF SECURITIES (U.S. CLS. 21, 23, 26, 36 AND 38).

CLASS 36—INSURANCE AND FINANCIAL

FOR FINANCIAL SERVICES, NAMELY, FORECASTING THE DEVELOPMENT OF SECURITIES (U.S. CLS. 100, 101 AND 102).

CLASS 42—SCIENTIFIC, COMPUTER AND LEGAL SERVICES

FOR DEVELOPMENT, CREATION AND RENTAL OF DATA PROCESSING COMPUTER PROGRAMS FOR OTHERS (U.S. CLS. 100 AND 101).

SN 76-000,290. ONEIDA LTD., ONEIDA, NY. FILED 3-13-2000.

ONEIDA.COM

OWNER OF U.S. REG. NOS. 185,759, 2,425,852 AND OTHERS.

CLASS 35—ADVERTISING AND BUSINESS

FOR COMPUTERIZED ON-LINE RETAIL STORE SERVICES FEATURING TABLEWARE, NAMELY, FLATWARE, HOLLOWARE, CHINA, GLASSWARE AND CRYSTAL; PROVIDING ON-LINE CONSUMER INFORMATION IN THE FIELDS OF TABLEWARE, KITCHENWARE AND GIFTWARE BY MEANS OF GLOBAL INFORMATION NETWORKS (U.S. CLS. 100, 101 AND 102).

FIRST USE 11-16-1999; IN COMMERCE 11-16-1999.

CLASS 42—SCIENTIFIC, COMPUTER AND LEGAL SERVICES

FOR PROVIDING ON-LINE CATERING INFORMATION IN THE FIELDS OF TABLEWARE, KITCHENWARE AND GIFTWARE BY MEANS OF GLOBAL INFORMATION NETWORKS (U.S. CLS. 100 AND 101).

FIRST USE 11-16-1999; IN COMMERCE 11-16-1999.

SN 76-001,017. INFANIA IP LTD, ISLE OF MAN, UNITED KINGDOM, FILED 3-15-2000.

INFANIA

CLASS 9—ELECTRICAL AND SCIENTIFIC APPARATUS

FOR MAGNETICALLY ENCODED CREDIT CARDS, DEBIT CARDS, PAY CARDS AND CASH CARDS BEARING SOME FORM OF DATA PROCESSING MATERIAL (U.S. CLS. 21, 23, 26, 36 AND 38).

CLASS 36—INSURANCE AND FINANCIAL

FOR FINANCIAL SERVICES, NAMELY, BANKING, CREDIT CARD, CASH CARD, AND STORED VALUE CARD SERVICES; MONEY TRANSFER SERVICES, FINANCIAL SERVICES PROVIDED VIA THE GLOBAL COMPUTER NETWORK, NAMELY, FOR TRANSACTIONS, USING BANKING, CREDIT CARD, DEBIT CARD, AND CASH CARDS, AND MONEY TRANSFER SERVICES (U.S. CLS. 100, 101 AND 102).

SN 76-002,077. KIMPEX INC., DRUMMONDVILLE, QUEBEC, CANADA, FILED 3-16-2000.



PRIORITY CLAIMED UNDER SEC. 44(D) ON CANADA APPLICATION NO. 1030322, FILED 9-24-1999, REG. NO. TMA548716, DATED 7-26-2001, EXPIRES 7-26-2016.

THE STIPPLING SHOWN IN THE DRAWING IS FOR SHADING PURPOSES ONLY AND NOT INTENDED TO INDICATE COLOR.

CLASS 9—ELECTRICAL AND SCIENTIFIC APPARATUS

FOR PROTECTIVE GEAR, NAMELY, HELMETS AND VISORS THEREFOR; EYE AND SUN GLASSES (U.S. CLS. 21, 23, 26, 36 AND 38).

CLASS 18—LEATHER GOODS

FOR GEAR BAGS FOR MOTORCYCLISTS (U.S. CLS. 1, 2, 3, 22 AND 41).

CLASS 25—CLOTHING

FOR CLOTHING, NAMELY, PANTS, SWEATERS, T-SHIRTS, ONE AND TWO PIECE MOTORCYCLE RIDING SUITS, GLOVES, LEATHER JACKETS, ONE AND TWO PIECE RAIN WEAR, JERSEYS, MOTOCROSS JERSEYS, CAPS; BELTS, RIDING BOOTS, ROAD RIDING BOOTS, DIRT BOOTS; ALL USED IN CONNECTION WITH MOTORCYCLING AND MOTOCROSS RACING (U.S. CLS. 22 AND 39).

CLASS 28—TOYS AND SPORTING GOODS

FOR MOTOCROSS CHEST AND SHOULDER PROTECTORS (U.S. CLS. 22, 23, 38 AND 50).

SN 76-002,535. BULLSEYE TELECOM, INC., SOUTHFIELD, MI. BY MERGER, BY CHANGE OF NAME ENTERPRISE NETWORK SOLUTIONS, L.L.C., SOUTHFIELD, MI. FILED 3-17-2000.



NO CLAIM IS MADE TO THE EXCLUSIVE RIGHT TO USE "TELECOM", APART FROM THE MARK AS SHOWN.

THE LINING IN THE MARK IS INTENDED TO INDICATE COLOR AND IS NOT A FEATURE OF THE MARK. THE DRAWING IS LINED FOR THE COLOR RED.

CLASS 38—COMMUNICATION

FOR PROVIDING MULTI-USER ACCESS TO A GLOBAL COMPUTER NETWORK (U.S. CLS. 100, 101 AND 104).

CLASS 42—SCIENTIFIC, COMPUTER AND LEGAL SERVICES

FOR HOSTING THE WEBSITES OF OTHERS ON A COMPUTER SERVER FOR A GLOBAL COMPUTER NETWORK; AND SERVER COLLOCATION SERVICES, NAMELY, HOUSING, MONITORING; AND MANAGING THE SERVERS OF OTHERS FOR PROVIDING ACCESS TO THE GLOBAL COMPUTER NETWORK (U.S. CLS. 100 AND 101).

SN 76-003,745. FLYING PIG, INC., THE, MOUNT KISCO, NY.
FILED 3-20-2000.

THE HUDSON VALLEY



NO CLAIM IS MADE TO THE EXCLUSIVE RIGHT TO USE "HUDSON VALLEY", APART FROM THE MARK AS SHOWN.

CLASS 16—PAPER GOODS AND PRINTED MATTER

FOR PRINTED AND PAPER OFFICE ARTICLES, NAMELY, NOTE CARDS, STATIONERY, PENS AND PENCILS; PAPER NAPKINS, PAPER TOWELS, PAPER BAGS; PRINTED LABELS, CARDBOARD BOXES, PAPER PLACE MATS, MOUNTED AND UNMOUNTED PHOTOGRAPHS, PHOTOGRAPH MOUNTS, PHOTOGRAPH ALBUMS; PRINTED INSTRUCTIONAL AND TEACHING MATERIALS ALL IN THE FIELD OF ANIMALS AND NATURAL SCIENCES; POSTERS, PLAYING CARDS, COOKBOOKS, NOTEBOOKS, NOTE PADS, ENVELOPES, GREETING CARDS, POSTCARDS, MAPS, COLORING BOOKS, BOOK COVERS, MAGAZINE HOLDERS, FILE CARDS, RECIPE CARDS, WRAPPING PAPER, PAPER GIFT WRAPPING RIBBON, BOOKMARKS, WAXED PAPER, PAPER TABLECLOTHS, PAPER COASTERS AND CALENDARS (U.S. CLS. 2, 5, 22, 23, 29, 37, 38 AND 50).

CLASS 18—LEATHER GOODS

FOR BACKPACKS, UMBRELLAS, TOTE BAGS, CARRYING BAGS, POCKETBOOKS, CHANGE PURSES, SCHOOL BAGS, DUFFEL BAGS, BRIEFCASES, SUITCASES, TRAVEL BAGS, CAMERA BAGS, WALLETS, BILLFOLDS AND KEY CASES; DOG COATS (U.S. CLS. 1, 2, 3, 22 AND 41).

CLASS 21—HOUSEWARES AND GLASS

FOR HOUSEWARES, NAMELY, PIGGY BANKS NOT OF METAL, GLASS FIGURINES, PORCELAIN FIGURINES, CHINA FIGURINES; RECIPE BOXES, CUTTING BOARDS, TOWEL RACKS, NAPKIN RINGS NOT OF PRECIOUS METAL, MUGS, CUPS, DRINKING GLASSES, DISHES, SAUCERS, COOKIE JARS, PITCHERS; KITCHEN AND COOKING UTENSILS, NAMELY, ROLLING PINS, SPATULAS, SIEVES, WOOD CHOPPING BLOCKS, COOKIE CUTTERS, COOKIE STAMPS, COOKERY MOLDS, PIE AND CAKE SERVERS, SCOOPS; FLOWER POTS, PAILS, SOAP CONTAINERS, FOOD CONTAINERS AND PAPER FOOD CONTAINERS; PAPER MEAL TRAYS FOR FOOD; COASTERS NOT OF PAPER; COFFEE CUPS, COLD DRINK CUPS, PAPER PLATES; NON-ELECTRIC COFFEE POTS NOT OF PRECIOUS METAL; VASES, SOAP DISHES, SOAP DISPENSERS, DUST BINS FOR STORAGE, DECANTERS, SERVING PLATTERS, COOKWARE, NAMELY, POTS AND FRYING PANS, SPICE RACKS, TEAPOTS NOT OF PRECIOUS METAL, GLASS BEVERAGEWARE, CAKE STANDS IN THE NATURE OF CAKE HOLDERS, GLASS JARS FOR JAMS AND JELLIES, SUGAR BOWLS, HONEY DISPENSERS, BAKING PANS, EGG CUPS, FLOWER HOLDERS, TUREENS FOR SERVING FOOD, ICE BUCKETS, SPONGES FOR HOUSEHOLD USE, FITTED PICNIC BASKETS, PLATES, TRASH CANS AND GARBAGE CANS FOR COMPOST (U.S. CLS. 2, 13, 23, 29, 30, 33, 40 AND 50).

CLASS 25—CLOTHING

FOR CLOTHING, NAMELY, TANK TOPS AND OTHER SHIRTS, NAMELY, POLO SHIRTS, T-SHIRTS AND SWEATSHIRTS; UNDERGARMENTS, NIGHT GOWNS, NIGHT SHIRTS AND PAJAMAS, BANDANNAS, SCARVES, BABY BUNTING, BABY T-SHIRTS, RAINWEAR, SHOES, SLIPPERS, SWEATERS, BEACHWEAR, BATHROBES, TIES, EARMUFFS, GLOVES; OUTERWEAR, NAMELY, PARKAS, WIND RESISTANT JACKETS, JACKET; SOCKS, SHORTS, SWEATSUITS, SWEATPANTS, APRONS, HATS AND CAPS (U.S. CLS. 22 AND 39).

CLASS 29—MEATS AND PROCESSED FOODS

FOR FOOD, NAMELY, MEAT, CHICKEN, GAME, FISH, LUNCHEON MEATS, SMOKED MEAT, SMOKED FISH, PATES, JAMS, JELLIES, FRUIT PRESERVES, CHEESE SPREADS, FRUIT SPREADS, VEGETABLE SPREADS, EGGS, MILK PRODUCTS, NAMELY, MILK AND PROCESSED CHEESE, BUTTER, HERBED BUTTER, POTATO CHIPS, DRIED MEATS, DRIED FISH, DRIED FRUITS AND VEGETABLES, PRESERVED VEGETABLES, FRUIT SAUCES, PREPARED MEALS CONSISTING PRIMARILY OF MEATS, FISH, CHICKEN, GAME AND VEGETABLES, SOUP MIXES AND SALAD MIXES (U.S. CL. 46).

CLASS 30—STAPLE FOODS

FOR DRIED HERBS; BAKED GOODS, NAMELY, BROWNIES, CAKES, BREAD, GRANOLA, TEA, COFFEE, COCOA, PASTRIES, HONEY, CONDIMENTS, NAMELY, CATSUP AND MUSTARD, SALAD DRESSINGS, CANDY, ICE CREAM, FLAVORED ICES, VINEGAR, PROCESSED GRAINS, NAMELY, SEASONINGS, PROCESSED CEREALS; NATURAL SWEETENERS; TACO CHIPS, BAKERY DESSERTS, CORN SYRUP, MAPLE SYRUP, CRACKERS, BISCUITS, PASTAS, SAUCES, MILK PRODUCTS, NAMELY, MILK SHAKES (U.S. CL. 46).

CLASS 31—NATURAL AGRICULTURAL PRODUCTS

FOR FRESH HERBS; PLANT SEEDS, LIVE FLOWERS, DRIED FLOWERS, LIVE BEDDING PLANTS; UNPROCESSED CEREALS, FRESH FRUITS AND VEGETABLES, NAMELY, APPLES, ORANGES, SPROUTS AND CARROTS; ANIMAL FOOD, PET FOOD BONES (U.S. CLS. 1 AND 46).

CLASS 42—SCIENTIFIC, COMPUTER AND LEGAL SERVICES

FOR RESTAURANT SERVICES (U.S. CLS. 100 AND 101).

SN 76-008,840. IDG BOOKS WORLDWIDE, INC., FOSTER CITY, CA. FILED 3-24-2000.

M&T

SN 76-004,461. INTELLISOLVE GROUP, INC., SAN ANTONIO, TX. FILED 3-20-2000.

INTELLISOLVE

OWNER OF U.S. REG. NO. 2,401,561.

CLASS 9—ELECTRICAL AND SCIENTIFIC APPARATUS

FOR COMPUTER PROGRAMS, NAMELY, CUSTOMIZED SOFTWARE FOR INTEGRATING DATA FOR ANALYSIS AND REPORTING OF BUSINESS INFORMATION ACROSS THE BUSINESS ENTERPRISE INCLUDING USER FRIENDLY MENUING FOR INPUT, ACCESS, AND RETRIEVAL OF ELECTRONICALLY STORED INFORMATION (U.S. CLS. 21, 23, 26, 36 AND 38).
FIRST USE 6-1-1998; IN COMMERCE 6-1-1998.

CLASS 9—ELECTRICAL AND SCIENTIFIC APPARATUS

FOR PRE-RECORDED CD-ROMS CONTAINING INFORMATION IN THE FIELD OF COMPUTERS, COMPUTER SOFTWARE AND INFORMATION TECHNOLOGY (U.S. CLS. 21, 23, 26, 36 AND 38).
FIRST USE 8-0-1996; IN COMMERCE 8-0-1996.

CLASS 16—PAPER GOODS AND PRINTED MATTER

FOR BOOKS AND GUIDES IN THE FIELD OF COMPUTERS, COMPUTER SOFTWARE AND INFORMATION TECHNOLOGY (U.S. CLS. 2, 5, 22, 23, 29, 37, 38 AND 50).
FIRST USE 11-0-1992; IN COMMERCE 11-0-1992.

CLASS 42—SCIENTIFIC, COMPUTER AND LEGAL SERVICES

FOR COMPUTER CONSULTING SERVICES, NAMELY, CONSULTING IN THE USE OF COMPUTER TECHNOLOGY FOR INPUT, ACCESS, AND RETRIEVAL OF BUSINESS INFORMATION AND FOR GENERATING REPORTS (U.S. CLS. 100 AND 101).
FIRST USE 6-1-1998; IN COMMERCE 6-1-1998.

SN 76-006,585. AMERICAN MARBLE INDUSTRIES, CANTON, OH. FILED 3-22-2000.

INNOVATIVE EDGE

NO CLAIM IS MADE TO THE EXCLUSIVE RIGHT TO USE "EDGE", APART FROM THE MARK AS SHOWN.

CLASS 11—ENVIRONMENTAL CONTROL APPARATUS

FOR PLUMBING FIXTURES, NAMELY, SINKS, SHOWER DOORS, SHOWER ENCLOSURES, BATHTUBS AND WHIRLPOOL TUBS (U.S. CLS. 13, 21, 23, 31 AND 34).

SN 76-008,965. HIROSE, TOKUZO, HYOGO-KEN, JAPAN, FILED 3-24-2000.

BIOSOFT

CLASS 1—CHEMICALS

FOR BACTERIA FOR USE IN FOOD MANUFACTURE, NAMELY, E-COLI AND SPORES OF BACTERIA (U.S. CLS. 1, 5, 6, 10, 26 AND 46).

CLASS 19—NON-METALLIC BUILDING MATERIALS

FOR NON-METAL COMPOSITE EDGE TRIM IN THE NATURE OF MOLDING (U.S. CLS. 1, 12, 33 AND 50).

CLASS 29—MEATS AND PROCESSED FOODS

FOR PROCESSED FRUITS AND VEGETABLES, EXCLUDING TEA LEAVES; PROCESSED EDIBLE SEAWEED (U.S. CL. 46).

CLASS 20—FURNITURE AND ARTICLES NOT OTHERWISE CLASSIFIED

FOR FURNITURE, NAMELY, COUNTER TOPS AND VANITIES (U.S. CLS. 2, 13, 22, 25, 32 AND 50).

CLASS 30—STAPLE FOODS

FOR PROCESSED GRAIN, NAMELY, FOXTAIL ITALIAN MILLET, CHINESE COMMON MILLET, SESAME, BUCKWHEAT, CORN, DECCAN GRASS MILLET, WHEAT, BARLEY, OATS, UNPROCESSED RICE, SORGHUM, NAMELY GRASS MILLET, MALT (U.S. CL. 46).

CLASS 31—NATURAL AGRICULTURAL PRODUCTS

FOR LIVE FISH AND SHELLFISH FOR FOOD; LIVE ANIMALS AND FISH, NOT FOR FOOD, LIVE BIRDS, LIVE INSECTS; UNPROCESSED FRUITS AND VEGETABLES, EXCLUDING TEA LEAVES; ANIMAL FOODSTUFFS, NAMELY, FORAGE, MICRO-ORGANISMS, AND PROTEIN FOR ANIMAL CONSUMPTION; LIVE TREES; LIVE GRASSES AND LAWN TURF DRIED FLOWERS; SEEDLINGS; LIVE SAPLINGS; LIVE FLOWERS; HAY, BONSAI, NAMELY, POTTED DWARFED TREES; UNPROCESSED GRAIN, NAMELY, FOXTAIL ITALIAN MILLET, CHINESE COMMON MILLET, SESAME, BUCKWHEAT, CORN, DECENT GRASS MILLET, WHEAT, BARLEY, OATS, UNPROCESSED RICE, SORGHUM, NAMELY GREAT MILLET AND INDIAN MILLET, MALT; AGRICULTURAL SEEDS OF URUSHI, ALSO CALLED JAPANESE LACQUER TREE; UNPROCESSED COCONUT FIBER, NAMELY COPRA, UNPROCESSED HOPS; UNPROCESSED CORK BARK; UNPROCESSED PALM TREE LEAVES; SILKWORM EGGS, COCOONS FOR HATCHING EGGS; EGGS FOR HATCHING; LIVE FISHING BAIT; UNPROCESSED TEA LEAVES; UNPROCESSED PLANTS FOR SUGAR PRODUCTION; PLANT SEEDS AND BULBS; LIVE AND DRIED FLOWER WREATHS (U.S. CLS. 1 AND 46).

SN 76-011,829. DIGITALCONVERGENCE.COM INC., DALLAS, TX. FILED 3-29-2000.

CRQ**CLASS 9—ELECTRICAL AND SCIENTIFIC APPARATUS**

FOR COMPUTER SOFTWARE, HARDWARE AND PERIPHERALS, NAMELY, SOFTWARE AND HARDWARE FOR INTERFACING BETWEEN THE INTERNET AND RADIO, TELEVISION AND PRINT MEDIA; COMPUTER SOFTWARE FOR INTERFACING WITH AN INPUT DEVICE SUCH AS A KEYSTROKE AUTOMATION APPLIANCE FOR READING AN ENCODED IMAGE AND CONVERTING IT TO KEYSTROKES; SOFTWARE FOR INTERFACING WITH THE OPERATING SYSTEM OF A PERSONAL COMPUTER TO ALLOW CODED INFORMATION TO BE INPUT THERETO BY A USER FOR THE PURPOSE OF ALLOWING THE USER TO INTERFACE WITH THE PERSONAL COMPUTER VIA THE CODED INFORMATION; AND ADDITIONAL SOFTWARE FOR LAUNCHING WEB PAGES ON THE INTERNET, SUCH AS VIA A LINK TO VARIOUS MEDIA AND TELECOMMUNICATIONS; SOFTWARE FOR AUDIBLY CONTROLLING A COMPUTER AND THE OPERATION THEREOF; SOFTWARE SYSTEM COMPRISING A SOFTWARE PROGRAM TO INTERFACE WITH THE INTERNET; AN AUDIO OR VIDEO TRANSDUCER FOR RECEIVING ENCODED AUDIO OR VIDEO; HAND-HELD INPUT DEVICES CAPABLE OF READING BAR CODES AND PROPRIETARY CODES FOR ALLOWING INPUT OF INFORMATION TO A COMPUTER DEVICE FOR RECEIVING CODED AUDIO FOR CONTROLLING A COMPUTER REMOTELY TO CONNECT TO THE INTERNET; MICE (U.S. CLS. 21, 23, 26, 36 AND 38).

CLASS 35—ADVERTISING AND BUSINESS

FOR PROVIDING INTERNET MARKETING SERVICES FOR OTHERS, NAMELY, DISSEMINATING ADVERTISING FOR OTHERS VIA THE INTERNET (U.S. CLS. 100, 101 AND 102).

CLASS 38—COMMUNICATION

FOR TELECOMMUNICATIONS SERVICES, NAMELY, PROVIDING USERS, THROUGH THE CONVERGENCE OF HARDWARE AND SOFTWARE TECHNOLOGY, AN INTERFACE TO THE INTERNET; PROVIDING VENDORS, THROUGH THE CONVERGENCE OF HARDWARE AND SOFTWARE TECHNOLOGY, AN INTERFACE FOR BROADCASTING AND/OR PUBLISHING INFORMATION OR ENTERTAINMENT OVER THE INTERNET (U.S. CLS. 100, 101 AND 104).

CLASS 42—SCIENTIFIC, COMPUTER AND LEGAL SERVICES

FOR COMPUTER SERVICES, NAMELY, PROVIDING HARDWARE AND SOFTWARE TECHNOLOGY FOR BROADCASTING AND/OR PUBLISHING INFORMATION OR ENTERTAINMENT OVER THE INTERNET (U.S. CLS. 100 AND 101).

SN 76-012,125. FAZIO GOLF COURSE DESIGNERS, INC., HENDERSONVILLE, NC. FILED 3-28-2000.

TOM FAZIO

THE NAME IN THE MARK IDENTIFIES A LIVING INDIVIDUAL WHOSE CONSENT IS OF RECORD.

CLASS 37—CONSTRUCTION AND REPAIR

FOR SHAPING, CONSTRUCTING, INSTALLING AND RENOVATING GOLF COURSES FOR OTHERS (U.S. CLS. 100, 103 AND 106).
FIRST USE 0-0-1967; IN COMMERCE 0-0-1967.

CLASS 42—SCIENTIFIC, COMPUTER AND LEGAL SERVICES

FOR DESIGNING GOLF COURSES FOR OTHERS (U.S. CLS. 100 AND 101).
FIRST USE 0-0-1967; IN COMMERCE 0-0-1967.

SN 76-012,650. ZEACOM GROUP LIMITED, GRAFTON, AUCKLAND, NEW ZEALAND, FILED 3-29-2000.

ZEACOM

OWNER OF NEW ZEALAND REG. NO. 600275, DATED 12-7-2000, EXPIRES 9-30-2006.

CLASS 9—ELECTRICAL AND SCIENTIFIC APPARATUS

FOR COMPUTER TELEPHONY SYSTEM SOFTWARE AND HARDWARE; TELEPHONY CALL DELIVERY SYSTEM SOFTWARE AND HARDWARE; CALL CENTER INTERACTIVE VOICE RESPONSE SYSTEM SOFTWARE AND HARDWARE (U.S. CLS. 21, 23, 26, 36 AND 38).
FIRST USE 10-10-1999; IN COMMERCE 11-5-1999.

CLASS 38—COMMUNICATION

FOR TELECOMMUNICATION SERVICES, NAMELY CALL CENTER SERVICES AND INTERACTIVE VOICE RESPONSE SERVICES DELIVERING VOICE, TEXT, AND IMAGE MESSAGES VIA LOCAL AND GLOBAL COMPUTER NETWORKS AND TELEPHONY NETWORKS (U.S. CLS. 100, 101 AND 104).
FIRST USE 10-10-1999; IN COMMERCE 11-5-1999.

CLASS 42—SCIENTIFIC, COMPUTER AND LEGAL SERVICES

FOR DESIGN AND INTEGRATION OF COMPUTER TECHNOLOGY SYSTEMS, TELEPHONY CALL DELIVERY SYSTEMS AND INTERACTIVE VOICE RESPONSE CALL CENTERS (U.S. CLS. 100 AND 101).

FIRST USE 10-10-1999; IN COMMERCE 11-5-1999.

SN 76-012,700. SYMMETRYGROUP, LLC, BUFFALO, NY.
FILED 3-29-2000.

IDENTIFIABLY DIFFERENT**CLASS 9—ELECTRICAL AND SCIENTIFIC APPARATUS**

FOR TECHNICAL WORK STATIONS, COMPRISED OF LABORATORY WORK SURFACES, SINKS, LIGHTING FIXTURES, ELECTRICAL OUTLETS, STORAGE RACKS AND CABINETS; AIR FLOW AND VENTILATION CONTROL DEVICES, NAMELY, PRESSURE AND TEMPERATURE CONTROL VALVES; AND LABORATORY EQUIPMENT, NAMELY, GLOVE BOXES (U.S. CLS. 21, 23, 26, 36 AND 38).

FIRST USE 1-26-1998; IN COMMERCE 1-26-1998.

CLASS 11—ENVIRONMENTAL CONTROL APPARATUS

FOR AIRFLOW AND VENTILATION DEVICES, NAMELY, AIRFLOW CONTAINMENT HOODS, FUME HOODS, TOTAL EXHAUST FILTERED RECIRCULATING HOODS; FUME SCRUBBER; INDUSTRIAL FILTERS FOR FILTERING PARTICULATE MATTER (U.S. CLS. 13, 21, 23, 31 AND 34).

FIRST USE 1-26-1998; IN COMMERCE 1-26-1998.

CLASS 20—FURNITURE AND ARTICLES NOT OTHERWISE CLASSIFIED

FOR FURNITURE, NAMELY, CLASSROOM FURNITURE, LOCKERS, CABINETS, AND DISPLAY COUNTERS; LABORATORY FURNITURE, COMPRISING, LABORATORY COUNTER TOPS; STOOLS; INDUSTRIAL AND COMMERCIAL LABORATORY CABINETS; AND HORIZONTAL AND VERTICAL CLEAN BENCHES FOR LABORATORY USE (U.S. CLS. 2, 13, 22, 25, 32 AND 50).

FIRST USE 1-26-1998; IN COMMERCE 1-26-1998.

SN 76-012,810. CODECULT SOFTWARE RESEARCH & DEVELOPMENT GMBH, 4486 BOCHUM, FED REP GERMANY, FILED 3-29-2000.

CODECULT

OWNER OF FED REP GERMANY REG. NO. 39914521,
DATED 4-28-1999, EXPIRES 3-31-2009.

CLASS 9—ELECTRICAL AND SCIENTIFIC APPARATUS

FOR COMPUTER SOFTWARE TO ENHANCE THE AUDIO VISUAL CAPABILITIES OF MULTIMEDIA APPLICATIONS, NAMELY FOR THE INTEGRATION OF TEXT, AUDIO, GRAPHICS, STILL IMAGES AND MOVING PICTURES; COMPUTER SOFTWARE FOR GRAPHIC APPLICATIONS, FOR PLAYING COMPUTER GAMES AND VIDEO GAMES, FOR RECORDING, TRANSMISSION OR REPRODUCTION OF SOUND, DATA OR IMAGES; COMPUTER SOFTWARE FOR COMPUTER OPERATING SYSTEMS; COMPUTER OPERATING SYSTEMS; COMPUTER PERIPHERALS; COMPUTER TERMINALS; COMPUTER INTERFACE BOARDS; COMPUTER CHIPS; PRE-RECORDED COMPUTER DISCS FEATURING COMPUTER GAMES OR VIDEO GAMES; PRE-RECORDED RECORDED CARRIERS FOR SOUND, IMAGE OR DIGITAL DATA; PRE-RECORDED VIDEO CASSETTES; APPARATUS FOR RECORDING CARRIERS FOR SOUND, IMAGE OR DIGITAL DATA; PRE-RECORDED VIDEO CASSETTES; APPARATUS FOR RECORDING, TRANSMISSION, OR REPRODUCTION OF SOUND AND IMAGES, NAMELY TELEPHONES, MOBILE TELEPHONES, PORTABLE MUSIC PLAYERS, VIDEO RECORDERS, VIDEO CAMERAS, DIGITAL VIDEO CAMERAS AND SOFTWARE SOLD AS A UNIT THEREWITH, PERSONAL DIGITAL ASSISTANTS; COMPUTER GAMES AND VIDEO GAMES FEATURING ADVENTURE GAMES; COMPUTER GAME CARTRIDGES; VIDEO GAME CARTRIDGES; COMPUTER GAME CASSETTES; GAME EQUIPMENT CONTAINING MEMORY DEVICES, NAMELY, COMPUTER DISCS OR CHIPS; ELECTRONIC GAME EQUIPMENT WITH A WATCH FUNCTION; VIDEO GAME OUTPUT MACHINES AND VIDEO GAME MACHINES FOR USE WITH TELEVISIONS; DOWNLOADABLE COMPUTER GAMES DISTRIBUTED VIA COMPUTER NETWORKS OR THE GLOBAL NETWORK OF INTERCONNECTED COMPUTERS; DOWNLOADABLE VIDEO GAMES DISTRIBUTED VIA COMPUTER NETWORKS OR THE GLOBAL NETWORK OF INTERCONNECTED COMPUTERS (U.S. CLS. 21, 23, 26, 36 AND 38).

CLASS 28—TOYS AND SPORTING GOODS

FOR GAMES AND PLAYTHINGS, NAMELY, ACTION FIGURES AND ACCESSORIES THEREFOR, ACTION SKILL GAMES, MECHANICAL ACTION TOYS, ACTION-TYPE TARGET GAMES, STUFFED TOY ANIMALS BOARD GAMES, TOY PISTOLS, PLAYGROUND BALLS, SPORTS BALLS, TOY BANKS, BATH TOYS, TEDDY BEARS, MUSIC BOX TOYS, CARD GAMES, DOLLS, ELECTRIC ACTION TOYS, PLAY FIGURES, PROMOTIONAL GAMES MATERIALS, MANIPULATIVE GAMES, KITES, MARIONETTE PUPPETS, TOY MOBILES, MUSICAL TOYS, TOY NOISE MAKERS, PLUSH TOYS, PUPPETS, JIGSAW PUZZLES, RIGHT-ON TOYS; STAND ALONE VIDEO GAME MACHINES; HAND HELD UNITS FOR PLAYING ELECTRONIC GAMES; HAND HELD UNITS FOR PLAYING VIDEO GAMES (U.S. CLS. 22, 23, 38 AND 50).

CLASS 42—SCIENTIFIC, COMPUTER AND LEGAL SERVICES

FOR DEVELOPMENT, UPDATING AND ADAPTING OF COMPUTER PROGRAMS FOR OTHERS; CONSULTANCY FOR COMPUTER-HARDWARE AND COMPUTER-SOFTWARE; CONSULTING FOR THE ORGANIZATION OF DATA PROCESSING; COMPUTER CONSULTING SERVICES; RENTAL OF COMPUTER-SOFTWARE, DATA PROCESSING EQUIPMENT AND COMPUTER PERIPHERAL DEVICES; PROVIDING DIGITAL IMAGE DATA, GRAPHIC DATA AND/OR SOUND DATA, NAMELY PROVIDING A WEBSITE ON GLOBAL COMPUTER NETWORKS FEATURING INFORMATION IN THE FIELD OF ENTERTAINMENT, GAMES, VIDEO GAMES, OR COMPUTER GAMES (U.S. CLS. 100 AND 101).

SN 76-012,811. CODECULT SOFTWARE RESEARCH & DEVELOPMENT GMBH, 4486 BOCHUM, FED REP GERMANY, FILED 3-29-2000.

CODECREATURES

OWNER OF FED REP GERMANY REG. NO. 39914520, DATED 4-28-1999, EXPIRES 3-31-2009.

CLASS 9—ELECTRICAL AND SCIENTIFIC APPARATUS

FOR COMPUTER SOFTWARE TO ENHANCE THE AUDIO VISUAL CAPABILITIES OF MULTIMEDIA APPLICATIONS, NAMELY FOR THE INTEGRATION OF TEXT, AUDIO, GRAPHICS, STILL IMAGES AND MOVING PICTURES; COMPUTER SOFTWARE FOR GRAPHIC APPLICATIONS, FOR PLAYING COMPUTER GAMES AND VIDEO GAMES, FOR RECORDING, TRANSMISSION OR REPRODUCTION OF SOUND, DATA OR IMAGES; COMPUTER SOFTWARE FOR COMPUTER OPERATING SYSTEMS; COMPUTER OPERATING SYSTEMS; COMPUTER PERIPHERALS; COMPUTER TERMINALS; COMPUTER INTERFACE BOARDS; COMPUTER CHIPS; PRE-RECORDED COMPUTER DISCS FEATURING COMPUTER GAMES OR VIDEO GAMES; PRE-RECORDED RECORDED CARRIERS FOR SOUND, IMAGE OR DIGITAL DATA; PRE-RECORDED VIDEO CASSETTES; APPARATUS FOR RECORDING CARRIERS FOR SOUND, IMAGE OR DIGITAL DATA; PRE-RECORDED VIDEO CASSETTES; APPARATUS FOR RECORDING, TRANSMISSION, OR REPRODUCTION OF SOUND AND IMAGES, NAMELY TELEPHONES, MOBILE TELEPHONES, PORTABLE MUSIC PLAYERS, VIDEO RECORDERS, VIDEO CAMERAS, DIGITAL VIDEO CAMERAS AND SOFTWARE SOLD AS A UNIT THEREWITH, PERSONAL DIGITAL ASSISTANTS; COMPUTER GAMES AND VIDEO GAMES FEATURING ADVENTURE GAMES; COMPUTER GAME CARTRIDGES; VIDEO GAME CARTRIDGES; COMPUTER GAME CASSETTES; GAME EQUIPMENT CONTAINING MEMORY DEVICES, NAMELY, COMPUTER DISCS OR CHIPS; ELECTRONIC GAME EQUIPMENT WITH A WATCH FUNCTION; VIDEO GAME OUTPUT MACHINES AND VIDEO GAME MACHINES FOR USE WITH TELEVISIONS; DOWNLOADABLE COMPUTER GAMES DISTRIBUTED VIA COMPUTER NETWORKS OR THE GLOBAL NETWORK OF INTERCONNECTED COMPUTERS; DOWNLOADABLE VIDEO GAMES DISTRIBUTED VIA COMPUTER NETWORKS OR THE GLOBAL NETWORK OF INTERCONNECTED COMPUTERS (U.S. CLS. 21, 23, 26, 36 AND 38).

CLASS 28—TOYS AND SPORTING GOODS

FOR GAMES AND PLAYTHINGS, NAMELY, ACTION FIGURES AND ACCESSORIES THEREFOR, ACTION SKILL GAMES, MECHANICAL ACTION TOYS, ACTION-TYPE TARGET GAMES, STUFFED TOY ANIMALS BOARD GAMES, TOY PISTOLS, PLAYGROUND BALLS, SPORTS BALLS, TOY BANKS, BATH TOYS, TEDDY BEARS, MUSIC BOX TOYS, CARD GAMES, DOLLS, ELECTRIC ACTION TOYS, PLAY FIGURES, PROMOTIONAL GAMES MATERIALS, MANIPULATIVE GAMES, KITES, MARIONETTE PUPPETS, TOY MOBILES, MUSICAL TOYS, TOY NOISE MAKERS, PLUSH TOYS, PUPPETS, JIGSAW PUZZLES, RIGHT-ON TOYS; STAND ALONE VIDEO GAME MACHINES; HAND HELD UNITS FOR PLAYING ELECTRONIC GAMES; HAND HELD UNITS FOR PLAYING VIDEO GAMES (U.S. CLS. 22, 23, 38 AND 50).

CLASS 42—SCIENTIFIC, COMPUTER AND LEGAL SERVICES

FOR DEVELOPMENT, UPDATING AND ADAPTING OF COMPUTER PROGRAMS FOR OTHERS; CONSULTANCY FOR COMPUTER-HARDWARE AND COMPUTER-SOFTWARE; CONSULTING FOR THE ORGANIZATION OF DATA PROCESSING; COMPUTER CONSULTING SERVICES; RENTAL OF COMPUTER-SOFTWARE, DATA PROCESSING EQUIPMENT AND COMPUTER PERIPHERAL DEVICES; PROVIDING DIGITAL IMAGE DATA, GRAPHIC DATA AND/OR SOUND DATA, NAMELY PROVIDING A WEBSITE ON GLOBAL COMPUTER NETWORKS FEATURING INFORMATION IN THE FIELD OF ENTERTAINMENT, GAMES, VIDEO GAMES, OR COMPUTER GAMES (U.S. CLS. 100 AND 101).

SN 76-013,708. J. PAUL GETTY TRUST, THE, LOS ANGELES, CA. FILED 3-30-2000.



OWNER OF U.S. REG. NOS. 2,091,377, 2,091,399 AND OTHERS.

CLASS 35—ADVERTISING AND BUSINESS

FOR RETAIL AND ON-LINE GIFT SHOP SERVICES; RETAIL AND ON-LINE RETAIL SERVICES FEATURING BOOKS, VIDEOS, TAPES AND OTHER PUBLISHED, PRINTED AND PRE-RECORDED WORKS IN THE FIELDS OF THE ARTS AND HUMANITIES (U.S. CLS. 100, 101 AND 102).

FIRST USE 7-8-1996; IN COMMERCE 7-8-1996.

CLASS 42—SCIENTIFIC, COMPUTER AND LEGAL SERVICES

FOR PROMOTING PUBLIC AWARENESS OF THE IMPORTANCE OF THE ARTS AND HUMANITIES; PROMOTING PUBLIC AWARENESS OF THE NEED FOR AN INTERNATIONAL STANDARD FOR DESCRIBING ART, ANTIQUES AND ANTIQUITIES THROUGH THE CREATION OF A UNIFORM SYSTEM FOR THE CLASSIFICATION OF ARTS; PROMOTING PUBLIC AWARENESS OF THE IMPORTANCE OF THE CONSERVATION AND PRESERVATION OF WORKS OF ARTS AND CULTURAL PROPERTIES; ARCHAEOLOGICAL SERVICES, NAMELY ARRANGING AND CONDUCTING ARCHAEOLOGICAL FIELD PROJECTS AND MANAGING ARCHAEOLOGICAL SITES; RESTAURANT SERVICES; ASSOCIATION SERVICES, NAMELY PROMOTING THE INTERESTS OF MUSEUM PATRONS AND MEMBERS (U.S. CLS. 100 AND 101).

FIRST USE 7-8-1996; IN COMMERCE 7-8-1996.

SN 76-013,930. ARNOLD & BIERBRAUER GMBH & CO. KG, 70173 STUTTGART, FED REP GERMANY, FILED 3-30-2000.

SN 76-020,123. UMTS FORUM, 8001 ZURICH, SWITZERLAND, FILED 4-7-2000.

COR

PRIORITY CLAIMED UNDER SEC. 44(D) ON ERPN CMNTY TM OFC APPLICATION NO. 1577949, FILED 3-27-2000, REG. NO. 1577949, DATED 5-3-2001, EXPIRES 3-27-2010.

CLASS 7—MACHINERY

FOR PUMPS, NAMELY, POSITIVE DISPLACEMENT PUMPS, ROTARY PUMPS, AIR COMPRESSORS, COMPRESSORS FOR MACHINES, COMPRESSORS FOR REFRIGERATORS (U.S. CLS. 13, 19, 21, 23, 31, 34 AND 35).

CLASS 42—SCIENTIFIC, COMPUTER AND LEGAL SERVICES

FOR ENGINEERING, TECHNICAL CONSULTATION AND RESEARCH IN THE FIELD OF ENGINEERING (U.S. CLS. 100 AND 101).

SN 76-014,130. ICF INFORMATION TECHNOLOGY, INC., FAIRFAX, VA. FILED 3-31-2000.



CLASS 35—ADVERTISING AND BUSINESS

FOR BUSINESS CONSULTING SERVICES FOR THE ENERGY INDUSTRY, NAMELY, CONSULTATION REGARDING THE PRODUCTION OF PROFILING, SCHEDULING, AND SETTLEMENT IN THE OPEN ACCESS MARKET THROUGH CREATING AND MODELING CUSTOMER AND CLASS SPECIFIC PROFILES, ESTIMATING CUSTOMERS' LOADS, DISTRIBUTING PROFILING ERRORS AND UNACCOUNTED FOR ENERGY, COMPARING AGGREGATED CUSTOMER LOADS TO SCHEDULED RESPONSIBILITIES AND ASSIGNING MONETARY RESPONSIBILITIES TO LOAD (U.S. CLS. 100, 101 AND 102).

CLASS 42—SCIENTIFIC, COMPUTER AND LEGAL SERVICES

FOR COMPUTER CONSULTATION, NAMELY, CONSULTING SERVICES FOR OTHERS IN THE ENERGY INDUSTRY REGARDING SOFTWARE APPLICATIONS (U.S. CLS. 100 AND 101).



UMTS
Forum

PRIORITY CLAIMED UNDER SEC. 44(D) ON SWITZERLAND APPLICATION NO. 09085/1999, FILED 10-8-1999, REG. NO. 470501, DATED 10-8-1999, EXPIRES 10-8-2009.

CLASS 16—PAPER GOODS AND PRINTED MATTER

FOR PRINTED MATTER, NAMELY, MAGAZINES, NEWSLETTERS AND BROCHURES IN THE FIELD OF MOBILE TELECOMMUNICATIONS (U.S. CLS. 2, 5, 22, 23, 29, 37, 38 AND 50).

CLASS 35—ADVERTISING AND BUSINESS

FOR PROMOTING THE GOODS AND SERVICES OF OTHERS THROUGH THE DISSEMINATION OF ONLINE AND PRINTED ADVERTISING; PUBLIC RELATIONS; CONDUCTING MARKETING STUDIES; BUSINESS CONSULTATION; AND BUSINESS MARKETING CONSULTATION (U.S. CLS. 100, 101 AND 102).

CLASS 38—COMMUNICATION

FOR TELECOMMUNICATION SERVICES, NAMELY, PERSONAL COMMUNICATION SERVICES AND LOCAL AND LONG-DISTANT TELEPHONE SERVICES (U.S. CLS. 100, 101 AND 104).

CLASS 42—SCIENTIFIC, COMPUTER AND LEGAL SERVICES

FOR CONSULTATION SERVICES, NAMELY, PROVIDING TECHNICAL ADVICE IN THE FIELD OF MOBILE TELECOMMUNICATION, AND RESEARCH AND DEVELOPMENT IN THE FIELD OF MOBILE TELECOMMUNICATION (U.S. CLS. 100 AND 101).

SN 76-020,863. INTERNATIONAL BUSINESS MACHINES CORPORATION, ARMONK, NY. FILED 4-7-2000.

MINDSPAN

CLASS 38—COMMUNICATION

FOR PROVIDING MULTIPLE-USER ACCESS TO A GLOBAL COMPUTER INFORMATION NETWORK (U.S. CLS. 100, 101 AND 104).

CLASS 41—EDUCATION AND ENTERTAINMENT

FOR COMPUTER EDUCATION TRAINING SERVICES PROVIDED VIA A GLOBAL COMPUTER NETWORK (U.S. CLS. 100, 101 AND 107).

SN 76-020,907. SPECTRUM MANAGEMENT, L.L.C., DALLAS, TX. FILED 4-7-2000.

SN 76-022,677. IK.COM LIMITED, GLOUCESTERSHIRE GL10 3HG, UNITED KINGDOM, FILED 4-11-2000.

SPECTRUM MANAGEMENT

NO CLAIM IS MADE TO THE EXCLUSIVE RIGHT TO USE "MANAGEMENT", APART FROM THE MARK AS SHOWN.

CLASS 35—ADVERTISING AND BUSINESS

FOR DISTRIBUTORSHIPS OF AN ELECTRONIC TRACKING DEVICE TO BE USED IN CONNECTION WITH LAW ENFORCEMENT (U.S. CLS. 100, 101 AND 102).

CLASS 37—CONSTRUCTION AND REPAIR

FOR MAINTENANCE OF AN ELECTRONIC TRACKING DEVICE TO BE USED IN CONNECTION WITH LAW ENFORCEMENT (U.S. CLS. 100, 103 AND 106).

CLASS 42—SCIENTIFIC, COMPUTER AND LEGAL SERVICES

FOR LEASING; TECHNICAL SUPPORT SERVICES AND MONITORING OF AN ELECTRONIC TRACKING DEVICE TO BE USED IN CONNECTION WITH LAW ENFORCEMENT (U.S. CLS. 100 AND 101).

SN 76-022,303. MIDWAY HOME ENTERTAINMENT INC., CHICAGO, IL. FILED 4-10-2000.

S.V.E.N.-209

CLASS 9—ELECTRICAL AND SCIENTIFIC APPARATUS

FOR COMPUTER AND VIDEO GAME PROGRAMS IN THE FORM OF CARTRIDGES, DISCS, CD ROMS, CASSETTES AND TAPES (U.S. CLS. 21, 23, 26, 36 AND 38).

CLASS 16—PAPER GOODS AND PRINTED MATTER

FOR PAPER GOODS, NAMELY, COMIC BOOKS, BOOKS IN THE FORM OF STRATEGY GUIDES FOR VIDEO GAMES, TRADING CARDS, POSTERS AND TRADING CARD MILK BOTTLE CAPS; PEN AND PENCIL TRAYS, HOLDERS, BOXES AND CASES; PENCIL SHARPENERS AND DECORATIVE PENCIL ORNAMENTS; PENCILS AND PENS; NOTEBOOKS; NOTEPADS, TEMPORARY TATTOOS AND STICKERS; CALENDARS AND STATIONERY (U.S. CLS. 2, 5, 22, 23, 29, 37, 38 AND 50).

CLASS 28—TOYS AND SPORTING GOODS

FOR COIN-OPERATED ARCADE AND VIDEO GAMES; HAND-HELD UNITS FOR PLAYING VIDEO GAMES; TOY ACTION FIGURES AND ACTION FIGURE ACCESSORIES (U.S. CLS. 22, 23, 38 AND 50).

CLASS 41—EDUCATION AND ENTERTAINMENT

FOR ENTERTAINMENT SERVICES, NAMELY, A CONTINUING SERIES OF TELEVISION SHOWS AND TELEVISION MOVIES FEATURING LIVE ACTION AND ANIMATION; PROVIDING ON-LINE COMPUTER GAMES (U.S. CLS. 100, 101 AND 107).

FQ

CLASS 9—ELECTRICAL AND SCIENTIFIC APPARATUS

FOR COMPUTER SOFTWARE FOR ENABLING WEB SITE MODIFICATION AND MAINTENANCE BY REMOTE ACCESS IN THE FIELD OF WEB SITE CREATION AND USE (U.S. CLS. 21, 23, 26, 36 AND 38).

CLASS 16—PAPER GOODS AND PRINTED MATTER

FOR PRINTED MATTER AND PUBLICATIONS, NAMELY, ILLUSTRATED, INSTRUCTIONAL LEAFLETS AND SHEETS IN THE FIELD OF WEB SITE DESIGN (U.S. CLS. 2, 5, 22, 23, 29, 37, 38 AND 50).

CLASS 38—COMMUNICATION

FOR PROVIDING MULTIPLE-USER ACCESS TO A GLOBAL COMPUTER INFORMATION NETWORK (U.S. CLS. 100, 101 AND 104).

CLASS 42—SCIENTIFIC, COMPUTER AND LEGAL SERVICES

FOR COMPUTER SERVICES, NAMELY, DESIGNING AND IMPLEMENTING WEB SITES FOR OTHERS (U.S. CLS. 100 AND 101).

SN 76-024,054. WILLEY BROTHERS, INC., ROCHESTER, NH. FILED 4-12-2000.

WILLEY BROTHERS

CLASS 35—ADVERTISING AND BUSINESS

FOR CONSULTING AND DESIGN SERVICES FOR FINANCIAL INSTITUTIONS, NAMELY ADVISING MARKETING STRATEGIES FOR BRAND AND IDENTITY RECOGNITION (U.S. CLS. 100, 101 AND 102).

FIRST USE 1-1-1995; IN COMMERCE 1-1-1995.

CLASS 37—CONSTRUCTION AND REPAIR

FOR CONSTRUCTION AND INSTALLATION MANAGEMENT SERVICES FOR FINANCIAL INSTITUTIONS (U.S. CLS. 100, 103 AND 106).

FIRST USE 1-1-1995; IN COMMERCE 1-1-1995.

CLASS 42—SCIENTIFIC, COMPUTER AND LEGAL SERVICES

FOR CONSULTING AND DESIGN SERVICES FOR FINANCIAL INSTITUTIONS, NAMELY OFFICE PLANNING, ARCHITECTURAL DESIGN AND RETAIL MERCHANDISING SYSTEMS, NAMELY DESIGNING POINT OF SALE MERCHANDISING DISPLAYS (U.S. CLS. 100 AND 101).

FIRST USE 1-1-1995; IN COMMERCE 1-1-1995.

SN 76-025,144. BTG INTERNATIONAL LIMITED, LONDON, GREAT BRITAIN, FILED 4-13-2000.

VARISOLVE

OWNER OF U.S. REG. NO. 2,273,712.

CLASS 1—CHEMICALS

FOR CHEMICALS FOR USE IN THE MANUFACTURE OF PHARMACEUTICALS IN THE NATURE OF THERAPEUTIC MICROFOAMS (U.S. CLS. 1, 5, 6, 10, 26 AND 46).

CLASS 5—PHARMACEUTICALS

FOR PHARMACEUTICAL PREPARATIONS, NAMELY, THERAPEUTIC MICROFOAMS FOR USE IN THE TREATMENT OF SCLEROTHERAPY OF VEINS WITH TREATMENT IN THE FIELDS OF PHLEBOLOGY, PROCTOLOGY AND ANGIOLOGY (U.S. CLS. 6, 18, 44, 46, 51 AND 52).

SN 76-027,758. CHA FOR TEA, INC., ARCADIA, CA. FILED 4-17-2000.



NO CLAIM IS MADE TO THE EXCLUSIVE RIGHT TO USE "CHA" & "TEA", APART FROM THE MARK AS SHOWN.

THE ENGLISH TRANSLATION OF "CHA" IS "TEA".

CLASS 21—HOUSEWARES AND GLASS

FOR SOUVENIR ITEMS, NAMELY, CUPS, MUGS, TEAPOTS NOT OF PRECIOUS METAL, BOWLS (U.S. CLS. 2, 13, 23, 29, 30, 33, 40 AND 50).

FIRST USE 11-26-1999; IN COMMERCE 11-26-1999.

CLASS 30—STAPLE FOODS

FOR TEAS, TEA DRINKS, NAMELY, ICED TEA, FRUIT FLAVORED TEAS, COFFEES, COFFEE DRINKS, NAMELY, SHAKES, ICED COFFEE (U.S. CL. 46).

FIRST USE 11-26-1999; IN COMMERCE 11-26-1999.

CLASS 32—LIGHT BEVERAGES

FOR FRUIT DRINKS AND FRUIT JUICES (U.S. CLS. 45, 46 AND 48).

FIRST USE 11-26-1999; IN COMMERCE 11-26-1999.

CLASS 42—SCIENTIFIC, COMPUTER AND LEGAL SERVICES

FOR OPERATION OF CAFE STYLE RESTAURANT FOR ON-PREMISES AND OFF-PREMISES CONSUMPTION OF FOOD AND BEVERAGES (U.S. CLS. 100 AND 101).

FIRST USE 11-26-1999; IN COMMERCE 11-26-1999.

SN 76-027,981. KABUSHIKI KAISHA FAST RETAILING, DBA FAST RETAILING CO., LTD., YAMAGUCHI-SHI, YAMAGUCHI 754-0894, JAPAN, FILED 4-18-2000.



PRIORITY CLAIMED UNDER SEC. 44(D) ON JAPAN APPLICATION NO. 2000-3902, FILED 1-24-2000, REG. NO. 4433063, DATED 11-17-2000, EXPIRES 11-17-2010.

CLASS 9—ELECTRICAL AND SCIENTIFIC APPARATUS

FOR SUNGLASSES AND EYEGLASSES (U.S. CLS. 21, 23, 26, 36 AND 38).

CLASS 18—LEATHER GOODS

FOR BACKPACKS, GARMENT BAGS FOR SHOPPING, BRIEFCASES, KEY CASES, PARASOLS, POCKET WALLETS, POUCHES OF LEATHER FOR PACKAGING, PURSES, SCHOOL BAGS, SHOPPING BAGS MADE OF SYNTHETIC RESIN AND WOVEN AND NON-WOVEN CLOTH, TRAVELING TRUNKS, UMBRELLAS (U.S. CLS. 1, 2, 3, 22 AND 41).

CLASS 24—FABRICS

FOR FACE TOWELS OF TEXTILE, HANDKERCHIEFS OF TEXTILE AND TOWELS OF TEXTILE (U.S. CLS. 42 AND 50).

CLASS 25—CLOTHING

FOR CLOTHING, NAMELY, SHIRTS, T-SHIRTS, PANTS, JEANS, JACKETS, COATS, DRESSES, SKIRTS, SOCKS, TIGHTS, GLOVES, VESTS, UNDERWEAR, ANORAKS, RAINWEAR, WIND RESISTANT JACKETS, SWEATSHIRTS, TANK TOPS, PULLOVERS, SWEATERS, KNIT SHIRTS, CARDIGANS, BELTS, PARKAS, HATS, CAPS, MUFFLERS, FOOTWEAR AND HEADWEAR (U.S. CLS. 22 AND 39).

SN 76-028,186. KABUSHIKI KAISHA FAST RETAILING, DBA FAST RETAILING CO. LTD., YAMAGUCHI 754-0894, JAPAN, FILED 4-18-2000.

UNIQLO KIDS

OWNER OF JAPAN REG. NO. 4342482, DATED 12-10-1999, EXPIRES 12-10-2009.

NO CLAIM IS MADE TO THE EXCLUSIVE RIGHT TO USE "KIDS", APART FROM THE MARK AS SHOWN.

CLASS 18—LEATHER GOODS

FOR BACKPACKS, GARMENT BAGS FOR SHOPPING, BRIEFCASES, KEY CASES, PARASOLS, POCKET WALLET, POUCHES OF LEATHER FOR PACKAGING, PURSES, SCHOOL BAGS, SHOPPING BAGS MADE OF SYNTHETIC RESIN AND WOVEN AND NON-WOVEN CLOTH, TRAVELING TRUNKS, UMBRELLAS (U.S. CLS. 1, 2, 3, 22 AND 41).

CLASS 24—FABRICS

FOR FACE TOWELS OF TEXTILE, HANDKERCHIEFS OF TEXTILE AND TOWELS OF TEXTILE (U.S. CLS. 42 AND 50).

CLASS 25—CLOTHING

FOR CLOTHING, NAMELY, SHIRTS, T-SHIRTS, PANTS, JEANS, JACKETS, COATS, DRESSES, SKIRTS, SOCKS, TIGHTS, GLOVES, VESTS, UNDERWEAR, ANORAKS, RAINWEAR, WIND RESISTANT JACKETS, SWEATSHIRTS, TANK TOPS, PULLOVERS, SWEATERS, KNIT SHIRTS, CARDIGANS, BELTS, PARKAS, HATS, CAPS, MUFFLERS, FOOTWEAR AND HEADWEAR (U.S. CLS. 22 AND 39).

SN 76-030,784, HCB ENTERPRISES, INC., DALLAS, TX. FILED 4-19-2000.

BIBBENTUCKERS BRIDE FOREVER

CLASS 37—CONSTRUCTION AND REPAIR

FOR CLOTHING MAINTENANCE AND REPAIR SERVICES, NAMELY MENDING, LEATHER CLEANING FOR ANIMAL SKINS, HIDES, AND IMITATIONS OF LEATHER, LAUNDRY AND DRY CLEANING SERVICES; AND CLOTHING MAINTENANCE AND REPAIR SERVICES, NAMELY MENDING, LEATHER CLEANING FOR ANIMAL SKINS, HIDES AND IMITATIONS OF LEATHER, LAUNDRY AND DRY CLEANING SERVICES, WHICH MAY BE ORDERED VIA GLOBAL COMPUTER NETWORKS (U.S. CLS. 100, 103 AND 106).

CLASS 39—TRANSPORTATION AND STORAGE

FOR PICK-UP AND DELIVERY SERVICES FOR CLOTH, CLOTHING, FABRIC, LEATHER, AND IMITATIONS OF LEATHER VIA GROUND TRANSPORTATION; AND PICK-UP AND DELIVERY SERVICES FOR CLOTH, CLOTHING, FABRIC, LEATHER, AND IMITATIONS OF LEATHER VIA GROUND TRANSPORTATION, WHICH MAY BE ORDERED VIA GLOBAL COMPUTER NETWORKS (U.S. CLS. 100 AND 105).

SN 76-032,127, TAXFREE.COM, INC., DENVER, CO. FILED 4-21-2000.

TAXFREE.COM

CLASS 16—PAPER GOODS AND PRINTED MATTER

FOR MAGAZINES CONCERNING BUSINESS AND FINANCE (U.S. CLS. 2, 5, 22, 23, 29, 37, 38 AND 50).

CLASS 35—ADVERTISING AND BUSINESS

FOR PROMOTING THE GOODS AND SERVICES OF OTHERS BY PREPARING AND PLACING ADVERTISEMENTS IN AN ELECTRONIC MAGAZINE ACCESSED THROUGH A GLOBAL NETWORK (U.S. CLS. 100, 101 AND 102).

CLASS 36—INSURANCE AND FINANCIAL

FOR PROVIDING FINANCIAL INFORMATION ABOUT INVESTMENTS ACCESSED THROUGH A GLOBAL COMPUTER NETWORK (U.S. CLS. 100, 101 AND 102).

CLASS 38—COMMUNICATION

FOR PROVIDING ON-LINE CHAT ROOMS AND ELECTRONIC BULLETIN BOARDS FOR TRANSMISSION OF MESSAGES AMONG COMPUTER USERS, AND BROADCASTING PROGRAMS ON A GLOBAL COMPUTER NETWORK, ALL CONCERNING BUSINESS AND FINANCE (U.S. CLS. 100, 101 AND 104).

CLASS 42—SCIENTIFIC, COMPUTER AND LEGAL SERVICES

FOR COMPUTER SERVICES, NAMELY PROVIDING AN ON-LINE MAGAZINE CONCERNING BUSINESS AND FINANCE, AND PROVIDING A SEARCH ENGINE FOR OBTAINING DATA ON A GLOBAL COMPUTER NETWORK (U.S. CLS. 100 AND 101).

SN 76-032,141, UNICA CORPORATION, LINCOLN, MA. FILED 4-21-2000.

UNICA AFFINIUM

THE ENGLISH TRANSLATION OF THE FEMALE SPANISH TERM "UNICA" IS THE "ONLY", "SOLE", "UNIQUE", "UNMATCHED", "UNEQUALLED".

CLASS 9—ELECTRICAL AND SCIENTIFIC APPARATUS

FOR COMPUTER SOFTWARE FOR MARKETING, CUSTOMER RELATIONSHIP MANAGEMENT, AND CUSTOMER INTERACTION MANAGEMENT PURPOSES, NAMELY, FOR USE IN CREATING AND MANAGING MARKETING CAMPAIGNS, CUSTOMER PROFILING, DATA MINING, COLLECTING DATA FOR PREDICTIVE MODELING, DATABASE CONTENT MANAGEMENT, CREATING AND MANAGING PERSONALIZED CUSTOMER RELATIONSHIP MANAGEMENT STRATEGIES, MARKETING MODELS, MARKETING REPORTS, AND E-MAIL CAMPAIGNS (U.S. CLS. 21, 23, 26, 36 AND 38).

CLASS 41—EDUCATION AND ENTERTAINMENT

FOR EDUCATIONAL SERVICES, NAMELY COMPUTER HARDWARE AND SOFTWARE TRAINING SERVICES RELATED TO MARKETING, CUSTOMER RELATIONSHIP MANAGEMENT AND CUSTOMER INTERACTION MANAGEMENT, NAMELY CAMPAIGN MANAGEMENT, CUSTOMER PROFILING, DATA MINING, PREDICTIVE MODELING, CONTENT MANAGEMENT, CREATING REPORTS AND PERSONALIZED BUSINESS MARKETING (U.S. CLS. 100, 101 AND 107).

CLASS 42—SCIENTIFIC, COMPUTER AND LEGAL SERVICES

FOR COMPUTER SERVICES IN THE NATURE OF PROVIDING COMPUTER CONSULTATION, ADVICE, INTEGRATION, AND IMPLEMENTATION IN CONNECTION WITH CUSTOMER RELATIONSHIP MANAGEMENT AND CUSTOMER INTERACTION MANAGEMENT NAMELY, CUSTOMER PROFILING, DATA MINING, PREDICTIVE MODELING, CONTENT MANAGEMENT, REPORTING AND PERSONALIZATION VIA AN ON-LINE GLOBAL COMPUTER NETWORK (U.S. CLS. 100 AND 101).

SN 76-033,428. COMPAGNIE INTERNATIONALE DES WAGONS-LITS ET DU TOURISME, BRUXELLES, BELGIUM, FILED 4-25-2000.



SN 76-033,263. CHEF REVIVAL USA INC., LODI, NJ. FILED 4-20-2000.



OWNER OF U.S. REG. NOS. 1,634,857, 2,112,949 AND OTHERS.

NO CLAIM IS MADE TO THE EXCLUSIVE RIGHT TO USE "CHEF", APART FROM THE MARK AS SHOWN.

CLASS 8—HAND TOOLS

FOR KITCHEN UTENSILS, NAMELY, GARNISHING KITS COMPRISED OF KNIFE BLADES, SAW BLADES FOR HAND-HELD SAWS, SCALPELS AND A CARRYING CASE, REPLACEMENT KNIFE BLADES, REPLACEMENT SAW BLADES FOR HAND-HELD SAWS, NON-ELECTRIC BONE SAWS, CLEAVERS, POULTRY SHEARS, KITCHEN SCISSORS, TONGS, RASPS, NON-ELECTRONIC PEELERS, ICE CHISELS, SHARPENING STONES, SHARPENING STEELS (U.S. CLS. 23, 28 AND 44).

CLASS 9—ELECTRICAL AND SCIENTIFIC APPARATUS

FOR KITCHEN UTENSILS, NAMELY, THERMOMETERS, MEASURING CUPS (U.S. CLS. 21, 23, 26, 36 AND 38).

CLASS 21—HOUSEWARES AND GLASS

FOR KITCHEN UTENSILS, NAMELY, WHISKS, MOLDS, INSULATED SAUCE BOTTLE SOLD EMPTY, SAUCE BOTTLES SOLD EMPTY, GRATERS, RICERS, ZESTERS, MELON BALLERS, APPLE CORERS, SERVING SPOONS, PERFORATED SPOONS, SPICE CONTAINERS SOLD EMPTY, GARNISHING KITS COMPRISED OF MELON BALLERS, NON-ELECTRIC PEELERS, ZESTERS, APPLE CORERS, KNIVES AND A CARRYING CASE (U.S. CLS. 2, 13, 23, 29, 30, 33, 40 AND 50).

OWNER OF U.S. REG. NOS. 2,124,935, 2,339,831 AND OTHERS.

THE TRANSLATION OF THE FOREIGN WORDING IN THE MARK IS "INTERNATIONAL COMPANY OF SLEEPING CARS AND GREAT EUROPEAN TRAINS".

CLASS 9—ELECTRICAL AND SCIENTIFIC APPARATUS

FOR HOME VIDEO GAME CONSOLES FOR USE WITH A TELEVISION; MULTIMEDIA SOFTWARE RECORDED ON CD-ROM FOR PLAYING VIDEO GAMES (U.S. CLS. 21, 23, 26, 36 AND 38).

CLASS 28—TOYS AND SPORTING GOODS

FOR GAMES AND PLAYTHINGS, NAMELY, DOLLS AND ELECTRIC TRAINS; PUZZLES, NAMELY, THREE DIMENSIONAL POLYSTYRENE PUZZLES, TWO-DIMENSIONAL PUZZLES MADE OF CARDBOARD, PLASTICS AND WOOD; MODELS OF TRAIN CARS, NAMELY, SLEEPER CARS, DINING CARS, AND LOUNGE CARS; BUILDING GAMES, NAMELY, GAMES BUILDING TRAIN CARS, NAMELY, SLEEPER CARS, DINING CARS AND LOUNGE CARS; HAND HELD UNITS FOR PLAYING VIDEO GAMES (U.S. CLS. 22, 23, 38 AND 50).

SN 76-033,489. ELSEVIER SCIENCE, INC., NEW YORK, NY. FILED 4-25-2000.

CHEMNAVIGATOR**CLASS 35—ADVERTISING AND BUSINESS**

FOR COMPUTERIZED DATABASE MANAGEMENT (U.S. CLS. 100, 101 AND 102).

CLASS 41—EDUCATION AND ENTERTAINMENT

FOR PROVIDING EDUCATIONAL INFORMATION IN THE FIELD OF SCIENCE VIA THE INTERNET (U.S. CLS. 100, 101 AND 107).

CLASS 42—SCIENTIFIC, COMPUTER AND LEGAL SERVICES

FOR PROVIDING NON-DOWNLOADABLE COMPUTER SOFTWARE FOR USE IN ACCESSING AND SEARCHING DATABASES IN THE FIELD OF SCIENCE VIA A GLOBAL COMPUTER NETWORK, AND INFORMATION IN THE FIELDS OF SCIENCE AND SCIENTIFIC RESEARCH (U.S. CLS. 100 AND 101).

SN 76-033,494. ELSEVIER SCIENCE, INC., NEW YORK, NY.
FILED 4-25-2000.

ENGINEERINGNAVIGATOR

CLASS 35—ADVERTISING AND BUSINESS

FOR COMPUTERIZED DATABASE MANAGEMENT (U.S. CLS. 100, 101 AND 102).

CLASS 41—EDUCATION AND ENTERTAINMENT

FOR PROVIDING EDUCATIONAL INFORMATION IN THE FIELD OF SCIENCE VIA THE INTERNET (U.S. CLS. 100, 101 AND 107).

CLASS 42—SCIENTIFIC, COMPUTER AND LEGAL SERVICES

FOR PROVIDING NON-DOWNLOADABLE COMPUTER SOFTWARE FOR USE IN ACCESSING AND SEARCHING DATABASES IN THE FIELD OF SCIENCE VIA A GLOBAL COMPUTER NETWORK, AND INFORMATION IN THE FIELDS OF SCIENCE AND SCIENTIFIC RESEARCH (U.S. CLS. 100 AND 101).

SN 76-033,682. MONTANA TRADEMARKS, 75017 PARIS, FRANCE, FILED 4-25-2000.



PRIORITY CLAIMED UNDER SEC. 44(D) ON FRANCE APPLICATION NO. 99820663, FILED 10-29-1999, REG. NO. 99820663, DATED 10-29-1999, EXPIRES 10-29-2009.

OWNER OF U.S. REG. NOS. 1,443,291, 1,929,368 AND OTHERS.

THE LEFT-HAND SIDE OF THE RECTANGLE IN APPLICANT'S MARK IS BLACK WITH THE WORD "MONTANA" IN WHITE SCRIPT. THE RIGHT-HAND SIDE OF THE RECTANGLE IS BLUE WITH THE WORD "BLU" IN WHITE SCRIPT. COLOR IS CLAIMED AS A FEATURE OF THIS MARK.

CLASS 9—ELECTRICAL AND SCIENTIFIC APPARATUS

FOR (BASED ON INTENT TO USE) SPECTACLES AND SPECTACLE CASES (U.S. CLS. 21, 23, 26, 36 AND 38).

CLASS 14—JEWELRY

FOR (BASED ON INTENT TO USE) JEWELRY AND WATCHES (U.S. CLS. 2, 27, 28 AND 50).

CLASS 18—LEATHER GOODS

FOR (BASED ON INTENT TO USE) ARTICLES OF LEATHER AND IMITATIONS OF LEATHER, NAMELY, LUGGAGE, TRUNKS, SUITCASES, BAGS, HANDBAGS, ATTACHE CASES, WALLETS, PURSES, UMBRELLAS AND RELATED ARTICLES (U.S. CLS. 1, 2, 3, 22 AND 41).

CLASS 25—CLOTHING

FOR (BASED ON USE IN COMMERCE) CLOTHING, NAMELY, JACKETS, TROUSERS, PANTS, RAINCOATS, COATS, SWEATERS, VESTS, BLOUSES, DRESSING GOWNS, BATH ROBES, PAJAMAS, UNDERSHIRTS, T-SHIRTS, UNDERWEAR, UNDERCLOTHING, SWIMSUITS, BATHING SUITS, SOCKS, STOCKINGS, LEGGINGS, NECK-TIES, NECKERCHIEFS, SCARVES, GLOVES, HATS, CAPS, BELTS, BOOTS, SHOES, AND SLIPPERS (U.S. CLS. 22 AND 39).

FIRST USE 10-29-1999; IN COMMERCE 10-29-1999.

SN 76-034,506. LES DERIVES RESINIQUES ET TERPENIQUES, 40100 DAX, FRANCE, FILED 4-25-2000.

DERTOPHENE

CLASS 1—CHEMICALS

FOR ARTIFICIAL UNPROCESSED PHENOLIC TERPENE RESINS FOR USE IN THE ADHESIVE, COATING AND RUBBER INDUSTRIES (U.S. CLS. 1, 5, 6, 10, 26 AND 46).

FIRST USE 9-2-1975; IN COMMERCE 5-17-1994.

CLASS 2—PAINTS

FOR NATURAL PHENOLIC TERPENE RESINS FOR USE IN THE ADHESIVE, COATING AND RUBBER INDUSTRIES (U.S. CLS. 6, 11 AND 16).

FIRST USE 9-2-1975; IN COMMERCE 5-17-1994.

SN 76-034,791. NETCENTREX S.A., CAEN, FRANCE, FILED 4-26-2000.

IPCENTREX

CLASS 9—ELECTRICAL AND SCIENTIFIC APPARATUS

FOR TELECOMMUNICATIONS SYSTEMS COMPRISED OF COMPUTER HARDWARE AND COMPUTER SOFTWARE FOR MANAGING VOICE-DATA COMMUNICATIONS OVER LOCAL AREA NETWORKS (LAN), WIDE AREA NETWORKS (WAN) AND GLOBAL COMPUTER NETWORKS (U.S. CLS. 21, 23, 26, 36 AND 38).

CLASS 16—PAPER GOODS AND PRINTED MATTER

FOR TRAINING MATERIALS, NAMELY PRINTED INSTRUCTIONAL MATERIALS AND MANUALS FOR TELECOMMUNICATIONS SYSTEMS COMPRISED OF COMPUTER HARDWARE AND SOFTWARE FOR MANAGING VOICE-DATA COMMUNICATIONS OVER LOCAL AREA NETWORKS (LAN), WIDE AREA NETWORKS (WAN) AND GLOBAL COMPUTER NETWORKS (U.S. CLS. 2, 5, 22, 23, 29, 37, 38 AND 50).

CLASS 37—CONSTRUCTION AND REPAIR

FOR REPAIR SERVICES RELATED TO TELECOMMUNICATIONS SYSTEMS COMPRISED OF COMPUTER HARDWARE AND COMPUTER SOFTWARE FOR MANAGING VOICE-DATA TRAFFIC OVER LOCAL AREA NETWORKS (LAN), WIDE AREA NETWORKS (WAN), AND GLOBAL COMPUTER NETWORKS (U.S. CLS. 100, 103 AND 106).

CLASS 41—EDUCATION AND ENTERTAINMENT

FOR EDUCATIONAL SERVICES, NAMELY PROVIDING CLASSES AND WORKSHOPS ON THE SUBJECT OF TELECOMMUNICATIONS SYSTEMS FOR MANAGING VOICE-DATA TRAFFIC OVER LOCAL AREA NETWORKS (LAN), WIDE AREA NETWORKS (WAN) AND GLOBAL COMPUTER NETWORKS, AND PROVIDING COURSE MATERIALS, NAMELY PRINTED INSTRUCTIONAL MATERIALS AND MANUALS RELATED THERETO (U.S. CLS. 100, 101 AND 107).

CLASS 42—SCIENTIFIC, COMPUTER AND LEGAL SERVICES

FOR TECHNICAL SUPPORT SERVICES, NAMELY TROUBLESHOOTING FOR TELECOMMUNICATION SYSTEMS COMPRISED OF COMPUTER HARDWARE AND COMPUTER SOFTWARE FOR MANAGING VOICE-DATA TRAFFIC OVER LOCAL AREA NETWORKS (LAN), WIDE AREA NETWORKS (WAN), AND GLOBAL COMPUTER NETWORKS VIA TELEPHONE, E-MAIL, FACSIMILE AND IN PERSON; AND COMPUTER PROGRAMMING SERVICES TO SUPPORT THE DEVELOPMENT OF CUSTOM SOFTWARE APPLICATIONS RELATED TO MANAGING VOICE-DATA TRAFFIC OVER LOCAL AREA NETWORKS (LAN), WIDE AREA NETWORKS (WAN) AND GLOBAL COMPUTER NETWORKS (U.S. CLS. 100 AND 101).

SN 76-034,964. SILKEBORG ULDSPINDERI APS, KJELLERUP, DENMARK, FILED 4-26-2000.

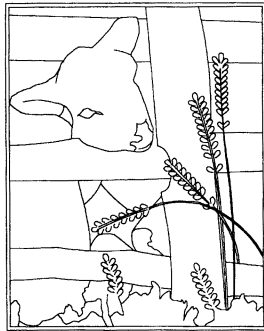

OWNER OF DENMARK REG. NO. VR199804008, DATED 12-2-1998, EXPIRES 12-2-2008.

THE MARK CONSISTS OF A DRAWING OF A LAMB POKING ITS HEAD BETWEEN THE SLATS OF A WOODEN FENCE, WITH STALKS OF WHEAT IN THE FOREGROUND.

CLASS 23—YARNS AND THREADS

FOR YARNS AND THREADS MADE OF WOOL, COTTON AND/OR SYNTHETIC MATERIALS, FOR TEXTILE USE (U.S. CL. 43).

CLASS 24—FABRICS

FOR TEXTILES AND TEXTILE GOODS, NAMELY FABRIC SOLD BY THE YARD FOR USE IN THE MANUFACTURE OF CLOTHING, NAMELY, BLOUSES, DRESSES, SKIRTS, JACKETS, SLACKS, PANTS, SUITS, SCARVES, SHAWLS, FOOTWEAR AND HEADWEAR, AS WELL AS CURTAINS, WALL HANGINGS AND FURNITURE COVERINGS; EIDERDOWN QUILTS, BED BLANKETS, CLOTH BED AND TABLE COVERS; WOVEN TRAVELLING RUGS AND PLAIDS, NAMELY, THROW BLANKETS MADE OF WOOL OR OF WOOL IN COMBINATION WITH COTTON AND/OR SYNTHETIC MATERIALS (U.S. CLS. 42 AND 50).

CLASS 25—CLOTHING

FOR CLOTHING, NAMELY BLOUSES, SWEATERS, DRESSES, SKIRTS, JACKETS, SLACKS, PANTS, SUITS, SCARVES, SHAWLS, SOCKS, GLOVES, FOOTWEAR, MADE OF WOOL OR OF WOOL IN COMBINATION WITH COTTON AND/OR SYNTHETIC MATERIALS (U.S. CLS. 22 AND 39).

CLASS 27—FLOOR COVERINGS

FOR CARPETS, RUGS, DOOR MATS AND MATTING, NAMELY CARPET UNDERLAY AND UNDERLINING (U.S. CLS. 19, 20, 37, 42 AND 50).

SN 76-035,177. BUSINESS DESIGN, INC., MINATO-KU, TOKYO, JAPAN, FILED 4-26-2000.

Go Smoking!

PRIORITY CLAIMED UNDER SEC. 44(D) ON JAPAN APPLICATION NO. 2000-27865, FILED 3-22-2000, REG. NO. 4444469, DATED 1-5-2001, EXPIRES 1-5-2011.

CLASS 14—JEWELRY

FOR NAPKIN HOLDERS AND NAPKIN RINGS MADE OF PRECIOUS METALS, JEWELRY BOXES MADE OF PRECIOUS METALS, CANDLE SNUFFERS AND CANDLE HOLDERS MADE OF PRECIOUS METALS, COMPACTS SOLD EMPTY AND MADE OF PRECIOUS METALS, JAPANESE SMOKING PIPES MADE OF PRECIOUS METALS, JAPANESE SMOKING PIPE CASES SOLD EMPTY AND MADE OF PRECIOUS METALS, TOBACCO POUCHES MADE OF PRECIOUS METALS, CIGARETTE CASES MADE OF PRECIOUS METALS, CIGARETTE HOLDERS MADE OF PRECIOUS METALS, ASHTRAYS MADE OF PRECIOUS METALS, SMOKING PIPES MADE OF PRECIOUS METALS, EARRINGS, MEDALLIONS MADE OF PRECIOUS METALS, BELT BUCKLES MADE OF PRECIOUS METALS, BADGES MADE OF PRECIOUS METALS, HAT PINS MADE OF PRECIOUS METALS, TIE TACKS, NECKTIE PINS, NECKLACES, BRACELETS, PENDANTS, FINE JEWELRY BROACHES, RINGS, LOCKETS, CUFF LINKS, WRIST WATCHES, CLOCKS, POCKET WATCHES, CLOCKS FOR AUTOMOBILES, STOP WATCHES, HANGING CLOCKS, ALARM CLOCKS, AND KEY CHAINS MADE OF PRECIOUS METALS (U.S. CLS. 2, 27, 28 AND 50).

CLASS 16—PAPER GOODS AND PRINTED MATTER

FOR PICTURE POST CARDS, CALENDARS, PRINTED PAPER TIME TABLES, MAPS, PHOTO ALBUMS, PLAYING CARDS, POCKET NOTEBOOKS, BOOKS OF PRINTED PAPER SALES SLIP FORMS, STATIONERY, ENVELOPES, NOTE PADS, PENCILS, CAPS FOR PENCILS, MARKERS, MECHANICAL PENCILS, FELT PENS, BALL POINT PENS, FOUNTAIN PENS, WRITING BRUSHES, INK POTS, INK STAMPS, INK STAMP CASES, THUMB TACKS, PAPER CLIPS, PAPER TAGS, STICKERS, ADHESIVE TAPES FOR STATIONERY USE, PRICE TAGS, PENCIL DESK STANDS, PENCIL CASES, DESK PAPER WEIGHT, AND ADDRESS LABELS (U.S. CLS. 2, 5, 22, 23, 29, 37, 38 AND 50).

CLASS 25—CLOTHING

FOR JACKETS, JOGGING PANTS, SWEAT PANTS, SUITS, SKIRTS, SKI JACKETS, SKI PANTS, TROUSERS, SMOCKS, OVER COATS, TOPPER COATS, MANTLES, RAIN COATS, CARDIGAN JACKETS, SWEATERS, VESTS, OPEN-NECKED SHIRTS, CUFFS, COLLARS, SPORT SHIRTS, BLOUSES, POLO SHIRTS, SHIRTS, NIGHTGOWNS, NEGLIGEEES, JAPANESE KIMONO-PAJAMA, PAJAMAS, BATH ROBES, CAMISOLES, CORSETS, UNDER SHIRTS, CHEMISES, DRAWERS, SLIPS, PANTS, BRASSIERES, PETTICOATS, SWIM WEAR, SWIMMING CAPS, APRONS, SOCKS AND STOCKINGS, WOOL MUFFLERS, SHAWLS, SCARFS, GLOVES, NECKTIES, NECKERCHIEFS, BANDANNAS, MUFFLERS, NIGHT CAPS, HATS, CAPS, BELTS, JAPANESE SANDALS, AND SLIPPERS (U.S. CLS. 22 AND 39).

CLASS 34—SMOKERS' ARTICLES

FOR JAPANESE SMOKING PIPES, JAPANESE SMOKING PIPE CASES, TOBACCO POUCHES, CIGARETTE ROLLING PAPERS, CIGARETTE CASES AND CIGARETTE HOLDERS NOT MADE OF PRECIOUS METALS, CIGARETTE TRAYS, ASHTRAYS NOT MADE OF PRECIOUS METALS, SMOKING PIPES, SMOKING PIPE HOLDERS NOT MADE OF PRECIOUS METALS, LIGHTERS NOT MADE OF PRECIOUS METALS, LIGHTER FLINTS, SAFETY MATCHES, SULFUR MATCHES, YELLOW PHOSPHORUS MATCHES, AND PARAFFIN MATCHES (U.S. CLS. 2, 8, 9 AND 17).

SN 76-037,281. CELL NETWORK AB, 421 31 VASTRA FROLUNDA, SWEDEN, FILED 4-28-2000.



CELL
NETWORK

NO CLAIM IS MADE TO THE EXCLUSIVE RIGHT TO USE "NETWORK", APART FROM THE MARK AS SHOWN.

CLASS 9—ELECTRICAL AND SCIENTIFIC APPARATUS

FOR COMPUTERS, COMPUTER PERIPHERAL DEVICES, NAMELY MONITORS, KEYBOARDS, PRINTERS, SPEAKERS, DATA MODEMS, OPTICAL AND MAGNETIC DATA CARRIERS AND COMPUTER SOFTWARE FOR USE TO ENABLE CONNECTIONS TO THE WORLD WIDE WEB IN THE FIELD OF BUSINESS CONSULTATION SERVICES, BUSINESS DEVELOPMENT AND BUSINESS MANAGEMENT (U.S. CLS. 21, 23, 26, 36 AND 38).

CLASS 35—ADVERTISING AND BUSINESS

FOR BUSINESS CONSULTATION SERVICES IN THE FIELD OF BUSINESS DEVELOPMENT AND BUSINESS MANAGEMENT (U.S. CLS. 100, 101 AND 102).

CLASS 42—SCIENTIFIC, COMPUTER AND LEGAL SERVICES

FOR COMPUTER CONSULTING AND COMPUTER PROGRAMMING, STRATEGIC, TECHNICAL AND GRAPHICAL CONSULTING SERVICES IN THE FIELD OF COMPUTERS, INTERACTIVE MEDIA, INFRASTRUCTURE FOR DIGITAL-TV AND ELECTRONIC TRANSACTIONS THROUGH INTERACTIVE MEDIA (U.S. CLS. 100 AND 101).

SN 76-040,315. SOFREL, 35770 VERN SUR SEICHE, FRANCE, FILED 5-3-2000.

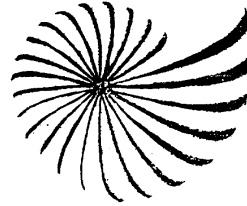

PRIORITY CLAIMED UNDER SEC. 44(D) ON FRANCE APPLICATION NO. 99822078, FILED 11-3-1999, REG. NO. 99822078, DATED 11-3-1999, EXPIRES 11-3-2009.

COLOR IS CLAIMED AS A FEATURE OF THE MARK. THE LINES REPRESENTING THE NAUTILUS DESIGN ARE REDDISH ORANGE AND THE INTERVALS ARE WHITE.

CLASS 6—METAL GOODS

FOR METAL URBAN MOVABLE FIXTURES, NAMELY, METAL SHELTERS FOR PROTECTING PERSONS WAITING FOR THE BUS, METAL INFORMATION PANELS, NAMELY, ROAD SIGN AND DIRECTION INDICATORS, METAL POSTING COLUMNS FOR SIGNPOSTING, METAL POSTS, METAL TRUNKS AND CASES FOR ROAD SIGNALING; NON-LUMINOUS AND NON-MECHANICAL METAL SIGNALING FOR ROAD SIGNALING; METAL CRASH BARRIERS FOR ROADS; NON-LUMINOUS AND NON-MECHANICAL METAL ROAD MARKERS; METAL LOCKS; SEMI-WORKED COMMON METALS FOR THE MANUFACTURE OF ALL OF THE AFORESAID GOODS (U.S. CLS. 2, 12, 13, 14, 23, 25 AND 50).

CLASS 7—MACHINERY

FOR MACHINE TOOLS FOR MANUFACTURING CIRCUIT BOARDS; MACHINE TOOLS FOR MANUFACTURING METAL BOXES AND TRUNKS (U.S. CLS. 13, 19, 21, 23, 31, 34 AND 35).

CLASS 9—ELECTRICAL AND SCIENTIFIC APPARATUS

FOR ELECTRIC AND ELECTRONIC INSTALLATIONS, APPARATUSES AND INSTRUMENTS FOR USE IN DIRECTING ROAD, HIGHWAY, URBAN AND INTERURBAN TRAFFIC, NAMELY, ELECTRONIC MECHANICAL CONTROLS, ELECTRONIC TRAFFIC DATA COLLECTION STATIONS, ELECTRONIC AUTOMATIC LANE CLOSURES, ELECTRONIC TRAFFIC CONTROLLERS AND JUNCTION CONTROLLERS; SIGNALING APPARATUSES AND INSTRUMENTS, NAMELY, LUMINOUS ROAD SIGNS, ELECTRIC ROAD SIGNS, TRAFFIC SIGNALS, ELECTRONIC VARIABLE MESSAGE SIGNS, ELECTRONIC TRAFFIC LANE CONTROL SIGNALS, ELECTRONIC TRANSPORT INFORMATION SIGNS, ELECTRONIC CAR PARKING GUIDANCE SIGNS, ELECTRONIC VEHICLE SPEED INFORMATION DISPLAYS, ELECTRONIC POLICE SIGNS, ELECTRONIC GRAPHIC TRAFFIC INFORMATION SIGNS, ELECTRONIC AUTOMATIC LANE CLOSURE WARNING SIGNS; MEASURING APPARATUSES AND INSTRUMENTS, NAMELY, TRAFFIC COUNTING STATION, WEIGHING STATIONS; APPARATUSES FOR REGISTERING AND SENDING IMAGES, NAMELY, LICENSE PLATE RECOGNITION UNITS, NAMELY, VIDEO-OPTICAL DETECTORS FOR DETECTING LICENSE PLATES; ELECTRIC AND ELECTRONIC APPARATUSES FOR SURVEILLANCE, REMOTE SURVEILLANCE AND REMOTE CONTROLLING OF INDUSTRIAL INSTALLATIONS IN THE FIELD OF WATER SUPPLIES, WATER TREATMENT, HEATING, VENTILATION, AIR CONDITIONING, BUILDING

AUTOMATION, STREET LIGHTING, ENERGY DISTRIBUTION SYSTEMS, POWER STATIONS AND TELECOMMUNICATIONS, NAMELY, TELEMETRY STATIONS, REMOTE TERMINAL UNITS COMPRISING OF DATA PROCESSORS, SUPERVISORY CONTROL AND DATA ACQUISITION STATIONS FOR THE REMOTE CONTROL OF INDUSTRIAL OPERATIONS, PROGRAMMABLE LOGIC CONTROLLERS; APPARATUSES FOR THE SAFETY OF ROAD TRAFFIC, NAMELY, ELECTRIC SIGNS, LUMINOUS SIGNS AND SAFETY MARKERS; ELECTRONIC DISTRIBUTION CABINETS FOR REGULATING TRAFFIC SIGNALING; APPARATUSES FOR PROCESSING INFORMATION, NAMELY, MODEMS, TRAFFIC DATA COLLECTION STATIONS, SUPERVISORY CONTROL AND DATA ACQUISITION STATIONS FOR THE REMOTE CONTROL OF INDUSTRIAL OPERATIONS; COMPUTERS; REGISTERED COMPUTER PROGRAMS, NAMELY SOFTWARE AND PROGRAM PACKAGES FOR THE SURVEILLANCE, REMOTE SURVEILLANCE AND REMOTE CONTROL OF TECHNICAL AND INDUSTRIAL OPERATIONS IN THE FIELDS OF WATER TREATMENT, HEATING, VENTILATION, AIR CONDITIONING, BUILDING AUTOMATION STREET LIGHTING ENERGY DISTRIBUTION SYSTEMS, POWER STATIONS AND TELECOMMUNICATIONS; TRAFFIC CONTROL SOFTWARE, SUPERVISORY CONTROL SOFTWARE FOR USE IN TRAFFIC DATA COLLECTION STATIONS; SEMI-CONDUCTOR; PRINTED CIRCUITS; SIGNALING AND TRAFFIC SIGNAL LAMPS; LUMINOUS OR MECHANICAL SIGNALING, NAMELY, LUMINOUS OR MECHANICAL ROAD MARKERS; ELECTRONIC NOTICE BOARDS; DETECTORS, NAMELY, SPEED DETECTORS; RADARS; PHOTOGRAPHIC AND VIDEO CAMERAS FOR USE IN LICENSE PLATE RECOGNITION UNITS; RADIO CONTROL APPARATUSES, NAMELY, REMOTE CONTROLS FOR REMOTE TERMINAL UNITS; TELEPHONE AUDIO AND VIDEO RECEIVERS; TELEPHONE AND RADIO TRANSMITTERS; TRANSCEIVERS; HIGHWAY SAFETY CONES; NON-METAL, NON-MECHANICAL AND NON-LUMINOUS ROAD MARKERS AND CONES; PROTECTION DEVICES, NAMELY, VOLTAGE SURGE PROTECTORS (U.S. CLS. 21, 23, 26, 36 AND 38).

CLASS 11—ENVIRONMENTAL CONTROL APPARATUS

FOR ROAD LIGHTING INSTALLATIONS AND APPARATUSES, NAMELY, LAMPS, LIGHT DIFFUSERS, AND SUSPENSION DEVICES; LIGHTING DEVICES, NAMELY, LIGHTING LAMPS, STREET LAMPS, LIGHT PROJECTORS; WATER PURIFIERS; APPARATUSES AND INSTALLATION SYSTEMS FOR COOLING WATER COMPRISED PRIMARILY OF DATA PROCESSORS AND MODULAR TELECOMMUNICATION TRANSMITTERS FOR REMOTELY MONITORING AND MEASURING WATER SYSTEM PERFORMANCE AND OPERATION; LAMP REFLECTORS AND REFLECTORS FOR VEHICLES; MEASURING AND INSPECTING UNITS FOR USE IN THE COLLECTION AND REGULATION OF DATA USED IN THE OPERATION OF ENVIRONMENTAL CONTROL INSTALLATIONS FOR WATER SUPPLIES, WATER TREATMENT, WATER SANITATION AND AQUACULTURE (U.S. CLS. 13, 21, 23, 31 AND 34).

CLASS 12—VEHICLES

FOR DYNAMIC ROAD SIGN TRAILERS (U.S. CLS. 19, 21, 23, 31, 35 AND 44).
FIRST USE 11-3-1999; IN COMMERCE 11-3-1999.

CLASS 19—NON-METALLIC BUILDING MATERIALS

FOR NON-METAL, NON-LUMINOUS AND NON-MECHANICAL SIGNS; CRASH BARRIERS OF PLASTIC OR CONCRETE FOR ROADS; NON-METAL POSTS; GLASS GRANULES FOR ROAD MARKING (U.S. CLS. 1, 12, 33 AND 50).

CLASS 37—CONSTRUCTION AND REPAIR

FOR REPAIR, MAINTENANCE AND INSTALLATION OF APPARATUSES FOR SIGNALING, SURVEILLANCE, SAFETY AND CONTROLLING ROAD, HIGHWAY, URBAN AND INTERURBAN, PUBLIC AND PRIVATE TRAFFIC, AND APPARATUSES FOR RECEIVING AND HANDLING REMOTE INFORMATION; RENTAL OF URBAN MOVABLE FIXTURES, NAMELY, OUTDOOR BENCHES FOR PUBLIC AREAS, SHELTERS FOR PROTECTING PERSONS WAITING FOR THE BUS, INFORMATION PANELS, AND MATERIALS FOR SIGNALING AND ROAD SAFETY; RENTAL OF ELECTRIC INSTALLATIONS FOR REMOTE CONTROLLING OF INDUSTRIAL INSTALLATIONS (U.S. CLS. 100, 103 AND 106).

CLASS 42—SCIENTIFIC, COMPUTER AND LEGAL SERVICES

FOR ENGINEERING SERVICES; DESIGNING AND DEVELOPMENT OF NEW TECHNOLOGY APPARATUSES, INSTRUMENTS, AND AUTOMATED SYSTEMS FOR OTHERS IN THE FIELD OF SIGNALING, DIRECTING AND SAFETY OF ROAD, HIGHWAY, URBAN, INTERURBAN, PUBLIC AND PRIVATE TRAFFIC; IN THE FIELD OF CONTROL AND SURVEILLANCE OF INDUSTRIAL INSTALLATIONS; AND IN THE FIELD OF RECEIVING AND PROCESSING INFORMATION FROM A DISTANCE; DESIGNING AND DEVELOPING COMPUTER PROGRAM PACKAGES AND COMPUTER SOFTWARE FOR OTHERS; RENTAL OF COMPUTERS AND COMPUTER SOFTWARE, LEASING OF COMPUTERS OR COMPUTER FACILITIES (U.S. CLS. 100 AND 101).

SN 76-041,073. NEWLINK GENETICS CORPORATION, AMES, IA. FILED 5-4-2000.

NEWLINK GENETICS

NO CLAIM IS MADE TO THE EXCLUSIVE RIGHT TO USE GENETICS, APART FROM THE MARK AS SHOWN.

CLASS 5—PHARMACEUTICALS

FOR PHARMACEUTICAL PREPARATIONS, NAMELY, PROPRIETARY GENOMIC AND THERAPEUTIC PREPARATIONS FOR THE PREVENTION FOR THE PREVENTION AND TREATMENT OF HUMAN DISEASES, NAMELY, CANCER, NEUROGENERATIVE DISORDERS, SUCH AS PARKINSON'S DISEASE AND ALZHEIMER'S DISEASE AND AUTOIMMUNE DISORDERS, SUCH AS RHEUMATOID ARTHRITIS, DIABETES AND MULTIPLE SCLEROSIS (U.S. CLS. 6, 18, 44, 46, 51 AND 52).

CLASS 9—ELECTRICAL AND SCIENTIFIC APPARATUS

FOR COMPUTER PROGRAMS AND DATABASES USED IN THE DEVELOPMENT OF PROPRIETARY GENOMIC AND THERAPEUTIC PRODUCTS FOR THE PREVENTION AND TREATMENT OF DISEASES IN THE HUMAN BODY (U.S. CLS. 21, 23, 26, 36 AND 38).

CLASS 16—PAPER GOODS AND PRINTED MATTER

FOR PHOTOGRAPHS AND PRINTED INSTRUCTIONAL AND TEACHING MATERIAL CONTAINING INFORMATION ABOUT THE USE OF PROPRIETARY GENOMIC AND THERAPEUTIC PRODUCTS USED FOR PREVENTION AND TREATMENT OF DISEASES IN THE HUMAN BODY (U.S. CLS. 2, 5, 22, 23, 29, 37, 38 AND 50).

CLASS 42—SCIENTIFIC, COMPUTER AND LEGAL SERVICES

FOR MEDICAL AND SCIENTIFIC RESEARCH RELATING TO THE DEVELOPMENT AND SALE OF GENOMIC AND THERAPEUTIC PRODUCTS FOR PREVENTION AND TREATMENT OF DISEASES IN THE HUMAN BODY (U.S. CLS. 100 AND 101).

SN 76-043,219. STANLEY LOGISTICS, INC., NEW BRITAIN, CT. FILED 5-9-2000.

CLASS 7—MACHINERY

FOR POWER SPRAYERS (U.S. CLS. 13, 19, 21, 23, 31, 34 AND 35).

CLASS 8—HAND TOOLS

FOR HAND-PUMPED SPRAYERS FOR LAWN AND GARDEN CARE FOR APPLYING FERTILIZER, WEED KILLER, AND PESTICIDE; HAND-PUMPED SPRAYERS FOR CONSTRUCTION APPLICATIONS (U.S. CLS. 23, 28 AND 44).

SN 76-043,265. TAHARI, ELIE, NEW YORK, NY. FILED 5-8-2000.

ELIE TAHARI

OWNER OF U.S. REG. NOS. 1,489,405, 1,979,893 AND OTHERS.

THE NAME "ELIE TAHARI" IDENTIFIES A LIVING INDIVIDUAL WHOSE CONSENT IS OF RECORD.

CLASS 3—COSMETICS AND CLEANING PREPARATIONS

FOR PERFUMES, EAU DE COLOGNE, EAU DE TOILETTE; COSMETICS, NAMELY, MOISTURIZING SKIN CREAM, CLEANSING CREAM, LOOSE FACE POWDER, PRESSED FACE POWDER, FOUNDATION MAKE-UP, LIPSTICKS, EYE SHADOW, BLUSHER, MASCARA, EYELINER, EYE PENCILS, LIP PENCILS, NAIL ENAMEL, HAIR SHAMPOOS, HAIR CONDITIONER AND HAIR RINSES (U.S. CLS. 1, 4, 6, 50, 51 AND 52).

CLASS 14—JEWELRY

FOR JEWELRY, CLOCKS AND WATCHES (U.S. CLS. 2, 27, 28 AND 50).

CLASS 18—LEATHER GOODS

FOR LEATHER GOODS NAMELY, HANDBAGS, KEY CASES, WALLETS, TOTE BAGS, COSMETIC BAGS SOLD EMPTY, BACKPACKS, FANNY PACKS, DIARY AND ADDRESS BOOK COVERS, AND LUGGAGE; AND UMBRELLAS (U.S. CLS. 1, 2, 3, 22 AND 41).

CLASS 25—CLOTHING

FOR BELTS (U.S. CLS. 22 AND 39).

CLASS 35—ADVERTISING AND BUSINESS

FOR RETAIL STORE SERVICES IN THE FIELDS OF APPAREL, FOOTWEAR, COSMETICS, LOTIONS AND PERFUMES, BAGS AND LUGGAGE AND WATCHES AND JEWELRY (U.S. CLS. 100, 101 AND 102).

SN 76-043,859. BOOST GLOBAL PTY LTD, SYDNEY, NEW SOUTH WALES, AUSTRALIA, BY ASSIGNMENT MARKETING GROUP WORLDWIDE PTY LTD, THE, CROWS NEST, NSW, 2065, AUSTRALIA, FILED 5-8-2000.

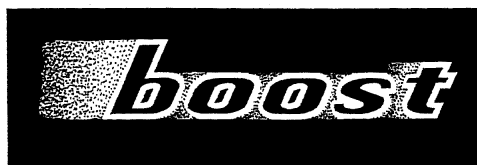

PRIORITY CLAIMED UNDER SEC. 44(D) ON AUSTRALIA APPLICATION NO. 813046, FILED 11-8-1999, REG. NO. 813046, DATED 11-8-1999, EXPIRES 11-8-2009.

THE STIPPLING IS FOR SHADING PURPOSES.

CLASS 9—ELECTRICAL AND SCIENTIFIC APPARATUS

FOR SMART CARDS, NAMELY PREPAID SMART CARDS FOR MOBILE TELEPHONES AND FIXED LINE TELEPHONES AND INTERNET ACCESS, CALLING CARDS (U.S. CLS. 21, 23, 26, 36 AND 38).

CLASS 36—INSURANCE AND FINANCIAL

FOR TELECOMMUNICATION SERVICES, NAMELY, CALLING CARD SERVICES FOR USE WITH MOBILE TELEPHONES AND INTERNET ACCESS (U.S. CLS. 100, 101 AND 102).

SN 76-044,182. SUPER LOVERS CO., LTD., TOKYO 108-0071, JAPAN, FILED 5-9-2000.

SUPER LOVERS

CLASS 18—LEATHER GOODS

FOR ATTACHE CASES; BEACH BAGS; BACK PACKS; OVERNIGHT BAGS; LEATHER SHOPPING BAGS; IMITATIONS OF LEATHER SHOPPING BAGS; TEXTILE SHOPPING BAGS; MESH SHOPPING BAGS; BRIEF-CASES; CHAIN MESH PURSES; CREDIT CARD CASES; BUSINESS CARD CASES; CALLING CARD CASES; COMMUTATION TICKET CASES; GARMENT BAGS FOR TRAVEL; HANDBAGS; KEY CASES; PARASOLS; DRAWSTRING POUCHES; FELT POUCHES; LEATHER POUCHES; PURSES; RUCKSACKS; SACHELS; BABY CARRIERS WORN ON THE BODY; SUITCASES; TRAVELING BAGS; LUGGAGE; LUGGAGE TRUNKS; UMBRELLAS; VALISES; VANITY CASES SOLD EMPTY; WALLETS (U.S. CLS. 1, 2, 3, 22 AND 41).

CLASS 25—CLOTHING

FOR APRONS; BANDANAS; BATH ROBES; BATHING CAPS; BATHING TRUNKS; BEACH COVERUPS; BELTS; BOAS; BODICES; BOXER SHORTS; BRASSIERES; BREECHES; BRIEFS; CAMISOLES; CLOTHING OF IMITATIONS OF LEATHER, NAMELY, JACKETS, SKIRTS, PANTS, SHOES, CAPS, JUMPERS AND COATS; CLOTHING OF LEATHER, NAMELY, JACKETS, SKIRTS, PANTS, SHOES, CAPS, JUMPERS AND COATS; COATS; TOP COATS; COLLARS; COMBINATIONS; CORSETS; DETACHABLE COLLARS; DRESS SHIELDS; GOWNS; EAR MUFFS; FROCKS; FUR STOLE; GABERDINES; GARTERS; GIRDLES; GLOVES; STUFF JACKETS; JACKETS; JERSEYS; JUMPERS; KNITWEAR, NAMELY, SHIRTS, PANTS, VESTS, JACKETS, SWEATERS, SUITS, HEAD WEAR, JUMPERS AND COATS; MASQUERADE COSTUMES; MITTENS; MUFFS; MUFFLERS; NECKTIES; OUTER CLOTHING, NAMELY, COATS, JACKETS, OVERCOATS AND JUMPERS; OVERALLS; OVERCOATS; PAJAMAS; PANTS; PARKAS; PELERINES; PELISSES; PETTICOATS; PULLOVERS; SARIS; SASHES; SCARVES; SHAWLS; SHIRTS; SHOULDER WRAPS; SINGLET; SKIRTS; SLIPS; SMOCKS; SOCK SUSPENDERS; SOCKS; SPATS; STOCKING SUSPENDERS; SUITS; SUSPENDERS; SWEAT-ABSORBENT UNDERCLOTHING; SWEATERS; SWIMSUITS; SWIM TRUNKS; SWIM WEAR; TEDDIES; T-SHIRTS; TIGHTS; UNDERCLOTHING; UNDERPANTS; UNDERWEAR; VEILS; VESTS; FOOTWEAR; HEAD WEAR; WRISTBANDS (U.S. CLS. 22 AND 39).

CLASS 28—TOYS AND SPORTING GOODS

FOR GAMES, NAMELY, BOARD GAMES, CARD GAMES AND PARLOUR GAMES; TOYS AND PLAYTHINGS, NAMELY, AIR PISTOLS AND RIFLES, BALLS FOR THE PLAYGROUND, SPORTS BALLS, BUILDING BLOCKS, DARTS, DOLLS, DOLLS' CLOTHES, DOLLS' HOUSES AND DOLLS' ACCESSORIES, MARBLES, MODELING CLAY, TOY MOBILES, PLAY BALLOONS, PUPPETS, KITES, BUBBLE MAKING WAND AND SOLUTION SETS, SPINNING TOPS, BABY RATTLES AND INFANT RATTLES, YO-YOS, FACE MASKS AND COSTUME MASKS, ACTION FIGURES, SOFT SCULPTURE TOYS, CUDDLE SCULPTURE TOYS, TEDDY BEARS, FANTASY CHARACTER TOYS, CONSTRUCTION TOYS, JIGSAW PUZZLES, REMOTE-CONTROLLED TOY VEHICLES, MODEL TOY VEHICLES, TOY SCOOTERS, TOY BICYCLES, TOY MODEL TRAIN SETS, PLAY TENTS, EXERCISE TRAMPOLINES AND TOY TRAMPOLINES, TOY STICKS, TENNIS, SQUASH AND BADMINTON RACKETS, BASEBALL AND CRICKET BATS; BADMINTON SHUTTLECOCKS, MAH-JONG GAMES; PLAY SWIMMING POOLS; ICE SKATES; ROLLER SKATES AND IN-LINE SKATES; SKATEBOARDS; SKIS; SKITTLES (U.S. CLS. 22, 23, 38 AND 50).

SN 76-044,344. CADARA, N.V., 1651 LOT-BEERSEL, BELGIUM, FILED 5-9-2000.

SN 76-044,285. WANDERING STAR LIMITED, DEVON, TQ6 0HD, UNITED KINGDOM, FILED 5-9-2000.

ADOX System



THE STIPLING IS A FEATURE OF THE MARK. "BRECKINRIDGE ELKINS" IS NOT THE NAME OF A PARTICULAR LIVING INDIVIDUAL.

CLASS 16—PAPER GOODS AND PRINTED MATTER

FOR STATIONERY; A SERIES OF BOOKS, MANUALS AND MAGAZINES FEATURING THE FICTIONAL CHARACTER BRECKINRIDGE ELKINS; PERIODICALS, NAMELY MAGAZINES FEATURING THE FICTIONAL CHARACTER BRECKINRIDGE ELKINS, ISSUED MONTHLY OR WEEKLY; POSTERS; COMIC BOOKS; GIFT WRAPPING PAPER; DIARIES; NOTEBOOKS; MOUNTED AND UNMOUNTED PHOTOGRAPHS; GREETING CARDS; WRITING PAPER; PRINTED PAPER; COPY PAPER (U.S. CLS. 2, 5, 22, 23, 29, 37, 38 AND 50).

PRIORITY CLAIMED UNDER SEC. 44(D) ON BELGIUM APPLICATION NO. 1386671, FILED 11-10-1999. OWNER OF U.S. REG. NO. 2,401,484. NO CLAIM IS MADE TO THE EXCLUSIVE RIGHT TO USE "SYSTEM", APART FROM THE MARK AS SHOWN.

CLASS 7—MACHINERY

FOR MACHINES FOR PUNCHING HOLES IN PAPER, CARDBOARD AND PLASTIC (U.S. CLS. 13, 19, 21, 23, 31, 34 AND 35).

CLASS 16—PAPER GOODS AND PRINTED MATTER

FOR PAPER GOODS, NAMELY, FILE FOLDERS, FILE JACKETS, FILE CARDS, RECORD CARDS, DIVIDERS FOR LOOSELEAF BOOKS AND FILE FOLDERS, BINDERS, NOTEPADS; PAPER GOODS COATED IN PLASTIC, NAMELY, FILING FOLDERS, FILE JACKETS, FILE CARDS, RECORD CARDS, DIVIDERS FOR LOOSELEAF BOOKS AND FILE FOLDERS, AND BINDERS WITH POCKETS FOR BUSINESS CARDS; FILING ITEMS AND BINDERS IN PLASTIC MATERIALS, NAMELY, FILING FOLDERS, FILE JACKETS, FILE CARDS, RECORD CARDS, DIVIDERS FOR LOOSELEAF BOOKS AND FILE FOLDERS, AND BINDERS WITH POCKETS FOR BUSINESS CARDS; NOTEBOOKS WITH ALPHABETICAL INDEXES, BINDERS WITH ALPHABETICAL INDEXES, ADDRESS AND TELEPHONE NUMBER BOOKS, PHOTOGRAPH ALBUMS; OFFICE PERFORATION MACHINES; AND STATIONERY (U.S. CLS. 2, 5, 22, 23, 29, 37, 38 AND 50).

SN 76-044,711. PROJECT PERFORMANCE CORPORATION, MCLEAN, VA. FILED 5-9-2000.

JURISPORTAL

CLASS 35—ADVERTISING AND BUSINESS

FOR PROVIDING ONLINE DIRECTORY INFORMATION IN THE FIELD OF LEGAL RESOURCES FEATURING HYPERLINKS TO OTHER WEBSITES (U.S. CLS. 100, 101 AND 102).
FIRST USE 11-1-1999; IN COMMERCE 1-24-2000.

CLASS 42—SCIENTIFIC, COMPUTER AND LEGAL SERVICES

FOR PROVIDING INFORMATION IN THE LEGAL FIELD, NAMELY LEGAL RESOURCES, LEGAL NEWS AND LEGISLATION VIA A GLOBAL COMPUTER NETWORK (U.S. CLS. 100 AND 101).
FIRST USE 11-1-1999; IN COMMERCE 1-24-2000.

SN 76-045,417. OPSION MEDICAL, INC., SAN DIEGO, CA. BY CHANGE OF NAME CLINICAL INTERACTIONS, INC., LA JOLLA, CA. FILED 5-11-2000.

CHARTBUILDER

CLASS 38—COMMUNICATION

FOR ELECTRONIC TRANSMISSION OF MESSAGES AND DATA BETWEEN PHYSICIANS AND PATIENTS (U.S. CLS. 100, 101 AND 104).

CLASS 42—SCIENTIFIC, COMPUTER AND LEGAL SERVICES

FOR COMPUTER SERVICES, NAMELY PROVIDING AN INTERACTIVE COMPUTER DATABASE THAT ALLOWS REMOTE INTERVIEWING OF PATIENTS, SELECTING AND PROVIDING MEDICAL INFORMATION TO PATIENT AND PHYSICIANS OVER AN ON-LINE ELECTRONIC COMMUNICATIONS NETWORK, CREATING MEDICAL SUMMARIES INCLUDING CREATING CHART NOTES FOR PHYSICIANS, AND STORING MEDICAL RECORDS (U.S. CLS. 100 AND 101).

SN 76-045,448. ADAYTUM SOFTWARE, INC., MINNEAPOLIS, MN. FILED 5-10-2000.

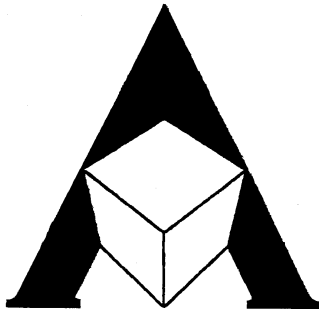

THE MARK CONSISTS OF A STYLIZED REPRESENTATION OF THE LETTER "A" WITH A DESIGN ELEMENT IN THE FORM OF A CUBE.

CLASS 9—ELECTRICAL AND SCIENTIFIC APPARATUS

FOR COMPUTER SOFTWARE FOR USE IN CONNECTION WITH FINANCIAL PLANNING, BUDGETING, FINANCIAL FORECASTING AND FINANCIAL REPORTING (U.S. CLS. 21, 23, 26, 36 AND 38).
FIRST USE 12-0-1995; IN COMMERCE 10-0-1996.

CLASS 41—EDUCATION AND ENTERTAINMENT

FOR PROVIDING TRAINING SERVICES, NAMELY, PROVIDING CLASSROOM AND ONE-ON-ONE TRAINING IN THE FIELD OF COMPUTER SOFTWARE FOR USE IN CONNECTION WITH FINANCIAL PLANNING, BUDGETING, FINANCIAL FORECASTING AND FINANCIAL REPORTING (U.S. CLS. 100, 101 AND 107).
FIRST USE 12-0-1996; IN COMMERCE 12-0-1996.

CLASS 42—SCIENTIFIC, COMPUTER AND LEGAL SERVICES

FOR PROVIDING NON-DOWNLOADABLE COMPUTER SOFTWARE FOR USE IN CONNECTION WITH FINANCIAL PLANNING, BUDGETING, FINANCIAL FORECASTING AND FINANCIAL REPORTING, VIA A GLOBAL COMPUTER NETWORK; COMPUTER CONSULTATION IN THE FIELD OF COMPUTER SOFTWARE; TECHNICAL SUPPORT SERVICES, NAMELY, ASSISTANCE WITH IMPLEMENTATION OF COMPUTER SOFTWARE AND TROUBLESHOOTING OF COMPUTER SOFTWARE PROBLEMS VIA TELEPHONE, E-MAIL, AND FACSIMILE (U.S. CLS. 100 AND 101).
FIRST USE 11-0-1996; IN COMMERCE 11-0-1996.

SN 76-046,712. G.L. HOMES LICENSING CORPORATION, CORAL SPRINGS, FL. FILED 5-11-2000.

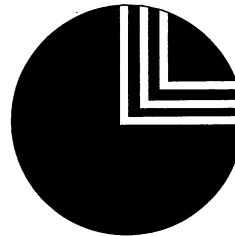

CLASS 36—INSURANCE AND FINANCIAL

FOR REAL ESTATE CONSULTING SERVICES, NAMELY, REAL ESTATE MANAGEMENT, REAL ESTATE AGENCY; REAL ESTATE BROKERAGE; AND REAL ESTATE LISTING SERVICES (U.S. CLS. 100, 101 AND 102).
FIRST USE 1-1-2000; IN COMMERCE 1-1-2000.

CLASS 37—CONSTRUCTION AND REPAIR

FOR RESIDENTIAL BUILDING CONSTRUCTION; HOUSE BUILDING AND REPAIR; AND REAL ESTATE DEVELOPMENT AND PLANNING SERVICES, NAMELY, DEVELOPING, LAYING OUT, AND CONSTRUCTING RESIDENTIAL COMMUNITIES AND INDIVIDUAL RESIDENCES, AND CONSTRUCTION MANAGEMENT (U.S. CLS. 100, 103 AND 106).
FIRST USE 1-1-2000; IN COMMERCE 1-1-2000.

CLASS 42—SCIENTIFIC, COMPUTER AND LEGAL SERVICES

FOR COMPUTER SERVICES, NAMELY, PROVIDING SEARCH ENGINES FOR OBTAINING REAL ESTATE DATA ON A GLOBAL COMPUTER NETWORK, PROVIDING DATABASES FEATURING GENERAL AND LOCAL NEWS, AND INFORMATION OF INTEREST TO THOSE LIVING IN, OR RELOCATING TO, SPECIFIC GEOGRAPHIC AREAS, AND PROVIDING ON-LINE INFORMATION AND DATABASES IN THE FIELD OF REAL ESTATE AND RELOCATION (U.S. CLS. 100 AND 101).

FIRST USE 1-1-2000; IN COMMERCE 1-1-2000.

SN 76-048,227. GREEN CANYON CORPORATION, WILMINGTON, DE. BY ASSIGNMENT CDI CORPORATION, PHILADELPHIA, PA. FILED 5-15-2000.

KNOWLEDGE @ WORK: ENGINEERING SOLUTIONS THAT CLICK

SN 76-047,405. MANAGEMENT DESIGN, SAN RAFAEL, CA. FILED 5-12-2000.

MANAGEMENT DESIGN

NO CLAIM IS MADE TO THE EXCLUSIVE RIGHT TO USE "MANAGEMENT", APART FROM THE MARK AS SHOWN.

SEC. 2(F).

NO CLAIM IS MADE TO THE EXCLUSIVE RIGHT TO USE "ENGINEERING SOLUTIONS", APART FROM THE MARK AS SHOWN.

CLASS 35—ADVERTISING AND BUSINESS

FOR BUSINESS MANAGEMENT CONSULTING AND PLANNING SERVICES (U.S. CLS. 100, 101 AND 102). FIRST USE 5-11-1970; IN COMMERCE 9-0-1974.

CLASS 9—ELECTRICAL AND SCIENTIFIC APPARATUS

FOR COMPUTER SOFTWARE FOR DATABASE MANAGEMENT FOR USE IN MANAGING, TRACKING, RETRIEVING, DELIVERING AND SHARING OF PROCUREMENT, BUYING, SELLING, TENDERING, JOB AND PROJECT BIDDING INFORMATION AND OPPORTUNITIES (U.S. CLS. 21, 23, 26, 36 AND 38).

CLASS 36—INSURANCE AND FINANCIAL

FOR FINANCIAL ANALYSIS AND CONSULTING SERVICES (U.S. CLS. 100, 101 AND 102). FIRST USE 5-11-1970; IN COMMERCE 9-0-1974.

CLASS 16—PAPER GOODS AND PRINTED MATTER

FOR PRINTED AND ELECTRONIC PUBLICATIONS; NAMELY, MANUALS, PAMPHLETS, BOOKS, PERIODICALS, MAGAZINES, NEWSLETTERS PERTAINING TO PROCUREMENT, BUYING, SELLING, TENDERING, JOB AND PROJECT BIDDING INFORMATION AND OPPORTUNITIES (U.S. CLS. 2, 5, 22, 23, 29, 37, 38 AND 50).

SN 76-047,425. KIM SENG COMPANY, LOS ANGELES, CA. FILED 5-12-2000.



SEC. 2(F) AS TO THE WORDING SUPER BRAND.

CLASS 35—ADVERTISING AND BUSINESS

FOR DATA PROCESSING SERVICES; EMPLOYMENT AGENCY SERVICES; LONG TERM AND SHORT TERM PLACEMENT OF CONSULTANTS, MANAGEMENT, MARKETING, PROFESSIONAL, LEGAL, ACCOUNTING, FINANCIAL, ADMINISTRATIVE, SALES, OFFICE AND CLERICAL PERSONNEL, TECHNICAL, ELECTRONIC DATA PROCESSING SUPPORT, PROGRAMMERS AND OTHER COMPUTER PERSONNEL, ENGINEERING AND INDUSTRIAL PERSONNEL AND THE MANAGEMENT OF SUCH PLACEMENTS FOR OTHERS, CONSULTING, BUSINESS BROKERAGE AND EMPLOYMENT AGENCY SERVICES PERTAINING TO PROCUREMENT, BUYING, SELLING, TENDERING, JOB AND PROJECT BIDDING INFORMATION AND OPPORTUNITIES, CONSULTING SERVICES; NAMELY, PROVIDING ONLINE INFORMATION PERTAINING TO PROCUREMENT, BUYING, SELLING, TENDERING, JOB AND PROJECT BIDDING INFORMATION AND OPPORTUNITIES TRANSMITTED TO THE INTERNET, ONE OR MORE WORLD WIDE WEB SITES, OR THROUGH ONE OR MORE INTRANET SITES WITHIN AN ELECTRONIC COMMUNICATIONS NETWORK; COMPUTERIZED DATABASE MANAGEMENT SERVICES FOR OTHERS IN PERSON AND VIA ONE OR MORE ON-LINE ELECTRONIC COMMUNICATIONS NETWORKS AND THE INTERNET, ALL PERTAINING TO PROCUREMENT, BUYING, SELLING, TENDERING, JOB AND PROJECT BIDDING INFORMATION AND OPPORTUNITIES; AND DATA COMPILATION AND ANALYSIS SERVICES, NAMELY, THE COMPILATION, ANALYSIS AND MODELING OF CUSTOMER SPECIFIED DATA (U.S. CLS. 100, 101 AND 102).

CLASS 29—MEATS AND PROCESSED FOODS

FOR STAPLE FOODS, NAMELY, DRIED VEGETABLES AND DRIED MUSHROOMS (U.S. CL. 46). FIRST USE 6-0-1999; IN COMMERCE 6-0-1999.

CLASS 37—CONSTRUCTION AND REPAIR

FOR SHORT TERM COMPUTER HARDWARE MAINTENANCE (U.S. CLS. 100, 103 AND 106).

CLASS 30—STAPLE FOODS

FOR STAPLE FOODS, NAMELY SAUCES, INCLUDING FISH SAUCE (U.S. CL. 46). FIRST USE 6-0-1999; IN COMMERCE 6-0-1999.

CLASS 42—SCIENTIFIC, COMPUTER AND LEGAL SERVICES

FOR SHORT TERM COMPUTER SOFTWARE MAINTENANCE; COMPUTER CONSULTING SERVICES IN THE FIELDS OF DATA PROCESSING, SOFTWARE ENGINEERING, SOFTWARE DESIGN, HARDWARE ENGINEERING, HARDWARE DESIGN, AND COMPUTER PROGRAMMING; COMPUTER SOFTWARE DESIGN FOR OTHER; ENGINEERING, DRAFTING AND DESIGN SERVICES FOR OTHERS IN THE FIELDS OF ELECTRONICS, CHEMICALS, AUTOMOBILES, PETROLEUM, PHARMACEUTICALS, AIRCRAFT, NAVAL ENGINEERING AND DESIGN, AND POWER PLANTS, COMPUTER CONSULTING SERVICES, NAMELY COMPUTER PROGRAMMING, SOFTWARE DEVELOPMENT AND SYSTEMS DESIGN SERVICES TO THE SPECIFICATIONS OF OTHERS PERTAINING TO PROCUREMENT, BUYING, SELLING, TENDERING, JOB AND PROJECT BIDDING INFORMATION AND OPPORTUNITIES (U.S. CLS. 100 AND 101).

SN 76-048,936. ZEPA TARIMSAL, HAYVANSAL VE SINAI URUNLER URETIM VE PAZARLAMA ANONIM SIRKETI, KARSIYAKA, IZMIR, TURKEY, FILED S.R. 5-16-2000; AM. P.R. 3-1-2002.

FORA**CLASS 29—MEATS AND PROCESSED FOODS**

FOR MEATS, FISH, POULTRY AND GAME; MEAT EXTRACTS; PRESERVED, DRIED AND COOKED FRUITS AND VEGETABLES; JELLIES, JAMS AND FRUIT SAUCES; EGGS, MILK PRODUCTS, NAMELY, WHOLE MILK, CHOCOLATE MILK, ACIDOPHILUS MILK, MILK BASED BEVERAGES CONTAINING COFFEE; EDIBLE OILS AND FATS (U.S. CL. 46).

CLASS 30—STAPLE FOODS

FOR COFFEE, TEA, COCOA, SUGAR, RICE, TAPIOCA, SAGO, GRAIN BASED COFFEE SUBSTITUTES, CHICORY BASED COFFEE SUBSTITUTES; FLOUR, CEREAL PREPARATIONS, NAMELY, BREAKFAST CEREAL, READY TO EAT CEREAL DERIVED FOOD BARS, CEREAL BASED SNACK FOODS; BREAD, PASTRIES; FLAVORED ICES; HONEY; TREACLE; YEAST; BAKING POWDER; SALT; MUSTARD; VINEGAR; SAUCES; SPICES AND ICE (U.S. CL. 46).

CLASS 32—LIGHT BEVERAGES

FOR BEER; MINERAL WATER; AERATED WATER; FRUIT DRINKS; FRUIT JUICES; SYRUPS FOR MAKING SOFT DRINKS (U.S. CLS. 45, 46 AND 48).

SN 76-050,779. INDIANAPOLIS MOTOR SPEEDWAY CORPORATION, INDIANAPOLIS, IN. FILED 5-17-2000.

ROAD TO INDY

OWNER OF U.S. REG. NOS. 1,192,522, 1,771,972 AND OTHERS.

CLASS 25—CLOTHING

FOR CLOTHING, NAMELY, BASEBALL CAPS (U.S. CLS. 22 AND 39).
FIRST USE 1-31-1999; IN COMMERCE 1-31-1999.

CLASS 41—EDUCATION AND ENTERTAINMENT

FOR TELEVISION DOCUMENTARY PROGRAM SERIES FEATURING AUTOMOTIVE RACING EVENTS (U.S. CLS. 100, 101 AND 107).

FIRST USE 5-24-1988; IN COMMERCE 5-24-1988.

SN 76-050,801. SENTRE PARTNERS, INC., SAN DIEGO, CA. FILED 5-17-2000.

BANDWIDTH NOW

NO CLAIM IS MADE TO THE EXCLUSIVE RIGHT TO USE "BANDWIDTH", APART FROM THE MARK AS SHOWN.

CLASS 38—COMMUNICATION

FOR PROVIDING INFORMATION IN THE FIELDS OF TELECOMMUNICATIONS AND HIGH SPEED TRANSMISSION OF INFORMATION, NAMELY, PROVIDING INFORMATION REGARDING THE USE OF TECHNOLOGY TO IMPROVE THE TELECOMMUNICATIONS ABILITY, CAPACITY, QUALITY AND CAPABILITIES OF BUILDINGS, FACILITIES AND STRUCTURES, AND PROVIDING INFORMATION TO IMPROVE TELECOMMUNICATIONS AND INFORMATION TRANSMISSION SERVICES OFFERED BY BUILDINGS, FACILITIES AND STRUCTURES, TO THEREBY INCREASE THE UTILITY AND REAL ESTATE VALUE OF SAID BUILDINGS, FACILITIES AND STRUCTURES, BY MEANS OF A GLOBAL COMPUTER INFORMATION NETWORK (U.S. CLS. 100, 101 AND 104).

CLASS 42—SCIENTIFIC, COMPUTER AND LEGAL SERVICES

FOR PROVIDING INFORMATION IN THE FIELD OF COMPUTER NETWORKING BY MEANS OF A GLOBAL COMPUTER NETWORK (U.S. CLS. 100 AND 101).

SN 76-051,654. PROVIDENCE ENERGY CORPORATION, PROVIDENCE, RI. FILED 5-18-2000.

PROVENERGY OIL

NO CLAIM IS MADE TO THE EXCLUSIVE RIGHT TO USE "OIL", APART FROM THE MARK AS SHOWN.

CLASS 4—LUBRICANTS AND FUELS

FOR FUEL (U.S. CLS. 1, 6 AND 15).

CLASS 37—CONSTRUCTION AND REPAIR

FOR INSTALLATION, REPAIR, SUPPORT, REGULATION AND MAINTENANCE SERVICES (U.S. CLS. 100, 103 AND 106).

CLASS 39—TRANSPORTATION AND STORAGE

FOR FUEL OIL STORAGE AND FUEL OIL DELIVERY (U.S. CLS. 100 AND 105).

CLASS 42—SCIENTIFIC, COMPUTER AND LEGAL SERVICES

FOR OIL BURNER INSPECTIONS (U.S. CLS. 100 AND 101).

SN 76-053,023. ENCHIRA BIOTECHNOLOGY CORPORATION, THE WOODLANDS, TX. BY CHANGE OF NAME ENERGY BIOSYSTEMS CORPORATION, THE WOODLANDS, TX. FILED 5-22-2000.

ENCHIRA**CLASS 1—CHEMICALS**

FOR CHEMICALS FOR USE IN THE MANUFACTURE OF HERBICIDES, PESTICIDES, NUTRITIONAL SUPPLEMENTS AND PHARMACEUTICALS (U.S. CLS. 1, 5, 6, 10, 26 AND 46).

CLASS 9—ELECTRICAL AND SCIENTIFIC APPARATUS

FOR COMPUTER SOFTWARE FOR GRAPHICAL SIMULATION IN THE FIELDS OF BIOTECHNOLOGY AND GENETICS (U.S. CLS. 21, 23, 26, 36 AND 38).

CLASS 42—SCIENTIFIC, COMPUTER AND LEGAL SERVICES

FOR CHEMICAL AND GENETIC RESEARCH AND ENGINEERING (U.S. CLS. 100 AND 101).

SN 76-052,459. FINETRICS, INC., LISLE, IL. FILED 5-19-2000.

FINETRICS**CLASS 35—ADVERTISING AND BUSINESS**

FOR BUSINESS MANAGEMENT, PLANNING AND CONSULTATION; PREPARING BUSINESS REPORTS; BUSINESS ACQUISITION AND MERGER CONSULTATION; TAX PREPARATION AND CONSULTATION; PAYROLL PREPARATION; BILLING; ACCOUNTING; ACCOUNT AUDITING; PERSONNEL PLACEMENT AND RECRUITMENT; LEASING AND RENTAL OF OFFICE BUILDING MACHINERY AND OFFICE BUILDING EQUIPMENT; PROCUREMENT, NAMELY, PURCHASING OFFICE BUILDING MACHINERY AND OFFICE BUILDING EQUIPMENT FOR OTHERS; PROVIDING INFORMATION VIA AN ON-LINE COMPUTER DATABASE IN THE FIELD OF BUSINESS; AND LICENSING OF COMPUTER SOFTWARE (U.S. CLS. 100, 101 AND 102).

FIRST USE 2-24-2000; IN COMMERCE 2-24-2000.

SN 76-053,164. TMH, INC., PRINCETON, NJ. FILED 5-22-2000.

**CLASS 36—INSURANCE AND FINANCIAL**

FOR FINANCIAL MANAGEMENT, PLANNING, ANALYSIS, RESEARCH, FORECASTING, REPORTING AND CONSULTATION FOR BUSINESSES; FISCAL ASSESSMENT AND EVALUATION FOR BUSINESSES; RISK MANAGEMENT; INSURANCE CONSULTATION AND BROKERAGE; BANKING; CHECKING AND SAVINGS ACCOUNT SERVICES; COMMERCIAL LENDING; CHECK PROCESSING AND VERIFICATION; FINANCING SERVICES AND LOAN FINANCING SERVICES; CREDIT CARD SERVICES; CREDIT RECOVERY AND COLLECTION; ELECTRONIC BILL PAYMENTS AND PRESENTMENT, NAMELY PROCESSING AND TRANSMISSION OF BILL PAYMENT DATA; ELECTRONIC FUNDS TRANSFER; PAYROLL TAX DEBITING SERVICES; CASH MANAGEMENT; ADMINISTRATION OF EMPLOYEE BENEFIT PLANS; AND PROVIDING INFORMATION VIA AN ON-LINE COMPUTER DATABASE IN THE FIELDS OF FINANCING SERVICES AND BANKING (U.S. CLS. 100, 101 AND 102).

FIRST USE 2-24-2000; IN COMMERCE 2-24-2000.

CLASS 35—ADVERTISING AND BUSINESS

FOR RETAIL SERVICES, BY MEANS OF A GLOBAL COMMUNICATIONS NETWORK, FEATURING GENERAL MERCHANDISE; CONDUCTING INTERACTIVE ON-LINE AUCTIONS FEATURING GENERAL MERCHANDISE; ADVERTISING SERVICES, NAMELY, DISTRIBUTING ADVERTISING FOR OTHERS BY MEANS OF A GLOBAL COMPUTER NETWORK (U.S. CLS. 100, 101 AND 102).

CLASS 38—COMMUNICATION

FOR PROVIDING MULTIPLE-USER ACCESS TO A GLOBAL COMPUTER INFORMATION NETWORK; COMPUTER SERVICES, NAMELY, PROVIDING INTERACTIVE COMPUTER BULLETIN BOARDS, MESSAGE BOARDS, AND CHAT ROOMS REGARDING A WIDE VARIETY OF TOPICS OF GENERAL INTEREST (U.S. CLS. 100, 101 AND 104).

CLASS 42—SCIENTIFIC, COMPUTER AND LEGAL SERVICES

FOR COMPUTER SERVICES, NAMELY PROVIDING SEARCH ENGINES FOR OBTAINING DATA IN THE FIELDS OF FINANCE, ACCOUNTING, BANKING AND BUSINESS MANAGEMENT ON A GLOBAL COMPUTER NETWORK; REVIEWING STANDARDS AND PRACTICES TO ASSURE COMPLIANCE WITH TAX LAWS AND REGULATIONS; LEASING AND RENTAL OF COMPUTER HARDWARE AND SOFTWARE; LICENSING OF INTELLECTUAL PROPERTY; AND COUNSELING, NAMELY, OFFERING ADVICE OR CONSULTATION IN THE FIELDS OF COMPUTER HARDWARE AND SOFTWARE (U.S. CLS. 100 AND 101).

FIRST USE 2-24-2000; IN COMMERCE 2-24-2000.

CLASS 42—SCIENTIFIC, COMPUTER AND LEGAL SERVICES

FOR COMPUTER SERVICES, NAMELY, PROVIDING A WEBSITE FEATURING AN ONLINE DATABASE OF ELECTRONIC MAIL ADDRESSES AND PROVIDING A WEBSITE FEATURING NEWS AND INFORMATION REGARDING A WIDE VARIETY OF TOPICS OF GENERAL INTEREST (U.S. CLS. 100 AND 101).

SN 76-054,051. IMAGETAG, INC., TEMPE, AZ. FILED 5-23-2000.

SN 76-056,752. FRISON, THEODORE W., GREAT FALLS, VA. FILED 5-19-2000.

KWIKTAG

CLASS 35—ADVERTISING AND BUSINESS

FOR COMPUTER SERVICES, NAMELY DATABASE MANAGEMENT OF COMPUTER DIGITAL IMAGES FOR OTHERS (U.S. CLS. 100, 101 AND 102).

CLASS 39—TRANSPORTATION AND STORAGE

FOR ELECTRONIC FILE ARCHIVING SERVICES IN THE NATURE OF ELECTRONIC STORAGE AND RETRIEVING OF COMPUTER DIGITAL IMAGES (U.S. CLS. 100 AND 105).

CHAOTIC.COM

CLASS 9—ELECTRICAL AND SCIENTIFIC APPARATUS

FOR COMPUTER SOFTWARE FOR USE IN SIGNAL PROCESSING AND DATA ANALYSIS (U.S. CLS. 21, 23, 26, 36 AND 38).

FIRST USE 2-9-2000; IN COMMERCE 2-9-2000.

CLASS 42—SCIENTIFIC, COMPUTER AND LEGAL SERVICES

FOR COMPUTER SOFTWARE DESIGN AND DEVELOPMENT FOR OTHERS, NAMELY FOR SIGNAL PROCESSING AND DATA ANALYSIS (U.S. CLS. 100 AND 101).

FIRST USE 2-9-2000; IN COMMERCE 2-9-2000.

SN 76-055,016. CHEREN, MEL, NEW YORK, NY. FILED 5-23-2000.

SN 76-060,480. MESSE DUSSELDORF GMBH, 40474 DUSSELDORF, FED REP GERMANY, FILED 5-31-2000.



THE STIPPLING SHOWN IN THE DRAWING IS A FEATURE OF THE MARK AND IS NOT INTENDED TO INDICATE COLOR.

CLASS 9—ELECTRICAL AND SCIENTIFIC APPARATUS

FOR PHONOGRAPH RECORDS, COMPACT DISCS AND PRE-RECORDED AUDIO TAPES FEATURING MUSIC; PRE-RECORDED VIDEO TAPES AND VIDEO DISCS FEATURING MUSICAL PERFORMANCES AND MOTION PICTURES FOR ENTERTAINMENT AND EDUCATION (U.S. CLS. 21, 23, 26, 36 AND 38).

FIRST USE 12-0-1998; IN COMMERCE 12-0-1998.

CLASS 25—CLOTHING

FOR APPAREL, NAMELY T-SHIRTS, SHIRTS, SWEATSHIRTS (U.S. CLS. 22 AND 39).

FIRST USE 12-0-1992; IN COMMERCE 12-0-1992.



PRIORITY CLAIMED UNDER SEC. 44(D) ON FED REP GERMANY APPLICATION NO. 39975566.738, FILED 12-1-1999, REG. NO. 39975566, DATED 10-11-2000, EXPIRES 12-31-2009.

CLASS 35—ADVERTISING AND BUSINESS

FOR PLANNING, ARRANGING AND CONDUCTING FAIRS, EXHIBITIONS AND PRESENTATIONS FOR ECONOMIC OR ADVERTISING PURPOSES IN THE WINE TRADE INDUSTRY; DATA PROCESSING SERVICES IN THE NATURE OF COMPILATION OF INFORMATION INTO DATA BASES AND SYSTEMIZATION OF DATA INTO DATA BASES; DISSEMINATION OF ADVERTISING MATTER; PROVIDING AN ON-LINE COMPUTER DATABASE IN THE FIELD OF THE WINE TRADE INDUSTRY; PERSONNEL MANAGEMENT CONSULTATION (U.S. CLS. 100, 101 AND 102).

CLASS 38—COMMUNICATION

FOR TELECOMMUNICATIONS SERVICES, NAMELY, PERSONAL COMMUNICATION SERVICES; TELEVISION AND RADIO BROADCASTING; TELEPHONE COMMUNICATION (U.S. CLS. 100, 101 AND 104).

SN 76-061,658. BRAXTEL COMMUNICATIONS, LLC, BOX-BOROUGH, MA. FILED 6-2-2000.

FLUENCY

CLASS 9—ELECTRICAL AND SCIENTIFIC APPARATUS

FOR COMPUTERIZED SYSTEMS COMPRISED OF COMPUTER HARDWARE, COMPUTER PERIPHERALS, COMMUNICATIONS SERVERS AND OPERATING SOFTWARE FOR CONTROL OF TELECOMMUNICATIONS SERVERS; COMPUTERIZED SYSTEMS COMPRISED OF COMPUTER HARDWARE, COMPUTER PERIPHERALS, AND COMMUNICATIONS SERVERS FOR OPERATING A CALL CENTER OR CONTACT CENTER, OPERATING SOFTWARE, AND USER AND INSTRUCTION MANUALS SOLD THEREWITH AS A UNIT (U.S. CLS. 21, 23, 26, 36 AND 38).

FIRST USE 2-19-2001; IN COMMERCE 2-19-2001.

CLASS 37—CONSTRUCTION AND REPAIR

FOR INSTALLATION AND MAINTENANCE OF COMPUTER SYSTEMS AND TELECOMMUNICATIONS HARDWARE; INSTALLATION OF COMPUTER NETWORKS (U.S. CLS. 100, 103 AND 106).

FIRST USE 2-19-2001; IN COMMERCE 2-19-2001.

CLASS 42—SCIENTIFIC, COMPUTER AND LEGAL SERVICES

FOR CONSULTING SERVICES IN THE FIELD OF TELECOMMUNICATIONS; INSTALLATION AND MAINTENANCE OF COMPUTER SOFTWARE AND TELECOMMUNICATIONS CONTROL SOFTWARE; COMPUTER SITE DESIGN; COMPUTER SYSTEMS ANALYSIS; INTEGRATION OF COMPUTER SYSTEMS AND NETWORKS (U.S. CLS. 100 AND 101).

FIRST USE 2-19-2001; IN COMMERCE 2-19-2001.

SN 76-063,348. STEVENS TRAVEL MANAGEMENT, INC., NEW YORK, NY. FILED 6-5-2000.

TRAVELCROSSINGS

CLASS 35—ADVERTISING AND BUSINESS

FOR ONLINE RETAIL SERVICES IN THE FIELD OF TRAVEL RELATED PRODUCTS (U.S. CLS. 100, 101 AND 102).

CLASS 39—TRANSPORTATION AND STORAGE

FOR TRAVEL AGENCY SERVICES, NAMELY, MAKING RESERVATIONS AND BOOKINGS FOR TRANSPORTATION; PROVIDING INFORMATION CONCERNING TRAVEL AND TRAVEL-RELATED TOPICS; PROVIDING TRAVEL INFORMATION OVER COMPUTER NETWORKS AND GLOBAL COMMUNICATION NETWORKS; PROVIDING TRAVEL RESERVATIONS AND BOOKING SERVICES FOR TRANSPORTATION, TOURS AND CRUISES OVER COMPUTER NETWORKS AND GLOBAL COMMUNICATION NETWORKS, PROVIDING INFORMATION ABOUT VACATION DESTINATIONS OVER COMPUTER NETWORKS AND GLOBAL COMMUNICATION NETWORKS (U.S. CLS. 100 AND 105).

CLASS 42—SCIENTIFIC, COMPUTER AND LEGAL SERVICES

FOR TRAVEL AGENCY SERVICES, NAMELY, MAKING RESERVATIONS AND BOOKINGS FOR TEMPORARY LODGING; PROVIDING LODGING INFORMATION SERVICES OVER COMPUTER NETWORKS AND GLOBAL COMMUNICATION NETWORKS; PROVIDING RESERVATIONS AND BOOKING SERVICES FOR TEMPORARY LODGING OVER COMPUTER NETWORKS AND GLOBAL COMMUNICATION NETWORKS (U.S. CLS. 100 AND 101).

SN 76-063,696. NEWBIOTICS, INC., SAN DIEGO, CA. FILED 5-31-2000.

NEWBIOTICS

CLASS 5—PHARMACEUTICALS

FOR PHARMACEUTICAL PREPARATIONS FOR THE TREATMENT OF CANCER, AUTO-IMMUNE DISEASES, AND BACTERIAL, VIRAL, AND FUNGAL INFECTIOUS (U.S. CLS. 6, 18, 44, 46, 51 AND 52).

CLASS 42—SCIENTIFIC, COMPUTER AND LEGAL SERVICES

FOR RESEARCH AND DEVELOPMENT OF PHARMACEUTICAL PREPARATIONS FOR OTHERS; CONSULTATION SERVICES IN THE FIELD OF RESEARCH AND DEVELOPMENT OF PHARMACEUTICAL PREPARATIONS FOR OTHERS (U.S. CLS. 100 AND 101).

SN 76-063,931. SATELLITE GUY, INC., THE, ADDISON, TX. FILED 6-6-2000.

THE SATELLITE GUY

NO CLAIM IS MADE TO THE EXCLUSIVE RIGHT TO USE "SATELLITE", APART FROM THE MARK AS SHOWN.

CLASS 35—ADVERTISING AND BUSINESS

FOR RETAIL STORE SERVICES FEATURING SATELLITE TELEVISION SYSTEMS (U.S. CLS. 100, 101 AND 102).

FIRST USE 10-31-1996; IN COMMERCE 10-31-1996.

CLASS 37—CONSTRUCTION AND REPAIR

FOR INSTALLATION OF SATELLITE TELEVISION SYSTEMS (U.S. CLS. 100, 103 AND 106).

FIRST USE 10-31-1996; IN COMMERCE 10-31-1996.

SN 76-064,317. VISUAL EDGE SOFTWARE CORP., CUPERTINO, CA. FILED 6-6-2000.

Actional

THE STIPPLING IN THE DRAWING IS FOR SHADING PURPOSES ONLY AND DOES NOT INDICATE COLOR.

CLASS 9—ELECTRICAL AND SCIENTIFIC APPARATUS

FOR COMPUTER SOFTWARE FOR CONNECTING TOGETHER ENTERPRISE SOFTWARE APPLICATIONS AND PLATFORMS, CUSTOMER RELATIONSHIP MANAGEMENT APPLICATIONS AND PLATFORMS, TRADING EXCHANGE AND MARKETPLACE SOFTWARE APPLICATIONS AND PLATFORMS, ELECTRONIC COMMERCE APPLICATIONS AND PLATFORMS, AND MIDDLEWARE PLATFORMS (U.S. CLS. 21, 23, 26, 36 AND 38).

CLASS 41—EDUCATION AND ENTERTAINMENT

FOR TRAINING IN THE USE OF COMPUTER SOFTWARE FOR CONNECTING TOGETHER ENTERPRISE SOFTWARE APPLICATIONS AND PLATFORMS, CUSTOMER RELATIONSHIP MANAGEMENT APPLICATIONS AND PLATFORMS, TRADING EXCHANGE AND MARKETPLACE SOFTWARE APPLICATIONS AND PLATFORMS, ELECTRONIC COMMERCE APPLICATIONS AND PLATFORMS, AND MIDDLEWARE PLATFORMS (U.S. CLS. 100, 101 AND 107).

CLASS 42—SCIENTIFIC, COMPUTER AND LEGAL SERVICES

FOR INSTALLATION AND MAINTENANCE OF COMPUTER SOFTWARE FOR CONNECTING TOGETHER ENTERPRISE SOFTWARE APPLICATIONS AND PLATFORMS, CUSTOMER RELATIONSHIP MANAGEMENT APPLICATIONS AND PLATFORMS, TRADING EXCHANGE AND MARKETPLACE SOFTWARE APPLICATIONS AND PLATFORMS, ELECTRONIC COMMERCE APPLICATIONS AND PLATFORMS, AND MIDDLEWARE PLATFORMS; COMPUTER SOFTWARE CONSULTING, NAMELY CUSTOMIZING OF COMPUTER SOFTWARE FOR CONNECTING TOGETHER ENTERPRISE SOFTWARE APPLICATIONS AND PLATFORMS, CUSTOMER RELATIONSHIP MANAGEMENT APPLICATIONS AND PLATFORMS, TRADING EXCHANGE AND MARKETPLACE SOFTWARE APPLICATIONS AND PLATFORMS, ELECTRONIC COMMERCE APPLICATIONS AND PLATFORMS, AND MIDDLEWARE PLATFORMS; TECHNICAL SUPPORT SERVICES, NAMELY TROUBLESHOOTING OF COMPUTER SOFTWARE PROBLEMS VIA GLOBAL COMPUTER NETWORKS, FOR SOFTWARE FOR CONNECTING TOGETHER ENTERPRISE SOFTWARE APPLICATIONS AND PLATFORMS, CUSTOMER RELATIONSHIP MANAGEMENT APPLICATIONS AND PLATFORMS, TRADING EXCHANGE AND MARKETPLACE SOFTWARE APPLICATIONS AND PLATFORMS, ELECTRONIC COMMERCE APPLICATIONS AND PLATFORMS, AND MIDDLEWARE PLATFORMS (U.S. CLS. 100 AND 101).

SN 76-065,076. DOLLFUS ET MULLER, FRANCE, FRANCE, FILED 6-7-2000.

DOLLFUS & MULLER

PRIORITY CLAIMED UNDER SEC. 44(D) ON FRANCE APPLICATION NO. 99828328, FILED 12-9-1999, REG. NO. 99/828328, DATED 12-9-1999, EXPIRES 12-9-2009.

CLASS 7—MACHINERY

FOR BELTS FOR MACHINES, NAMELY, TEXTILE BELTS FOR PROCESSING MACHINES INTENDED FOR THE TEXTILE BONDED WEB AND LEATHER INDUSTRIES (U.S. CLS. 13, 19, 21, 23, 31, 34 AND 35).

CLASS 17—RUBBER GOODS

FOR ELASTOMER BELTS, ELASTOMER SLEEVES, AND ELASTOMER-COATED CYLINDERS, ALL THESE PRODUCTS BEING INTENDED FOR THE TEXTILE, TANNING AND FOOD-PROCESSING INDUSTRIES (U.S. CLS. 1, 5, 12, 13, 35 AND 50).

CLASS 24—FABRICS

FOR CLOSED LOOP OR OPEN LOOP TEXTILE FABRICS, INTENDED FOR THE CONSTRUCTION OF TRANSPORTING, CONVEYING AND FILTERING SYSTEMS FOR ANY KIND OF INDUSTRY, AND TECHNICAL FELTS INTENDED FOR TRANSPORT, DEWATERING, FILTRATION, FINISHING, DIMENSIONAL STABILIZATION FOR ANY KIND OF INDUSTRY (U.S. CLS. 42 AND 50).

SN 76-066,074. MEDITRACT LLC, CHATTANOOGA, TN, FILED 6-7-2000.



The logo for TractManager features a stylized diamond shape composed of four smaller diamonds on the left, followed by the word "TRACTMANAGER" in a bold, serif font.

CLASS 35—ADVERTISING AND BUSINESS

FOR BUSINESS CONSULTING IN THE NATURE OF CONTRACT AND DOCUMENT DATABASE MANAGEMENT AND ADMINISTRATION (U.S. CLS. 100, 101 AND 102).

FIRST USE 3-20-2000; IN COMMERCE 3-20-2000.

CLASS 42—SCIENTIFIC, COMPUTER AND LEGAL SERVICES

FOR PROVIDING TEMPORARY USE OF ON-LINE NON-DOWNLOADABLE SOFTWARE FOR MANAGEMENT AND ADMINISTRATION OF DOCUMENT AND CONTRACT DATABASES (U.S. CLS. 100 AND 101).

FIRST USE 3-20-2000; IN COMMERCE 3-20-2000.

SN 76-066,208. PRL USA HOLDINGS, INC., WILMINGTON, DE. FILED 6-8-2000.

SN 76-067,311. BOCAR, S.A. DE C.V., LOS REYES COYOACAN, C.P., MEXICO, FILED 6-9-2000.

POLO

CLASS 9—ELECTRICAL AND SCIENTIFIC APPARATUS

FOR INTERACTIVE COMPUTER GAMES RECORDED ON CD-ROMS, INTERACTIVE VIDEO GAMES OF VIRTUAL REALITY COMPRISED OF COMPUTER HARDWARE AND SOFTWARE, COMPUTER GAME CASSETTES, COMPUTER GAME DISCS, COMPUTER GAME CARTRIDGES, COMPUTER GAME PROGRAMS, VIDEO GAME CASSETTES, VIDEO GAME DISCS, VIDEO GAME CARTRIDGES AND PERSONAL DIGITAL ASSISTANTS (U.S. CLS. 21, 23, 26, 36 AND 38).

CLASS 28—TOYS AND SPORTING GOODS

FOR HAND-HELD COMPUTER GAMES AND HAND-HELD VIDEO GAMES (U.S. CLS. 22, 23, 38 AND 50).

SN 76-067,016. CAESIUS SOFTWARE, INC., SEATTLE, WA. FILED 6-8-2000.

MISCELLANEOUS DESIGN

CLASS 9—ELECTRICAL AND SCIENTIFIC APPARATUS

FOR DATA MINING PRODUCT, NAMELY, COMPUTER SOFTWARE THAT PROVIDES A SEARCH ENGINE WITH THE CAPABILITY TO EXTRACT AND ORGANIZE SELECTED DATA FROM A WIDE VARIETY OF SOURCES ON A GLOBAL COMPUTER NETWORK; THE COMPUTER SOFTWARE BEING PROVIDED AS A PRODUCT ON A COMPUTER-READABLE MEDIA, NAMELY, ROM, RAM, EEPROM, FLASH MEMORY, MAGNETIC STORAGE DEVICES, CD-ROM, DVD, OPTICAL STORAGE DEVICES, MAGNETIC TAPE, MAGNETIC TAPE CASSETTES, MAGNETIC HARD DISK STORAGE AND FLOPPY DISKS AND THE COMPUTER SOFTWARE BEING PROVIDED AS A PRODUCT OVER A COMMUNICATIONS MEDIA VIA A GLOBAL COMPUTER NETWORK, NAMELY, WIRED NETWORK, DIRECT WIRED CONNECTION, AND WIRELESS NETWORK, NAMELY, ACOUSTIC, RADIO FREQUENCY AND INFRARED TECHNOLOGIES (U.S. CLS. 21, 23, 26, 36 AND 38).

FIRST USE 5-5-2000; IN COMMERCE 5-5-2000.

CLASS 42—SCIENTIFIC, COMPUTER AND LEGAL SERVICES

FOR COMPUTER SERVICES, NAMELY, PROVIDING COMPUTER SEARCHES FOR OBTAINING DATA ON A GLOBAL COMPUTER NETWORK (U.S. CLS. 100 AND 101).

FIRST USE 5-5-2000; IN COMMERCE 5-5-2000.

BOCAR

CLASS 7—MACHINERY

FOR ALUMINUM DIE CASTING ENGINE COMPONENTS FOR AUTOMOBILE ENGINES NAMELY, ENGINE BRACKETS, CAMSHAFT BEARINGS, THERMOHOUSING BODIES, WATER PUMPS, OIL PUMPS, ADAPTER OIL FILTERS; ZINC DIE CASTING AND GRAVITY CASTING PARTS FOR AUTOMOBILE ENGINES, NAMELY, INTAKE MANIFOLDS, WATER BYPASS VALVES, ADAPTER OIL FILTERS; NONFERROUS MACHINED AND ASSEMBLED COMPONENTS FOR AUTOMOBILE ENGINES, NAMELY, CARBURETORS, MECHANICAL FUEL PUMPS, OIL PUMPS, WATER PUMPS (U.S. CLS. 13, 19, 21, 23, 31, 34 AND 35).

FIRST USE 3-0-1975; IN COMMERCE 3-0-1975.

CLASS 9—ELECTRICAL AND SCIENTIFIC APPARATUS

FOR NONFERROUS MACHINED AND ASSEMBLED COMPONENTS FOR AUTOMOBILE ENGINES, NAMELY, ELECTRIC SWITCHES (U.S. CLS. 21, 23, 26, 36 AND 38).

FIRST USE 3-0-1975; IN COMMERCE 3-0-1975.

CLASS 12—VEHICLES

FOR MOTORS, NAMELY, AUTOMOBILE MOTORS; ALUMINUM DIE CASTING ENGINE COMPONENTS FOR AUTOMOBILE ENGINES, NAMELY, FRONT COVERS FOR AUTOMOBILE CHASSIS, CAM COVERS, TRANSMISSION COVERS; ZINC DIE CASTING AND GRAVITY CASTING PARTS FOR AUTOMOBILE ENGINES, NAMELY, OIL PANS; PLASTIC INJECTION MOLDING PARTS AND COMPONENTS FOR THE AUTOMOTIVE INDUSTRY, NAMELY, GLOVE BOX DOOR ASSEMBLIES, GLOVE BOX BACK ASSEMBLIES, DOOR ASSEMBLIES, CONTROL PANEL AND DASHBOARD ASSEMBLIES, SUPERIOR/UPPER AND INFERIOR/LOWER PILLARS (U.S. CLS. 19, 21, 23, 31, 35 AND 44).

FIRST USE 3-0-1975; IN COMMERCE 3-0-1975.

CLASS 42—SCIENTIFIC, COMPUTER AND LEGAL SERVICES

FOR AUTOMOTIVE RESEARCH AND ENGINEERING SERVICES (U.S. CLS. 100 AND 101).

FIRST USE 3-0-1975; IN COMMERCE 3-0-1975.

SN 76-067,318. BOCAR, S.A. DE C.V., LOS REYES COYOACAN, C.P., MEXICO, FILED 6-9-2000.



CLASS 7—MACHINERY

FOR ALUMINUM DIE CASTING ENGINE COMPONENTS FOR AUTOMOBILE ENGINES NAMELY, ENGINE BRACKETS, CAMSHAFT BEARINGS, THERMOHOUSING BODIES, WATER PUMPS, OIL PUMPS, ADAPTER OIL FILTERS; ZINC DIE CASTING AND GRAVITY CASTING PARTS FOR AUTOMOBILE ENGINES, NAMELY, INTAKE MANIFOLDS, WATER BYPASS VALVES, ADAPTER OIL FILTERS; NONFERROUS MACHINED AND ASSEMBLED COMPONENTS FOR AUTOMOBILE ENGINES, NAMELY, CARBURETORS, MECHANICAL FUEL PUMPS, OIL PUMPS, WATER PUMPS (U.S. CLS. 13, 19, 21, 23, 31, 34 AND 35).
FIRST USE 0-0-1968; IN COMMERCE 4-0-1970.

CLASS 9—ELECTRICAL AND SCIENTIFIC APPARATUS

FOR NONFERROUS MACHINED AND ASSEMBLED COMPONENTS FOR AUTOMOBILE ENGINES, NAMELY, ELECTRIC SWITCHES (U.S. CLS. 21, 23, 26, 36 AND 38).
FIRST USE 0-0-1968; IN COMMERCE 4-0-1970.

CLASS 12—VEHICLES

FOR MOTORS, NAMELY, AUTOMOBILE MOTORS; ALUMINUM DIE CASTING ENGINE COMPONENTS FOR AUTOMOBILE ENGINES, NAMELY, FRONT COVERS FOR AUTOMOBILE CHASSIS, CAM COVERS, TRANSMISSION COVERS; ZINC DIE CASTING AND GRAVITY CASTING PARTS FOR AUTOMOBILE ENGINES, NAMELY, OIL PANS; PLASTIC INJECTION MOLDING PARTS AND COMPONENTS FOR THE AUTOMOTIVE INDUSTRY, NAMELY, GLOVE BOX DOOR ASSEMBLIES, GLOVE BOX BACK ASSEMBLIES, DOOR ASSEMBLIES, CONTROL PANEL AND DASHBOARD ASSEMBLIES, SUPERIOR/UPPER AND INFERIOR/LOWER PILLARS (U.S. CLS. 19, 21, 23, 31, 35 AND 44).
FIRST USE 0-0-1968; IN COMMERCE 4-0-1970.

SN 76-067,384. J. PAUL GETTY TRUST, THE, LOS ANGELES, CA. FILED 6-9-2000.

GETTY.EDU

OWNER OF U.S. REG. NOS. 2,091,377, 2,091,399 AND OTHERS.
SEC. 2(F).

CLASS 39—TRANSPORTATION AND STORAGE

FOR PROVIDING GUIDED MUSEUM TOURS; PROVIDING GUIDED FIELD TOURS IN THE ARTS AND HUMANITIES (U.S. CLS. 100 AND 105).

CLASS 41—EDUCATION AND ENTERTAINMENT

FOR FULL LINE OF EDUCATIONAL AND MUSEUM SERVICES IN THE ARTS AND HUMANITIES, NAMELY OPERATING A MUSEUM; ART EXHIBITIONS; ORGANIZING AND CONDUCTING LECTURES, CONFERENCES, CLASSES, WORKSHOPS, PROGRAMS AND SEMINARS IN THE FIELDS OF THE ARTS AND HUMANITIES, DEVELOPING AND DISSEMINATING EDUCATIONAL MATERIALS FOR OTHERS IN THE FIELDS OF THE ARTS AND HUMANITIES; SPONSORING EDUCATIONAL INITIATIVES AND COMMUNITY OUTREACH PROGRAMS IN THE FIELDS OF THE ARTS AND HUMANITIES; CONDUCTING ART EDUCATION CLASSES AND WORKSHOPS AT THE PRIMARY AND SECONDARY LEVELS; LIBRARY SERVICES; LENDING AND RENTAL OF ARTWORKS, REPRESENTATIONS OF ART WORKS AND REPRODUCTIONS OF ARTWORKS; TRAINING OTHERS IN THE CONSERVATION AND PRESERVATION OF ARTWORKS AND CULTURAL PROPERTIES; PROVIDING MUSEUM MANAGEMENT TRAINING FOR MUSEUM DIRECTORS, ADMINISTRATORS, CURATORS, STEWARDS AND EDUCATORS; PROVIDING ENTERTAINMENT IN THE NATURE OF LIVE MUSICAL, THEATRICAL AND DANCE PRESENTATIONS (U.S. CLS. 100, 101 AND 107).

CLASS 42—SCIENTIFIC, COMPUTER AND LEGAL SERVICES

FOR RESEARCH IN THE FIELDS OF THE ARTS AND HUMANITIES; PRESERVING AND CONSERVING WORKS OF ARTS AND CULTURAL PROPERTIES; INFORMATION SERVICES, NAMELY PROVIDING INFORMATION PERTAINING TO THE ARTS AND HUMANITIES OVER A GLOBAL COMPUTER NETWORK; PROVIDING ON-LINE RESEARCH DATABASES, INFORMATION NETWORKS AND WEB SITES IN THE FIELDS OF THE ARTS AND HUMANITIES (U.S. CLS. 100 AND 101).

SN 76-067,472. SEABURY & SMITH, INC., NEW YORK, NY. FILED 6-9-2000.

MARSH @WORK

CLASS 35—ADVERTISING AND BUSINESS

FOR BUSINESS CONSULTING; BUSINESS MANAGEMENT CONSULTING, AND HUMAN RESOURCES CONSULTING (U.S. CLS. 100, 101 AND 102).

CLASS 36—INSURANCE AND FINANCIAL

FOR ADMINISTRATION OF EMPLOYEE BENEFITS PLANS AND EMPLOYEE PENSION PLANS; INSURANCE ADMINISTRATION AND INSURANCE BROKERAGE IN THE FIELDS OF LIFE INSURANCE, PROPERTY AND CASUALTY INSURANCE, AND HEALTH INSURANCE; INSURANCE CONSULTATION; EMPLOYEE BENEFITS AND VOLUNTARY BENEFITS CONSULTING; INVESTMENT CONSULTING; INVESTMENT BROKERAGE; FINANCIAL ANALYSIS AND CONSULTING; FUND INVESTMENT CONSULTING; MORTGAGE BROKERAGE; MUTUAL FUND BROKERAGE (U.S. CLS. 100, 101 AND 102).

CLASS 42—SCIENTIFIC, COMPUTER AND LEGAL SERVICES

FOR COMPUTER SERVICES, NAMELY DESIGNING AND IMPLEMENTING WEB SITES FOR EMPLOYERS TO PERMIT ACCESS BY EMPLOYEES TO PURCHASE GOODS AND SERVICES OF OTHERS (U.S. CLS. 100 AND 101).

SN 76-068,804. AIDS-HILFE SCHWEIZ, 8031 ZURICH, SWITZERLAND, FILED 6-12-2000.

HOT RUBBER

OWNER OF SWITZERLAND REG. NO. 402,920, DATED 3-29-1993, EXPIRES 3-29-2013.

NO CLAIM IS MADE TO THE EXCLUSIVE RIGHT TO USE "RUBBER", APART FROM THE MARK AS SHOWN.

CLASS 5—PHARMACEUTICALS

FOR GELS FOR USE AS A PERSONAL INTIMATE LUBRICANT (U.S. CLS. 6, 18, 44, 46, 51 AND 52).

CLASS 10—MEDICAL APPARATUS

FOR CONDOMS (U.S. CLS. 26, 39 AND 44).

SN 76-069,610. KILCHER, JEWEL, SAN DIEGO, CA. FILED 6-14-2000.

SOUL CITY

CLASS 35—ADVERTISING AND BUSINESS

FOR ON-LINE RETAIL SERVICES FEATURING AUDIO AND VIDEO PROGRAMS IN THE FIELD OF CULTURE, ART, MUSIC AND LITERATURE VIA THE INTERNET (U.S. CLS. 100, 101 AND 102).

CLASS 41—EDUCATION AND ENTERTAINMENT

FOR ON-LINE WORKSHOPS IN THE FIELDS OF CULTURE, ART, MUSIC AND LITERATURE; PROVIDING AN ON-LINE FORUM FOR THE EXCHANGE OF INFORMATION, FILES, AND MATERIALS IN THE FIELDS OF CULTURE, ART, MUSIC AND LITERATURE (U.S. CLS. 100, 101 AND 107).

CLASS 42—SCIENTIFIC, COMPUTER AND LEGAL SERVICES

FOR COMPUTER SERVICES, NAMELY CREATING INDEXES OF INFORMATION, SITES AND OTHER RESOURCES AVAILABLE ON COMPUTER NETWORKS; SEARCHING AND RETRIEVING INFORMATION, SITES AND OTHER RESOURCES AVAILABLE ON COMPUTER NETWORKS FOR OTHERS; PROVIDING AN ON-LINE LINK TO NEWS, CURRENT AND CULTURAL EVENTS, ENTERTAINMENT, ART, ARTISTS, MUSIC, MUSICIANS, LITERATURE, AUTHORS AND REFERENCE MATERIALS; PROVIDING AN ON-LINE FORUM FOR HONORING ARTISTS, MUSICIANS AND AUTHORS (U.S. CLS. 100 AND 101).

SN 76-070,493. CAVELIER ABOGADOS, BOGOTA, COLOMBIA, FILED 6-14-2000.

CAVELIER

CLASS 35—ADVERTISING AND BUSINESS

FOR PATENT AND TRADEMARK MONITORING AND SEARCHING SERVICES; BUSINESS MANAGEMENT CONSULTATION AND RESEARCH (U.S. CLS. 100, 101 AND 102).

FIRST USE 3-10-1983; IN COMMERCE 8-0-1997.

CLASS 42—SCIENTIFIC, COMPUTER AND LEGAL SERVICES

FOR LEGAL SERVICES IN THE DIFFERENT FIELDS OF LAW, NAMELY, CIVIL, COMMERCIAL, ADMINISTRATIVE AND CONSTITUTIONAL LAW, CORPORATE LAW, FOREIGN INVESTMENTS, COMMERCIAL CONTRACTS, AGENCY, FRANCHISING AND DISTRIBUTION AGREEMENTS, BANKING AND FINANCE LAW, TRADEMARKS AND SERVICE MARKS, COMMERCIAL NAMES, PATENTS, UTILITY MODELS, INTELLECTUAL PROPERTY, COPYRIGHT, TRANSFER OF TECHNOLOGY, UNFAIR COMPETITION, ARBITRATION, LITIGATION IN INDUSTRIAL PROPERTY, ANTITRUST AND TRADE REGULATIONS, ANDEAN GROUP AND ANDEAN COURT OF JUSTICE, PUBLIC AND PRIVATE INTERNATIONAL LAW, OIL AND MINING LAW, ENVIRONMENTAL LAW, HEALTH REGISTRATIONS, PLANT VARIETIES, DOMAIN NAMES, E-COMMERCE, E-BANKING, E-GOVERNMENT AND INTERNET LAW (U.S. CLS. 100 AND 101).

FIRST USE 3-10-1983; IN COMMERCE 8-0-1997.

SN 76-070,494. CAVELIER ABOGADOS, BOGOTA, COLOMBIA, FILED 6-14-2000.

CAVELIER ABOGADOS

NO CLAIM IS MADE TO THE EXCLUSIVE RIGHT TO USE "ABOGADOS", APART FROM THE MARK AS SHOWN. THE ENGLISH TRANSLATION OF "ABOGADOS" IS "LAWYERS".

CLASS 35—ADVERTISING AND BUSINESS

FOR PATENT AND TRADEMARK MONITORING AND SEARCHING SERVICES; BUSINESS MANAGEMENT CONSULTATION AND RESEARCH (U.S. CLS. 100, 101 AND 102).

FIRST USE 8-0-1997; IN COMMERCE 8-0-1997.

CLASS 42—SCIENTIFIC, COMPUTER AND LEGAL SERVICES

FOR LEGAL SERVICES IN THE DIFFERENT FIELDS OF LAW, NAMELY, CIVIL, COMMERCIAL, ADMINISTRATIVE AND CONSTITUTIONAL LAW, CORPORATE LAW, FOREIGN INVESTMENTS, COMMERCIAL CONTRACTS, AGENCY, FRANCHISING AND DISTRIBUTION AGREEMENTS, BANKING AND FINANCE LAW, TRADEMARKS AND SERVICE MARKS, COMMERCIAL NAMES, PATENTS, UTILITY MODELS, INTELLECTUAL PROPERTY, COPYRIGHT, TRANSFER OF TECHNOLOGY, UNFAIR COMPETITION, ARBITRATION, LITIGATION IN INDUSTRIAL PROPERTY, ANTITRUST AND TRADE REGULATIONS, ANDEAN GROUP AND ANDEAN COURT OF JUSTICE, PUBLIC AND PRIVATE INTERNATIONAL LAW, OIL AND MINING LAW, ENVIRONMENTAL LAW, HEALTH REGISTRATIONS, PLANT VARIETIES, DOMAIN NAMES, E-COMMERCE, E-BANKING, E-GOVERNMENT AND INTERNET LAW (U.S. CLS. 100 AND 101).

FIRST USE 8-0-1997; IN COMMERCE 8-0-1997.

SN 76-071,481. AMERICAN PRODUCTION AND INVENTORY CONTROL SOCIETY, ALEXANDRIA, VA. FILED 6-16-2000.

REMAN SIG

OWNER OF U.S. REG. NO. 1,579,495.

NO CLAIM IS MADE TO THE EXCLUSIVE RIGHT TO USE "REMAN" AND "SIG", APART FROM THE MARK AS SHOWN.

CLASS 16—PAPER GOODS AND PRINTED MATTER

FOR PRINTED MATERIALS NAMELY NEWSLETTERS AND BROCHURES CONCERNING EDUCATIONAL COURSES, SEMINARS AND WORKSHOPS IN THE FIELD OF PRODUCTION AND INVENTORY CONTROL (U.S. CLS. 2, 5, 22, 23, 29, 37, 38 AND 50).

FIRST USE 0-0-1983; IN COMMERCE 0-0-1983.

CLASS 41—EDUCATION AND ENTERTAINMENT

FOR EDUCATIONAL SERVICES, NAMELY, PROVIDING EDUCATIONAL COURSES, SEMINARS AND WORKSHOPS IN THE FIELD OF PRODUCTION AND INVENTORY CONTROL (U.S. CLS. 100, 101 AND 107).

FIRST USE 0-0-1983; IN COMMERCE 0-0-1983.

CLASS 9—ELECTRICAL AND SCIENTIFIC APPARATUS

FOR ENTERTAINMENT MEDIA, NAMELY, MOTION PICTURE FILMS, EXPOSED FILM AND NEGATIVE CONTAINING MOTION PICTURES, TELEVISION MOVIES, DOCUMENTARIES, NEWS, MUSICALS, COMEDY PERFORMANCES, AND OTHER TYPES OF ENTERTAINMENT MEDIA; CELLS, NAMELY, FILM DUPLICATIONS OF INDIVIDUAL FRAMES OF MOTION PICTURES, NAMELY, COMPUTER-ASSISTED RENDERINGS AND PRODUCTIONS OF IMAGES CREATED BY COMPUTER-ASSISTED RENDERINGS, OR OTHER MEANS OF IMAGE PRODUCTION FOR INCORPORATION INTO A MOTION PICTURE; BLANK LASER DISCS, BLANK AUDIO AND VIDEO TAPES, SOUND TRACKS FOR MOTION PICTURE AND TELEVISION MOVIES, CD-ROMS, AND COMPUTER DISCS (U.S. CLS. 21, 23, 26, 36 AND 38).

CLASS 41—EDUCATION AND ENTERTAINMENT

FOR ENTERTAINMENT SERVICES, NAMELY, MOTION PICTURE, TELEVISION, LASER DISC AND VIDEO AND AUDIO TAPE PRODUCTION (U.S. CLS. 100, 101 AND 107).

SN 76-071,484. AMERICAN PRODUCTION AND INVENTORY CONTROL SOCIETY, ALEXANDRIA, VA. FILED 6-16-2000.

PI SIG

OWNER OF U.S. REG. NO. 1,579,495.
NO CLAIM IS MADE TO THE EXCLUSIVE RIGHT TO USE "PI" AND "SIG", APART FROM THE MARK AS SHOWN.

SN 76-074,223. BROAN-NUTONE LLC, HARTFORD, WI. FILED 6-20-2000.

CLASS 16—PAPER GOODS AND PRINTED MATTER

FOR PRINTED MATERIALS, NAMELY, NEWSLETTERS AND BROCHURES CONCERNING EDUCATIONAL COURSES, SEMINARS AND WORKSHOPS IN THE FIELD OF PRODUCTION AND INVENTORY CONTROL (U.S. CLS. 2, 5, 22, 23, 29, 37, 38 AND 50).

FIRST USE 0-0-1983; IN COMMERCE 0-0-1983.

CLASS 41—EDUCATION AND ENTERTAINMENT

FOR EDUCATIONAL SERVICES, NAMELY, PROVIDING EDUCATIONAL COURSES, SEMINARS AND WORKSHOPS IN THE FIELD OF PRODUCTION AND INVENTORY CONTROL (U.S. CLS. 100, 101 AND 107).

FIRST USE 0-0-1983; IN COMMERCE 0-0-1983.

BROAN-NUTONE

OWNER OF U.S. REG. NOS. 505,582, 2,184,419 AND OTHERS.

CLASS 35—ADVERTISING AND BUSINESS

FOR RETAIL STORE AND MAIL ORDER CATALOGUE SERVICES FEATURING VENTILATION SYSTEMS, NAMELY, BATH FANS, RANGE HOODS, HEATER/FAN LIGHT COMBINATION UNITS, INDOOR AIR QUALITY SYSTEMS, HEATERS, WHOLE-HOUSE FANS, ATTIC VENTILATORS; AND TRASH COMPACTORS, MEDICINE CABINETS, DOOR CHIMES, PADDLE FANS, STEREO INTERCOM SYSTEMS, CENTRAL VACUUM SYSTEMS AND IRONING CENTERS (U.S. CLS. 100, 101 AND 102).

FIRST USE 2-15-2000; IN COMMERCE 2-15-2000.

SN 76-073,777. LUCASEY, JOHN, OAKLAND, CA. FILED 6-20-2000.

880 ENTERTAINMENT

NO CLAIM IS MADE TO THE EXCLUSIVE RIGHT TO USE "ENTERTAINMENT", APART FROM THE MARK AS SHOWN.

CLASS 40—MATERIAL TREATMENT

FOR CUSTOM MANUFACTURE OF VENTILATION SYSTEMS, NAMELY, BATH FANS, RANGE HOODS, HEATER/FAN LIGHT COMBINATION UNITS, INDOOR AIR QUALITY SYSTEMS, HEATERS, WHOLE-HOUSE FANS, ATTIC VENTILATORS; AND TRASH COMPACTORS, MEDICINE CABINETS, DOOR CHIMES, PADDLE FANS, STEREO INTERCOM SYSTEMS, CENTRAL VACUUM SYSTEMS AND IRONING CENTERS (U.S. CLS. 100, 103 AND 106).

FIRST USE 2-15-2000; IN COMMERCE 2-15-2000.

SN 76-074,360. SERITIS SERVICES GROUP, LLC, MILWAUKEE, WI. FILED 6-21-2000.

SERITIS

CLASS 35—ADVERTISING AND BUSINESS

FOR BUSINESS MANAGEMENT, NAMELY, TURN-KEY PROJECT MANAGEMENT (U.S. CLS. 100, 101 AND 102).

FIRST USE 2-17-1997; IN COMMERCE 8-31-1997.

CLASS 42—SCIENTIFIC, COMPUTER AND LEGAL SERVICES

FOR INFORMATION TECHNOLOGY CONSULTING SERVICES, PRIMARILY USED FOR THE ASSET MANAGEMENT, BANKING AND INSURANCE INDUSTRIES; SOFTWARE APPLICATION DEVELOPMENT; SOFTWARE PRODUCT DEVELOPMENT; AND DATA CONVERSION OF COMPUTER PROGRAM DATA OR INFORMATION NOT PHYSICAL CONVERSION (U.S. CLS. 100 AND 101).

FIRST USE 2-17-1997; IN COMMERCE 8-31-1997.

SN 76-076,375. HAT TRICK PRODUCTIONS LTD., LONDON W1V 3PH, ENGLAND, FILED 6-22-2000.

HAVE I GOT NEWS FOR YOU

PRIORITY CLAIMED UNDER SEC. 44(D) ON UNITED KINGDOM APPLICATION NO. 2235283, FILED 6-8-2000, REG. NO. 2235283, DATED 5-8-2000, EXPIRES 6-8-2010.

CLASS 9—ELECTRICAL AND SCIENTIFIC APPARATUS

FOR (BASED ON INTENT TO USE) AUDIO AND VIDEO RECORDINGS, COMPACT DISCS AND CD-ROMS, ALL FEATURING CURRENT AFFAIRS, QUIZ SHOWS, COMEDY SHOWS, ENTERTAINMENT OR GENERAL FEATURE (U.S. CLS. 21, 23, 26, 36 AND 38).

CLASS 16—PAPER GOODS AND PRINTED MATTER

FOR (BASED ON INTENT TO USE) PERIODICAL PUBLICATIONS, NAMELY, MAGAZINES, NEWSPAPERS AND NEWSLETTERS, ALL IN THE FIELD OF CURRENT AFFAIRS, QUIZ SHOWS, COMEDY SHOWS AND ENTERTAINMENT OR FEATURING ARTICLES OF GENERAL INTEREST; PRINTED MATTER, NAMELY, BROCHURES IN THE FIELD OF CURRENT AFFAIRS, QUIZ SHOWS, COMEDY SHOWS AND ENTERTAINMENT OR FEATURING ARTICLES OF GENERAL INTEREST, AND DIARIES; MOUNTED AND UNMOUNTED PHOTOGRAPHS; BOOKS IN THE FIELD OF CURRENT AFFAIRS, QUIZ SHOWS, COMEDY SHOWS AND ENTERTAINMENT OR GENERAL INTEREST; WRITING PAPER, WRAPPING PAPER (U.S. CLS. 2, 5, 22, 23, 29, 37, 38 AND 50).

CLASS 25—CLOTHING

FOR (BASED ON INTENT TO USE) AND (BASED ON 44(E)) PRIORITY APPLICATION) CLOTHING, NAMELY, DRESSES, SUITS, TROUSERS, T-SHIRTS, SHORTS, JACKETS, SHIRTS, SKIRTS, SINGLETS, VESTS, RAINWEAR, UNDERWEAR, SOCKS, COATS; FOOTWEAR; HEADWEAR (U.S. CLS. 22 AND 39).

CLASS 41—EDUCATION AND ENTERTAINMENT

FOR (BASED ON INTENT TO USE) TELEVISION AND RADIO PRODUCTION, RECORDING AND SYNDICATION; DISTRIBUTION OF TELEVISION AND RADIO PROGRAMS; MOTION PICTURE CINE FILM PRODUCTION; VIDEO TAPE PRODUCTION; RECORDED SOUND PRODUCTION; SHOW PRODUCTION SERVICES, NAMELY, THE PRODUCTION OF TELEVISION SHOWS, RADIO SHOWS AND LIVE STAGE SHOW PERFORMANCES; RECORDING STUDIO SERVICES; INFORMATION AND ADVISORY SERVICES ALL RELATING TO THE AFORESAID SERVICES (U.S. CLS. 100, 101 AND 107).

SN 76-077,587. KUKRALL, KATHY, GLENDALE, AZ. FILED 6-26-2000.



CLASS 25—CLOTHING

FOR CAPS, VISORS, T-SHIRTS, SHIRTS, SHORTS, SOCKS, SWEAT BANDS, SWEATERS AND JACKETS (U.S. CLS. 22 AND 39).

FIRST USE 7-5-2000; IN COMMERCE 7-5-2000.

CLASS 28—TOYS AND SPORTING GOODS

FOR GOLF CLUBS, NAMELY WOODS, IRONS AND PUTTERS AND GOLF ACCESSORIES NAMELY, GLOVES, BALLS, GOLF CLUB HEAD COVERS AND GOLF GRIPS (U.S. CLS. 22, 23, 38 AND 50).

FIRST USE 7-5-2000; IN COMMERCE 7-5-2000.

SN 76-077,782. ACANDO AB, S-114 85 STOCKHOLM, SWEDEN, FILED 6-27-2000.

ACANDO

OWNER OF SWEDEN REG. NO. 343306, DATED 12-22-2000, EXPIRES 12-22-2010.

CLASS 9—ELECTRICAL AND SCIENTIFIC APPARATUS

FOR COMPUTER SOFTWARE USED FOR BUSINESS MANAGEMENT AND BUSINESS ADMINISTRATION, EXCLUDING SOFTWARE USED FOR DATABASE MANAGEMENT AND MAINTENANCE; COMPUTER HARDWARE (U.S. CLS. 21, 23, 26, 36 AND 38).

CLASS 35—ADVERTISING AND BUSINESS

FOR DISSEMINATION OF ADVERTISING MATTER; BUSINESS MANAGEMENT; BUSINESS MANAGEMENT AND ADMINISTRATION CONSULTATION SERVICES; OPERATION OF A BUSINESS FOR OTHERS (U.S. CLS. 100, 101 AND 102).

CLASS 41—EDUCATION AND ENTERTAINMENT

FOR EDUCATIONAL SERVICES IN THE NATURE OF PROVIDING CLASSES, WORKSHOPS AND SEMINARS ON THE SUBJECT OF BUSINESS MANAGEMENT AND BUSINESS ADMINISTRATION; ENTERTAINMENT SERVICES IN THE NATURE OF ORGANIZING AND CONDUCTING SPORTING EVENTS AND CULTURAL ACTIVITIES (U.S. CLS. 100, 101 AND 107).

CLASS 42—SCIENTIFIC, COMPUTER AND LEGAL SERVICES

FOR VETERINARY SERVICES; LEGAL SERVICES; SCIENTIFIC RESEARCH; RESEARCH IN THE FIELD OF BUSINESS MANAGEMENT; COMPUTER PROGRAMMING FOR OTHERS RELATING TO BUSINESS MANAGEMENT; COMPUTER CONSULTATION SERVICES RELATING TO BUSINESS MANAGEMENT; INSTALLATION AND UPDATING OF SOFTWARE RELATING TO BUSINESS MANAGEMENT (U.S. CLS. 100 AND 101).

SN 76-078,992. AF2 ENTERPRISES LLC, CHICAGO, IL. FILED 6-28-2000.



THE MARK CONSISTS, IN PART, OF A STYLIZED BARRACUDA HOLDING A FOOTBALL.

CLASS 16—PAPER GOODS AND PRINTED MATTER

FOR GENERAL MERCHANDISE CATALOGS, BUMPER STICKERS, WRITING PADS AND PENS, TRADING CARDS, POSTERS, POST CARDS, CALENDARS, PAPER STICKERS, APPLIQUES IN THE FORM OF DECALS, AND GREETING CARDS (U.S. CLS. 2, 5, 22, 23, 29, 37, 38 AND 50).

FIRST USE 12-20-1999; IN COMMERCE 12-20-1999.

CLASS 25—CLOTHING

FOR MEN'S, WOMEN'S AND CHILDREN'S CLOTHING, NAMELY, PLAYER UNIFORMS, NAMELY, FOOTWEAR, JERSEY TOPS AND PANTS; CHEERLEADER UNIFORMS; REPLICA UNIFORM SHIRTS, COACHES' CAPS, WOOL HATS, PAINTERS' CAPS, BASEBALL CAPS, VISORS, HEADBANDS, BELTS, T-SHIRTS, TANK TOPS, GOLF SHIRTS, SWEATERS, SWEATSHIRTS, LEATHER JACKETS, NECKTIES, COATS, SHORTS, SWEATPANTS, PANTS, SOCKS AND UNDERWEAR (U.S. CLS. 22 AND 39).

FIRST USE 12-20-1999; IN COMMERCE 12-20-1999.

CLASS 41—EDUCATION AND ENTERTAINMENT

FOR ENTERTAINMENT SERVICES, NAMELY, ORGANIZING AND PRESENTING FOOTBALL GAMES BEFORE LIVE AUDIENCES AND ON TELEVISION, RADIO FOR GLOBAL COMPUTER NETWORK DISPLAY AND OTHER MEDIA (U.S. CLS. 100, 101 AND 107).

FIRST USE 12-20-1999; IN COMMERCE 12-20-1999.

SN 76-078,437. GINGE-KERR DANMARK A/S, DK-2650 HVIDOVRE, DENMARK, FILED 6-27-2000.

ARGONITE

OWNER OF DENMARK REG. NO. VR199300848, DATED 1-29-1993, EXPIRES 1-29-2003.

CLASS 1—CHEMICALS

FOR FIRE EXTINGUISHING COMPOSITIONS, NAMELY FIRE EXTINGUISHING GASES (U.S. CLS. 1, 5, 6, 10, 26 AND 46).

CLASS 9—ELECTRICAL AND SCIENTIFIC APPARATUS

FOR FIRE EXTINGUISHING SYSTEMS COMPRISED PRIMARILY OF PRESSURE CYLINDERS, GAUGES, SWITCHES, MANIFOLDS, VALVES, PIPES AND NOZZLES (U.S. CLS. 21, 23, 26, 36 AND 38).

SN 76-079,373. FRENCH CONNECTION LIMITED, LONDON E3 8DA, ENGLAND, FILED 6-28-2000.

FRENCH CONNECTION

OWNER OF ERPN CMNTY TM OFC REG. NO. 001080266, DATED 3-26-2001, EXPIRES 3-26-2011.

OWNER OF UNITED KINGDOM REG. NO. 2251304, DATED 2-11-2000, EXPIRES 2-11-2010.

OWNER OF U.S. REG. NOS. 995,877, 1,310,145 AND 1,527,886.

CLASS 9—ELECTRICAL AND SCIENTIFIC APPARATUS

FOR SPECTACLES, SUNGLASSES, AND ACCESSORIES THEREOF, NAMELY, CASES, FRAMES, LENSES, EARSTEMS, CHAINS, NOSE PADS AND PARTS AND FITTINGS THEREOF; NOSE-CLIPS FOR DIVERS AND SWIMMERS, CLIP-ON SUNGLASSES, ANTI-GLARE EYEGLASSES, SAFETY GOGGLES, AND EYEGLASSES, NAMELY, PINCE-NEZ TYPE EYEGLASSES AND PARTS AND FITTINGS THEREOF (U.S. CLS. 21, 23, 26, 36 AND 38).

CLASS 14—JEWELRY

FOR HOROLOGICAL INSTRUMENTS AND APPARATUS, NAMELY WATCHES, AND PARTS AND FITTINGS THEREOF; WATCH BANDS, WATCH CHAINS, WATCH STRAPS, AND PARTS AND FITTINGS THEREOF (U.S. CLS. 2, 27, 28 AND 50).

SN 76-080,746. ADVANCED INTERFACE SOLUTIONS, INC., WESTFIELD, IN. FILED 6-29-2000.

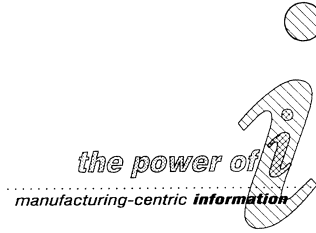

NO CLAIM IS MADE TO THE EXCLUSIVE RIGHT TO USE "INFORMATION", APART FROM THE MARK AS SHOWN.

THE MARK IS LINED FOR THE COLORS PURPLE, GREEN AND ORANGE.

SN 76-079,726. AF2 ENTERPRISES LLC, CHICAGO, IL. FILED 6-28-2000.

**CLASS 25—CLOTHING**

FOR MEN'S, WOMEN'S AND CHILDREN'S CLOTHING, NAMELY, PLAYER UNIFORMS, NAMELY, FOOTWEAR, JERSEY TOPS AND PANTS; CHEERLEADER UNIFORMS; REPLICA UNIFORM SHIRTS, COACHES' CAPS, WOOL HATS, PAINTERS' CAPS, BASEBALL CAPS, VISORS, HEADBANDS, BELTS, T-SHIRTS, TANK TOPS, GOLF SHIRTS, SWEATERS, SWEATSHIRTS, LEATHER JACKETS, NECKTIES, COATS, SHORTS, SWEATPANTS, PANTS, SOCKS AND UNDERWEAR (U.S. CLS. 22 AND 39).

FIRST USE 4-16-2000; IN COMMERCE 4-16-2000.

CLASS 41—EDUCATION AND ENTERTAINMENT

FOR ENTERTAINMENT SERVICES, NAMELY, ORGANIZING AND PRESENTING FOOTBALL GAMES BEFORE LIVE AUDIENCES AND ON TELEVISION, RADIO FOR GLOBAL COMPUTER NETWORK DISPLAY AND OTHER MEDIA (U.S. CLS. 100, 101 AND 107).

FIRST USE 11-17-1999; IN COMMERCE 11-17-1999.

CLASS 9—ELECTRICAL AND SCIENTIFIC APPARATUS

FOR HARDWARE AND SOFTWARE FOR MANUFACTURING AND BUSINESS CONTROL AND REPORTING BASED ON REAL TIME INFORMATION (U.S. CLS. 21, 23, 26, 36 AND 38).

CLASS 42—SCIENTIFIC, COMPUTER AND LEGAL SERVICES

FOR CONSULTING, IMPLEMENTING AND MANAGING HARDWARE AND SOFTWARE FOR MANUFACTURING AND BUSINESS CONTROL AND REPORTING BASED ON REAL TIME INFORMATION (U.S. CLS. 100 AND 101).

SN 76-081,822. MOVICORP HOLDINGS, INC., BEVERLY HILLS, CA. FILED 7-3-2000.

OASIS TV

OWNER OF U.S. REG. NO. 2,265,254.
NO CLAIM IS MADE TO THE EXCLUSIVE RIGHT TO USE "TV", APART FROM THE MARK AS SHOWN.

CLASS 38—COMMUNICATION

FOR CABLE TELEVISION BROADCASTING (U.S. CLS. 100, 101 AND 104).

FIRST USE 6-11-1996; IN COMMERCE 6-11-1996.

CLASS 41—EDUCATION AND ENTERTAINMENT

FOR PRODUCTION OF AUDIO-VISUAL PROGRAMS FOR DISTRIBUTION ON CABLE TELEVISION, VIDEO TAPE AND THE INTERNET, NOT INCLUDING THE DUPLICATION OF AUDIO TAPES, COMPACT DISCS AND VIDEO TAPES FOR THIRD PARTIES (U.S. CLS. 100, 101 AND 107).

FIRST USE 6-11-1996; IN COMMERCE 6-11-1996.

SN 76-083,067. OWLCENTRAL LIMITED, AUCKLAND, NEW ZEALAND, FILED 7-5-2000.

OWLDOCUMENTS

PRIORITY CLAIMED UNDER SEC. 44(D) ON NEW ZEALAND APPLICATION NO. 614984, FILED 5-18-2000, REG. NO. 614984, DATED 5-18-2000, EXPIRES 5-18-2010.
PRIORITY CLAIMED UNDER SEC. 44(D) ON NEW ZEALAND APPLICATION NO. 614983, FILED 5-18-2000.

CLASS 9—ELECTRICAL AND SCIENTIFIC APPARATUS

FOR COMPUTER SOFTWARE FOR THE CREATION, COMPLETION, DELIVERY, STORAGE AND/OR MANAGEMENT OF DOCUMENTS, FORMS, TEMPLATES AND INFORMATION (U.S. CLS. 21, 23, 26, 36 AND 38).

CLASS 42—SCIENTIFIC, COMPUTER AND LEGAL SERVICES

FOR COMPUTER PROGRAMMING FOR OTHERS (U.S. CLS. 100 AND 101).

SN 76-083,166. INFORMATECH INC., LAVAL, QUEBEC, CANADA, FILED 7-5-2000.

USAPP-E.COM

CLASS 9—ELECTRICAL AND SCIENTIFIC APPARATUS

FOR BUSINESS MANAGEMENT SOFTWARE (U.S. CLS. 21, 23, 26, 36 AND 38).

CLASS 35—ADVERTISING AND BUSINESS

FOR BUSINESS MANAGEMENT CONSULTING SERVICES, AND BUSINESS MANAGEMENT SOFTWARE SUPPORT SERVICES (U.S. CLS. 100, 101 AND 102).

SN 76-083,417. WUJEK-CALCATERRA & SONS, INC., STERLING HEIGHTS, MI. FILED 7-6-2000.



CLASS 36—INSURANCE AND FINANCIAL

FOR FUNERAL INSURANCE SERVICES, NAMELY FUNERAL INSURANCE UNDERWRITING AND PREPAID FUNERAL EXPENSE SERVICES (U.S. CLS. 100, 101 AND 102).

FIRST USE 1-15-1998; IN COMMERCE 1-15-1998.

CLASS 42—SCIENTIFIC, COMPUTER AND LEGAL SERVICES

FOR FUNERAL HOME SERVICES, NAMELY PLANNING AND CONDUCTING FUNERALS, TRANSFERRING REMAINS, PROVIDING FUNERAL COACHES, CASKETS, VAULTS, AND URNS, PREPARATIONS OF BODY, EMBALMING, CREMATING, ARRANGING VIEWINGS, RECEPTIONS, FUNERAL MEMORIAL CEREMONIES, INTERMENTS AND BURIALS (U.S. CLS. 100 AND 101).

FIRST USE 1-15-1998; IN COMMERCE 1-15-1998.

SN 76-083,496. GEMSTAR DEVELOPMENT CORPORATION, PASADENA, CA. FILED 7-5-2000.

THE NEW WAY TO READ

CLASS 9—ELECTRICAL AND SCIENTIFIC APPARATUS

FOR HAND-HELD DISPLAY DEVICES FOR RECEIVING AND DISPLAYING ELECTRONICALLY PUBLISHED WORKS, AND SOFTWARE FOR SAME (U.S. CLS. 21, 23, 26, 36 AND 38).

CLASS 35—ADVERTISING AND BUSINESS

FOR DISTRIBUTORSHIP SERVICES IN THE FIELD OF NON-FICTIONAL AND FICTIONAL ELECTRONIC PUBLICATIONS (U.S. CLS. 100, 101 AND 102).

CLASS 41—EDUCATION AND ENTERTAINMENT

FOR ELECTRONIC PUBLISHING SERVICES, NAMELY, ELECTRONIC PUBLICATION OF NON-FICTION AND FICTION TO REMOTE HAND-HELD DISPLAY DEVICES FOR STORAGE AND DISPLAY (U.S. CLS. 100, 101 AND 107).

SN 76-083,746. CONSTRUCTION SOFTWARE TECHNOLOGIES, INC., WEST CHESTER, OH. FILED 7-6-2000.

ISQFT.COM

CLASS 35—ADVERTISING AND BUSINESS

FOR COMPUTERIZED DATABASE MANAGEMENT, NAMELY, PROVIDING AN ON-LINE SERVICE FOR MANAGING DATA IN THE FORM OF DRAWING PLANS, BLUEPRINTS, AND SPECIFICATIONS OF CONSTRUCTION COMPANIES, REAL ESTATE DEVELOPERS, ENGINEERS, ARCHITECTS, SUBCONTRACTORS AND FACILITIES MANAGERS VIA A GLOBAL COMPUTER NETWORK (U.S. CLS. 100, 101 AND 102).

CLASS 38—COMMUNICATION

FOR PROVIDING AN ON-LINE ELECTRONIC FORUM IN THE NATURE OF CHAT ROOMS AND BULLETIN BOARDS VIA A GLOBAL COMPUTER NETWORK FOR THE TRANSMISSION OF MESSAGES AMONG COMPUTER USERS WHICH ALLOWS CONSTRUCTION COMPANIES, SUPPLIERS, ARCHITECTS, VENDORS, SUBCONTRACTORS AND FACILITIES MANAGERS TO COMMUNICATE ON CONSTRUCTION PROJECTS (U.S. CLS. 100, 101 AND 104).

SN 76-084,801. SSL PRODUCTS LIMITED, CHESHIRE WA 16 9PD, ENGLAND, FILED 7-7-2000.

SN 76-085,494. PICKHARDT, MARTINA, HAMBURG, FED REP GERMANY, FILED 7-5-2000.

AVANCE

CLASS 5—PHARMACEUTICALS

FOR BANDAGES FOR SKIN WOUNDS; WOUND AND SURGICAL DRESSINGS; MATERIALS FOR DRESSINGS, NAMELY, GAUZE AND SURGICAL TAPE; INCONTINENCE PADS; SURGICAL SPONGES; COTTON WADDING FOR SURGERY AND WOUNDS; COTTON SWABS FOR MEDICAL PURPOSES; AND PRE-MOISTENED MEDICATED WIPES (U.S. CLS. 6, 18, 44, 46, 51 AND 52).

CLASS 10—MEDICAL APPARATUS

FOR COMPRESSION BANDAGES; BREAST PADS (U.S. CLS. 26, 39 AND 44).



SN 76-084,829. MEDAIRE, INC., PHOENIX, AZ. FILED 7-7-2000.

EXPERT CARE, EVERYWHERE

NO CLAIM IS MADE TO THE EXCLUSIVE RIGHT TO USE "EXPERT CARE", APART FROM THE MARK AS SHOWN.

CLASS 41—EDUCATION AND ENTERTAINMENT

FOR EDUCATIONAL SERVICES, NAMELY, PROVIDING CLASSES, SEMINARS, CONFERENCES AND WORKSHOPS ON PROCEDURES UTILIZED IN MEDICAL EMERGENCIES AT REMOTE LOCATIONS IN AIR, LAND OR SEA (U.S. CLS. 100, 101 AND 107).
FIRST USE 10-0-1999; IN COMMERCE 10-0-1999.

CLASS 42—SCIENTIFIC, COMPUTER AND LEGAL SERVICES

FOR MEDICAL CONSULTATION AND TELEMEDICINE SERVICES AND EMERGENCY MEDICAL SERVICES INCLUDING TELEMEDICINE MONITORING AND NURSE OR PHYSICIAN TRIAGING PROVIDED ON AIRCRAFT, BOATS OR ON LAND; PROVIDING PRE-TRAVEL ADVICE AND PRECAUTIONARY MEDICAL ADVICE FOR VARIOUS TRAVEL DESTINATIONS, NAMELY, MEDICAL CONSULTATION WITH RESPECT TO EPIDEMICS, OUTBREAKS, UNUSUAL AND/OR LOCALIZED DISEASES, REQUIRED AND RECOMMENDED IMMUNIZATIONS, FOOD AND/OR WATER PROBLEMS, INSECTS AND ANIMALS AND POTENTIAL MEDICAL CONDITIONS RELATED THERETO AND STEPS THAT SHOULD BE TAKEN TO AVOID MEDICAL PROBLEMS; MEDICAL CONSULTATION AND TELEMEDICINE SERVICES WHICH PROVIDE INFORMATION CONCERNING LOCAL MEDICAL SPECIALISTS, HOSPITALS AND CLINICS FOR VARIOUS TRAVEL DESTINATIONS; MEDICAL CONSULTATION AND TELEMEDICINE SERVICES WHICH PROVIDE MEDICAL ADVICE AND TRIAGE SERVICES BY NURSES, PHYSICIANS AND SPECIALTY PHYSICIANS; SAID SERVICES NOT COMPRISING HOME HEALTH CARE, TEMPORARY STAFFING OR SUPPLYING GOODS OR SERVICES TO HOSPITALS; TELEPHONE COUNSELING, NAMELY OFFERING CONSULTATION REGARDING TREATMENT AND/OR TRANSPORTATION OF A STRICKEN PARTY IN CONNECTION WITH MEDICAL EMERGENCIES ON AIRCRAFT, LAND VEHICLES, AND WATER VESSELS (U.S. CLS. 100 AND 101).
FIRST USE 10-0-1999; IN COMMERCE 10-0-1999.

THE STIPLING IN THE MARK IS FOR SHADING PURPOSES ONLY AND DOES NOT INDICATE COLOR.

THE MARK CONSISTS OF A DESIGN DEPICTING A FAIRY IN A CIRCLE WITH A MAGICIAN'S WAND; CIRCLE BEING SMALLER THAN SIZE OF FAIRY.

CLASS 16—PAPER GOODS AND PRINTED MATTER

FOR PUBLICATION PRODUCTS, NAMELY MAGAZINES, BROCHURES, AND FLYERS IN THE FIELD OF THE DOMESTIC AND INTERNATIONAL TRADE BUSINESS (U.S. CLS. 2, 5, 22, 23, 29, 37, 38 AND 50).

CLASS 35—ADVERTISING AND BUSINESS

FOR ADVERTISING AGENCIES AND ONLINE MARKET RESEARCH; BUSINESS MANAGEMENT CONSULTATION; PUBLICATION OF PUBLICITY TEXTS (U.S. CLS. 100, 101 AND 102).

SN 76-086,455. KM3 MEDIA, LLC, DEL MAR, CA. FILED 7-11-2000.

BEYONDCLASS

CLASS 35—ADVERTISING AND BUSINESS

FOR PROVIDING INFORMATION OF ADVERTISING FOR OTHERS VIA THE INTERNET (U.S. CLS. 100, 101 AND 102).
FIRST USE 11-0-1999; IN COMMERCE 11-0-1999.

CLASS 42—SCIENTIFIC, COMPUTER AND LEGAL SERVICES

FOR PROVIDING A WIDE RANGE OF GENERAL INTEREST INFORMATION FEATURING ACADEMIC RESEARCH, ENTERTAINMENT AND SPORTS NEWS, CAREERS INFORMATION, AND HEALTH AND FITNESS ISSUES (U.S. CLS. 100 AND 101).
FIRST USE 11-0-1999; IN COMMERCE 11-0-1999.

SN 76-087,430. FOLIAGE SOFTWARE SYSTEMS, INC., BURLINGTON, MA. FILED 7-12-2000.

SN 76-087,777. TPRESSENCE, INC., PITTSBURGH, PA. FILED 7-10-2000.

FOLIAGE

CLASS 9—ELECTRICAL AND SCIENTIFIC APPARATUS

FOR COMPUTER SOFTWARE FOR DATA ANALYSIS TO BE USED IN THE FIELD OF BUSINESS-TO-BUSINESS NETWORKS AND INTERNET-BASED TRANSACTIONS (U.S. CLS. 21, 23, 26, 36 AND 38).

CLASS 42—SCIENTIFIC, COMPUTER AND LEGAL SERVICES

FOR COMPUTER SOFTWARE DEVELOPMENT SERVICES FOR OTHERS (U.S. CLS. 100 AND 101).

SN 76-087,478. TEALUXE, INC., FRANKLIN, MA. FILED 7-13-2000.



OWNER OF U.S. REG. NOS. 2,071,591 AND 2,165,216. THE STIPPLING SHOWN IN THE DRAWING IS A FEATURE OF THE MARK AND IS NOT INTENDED TO INDICATE COLOR.

CLASS 21—HOUSEWARES AND GLASS

FOR HOUSEWARES, NAMELY, TEA POTS NOT OF PRECIOUS METAL, BEVERAGE GLASSWARE, TEA CANISTERS, INSULATED BEVERAGE CUPS, TEA CUPS, AND MUGS; NON-ELECTRIC APPLIANCES, NAMELY, KETTLES MADE OF METAL, STAINLESS STEEL AND/OR CERAMIC (U.S. CLS. 2, 13, 23, 29, 30, 33, 40 AND 50).

FIRST USE 12-0-1996; IN COMMERCE 12-0-1996.

CLASS 30—STAPLE FOODS

FOR TEA AND TEA-BASED BEVERAGES FOR CONSUMPTION ON OR OFF THE PREMISES (U.S. CL. 46).

FIRST USE 12-0-1996; IN COMMERCE 12-0-1996.

CLASS 35—ADVERTISING AND BUSINESS

FOR RETAIL STORES, MAIL ORDER SERVICES, AND ON-LINE STORE SERVICES FEATURING TEA, TEA-RELATED GIFT ITEMS, SOUVENIRS, ACCESSORIES, HOUSEWARES, AND OTHER GENERAL MERCHANDISE (U.S. CLS. 100, 101 AND 102).

FIRST USE 12-0-1996; IN COMMERCE 12-0-1996.

CLASS 42—SCIENTIFIC, COMPUTER AND LEGAL SERVICES

FOR RESTAURANT SERVICES, RESTAURANT TAKE-OUT SERVICES, CAFE SERVICES, TEA HOUSE RESTAURANT SERVICES (U.S. CLS. 100 AND 101).

FIRST USE 12-0-1996; IN COMMERCE 12-0-1996.

INTELLIPRESENCE

CLASS 9—ELECTRICAL AND SCIENTIFIC APPARATUS

FOR COMPUTER SOFTWARE FOR DATA AND COMMUNICATION MANAGEMENT (U.S. CLS. 21, 23, 26, 36 AND 38).

FIRST USE 6-27-2000; IN COMMERCE 6-27-2000.

CLASS 42—SCIENTIFIC, COMPUTER AND LEGAL SERVICES

FOR COMPUTER CONSULTATION RELATING TO DATA AND COMMUNICATIONS MANAGEMENT (U.S. CLS. 100 AND 101).

FIRST USE 6-21-2000; IN COMMERCE 6-21-2000.

SN 76-087,812. ALTA CULTURA, INC., NEW YORK, NY. FILED 7-11-2000.

ONMODERN

CLASS 16—PAPER GOODS AND PRINTED MATTER

FOR POSTERS, ART PRINTS, NOTE CARDS, STATIONERY, PENCILS AND PENS (U.S. CLS. 2, 5, 22, 23, 29, 37, 38 AND 50).

CLASS 18—LEATHER GOODS

FOR BAGS, NAMELY, PURSES, BACKPACKS AND TOTE BAGS (U.S. CLS. 1, 2, 3, 22 AND 41).

CLASS 25—CLOTHING

FOR CLOTHING, NAMELY, T-SHIRTS, SWEAT-SHIRTS, CAPS AND SCARVES (U.S. CLS. 22 AND 39).

CLASS 35—ADVERTISING AND BUSINESS

FOR ONLINE RETAIL SERVICES IN THE FIELD OF ARTWORK, STATIONERY, BOOKS, HOUSEWARES, GIFTS, TOYS, FURNITURE, CLOTHING AND OTHER GENERAL MERCHANDISE (U.S. CLS. 100, 101 AND 102).

CLASS 41—EDUCATION AND ENTERTAINMENT

FOR ONLINE MUSEUM SERVICES; PROVIDING INFORMATION IN THE FIELD OF ART AND CULTURE; AND ONLINE EDUCATIONAL SERVICES, NAMELY, PROVIDING CLASSES AND SEMINARS IN THE FIELDS OF ART, CULTURE, AND DESIGN OF DECORATIVE OR ARTISTIC WORKS, NAMELY, ARCHITECTURE, PAINTING, ENGRAVING, SCULPTURE, FURNITURE, HOUSEHOLD OBJECTS, FORMS AND FIGURES, VIA THE INTERNET AND THE DISTRIBUTION OF MATERIALS (U.S. CLS. 100, 101 AND 107).

CLASS 42—SCIENTIFIC, COMPUTER AND LEGAL SERVICES

FOR COMPUTER SERVICES, NAMELY, ONLINE GREETING CARDS; AND PROVIDING INFORMATION IN THE FIELD OF DESIGN OF DECORATIVE OR ARTISTIC WORKS, NAMELY, ARCHITECTURE, PAINTING, ENGRAVING, SCULPTURE, FURNITURE, HOUSEHOLD OBJECTS, FORMS AND FIGURES (U.S. CLS. 100 AND 101).

SN 76-087,876. COOGI AUSTRALIA PTY. LTD., ABBOTSFORD VICTORIA 3067, AUSTRALIA, FILED 7-12-2000.

DU BLUE

CLASS 3—COSMETICS AND CLEANING PREPARATIONS

FOR FRAGRANCES, NAMELY, PERFUMES AND COLOGNES, BODY LOTIONS, BODY GELS, BODY CREAMS, AND BODY SOAPS (U.S. CLS. 1, 4, 6, 50, 51 AND 52).

CLASS 9—ELECTRICAL AND SCIENTIFIC APPARATUS

FOR EYEWEAR, NAMELY SUNGLASSES AND EYEGASSES (U.S. CLS. 21, 23, 26, 36 AND 38).

CLASS 25—CLOTHING

FOR SWIMWEAR AND BEACHWEAR (U.S. CLS. 22 AND 39).

SN 76-087,906. AUTREFOIS S.R.L., MILANO, ITALY, FILED 7-13-2000.



Sophie Petit

PRIORITY CLAIMED UNDER SEC. 44(D) ON ERPNTY TM OFC APPLICATION NO. 1550409, FILED 3-10-2000, REG. NO. 1550409, DATED 3-10-2000, EXPIRES 3-10-2010.

IN THE DESIGN PORTION OF THE MARK, THE STEM AND LEAVES ARE GREEN AND THE FLOWERS ARE RED.

CLASS 3—COSMETICS AND CLEANING PREPARATIONS

FOR LIQUID AND SOLID SOAPS FOR HANDS, FACE AND BODY, TOILET SOAPS, DETERGENT SOAPS, BABY SOAPS, PERFUMED SOAPS, SKIN SOAPS, COLOGNE, TOILET WATERS, EAU DE PARFUM, EAU DE TOILETTE, PERFUMES, ESSENTIAL OILS FOR USE BY CHILDREN, ESSENTIAL OILS FOR PERSONAL USE, DAY CREAM, FOUNDATION MAKEUP, NAIL POLISH, POWDER, BLUSH, EYE SHADOW, EYE LINER, LIPSTICK, HAIR LOTIONS; DENTIFRICES (U.S. CLS. 1, 4, 6, 50, 51 AND 52).

CLASS 16—PAPER GOODS AND PRINTED MATTER

FOR NOTEBOOK PAPER, LETTER PAPER, WRITING PAPER, LOOSELEAF PAPER, PAPER EXPANDING FILES, PRINTING PAPER, ART PAPER, COMPUTER PAPER, PAPER BADGES, PAPER BAGS, PAPER BANNERS, PAPER BIBS, PAPER BOARDS, PAPER BOXES, PAPER BOWS FOR GIFT WRAP, PAPER CAKE DECORATIONS, ENVELOPES, CARDBOARD BOXES, CARDBOARD CARTONS, CARDBOARD CONTAINERS, CARDBOARD FLOOR DISPLAY UNITS FOR MERCHANDISING PRODUCTS, CARDBOARD MAILING TUBES, NUMERICAL AND ALPHABETIC INSERTS IN PAPER AND CARDBOARD, CARDBOARD; BOOKS AND MAGAZINES IN THE FIELD OF BABYHOOD, EXERCISE BOOKS, ADDRESS BOOKS, NOTEBOOKS, CALENDARS, AGENDAS; UNMOUNTED PHOTOGRAPHS; STATIONERY; ADHESIVES FOR STATIONERY OR HOUSEHOLD PURPOSES; ARTISTS' BRUSHES, PAINTING SETS FOR ARTISTS, ARTISTS' PASTELS, ARTISTS' PENS, ARTISTS' PENCILS; PAINT BRUSHES; TYPEWRITERS, CORRECTING FLUID FOR INK AND TYPE, PUNCHES, RUBBER BANDS, STAPLERS, FOUNTAIN PENS, ROLLER BALLPOINT PENS, FELT TIPPED PENS, ROLLER PENS, MARKERS, MARKING PENS, PENCIL AND PENCIL LEADS, REFILLS FOR PENS, NON-ELECTRIC ERASERS, HIGHLIGHTERS; GENERAL PURPOSE PLASTIC BAGS, ENVELOPES AND POUCHES FOR MERCHANDISE PACKAGING, PLASTIC BUBBLE PACKS FOR WRAPPING OR PACKAGING; PLAYING CARDS; STENCILS AND LITTLE MOULDS FOR USE BY CHILDREN; PRINTING BLOCKS (U.S. CLS. 2, 5, 22, 23, 29, 37, 38 AND 50).

CLASS 20—FURNITURE AND ARTICLES NOT OTHERWISE CLASSIFIED

FOR BEDROOM FURNITURE, TABLES, CHAIRS, HIGH-CHAIRS, COMPUTER FURNITURE, MIRRORS, PICTURE FRAMES; BOXES AND CONTAINERS MADE OF PLASTIC, WOOD, BONE, IVORY, PLASTER, BUSTS, FIGURES AND FIGURINES MADE OF BONE, IVORY, PLASTER, PLASTIC, WAX AND WOOD, GIFT PACKAGE DECORATIONS MADE OF PLASTIC (U.S. CLS. 2, 13, 22, 25, 32 AND 50).

CLASS 25—CLOTHING

FOR COATS, RAINCOATS, WAISTCOATS, BLOUSES, PULLOVERS, JACKETS, TROUSERS, SHORTS, SKIRTS, DRESSES, SUITS, SHIRTS, CHEMISES, T-SHIRTS, SWEATERS, UNDERWEAR, SOCKS AND STOCKINGS, GLOVES, TIES, SCARVES, CLOTH BIBS, WRAPS, BELTS, PANTS, VESTS, JERSEYS, PAJAMAS, BATHING SUITS, EQUIPMENT FOR CHILDREN, NAMELY, PINAFORE AND ROMPERS, FOOTWEAR, HEADWEAR, HATS, CAPS, HEADSCARVES (U.S. CLS. 22 AND 39).

CLASS 27—FLOOR COVERINGS

FOR CARPETS, RUGS, RUBBER BATH MATS, CORK MATS, TEXTILE FLOOR MATS FOR USE IN THE HOME, LINOLEUM; NON-TEXTILE WALL HANGINGS (U.S. CLS. 19, 20, 37, 42 AND 50).

SN 76-089,173. NATIONAL MANUFACTURING CO., STERLING, IL. FILED 7-14-2000.

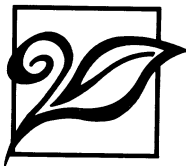

CLASS 6—METAL GOODS

FOR METAL DECORATIVE ACCENT HARDWARE PRODUCTS FOR HOME EXTERIOR AND GARDEN-RELATED USE, NAMELY, ADDRESS PLATES, PREFABRICATED ARBORS, BASKET HOOKS, BIRD BATHS, NON-ELECTRIC METAL DOORBELLS, DOOR HINGES, DOOR KICKPLATES, DOOR KNOCKERS, FENCE POST CAPS, FLAG HOLDERS, GATE HANDLES, GATE HINGES, GATE LATCHES, GATE RETURN SPRINGS, GATE STAYS, GARDEN HOSE HANGERS AND GUIDES, HAND-OPERATED GARDEN HOSE REELS, HOUSE NUMBERS; METAL DOOR HARDWARE, NAMELY, METAL LOCKS, MAILBOXES, MAIL SLOTS FOR DOORS, NAMEPLATES, SHELF BRACKETS, SHUTTER CLIPS, SHUTTER HINGES, TREE HOOKS, WEATHER VANES; METAL CONSTRUCTION HARDWARE, NAMELY, STEP BRACKETS, HAND RAIL BRACKETS, HAND RAILING, BENCH BRACKETS, AND FENCE BRACKETS; METAL TRELLISES, TRELLIS ARBORS AND OBELISKS, AND TRELLIS STANDS; STATUES AND FIGURINES OF NON-PRECIOUS METALS; METAL SHEPHERD HOOKS AND WREATH HOLDERS (U.S. CLS. 2, 12, 13, 14, 23, 25 AND 50).

CLASS 9—ELECTRICAL AND SCIENTIFIC APPARATUS

FOR ELECTRIC DOORBELLS AND DOORBELL SWITCH BUTTONS; DRIVEWAY MARKERS; MAGNIFYING PEEPHOLES FOR DOORS (U.S. CLS. 21, 23, 26, 36 AND 38).

CLASS 11—ENVIRONMENTAL CONTROL APPARATUS

FOR ELECTRIC METAL DECORATIVE ACCENT HARDWARE PRODUCTS, NAMELY, COACH LIGHTS, HANGING LIGHTS, LANDSCAPE LIGHTS, PATH LIGHTS, TORCHES, PORCH LIGHTS, AND POST LIGHTS; GARDEN FAUCETS (U.S. CLS. 13, 21, 23, 31 AND 34).

CLASS 14—JEWELRY

FOR SUN DIALS (U.S. CLS. 2, 27, 28 AND 50).

CLASS 19—NON-METALLIC BUILDING MATERIALS

FOR NON-METAL TRELLISES AND TRELLIS STANDS; STATUES AND FIGURINES OF STONE, CONCRETE OR RESIN; PATIO AND STEPPING STONES; CONCRETE OR RESIN BIRD BATHS (U.S. CLS. 1, 12, 33 AND 50).

CLASS 20—FURNITURE AND ARTICLES NOT OTHERWISE CLASSIFIED

FOR DECORATIVE ACCENT PRODUCTS FOR HOME EXTERIOR AND GARDEN-RELATED USE, NAMELY, UMBRELLA STANDS; PLASTIC LANDSCAPE EDGING BORDERS; NON-METAL WREATH HOLDERS (U.S. CLS. 2, 13, 22, 25, 32 AND 50).

CLASS 21—HOUSEWARES AND GLASS

FOR DECORATIVE ACCENT HARDWARE PRODUCTS FOR HOME EXTERIOR AND GARDEN RELATED USE, NAMELY, BIRD FEEDERS, CANDLE HOLDERS NOT OF PRECIOUS METALS, FLOWER BOXES, FLOWER WINDOW BOXES, FLOWER POT HOLDERS AND CADDIES, HANGING FLOWER BASKETS, PLANT STANDS; YARD ART AND FEEDERS ORNAMENTS, NAMELY STATUES AND FIGURES OF TERRA COTTA, BIRD BATHS NOT BEING STRUCTURES AND BIRD FEEDERS (U.S. CLS. 2, 13, 23, 29, 30, 33, 40 AND 50).

SN 76-089,174. NATIONAL MANUFACTURING CO., STERLING, IL. FILED 7-14-2000.



CLASS 6—METAL GOODS

FOR METAL DECORATIVE ACCENT HARDWARE PRODUCTS FOR HOME EXTERIOR AND GARDEN-RELATED USE, NAMELY ADDRESS PLATES, PREFABRICATED ARBORS, BASKET HOOKS, BIRD BATHS, NON-ELECTRIC METAL DOORBELLS, DOOR HINGES, DOOR KICKPLATES, DOOR KNOCKERS, FENCE POST CAPS, FLAG HOLDERS, GATE HANDLES, GATE HINGES, GATE LATCHES, GATE RETURN SPRINGS, GATE STAYS, GARDEN HOSE HANGERS AND GUIDES, HAND-OPERATED GARDEN HOSE REELS, HOUSE NUMBERS; METAL DOOR HARDWARE, NAMELY, METAL LOCKS, MAILBOXES, MAIL SLOTS FOR DOORS, NAMEPLATES, SHELF BRACKETS, SHUTTER CLIPS, SHUTTER HINGES, TREE HOOKS, WEATHER VANES; METAL CONSTRUCTION HARDWARE NAMELY, STEP BRACKETS, HAND RAIL BRACKETS, HAND RAILING, BENCH BRACKETS, AND FENCE BRACKETS; METAL TRELLISES, TRELLIS ARBORS AND OBELISKS, AND TRELLIS STANDS; STATUES AND FIGURINES OF NON-PRECIOUS METALS; METAL SHEPHERD HOOKS AND WREATH HOLDERS (U.S. CLS. 2, 12, 13, 14, 23, 25 AND 50).

CLASS 9—ELECTRICAL AND SCIENTIFIC APPARATUS

FOR ELECTRIC DOORBELLS AND DOORBELL SWITCH BUTTONS; DRIVEWAY MARKERS; MAGNIFYING PEEPHOLES FOR DOORS (U.S. CLS. 21, 23, 26, 36 AND 38).

CLASS 11—ENVIRONMENTAL CONTROL APPARATUS

FOR ELECTRIC METAL DECORATIVE ACCENT HARDWARE PRODUCTS, NAMELY COACH LIGHTS, HANGING LIGHTS, LANDSCAPE LIGHTS, PATH LIGHTS, TORCHES, PORCH LIGHTS, AND POST LIGHTS; GARDEN FAUCETS (U.S. CLS. 13, 21, 23, 31 AND 34).

CLASS 14—JEWELRY

FOR SUN DIALS (U.S. CLS. 2, 27, 28 AND 50).

CLASS 19—NON-METALLIC BUILDING MATERIALS

FOR NON-METAL TRELLISES AND TRELLIS STANDS; STATUES AND FIGURINES OF STONE, CONCRETE OR RESIN; PATIO AND STEPPING STONES; CONCRETE OR RESIN BIRD BATHS (U.S. CLS. 1, 12, 33 AND 50).

CLASS 20—FURNITURE AND ARTICLES NOT OTHERWISE CLASSIFIED

FOR DECORATIVE ACCENT PRODUCTS FOR HOME EXTERIOR AND GARDEN-RELATED USE, NAMELY, UMBRELLA STANDS; PLASTIC LANDSCAPE EDGING BORDERS; NON-METAL WREATH HOLDERS (U.S. CLS. 2, 13, 22, 25, 32 AND 50).

CLASS 21—HOUSEWARES AND GLASS

FOR DECORATIVE ACCENT HARDWARE PRODUCTS FOR HOME EXTERIOR AND GARDEN RELATED USE, NAMELY, BIRD FEEDERS, CANDLE HOLDERS NOT OF PRECIOUS METALS, FLOWER BOXES, FLOWER WINDOW BOXES, FLOWER POT HOLDERS AND CADDIES, HANGING FLOWER BASKETS, PLANT STANDS; YARD ART AND FEEDERS ORNAMENTS, NAMELY STATUES AND FIGURES OF TERRA COTTA, BIRD BATHS NOT BEING STRUCTURES AND BIRD FEEDERS (U.S. CLS. 2, 13, 23, 29, 30, 33, 40 AND 50).

SN 76-089,244. NUFORIA INC., DBA RED SKY, HINGHAM, MA. FILED 7-14-2000.

EVERY CLICK IS A WISH**CLASS 9—ELECTRICAL AND SCIENTIFIC APPARATUS**

FOR COMPUTER SOFTWARE FOR USE IN SUPPORTING INTERACTIVE PROGRAMS RUNNING ON THE GLOBAL ELECTRONIC COMMUNICATIONS NETWORKS, KIOSKS AND CD-ROMS; COMPUTER PROGRAMS FOR THE PURPOSE OF CREATING AND REPRODUCING SOUND, PICTURES, SPECIAL EFFECTS, AND TEXT, IN THE FIELDS OF ADVERTISING AND PROMOTIONS AND GAMES (U.S. CLS. 21, 23, 26, 36 AND 38).

CLASS 35—ADVERTISING AND BUSINESS

FOR PREPARATION OF COMPUTER GENERATED INTERACTIVE MULTIMEDIA PROMOTIONAL AND ADVERTISING PRESENTATIONS FOR OTHERS; PROVIDING INFORMATION IN THE FIELD OF ADVERTISING AND THE PROMOTION OF THE GOODS AND SERVICES OF OTHERS VIA WEBSITES ON GLOBAL COMPUTER NETWORKS (U.S. CLS. 100, 101 AND 102).

CLASS 41—EDUCATION AND ENTERTAINMENT

FOR PREPARATION OF COMPUTER GENERATED INTERACTIVE MULTIMEDIA ENTERTAINMENT PRESENTATIONS FOR OTHERS; PROVIDING INFORMATION IN THE FIELD OF EDUCATION AND VIDEO GAMES, EDUCATIONAL GAMES, SPORTS GAMES AND INTERACTIVE GAMES BY MEANS OF A GLOBAL COMPUTER NETWORK (U.S. CLS. 100, 101 AND 107).

CLASS 42—SCIENTIFIC, COMPUTER AND LEGAL SERVICES

FOR CONSULTING SERVICES IN THE FIELD OF INTERACTIVE MULTIMEDIA PRESENTATIONS; COMPUTER SERVICES, NAMELY, CUSTOM DESIGN OF INTERACTIVE MULTIMEDIA SOFTWARE FOR OTHERS; DESIGN OF COMPUTER PROGRAMS FOR OTHERS (U.S. CLS. 100 AND 101).

SN 76-089,367. CCA INDUSTRIES, INC., EAST RUTHERFORD, NJ. FILED 7-14-2000.

PLUS + WHITE

OWNER OF U.S. REG. NOS. 1,678,046 AND 2,003,498.

CLASS 3—COSMETICS AND CLEANING PREPARATIONS

FOR TOOTHPASTE (U.S. CLS. 1, 4, 6, 50, 51 AND 52). FIRST USE 8-1-1990; IN COMMERCE 8-1-1990.

CLASS 5—PHARMACEUTICALS

FOR TEETH WHITENER GEL; TEETH WHITENING KIT CONSISTING PRIMARILY OF RINSE, TEETH WHITENER GEL AND MOUTH TRAY (U.S. CLS. 6, 18, 44, 46, 51 AND 52). FIRST USE 8-1-1990; IN COMMERCE 8-1-1990.

CLASS 30—STAPLE FOODS

FOR TEETH WHITENING BREATH MINTS (U.S. CL. 46). FIRST USE 3-10-1999; IN COMMERCE 3-10-1999.

SN 76-089,833. DIGITAL SECURITY CONTROLS LTD., CONCORD, ONTARIO, CANADA, FILED 7-14-2000.

Partner
SECURITY PRODUCTS

OWNER OF CANADA REG. NO. 1,043,171, DATED 1-19-2000, EXPIRES 1-19-2010.

NO CLAIM IS MADE TO THE EXCLUSIVE RIGHT TO USE "SECURITY PRODUCTS", APART FROM THE MARK AS SHOWN.

CLASS 9—ELECTRICAL AND SCIENTIFIC APPARATUS

FOR SECURITY DEVICES, NAMELY SECURITY SYSTEMS FOR COMMERCIAL AND DOMESTIC BUILDINGS AND COMPONENTS FOR SECURITY SYSTEMS, NAMELY CONTROL PANELS, MODULES THEREFOR, ANNUNCIATORS, PRINTERS, SENSORS, KEYPADS, AUTOMATIC TELEPHONE DIALERS, SMOKE DETECTORS, MOTION SENSORS, HEAT DETECTORS, FIRE DETECTORS, DOOR SENSORS, CONTACT SENSORS, VIDEO RECORDING DEVICES AND VIDEO DISPLAY DEVICES (U.S. CLS. 21, 23, 26, 36 AND 38).

CLASS 35—ADVERTISING AND BUSINESS

FOR MARKETING SUPPORT SERVICES (U.S. CLS. 100, 101 AND 102).

SN 76-091,796. SUPERDUDES LLC, VENICE, CA. FILED 7-19-2000.

MR. ELECTRIC

NO CLAIM IS MADE TO THE EXCLUSIVE RIGHT TO USE "ELECTRIC", APART FROM THE MARK AS SHOWN.

SN 76-090,363. FAERIE WORKS, INC., PACIFIC PALISADES, CA. FILED 7-17-2000.

PUCK**CLASS 9—ELECTRICAL AND SCIENTIFIC APPARATUS**

FOR COMPUTER GAME CARTRIDGES; COMPUTER GAME CASSETTES; COMPUTER GAME DISCS; COMPUTER GAME PROGRAMS; COMPUTER GAME SOFTWARE; COMPUTER GAME TAPES; STAND ALONE VIDEO GAME MACHINES; VIDEO GAME MACHINES FOR USE WITH TELEVISIONS; VIDEO GAME CARTRIDGES; VIDEO GAME DISCS; VIDEO GAME SOFTWARE; VIDEO GAME TAPE CASSETTES; AND VIRTUAL REALITY GAME SOFTWARE (U.S. CLS. 21, 23, 26, 36 AND 38).

CLASS 16—PAPER GOODS AND PRINTED MATTER

FOR TRADING CARDS, STICKERS, POSTERS, PICTURE BOOKS, COLORING BOOKS, STORY BOOKS, GUIDE BOOKS, PAPER BAGS, PLASTIC BAGS (U.S. CLS. 2, 5, 22, 23, 29, 37, 38 AND 50).

CLASS 16—PAPER GOODS AND PRINTED MATTER

FOR PAPER, PAPER GOODS AND PRINTED MATTER, NAMELY, BOOK COVERS; PLAYING CARDS; TRADING CARDS; STATIONERY; CALENDARS; COLORING BOOKS; PICTURE BOOKS; CHILDREN'S ACTIVITY BOOKS; MOUNTED PHOTOGRAPHS; UNMOUNTED PHOTOGRAPHS; PHOTOGRAPHIC PRINTS; CHILDREN'S BOOKS; COMIC BOOKS; ERASERS; MEMO PADS; NOTEBOOKS; PAPER NAPKINS; PAPER HATS; PENS; PENCILS; PICTURE STORYBOOKS; POSTERS; RING BINDERS; SCRATCH PADS; STICKERS AND STICKER ALBUMS (U.S. CLS. 2, 5, 22, 23, 29, 37, 38 AND 50).

CLASS 28—TOYS AND SPORTING GOODS

FOR DOLLS, DOLL CLOTHING AND DOLL ACCESSORIES (U.S. CLS. 22, 23, 38 AND 50).

CLASS 41—EDUCATION AND ENTERTAINMENT

FOR ENTERTAINMENT SERVICES, NAMELY, MOTION PICTURE PRODUCTION AND ENTERTAINMENT SERVICES IN THE NATURE OF A TELEVISION SERIES FEATURING FAIRIES; EDUCATION AND ENTERTAINMENT SERVICES IN THE NATURE OF PROVIDING INFORMATION VIA A GLOBAL COMPUTER NETWORK FEATURING FAIRIES (U.S. CLS. 100, 101 AND 107).

CLASS 28—TOYS AND SPORTING GOODS

FOR TOYS, GAMES AND PLAYTHINGS, NAMELY, GAMES PLAYABLE INTERACTIVELY OR INDIVIDUALLY ON A PROPRIETARY GAMING SYSTEM; DOLLS; PLUSH DOLLS; PLUSH TOYS; ACTION FIGURES; ACTION FIGURE ACCESSORIES; TOY MODEL VEHICLES; RADIO CONTROLLED MODEL VEHICLES; TOY MODEL HOBBYCRAFT KITS; HAND HELD UNIT FOR PLAYING ELECTRONIC GAMES; HAND HELD UNIT FOR PLAYING VIDEO GAMES; HAND HELD UNIT FOR WIRELESS GAMING; JIGSAW PUZZLES; INFLATABLE BOP BAGS; BOARD GAMES; PLAY FIGURES; NON-ELECTRIC HAND-HELD SKILL GAMES; TOY BALLOONS; YO-YOS; BEAN BAGS; KITES; PUPPETS; TOY BANKS; TOY PIGGY BANKS; TOY VEHICLES; AND TOY WHISTLES (U.S. CLS. 22, 23, 38 AND 50).

SN 76-091,453. TILIA INTERNATIONAL, INC., TAI KOK TSUI, KOWLOON, HONG KONG, FILED 7-18-2000.

FOODSAVER

OWNER OF U.S. REG. NOS. 1,422,539 AND 2,039,276.

CLASS 16—PAPER GOODS AND PRINTED MATTER

FOR PLASTIC VACUUM PACKAGING BAGS AND ROLLS FOR HOUSEHOLD USE (U.S. CLS. 2, 5, 22, 23, 29, 37, 38 AND 50).
FIRST USE 11-1-1985; IN COMMERCE 2-1-1986.

SN 76-093,464. ISOTIS B.V., MB BILTHOVEN, NETHERLANDS, FILED 7-12-2000.

CLASS 20—FURNITURE AND ARTICLES NOT OTHERWISE CLASSIFIED

FOR BOTTLE STOPPERS NOT OF METAL FOR HOUSEHOLD USE (U.S. CLS. 2, 13, 22, 25, 32 AND 50).
FIRST USE 2-0-1987; IN COMMERCE 12-31-1994.

CREATOS

PRIORITY CLAIMED UNDER SEC. 44(D) ON BENELUX APPLICATION NO. 0946882, FILED 9-24-1999, REG. NO. 0659513, DATED 9-24-1999, EXPIRES 9-24-2009.

CLASS 21—HOUSEWARES AND GLASS

FOR PLASTIC VACUUM PACKAGING CONTAINERS WITH LIDS, AND CANISTERS WITH LIDS, FOR HOUSEHOLD USE (U.S. CLS. 2, 13, 23, 29, 30, 33, 40 AND 50).
FIRST USE 2-0-1987; IN COMMERCE 2-0-1987.

CLASS 1—CHEMICALS

FOR CALCIUM PHOSPHATE FOR USE IN THE MANUFACTURE OF SYNTHETIC BONE, PROSTHESES AND SYNTHETIC BONE FILLING PREPARATIONS (U.S. CLS. 1, 5, 6, 10, 26 AND 46).

CLASS 5—PHARMACEUTICALS

FOR NATURAL BONE FILLING PREPARATIONS, CALCIUM PHOSPHATE COATING FOR USE AS AN ADDITIVE TO SYNTHETIC BONE FILLING PREPARATIONS (U.S. CLS. 6, 18, 44, 46, 51 AND 52).

SN 76-095,951. WESTERN ALPS FOUNDATION, GRAND CAYMAN, CAYMAN ISLANDS, FILED 7-25-2000.

INTERNETMILK**CLASS 10—MEDICAL APPARATUS**

FOR ARTIFICIAL TISSUE AND BONE CONTAINING PHARMACEUTICAL PREPARATIONS SUCH AS GROWTH STIMULANTS OR ANTIBIOTICS AND ARTIFICIAL TISSUE AND BONE WITHOUT PHARMACEUTICAL PREPARATION; ARTIFICIAL BONE FILLING PREPARATIONS; CALCIUM PHOSPHATE COATING SOLD AS AN INTEGRAL COMPONENT OF SYNTHETIC BONE AND PROSTHESES (U.S. CLS. 26, 39 AND 44).

CLASS 29—MEATS AND PROCESSED FOODS

FOR FISH, GAME; MEAT; POULTRY; MEAT EXTRACTS; COOKED, DRIED AND PRESERVED FRUITS AND VEGETABLES; JELLIES; JAMS; FRUIT SAUCES; EGGS; DAIRY PRODUCTS EXCLUDING ICE CREAMS, ICE MILK AND FROZEN YOGURT; EDIBLE OILS AND FATS (U.S. CL. 46).

CLASS 30—STAPLE FOODS

FOR ICE CREAM; ICE MILK; FROZEN YOGURT; BAKERY DESSERTS; COFFEE AND COFFEE SUBSTITUTES; TEA; COCOA; SUGAR; RICE; TAPIOCA; SAGO; TAPIOCA; SAGO; FLOUR; PROCESSED CEREALS; CEREAL-BASED SNACK FOOD; BREAD; PASTRIES; FROZEN CONFECTIONS; FLAVORED ICES; CANDY; HONEY; TREACLE; YEAST; BAKING POWDER; SPICES; SALT; MUSTARD; VINEGAR; ICE; SAUCES; FOOD PACKAGE COMBINATIONS CONSISTING OF BREAD, COOKIES AND/OR CRACKERS (U.S. CL. 46).

SN 76-093,494. SARAH SPENCER LIMITED, HALE CHESHIRE WA14 2UW, ENGLAND, FILED 7-12-2000.

SNOOZZEEE DOG

NO CLAIM IS MADE TO THE EXCLUSIVE RIGHT TO USE "DOG", APART FROM THE MARK AS SHOWN.

CLASS 20—FURNITURE AND ARTICLES NOT OTHERWISE CLASSIFIED

FOR PORTABLE BEDS FOR ANIMALS; PILLOWS FOR USE AS BEDDING FOR ANIMALS; PILLOWS; SLEEPING BAGS; DOG KENNELS; KENNELS FOR HOUSEHOLD PETS; FURNITURE, MIRRORS AND PICTURE FRAMES; TOY CHESTS; CHESTS OF DRAWERS; DRINKING STRAWS; BONE, IVORY, PLASTER, PLASTIC, WAX, WOOD, AND FABRIC ORNAMENTAL FIGURINES OF ANIMALS AND HUMANS; WALL PLAQUES; BONE, IVORY, PLASTER, PLASTIC, WAX, WOOD AND FABRIC ORNAMENTAL STATUETTES OF ANIMALS AND HUMANS; PARTS AND FITTINGS FOR THE AFORESAID GOODS (U.S. CLS. 2, 13, 22, 25, 32 AND 50).

SN 76-096,068. OVATION GROUP, INC., ALPHARETTA, GA. FILED 7-25-2000.

CLASS 24—FABRICS

FOR QUILTS BLANKETS AND DUVETS ALL PROVIDING BEDDING FOR ANIMALS; QUILTS, BLANKETS AND DUVETS (U.S. CLS. 42 AND 50).

SN 76-095,734. CUBATEC, LNC., CORAL GABLES, FL. FILED 7-24-2000.

BUILDING THE CUBA OF TOMORROW TODAY**CLASS 35—ADVERTISING AND BUSINESS**

FOR BUSINESS CONSULTATION SERVICES, NAMELY, CONSULTATION REGARDING STRATEGIC PLANNING, MARKET ANALYSIS, CONCEPT AND TECHNOLOGY ASSESSMENT, AND ADVERTISING STRATEGIES CONCERNING CUBA (U.S. CLS. 100, 101 AND 102).

CLASS 1—CHEMICALS

FOR FERTILIZERS AND SOIL CONDITIONERS FOR AGRICULTURAL, HORTICULTURAL, OR DOMESTIC USE; GROWING MEDIA FOR PLANTS, NAMELY, WATER-ABSORBING POLYMERS FOR CONSERVING WATER AND GERMINATING SEEDS (U.S. CLS. 1, 5, 6, 10, 26 AND 46).
FIRST USE 2-28-2000; IN COMMERCE 6-28-2000.

CLASS 36—INSURANCE AND FINANCIAL

FOR FINANCIAL SERVICES IN THE NATURE OF VENTURE CAPITAL INVESTMENTS IN EMERGING ENTERPRISES AND CAPITAL FINANCING CONSULTATION CONCERNING CUBA (U.S. CLS. 100, 101 AND 102).

CLASS 5—PHARMACEUTICALS

FOR NATURAL INSECTICIDES FOR AGRICULTURAL, HORTICULTURAL OR DOMESTIC USE (U.S. CLS. 6, 18, 44, 46, 51 AND 52).
FIRST USE 2-28-2000; IN COMMERCE 6-28-2000.



SN 76-096,555. CISCO TECHNOLOGY, INC., SAN JOSE, CA. BY MERGER; BY ASSIGNMENT VOVIDA NETWORKS, INC., SAN JOSE, CA. FILED 7-11-2000.

THE GLOBAL PIONEER IN OPEN SOURCE TELEPHONY

CLASS 9—ELECTRICAL AND SCIENTIFIC APPARATUS

FOR TELECOMMUNICATIONS EQUIPMENT, NAMELY, COMPUTER BASED TELEPHONY SWITCH AND COMPUTER SOFTWARE FOR USE IN TELEPHONE SWITCHING, MANAGEMENT OF VOICE MAIL, AUTOMATION OF ANSWERING, MESSAGING AND TRANSFERRING CALLS, AUTOMATION OF CALL DISTRIBUTION, CONTROL OF COMPUTER NETWORK ACCESS TO TELEPHONE SYSTEMS, AND CONTROL OF ALL TELEPHONE OPERATIONS (U.S. CLS. 21, 23, 26, 36 AND 38).

CLASS 38—COMMUNICATION

FOR TELECOMMUNICATIONS SERVICES, NAMELY, PROVIDING TELECOMMUNICATIONS CONNECTIONS TO ELECTRONIC COMMUNICATIONS NETWORKS; TELECOMMUNICATION SERVICES, NAMELY ELECTRONIC TRANSMISSION OF VOICE, VIDEO, MESSAGES AND DATA; IP TELEPHONY SERVICES; ASYNCHRONOUS TRANSFER MODE SERVICES; PROVIDING FRAME RELAY CONNECTIVITY SERVICES FOR TELEPHONY DATA TRANSFER; INTERNATIONAL CALL BACK SERVICES; PROVIDING TELECOMMUNICATIONS CONNECTIONS TO A GLOBAL COMPUTER NETWORK; VIDEO CONFERENCING SERVICES; CONSULTATION SERVICES IN THE FIELD OF TELECOMMUNICATIONS (U.S. CLS. 100, 101 AND 104).

CLASS 42—SCIENTIFIC, COMPUTER AND LEGAL SERVICES

FOR INTEGRATION OF COMPUTER SYSTEMS AND NETWORKS (U.S. CLS. 100 AND 101).

SN 76-096,856. GIANTLOOP NETWORK, INC., WALTHAM, MA. FILED 7-26-2000.

GIANTLOOP

CLASS 38—COMMUNICATION

FOR TELECOMMUNICATIONS SERVICES AND FIBER OPTIC NETWORK SERVICES, NAMELY, PROVIDING MULTIPLE-USER ACCESS TO A GLOBAL COMPUTER INFORMATION NETWORK (U.S. CLS. 100, 101 AND 104).

CLASS 42—SCIENTIFIC, COMPUTER AND LEGAL SERVICES

FOR CONSULTING SERVICES IN THE FIELD OF TELECOMMUNICATIONS AND COMPUTER NETWORKS (U.S. CLS. 100 AND 101).

SN 76-096,937. PAMPERED CHEF, LTD., THE, ADDISON, IL. FILED 7-26-2000.

KITCHEN SHOWCASE

NO CLAIM IS MADE TO THE EXCLUSIVE RIGHT TO USE "KITCHEN", APART FROM THE MARK AS SHOWN.

CLASS 8—HAND TOOLS

FOR HAND OPERATED HAND TOOLS AND IMPLEMENTS, NAMELY, KITCHEN KNIVES, NON-ELECTRIC FRUIT AND VEGETABLE PEELERS, HAND OPERATED FOOD SLICERS AND CHOPPERS, CHEESE SLICERS, EGG SLICERS, PIZZA CUTTERS, NON-ELECTRIC CAN OPENERS, FRUIT ZESTERS, FRUIT SCORERS, FRUIT AND VEGETABLE CORERS, SCISSORS, GARNISHERS, KNIFE SHARPENERS, WEDGERS, MANUALLY OPERATED ICE SHAVERS, TONGS, FORKS, CUTLERY, NAMELY, STEAK KNIVES (U.S. CLS. 23, 28 AND 44).

FIRST USE 3-1-1998; IN COMMERCE 3-1-1998.

CLASS 9—ELECTRICAL AND SCIENTIFIC APPARATUS

FOR PRE-RECORDED AUDIO AND VIDEO CASSETTES FEATURING COOKING; FOOD THERMOMETERS; MEASURING SPOONS; MEASURING CUPS; FOOD SCALES; KITCHEN TIMERS (U.S. CLS. 21, 23, 26, 36 AND 38).

FIRST USE 3-1-1998; IN COMMERCE 3-1-1998.

CLASS 16—PAPER GOODS AND PRINTED MATTER

FOR COOKBOOKS; CATALOGS AND BROCHURES FEATURING HOUSEHOLD AND KITCHEN UTENSILS AND RECIPES; PRINTED RECIPES ON CARDS; PARCHMENT PAPER (U.S. CLS. 2, 5, 22, 23, 29, 37, 38 AND 50).

FIRST USE 3-1-1998; IN COMMERCE 3-1-1998.

CLASS 21—HOUSEWARES AND GLASS

FOR CONTAINERS FOR HOUSEHOLD AND KITCHEN USE; HOUSEHOLD AND KITCHEN UTENSILS, NAMELY, GARLIC PRESSES, EGG SEPARATORS, TART CUTTERS, CAKE TESTERS, GRATERS, ONION HOLDERS, FOOD AND PASTRY BRUSHES, PASTRY WHEELS, FOOD DECORATING TUBES AND TIPS, POT AND PAN SCRAPERS, FOOD SCRAPERS, SPATULAS, SCOOPS, SPOONS, NAMELY, MIXING, SERVING AND SLOTTED SPOONS, FOOD MASHERS, KITCHENS LADLES, WHISKS, WHIPS FOR WHIPPING FOOD, TURNERS, DOUGH ROLLING PINS, COOKIE DROPPERS; CUTTING BOARDS; PASTRY BOARDS; JAR OPENERS; BOIL CONTROL DISKS PLACED AT THE BOTTOM OF POTS TO PREVENT SPILLOVERS; CORN COB HOLDERS; CORN BUTTERERS; FOOD SHAKERS; PITCHERS; BOWL; SERVING PLATTERS; COOKWARE, NAMELY, POTS, PANS, POT LIDS AND COVERS; CROCKS; BAKEWARE, NAMELY, FOOD MOLDS, BREAD MOLDS; BAKING RACKS; COOLING RACKS; SPRING FORM PANS; MUFFIN PANS, BAKING SHEETS; PIE PANS; PIE PLATES; CAKE PANS; LOAF PANS; TRIVETS, SALT MILLS; PEPPER MILLS; KITCHEN TOOL ORGANIZERS, NAMELY, CONTAINERS FOR ORGANIZING HOUSEHOLD AND KITCHEN UTENSILS; SOAP DISPENSERS; FOOD STRAINERS; STONEWARE, NAMELY, BOWLS, PIE PLATES, PANS, CAKE PANS AND ROASTERS, BAKING DISHES, BAKING STONES; BAKING PANS ROASTERS; PLATES; CORK-SCREWS; NON-ELECTRIC PASTRY BLENDERS; COLANDERS FOR HOUSEHOLD USE; NON-ELECTRIC JUICERS; PASTRY CUTTERS (U.S. CLS. 2, 13, 23, 29, 30, 33, 40 AND 50).

FIRST USE 3-1-1998; IN COMMERCE 3-1-1998.

CLASS 24—FABRICS

FOR OVEN MITTS; HOT MITTS; POT HOLDERS (U.S. CLS. 42 AND 50).

FIRST USE 3-1-1998; IN COMMERCE 3-1-1998.

CLASS 30—STAPLE FOODS

FOR SPECIALITY FOOD ITEMS, NAMELY, VINEGARS, CAKE MIXES, MIXES FOR MAKING BAKERY GOODS, SPICES, SEASONINGS, EXTRACTS USED AS FOOD FLAVORINGS, SAUCES, SALSAS, SALAD DRESSINGS; PREPARATIONS FOR MAKING COFFEE, TEA AND COCOA; COFFEE (U.S. CL. 46).
FIRST USE 3-1-1998; IN COMMERCE 3-1-1998.

CLASS 35—ADVERTISING AND BUSINESS

FOR SHOP-AT-HOME PARTY SERVICE IN THE FIELD OF HOUSEWARES, HOUSEHOLD AND KITCHEN UTENSILS, KITCHEN HAND TOOLS AND IMPLEMENTS, PRINTED MATTER, NAMELY, COOKBOOKS AND PRINTED RECIPES ON CARDS, PRE-RECORDED VIDEO TAPES AND FOOD (U.S. CLS. 100, 101 AND 102).
FIRST USE 3-1-1998; IN COMMERCE 3-1-1998.

SN 76-097,930. ARMAMENT SYSTEMS AND PROCEDURES, INC., APPLETON, WI. FILED 7-24-2000.

ASP

CLASS 11—ENVIRONMENTAL CONTROL APPARATUS

FOR FLASHLIGHTS (U.S. CLS. 13, 21, 23, 31 AND 34).
FIRST USE 10-0-1996; IN COMMERCE 10-0-1996.

CLASS 13—FIREARMS

FOR PERSONAL SAFETY DEFENSE PRODUCTS, NAMELY PROJECTING DISPENSERS CONTAINING CHEMICAL IRRITANT (U.S. CLS. 2 AND 9).
FIRST USE 10-0-1994; IN COMMERCE 10-0-1994.

SN 76-099,338. RINGTAIL SOLUTIONS PTY LIMITED, MELBOURNE, VIC 2300, AUSTRALIA, FILED 7-28-2000.

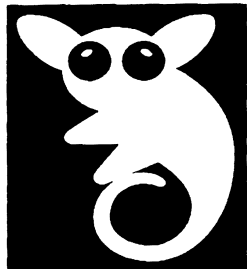
**CLASS 9—ELECTRICAL AND SCIENTIFIC APPARATUS**

FOR COMPUTER SOFTWARE, NAMELY SOFTWARE USED FOR ENABLING DOCUMENT EXCHANGE, ELECTRONIC FILE MAINTENANCE AND COMMUNICATIONS ON AN EXTRANET (U.S. CLS. 21, 23, 26, 36 AND 38).

CLASS 35—ADVERTISING AND BUSINESS

FOR BUSINESS CONSULTATION FOR ENTERPRISES, BUSINESS AND GOVERNMENT ORGANIZATIONS CONCERNING WAYS TO IMPROVE INFORMATION EXCHANGE AND COMMUNICATION; ELECTRONIC MANAGEMENT OF FILES AND DOCUMENTS VIA INTRANETS, EXTRANETS, INTERNET OR OTHER PUBLIC OR PRIVATE NETWORKS (U.S. CLS. 100, 101 AND 102).

CLASS 38—COMMUNICATION

FOR TELECOMMUNICATION SERVICES, NAMELY ELECTRONIC TRANSMISSION OF FILES AND DOCUMENTS VIA INTRANETS, EXTRANETS, INTERNET OR OTHER PUBLIC OR PRIVATE NETWORKS (U.S. CLS. 100, 101 AND 104).

CLASS 42—SCIENTIFIC, COMPUTER AND LEGAL SERVICES

FOR COMPUTER PROGRAMMING, COMPUTER DESIGN SERVICES, AND CONSULTATION IN THE FIELD OF COMPUTER SOFTWARE, COMPUTER DATA MANAGEMENT AND COMPUTER-ASSISTED LITIGATION SUPPORT (U.S. CLS. 100 AND 101).

SN 76-099,339. RINGTAIL SOLUTIONS PTY LIMITED, MELBOURNE, VIC 2300, AUSTRALIA, FILED 7-28-2000.

RINGTAIL

CLASS 9—ELECTRICAL AND SCIENTIFIC APPARATUS

FOR COMPUTER SOFTWARE, NAMELY SOFTWARE USED FOR ENABLING DOCUMENT EXCHANGE, ELECTRONIC FILE MAINTENANCE AND COMMUNICATIONS ON AN EXTRANET (U.S. CLS. 21, 23, 26, 36 AND 38).

CLASS 35—ADVERTISING AND BUSINESS

FOR BUSINESS CONSULTATION FOR ENTERPRISES, BUSINESS AND GOVERNMENT ORGANIZATIONS CONCERNING WAYS TO IMPROVE INFORMATION EXCHANGE AND COMMUNICATION; ELECTRONIC MANAGEMENT OF FILES AND DOCUMENTS VIA INTRANETS, EXTRANETS, INTERNET OR OTHER PUBLIC OR PRIVATE NETWORKS (U.S. CLS. 100, 101 AND 102).

CLASS 38—COMMUNICATION

FOR TELECOMMUNICATION SERVICES, NAMELY ELECTRONIC TRANSMISSION OF FILES AND DOCUMENTS VIA INTRANETS, EXTRANETS, INTERNET OR OTHER PUBLIC OR PRIVATE NETWORKS (U.S. CLS. 100, 101 AND 104).

CLASS 42—SCIENTIFIC, COMPUTER AND LEGAL SERVICES

FOR COMPUTER PROGRAMMING, COMPUTER DESIGN SERVICES, AND CONSULTATION IN THE FIELD OF COMPUTER SOFTWARE, COMPUTER DATA MANAGEMENT AND COMPUTER-ASSISTED LITIGATION SUPPORT (U.S. CLS. 100 AND 101).

SN 76-099,389. MYND CORPORATION, BLYTHEWOOD, SC. BY CHANGE OF NAME POLICY MANAGEMENT SYSTEMS CORPORATION, DBA MYND CORPORATION, BLYTHEWOOD, SC. FILED 7-28-2000.

VIAMYND.NET

CLASS 9—ELECTRICAL AND SCIENTIFIC APPARATUS

FOR COMPUTER SOFTWARE, NAMELY, DATA MANAGEMENT AND ANALYSIS PROGRAMS DIRECTED TO THE INSURANCE AND FINANCIAL SERVICE COMPANIES AND RELATED ENTITIES (U.S. CLS. 21, 23, 26, 36 AND 38).

CLASS 42—SCIENTIFIC, COMPUTER AND LEGAL SERVICES

FOR COMPUTER SOFTWARE SERVICES FOR OTHERS, NAMELY, SOFTWARE DESIGN AND CUSTOMIZATION FOR INSURANCE AND FINANCIAL SERVICES COMPANIES AND RELATED ENTITIES; COMPUTER SOFTWARE CONSULTATION; COMPUTER SERVICES, NAMELY, PROVIDING TEMPORARY USE OF ON-LINE NON-DOWNLOADABLE SOFTWARE TO INSURANCE AND FINANCIAL SERVICES COMPANIES AND RELATED ENTITIES FOR USE WITH DATA MANAGEMENT VIA A GLOBAL INFORMATION NETWORK; PROVIDING INFORMATION TO INSURANCE, FINANCIAL SERVICES COMPANIES AND OTHER RELATED COMPANIES PERTAINING TO THE FUNCTIONS, BENEFITS, AND APPLICATIONS OF COMPUTER SOFTWARE VIA A GLOBAL COMPUTER NETWORK (U.S. CLS. 100 AND 101).

SN 76-099,390. MYND CORPORATION, BLYTHEWOOD, SC. BY CHANGE OF NAME POLICY MANAGEMENT SYSTEMS CORPORATION, DBA MYND CORPORATION, BLYTHEWOOD, SC. FILED 7-28-2000.

VIAMYND.COM

CLASS 9—ELECTRICAL AND SCIENTIFIC APPARATUS

FOR COMPUTER SOFTWARE, NAMELY, DATA MANAGEMENT AND ANALYSIS PROGRAMS DIRECTED TO THE INSURANCE AND FINANCIAL SERVICE COMPANIES AND RELATED ENTITIES (U.S. CLS. 21, 23, 26, 36 AND 38).

CLASS 42—SCIENTIFIC, COMPUTER AND LEGAL SERVICES

FOR COMPUTER SOFTWARE SERVICES FOR OTHERS, NAMELY, SOFTWARE DESIGN AND CUSTOMIZATION FOR INSURANCE AND FINANCIAL SERVICES COMPANIES AND RELATED ENTITIES; COMPUTER SOFTWARE CONSULTATION; COMPUTER SERVICES, NAMELY, PROVIDING TEMPORARY USE OF ON-LINE NON-DOWNLOADABLE SOFTWARE TO INSURANCE AND FINANCIAL SERVICES COMPANIES AND RELATED ENTITIES FOR USE WITH DATA MANAGEMENT VIA A GLOBAL INFORMATION NETWORK; PROVIDING INFORMATION TO INSURANCE, FINANCIAL SERVICES COMPANIES AND OTHER RELATED COMPANIES PERTAINING TO THE FUNCTIONS, BENEFITS, AND APPLICATIONS OF COMPUTER SOFTWARE VIA A GLOBAL COMPUTER NETWORK (U.S. CLS. 100 AND 101).

SN 76-100,188. RAVI, KUMAR, EDGEWATER, NJ. AND SHERMAN, WARREN, EDGEWATER, NJ. FILED 7-31-2000.

NEWYORKHEART

CLASS 35—ADVERTISING AND BUSINESS

FOR PHYSICIAN REFERRAL SERVICES VIA A GLOBAL NETWORK OF COMPUTERS (U.S. CLS. 100, 101 AND 102).

CLASS 42—SCIENTIFIC, COMPUTER AND LEGAL SERVICES

FOR PROVIDING GENERAL MEDICAL AND HEALTH CARE RELATED INFORMATION VIA A GLOBAL NETWORK OF COMPUTERS; PROVIDING MEDICAL CONSULTATION SERVICES WITH MEDICAL CARE PROVIDERS AND PHYSICIANS VIA A GLOBAL NETWORK OF COMPUTERS (U.S. CLS. 100 AND 101).

SN 76-100,239. AMES TRUE TEMPER, PROPERTIES, INC., CAMP HILL, PA. BY ASSIGNMENT AMES TRUE TEMPER, INC., CAMP HILL, PA. FILED 8-1-2000.

AMES TRUE TEMPER

OWNER OF U.S. REG. NOS. 260,024, 2,205,580 AND OTHERS.

CLASS 8—HAND TOOLS

FOR HAND-OPERATED LAWN AND GARDEN TOOLS, NAMELY RAKES, HOES, DIGGING FORKS, GARDEN CULTIVATORS, A COMBINATION CULTIVATOR-HOE, EDGERS, POST HOLE DIGGERS, COMPOST FORKS, SHOVELS AND SPADES (U.S. CLS. 23, 28 AND 44).

CLASS 20—FURNITURE AND ARTICLES NOT OTHERWISE CLASSIFIED

FOR HAND-OPERATED NON-METAL GARDEN HOSE REELS (U.S. CLS. 2, 13, 22, 25, 32 AND 50).

SN 76-101,686. LONELY PLANET PUBLICATIONS PTY LIMITED, HAWTHORN, VICTORIA 3122, AUSTRALIA, FILED 8-1-2000.

WorldSync

CLASS 9—ELECTRICAL AND SCIENTIFIC APPARATUS

FOR COMPUTER SOFTWARE FOR USE WITH HAND-HELD COMPUTERS THAT RETRIEVE, STORE, ORGANIZE AND DISPLAY INFORMATION ABOUT TRAVEL, RESTAURANTS, ACCOMMODATION AND MAPS (U.S. CLS. 21, 23, 26, 36 AND 38).

CLASS 39—TRANSPORTATION AND STORAGE

FOR TRAVEL INFORMATION PROVIDED ON-LINE FROM DATABASES OR FROM THE INTERNET (U.S. CLS. 100 AND 105).

SN 76-103,797. MEMETRICS INC., WILMINGTON, DE. FILED 8-4-2000.



SN 76-103,707. UNCLE BEN'S, INC., HOUSTON, TX. FILED 8-3-2000.

BRANDS THAT BUILD

CLASS 29—MEATS AND PROCESSED FOODS

FOR POTATO SIDE DISHES; FROZEN ENTREES CONSISTING OF MEAT AND PROCESSED VEGETABLES (U.S. CL. 46).

CLASS 30—STAPLE FOODS

FOR RICE, RICE MIXES, PASTA MIXES AND SAUCES; CONFECTIONERY PRODUCTS, NAMELY, CANDY; FROZEN ENTREES CONSISTING OF MEAT, RICE, PASTA AND/OR SAUCE (U.S. CL. 46).

CLASS 35—ADVERTISING AND BUSINESS

FOR DISTRIBUTORSHIP SERVICES IN THE FIELD OF FOOD AND ITEMS RELATED TO THE FOOD SERVICE INDUSTRY (U.S. CLS. 100, 101 AND 102).

CLASS 42—SCIENTIFIC, COMPUTER AND LEGAL SERVICES

FOR PROVIDING INFORMATION BY WAY OF AN ON-LINE COMPUTER DATABASE REGARDING FOOD PRODUCTS, FOOD PREPARATION AND FOOD SERVICE TO THE FOOD SERVICE INDUSTRY (U.S. CLS. 100 AND 101).

CLASS 9—ELECTRICAL AND SCIENTIFIC APPARATUS

FOR COMPUTER SOFTWARE FOR TRACKING ON-LINE BEHAVIOR AND ACTIVITIES OF USERS OF ELECTRONIC COMMUNICATIONS NETWORKS; COMPUTER SOFTWARE FOR DIRECTING INFORMATIONAL CONTENT TO ONLINE USERS BASED ON USER PROFILES, ACTIVITIES AND BEHAVIOR; COMPUTER SOFTWARE FOR PROVIDING OTHERS WITH INFORMATION ABOUT USER BEHAVIOR, ACTIVITIES, AND PROFILES; COMPUTER SOFTWARE FOR CUSTOMIZING PRODUCT OFFERINGS FOR ONLINE PRESENTATION; COMPUTER SOFTWARE FOR DESIGNING CUSTOMER SERVICE BY IDENTIFYING PREFERENCES OF CUSTOMERS FROM VARIABLE CUSTOMER SERVICE FEATURES OR OPTIONS PRESENTED TO CUSTOMERS; COMPUTER SOFTWARE FOR PRODUCT DEVELOPMENT; COMPUTER SOFTWARE FOR DESIGN OF PRODUCTS BY IDENTIFYING CUSTOMER PRODUCT PREFERENCES FROM VARIABLE FEATURES OR OPTIONS PRESENTED TO CUSTOMERS; COMPUTER SOFTWARE FOR OPTIMIZING PRODUCT MARKETING BY IDENTIFYING PREFERENCES OF CUSTOMERS FROM VARIABLE MARKETING FEATURES OR OPTIONS PRESENTED TO CUSTOMERS; COMPUTER SOFTWARE FOR DESIGNING PRODUCT FULFILLMENT BY IDENTIFYING PREFERENCES OF CUSTOMERS FROM VARIABLE PRODUCT FULFILLMENT FEATURES OR OPTIONS PRESENTED TO CUSTOMERS; COMPUTER SOFTWARE FOR INTERACTIVE MANAGEMENT OF ONLINE CONTENT; COMPUTER SOFTWARE FOR ONLINE TARGET MARKETING; AND COMPUTER SOFTWARE FOR FACILITATION OF COMMUNICATIONS BETWEEN ONLINE BUYERS AND SELLERS (U.S. CLS. 21, 23, 26, 36 AND 38).

FIRST USE 3-0-2000; IN COMMERCE 3-0-2000.

CLASS 35—ADVERTISING AND BUSINESS

FOR MARKET RESEARCH SERVICES, NAMELY TRACKING AND PROFILING ONLINE BEHAVIOR AND ACTIVITIES OF USERS OF ELECTRONIC COMMUNICATIONS NETWORKS; DISSEMINATION OF ADVERTISING AND PROMOTIONS FOR OTHERS, NAMELY DIRECTING INFORMATIONAL CONTENT TO ONLINE USERS BASED ON USER PROFILES, ACTIVITIES AND BEHAVIOR; BUSINESS MARKETING CONSULTING SERVICES, NAMELY PROVIDING OTHERS WITH INFORMATION ABOUT ONLINE USER PROFILES, ACTIVITIES AND BEHAVIORS; PREPARING ADVERTISEMENTS AND PROMOTIONS FOR OTHERS, NAMELY CUSTOMIZATION OF PRODUCT OFFERINGS; DESIGNING CUSTOMER SERVICE BY IDENTIFYING PREFERENCES OF CUSTOMERS FROM VARIABLE CUSTOMER SERVICE FEATURES OR OPTIONS PRESENTED TO CUSTOMERS; OPTIMIZING PRODUCT MARKETING BY IDENTIFYING PREFERENCES OF CUSTOMERS FROM VARIABLE MARKETING FEATURES OR OPTIONS PRESENTED TO CUSTOMERS; DESIGNING PRODUCT FULFILLMENT BY IDENTIFYING PREFERENCES OF CUSTOMERS FROM VARIABLE PRODUCT FULFILLMENT FEATURES OR OPTIONS PRESENTED TO CUSTOMERS; DISSEMINATION OF ADVERTISING MATERIAL FOR

OTHERS VIA AN ELECTRONIC COMMUNICATIONS NETWORK ACCORDING TO ONLINE USER PROFILING; AND DISSEMINATION OF ONLINE TARGETED ADVERTISING FOR OTHERS VIA AN ELECTRONIC COMMUNICATIONS NETWORK; BUSINESS CONSULTING SERVICES; MARKET RESEARCH SERVICES, NAMELY WEBSITE TRAFFIC MONITORING AND USER PROFILING; MARKET RESEARCH, DESIGN, STATISTICAL ANALYSIS, AND STRATEGIC MARKETING; RESEARCH AND ANALYSIS OF ONLINE CONSUMER BEHAVIOR; AND LICENSING OF COMPUTER SOFTWARE (U.S. CLS. 100, 101 AND 102).

FIRST USE 3-0-2000; IN COMMERCE 3-0-2000.

CLASS 42—SCIENTIFIC, COMPUTER AND LEGAL SERVICES

FOR DESIGNING COMPUTER SOFTWARE FOR OTHERS; AND COMPUTER SERVICES, NAMELY DESIGNING AND IMPLEMENTING NETWORK WEBSITE FEATURES FOR OTHERS; WEBSITE TRAFFIC MONITORING; CREATING AND MAINTAINING WEBSITES FOR OTHERS; CREATING WEBSITES FOR OTHERS, NAMELY CUSTOMIZATION OF ONLINE CONTENT ACCORDING TO USER PROFILING; AND PRODUCT DEVELOPMENT; DESIGN OF PRODUCTS BY IDENTIFYING CUSTOMER PRODUCT PREFERENCES FROM VARIABLE FEATURES OR OPTIONS PRESENTED TO CUSTOMERS (U.S. CLS. 100 AND 101).

FIRST USE 3-0-2000; IN COMMERCE 3-0-2000.

SN 76-103,905. FX ALLIANCE, LLC, NEW YORK, NY. BY ASSIGNMENT J.P. MORGAN & CO. INCORPORATED, NEW YORK, NY. FILED 8-4-2000.

FXALL

CLASS 9—ELECTRICAL AND SCIENTIFIC APPARATUS

FOR COMPUTER SOFTWARE FOR CURRENCY EXCHANGE TRANSACTIONS, INCLUDING THE ELECTRONIC PROCESSING, EXECUTION AND SETTLEMENT OF ORDERS; COMPUTER SOFTWARE FOR EXCHANGE RATE RESEARCH AND ANALYSIS (U.S. CLS. 21, 23, 26, 36 AND 38).

CLASS 36—INSURANCE AND FINANCIAL

FOR FINANCIAL CLEARING HOUSE SERVICES, NAMELY, THE FACILITATION OF CURRENCY EXCHANGE TRANSACTIONS AND EXCHANGE RATE RESEARCH AND ANALYSIS; CONSULTATION IN THE FIELD OF CURRENCY EXCHANGE; ELECTRONIC PROCESSING, EXECUTION AND SETTLEMENT OF ORDERS FOR CURRENCY EXCHANGE AND SECURITIES TRANSACTIONS (U.S. CLS. 100, 101 AND 102).

CLASS 42—SCIENTIFIC, COMPUTER AND LEGAL SERVICES

FOR COMPUTER SOFTWARE CONSULTATION AND TECHNICAL SUPPORT SERVICES IN THE FIELD OF CURRENCY EXCHANGE, RESEARCH AND PLATFORMS FOR CONDUCTING BUSINESSES IN CONNECTION THEREWITH (U.S. CLS. 100 AND 101).

SN 76-105,447. J. D COMPONENTS CO., LTD., CHANG HUA HSIEN, TAIWAN, FILED 8-8-2000.

CITYBUG

CLASS 25—CLOTHING

FOR ARTICLES OF SPORTS AND LEISURE CLOTHING, NAMELY, COATS, JACKETS, SHIRTS, TROUSERS, SWEATERS, NECKTIES, BELTS, HEADWEAR, GLOVES, SOCKS, AND FOOTWEAR (U.S. CLS. 22 AND 39).

CLASS 28—TOYS AND SPORTING GOODS

FOR TOYS, GAMES, AND PLAYTHINGS, NAMELY, NON-MOTORIZED SCOOTERS, TOY SCOOTERS, TOY BICYCLES, MODEL SCOOTERS, MODEL BICYCLES, ATHLETIC PADS FOR PROTECTING THE KNEE, WRIST, CHEST, SHOULDER, NECK, HAND, EAR, ELBOW, ARM, AND ANKLE; SPORTING AND GYMNASIAC GOODS, NAMELY, IN-LINE SKATES, ICE SKATES, ROLLER SKATES, SKATEBOARDS, TENNIS RACKETS, RACQUETBALL RACKETS, SQUASH RACKETS, GOLF CLUBS, BILLIARD CUES, HOCKEY STICKS; SPORTS EQUIPMENT BAGS; AND STATIONARY EXERCISE BICYCLES (U.S. CLS. 22, 23, 38 AND 50).

SN 76-105,782. AMERICA'S HOBBY CENTER, INC., NORTH BERGEN, NJ. FILED 8-9-2000.

RAILTECH

CLASS 9—ELECTRICAL AND SCIENTIFIC APPARATUS

FOR ELECTRIC POWER PACKS FOR USE WITH ELECTRIC MODEL RAILROADS (U.S. CLS. 21, 23, 26, 36 AND 38).

CLASS 28—TOYS AND SPORTING GOODS

FOR HOBBY SUPPLIES, NAMELY, SCALE MODEL TRAINS AND PARTS THEREFORE (U.S. CLS. 22, 23, 38 AND 50).

SN 76-106,435. WELLNESS, INC., BOSTON, MA. FILED 8-10-2000.

ALPHABET A*KID*DO

CLASS 25—CLOTHING

FOR CLOTHING, NAMELY, SHIRTS, PANTS, JACKETS, HATS, PAJAMAS, GLOVES, SOCKS AND BELTS (U.S. CLS. 22 AND 39).

CLASS 41—EDUCATION AND ENTERTAINMENT

FOR EDUCATIONAL SERVICES, NAMELY, TRAINING FOR LITERACY AND PHYSICAL AND MENTAL FITNESS (U.S. CLS. 100, 101 AND 107).

SN 76-106,716. G5 TECHNOLOGIES, INC., CHERRY HILL, NJ. FILED 8-9-2000.

VCMS

CLASS 9—ELECTRICAL AND SCIENTIFIC APPARATUS

FOR COMPUTER HARDWARE; COMPUTER SOFTWARE DEVELOPMENT TOOLS; GENERAL PURPOSE KNOWLEDGE MANAGEMENT SOFTWARE, NAMELY, SOFTWARE PLATFORMS THAT PROVIDE PROJECT MANAGEMENT SUPPORT, NAMELY, ELECTRONIC DATA STORAGE AND RETRIEVAL, SCHEDULE OF ACTIVITIES, TASK LIST, STATUS REPORTS AND RESOURCE ALLOCATION FOR DISTRIBUTED TEAM MEMBERS COLLABORATING ON JOINT DEVELOPMENT ACTIVITIES IN THE FIELDS OF RESEARCH AND DEVELOPMENT, PRODUCT DESIGN, FIELD SUPPORT SERVICES, DISTANCE LEARNING AND HUMAN RESOURCES TRAINING; COMPUTER HARDWARE AND SOFTWARE TO CREATE AND MAINTAIN AN ELECTRONIC MARKETPLACE; COMPUTER SOFTWARE USED TO CREATE AND MAINTAIN AND ELECTRONIC BUSINESS NETWORK; COMPUTER WORKSTATIONS, NAMELY, COMPUTER TERMINALS (U.S. CLS. 21, 23, 26, 36 AND 38).

CLASS 35—ADVERTISING AND BUSINESS

FOR BUSINESS MANAGEMENT AND CONSULTATION, PLANNING, AND SUPERVISION FOR THE MANUFACTURE, DESIGN, AND SERVICE INDUSTRIES (U.S. CLS. 100, 101 AND 102).

CLASS 40—MATERIAL TREATMENT

FOR CUSTOM MANUFACTURE OF ENERGY AND POWER GENERATION EQUIPMENT, INDUSTRIAL MACHINERY, INDUSTRIAL CHEMICALS, POWDERED AND INJECTION MOLDED METALS, AND BIOMETRIC CONTROLLED ACCESS CONTROL AND SMART CARDS BY BRINGING TOGETHER THE CAPABILITIES AND CAPACITIES OF OTHER COMPANIES (U.S. CLS. 100, 103 AND 106).

CLASS 42—SCIENTIFIC, COMPUTER AND LEGAL SERVICES

FOR COMPUTER HARDWARE DESIGN AND DEVELOPMENT FOR OTHERS; COMPUTER SOFTWARE DESIGN AND DEVELOPMENT FOR OTHERS (U.S. CLS. 100 AND 101).

SN 76-107,139. THURIS CORPORATION, NEWPORT BEACH, CA. FILED 8-10-2000.

THE BUSINESS OF NEUROTECHNOLOGY

CLASS 5—PHARMACEUTICALS

FOR PHARMACEUTICAL PREPARATIONS, CHEMICAL COMPOUNDS, AND PSYCHOTROPIC SUBSTANCES FOR THE DIAGNOSIS AND TREATMENT OF PSYCHIATRIC AND OTHER BRAIN DISORDERS (U.S. CLS. 6, 18, 44, 46, 51 AND 52).

CLASS 9—ELECTRICAL AND SCIENTIFIC APPARATUS

FOR ELECTRONIC APPARATUS, LABORATORY EQUIPMENT, AND COMPUTER SOFTWARE AND HARDWARE TO DETECT AND DIAGNOSE MEDICAL, PSYCHIATRIC, AND PSYCHOLOGICAL CONDITIONS AND DISORDERS IN HUMANS AND ANIMALS (U.S. CLS. 21, 23, 26, 36 AND 38).

CLASS 10—MEDICAL APPARATUS

FOR MEDICAL DEVICES AND ASSAYS FOR DIAGNOSING AND EVALUATING MEDICAL, PSYCHIATRIC, AND PSYCHOLOGICAL CONDITIONS AND DISORDERS IN HUMANS AND ANIMALS, AND DIAGNOSING THE NEED FOR AND EVALUATING THE EFFECT OF PSYCHOACTIVE DRUGS AND PSYCHOTROPIC SUBSTANCES (U.S. CLS. 26, 39 AND 44).

SN 76-107,816. ATTENZA.COM, INC., DALLAS, TX. BY CHANGE OF NAME SERVICE911.COM, INC., DALLAS, TX. FILED 8-11-2000.

WE SUPPORT THE INTERNET

CLASS 37—CONSTRUCTION AND REPAIR

FOR REPAIR AND MAINTENANCE OF COMPUTERS, ELECTRONIC EQUIPMENT AND INFORMATION COMMUNICATIONS SYSTEMS (U.S. CLS. 100, 103 AND 106).

CLASS 42—SCIENTIFIC, COMPUTER AND LEGAL SERVICES

FOR COMPUTER SERVICES, NAMELY PROVIDING ON-LINE TECHNICAL SUPPORT SERVICES, NAMELY, TROUBLESHOOTING OF COMPUTER HARDWARE AND SOFTWARE PROGRAMS, AND PROVIDING TEMPORARY USE OF NON-DOWNLOADABLE ELECTRONIC TUTORIALS FOR TROUBLESHOOTING THE SAME, ALL PROVIDED VIA A GLOBAL COMPUTER NETWORK (U.S. CLS. 100 AND 101).

SN 76-107,817. ATTENZA.COM, INC., DALLAS, TX. BY CHANGE OF NAME SERVICE911.COM, INC., DALLAS, TX. FILED 8-11-2000.

SUPPORTING THE INTERNET

CLASS 37—CONSTRUCTION AND REPAIR

FOR REPAIR AND MAINTENANCE OF COMPUTERS, ELECTRONIC EQUIPMENT AND INFORMATION COMMUNICATIONS SYSTEMS (U.S. CLS. 100, 103 AND 106).

CLASS 42—SCIENTIFIC, COMPUTER AND LEGAL SERVICES

FOR COMPUTER SERVICES, NAMELY PROVIDING ON-LINE TECHNICAL SUPPORT SERVICES, NAMELY, TROUBLESHOOTING OF COMPUTER HARDWARE AND SOFTWARE PROGRAMS, AND PROVIDING TEMPORARY USE OF NON-DOWNLOADABLE ELECTRONIC TUTORIALS FOR TROUBLESHOOTING THE SAME, ALL PROVIDED VIA A GLOBAL COMPUTER NETWORK (U.S. CLS. 100 AND 101).

SN 76-108,028. AEROVIRONMENT INC., MONROVIA, CA.
FILED 8-14-2000.

SN 76-110,302. FIN-ECO HOLDING S.P.A., BRESCIA, ITALY,
FILED 8-16-2000.

SKYTOWER

CLASS 35—ADVERTISING AND BUSINESS

FOR RETAIL STORE SERVICES, DISTRIBUTORSHIPS, AND WHOLESALE DISTRIBUTORSHIPS ALL FEATURING UNMANNED AIRCRAFTS FOR USE IN THE FLIGHT OF ELECTROMAGNETIC TRANSMISSION OF DATA, AUDIO SIGNALS, VIDEO SIGNALS AND TELEPHONY (U.S. CLS. 100, 101 AND 102).

CLASS 38—COMMUNICATION

FOR LEASING OF TELECOMMUNICATIONS EQUIPMENT, NAMELY, AN UNMANNED AIRCRAFT FOR USE IN THE FLIGHT OF ELECTROMAGNETIC TRANSMISSION OF DATA, AUDIO SIGNALS, VIDEO SIGNALS AND TELEPHONY (U.S. CLS. 100, 101 AND 104).

SN 76-108,118. HAWAIIAN HOST, INC., HONOLULU, HI.
FILED 8-10-2000.

CALIFORNIA VACATION

NO CLAIM IS MADE TO THE EXCLUSIVE RIGHT TO USE "CALIFORNIA", APART FROM THE MARK AS SHOWN.

CLASS 29—MEATS AND PROCESSED FOODS

FOR NUTS, NAMELY, SHELLED, ROASTED, CANDIED, OR OTHERWISE PROCESSED; DRIED FRUIT; AND JERKY (U.S. CL. 46).

CLASS 30—STAPLE FOODS

FOR CONFECTIONARY, NAMELY, CHOCOLATE COVERED CANDIES AND NUTS, MINTS, CARAMEL AND NUT CANDIES, BRITTLES, AND CANDIED OR GLAZED POPCORN; COOKIES; AND COFFEE (U.S. CL. 46).

SN 76-109,273. HESPEROS, INC., FALLS CHURCH, VA.
FILED 8-15-2000.

HESPEROS

CLASS 1—CHEMICALS

FOR REAGENTS FOR SCIENTIFIC OR RESEARCH USE (U.S. CLS. 1, 5, 6, 10, 26 AND 46).

CLASS 5—PHARMACEUTICALS

FOR REAGENTS FOR MEDICAL DIAGNOSTIC USE (U.S. CLS. 6, 18, 44, 46, 51 AND 52).

CLASS 9—ELECTRICAL AND SCIENTIFIC APPARATUS

FOR SOFTWARE FOR USE IN CONDUCTING BIO-CHEMICAL ASSAYS (U.S. CLS. 21, 23, 26, 36 AND 38).

FINECO

OWNER OF ITALY REG. NO. 008967, DATED 8-1-2000,
EXPIRES 8-1-2010.

CLASS 35—ADVERTISING AND BUSINESS

FOR ADVERTISING SERVICES, NAMELY RESEARCHING, PLANNING, DESIGNING, CREATING, IMPLEMENTING AND MANAGING PRINT, RADIO, TELEVISION AND INTERNET ADVERTISING MATERIALS AND ADVERTISING CAMPAIGNS; DISSEMINATION OF ADVERTISING FOR OTHERS VIA AN ON LINE ELECTRONIC COMMUNICATION NETWORK; PROMOTION OF FINANCIAL AND INSURANCE SERVICES ON BEHALF OF THIRD PARTIES; ISSUING AND UPDATING OF ADVERTISING TEXTS; COMMERCIAL BUSINESS MANAGEMENT SERVICES; TRADE MANAGEMENT SERVICES; ECONOMIC FORECASTING SERVICES; COMPILATION AND DISSEMINATION OF BUSINESS INFORMATION PUBLICATIONS; COST ACCOUNTING SERVICES; COST/PRICE ANALYSIS SERVICES; COMMERCIAL INFORMATION AGENCIES SERVICES; AUCTIONEERING SERVICES; PERSONNEL MANAGEMENT SERVICES; PERSONNEL PLACEMENT AND RECRUITMENT SERVICES; MARKET RESEARCH SERVICES; MARKET ANALYSIS SERVICES; BUSINESS RESEARCH SERVICES; RESEARCH AND PROFESSIONAL CONSULTANCY SERVICES, NAMELY STAFF ORGANIZATIONAL, STAFF AND BUSINESS FUNCTIONAL ORGANIZATIONAL AND PERSONNEL RESEARCH SERVICES (U.S. CLS. 100, 101 AND 102).

CLASS 36—INSURANCE AND FINANCIAL

FOR INSURANCE, FINANCIAL, MONETARY AND REAL PROPERTY BUSINESS SERVICES, NAMELY FINANCIAL LOAN SERVICES; ACCEPTANCE, EXCHANGE AND PLACEMENT OF PUBLIC AND PRIVATE SECURITIES, SHARE AND BOND SECURITIES; INVESTMENT MANAGEMENT AND BROKERAGE SERVICES; INSURANCE BROKERAGE SERVICES; FINANCIAL INSTRUMENT FACTORING SERVICES; REAL PROPERTY MANAGEMENT SERVICES; CREDIT CARD BASED FINANCIAL TRANSACTION MANAGEMENT SERVICES; DEBIT CARD BASED FINANCIAL TRANSACTION MANAGEMENT SERVICES; CAPITAL AND FUND INVESTMENT SERVICES; FINANCIAL ANALYSIS SERVICES; INTERNET AND WIRELESS NETWORK PROVISION AND MANAGEMENT OF FINANCIAL TRANSACTION SERVICES; AND FINANCIAL INFORMATION SERVICES; TAX PAYMENT PROCESSING SERVICES; VALUATION SERVICES, NAMELY STAMPS, JEWELS, OBJECTS D'ART, ANTIQUES, COINS AND PERSONAL PROPERTY VALUATION SERVICES; SAVINGS BANK SERVICES; SAVINGS ACCOUNT SERVICES; CHECK CASHING, ISSUANCE, PROCESSING AND VERIFICATION SERVICES; CHECKING ACCOUNT SERVICES; REAL ESTATE MANAGEMENT SERVICES; HOME-BANKING SERVICES (U.S. CLS. 100, 101 AND 102).

CLASS 42—SCIENTIFIC, COMPUTER AND LEGAL SERVICES

FOR LEGAL RESEARCH SERVICES; LEGAL SERVICES, NAMELY PROVIDING LEGAL ADVICE RESPECTING SECURITIES, CORPORATE FINANCING AND NATURAL RESOURCE MATTERS, PROVIDING LEGAL ADVICE TO EMERGING, SMALL CAP AND PUBLIC COMPANIES; LEGAL SERVICES RELATING TO PROPERTY, REAL ESTATE AND CONVEYANCING THEREOF; COMPUTER SERVICES, NAMELY PROVIDING DATABASES FEATURING GENERAL AND LOCAL NEWS AND INFORMATION OF INTEREST TO SPECIFIC GEOGRAPHIC AREAS; COMPUTER CONSULTATION SERVICES; COMPUTER DIAGNOSTIC SERVICES; COMPUTER PROGRAMMING SERVICES; COMPUTER SOFTWARE UPDATING SERVICES; COMPUTER SITE DESIGN SERVICES; COMPUTER TIME-SHARING SERVICES; PROVIDING SEARCH ENGINES FOR OBTAINING DATA ON A GLOBAL COMPUTER NETWORK; COMPUTER SOFTWARE MAINTENANCE SERVICES (U.S. CLS. 100 AND 101).

SN 76-110,845. PGS DATA PROCESSING, INC., HOUSTON, TX. FILED 8-16-2000.

A CLEARER IMAGE

NO CLAIM IS MADE TO THE EXCLUSIVE RIGHT TO USE "IMAGE", APART FROM THE MARK AS SHOWN.

CLASS 9—ELECTRICAL AND SCIENTIFIC APPARATUS

FOR SOFTWARE AND COMPUTER HARDWARE FOR ACQUIRING, PROCESSING, RESERVOIR MONITORING, AND CHARACTERIZING SEISMIC DATA (U.S. CLS. 21, 23, 26, 36 AND 38).

CLASS 42—SCIENTIFIC, COMPUTER AND LEGAL SERVICES

FOR SEISMIC DATA SERVICES, NAMELY, ACQUIRING, PROCESSING, RESERVOIR MONITORING, AND CHARACTERIZING SEISMIC DATA FOR OTHERS (U.S. CLS. 100 AND 101).

SN 76-110,961. IEWILD INC., SAN DIEGO, CA. FILED 8-18-2000.

WEB INVERSION

NO CLAIM IS MADE TO THE EXCLUSIVE RIGHT TO USE "WEB", APART FROM THE MARK AS SHOWN.

CLASS 9—ELECTRICAL AND SCIENTIFIC APPARATUS

FOR COMPUTER SOFTWARE FOR AUGMENTING INFORMATION IN A DATABASE WITH INFORMATION FROM THE INTERNET TO CREATE AN AUGMENTED DATABASE USED FOR DATABASE APPLICATIONS IN THE BUSINESS AND CUSTOMER RELATIONS FIELDS (U.S. CLS. 21, 23, 26, 36 AND 38).

CLASS 35—ADVERTISING AND BUSINESS

FOR COMPUTER SERVICES, NAMELY, CREATING A DATABASE AUGMENTED WITH INFORMATION FROM THE INTERNET USED FOR DATABASE APPLICATIONS IN THE FIELDS OF BUSINESS AND CUSTOMER RELATIONS (U.S. CLS. 100, 101 AND 102).

SN 76-111,856. FAIRFIELD RESORTS, INC., ORLANDO, FL. BY CHANGE OF NAME FAIRFIELD COMMUNITIES, INC., FORT LAUDERDALE, FL. FILED 8-17-2000.

RESHAPING TODAY'S VACATION INDUSTRY**CLASS 36—INSURANCE AND FINANCIAL**

FOR VACATION REAL ESTATE TIME-SHARING SERVICES (U.S. CLS. 100, 101 AND 102).

CLASS 39—TRANSPORTATION AND STORAGE

FOR TRAVEL AGENCY SERVICES, NAMELY MAKING RESERVATIONS AND BOOKINGS FOR TRANSPORTATION (U.S. CLS. 100 AND 105).

CLASS 42—SCIENTIFIC, COMPUTER AND LEGAL SERVICES

FOR TRAVEL AGENCY SERVICES, NAMELY MAKING RESERVATIONS AND BOOKINGS FOR TEMPORARY LODGING (U.S. CLS. 100 AND 101).

SN 76-112,034. BERNHARDT, SIEGFRIED, A-6134 VOMP, AUSTRIA, FILED 8-16-2000.

GRAIL**CLASS 16—PAPER GOODS AND PRINTED MATTER**

FOR PRINTED MATTER, NAMELY, BOOKS ABOUT PHILOSOPHY AND RELIGION, MAGAZINES ABOUT PHILOSOPHY AND RELIGION, BROCHURES ABOUT PHILOSOPHY AND RELIGION, MAPS, AND PRINTED TEACHING MATERIALS ABOUT PHILOSOPHY AND RELIGION (U.S. CLS. 2, 5, 22, 23, 29, 37, 38 AND 50).

CLASS 36—INSURANCE AND FINANCIAL

FOR ASSET AND REAL ESTATE MANAGEMENT, CHARITABLE FUND RAISING (U.S. CLS. 100, 101 AND 102).

CLASS 41—EDUCATION AND ENTERTAINMENT

FOR CONDUCTING SEMINARS AND CONFERENCES IN THE FIELD OF PHILOSOPHY AND RELIGION; ORGANIZING EXHIBITIONS FOR CULTURAL EVENTS; PUBLICATION OF BOOKS, MAGAZINES, BROCHURES AND TEACHING MATERIALS ABOUT PHILOSOPHY AND RELIGION (U.S. CLS. 100, 101 AND 107).

CLASS 42—SCIENTIFIC, COMPUTER AND LEGAL SERVICES

FOR CONDUCTION OF DEVOTIONAL SERVICES; FUNERAL HOMES; PROVIDING FUNERAL SERVICES, NAMELY, BURIAL SERVICES OF DECEASED; RESTAURANTS; PROVIDING TEMPORARY HOUSING ACCOMMODATIONS; COMPUTER SERVICES, NAMELY, DESIGNING AND MAINTAINING WEB SITES; AND PROVIDING AN ONLINE COMPUTER DATABASE IN THE FIELD OF RELIGIOUS MEMBERSHIP ORGANIZATIONS (U.S. CLS. 100 AND 101).

SN 76-112,168. CARDSERVICE INTERNATIONAL, INC., AGOURA HILLS, CA. FILED 8-18-2000.

EQUICKAPP

CLASS 9—ELECTRICAL AND SCIENTIFIC APPARATUS

FOR COMPUTER SOFTWARE PRE RECORDED ON CD-ROMS, AND/OR DOWNLOADABLE FROM A GLOBAL COMPUTER NETWORK, FOR ELECTRONIC UPLOADING, DOWNLOADING, AND PROCESSING OF APPLICATIONS BY BUSINESSES AND MERCHANTS TO APPLY FOR A WIDE VARIETY OF E-COMMERCE COMPUTER SERVICES, NAMELY, ELECTRONIC TRANSACTION PROCESSING, ON-LINE SHOPPING, AND OTHER NON-CASH TRANSACTION PROCESSING, NAMELY, CREDIT CARD, PURCHASING CARD, ELECTRONIC BENEFITS TRANSFER CARD, AND DEBIT CARD PROCESSING AND CHECK GUARANTEE SERVICES OVER A GLOBAL COMPUTER NETWORK; AND INSTRUCTION, TRAINING AND INSTALLATION MANUALS PROVIDED THEREWITH (U.S. CLS. 21, 23, 26, 36 AND 38).

CLASS 36—INSURANCE AND FINANCIAL

FOR ELECTRONIC TRANSMISSION AND PROCESSING OF APPLICATIONS BY BUSINESSES AND MERCHANTS TO APPLY FOR A WIDE VARIETY OF E-COMMERCE COMPUTER SERVICES, NAMELY, ELECTRONIC TRANSACTION PROCESSING, ON-LINE SHOPPING, AND OTHER NON-CASH TRANSACTION PROCESSING, NAMELY, CREDIT CARD, PURCHASING CARD, ELECTRONIC BENEFITS TRANSFER CARD, AND DEBIT CARD PROCESSING AND CHECK GUARANTEE SERVICES OVER A GLOBAL COMPUTER NETWORK (U.S. CLS. 100, 101 AND 102).

SN 76-114,025. MEDCOM, INC., CYPRESS, CA. FILED 8-22-2000.



OWNER OF U.S. REG. NOS. 976,838, 1,883,405 AND 2,153,460.

CLASS 35—ADVERTISING AND BUSINESS

FOR (BASED ON USE IN COMMERCE) ONLINE RETAIL STORE SERVICES IN THE FIELD OF MEDICAL AND HEALTH EDUCATIONAL MATERIALS (U.S. CLS. 100, 101 AND 102).
FIRST USE 7-28-1998; IN COMMERCE 7-28-1999.

CLASS 41—EDUCATION AND ENTERTAINMENT

FOR (BASED ON USE IN COMMERCE) PROVIDING COURSES OF INSTRUCTIONS IN THE HEALTH CARE FIELD, AND DISTRIBUTION OF COURSE MATERIAL IN CONJUNCTION THEREWITH; (BASED ON INTENT TO USE) PRODUCTION AND DISTRIBUTION OF TELEVISION PROGRAMS IN THE FIELD HEALTH CARE AND MEDICINE; EDUCATIONAL SERVICES; NAMELY, CONDUCTING COURSES OF INSTRUCTION IN THE HEALTH CARE FIELD THROUGH THE BROADCAST OF TELEVISION PROGRAMS AND THE DISTRIBUTION OF COURSE MATERIALS IN CONNECTION THEREWITH (U.S. CLS. 100, 101 AND 107).
FIRST USE 11-1-1995; IN COMMERCE 11-1-1995.

SN 76-114,073. CONNOLLY, JAMES S., WOODSIDE, NY. FILED 8-23-2000.

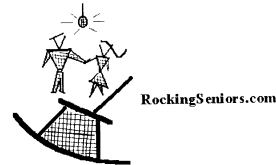

CLASS 16—PAPER GOODS AND PRINTED MATTER

FOR PUBLICATIONS AND PRINTED MATERIAL, NAMELY, MAGAZINES AND NEWSLETTERS ABOUT GERIATRICS AND SENIOR CITIZENS; ARTWORK, NAMELY, REPRODUCTION OF MUSEUM ARTWORK; AND PHOTOGRAPHS (U.S. CLS. 2, 5, 22, 23, 29, 37, 38 AND 50).

CLASS 35—ADVERTISING AND BUSINESS

FOR PUBLIC RELATIONS SERVICES FOR OTHERS AND ADVERTISING AGENCY SERVICES (U.S. CLS. 100, 101 AND 102).

CLASS 41—EDUCATION AND ENTERTAINMENT

FOR ENTERTAINMENT IN THE NATURE OF ONGOING CULTURAL AND SOCIAL PROGRAMS FOR SENIOR CITIZENS AND EDUCATIONAL SERVICES, NAMELY, PROVIDING TRAINING CLASSES IN THE FIELD OF COMPUTER SKILLS AND USE OF THE INTERNET (U.S. CLS. 100, 101 AND 107).

SN 76-114,216. GOMID INC., SEOUL, REPUBLIC OF KOREA,
FILED 8-22-2000.

SN 76-114,266. DIAGNOS.CO.UK LIMITED, OXFORD, UNI-
TED KINGDOM, FILED 8-22-2000.



CLASS 9—ELECTRICAL AND SCIENTIFIC APPARATUS

FOR COMPUTER APPLICATIONS SOFTWARE IN THE FIELD OF NETWORK COMMUNICATIONS; INTERNET BROWSERS; COMPUTER SOFTWARE EMBODIED IN PERSONAL DIGITAL ASSISTANTS FOR THE WIRELESS RECEIPT AND/OR TRANSMISSION OF DATA, THAT ENABLE THE USER TO KEEP TRACK OF OR MANAGE PERSONAL INFORMATION, INVENTORY CONTROL, BAR-CODE SCANNING, REAL-TIME PRINTING, AND WEB BROWSING; COMPUTER GAME PROGRAMS; COMPUTER PROGRAMS FOR THE CREATION OF 3-D VIRTUAL REALITY STRUCTURES AND IMAGES (U.S. CLS. 21, 23, 26, 36 AND 38).

CLASS 35—ADVERTISING AND BUSINESS

FOR COMPUTE SERVICES, NAMELY, INFORMATION STORAGE AND RETRIEVAL IN THE FIELD OF BUSINESS ORGANIZATION; COMPUTER DATABASE MANAGEMENT SERVICES AND INFORMATION DATABASE COMPILATION SERVICES IN THE NATURE OF BUSINESS AND COMMERCE INFORMATION (U.S. CLS. 100, 101 AND 102).

CLASS 37—CONSTRUCTION AND REPAIR

FOR COMPUTER SYSTEM HARDWARE CONSTRUCTION SERVICES (U.S. CLS. 100, 103 AND 106).

CLASS 38—COMMUNICATION

FOR PROVIDING MULTIPLE-USER ACCESS TO A GLOBAL COMPUTER INFORMATION NETWORK; COMPUTER NETWORK COMMUNICATION SERVICES, NAMELY, CHAT ROOMS IN THE FIELD OF PERSONAL, SOCIAL, COMMUNITY AND BUSINESS ISSUES; INSTANT MESSAGE SERVICES (U.S. CLS. 100, 101 AND 104).

CLASS 42—SCIENTIFIC, COMPUTER AND LEGAL SERVICES

FOR COMPUTER SERVICES, NAMELY, CREATING AND MAINTAINING INTERNET WEB SITES AND PORTAL SITES FOR OTHERS; COMPUTER SOFTWARE DESIGN SERVICES; COMPUTER SOFTWARE UPDATING SERVICES; COMPUTER SOFTWARE MAINTENANCE SERVICES; COMPUTER PROGRAMMING SERVICES (U.S. CLS. 100 AND 101).



NO CLAIM IS MADE TO THE EXCLUSIVE RIGHT TO USE "AUTO", APART FROM THE MARK AS SHOWN.

CLASS 9—ELECTRICAL AND SCIENTIFIC APPARATUS

FOR COMPUTER HARDWARE; COMPUTER SOFTWARE, NAMELY IDENTIFICATION AND DIAGNOSTIC SOFTWARE; COMPUTER PERIPHERALS; ALL BEING GOODS RELATING TO IDENTIFICATION AND EVALUATION OF VEHICLE FUNCTIONING, MAINTENANCE AND SERVICING (U.S. CLS. 21, 23, 26, 36 AND 38).

CLASS 37—CONSTRUCTION AND REPAIR

FOR MAINTENANCE OF COMPUTER HARDWARE (U.S. CLS. 100, 103 AND 106).

CLASS 42—SCIENTIFIC, COMPUTER AND LEGAL SERVICES

FOR COMPUTER CONSULTATION; DESIGN AND TESTING FOR NEW PRODUCT DEVELOPMENT; MAINTENANCE OF COMPUTER SOFTWARE; COMPUTER PROGRAMMING FOR OTHERS; COMPUTER SYSTEMS ANALYSIS; ALL BEING SERVICES RELATING TO IDENTIFICATION AND EVALUATION OF VEHICLE FUNCTIONING, MAINTENANCE AND SERVICING (U.S. CLS. 100 AND 101).

SN 76-114,551. WINERY EXCHANGE, INC., NOVATO, CA.
BY CHANGE OF NAME WINERYEXCHANGE.COM,
NOVATO, CA. FILED 8-21-2000.



CLASS 20—FURNITURE AND ARTICLES NOT OTHERWISE CLASSIFIED

FOR EQUIPMENT AND SUPPLIES FOR WINE MAKING, NAMELY, WOODEN WINE BARRELS, WOODEN CASKS, CORKS FOR BOTTLES, AND WOODEN STAKES FOR PLANTS (U.S. CLS. 2, 13, 22, 25, 32 AND 50).

CLASS 33—WINES AND SPIRITS

FOR WINE, PORT AND WINE COOLERS (U.S. CLS. 47 AND 49).

CLASS 35—ADVERTISING AND BUSINESS

FOR INFORMATION CLEARING HOUSE FOR THE WINE INDUSTRY; PROVIDING AN ONLINE DATABASE OF INFORMATION RELATED TO THE WINE INDUSTRY; PROVIDING AN ONLINE MARKETPLACE FOR BUSINESSES TO BUY, SELL AND/OR TRADE WINE INDUSTRY RELATED GOODS AND SERVICES, NAMELY GRAPES, WINES, EQUIPMENT, SUPPLIES, BOTTLING, TRANSPORTATION, MARKETING AND DESIGN (U.S. CLS. 100, 101 AND 102).

CLASS 38—COMMUNICATION

FOR PROVIDING AN ELECTRONIC FORUM FOR SHARING INFORMATION, LEARNING ABOUT INDUSTRY NEWS AND EVENTS AND RESEARCHING AREAS OF INTEREST IN THE WINE INDUSTRY (U.S. CLS. 100, 101 AND 104).

SN 76-116,189. CAPELLON PHARMACEUTICALS, FORTH WORTH, TX. FILED 8-25-2000.

CAPELLON**CLASS 40—MATERIAL TREATMENT**

FOR CUSTOM MANUFACTURE OF PHARMACEUTICAL PREPARATIONS (U.S. CLS. 100, 103 AND 106).
FIRST USE 1-3-1999; IN COMMERCE 1-3-1999.

CLASS 42—SCIENTIFIC, COMPUTER AND LEGAL SERVICES

FOR PHARMACEUTICAL ADVICE (U.S. CLS. 100 AND 101).
FIRST USE 1-3-1999; IN COMMERCE 1-3-1999.

SN 76-116,895. ASSET MANAGEMENT SOFTWARE SYSTEMS INC., MISSISSAUGA, CANADA, FILED 8-25-2000.

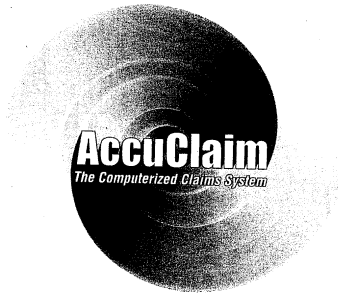

PRIORITY CLAIMED UNDER SEC. 44(D) ON CANADA APPLICATION NO. 1006789, FILED 2-24-1999.

NO CLAIM IS MADE TO THE EXCLUSIVE RIGHT TO USE "THE COMPUTERIZED CLAIMS SYSTEM", APART FROM THE MARK AS SHOWN.

CLASS 9—ELECTRICAL AND SCIENTIFIC APPARATUS

FOR COMPUTER SOFTWARE, NAMELY, CUSTOMIZABLE SOFTWARE DESIGNED FOR USE BY PROPERTY AND CASUALTY CLAIMS ADJUSTERS TO GENERATE CUSTOMIZED ELECTRONIC "SCHEDULE OF LOSS" FORMS AND "PROPERTY CONTENT" REPORTS IN THE FIELD OF PROCESSING INSURANCE CLAIMS (U.S. CLS. 21, 23, 26, 36 AND 38).

FIRST USE 11-2-1999; IN COMMERCE 11-2-1999.

CLASS 36—INSURANCE AND FINANCIAL

FOR INSURANCE CLAIM PROCESSING SERVICES (U.S. CLS. 100, 101 AND 102).
FIRST USE 11-2-1999; IN COMMERCE 11-2-1999.

SN 76-120,061. CAMPUS CRUSADE FOR CHRIST, INC., ORLANDO, FL. FILED 8-30-2000.



NO CLAIM IS MADE TO THE EXCLUSIVE RIGHT TO USE "ASSOCIATES" AND "BALANCE FOCUS DIRECTION", APART FROM THE MARK AS SHOWN.

CLASS 41—EDUCATION AND ENTERTAINMENT

FOR EDUCATIONAL SERVICES, NAMELY, CONDUCTING INSPIRATIONAL SEMINARS AND CONFERENCES FOR BUSINESS PERSONS TO PROMOTE FAITH-BASED LEADERSHIP SKILLS AND SPIRITUAL, PERSONAL AND PROFESSIONAL DEVELOPMENT (U.S. CLS. 100, 101 AND 107).
FIRST USE 12-0-1996; IN COMMERCE 12-0-1996.

CLASS 42—SCIENTIFIC, COMPUTER AND LEGAL SERVICES

FOR RELIGIOUS SERVICES, NAMELY, EVANGELISTIC AND MINISTERIAL SERVICES FOR BUSINESS PERSONS (U.S. CLS. 100 AND 101).
FIRST USE 12-0-1996; IN COMMERCE 12-0-1996.

SN 76-120,571. APPLIED ACOUSTICAL SCIENCES, INC., HANOVER, MD. FILED 8-28-2000.

EVENT TECH

NO CLAIM IS MADE TO THE EXCLUSIVE RIGHT TO USE "EVENT", APART FROM THE MARK AS SHOWN.

CLASS 40—MATERIAL TREATMENT

FOR RENTAL OF GENERATORS AND POWER DISTRIBUTION (U.S. CLS. 100, 103 AND 106).
FIRST USE 10-0-1994; IN COMMERCE 10-0-1994.

CLASS 41—EDUCATION AND ENTERTAINMENT

FOR RENTAL OF SOUND SYSTEMS, LIGHTING SYSTEMS, STAGING SYSTEMS, PORTABLE ROOF SYSTEMS, VIDEO PRODUCTION EQUIPMENT, FLIGHT CASES AND CUSTOM SPEAKERS FOR USE IN STAGING EVENTS (U.S. CLS. 100, 101 AND 107).

FIRST USE 10-0-1994; IN COMMERCE 10-0-1994.

CLASS 42—SCIENTIFIC, COMPUTER AND LEGAL SERVICES

FOR CONSULTING SERVICES RELATED TO STAGING EVENTS (U.S. CLS. 100 AND 101).
FIRST USE 10-0-1994; IN COMMERCE 10-0-1994.

SN 76-121,460. COFFEE NATION LIMITED, LONDON, UNITED KINGDOM, BY CHANGE OF NAME COFFEE NATION UK LIMITED, LONDON, UNITED KINGDOM, FILED 9-5-2000.

COFFEE NATION

OWNER OF UNITED KINGDOM REG. NO. 2212632A, DATED 10-27-1999, EXPIRES 10-27-2009.
OWNER OF U.S. REG. NO. 2,145,537.

NO CLAIM IS MADE TO THE EXCLUSIVE RIGHT TO USE "COFFEE", APART FROM THE MARK AS SHOWN.

SN 76-120,866. MARTORELLA, RUDOLPH, DEER PARK, NY. FILED 9-1-2000.

YOUR HOME WILL LOVE YOU FOR IT!**CLASS 20—FURNITURE AND ARTICLES NOT OTHERWISE CLASSIFIED**

FOR CLOTHES HANGERS; COAT RACKS; CLOSET SHELF AND CLOTHING ORGANIZERS (U.S. CLS. 2, 13, 22, 25, 32 AND 50).

CLASS 21—HOUSEWARES AND GLASS

FOR HOUSEWARES, NAMELY, CUTTING BOARDS, PORTABLE COOLERS, INSULATED COOLERS, CLOTHES DRYING RACKS; DRY FOOD STORAGE CONTAINERS, NAMELY, CONTAINERS FOR FOODS; DISH STANDS AND RACKS; ALL PURPOSE PORTABLE HOUSEHOLD CONTAINERS; MOPS; BROOMS; DISHWASHING BRUSHES; FLOOR BRUSHES; POT CLEANING BRUSHES; SCRUBBING BRUSHES; TOILET BRUSHES; FRYING PANS; METAL COOKING PANS; POTS; TOWEL RACKS; TOWEL RINGS; TOWEL BARS; MEAL TRAYS; SERVING TRAYS NOT OF PRECIOUS METAL AND TRASH CANS (U.S. CLS. 2, 13, 23, 29, 30, 33, 40 AND 50).

CLASS 21—HOUSEWARES AND GLASS

FOR CUPS, COFFEE CUPS, CUPS FOR DRINKING CHOCOLATE, LIDS FOR CUPS, NON-ELECTRIC COFFEE BREWERS, HAND-OPERATED COFFEE MILLS, HAND-OPERATED COFFEE PERCOLATORS, HAND-OPERATED COFFEE GRINDERS, NON-ELECTRIC COFFEE POTS NOT OF PRECIOUS METAL, COFFEE SERVICES NOT OF PRECIOUS METAL, COFFEE POT STANDS, NON-ELECTRIC COFFEE MAKERS, NON-ELECTRIC COFFEE MAKING MACHINES NON-ELECTRIC COFFEE FILTERS (U.S. CLS. 2, 13, 23, 29, 30, 33, 40 AND 50).

CLASS 30—STAPLE FOODS

FOR COFFEE, COFFEE BEANS, CHOCOLATE, SUGAR, SUGAR STICKS, COFFEE BEVERAGES, COFFEE BEVERAGES WITH MILK, COFFEE CONCENTRATES, COFFEE ESSENCES, COFFEE EXTRACTS, COFFEE FLAVORINGS, COFFEE OILS USED FOR FLAVORING, COFFEE PRODUCTS, NAMELY, COFFEE SUBSTITUTES, COFFEE BASED BEVERAGES, CHOCOLATE BEVERAGES, CHOCOLATE COFFEE AND CHOCOLATE ESSENCES FOR PREPARATION OF BEVERAGES (U.S. CL. 46).

SN 76-121,022. E*TRADE SECURITIES, INC., MENLO PARK, CA. FILED 9-1-2000.

CLUB E*TRADE

OWNER OF U.S. REG. NOS. 1,854,863, 2,220,629 AND OTHERS.

CLASS 16—PAPER GOODS AND PRINTED MATTER

FOR PRINTED MATERIALS AND MARKETING MATERIALS, NAMELY NEWSLETTERS, NEWS BULLETINS, MAGAZINES, BOOKS, REPORTS, EDUCATIONAL BROCHURES AND DATA SHEETS RELATED TO FINANCIAL SERVICES (U.S. CLS. 2, 5, 22, 23, 29, 37, 38 AND 50).

CLASS 42—SCIENTIFIC, COMPUTER AND LEGAL SERVICES

FOR CAFETERIA SERVICES, RESTAURANT SERVICES, PREPARATION OF BEVERAGES FOR CONSUMPTION ON OR OFF THE PREMISES, COFFEE BAR SERVICES, PROVIDING SELF-SERVICE MACHINES FOR DISPENSING BEVERAGES, PROVIDING SELF-SERVICE BEVERAGE MACHINES TO OTHERS (U.S. CLS. 100 AND 101).

SN 76-121,517. PINK TRIANGLE PRESS, INC., TORONTO, ONTARIO, CANADA, FILED 9-5-2000.

SQUIRT**CLASS 36—INSURANCE AND FINANCIAL**

FOR FINANCIAL SERVICES, NAMELY STOCK BROKERAGE SERVICES, CREDIT CARD SERVICES, LOAN FINANCING, MORTGAGE LENDING AND MORTGAGE BROKERAGE SERVICES, BILL PAYMENT SERVICES, ELECTRONIC TRANSFERS OF FUNDS ON BEHALF OF OTHERS, INSURANCE BROKERAGE SERVICES, AND PROVIDING INFORMATION IN THE FIELDS OF INVESTMENT AND FINANCE OVER COMPUTER NETWORKS AND GLOBAL COMMUNICATIONS NETWORKS (U.S. CLS. 100, 101 AND 102).

CLASS 35—ADVERTISING AND BUSINESS

FOR ADVERTISING SERVICES, NAMELY, DISSEMINATION OF PERSONALS ADVERTISING FOR OTHERS VIA AN ON-LINE ELECTRONIC COMMUNICATIONS NETWORK (U.S. CLS. 100, 101 AND 102).
FIRST USE 5-31-1999; IN COMMERCE 5-31-1999.

CLASS 38—COMMUNICATION

FOR COMMUNICATION SERVICES, NAMELY, ELECTRONIC MAIL SERVICES, MESSAGING SERVICES, PROVIDING ON-LINE CHAT ROOMS FOR TRANSMISSION AND POSTING OF MESSAGES TO COMPUTER USERS, AND PROVIDING ON-LINE ELECTRONIC BULLETIN BOARDS FOR TRANSMISSION AND POSTING OF MESSAGES AMONG COMPUTER USERS, ALL CONCERNING GAY MEN'S LIFESTYLES AND ENTERTAINMENT OPTIONS AND ALL VIA A GLOBAL COMPUTER NETWORK (U.S. CLS. 100, 101 AND 104).

FIRST USE 5-31-1999; IN COMMERCE 5-31-1999.

CLASS 41—EDUCATION AND ENTERTAINMENT

FOR EDUCATION AND ENTERTAINMENT SERVICES, NAMELY, PROVIDING INFORMATION AND A SEARCHABLE ON-LINE DATA BASE CONCERNING GAY MEN'S LIFESTYLES AND ENTERTAINMENT OPTIONS (U.S. CLS. 100, 101 AND 107).

FIRST USE 5-31-1999; IN COMMERCE 5-31-1999.

SN 76-121,778. SCOREBOARD, INC., HERNDON, VA. FILED 8-30-2000.

**CLASS 35—ADVERTISING AND BUSINESS**

FOR BUSINESS SERVICES PROVIDED TO THE TELECOMMUNICATION INDUSTRY, NAMELY, COLLECTION AND DISTRIBUTION OF TECHNICAL DATA AND MEASURED TELECOMMUNICATION SYSTEM PERFORMANCE RESULTS; PROVIDING A WEBSITE FOR CUSTOMERS, ADVISORS, SERVICE AND TECHNICAL PERSONNEL IN THE WIRELESS TELECOMMUNICATION INDUSTRY TO REQUEST TELECOMMUNICATION SERVICES (U.S. CLS. 100, 101 AND 102).

FIRST USE 8-0-2000; IN COMMERCE 8-0-2000.

CLASS 38—COMMUNICATION

FOR WIRELESS TELECOMMUNICATION CONSULTATION SERVICES (U.S. CLS. 100, 101 AND 104).

FIRST USE 8-0-2000; IN COMMERCE 8-0-2000.

SN 76-122,351. DENALI SOFTWARE, INC., PALO ALTO, CA. FILED 9-5-2000.

DENALI

CLASS 35—ADVERTISING AND BUSINESS

FOR BUSINESS SERVICES, NAMELY, SUPPLY CHAIN MANAGEMENT SERVICES (U.S. CLS. 100, 101 AND 102).

CLASS 42—SCIENTIFIC, COMPUTER AND LEGAL SERVICES

FOR COMPUTER RELATED SERVICES, NAMELY CUSTOM DESIGN OF COMPUTER HARDWARE AND COMPUTER SOFTWARE FOR USE IN THE DESIGN AND ENGINEERING OF COMPUTER HARDWARE, DATA STORAGE DEVICES, MEMORY SYSTEMS, INTEGRATED CIRCUITS, DATA CHECKING AND VERIFICATION DEVICES, AND DIAGNOSTIC AND DEBUGGING DEVICES (U.S. CLS. 100 AND 101).

SN 76-123,337. INSTITUTE FOR SUPPLY MANAGEMENT, INC., TEMPE, AZ. BY CHANGE OF NAME NATIONAL ASSOCIATION OF PURCHASING MANAGEMENT, INC., TEMPE, AZ. FILED 9-6-2000.



NO CLAIM IS MADE TO THE EXCLUSIVE RIGHT TO USE "INSTITUTE FOR SUPPLY MANAGEMENT", APART FROM THE MARK AS SHOWN.

CLASS 9—ELECTRICAL AND SCIENTIFIC APPARATUS

FOR PRERECORDED AUDIO AND VIDEO TAPES FEATURING SEMINARS, CLASSES AND LECTURES IN THE FIELD OF PURCHASING, SUPPLY MANAGEMENT AND SUPPLY CHAIN MANAGEMENT (U.S. CLS. 21, 23, 26, 36 AND 38).

CLASS 16—PAPER GOODS AND PRINTED MATTER

FOR PRINTED MATTER, NAMELY, BROCHURES, NEWSLETTERS, MAGAZINES, TESTING MATERIALS, SERIES OF NON-FICTION BOOKS, PAMPHLETS, STUDY GUIDES, AND DIRECTORIES ALL IN THE FIELD OF PURCHASING, SUPPLY MANAGEMENT AND SUPPLY CHAIN MANAGEMENT; LOOSE LEAF BINDERS, DESK ACCESSORIES, NAMELY, DESK HOLDERS FOR PENS, PENCILS AND BUSINESS CARDS; DESK CALENDARS (U.S. CLS. 2, 5, 22, 23, 29, 37, 38 AND 50).

CLASS 41—EDUCATION AND ENTERTAINMENT

FOR ARRANGING AND CONDUCTING EDUCATIONAL PROGRAMS, NAMELY, SEMINARS, CLASSES AND LECTURES IN THE FIELD OF PURCHASING, SUPPLY MANAGEMENT AND SUPPLY CHAIN MANAGEMENT (U.S. CLS. 100, 101 AND 107).

SN 76-123,339. INSTITUTE FOR SUPPLY MANAGEMENT, INC., TEMPE, AZ. BY CHANGE OF NAME NATIONAL ASSOCIATION OF PURCHASING MANAGEMENT, INC., TEMPE, AZ. FILED 9-6-2000.

SN 76-123,447. BOLAND, JAMES P., LOS ALTOS, CA. FILED 9-6-2000.



NO CLAIM IS MADE TO THE EXCLUSIVE RIGHT TO USE "INSTITUTE FOR SUPPLY MANAGEMENT", APART FROM THE MARK AS SHOWN.

THE STIPPLING IS FOR SHADING PURPOSES ONLY.

CLASS 9—ELECTRICAL AND SCIENTIFIC APPARATUS

FOR PRERECORDED AUDIO AND VIDEO TAPES FEATURING SEMINARS, CLASSES AND LECTURES IN THE FIELD OF PURCHASING, SUPPLY MANAGEMENT AND SUPPLY CHAIN MANAGEMENT (U.S. CLS. 21, 23, 26, 36 AND 38).

CLASS 16—PAPER GOODS AND PRINTED MATTER

FOR PRINTED MATTER, NAMELY, BROCHURES, NEWSLETTERS, MAGAZINES, TESTING MATERIALS, SERIES OF NON-FICTION BOOKS, PAMPHLETS, STUDY GUIDES, AND DIRECTORIES ALL IN THE FIELD OF PURCHASING, SUPPLY MANAGEMENT AND SUPPLY CHAIN MANAGEMENT; LOOSE LEAF BINDERS, DESK ACCESSORIES, NAMELY, DESK HOLDERS FOR PENS, PENCILS AND BUSINESS CARDS; DESK CALENDARS (U.S. CLS. 2, 5, 22, 23, 29, 37, 38 AND 50).

CLASS 41—EDUCATION AND ENTERTAINMENT

FOR ARRANGING AND CONDUCTING EDUCATIONAL PROGRAMS, NAMELY, SEMINARS, CLASSES AND LECTURES IN THE FIELD OF PURCHASING, SUPPLY MANAGEMENT AND SUPPLY CHAIN MANAGEMENT (U.S. CLS. 100, 101 AND 107).

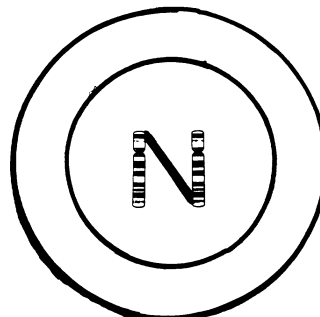

CLASS 9—ELECTRICAL AND SCIENTIFIC APPARATUS

FOR LABORATORY EQUIPMENT AND SUPPLIES, NAMELY, CONTAINERS FOR STORING BIOLOGICAL MATERIALS (U.S. CLS. 21, 23, 26, 36 AND 38).

CLASS 10—MEDICAL APPARATUS

FOR MEDICAL EQUIPMENT AND SUPPLIES, NAMELY, CONTAINERS FOR STORING BIOLOGICAL MATERIALS (U.S. CLS. 26, 39 AND 44).

CLASS 42—SCIENTIFIC, COMPUTER AND LEGAL SERVICES

FOR CHEMICAL ANALYSIS, NAMELY, DNA ANALYSIS; TECHNICAL CONSULTATION AND RESEARCH IN THE FIELD OF BIOTECHNOLOGY, NAMELY, DNA ANALYSIS (U.S. CLS. 100 AND 101).

SN 76-124,263. AF2 ENTERPRISES LLC, CHICAGO, IL. FILED 9-8-2000.



THE MARK CONSISTS OF A STYLIZED FACE OF A CAT.

CLASS 16—PAPER GOODS AND PRINTED MATTER

FOR SOUVENIR PROGRAMS CONCERNING FOOTBALL GAMES, GENERAL MERCHANDISE CATALOGS, BUMPER STICKERS, WRITING PADS AND PENS, TRADING CARDS, POSTERS, FOOTBALL MAGAZINES, POST CARDS, CALENDARS, PAPER STICKERS, APPLIQUES IN THE FORM OF DECALS, SERIES OF NON-FICTION BOOKS ON THE SPORT OF FOOTBALL, AND GREETING CARDS (U.S. CLS. 2, 5, 22, 23, 29, 37, 38 AND 50).

FIRST USE 4-17-2000; IN COMMERCE 4-17-2000.

CLASS 25—CLOTHING

FOR MEN'S, WOMEN'S AND CHILDREN'S CLOTHING, NAMELY, PLAYER UNIFORMS, NAMELY, FOOTWEAR, JERSEY TOPS AND PANTS; CHERLEADER UNIFORMS; REPLICAS UNIFORM SHIRTS, COACHES' CAPS, WOOL HATS, PAINTERS' CAPS, BASEBALL CAPS, VISORS, HEADBANDS, BELTS, T-SHIRTS, TANK TOPS, GOLF SHIRTS, SWEATERS, SWEATSHIRTS, LEATHER JACKETS, NECKTIES, COATS, SHORTS, SWEATPANTS, PANTS, SOCKS AND UNDERWEAR (U.S. CLS. 22 AND 39).

FIRST USE 4-17-2000; IN COMMERCE 4-17-2000.

CLASS 41—EDUCATION AND ENTERTAINMENT

FOR ENTERTAINMENT SERVICES, NAMELY, ORGANIZING AND PRESENTING FOOTBALL GAMES BEFORE LIVE AUDIENCES AND ON TELEVISION, RADIO, FOR GLOBAL COMPUTER NETWORK DISPLAY AND OTHER MEDIA (U.S. CLS. 100, 101 AND 107).

FIRST USE 6-10-1999; IN COMMERCE 6-10-1999.

SN 76-124,502. PROFESSORQ, INC., SAN JOSE, CA. FILED 9-8-2000.

VIRTUAL INTERACTIVE PERSONA

NO CLAIM IS MADE TO THE EXCLUSIVE RIGHT TO USE "VIRTUAL INTERACTIVE", APART FROM THE MARK AS SHOWN.

CLASS 9—ELECTRICAL AND SCIENTIFIC APPARATUS

FOR COMPUTER HARDWARE AND SOFTWARE, NAMELY, COMPUTER SOFTWARE FOR SEARCHING AND RETRIEVING INFORMATION, SITES AND OTHER RESOURCES ON COMPUTER NETWORKS; COMPUTER HARDWARE AND SOFTWARE HAVING VOICE RECOGNITION AND SPEECH SYNTHESIS CAPABILITY; COMPUTER SOFTWARE AND HARDWARE FOR SEARCHING AND RETRIEVING INFORMATION USING NATURAL LANGUAGE INQUIRIES; COMPUTER SOFTWARE FOR FACILITATING BUYING AND SELLING PRODUCTS AND SERVICES ON COMPUTER NETWORKS; COMPUTER SOFTWARE FOR PROVIDING MULTI-USER ACCESS TO A COMPUTER NETWORK FOR BUYING AND SELLING PRODUCTS AND SERVICES; COMPUTER SOFTWARE FOR GENERATING A SEARCHABLE DATABASE OF INFORMATION FROM WHICH INFORMATION CAN BE RETRIEVED; COMPUTER SOFTWARE FOR GENERATING A DATABASE REGARDING PRODUCT INFORMATION, CUSTOMER INFORMATION AND PREFERENCES (U.S. CLS. 21, 23, 26, 36 AND 38).

CLASS 42—SCIENTIFIC, COMPUTER AND LEGAL SERVICES

FOR COMPUTER SERVICES, NAMELY, OBTAINING DATA AND CONTENT INFORMATION ON A COMPUTER NETWORK USING A SEARCH ENGINE; SEARCHING AND RETRIEVING INFORMATION, SITES AND OTHER RESOURCES FOR OTHERS ON A COMPUTER NETWORK; CREATING FOR OTHERS INDEXES OF INFORMATION, WEB SITES, AND OTHER RESOURCES AVAILABLE ON A COMPUTER NETWORK; DATABASE DEVELOPMENT SERVICES IN THE FIELD OF CUSTOMER ASSISTANCE OR DEMOGRAPHICS AND IN THE FIELD OF ON-LINE INFORMATION ACCESS; AND PROVIDING COMPUTER PROGRAMMING SERVICES FOR OTHERS (U.S. CLS. 100 AND 101).

SN 76-125,246. MEHDI DILMAGHANI & CO., INC., SCARSDALE, NY. FILED 9-8-2000.

FLYINGCARPETS**CLASS 35—ADVERTISING AND BUSINESS**

FOR RETAIL AND WHOLESALE STORES FEATURING HANDMADE, CUSTOM MADE AND MANUFACTURED TEXTILE CARPETS, TAPESTRIES, AND FABRICS (U.S. CLS. 100, 101 AND 102).

FIRST USE 8-20-2001; IN COMMERCE 8-20-2001.

CLASS 37—CONSTRUCTION AND REPAIR

FOR CARPETING SERVICES, NAMELY INSTALLATION OF CARPETS (U.S. CLS. 100, 103 AND 106).

FIRST USE 8-20-2001; IN COMMERCE 8-20-2001.

CLASS 42—SCIENTIFIC, COMPUTER AND LEGAL SERVICES

FOR INDUSTRIAL DESIGN SERVICES, NAMELY DESIGN OF CARPETS, TAPESTRIES, AND FABRICS FOR OTHERS, CUSTOM IMPRINTING OF CARPETS, TAPESTRIES AND FABRICS WITH DECORATIVE DESIGNS (U.S. CLS. 100 AND 101).

FIRST USE 8-20-2001; IN COMMERCE 8-20-2001.

SN 76-125,713. YIJIAN INTERNATIONAL LIMITED, ROAD TOWN, TORTOLA, BR. VIRGIN ISLANDS, FILED 9-6-2000.

EZYPRODUCT**CLASS 25—CLOTHING**

FOR CLOTHING, NAMELY, SHIRTS, T-SHIRTS, SWEATSHIRTS, SPORT SHIRTS, JACKETS, SHORTS, CAPS, HATS, PANTS, SWEAT PANTS, BELTS, SHOES, SOCKS, TIES, SKIRTS, SKORTS, LEOTARDS, UNITARDS, COATS, SWEATERS, BLOUSES, JERSEYS, SCARVES, UNDERGARMENTS AND GLOVES (U.S. CLS. 22 AND 39).

CLASS 35—ADVERTISING AND BUSINESS

FOR BUSINESS SERVICES, NAMELY, COMPUTERIZED ON-LINE ORDERING SERVICES IN THE FIELDS OF APPAREL, FURNITURE, CONSUMER ELECTRONICS, KEYCHAINS, WALLETS, PURSES, WATCHES, TOTE BAGS, SUNGLASSES, JEWELRY, BEDDING, TELEPHONE EQUIPMENT, HOUSEWARES, PICTURE FRAMES, FLASHLIGHTS, UMBRELLAS, SPORTS BAGS, BACK PACKS, GLASSES, MUGS, ASHTRAYS, PERFUMES, COGNES, COSMETICS, COMPUTERS AND COMPUTER SUPPLIES AND EQUIPMENT, COMPUTER SOFTWARE AND TOILETRIES; PROCUREMENT SERVICES, NAMELY, PURCHASING APPAREL, FURNITURE, CONSUMER ELECTRONICS, KEYCHAINS, WALLETS, PURSES, WATCHES, TOTE BAGS, SUNGLASSES, JEWELRY, BEDDING, TELEPHONE EQUIPMENT, HOUSEWARES, PICTURE FRAMES, FLASHLIGHTS, UMBRELLAS, SPORTS BAGS, BACK PACKS, GLASSES, MUGS, ASHTRAYS, PERFUMES, COGNES, COSMETICS, COMPUTERS AND COMPUTER SUPPLIES AND EQUIPMENT, COMPUTER SOFTWARE AND TOILETRIES FOR OTHERS (U.S. CLS. 100, 101 AND 102).

SN 76-127,572. AVERY OUTDOORS, INC., MEMPHIS, TN.
FILED 9-14-2000.



NO CLAIM IS MADE TO THE EXCLUSIVE RIGHT TO USE "GEAR", APART FROM THE MARK AS SHOWN.

THE MARK CONSISTS OF A MALLARD DUCK, WITH WINGS EXTENDED, INSIDE A CIRCULAR BORDER INSCRIBED WITH THE WORDS "GREENHEAD GEAR".

CLASS 7—MACHINERY

FOR MECHANICALLY OPERATED HAND HELD CORD CRIMPERS (U.S. CLS. 13, 19, 21, 23, 31, 34 AND 35).

CLASS 8—HAND TOOLS

FOR HUNTING KNIVES; HAND TOOLS IN THE NATURE OF SAWS (U.S. CLS. 23, 28 AND 44).

CLASS 11—ENVIRONMENTAL CONTROL APPARATUS

FOR FLASHLIGHTS; OIL LANTERNS; SPOTLIGHTS (U.S. CLS. 13, 21, 23, 31 AND 34).

CLASS 12—VEHICLES

FOR FITTED BOAT COVERS, STRUCTURAL PARTS OF BOATS, NAMELY, BOAT SEATS (U.S. CLS. 19, 21, 23, 31, 35 AND 44).

CLASS 13—FIREARMS

FOR SHOTGUN SHELLS, GUN SLINGS (U.S. CLS. 2 AND 9).

CLASS 17—RUBBER GOODS

FOR PLASTIC TAPE FOR USE IN HUNTING (U.S. CLS. 1, 5, 12, 13, 35 AND 50).

CLASS 21—HOUSEWARES AND GLASS

FOR BOTTLES SOLD EMPTY; FLASKS; CONTAINERS FOR FOOD OR BEVERAGES (U.S. CLS. 2, 13, 23, 29, 30, 33, 40 AND 50).

CLASS 22—CORDAGE AND FIBERS

FOR UNFITTED BOAT COVERS; TWINE; ROPES (U.S. CLS. 1, 2, 7, 19, 22, 42 AND 50).

CLASS 24—FABRICS

FOR FABRICS, NAMELY, BURLAP AND CEREX (U.S. CLS. 42 AND 50).

CLASS 25—CLOTHING

FOR FISHING WADERS; BOOTS; RAINWEAR; SHIRTS; PANTS; JACKETS; OVERALLS; HATS; GLOVES; T-SHIRTS; VESTS (U.S. CLS. 22 AND 39).

CLASS 28—TOYS AND SPORTING GOODS

FOR WEIGHTS AND CORDS FOR USE WITH HUNTING DECOYS; WILD GAME CARRIERS IN THE NATURE OF A PIECE OF FABRIC WITH WIRE LOOPS AT EITHER END FOR CARRYING GAME; HUNTING GAME CALLS (U.S. CLS. 22, 23, 38 AND 50).

CLASS 34—SMOKERS' ARTICLES

FOR CIGARETTE LIGHTERS NOT FOR LAND VEHICLES (U.S. CLS. 2, 8, 9 AND 17).

SN 76-127,706. ZAPF'S MUSIC, INC., CHERRY HILL, NJ.
FILED 9-12-2000.

MISUPPLY

CLASS 35—ADVERTISING AND BUSINESS

FOR ON-LINE ORDERING SERVICES FEATURING MUSICAL INSTRUMENTS, MUSICAL EQUIPMENT, MUSICAL ACCESSORIES, SOUND EQUIPMENT, SOUND ACCESSORIES, COMPUTER SOFTWARE AND PRINTED SHEET MUSIC AND CONSULTATION SERVICES PROVIDED IN CONNECTION THEREWITH; ON-LINE RETAIL STORE SERVICES FEATURING MUSICAL INSTRUMENTS, MUSICAL EQUIPMENT, MUSICAL ACCESSORIES, SOUND EQUIPMENT, SOUND ACCESSORIES, COMPUTER SOFTWARE AND PRINTED SHEET MUSIC AND CONSULTATION SERVICES PROVIDED IN CONNECTION THEREWITH; MAIL ORDER SERVICES FEATURING MUSICAL INSTRUMENTS, MUSICAL EQUIPMENT, MUSICAL ACCESSORIES, SOUND EQUIPMENT, SOUND ACCESSORIES, COMPUTER SOFTWARE AND PRINTED SHEET MUSIC AND CONSULTATION SERVICES PROVIDED IN CONNECTION THEREWITH; WHOLESALE DISTRIBUTORSHIP SERVICES FEATURING MUSICAL INSTRUMENTS, MUSICAL EQUIPMENT, MUSICAL ACCESSORIES, SOUND EQUIPMENT, SOUND ACCESSORIES, COMPUTER SOFTWARE AND PRINTED SHEET MUSIC AND CONSULTATION SERVICES PROVIDED IN CONNECTION THEREWITH; WHOLESALE STORES FEATURING MUSICAL INSTRUMENTS, MUSICAL EQUIPMENT, MUSICAL ACCESSORIES, SOUND EQUIPMENT, SOUND ACCESSORIES, COMPUTER SOFTWARE AND PRINTED SHEET MUSIC AND CONSULTATION SERVICES PROVIDED IN CONNECTION THEREWITH; AUCTIONEERING SERVICES; PROVIDING RESALE AND EXCHANGE SERVICES IN THE FIELDS OF BUYING AND SELLING MUSICAL INSTRUMENTS, MUSICAL EQUIPMENT, MUSICAL ACCESSORIES, SOUND EQUIPMENT, SOUND ACCESSORIES, COMPUTER SOFTWARE AND PRINTED SHEET MUSIC PROVIDED VIA WHOLESALE STORES, RETAIL STORES, MAIL ORDER AND THE INTERNET (U.S. CLS. 100, 101 AND 102).

CLASS 42—SCIENTIFIC, COMPUTER AND LEGAL SERVICES

FOR COMPUTER SERVICES, NAMELY APPLICATION SERVICE PROVIDER SERVICES RELATING TO PRODUCT DATABASE MANAGEMENT AND CUSTOMER TRANSACTIONS VIA ELECTRONIC COMMERCE FOR THE MUSICAL PRODUCTS INDUSTRY AND CONSULTATION SERVICES PROVIDED IN CONNECTION THEREWITH (U.S. CLS. 100 AND 101).

SN 76-127,749. EVERLASTING SYSTEMS LIMITED, HONG KONG, FILED 9-14-2000.

INTERLYZER

CLASS 9—ELECTRICAL AND SCIENTIFIC APPARATUS

FOR COMPUTER SOFTWARE AND COMPUTER PROGRAMS FOR PERFORMING NETWORK MANAGEMENT, SYSTEM MANAGEMENT AND SECURITY MANAGEMENT OF SERVER-BASED SYSTEMS THAT COVER PERFORMANCE FUNCTIONS, NAMELY, ELIMINATING BOTTLENECKS IN THE NETWORK AND COVER RELIABILITY FUNCTIONS, NAMELY, MAKING SURE THE NETWORKS IS AVAILABLE TO USERS AND RESPONDING TO HARDWARE AND SOFTWARE MALFUNCTIONS; MIDDLEWARE SOFTWARE FOR INTEGRATING THE INTERFACE AND INCREASING THE PERFORMANCE OF MULTIPLE HOST AND SERVER PLATFORMS IN ORDER TO INCREASE PRODUCTIVITY; COMPUTERS; ENCODED MAGNETIC CARDS; AND ELECTRONIC NOTICE BOARDS (U.S. CLS. 21, 23, 26, 36 AND 38).

CLASS 42—SCIENTIFIC, COMPUTER AND LEGAL SERVICES

FOR COMPUTER SERVICES, NAMELY, COMPUTER PROGRAMMING FOR CONVERSION OF COMPUTER SOFTWARE PRODUCED BY OTHERS TO HANDLE MULTIPLE FOREIGN LANGUAGE PLATFORMS; COMPUTER PROGRAMMING, UPDATING COMPUTER SOFTWARE, COMPUTER SYSTEMS ANALYSIS, COMPUTER ENGINEERING, COMPUTER SOFTWARE MAINTENANCE ALL FOR COMPUTER INTERNATIONALIZATION, WHICH INVOLVES IDENTIFYING AND REMOVING OF HARD-CODED DEPENDENCIES TO NEUTRALIZE SOFTWARE TO BE FOREIGN LANGUAGE INDEPENDENT AND LOCALIZATION OF SOFTWARE FOR SOFTWARE VENDORS; RENTAL OF COMPUTER SOFTWARE, COMPUTER AND SOFTWARE RESEARCH AND DEVELOPMENT FOR OTHERS, COMPUTER SOFTWARE DESIGN DEVELOPMENT AND TECHNICAL CONSULTATION OF E-COMMERCE COMPUTER APPLICATIONS FOR GLOBAL COMPUTER NETWORK AND GENERAL PURPOSE PROGRAMMING LANGUAGE SUITED FOR USE ON THE GLOBAL COMPUTER NETWORK (U.S. CLS. 100 AND 101).

SN 76-128,080. WILK PATENT DEVELOPMENT CORPORATION, NEW YORK, NY. FILED 9-14-2000.

ULTRA PLOT

NO CLAIM IS MADE TO THE EXCLUSIVE RIGHT TO USE "PLOT", APART FROM THE MARK AS SHOWN.

CLASS 9—ELECTRICAL AND SCIENTIFIC APPARATUS

FOR IMAGING DEVICES UTILIZING ULTRASONIC SENSOR ARRAYS, NAMELY, ULTRASONIC SCANNERS; UNDERWATER SURVEYING APPARATUS, NAMELY, UNDERWATER SCANNERS AND UNDERWATER ULTRASONIC SCANNERS; UNDERGROUND SURVEYING APPARATUS, NAMELY, UNDERGROUND SCANNERS AND ULTRASONIC UNDERGROUND SCANNERS (U.S. CLS. 21, 23, 26, 36 AND 38).

CLASS 10—MEDICAL APPARATUS

FOR MEDICAL IMAGING DEVICES UTILIZING ULTRASONIC SENSOR ARRAYS, NAMELY, MEDICAL ULTRASOUND SCANNERS; ULTRASONIC MEDICAL SCANNERS (U.S. CLS. 26, 39 AND 44).

SN 76-128,765. EVERLASTING SYSTEMS LIMITED, HONG KONG, FILED 9-14-2000.

LOCALYZER

CLASS 9—ELECTRICAL AND SCIENTIFIC APPARATUS

FOR COMPUTER SOFTWARE AND COMPUTER PROGRAMS FOR PERFORMING NETWORK MANAGEMENT, SYSTEM MANAGEMENT AND SECURITY MANAGEMENT OF SERVER-BASED SYSTEMS THAT COVER PERFORMANCE FUNCTIONS, NAMELY, ELIMINATING BOTTLENECKS IN THE NETWORK AND COVER RELIABILITY FUNCTIONS, NAMELY, MAKING SURE THE NETWORK IS AVAILABLE TO USERS AND RESPONDING TO HARDWARE AND SOFTWARE MALFUNCTIONS; MIDDLEWARE SOFTWARE FOR INTEGRATING THE INTERFACE AND INCREASING THE PERFORMANCE OF MULTIPLE HOST AND SERVER PLATFORMS IN ORDER TO INCREASE PRODUCTIVITY; COMPUTERS; ENCODED MAGNETIC CARDS; AND ELECTRONIC NOTICE BOARDS (U.S. CLS. 21, 23, 26, 36 AND 38).

CLASS 42—SCIENTIFIC, COMPUTER AND LEGAL SERVICES

FOR COMPUTER SERVICES, NAMELY, COMPUTER PROGRAMMING FOR CONVERSION OF COMPUTER SOFTWARE PRODUCED BY OTHERS TO HANDLE MULTIPLE FOREIGN LANGUAGE PLATFORMS; COMPUTER PROGRAMMING, UPDATING COMPUTER SOFTWARE, COMPUTER SYSTEMS ANALYSIS, COMPUTER ENGINEERING, COMPUTER SOFTWARE MAINTENANCE ALL FOR COMPUTER INTERNATIONALIZATION, WHICH INVOLVES IDENTIFYING AND REMOVING OF HARD-CODED DEPENDENCIES TO NEUTRALIZE SOFTWARE TO BE FOREIGN LANGUAGE INDEPENDENT AND LOCALIZATION OF SOFTWARE FOR SOFTWARE VENDORS; RENTAL OF COMPUTER SOFTWARE, COMPUTER AND SOFTWARE RESEARCH AND DEVELOPMENT FOR OTHERS, COMPUTER SOFTWARE DESIGN DEVELOPMENT AND TECHNICAL CONSULTATION OF E-COMMERCE COMPUTER APPLICATIONS FOR GLOBAL COMPUTER NETWORK AND GENERAL PURPOSE PROGRAMMING LANGUAGE SUITED FOR USE ON THE GLOBAL COMPUTER NETWORK (U.S. CLS. 100 AND 101).

SN 76-128,827. DIGITAL PRESS & GRAPHICS, L.L.C., BATON ROUGE, LA. FILED 9-14-2000.



NO CLAIM IS MADE TO THE EXCLUSIVE RIGHT TO USE "DIGITAL PRESS & GRAPHICS", APART FROM THE MARK AS SHOWN.

THE STIPPLING IS A FEATURE OF THE MARK.

THE MARK CONSISTS OF A STYLIZED REPRESENTATION OF THE LETTER "D" AND THE WORDING "DIGITAL PRESS & GRAPHICS".

CLASS 40—MATERIAL TREATMENT

FOR DIGITAL IMAGING IN BLACK AND WHITE OR FULL COLOR (U.S. CLS. 100, 103 AND 106).
FIRST USE 6-1-2000; IN COMMERCE 6-1-2000.

CLASS 42—SCIENTIFIC, COMPUTER AND LEGAL SERVICES

FOR PROVIDING QUICK PRINTING AND COMMERCIAL PRINTING SERVICES (U.S. CLS. 100 AND 101).
FIRST USE 6-1-2000; IN COMMERCE 6-1-2000.

SN 76-128,957. STARLIGHT SIGN INSTALLATION SERVICE LIGHTING CORP., VAN NUYS, CA. FILED 9-14-2000.

The logo consists of the letters "SMMS" in a bold, stylized font with a thick outline. Below "SMMS" is a horizontal bar containing a stylized yellow "T" shaped like a four-pronged star. Below the bar, the word "STARLIGHT" is written in a bold, sans-serif font.

THE MARK CONSISTS OF THE "SMMS" LETTERS IN YELLOW AND OUTLINED IN BLACK, A STYLIZED YELLOW "T" SHAPED LIKE A FOUR-PRONGED STAR AND THE WORDING "STARLIGHT" COMPOSED OF WHITE LETTERING WITH SLIGHT YELLOW AROUND THE LETTERS. COLOR IS A FEATURE OF THE MARK.

CLASS 35—ADVERTISING AND BUSINESS

FOR BUSINESS MANAGEMENT SERVICES, NAMELY, SIGN AND LIGHTING INVENTORY MANAGEMENT FOR OTHERS (U.S. CLS. 100, 101 AND 102).
FIRST USE 5-10-2000; IN COMMERCE 5-10-2000.

CLASS 37—CONSTRUCTION AND REPAIR

FOR SIGN MAINTENANCE (U.S. CLS. 100, 103 AND 106).
FIRST USE 5-10-2000; IN COMMERCE 5-10-2000.

SN 76-129,601. MCDIVOT NOVELTIES, INC., BRATEHAHL, OH. FILED 9-18-2000.

The logo consists of the word "MCDIVOT" in a bold, sans-serif font.

CLASS 16—PAPER GOODS AND PRINTED MATTER

FOR GOLF PRODUCTS, NAMELY, DISPOSABLE PAPER MESSAGES FOR GOLFERS (U.S. CLS. 2, 5, 22, 23, 29, 37, 38 AND 50).

CLASS 28—TOYS AND SPORTING GOODS

FOR GOLF PRODUCTS, NAMELY, GOLF HOLE COVERS, GOLF HOLE INSERTS USED AS A NOVELTY ITEM TO EITHER REDUCE THE HOLE SIZE OR MECHANICALLY EJECT THE BALL FROM THE HOLE, GOLF HOLE FOAM, GREASE USED AS A NOVELTY ITEM, AND GOLF TEES (U.S. CLS. 22, 23, 38 AND 50).

SN 76-129,682. POTOMAC RESEARCH INTERNATIONAL, INC., ROCKVILLE, MD. FILED 9-18-2000.

The logo consists of the letters "PRI" in a bold, sans-serif font.

OWNER OF U.S. REG. NO. 1,610,737.

CLASS 35—ADVERTISING AND BUSINESS

FOR LOGISTICS MANAGEMENT SERVICES IN THE FIELDS OF INTEGRATED LOGISTICS SUPPORT, SUPPORTABILITY AND MAINTAINABILITY OF EQUIPMENT, SYSTEMS INTEGRATIONS (U.S. CLS. 100, 101 AND 102).

FIRST USE 7-0-1996; IN COMMERCE 7-0-1996.

CLASS 42—SCIENTIFIC, COMPUTER AND LEGAL SERVICES

FOR ENGINEERING SERVICES IN THE FIELD OF INTELLIGENCE AND SENSOR INFORMATION IN THE BATTLEFIELD, TELECOMMUNICATIONS AND WEAPONRY (U.S. CLS. 100 AND 101).

FIRST USE 7-0-1996; IN COMMERCE 7-0-1996.

SN 76-130,104. EVERLASTING SYSTEMS LIMITED, STUBBS ROAD, HONG KONG, FILED 9-15-2000.

The logo consists of the letters "SGIL" in a bold, sans-serif font.

CLASS 9—ELECTRICAL AND SCIENTIFIC APPARATUS

FOR COMPUTER SOFTWARE AND COMPUTER PROGRAMS FOR PERFORMING NETWORK MANAGEMENT, SYSTEM MANAGEMENT AND SECURITY MANAGEMENT OF SERVER-BASED SYSTEMS THAT COVER PERFORMANCE FUNCTIONS, NAMELY, ELIMINATING BOTTLENECKS IN THE NETWORK AND COVER RELIABILITY FUNCTIONS, NAMELY, MAKING SURE THE NETWORK IS AVAILABLE TO USERS AND RESPONDING TO HARDWARE AND SOFTWARE MALFUNCTIONS; MIDDLEWARE SOFTWARE FOR INTEGRATING THE INTERFACE AND INCREASING THE PERFORMANCE OF MULTIPLE HOST AND SERVER PLATFORMS IN ORDER TO INCREASE PRODUCTIVITY; COMPUTERS; ENCODED MAGNETIC CARDS; AND ELECTRONIC NOTICE BOARDS (U.S. CLS. 21, 23, 26, 36 AND 38).

CLASS 42—SCIENTIFIC, COMPUTER AND LEGAL SERVICES

FOR COMPUTER SERVICES, NAMELY, COMPUTER PROGRAMMING FOR CONVERSION OF COMPUTER SOFTWARE PRODUCED BY OTHERS TO HANDLE MULTIPLE FOREIGN LANGUAGE PLATFORMS; COMPUTER PROGRAMMING, UPDATING COMPUTER SOFTWARE, COMPUTER SYSTEMS ANALYSIS, COMPUTER ENGINEERING, COMPUTER SOFTWARE MAINTENANCE ALL FOR COMPUTER INTERNATIONALIZATION, WHICH INVOLVES IDENTIFYING AND REMOVING OF HARD-CODED DEPENDENCIES TO NEUTRALIZE SOFTWARE TO BE FOREIGN LANGUAGE INDEPENDENT AND LOCALIZATION OF SOFTWARE FOR SOFTWARE VENDORS; RENTAL OF COMPUTER SOFTWARE, COMPUTER AND SOFTWARE RESEARCH AND DEVELOPMENT FOR OTHERS, COMPUTER SOFTWARE DESIGN DEVELOPMENT AND TECHNICAL CONSULTATION OF E-COMMERCE COMPUTER APPLICATIONS FOR GLOBAL COMPUTER NETWORK AND GENERAL PURPOSE PROGRAMMING LANGUAGE SUITED FOR USE ON THE GLOBAL COMPUTER NETWORK (U.S. CLS. 100 AND 101).

SN 76-130,395. ZEUS SPORTS, INC., WESTMINSTER, MD.
FILED 9-18-2000.



NO CLAIM IS MADE TO THE EXCLUSIVE RIGHT TO USE "SPORTS", APART FROM THE MARK AS SHOWN.

CLASS 16—PAPER GOODS AND PRINTED MATTER

FOR PRINTED MATTER, NAMELY, BOOKS AND MANUALS FEATURING SPORTS INSTRUCTION AND INFORMATION WITH PRE-RECORDED VIDEO TAPES AND VIDEO CASSETTES FEATURING INSTRUCTIONAL AND TEACHING MATERIALS FOR SPORTS INSTRUCTION AND SPORTING EVENTS, SOLD TOGETHER AS A UNIT (U.S. CLS. 2, 5, 22, 23, 29, 37, 38 AND 50).

CLASS 41—EDUCATION AND ENTERTAINMENT

FOR PRODUCTION OF VIDEO TAPES, FILMS, TELEVISION PROGRAMS AND ANIMATIONS FEATURING SPORTS INSTRUCTION AND SPORTING EVENTS FOR EDUCATIONAL PURPOSES; MULTIMEDIA ENTERTAINMENT SOFTWARE PRODUCTION SERVICES; AND PROVIDING OF TRAINING, NAMELY CONDUCTING SPORTS CAMPS AND SPORTS-RELATED CLINICS (U.S. CLS. 100, 101 AND 107).

SN 76-130,905. CATELLIER, JEAN, 63730 LES MARTRES DE VEYRE, FRANCE, FILED 9-15-2000.

AVIDIS

PRIORITY CLAIMED UNDER SEC. 44(D) ON FRANCE APPLICATION NO. 003014530, FILED 3-15-2000, REG. NO. 003014530, DATED 3-15-2000, EXPIRES 3-15-2010.

CLASS 1—CHEMICALS

FOR RAW PROTEINS, CHEMICAL AND BIOLOGICAL DIAGNOSTIC PREPARATIONS AND BIOTRANSFORMATIONS, REAGENTS AND CULTURE OF MICROORGANISMS FOR SCIENTIFIC RESEARCH USE (U.S. CLS. 1, 5, 6, 10, 26 AND 46).

CLASS 5—PHARMACEUTICALS

FOR DIAGNOSTIC AND BIOLOGICAL PREPARATIONS AND CULTURES OF MICROORGANISMS FOR CLINICAL OR MEDICAL LABORATORY USE; REAGENTS FOR MEDICAL, VETERINARY AND DIAGNOSTIC USE (U.S. CLS. 6, 18, 44, 46, 51 AND 52).

CLASS 42—SCIENTIFIC, COMPUTER AND LEGAL SERVICES

FOR RESEARCH, SCIENTIFIC AND MEDICAL RESEARCH SERVICES IN THE FIELD OF BIOTECHNOLOGY; PRODUCTS AND TECHNOLOGY CONCEPTION, DEVELOPMENT, RESEARCH AND DESIGN FOR OTHERS IN THE FIELD OF BIOTECHNOLOGY, ALL CONCERNING PROTEINS AND MICROORGANISMS (U.S. CLS. 100 AND 101).

SN 76-132,003. GODFREY, JULIE, CHATSWORTH, CA. AND DE LEO, DEBRA, CHATSWORTH, CA. FILED 9-19-2000.

CLEARLY QUEER

CLASS 18—LEATHER GOODS

FOR ALL PURPOSE SPORT BAGS, DUFFEL BAGS, TOTE BAGS, WAIST PACKS, SHOULDER BAGS AND BOOK BAGS (U.S. CLS. 1, 2, 3, 22 AND 41).

CLASS 25—CLOTHING

FOR BEACH WEAR, BLOUSES, COATS, COVERALLS, DRESSES, HEAD WEAR, JACKETS, JEANS, JOGGING SUITS, JUMPERS, LEG WARMERS, LEGGINGS, LINGERIE, LOUNGEWEAR, NECKWEAR, PANTS, SCARVES, SHIRTS, SKI WEAR, SLACKS, SLEEPWEAR, T-SHIRTS, TANK TOPS, SOCKS, VESTS (U.S. CLS. 22 AND 39).

SN 76-135,212. COLUMBIA TRISTAR TELEVISION, INC., CULVER CITY, CA. FILED 9-25-2000.

THE NEWLYWED GAME

OWNER OF U.S. REG. NO. 2,135,464.
NO CLAIM IS MADE TO THE EXCLUSIVE RIGHT TO USE "GAME", APART FROM THE MARK AS SHOWN.

CLASS 9—ELECTRICAL AND SCIENTIFIC APPARATUS

FOR SLOT MACHINES; ELECTRONIC GAMING MACHINES; COMPUTER GAME CARTRIDGES; COMPUTER GAMES ON CD ROM; DOWNLOADABLE INTERACTIVE COMPUTER GAMES SOFTWARE ACCESSIBLE VIA A COMPUTER NETWORK (U.S. CLS. 21, 23, 26, 36 AND 38).

CLASS 41—EDUCATION AND ENTERTAINMENT

FOR ENTERTAINMENT SERVICES, NAMELY, PROVIDING ON-LINE INTERACTIVE COMPUTER GAMES (U.S. CLS. 100, 101 AND 107).

SN 76-136,005. JOURNAL OF BONE AND JOINT SURGERY, INCORPORATED, THE, NEEDHAM, MA. FILED 9-26-2000.

EJBJS

OWNER OF U.S. REG. NOS. 1,108,574 AND 2,055,138.

CLASS 35—ADVERTISING AND BUSINESS

FOR PROMOTING THE GOODS AND SERVICES OF OTHERS BY PLACING ADVERTISEMENTS AND PROMOTIONAL DISPLAYS IN AN ELECTRONIC SITE ACCESSED VIA GLOBAL COMPUTER NETWORKS (U.S. CLS. 100, 101 AND 102).
FIRST USE 3-1-2000; IN COMMERCE 3-1-2000.

CLASS 42—SCIENTIFIC, COMPUTER AND LEGAL SERVICES

FOR ON-LINE INFORMATION SERVICES IN THE FIELD OF ORTHOPAEDIC SURGERY AND MEDICINE (U.S. CLS. 100 AND 101).

FIRST USE 3-1-2000; IN COMMERCE 3-1-2000.

SN 76-137,038. PETROVAL (SOCIETE ANONYME), 76430 LES TROIS PIERRES, FRANCE, FILED 9-28-2000.

PETROVAL

OWNER OF FRANCE REG. NO. 1,574,037, DATED 2-6-1990, EXPIRES 2-6-2010.

CLASS 40—MATERIAL TREATMENT

FOR CUSTOM MANUFACTURE OF CHEMICAL, OIL REFINING AND PETROCHEMICAL CATALYSTS FOR OTHERS (U.S. CLS. 100, 103 AND 106).

CLASS 42—SCIENTIFIC, COMPUTER AND LEGAL SERVICES

FOR TECHNICAL ASSISTANCE AND CONSULTATION BY ENGINEERS IN THE FIELD OF CHEMICALS, PETROCHEMICALS AND OIL REFINING INDUSTRY (U.S. CLS. 100 AND 101).

SN 76-137,536. BANK OF MONTREAL, TORONTO, ONTARIO M5X 1A1, CANADA, FILED 9-28-2000.

PROCUREMENT BEYOND

NO CLAIM IS MADE TO THE EXCLUSIVE RIGHT TO USE "PROCUREMENT", APART FROM THE MARK AS SHOWN.

CLASS 35—ADVERTISING AND BUSINESS

FOR BUSINESS TO BUSINESS PROCUREMENT SERVICES, NAMELY, PURCHASING A WIDE VARIETY OF GOODS AND SERVICES FOR OTHERS (U.S. CLS. 100, 101 AND 102).

CLASS 36—INSURANCE AND FINANCIAL

FOR BUSINESS TRANSACTION SERVICES, NAMELY, CREDIT CARD PROCESSING SERVICES (U.S. CLS. 100, 101 AND 102).

SN 76-137,715. ANSYS DIAGNOSTICS, INC., LAKE FOREST, CA. FILED 10-2-2000.

MONOCHROM**CLASS 1—CHEMICALS**

FOR LIQUID CHROMATOGRAPHY CHEMICALS FOR LABORATORY AND INDUSTRIAL USE, NAMELY, PACKING CARTRIDGES AND PACKING MEDIA FOR CHROMATOGRAPHY COLUMNS (U.S. CLS. 1, 5, 6, 10, 26 AND 46).

FIRST USE 1-15-1998; IN COMMERCE 1-15-1998.

CLASS 9—ELECTRICAL AND SCIENTIFIC APPARATUS

FOR LIQUID CHROMATOGRAPHY PRODUCTS FOR LABORATORY AND INDUSTRIAL USE, NAMELY, CHROMATOGRAPHY COLUMNS AND FILTERS THEREFOR (U.S. CLS. 21, 23, 26, 36 AND 38).

FIRST USE 1-15-1998; IN COMMERCE 1-15-1998.

SN 76-137,717. ANSYS DIAGNOSTICS, INC., LAKE FOREST, CA. FILED 10-2-2000.

HYDROPEP**CLASS 1—CHEMICALS**

FOR LIQUID CHROMATOGRAPHY CHEMICALS FOR LABORATORY AND INDUSTRIAL USE, NAMELY, PACKING CARTRIDGES AND PACKING MEDIA FOR CHROMATOGRAPHY COLUMNS (U.S. CLS. 1, 5, 6, 10, 26 AND 46).

FIRST USE 2-6-1998; IN COMMERCE 2-6-1998.

CLASS 9—ELECTRICAL AND SCIENTIFIC APPARATUS

FOR LIQUID CHROMATOGRAPHY PRODUCTS FOR LABORATORY AND INDUSTRIAL USE, NAMELY, CHROMATOGRAPHY COLUMNS AND FILTERS THEREFOR (U.S. CLS. 21, 23, 26, 36 AND 38).

FIRST USE 2-6-1998; IN COMMERCE 2-6-1998.

SN 76-138,133. SIXSIGMA,LTD, MILL CREEK, WA. FILED 10-2-2000.

DIRECTVM**CLASS 9—ELECTRICAL AND SCIENTIFIC APPARATUS**

FOR TELEPHONY EQUIPMENT, NAMELY, A COMBINATION TELEPHONE AND VOICE-MAIL TRANSCIEVER (U.S. CLS. 21, 23, 26, 36 AND 38).

CLASS 38—COMMUNICATION

FOR TELECOMMUNICATION SERVICES, NAMELY TELEPHONE COMMUNICATION AND VOICE-MAIL TRANSMISSION (U.S. CLS. 100, 101 AND 104).

SN 76-138,749. LOMINGER LIMITED, INC., MINNEAPOLIS, MN. FILED 10-2-2000.

ROI ARCHITECT

OWNER OF U.S. REG. NOS. 1,713,627, 2,238,076 AND OTHERS.

CLASS 9—ELECTRICAL AND SCIENTIFIC APPARATUS

FOR INTERACTIVE MULTIMEDIA COMPUTER PROGRAM FOR USE BY INDIVIDUALS AND BUSINESSES TO EVALUATE AND IMPROVE JOB PERFORMANCE, CAREER SKILLS AND CAREER DEVELOPMENT, NAMELY, ELECTRONIC SURVEYS AND SURVEY ANSWER SHEETS (U.S. CLS. 21, 23, 26, 36 AND 38).

CLASS 16—PAPER GOODS AND PRINTED MATTER

FOR PRINTED MATTER FOR USE BY INDIVIDUALS AND BUSINESSES TO EVALUATE AND IMPROVE JOB PERFORMANCE, CAREER SKILLS AND CAREER DEVELOPMENT, NAMELY PRINTED SURVEYS AND SURVEY ANSWER SHEETS (U.S. CLS. 2, 5, 22, 23, 29, 37, 38 AND 50).

CLASS 42—SCIENTIFIC, COMPUTER AND LEGAL SERVICES

FOR PROVIDING TEMPORARY USE OF ON-LINE NON-DOWNLOADABLE SOFTWARE FOR ONLINE EVALUATION AND IMPROVEMENT OF JOB PERFORMANCE, CAREER SKILLS AND CAREER DEVELOPMENT BY INDIVIDUALS AND BUSINESSES, NAMELY, SURVEYS AND SURVEY ANSWER SHEETS FOR USE ONLINE (U.S. CLS. 100 AND 101).

SN 76-138,832. PRIMENET MARKETING SERVICES, INC., ST. PAUL, MN. FILED 10-2-2000.

POWER DIRECT SOLUTIONS

NO CLAIM IS MADE TO THE EXCLUSIVE RIGHT TO USE "DIRECT", APART FROM THE MARK AS SHOWN.

CLASS 35—ADVERTISING AND BUSINESS

FOR MARKETING, NAMELY, MAILING LIST PREPARATION AND DIRECT MAILING SERVICES SPECIFICALLY RELATING TO CUSTOMER INFORMATION FOR AUTOMOTIVE DEALERSHIPS (U.S. CLS. 100, 101 AND 102).

CLASS 42—SCIENTIFIC, COMPUTER AND LEGAL SERVICES

FOR PRINTING SERVICES FEATURING PRINTED ITEMS FOR AUTOMOTIVE DEALERSHIPS (U.S. CLS. 100 AND 101).

SN 76-139,057. IT FACTORY, INC., CAMBRIDGE, MA. FILED 9-29-2000.



THE STIPPLING SHOWN IN THE DRAWING IS A FEATURE OF THE MARK AND IS NOT INTENDED TO INDICATE COLOR.

CLASS 9—ELECTRICAL AND SCIENTIFIC APPARATUS

FOR COMPUTER SOFTWARE DEVELOPMENT TOOLS; COMPUTER DATABASE MANAGEMENT SOFTWARE FOR USE IN BUSINESS DEVELOPMENT; COMPUTER E-COMMERCE SOFTWARE TO ALLOW USERS TO PERFORM ELECTRONIC BUSINESS TRANSACTIONS VIA A GLOBAL COMPUTER NETWORK; AND COMPUTER SOFTWARE TO AUTOMATE DATA WAREHOUSING (U.S. CLS. 21, 23, 26, 36 AND 38).

CLASS 37—CONSTRUCTION AND REPAIR

FOR E-BUSINESS IMPLEMENTATION SERVICES, NAMELY INSTALLATION OF COMPUTER NETWORKS (U.S. CLS. 100, 103 AND 106).

CLASS 41—EDUCATION AND ENTERTAINMENT

FOR EDUCATIONAL SERVICES, NAMELY, ARRANGING AND CONDUCTING TRAINING, INSTRUCTIONAL AND INFORMATIVE SEMINARS AND WORKSHOPS CONCERNING COMPUTER SOFTWARE BUSINESS SOLUTIONS (U.S. CLS. 100, 101 AND 107).

CLASS 42—SCIENTIFIC, COMPUTER AND LEGAL SERVICES

FOR COMPUTER SERVICES, NAMELY, COMPUTER SOFTWARE DESIGN FOR OTHERS; MAINTENANCE OF COMPUTER SOFTWARE; COMPUTER SOFTWARE RENTAL; COMPUTER PROGRAMMING FOR OTHERS; COMPUTER SYSTEM DESIGN AND IMPLEMENTATION FOR OTHERS; COMPUTER PROJECT MANAGEMENT AND ADMINISTRATION FOR OTHERS; LEASING OF COMPUTER FACILITIES, NAMELY LEASING ACCESS TIME TO A COMPUTER DATABASES; CONSULTING SERVICES IN THE FIELD OF E-BUSINESS IMPLEMENTATION SERVICES; TECHNICAL SUPPORT SERVICES, NAMELY, TROUBLE SHOOTING OF COMPUTER HARDWARE AND SOFTWARE PROBLEMS VIA TELEPHONE, E-MAIL AND IN PERSON (U.S. CLS. 100 AND 101).

SN 76-139,317. ALFY, INC., NEW YORK, NY. FILED 10-3-2000.

A TREASURE CHEST OF LEARNING**CLASS 3—COSMETICS AND CLEANING PREPARATIONS**

FOR BATH AND BEAUTY PRODUCTS, NAMELY, SKIN SOAPS, HAND AND BODY LOTIONS, HAIR SHAMPOOS AND HAIR CONDITIONERS (U.S. CLS. 1, 4, 6, 50, 51 AND 52).

CLASS 9—ELECTRICAL AND SCIENTIFIC APPARATUS

FOR COMPUTERS; COMPUTER HARDWARE, CHILDREN'S EDUCATIONAL, GAME, AND ENTERTAINMENT COMPUTER SOFTWARE; COMPUTER PERIPHERALS; MULTIMEDIA SOFTWARE RECORDED ON CD-ROMS FOR TEACHING AND ENTERTAINING CHILDREN; PRE-RECORDED AUDIO AND VIDEO CASSETTES FOR TEACHING AND ENTERTAINING CHILDREN; DIGITAL CAMERAS (U.S. CLS. 21, 23, 26, 36 AND 38).

CLASS 16—PAPER GOODS AND PRINTED MATTER

FOR PAPER PRODUCTS, NAMELY, STATIONERY, POSTERS, COLORING BOOKS, CHILDREN'S ACTIVITY BOOKS, CHILDREN'S BOOKS, STICKERS, CALENDARS, GREETING CARDS AND GIFT WRAPPING PAPER; PAPER PARTY SUPPLIES, NAMELY, PARTY HATS, PAPER PARTY AND CAKE DECORATIONS, TABLECLOTHS AND NAPKINS; SCHOOL SUPPLIES, NAMELY, NOTEBOOKS, PENS AND PENCILS, AND CASES THEREFOR (U.S. CLS. 2, 5, 22, 23, 29, 37, 38 AND 50).

CLASS 18—LEATHER GOODS

FOR LUGGAGE, BACKPACKS AND GYM AND BOOK BAGS (U.S. CLS. 1, 2, 3, 22 AND 41).

SN 76-140,434. CASCO COURSEWARE LLC, CHEBEAGUE ISLAND, ME. FILED 10-5-2000.

CLASS 21—HOUSEWARES AND GLASS

FOR HOUSEHOLD TOOLS AND ACCESSORIES, NAMELY, SOAP DISHES, SOAP DISPENSERS, TOWEL RACKS, TOOTHBRUSH HOLDERS, ELECTRIC TOOTHBRUSHES, POTS AND METAL COOKING PANS, LUNCH BOXES; AND PAPER PARTY CUPS AND PLATES, CERAMIC CHRISTMAS ORNAMENTS (U.S. CLS. 2, 13, 23, 29, 30, 33, 40 AND 50).

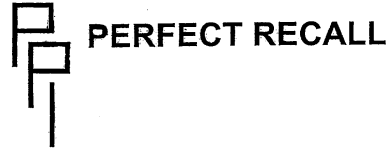
**CLASS 24—FABRICS**

FOR HOUSEHOLD ITEMS, NAMELY, BED SHEETS, TOWELS PILLOW CASES AND BED BLANKETS (U.S. CLS. 42 AND 50).

CLASS 9—ELECTRICAL AND SCIENTIFIC APPARATUS

FOR COMPUTER DATABASE SOFTWARE FOR USE BY STUDENTS WHICH EMPLOYS TESTS, QUIZZES AND DRILLS TO ASSIST IN THE LEARNING AND RETENTION OF COURSE MATERIALS (U.S. CLS. 21, 23, 26, 36 AND 38).

CLASS 25—CLOTHING

FOR CLOTHING, NAMELY, T-SHIRTS, HATS, CAPS, PAJAMAS, SWIMWEAR, FOOTWEAR, SOCKS, SHOES, HALLOWEEN AND MASQUERADE COSTUMES, AND UNIFORMS (U.S. CLS. 22 AND 39).

CLASS 16—PAPER GOODS AND PRINTED MATTER

FOR COMPUTER MANUALS FOR DATABASE SOFTWARE FOR USE BY STUDENTS WHICH EMPLOYS TESTS, QUIZZES DRILLS TO ASSIST IN THE LEARNING AND RETENTION OF COURSE MATERIALS; WORKBOOKS AND INSTRUCTIONAL PAMPHLETS IN THE FIELD OF STUDY AND LEARNING METHODS (U.S. CLS. 2, 5, 22, 23, 29, 37, 38 AND 50).

CLASS 28—TOYS AND SPORTING GOODS

FOR TOYS, NAMELY, PLUSH TOYS, ELECTRIC ACTION TOYS, HAND-HELD UNITS FOR PLAYING ELECTRONIC GAMES, BOARD GAMES, KITS FOR BUILDING OUTDOOR PLAY EQUIPMENT, CHRISTMAS TREE ORNAMENTS, BALLOONS, CHILDREN'S TOY COSMETICS, PARTY FAVORS IN THE NATURE OF SMALL TOYS, NOISEMAKERS (U.S. CLS. 22, 23, 38 AND 50).

SN 76-140,487. PAMP DISTRIBUTION S.A., 1211 GENEVA 3, SWITZERLAND, FILED 10-4-2000.

CLASS 30—STAPLE FOODS

FOR FOOD PRODUCTS, NAMELY, CEREAL-BASED SNACKS, CANDY, EDIBLE CAKE DECORATIONS, BREAKFAST CEREALS AND BEVERAGES, NAMELY, COFFEE AND TEA (U.S. CL. 46).

GOLD AVENUE

OWNER OF SWITZERLAND REG. NO. 473940, DATED 7-5-2000, EXPIRES 4-5-2010.

NO CLAIM IS MADE TO THE EXCLUSIVE RIGHT TO USE "GOLD", APART FROM THE MARK AS SHOWN.

CLASS 35—ADVERTISING AND BUSINESS

FOR RETAIL STORE SERVICES, ON-LINE RETAIL SERVICES AND MAIL ORDER CATALOG SERVICES, ALL FEATURING TOYS, CLOTHING, SOFTWARE, COMPUTERS, FOOD PRODUCTS, HOUSEHOLD TOOLS AND ACCESSORIES, BATH AND BEAUTY PRODUCTS, LUNCH BOXES, PARTY FAVORS AND DECORATIONS, AND OTHER NOVELTY ITEMS (U.S. CLS. 100, 101 AND 102).

CLASS 9—ELECTRICAL AND SCIENTIFIC APPARATUS

FOR ARTICLES OF SPECTACLE TRADE, NAMELY, SPECTACLES, EYEGLASSES, CONTACT LENSES, EYEGLASS CASES, EYEGLASS FRAMES, OPTICAL GLASSES, SUNGLASSES (U.S. CLS. 21, 23, 26, 36 AND 38).

CLASS 41—EDUCATION AND ENTERTAINMENT

FOR EDUCATIONAL AND ENTERTAINMENT SERVICES, NAMELY PROVIDING ONLINE GAMES AND EDUCATIONAL ACTIVITIES FOR CHILDREN VIA A GLOBAL COMPUTER NETWORK (U.S. CLS. 100, 101 AND 107).

CLASS 14—JEWELRY

FOR PRECIOUS METAL AND THEIR ALLOYS SOLD IN BULK AND AT RETAIL AND GOODS OF PRECIOUS METALS AND THEIR ALLOYS OR COATED THEREWITH, NAMELY, INGOTS, JEWELRY, WATCH MAKING AND CHRONOMETRIC INSTRUMENTS, NAMELY, CLOCKS, TABLE CLOCKS, WALL CLOCKS, WATCHES, POCKET WATCHES, WRISTWATCHES, WATCH MOVEMENTS, CHRONOMETERS AND PARTS THEREFOR, NAMELY WATCH BANDS, BRACELETS, WATCH DIALS, WINDING BUTTONS, WATCH BUCKLES, WATCH HANDS AND WATCH CASES, ALL THESE PRODUCTS ARE MADE IN WHOLE OR OF SUBSTANTIAL PART OF GOLD; PRECIOUS GEMSTONES; CIGARETTE LIGHTERS OF PRECIOUS METAL MADE IN WHOLE OR SUBSTANTIAL PART OF GOLD (U.S. CLS. 2, 27, 28 AND 50).

CLASS 42—SCIENTIFIC, COMPUTER AND LEGAL SERVICES

FOR COMPUTER SERVICES, NAMELY OPERATING AN INTERACTIVE WEBSITE FOR CHILDREN AND PROVIDING LINKS TO WEBSITES OF INTEREST TO CHILDREN VIA A GLOBAL COMPUTER NETWORK (U.S. CLS. 100 AND 101).

CLASS 16—PAPER GOODS AND PRINTED MATTER

FOR PAPER, NAMELY, WRITING PAPER AND WRAPPING PAPER; CARDBOARD; PAPER AND CARDBOARD GOODS, NAMELY, CARDBOARD BOXES; PRINTED MATTER, NAMELY, MAGAZINES, NEWSPAPERS, NEWSLETTERS AND BROCHURES IN THE FIELD OF PRECIOUS METALS, GEMSTONES, JEWELRY, ART, CHRONOMETRIC INSTRUMENTS AND SMOKER'S ARTICLES; STATIONERY; BOOKBINDING MATERIALS, NAMELY, BOOKBINDERS, BOOKBINDING WIRE, BOOKBINDING TAPE, CLOTH FOR BOOKBINDING; ARTIST'S MATERIALS, NAMELY, BRUSHES, PAINTING PENS AND PENCILS; PRINTED INSTRUCTIONAL AND TEACHING MATERIAL IN THE FIELD OF PRECIOUS METALS, GEMSTONES, JEWELRY, ART, CHRONOMETRIC INSTRUMENTS AND SMOKER'S ARTICLES; PLASTIC MATERIALS FOR PACKAGING, NAMELY, PLASTIC BUBBLE PACKS FOR WRAPPING AND PACKAGING; INSTRUMENTS FOR WRITING (U.S. CLS. 2, 5, 22, 23, 29, 37, 38 AND 50).

CLASS 34—SMOKERS' ARTICLES

FOR TOBACCO, SMOKER' ARTICLES, NAMELY, SMOKING PIPES, ASHTRAYS, NOT OF PRECIOUS METAL, MATCHES, CIGARETTE LIGHTERS FOR SMOKERS, NOT OF PRECIOUS METALS, CIGARETTE HOLDERS, NOT OF PRECIOUS METAL, CIGAR CUTTERS NOT OF PRECIOUS METAL (U.S. CLS. 2, 8, 9 AND 17).

CLASS 35—ADVERTISING AND BUSINESS

FOR RETAIL STORE SERVICES OR ONLINE COMPUTERIZED RETAIL SERVICES FEATURING PRODUCTS MADE OF GOLD, NAMELY, PRECIOUS METALS AND THEIR ALLOYS, INGOTS, JEWELRY, WATCH MAKING AND CHRONOMETRICAL INSTRUMENTS, PRECIOUS GEMSTONES, CIGARETTE LIGHTERS NOT OF PRECIOUS METAL AND OF PRECIOUS METAL MADE IN SUBSTANTIAL PART OF GOLD; ADVERTISING BY ELECTRONIC MEDIA, NAMELY, DISSEMINATION OF ADVERTISING FOR OTHERS VIA AN ONLINE ELECTRONIC COMMUNICATIONS NETWORK AND THE INTERNET; PROVISION OF TRADE INFORMATION VIA AN ONLINE ELECTRONIC COMMUNICATIONS NETWORK AND THE INTERNET (U.S. CLS. 100, 101 AND 102).

CLASS 39—TRANSPORTATION AND STORAGE

FOR DELIVERY OF GOODS ORDERED BY TELECOMMUNICATIONS MEANS VIA AIR, BOAT, RAIL AND TRUCK (U.S. CLS. 100 AND 105).

CLASS 42—SCIENTIFIC, COMPUTER AND LEGAL SERVICES

FOR PROVIDING ON-LINE INFORMATION ABOUT PRECIOUS METALS AND THEIR ALLOYS, INGOTS, JEWELRY, WATCH MAKING AND CHRONOMETRICAL INSTRUMENTS, PRECIOUS GEMSTONES, CIGARETTE LIGHTERS NOT OF PRECIOUS METAL AND OF PRECIOUS METAL MADE IN WHOLE OR SUBSTANTIAL PART OF GOLD (U.S. CLS. 100 AND 101).

SN 76-140,808. SIC MARKING, 69380 LISSIEU, FRANCE, FILED 10-4-2000.

SIC

PRIORITY CLAIMED UNDER SEC. 44(D) ON FRANCE APPLICATION NO. 00/3021187, FILED 4-7-2000, REG. NO. 53081, DATED 4-7-2000, EXPIRES 4-7-2010.

CLASS 7—MACHINERY

FOR MACHINE TOOLS NAMELY, STAMPING PRESSES; ENGRAVING MACHINES, MARKING HEADS, CHARACTERS AND STYLETS FOR ENGRAVING AND STAMPING MACHINES (U.S. CLS. 13, 19, 21, 23, 31, 34 AND 35).

CLASS 37—CONSTRUCTION AND REPAIR

FOR REPAIR, CLEANING AND MAINTENANCE FOR STAMPING AND ENGRAVING MACHINES, MACHINE TOOLS, TOOLS, INSTRUMENTS AS WELL AS THEIR CONSTITUTING PARTS (U.S. CLS. 100, 103 AND 106).

SN 76-142,593. ARENA FOOTBALL LEAGUE LLC, CHICAGO, IL. FILED 10-10-2000.

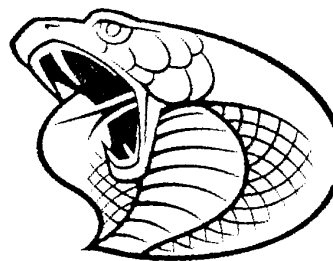

THE MARK CONSISTS OF A FANCIFUL DESIGN OF A COBRA SNAKE.

CLASS 16—PAPER GOODS AND PRINTED MATTER

FOR SOUVENIR PROGRAMS CONCERNING FOOTBALL GAMES, GENERAL MERCHANDISE CATALOGS, BUMPER STICKERS, WRITING PADS AND PENS, TRADING CARDS, POSTERS, FOOTBALL MAGAZINES, POST CARDS, CALENDARS, PAPER STICKERS, SERIES OF NON-FICTION BOOKS ON THE SPORT OF FOOTBALL, AND GREETING CARDS (U.S. CLS. 2, 5, 22, 23, 29, 37, 38 AND 50).

FIRST USE 11-18-1999; IN COMMERCE 11-18-1999.

CLASS 25—CLOTHING

FOR MEN'S, WOMEN'S AND CHILDREN'S CLOTHING, NAMELY, ATHLETIC UNIFORMS AND FOOTWEAR; CHEERLEADER UNIFORMS; REPLICA UNIFORM SHIRTS; JERSEYS, TOPS AND PANTS; COACHES' CAPS; WOOL HATS; PAINTERS' CAPS; BASEBALL CAPS; VISORS; HEADBANDS; BELTS; T-SHIRTS; TANK TOPS; GOLF SHIRTS; SWEATERS; SWEATSHIRTS; LEATHER JACKETS; NECKTIES; COATS; SHORTS; SWEAT PANTS; PANTS; SOCKS; AND UNDERWEAR (U.S. CLS. 22 AND 39).

FIRST USE 11-18-1999; IN COMMERCE 11-18-1999.

CLASS 41—EDUCATION AND ENTERTAINMENT

FOR ENTERTAINMENT SERVICES, NAMELY, ORGANIZING AND PRESENTING FOOTBALL GAMES BEFORE LIVE AUDIENCES AND ON TELEVISION, RADIO AND OTHER MEDIA (U.S. CLS. 100, 101 AND 107).

FIRST USE 11-18-1999; IN COMMERCE 11-18-1999.

SN 76-142,740. CORNERHARDWARE.COM, INC., SAN FRANCISCO, CA. FILED 10-6-2000.

SN 76-143,527. GOODY'S FAMILY CLOTHING, INC., KNOXVILLE, TN. FILED 10-10-2000.

ASK REX

THE NAME "REX" IDENTIFIES A LIVING INDIVIDUAL WHOSE CONSENT IS OF RECORD.

CLASS 35—ADVERTISING AND BUSINESS

FOR ON-LINE RETAIL STORE SERVICES FEATURING HOME IMPROVEMENT PRODUCTS (U.S. CLS. 100, 101 AND 102).

FIRST USE 5-7-2000; IN COMMERCE 5-7-2000.

CLASS 37—CONSTRUCTION AND REPAIR

FOR PROVIDING INFORMATION IN THE FIELD OF HOME IMPROVEMENT AND HOME IMPROVEMENT GOODS AND SERVICES VIA AN ON-LINE GLOBAL COMPUTER NETWORK (U.S. CLS. 100, 103 AND 106).

FIRST USE 5-7-2000; IN COMMERCE 5-7-2000.

SN 76-143,291. BOARD OF REGENTS OF THE UNIVERSITY OF NEBRASKA, THE, LINCOLN, NE. FILED 10-10-2000.



OWNER OF U.S. REG. NOS. 2,081,713, 2,117,700 AND OTHERS.

CLASS 16—PAPER GOODS AND PRINTED MATTER

FOR PAPER GOODS AND PRINTED MATTER, NAMELY NOTEBOOKS, NOTEPADS, STATIONERY, FOLDERS, POSTERS, CALENDARS, TRADING CARDS, POSTCARDS, DECALS, STICKERS, PENCILS, PENS, BINDERS; MAGAZINES, NEWSLETTERS, BOOKS AND PRINTED PROGRAMS RELATED TO ACTIVITIES OF OR SPONSORED BY THE UNIVERSITY (U.S. CLS. 2, 5, 22, 23, 29, 37, 38 AND 50).

CLASS 25—CLOTHING

FOR CLOTHING, NAMELY CAPS, JACKETS, SHIRTS, SWEAT PANTS, SWEATSHIRTS, T-SHIRTS, BOXER SHORTS, INFANT WEAR, AND ATHLETIC UNIFORMS (U.S. CLS. 22 AND 39).

CLASS 41—EDUCATION AND ENTERTAINMENT

FOR EDUCATION AND ENTERTAINMENT SERVICES, NAMELY PROVIDING COURSES OF INSTRUCTION AT THE UNIVERSITY LEVEL, CONDUCTING EDUCATIONAL RESEARCH, ARRANGING AND CONDUCTING ATHLETIC EVENTS AND TOURNAMENTS, UNIVERSITY EDUCATIONAL EXHIBITIONS, UNIVERSITY EDUCATIONAL CONFERENCES, LIVE PERFORMANCES AND FESTIVALS (U.S. CLS. 100, 101 AND 107).

ACCESSORY CROSSING

NO CLAIM IS MADE TO THE EXCLUSIVE RIGHT TO USE "ACCESSORY", APART FROM THE MARK AS SHOWN.

CLASS 14—JEWELRY

FOR JEWELRY (U.S. CLS. 2, 27, 28 AND 50).

CLASS 18—LEATHER GOODS

FOR HANDBAGS (U.S. CLS. 1, 2, 3, 22 AND 41).

CLASS 25—CLOTHING

FOR SOCKS (U.S. CLS. 22 AND 39).

SN 76-143,590. BOARD OF REGENTS OF THE UNIVERSITY OF NEBRASKA, THE, LINCOLN, NE. FILED 10-10-2000.

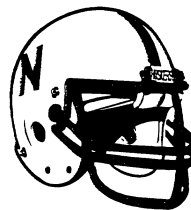

OWNER OF U.S. REG. NOS. 2,081,713, 2,195,998 AND OTHERS.

THE MARK CONSISTS IN PART OF THE TERM "HUSKERS"- DISPLAYED ON THE FRONT OF A FOOTBALL HELMET.

CLASS 16—PAPER GOODS AND PRINTED MATTER

FOR PAPER GOODS AND PRINTED MATTER, NAMELY NOTEBOOKS, NOTEPADS, STATIONERY, FOLDERS, POSTERS, CALENDARS, TRADING CARDS, POSTCARDS, DECALS, STICKERS, PENCILS, PENS, BINDERS; MAGAZINES, NEWSLETTERS, BOOKS AND PRINTED PROGRAMS RELATED TO ACTIVITIES OF OR SPONSORED BY THE UNIVERSITY (U.S. CLS. 2, 5, 22, 23, 29, 37, 38 AND 50).

CLASS 25—CLOTHING

FOR CLOTHING, NAMELY CAPS, JACKETS, SHIRTS, SWEAT PANTS, SWEATSHIRTS, T-SHIRTS, BOXER SHORTS, INFANT WEAR, AND ATHLETIC UNIFORMS (U.S. CLS. 22 AND 39).

CLASS 41—EDUCATION AND ENTERTAINMENT

FOR EDUCATION AND ENTERTAINMENT SERVICES, NAMELY PROVIDING COURSES OF INSTRUCTION AT THE UNIVERSITY LEVEL, CONDUCTING EDUCATIONAL RESEARCH, ARRANGING AND CONDUCTING ATHLETIC EVENTS AND TOURNAMENTS, UNIVERSITY EDUCATIONAL EXHIBITIONS, UNIVERSITY EDUCATIONAL CONFERENCES, LIVE PERFORMANCES AND FESTIVALS (U.S. CLS. 100, 101 AND 107).

SN 76-143,606. MIDWEST ENERGY, INC., CASSOPOLIS, MI. FILED 10-10-2000.

SN 76-146,476. FLYTOUR AGENCIA DE VIAGENS E TURISMO LTDA., BRAZIL, FILED 10-13-2000.



NO CLAIM IS MADE TO THE EXCLUSIVE RIGHT TO USE "MIDWEST" AND "ENERGY" AND "COOPERATIVE", APART FROM THE MARK AS SHOWN.

CLASS 39—TRANSPORTATION AND STORAGE

FOR ELECTRICITY UTILITY SERVICES, NAMELY, ELECTRICITY DISTRIBUTION (U.S. CLS. 100 AND 105).

CLASS 42—SCIENTIFIC, COMPUTER AND LEGAL SERVICES

FOR ENERGY CONSULTING SERVICES, NAMELY LOAD MANAGEMENT PROGRAMS FOR REDUCING PEAK ELECTRICAL USAGE, CONDUCTING ENERGY AUDITS, AND PROVIDING POWER QUALITY ANALYSIS AND RESOLUTION (U.S. CLS. 100 AND 101).



CLASS 39—TRANSPORTATION AND STORAGE

FOR TRAVEL AGENCY SERVICES, NAMELY, LEISURE AND BUSINESS TRAVEL RESERVATIONS, ARRANGING AND CONDUCTING TRAVEL AND VACATION PACKAGES, BOOKING AND ARRANGING AIR, LAND AND SEA TRANSPORTATION FOR BUSINESS AND LEISURE TRAVEL, COORDINATING AND PLANNING LEISURE AND BUSINESS TRAVEL ARRANGEMENTS FOR INDIVIDUALS AND GROUPS, EXCLUDING LODGING ARRANGEMENTS, NAMELY ARRANGING, CONSOLIDATING, AND ISSUING AIR, LAND, AND SEA TRAVEL TICKETS, ARRANGING FOR TRAVEL VISAS, PASSPORTS AND TRAVEL DOCUMENTS, SPONSORING AND ARRANGING TRAVEL TOURS VIA A GLOBAL COMPUTER NETWORK, IN PERSON, BY TELEPHONE AND VIA PRINT MEDIA (U.S. CLS. 100 AND 105).

FIRST USE 5-10-1993; IN COMMERCE 5-4-1994.

CLASS 42—SCIENTIFIC, COMPUTER AND LEGAL SERVICES

FOR TRAVEL AGENCY SERVICES, NAMELY, MAKING RESERVATIONS AND BOOKING FOR TEMPORARY LODGING FOR BUSINESS AND LEISURE TRAVEL VIA A GLOBAL COMPUTER NETWORK, IN PERSON, BY TELEPHONE AND VIA PRINT MEDIA (U.S. CLS. 100 AND 101).

FIRST USE 5-10-1993; IN COMMERCE 5-4-1994.

SN 76-146,681. FENDER MUSEUM OF THE ARTS FOUNDATION, CORONA, CA. FILED 10-16-2000.

SN 76-145,733. ENSERA, INC., REDWOOD SHORES, CA. FILED 10-12-2000.

ION CONNECTION

CLASS 35—ADVERTISING AND BUSINESS

FOR BUSINESS EXCHANGE SERVICES, NAMELY BARTERING OF GOODS AND SERVICES OF OTHERS VIA A GLOBAL COMPUTER NETWORK IN THE AUTOMOBILE COLLISION REPAIR INDUSTRY; ORDERING SERVICES FOR OTHERS IN THE FIELD OF AUTOMOBILE COLLISION REPAIR INDUSTRY (U.S. CLS. 100, 101 AND 102).

CLASS 37—CONSTRUCTION AND REPAIR

FOR PROVIDING INFORMATION VIA A GLOBAL COMPUTER NETWORK IN THE FIELD OF THE AUTOMOBILE COLLISION REPAIR INDUSTRY (U.S. CLS. 100, 103 AND 106).



THE MARK CONSISTS OF A STYLIZED REPRESENTATION OF A MUSICAL SYMBOL.

CLASS 6—METAL GOODS

FOR METAL GOODS, NAMELY KEY CHAINS (U.S. CLS. 2, 12, 13, 14, 23, 25 AND 50).

CLASS 14—JEWELRY

FOR ORNAMENTAL DECORATIVE PINS (U.S. CLS. 2, 27, 28 AND 50).
FIRST USE 1-0-2000; IN COMMERCE 1-0-2000.

CLASS 16—PAPER GOODS AND PRINTED MATTER

FOR BASED ON USE IN COMMERCE PRINTED MATERIALS, NAMELY A NEWSLETTER CONCERNING MUSEUM SERVICES AND PERFORMING ARTS EDUCATION AND POSTERS, BASED ON INTENT TO USE WRITING INSTRUMENTS, NAMELY PENS AND PENCILS; DECALS, BUMPER STICKERS AND STICKERS (U.S. CLS. 2, 5, 22, 23, 29, 37, 38 AND 50).
FIRST USE 4-0-1999; IN COMMERCE 4-0-1999.

CLASS 18—LEATHER GOODS

FOR BACKPACKS (U.S. CLS. 1, 2, 3, 22 AND 41).

CLASS 20—FURNITURE AND ARTICLES NOT OTHERWISE CLASSIFIED

FOR BASED ON USE IN COMMERCE PICTURE FRAMES, BASED ON INTENT TO USE NON-METAL KEY CHAINS (U.S. CLS. 2, 13, 22, 25, 32 AND 50).
FIRST USE 11-0-1999; IN COMMERCE 11-0-1999.

CLASS 21—HOUSEWARES AND GLASS

FOR HOUSEHOLD GOODS, NAMELY COFFEE MUGS AND DRINKING GLASSES (U.S. CLS. 2, 13, 23, 29, 30, 33, 40 AND 50).
FIRST USE 7-0-1999; IN COMMERCE 7-0-1999.

CLASS 25—CLOTHING

FOR MEN'S, WOMEN'S AND CHILDREN'S CLOTHING, NAMELY HATS, SWEATSHIRTS AND T-SHIRTS (U.S. CLS. 22 AND 39).
FIRST USE 8-0-1999; IN COMMERCE 8-0-1999.

SN 76-147,827. KARL, ALLAN F., COSTA MESA, CA. FILED 10-16-2000.

COMPETE IN THE NEW ECONOMY

CLASS 9—ELECTRICAL AND SCIENTIFIC APPARATUS

FOR COMPUTER SOFTWARE DEVELOPMENT TOOLS; COMPUTER SEARCH ENGINE SOFTWARE; COMPUTER SOFTWARE TO GENERATE BANNERS ON WEBSITES FOR ADVERTISING AND ENTERTAINMENT PURPOSES, THAT ENABLES REAL-TIME INTERCOMMUNICATIONS, SIMULTANEOUS DATA MANIPULATION AND INSTANTANEOUS FEEDBACK FOR ANALYZING WEBSITE MARKETING DATA TO STORE, THAT MAY BE DOWNLOADED FROM A GLOBAL COMPUTER NETWORK; AUDIO AND VIDEO MULTIMEDIA STREAMING SOFTWARE FOR USE IN COMPRESSING AND PROCESSING IMAGES AND VIDEO FOR USE ON A GLOBAL COMPUTER NETWORK (U.S. CLS. 21, 23, 26, 36 AND 38).

CLASS 35—ADVERTISING AND BUSINESS

FOR BUSINESS MARKETING CONSULTING SERVICES; BUSINESS CONSULTING SERVICES IN THE FIELD OF MARKETING COMMUNICATIONS, MARKETING RESEARCH, PUBLIC RELATION SERVICES, PROVIDING BUSINESS TECHNIQUES RELATING TO E-COMMERCE AND THE GLOBAL COMPUTER NETWORK AND COMPUTER TECHNOLOGY INTEGRATION AND ARCHITECTURE SERVICES RELATED THERETO; ADVERTISING AGENCY SERVICES; PREPARING AUDIO-VISUAL PRESENTATIONS FOR USE IN ADVERTISING (U.S. CLS. 100, 101 AND 102).
FIRST USE 4-1-2000; IN COMMERCE 4-1-2000.

CLASS 41—EDUCATION AND ENTERTAINMENT

FOR VIDEOTAPE, CD-ROM, AND DVD PRODUCTION SERVICES; ONLINE COMPUTER EDUCATION TRAINING REGARDING THE USE OF CUSTOMIZED SOFTWARE APPLICATIONS (U.S. CLS. 100, 101 AND 107).
FIRST USE 4-1-2000; IN COMMERCE 4-1-2000.

CLASS 42—SCIENTIFIC, COMPUTER AND LEGAL SERVICES

FOR WEBSITE DESIGN AND DEVELOPMENT SERVICES; DESIGN OF MULTIMEDIA SOFTWARE RECORDED ON CD-ROM FOR MARKETING, ADVERTISING, TRAINING AND COMMUNICATION PURPOSES; CUSTOM DESIGN OF COMPUTER SOFTWARE IN MULTIPLE FIELDS FOR OTHERS; COMPUTER SOFTWARE DESIGN CONSULTATION (U.S. CLS. 100 AND 101).
FIRST USE 4-1-2000; IN COMMERCE 4-1-2000.

SN 76-148,024. LICO BRANDS, INC., STOCKTON, CA. FILED 10-18-2000.

SAN BAUTISTA

OWNER OF U.S. REG. NO. 1,545,507.
THE ENGLISH TRANSLATION OF "SAN BAUTISTA" IS "SAINT BAPTIST".

CLASS 29—MEATS AND PROCESSED FOODS

FOR CANNED GOODS, NAMELY, CANNED TOMATOES (U.S. CL. 46).

CLASS 30—STAPLE FOODS

FOR TOMATO BASED FOOD SAUCES (U.S. CL. 46).

SN 76-148,232. STELLCOM, INC., SAN DIEGO, CA. FILED 10-17-2000.

ENGINEERING A WIRELESS WORLD

CLASS 35—ADVERTISING AND BUSINESS

FOR BUSINESS CONSULTATION SERVICES, NAMELY, ASSESSMENT OF AND PROVIDING SOLUTIONS FOR ELECTRONIC BUSINESS AND COMMERCE FOR OTHERS, PROVIDING TECHNOLOGY INTEGRATION SOLUTIONS, AND PROVIDING INFORMATION TECHNOLOGY STAFFING SERVICES FOR OTHERS (U.S. CLS. 100, 101 AND 102).
FIRST USE 10-9-2000; IN COMMERCE 10-9-2000.

CLASS 42—SCIENTIFIC, COMPUTER AND LEGAL SERVICES

FOR COMPUTER SERVICES, NAMELY DESIGN OF COMPUTER HARDWARE AND SOFTWARE FOR OTHERS FOR USE IN CONNECTION WITH EMBEDDED INTELLIGENCE IN APPLIANCES AND VARIOUS DEVICES FOR USE IN CONNECTION WITH GLOBAL COMPUTER AND COMMUNICATION NETWORKS, WEB SITE DESIGN SERVICES, AND DESIGN AND CUSTOMIZATION OF COMPUTER HARDWARE AND SOFTWARE APPLICATIONS FOR OTHERS (U.S. CLS. 100 AND 101).

FIRST USE 10-9-2000; IN COMMERCE 10-9-2000.

SN 76-148,712. DENSEI-LAMBDA K.K., SHINAGAWA-KU, TOKYO, JAPAN, FILED 10-17-2000.

CLASS 37—CONSTRUCTION AND REPAIR

FOR INSTALLATION OF TELECOMMUNICATION WIRING AND FLOOR WIRING, REPAIR AND MAINTENANCE OF SWITCHING POWER SUPPLY, REPAIR AND MAINTENANCE OR NOISE FILTER, REPAIR AND MAINTENANCE OF UPS (UNINTERRUPTIBLE POWER SUPPLY), REPAIR MAINTENANCE OF MEASURING AND/OR TESTING MACHINES AND INSTRUMENT, REPAIR AND MAINTENANCE OF ELECTRICAL COMMUNICATION APPARATUS, REPAIR AND MAINTENANCE OF COMPUTERS, INCLUDING, CENTRAL PROCESSING UNIT, PROGRAM-ENCODED ELECTRONIC CIRCUITS OR MAGNETIC DISKS, AND OTHER PERIPHERAL EQUIPMENT, REPAIR AND MAINTENANCE OF POWER DISTRIBUTION AND APPARATUS, REPAIR AND MAINTENANCE OF POWER GENERATORS, REPAIR AND MAINTENANCE OF MOTOR, REPAIR AND MAINTENANCE OF HOUSEHOLD ELECTRIC APPLIANCES, INSTALLATION OF TELECOMMUNICATION EQUIPMENT, INSTALLATION OF SWITCHBOARDS AND CONTROL PANELS, MACHINERY INSTALLATION, MAINTENANCE AND REPAIR, ELECTRIC APPLIANCE INSTALLATION AND REPAIR, OFFICE MACHINES AND EQUIPMENT INSTALLATION, MAINTENANCE AND REPAIR, REPAIR AND MAINTENANCE OF ELECTRIC TRANSFORMERS, REPAIR OF DC-DC AND DC-AC CONVERTERS, MAINTENANCE AND INSPECTION OF POWER SOURCE UNITS, MAINTENANCE AND INSPECTION OF BATTERIES, REPAIR INFORMATION RELATION TO ELECTRIC WORKS (U.S. CLS. 100, 103 AND 106).

SN 76-148,720. AVOCENT CORPORATION, HUNTSVILLE, AL. FILED 10-17-2000.

 **DENSEI-LAMBDA**

**THE POWER OF BEING
THERE**

CLASS 9—ELECTRICAL AND SCIENTIFIC APPARATUS

FOR SWITCHING POWER SUPPLY, DC-DC POWER MODULE, POWER MODULE FOR TELECOMMUNICATION, ON BOARD POWER SUPPLY, MODULAR WATT-BOX, VARIABLE TYPE POWER SUPPLY, CELL SWITCHES, SWITCHES, NOISE FILTER UPS (UNINTERRUPTIBLE POWER SUPPLY), BATTERY, SEALED-LEAD RECHARGEABLE BATTERY, GALVANIC BATTERIES, GALVANIC CELLS, HIGH-TENSION BATTERIES, SOLAR BATTERIES, BATTERY BOXES, BATTERY CHARGERS, CONTROLS FOR TEMPERATURE AND PROCESS CONTROLLER/GRAPHICAL DISPLAY RECORDER, ACCUMULATORS, DYNAMOMETERS, AMMETERS, AMPLIFIERS, CABLES, CAPACITORS, CIRCUIT BREAKERS, COILS, APPARATUS FOR COMMUTATION OF ELECTRICITY, COMMUTATORS, CONDUCTORS ELECTRIC CONNECTIONS, ELECTRICITY CONNECTORS, CONTACTS, CONTROL PANELS, CONVERTERS, DC-DC CONVERTERS, AC-DC CONVERTERS, CURRENT RECTIFIERS, DISTRIBUTION BOARDS, SWITCHBOARDS, DISTRIBUTION BOXES, SWITCHBOXES, DISTRIBUTION CONSOLES, FUSE WIRE, FUSE, ELECTRICITY INDICATORS, INDUCTORS, INTERFACES, INVERTERS, SLEEVES FOR ELECTRIC CABLES, LIMITERS, PLATES FOR BATTERIES, RELAYS, RESISTANCES, TRANSFORMERS, TRANSMITTERS, ELECTRICAL WIRES (U.S. CLS. 21, 23, 26, 36 AND 38).

CLASS 9—ELECTRICAL AND SCIENTIFIC APPARATUS

FOR COMPUTER PERIPHERALS FOR ACCESSING AND CONTROLLING MULTIPLE COMPUTERS AND SERVERS WITH A SINGLE KEYBOARD, MONITOR AND MOUSE; COMPUTER PERIPHERALS ALLOWING A PLURALITY OF USERS TO INDEPENDENTLY ACCESS AND CONTROL A PLURALITY OF COMPUTERS; COMPUTER PERIPHERALS FOR REMOTE ACCESS AND CONTROL OF COMPUTERS AND SERVERS; SWITCHES FOR CONTROLLING A PLURALITY OF COMPUTERS AND WITH A SINGLE KEYBOARD, MONITOR AND MOUSE, REMOTE CONTROL APPARATUS FOR COMPUTERS; CABLE SPLITTERS AND TELEPHONE-ACTIVATED POWER SWITCHES; EXTENSION AND EXPANSION APPARATUS AND CABLES FOR LINKING COMPUTERS WITH PERIPHERALS, KEYBOARDS, VIDEO DISPLAY MONITORS AND MICE; COMPUTER HARDWARE; NAMELY DISPLAY TERMINALS, MONITORS AND INTERFACE CARDS AND COMPUTER OPERATING SOFTWARE; COMPUTER PERIPHERALS; COMPUTER HARDWARE AND ASSOCIATED SOFTWARE FOR ON-SCREEN PROGRAMMING OF COMPUTER PERIPHERALS; COMPUTER PERIPHERALS HARDWARE FOR TRANSMITTING KEYBOARD, MOUSE AND VIDEO SIGNALS BETWEEN A LOCAL COMPUTER AND A REMOTE COMPUTER OVER A COMPUTER COMMUNICATIONS LINK; CLIENT/SERVER COMPUTER CONSOLE SWITCHING SYSTEMS COMPRISING COMPUTER HARDWARE AND SOFTWARE TO CONNECT SERVERS; SUPPORTING CABINETS SPECIFICALLY INTENDED TO HOUSE NETWORK SERVERS AND COMPUTER COMMUNICATIONS SYSTEMS; RACKS SPECIFICALLY INTENDED FOR USE IN MOUNTING COMPUTER EQUIPMENT; AND MANUALS SOLD AS A UNIT WITH EACH OF THE AFORESAID GOODS (U.S. CLS. 21, 23, 26, 36 AND 38).

CLASS 41—EDUCATION AND ENTERTAINMENT

FOR DEALER TRAINING SERVICES IN THE FIELD OF COMPUTER SWITCHING, EXTENSION AND REMOTE ACCESS PRODUCTS (U.S. CLS. 100, 101 AND 107).

CLASS 42—SCIENTIFIC, COMPUTER AND LEGAL SERVICES

FOR COMPUTER CONSULTATION SERVICES; NAMELY, PROVIDING TECHNICAL SERVICE AND PRODUCT SUPPORT SERVICES IN THE FIELD OF COMPUTER SWITCHING, EXTENSION AND REMOTE ACCESS PRODUCTS (U.S. CLS. 100 AND 101).

SN 76-148,757. PILEJE, 75007 PARIS, FRANCE, FILED 10-17-2000.

LACTIBIANE

OWNER OF FRANCE REG. NO. 515700, DATED 6-4-1999, EXPIRES 6-4-2009.

CLASS 5—PHARMACEUTICALS

FOR PHARMACEUTICAL AND VETERINARY PREPARATIONS FOR THE TREATMENT OF DIARRHEA, INTESTINAL FUNCTIONAL DISORDERS, CONSTIPATION, DIGESTIVE DISORDERS; DIETETIC SUBSTANCES ADAPTED FOR MEDICAL USE, NAMELY, PROBIOTIC OR PREBIOTIC MILK FERMENTS FOR MEDICAL USE; DIETARY SUPPLEMENTS; FOOD SUPPLEMENTS NOT FOR MEDICAL PURPOSES AND FOR HUMAN CONSUMPTION ONLY, NAMELY, PREBIOTIC OR PROBIOTIC MILK FERMENTS AND NUTRITIONAL SUPPLEMENTS FOR MEDICAL PURPOSES, NAMELY, PROBIOTIC OR PREBIOTIC MILK FERMENTS; NON-NUTRITIVE EDIBLE PLANT FIBERS FOR USE AS A LAXATIVE; MINERAL SUPPLEMENTS WITH TRACE ELEMENTS FOR HUMANS AND ANIMAL FEED CONTAINING TRACE ELEMENTS; VITAMINS; FOOD FOR BABIES; PLASTERS FOR MEDICAL PURPOSES (U.S. CLS. 6, 18, 44, 46, 51 AND 52).

CLASS 29—MEATS AND PROCESSED FOODS

FOR PRESERVED, DRIED AND COOKED FRUITS AND VEGETABLES; JELLIES, JAMS, FRUIT SAUCES; EGGS, EDIBLE OILS AND FATS; PRESERVES WITH A MEAT, FISH, POULTRY OR GAME BASE; MILK AND MILK PRODUCTS, EXCLUDING ICE CREAM, ICE MILK AND FROZEN YOGURT; MILK FERMENT NOT FOR PHARMACEUTICAL PURPOSES AND FOR HUMAN CONSUMPTION ONLY (U.S. CL. 46).

CLASS 30—STAPLE FOODS

FOR TEA, COCOA, SUGAR; RICE, TAPIOCA, SAGO; CEREAL-BASED SNACK FOOD, BREAD; FLAVORED ICES; HONEY, TREACLE; YEAST, BAKING-POWDER, SALT, MUSTARD, VINEGAR, CONDIMENT SAUCES, SALAD DRESSINGS, SPICES, ICE (U.S. CL. 46).

SN 76-148,789. MAXPITCH MEDIA, INC., FAIRFAX, VA. FILED 10-17-2000.

JUST SELL

NO CLAIM IS MADE TO THE EXCLUSIVE RIGHT TO USE "SELL", APART FROM THE MARK AS SHOWN.

CLASS 35—ADVERTISING AND BUSINESS

FOR PROVIDING INFORMATION IN THE FIELDS OF SALES-INTELLIGENCE, MARKETING, SALES ACTIVITIES, SALES-PROSPECTING, OPINIONS ADVICE VIA A GLOBAL COMMUNICATIONS NETWORK, FEATURING ON-LINE BUSINESS CONSULTING SERVICES, NAMELY ADVICE TO CUSTOMERS BY MEANS OF FAXES, E-MAILS, AND ELECTRONIC REPRESENTATIONS OF WRITTEN MATERIAL (U.S. CLS. 100, 101 AND 102).

FIRST USE 4-1-1998; IN COMMERCE 4-1-1998.

CLASS 41—EDUCATION AND ENTERTAINMENT

FOR PROVIDING INFORMATION IN THE FIELD OF SALES TRAINING BY MEANS OF A GLOBAL COMMUNICATIONS NETWORK, FAXES, E-MAILS AND ELECTRONIC REPRESENTATIONS OF WRITTEN MATERIAL (U.S. CLS. 100, 101 AND 107).

FIRST USE 10-0-1998; IN COMMERCE 10-0-1998.

SN 76-148,978. BANCA POPOLARE DI MILANO SOCIETA COOPERATIVA A.R.L., 20121 MILAN, ITALY, FILED 10-18-2000.

WE@

CLASS 9—ELECTRICAL AND SCIENTIFIC APPARATUS

FOR COMPUTER PROGRAMS FOR DATA TRANSMISSION, PROCESSING, MANAGEMENT AND ANALYSIS; MAGNETIC DATA CARRIERS, INCLUDING MAGNETIC DISKS; OPTICAL DATA CARRIERS, INCLUDING OPTICAL DISKS; MAGNETIC TAPE UNITS FOR COMPUTERS, ALL FOR THE TRANSPORT OF THE ABOVE-MENTIONED COMPUTER PROGRAMS (U.S. CLS. 21, 23, 26, 36 AND 38).

CLASS 35—ADVERTISING AND BUSINESS

FOR DATA PROCESSING, NAMELY, INFORMATION MANAGEMENT, PROCESSING AND ENCODING (U.S. CLS. 100, 101 AND 102).

CLASS 36—INSURANCE AND FINANCIAL

FOR INSURANCE BROKERAGE SERVICES; BANKING SERVICES, MONETARY EXCHANGE SERVICES; REAL ESTATE BROKERAGE SERVICES; PROVIDING AN ONLINE COMPUTER DATABASE FEATURING BANKING, INSURANCE AND REAL ESTATE INFORMATION (U.S. CLS. 100, 101 AND 102).

CLASS 38—COMMUNICATION

FOR TELECOMMUNICATIONS SERVICES, NAMELY, ELECTRONIC MESSAGES TRANSMISSION, RENTAL OF MESSAGES TRANSMISSION EQUIPMENT, ELECTRONIC MESSAGES AND IMAGES TRANSMISSION WITH THE AID OF A COMPUTER (U.S. CLS. 100, 101 AND 104).

CLASS 42—SCIENTIFIC, COMPUTER AND LEGAL SERVICES

FOR COMPUTER CONSULTATION IN THE FIELD OF SOFTWARE DEVELOPMENT (U.S. CLS. 100 AND 101).

SN 76-149,890. LOGISCO, INC., NASHVILLE, TN. FILED 10-19-2000.

LOGISCO

CLASS 35—ADVERTISING AND BUSINESS

FOR PACKAGING ARTICLES TO THE ORDER AND SPECIFICATION OF OTHERS (U.S. CLS. 100, 101 AND 102).

FIRST USE 8-0-1998; IN COMMERCE 8-0-1998.

CLASS 36—INSURANCE AND FINANCIAL

FOR CUSTOMS BROKERAGE (U.S. CLS. 100, 101 AND 102).

FIRST USE 8-0-1998; IN COMMERCE 8-0-1998.

CLASS 39—TRANSPORTATION AND STORAGE

FOR PUBLIC AND CONTRACT WAREHOUSING SERVICES; INTERNATIONAL FREIGHT FORWARDING; DOMESTIC EXPEDITED DELIVERY BY AIR AND/OR GROUND TRANSPORTATION; PACKAGING ARTICLES FOR TRANSPORT; CARGO HANDLING; STORAGE AND HANDLING OF CHEMICALS AND HAZARDOUS MATERIALS; AND REFRIGERATION STORAGE (U.S. CLS. 100 AND 105).

FIRST USE 8-0-1998; IN COMMERCE 8-0-1998.

CLASS 40—MATERIAL TREATMENT

FOR ASSEMBLY OF PRODUCTS FOR OTHERS; REMOVAL OF HIGH VALUE PRODUCTS FOR OTHERS (U.S. CLS. 100, 103 AND 106).

FIRST USE 8-0-1998; IN COMMERCE 8-0-1998.

SN 76-149,939. NOEL BIOCARE AB, SE 402 26 GOTHENBURG, SWEDEN, FILED 10-19-2000.

TEETH NOW

OWNER OF SWEDEN REG. NO. 347341, DATED 7-6-2001, EXPIRES 7-6-2010.

NO CLAIM IS MADE TO THE EXCLUSIVE RIGHT TO USE "TEETH", APART FROM THE MARK AS SHOWN.

CLASS 5—PHARMACEUTICALS

FOR MATERIAL FOR TEETH, NAMELY, FILLINGS FOR TEETH, DENTAL IMPRESSION MATERIAL AND DENTAL PORCELAIN FOR FILLING TEETH; PORCELAIN, PLASTIC, TITANIUM, AND PRECIOUS METAL ALLOYS FOR DENTAL CROWNS, BRIDGES, MENDING TEETH, RESTORATION AND RECONSTRUCTION OF TEETH AND FOR FILLING TEETH; DENTAL WAX (U.S. CLS. 6, 18, 44, 46, 51 AND 52).

CLASS 10—MEDICAL APPARATUS

FOR ODONTOLOGICAL IMPLANTS OF ARTIFICIAL MATERIAL, ORTHOPEDIC JOINT IMPLANTS, ORTHOPEDIC ARTICLES, NAMELY, BELTS, BRACES, FOOTWEAR AND SURGICAL IMPLANTS COMPRISING ARTIFICIAL MATERIAL; SURGICAL, MEDICAL AND ODONTOLOGICAL INSTRUMENTS, NAMELY, INSTRUMENTS AND APPARATUS FOR RECONSTRUCTION AND REHABILITATION OF TISSUE-ANCHORED NON-BIOLOGICAL PROSTHESES AND EPITHESES; ARTIFICIAL LIMBS, EYES AND TEETH (U.S. CLS. 26, 39 AND 44).

CLASS 40—MATERIAL TREATMENT

FOR TREATMENT OF METAL ALLOYS, PORCELAIN, TITANIUM, AND OTHER BIOCOMPATIBLE MATERIALS, NAMELY ALLOYS OF TITANIUM, CERAMIC, METALS AND GOLD (U.S. CLS. 100, 103 AND 106).

CLASS 41—EDUCATION AND ENTERTAINMENT

FOR EDUCATION AND TRAINING SERVICES, NAMELY ARRANGING AND CONDUCTING SEMINARS ABOUT IMPLANTATION SURGERY AND IMPLANTATION TECHNIQUES (U.S. CLS. 100, 101 AND 107).

CLASS 42—SCIENTIFIC, COMPUTER AND LEGAL SERVICES

FOR TECHNICAL ADVISORY SERVICES, IN THE FIELD OF SURGICAL ACTIVITIES; PROVIDING SURGICAL INFORMATION, RESEARCH AND DEVELOPMENT IN THE SURGICAL FIELD; RENTAL OF DENTAL AND SURGICAL EQUIPMENT AND DEVICES (U.S. CLS. 100 AND 101).

SN 76-150,491. SOMMERS, JAMES, BEVERLY HILLS, CA. FILED 10-19-2000.

RAP-A-BABY

CLASS 9—ELECTRICAL AND SCIENTIFIC APPARATUS

FOR MUSICAL SOUND RECORDINGS (U.S. CLS. 21, 23, 26, 36 AND 38).

CLASS 25—CLOTHING

FOR CLOTHING - NAMELY, JACKETS, SHIRTS, PANTS AND HATS (U.S. CLS. 22 AND 39).

SN 76-150,899. BENIKO, INC., LOS ANGELES, CA. FILED 10-23-2000.

PX

CLASS 18—LEATHER GOODS

FOR BACKPACKS; ALL-PURPOSE ATHLETIC BAGS; TOTE BAGS; HANDBAG; LUGGAGE; DUFFEL BAGS; BRIEFCASES; CARRY-ON BAGS AND WAIST PACKS (U.S. CLS. 1, 2, 3, 22 AND 41).

CLASS 25—CLOTHING

FOR CLOTHING, OUTERWEAR, AND ATHLETIC WEAR, NAMELY, PANTS, SHIRTS, SHORTS, SUITS, SWEATERS, JACKETS, UNDERWEAR, SWIMWEAR, HOSIERY, VEST, SOCKS, SKIRTS, DRESSES, COATS, SHOES, HATS, AND BELTS (U.S. CLS. 22 AND 39).

SN 76-150,978. BTF PA CORPORATION, CHICAGO, IL. BY ASSIGNMENT SPREE.COM CORP., WEST CHESTER, PA. FILED 10-20-2000.

SN 76-152,760. MEDICINOVA, INC., SAN DIEGO, CA. FILED 10-24-2000.

EVP

CLASS 35—ADVERTISING AND BUSINESS

FOR COMPUTER SERVICES, NAMELY, PROVIDING AN AFFINITY SITE WHEREIN USERS MAY PURCHASE VARIOUS GOODS ON A GLOBAL COMPUTER NETWORK; ADVERTISING AND MARKETING SERVICES PROVIDED TO ONLINE BUSINESSES, NAMELY PROMOTING THE GOODS AND SERVICES OF OTHERS THROUGH CREATING AND PLACING ELECTRONIC ADVERTISEMENTS AND DIRECT MARKETING COMMUNICATIONS ON AN ELECTRONIC WEBSITE ACCESSED THROUGH A GLOBAL COMPUTER NETWORK; CONSULTATION SERVICES IN THE AREA OF PREPARING AND CONDUCTING MARKETING PROGRAMS; COMPUTERIZED DATABASE MANAGEMENT; PROVIDING BUSINESS CONSULTATION IN THE FIELD OF ELECTRONIC COMMERCE AND; PROVIDING CONSULTING IN THE FIELD OF BUSINESS TECHNIQUES RELATING TO ELECTRONIC COMMERCE; PROVIDING TECHNICAL ASSISTANCE IN ORGANIZING AND ADMINISTERING ONLINE RETAIL SHOPPING SITES IN THE WEBSITES OF OTHERS ON GLOBAL COMPUTER NETWORKS (U.S. CLS. 100, 101 AND 102).

CLASS 42—SCIENTIFIC, COMPUTER AND LEGAL SERVICES

FOR COMPUTER APPLICATIONS SERVICES FOR THIRD PARTIES CONDUCTING ONLINE BUSINESSES, NAMELY, PROVIDING APPLICATION HOSTING, APPLICATION MANAGEMENT AND APPLICATION RENTAL SERVICES (U.S. CLS. 100 AND 101).

SN 76-151,970. BUSH BOAKE ALLEN LIMITED, LONDON E17 5QP, UNITED KINGDOM, FILED 10-23-2000.

ReleasTec

PRIORITY CLAIMED UNDER SEC. 44(D) ON UNITED KINGDOM APPLICATION NO. 2243395, FILED 8-23-2000, REG. NO. 2243395, DATED 8-23-2000, EXPIRES 8-23-2010.

CLASS 3—COSMETICS AND CLEANING PREPARATIONS

FOR ESSENTIAL OILS FOR USE IN FOOD AND BEVERAGES (U.S. CLS. 1, 4, 6, 50, 51 AND 52).

CLASS 30—STAPLE FOODS

FOR FLAVORINGS FOR FOOD AND FOR BEVERAGES (U.S. CL. 46).

MEDICINOVA

CLASS 36—INSURANCE AND FINANCIAL

FOR VENTURE CAPITAL INVESTING IN THE PHARMACEUTICAL INDUSTRY (U.S. CLS. 100, 101 AND 102).

CLASS 42—SCIENTIFIC, COMPUTER AND LEGAL SERVICES

FOR RESEARCH, CONDUCTING CLINICAL TRIALS, AND NEW PRODUCT DEVELOPMENT ALL IN THE FIELD OF PHARMACEUTICALS (U.S. CLS. 100 AND 101).

SN 76-153,645. BASF AKTIENGESELLSCHAFT, LUDWIGSHAFEN AM RHEIN, FED REP GERMANY, FILED 10-25-2000.

HEXAMOLL

CLASS 1—CHEMICALS

FOR CHEMICAL PRODUCTS FOR USE IN THE MANUFACTURE AND PROCESSING OF PLASTICS IN A CRUDE STATE; CHEMICAL PRODUCTS, NAMELY SOLVENTS AND PLASTICIZERS FOR PLASTICS IN THE CRUDE STATE (U.S. CLS. 1, 5, 6, 10, 26 AND 46).

CLASS 17—RUBBER GOODS

FOR PLASTIC IN THE CRUDE STATE FOR GENERAL INDUSTRIAL USE AND FOR USE IN MANUFACTURING (U.S. CLS. 1, 5, 12, 13, 35 AND 50).

SN 76-153,807. UNIVERSAL MEDICAL INVESTMENT CORP., NEW YORK, NY. FILED 10-25-2000.

CLINICAL CONCEPTS PLASTIC ASTHETIC DERMATOLOGY

NO CLAIM IS MADE TO THE EXCLUSIVE RIGHT TO USE "CLINICAL" AND "PLASTIC ASTHETIC DERMATOLOGY", APART FROM THE MARK AS SHOWN.

CLASS 3—COSMETICS AND CLEANING PREPARATIONS

FOR SOAPS, PERFUMES, ESSENTIAL OILS FOR PERSONAL USE, AIDS FOR BODY AND BEAUTY CARE, NAMELY, SKIN CREAM, WRINKLE CREAM, HAIR LOTIONS, DENTIFRICES (U.S. CLS. 1, 4, 6, 50, 51 AND 52).

CLASS 5—PHARMACEUTICALS

FOR MEDICATED SKIN CARE PREPARATIONS CONTAINING RETINOL AND COLLAGEN (U.S. CLS. 6, 18, 44, 46, 51 AND 52).

CLASS 42—SCIENTIFIC, COMPUTER AND LEGAL SERVICES

FOR MEDICAL CARE SERVICES, HEALTH AND BEAUTY CARE SERVICES, NAMELY, COSMETIC AND PLASTIC SURGERY, HOSPITAL SERVICES, MEDICAL CLINIC SERVICES, REST-HOME SERVICES, PERFORMING DERMATOLOGICAL-COSMETIC PROCEDURES, NAMELY, CHEMICAL PEELING FOR FACE AND MOUTH WRINKLES, INJECTIONS FOR FACE WRINKLES, LIP CORRECTIONS AND SKIN REJUVENATION, MEDICAL TESTING, NAMELY, PERFORMING ALLERGY TESTS FOR COSMETICS AND FOOD ALLERGIES, NAMELY, PERFORMING TESTS, STATIONARY INTRODUCTION AND SALES CONTROL OF TESTING AND INTRODUCTION OF DIETS FOR AMBULATORY, NOT DISABLED, PATIENTS, PERFORMING AMBULATORY LASER SURGERY, NAMELY, LIP CORRECTIONS, EYELID CORRECTIONS, SCAR CORRECTIONS, SKIN ABRASIONS, NAMELY, FACE AND MOUTH WRINKLES, TATTOO REMOVALS, WARTS REMOVAL, REMOVAL OF BIRTHMARKS AND UNWANTED SKIN CHANGES, HAIR TRANSPLANTS, REMOVAL OF EPIDERMAL AND DERMAL BLOOD VESSEL CHANGES, NAMELY, NAEVUS FLAMMEOUS, VARIX, RENTAL OF MEDICAL EQUIPMENT, NAMELY, LASER INSTRUMENTS, TECHNICAL CONSULTATION IN THE FIELD OF MANUFACTURERS AND BUILDING OF LASER INSTRUMENTS (U.S. CLS. 100 AND 101).

SN 76-154,145. APA - THE ENGINEERED WOOD ASSOCIATION, TACOMA, WA. FILED 10-25-2000.

PERFORMANCE RATED

OWNER OF U.S. REG. NO. 1,449,705.
SEC. 2(F).

CLASS 17—RUBBER GOODS

FOR STRUCTURAL INSULATED PANELS MADE FROM PLYWOOD (U.S. CLS. 1, 5, 12, 13, 35 AND 50).
FIRST USE 6-30-1980; IN COMMERCE 6-30-1980.

CLASS 19—NON-METALLIC BUILDING MATERIALS

FOR STRUCTURAL WOOD PRODUCTS, NAMELY L-JOISTS, LAMINATED VENEER LUMBER, PARALLEL STRAND LUMBER, STRUCTURAL COMPOSITE LUMBER, GLULAMS, RIM BOARDS, SIDING AND STRUCTURAL PANELS (U.S. CLS. 1, 12, 33 AND 50).
FIRST USE 6-30-1980; IN COMMERCE 6-30-1980.

SN 76-154,636. TUTOGEN MEDICAL GMBH, 91077 NEUNKIRCHEN AM BRAND, FED REP GERMANY, FILED 10-26-2000.

TUTOBONE

OWNER OF FED REP GERMANY REG. NO. 39951331,
DATED 11-23-1999, EXPIRES 8-31-2009.

CLASS 5—PHARMACEUTICALS

FOR BIOLOGICAL BONE TISSUE INTENDED FOR SUBSEQUENT IMPLANTATION (U.S. CLS. 6, 18, 44, 46, 51 AND 52).

CLASS 10—MEDICAL APPARATUS

FOR SURGICAL CUTLERY AND THREAD; DENTAL HANDPIECES AND IMPRESSION TRAYS; ARTIFICIAL EYES, LIMBS AND TEETH; SUTURES; ORTHOPEDIC BELTS, BRACES, FOOTWEAR, JOINT IMPLANTS AND SUPPORTS; SURGICAL IMPLANTS COMPRISING ARTIFICIAL MATERIAL, BONE IMPLANTS (U.S. CLS. 26, 39 AND 44).

SN 76-154,935. FLYING RHINOCEROS, INC., PORTLAND, OR. FILED 10-26-2000.

**CLASS 9—ELECTRICAL AND SCIENTIFIC APPARATUS**

FOR MULTIMEDIA SOFTWARE RECORDED ON CD-ROM IN THE FIELDS OF CHILDREN'S EDUCATION AND ENTERTAINMENT FEATURING MUSIC, STORIES, GAMES AND ANIMATED CARTOONS; PRE-RECORDED CHILDREN'S VIDEOTAPES AND AUDIOCASSETTES, INTERACTIVE MULTIMEDIA COMPUTER GAME PROGRAMS, NAMELY, INTERACTIVE CHILDREN'S EDUCATIONAL COMPUTER PROGRAM (U.S. CLS. 21, 23, 26, 36 AND 38).
FIRST USE 8-17-2000; IN COMMERCE 8-17-2000.

CLASS 16—PAPER GOODS AND PRINTED MATTER

FOR CHILDREN'S BOOKS; ELEMENTARY-LEVEL EDUCATIONAL BOOKS; WRITTEN CURRICULUM MATERIALS; COMIC BOOKS; BOOKMARKS; PRINTED CHARTS; STICKERS; AND POSTERS (U.S. CLS. 2, 5, 22, 23, 29, 37, 38 AND 50).
FIRST USE 8-17-2000; IN COMMERCE 8-17-2000.

CLASS 25—CLOTHING

FOR CHILDREN'S CLOTHING, NAMELY, T-SHIRTS, HATS AND SWEATSHIRTS (U.S. CLS. 22 AND 39).

CLASS 28—TOYS AND SPORTING GOODS

FOR STUFFED TOY ANIMALS; BOARD GAMES AND JIGSAW PUZZLES (U.S. CLS. 22, 23, 38 AND 50).

CLASS 41—EDUCATION AND ENTERTAINMENT

FOR ENTERTAINMENT SERVICES, NAMELY, PROVIDING INTERACTIVE EDUCATIONAL AND COMPUTER GAMES VIA A GLOBAL COMMUNICATIONS NETWORK (U.S. CLS. 100, 101 AND 107).
FIRST USE 8-17-2000; IN COMMERCE 8-17-2000.

SN 76-155,980. DEPAUL UNIVERSITY, CHICAGO, IL. FILED 10-30-2000.

SN 76-156,131. HAIGHTS CROSS COMMUNICATIONS, INC., WHITE PLAINS, NY. FILED 10-27-2000.

DEMON TECHNOLOGIES L.L.C.

NO CLAIM IS MADE TO THE EXCLUSIVE RIGHT TO USE "TECHNOLOGIES, L.L.C.", APART FROM THE MARK AS SHOWN.

CLASS 35—ADVERTISING AND BUSINESS

FOR BUSINESS CONSULTATION SERVICES IN THE FIELD OF START-UP HIGH TECHNOLOGY BUSINESSES; CONSULTATION IN THE FIELD OF HUMAN RESOURCES AND EMPLOYEE RECRUITMENT (U.S. CLS. 100, 101 AND 102).

CLASS 36—INSURANCE AND FINANCIAL

FOR LEASING OFFICE SPACE TO ENTREPRENEURS TO ESTABLISH START-UP HIGH TECHNOLOGY BUSINESSES; PROVIDING CONSULTATION IN START-UP FUNDING AND LOAN FINANCING FOR STARTUP HIGH TECHNOLOGY BUSINESSES (U.S. CLS. 100, 101 AND 102).

CLASS 38—COMMUNICATION

FOR CONSULTATION SERVICES PROVIDED TO START-UP HIGH TECHNOLOGY BUSINESSES IN THE FIELDS OF COMPUTER/INTERNET ACCESS, HIGH BANDWIDTH CONNECTIVITY, AND TELECOMMUNICATIONS EQUIPMENT AND SERVICES (U.S. CLS. 100, 101 AND 104).

CLASS 41—EDUCATION AND ENTERTAINMENT

FOR EDUCATIONAL SERVICES IN THE NATURE OF SEMINARS IN THE FIELD OF START-UP HIGH TECHNOLOGY BUSINESSES, NAMELY THE NEEDS AND REQUIREMENTS OF HIGH TECHNOLOGY BUSINESSES, NAMELY, COMPUTER/INTERNET ACCESS, HIGH BANDWIDTH CONNECTIVITY, TELECOMMUNICATIONS EQUIPMENT AND SERVICES, BIOTECHNOLOGY RESEARCH AND RESOURCES, COMPUTER SOFTWARE AND HARDWARE, ELECTRONICS RESEARCH AND EQUIPMENT, LOAN FINANCING, START-UP FUNDING, EMPLOYEE RECRUITMENT, HUMAN RESOURCES, INDUSTRY UPDATES, AND PERSONNEL PARTNERING AND NETWORKING (U.S. CLS. 100, 101 AND 107).

CLASS 42—SCIENTIFIC, COMPUTER AND LEGAL SERVICES

FOR CONSULTATION SERVICES PROVIDED TO START-UP HIGH TECHNOLOGY BUSINESSES IN THE FIELDS OF BIOTECHNOLOGY RESEARCH, COMPUTER SOFTWARE AND HARDWARE, AND ELECTRONICS RESEARCH (U.S. CLS. 100 AND 101).

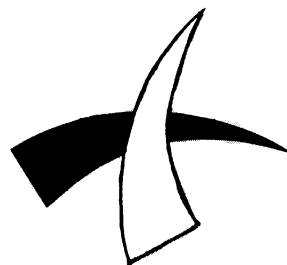

CLASS 9—ELECTRICAL AND SCIENTIFIC APPARATUS

FOR HOUSE MARK FOR A FULL LINE OF ELECTRONIC PUBLICATIONS IN THE FIELD OF EDUCATIONAL AND PROFESSIONAL PUBLISHING, NAMELY, LAW, MEDICINE THAT IS DOWNLOADABLE AND RECORDED ON CD-ROMS (U.S. CLS. 21, 23, 26, 36 AND 38).

CLASS 16—PAPER GOODS AND PRINTED MATTER

FOR HOUSE MARK FOR A FULL LINE OF BOOKS, BOOKLETS AND NEWSLETTERS FEATURING MEDICAL, INFORMATION TECHNOLOGY, LEGAL AND EDUCATIONAL INFORMATION (U.S. CLS. 2, 5, 22, 23, 29, 37, 38 AND 50).

SN 76-156,370. ONEPIPELINE.COM, INC., SALT LAKE CITY, UT. FILED 10-30-2000.

SN 76-156,399. GREATER LAFAYETTE CHAMBER OF COMMERCE, INC., LAFAYETTE, LA. FILED 10-30-2000.

ONEPIPELINE.COM



CLASS 36—INSURANCE AND FINANCIAL

FOR FINANCIAL SERVICES PROVIDED ONLINE VIA A GLOBAL COMPUTER INFORMATION NETWORK, BY TELEPHONE, BY FACSIMILE, BY E-MAIL, AND PERSON TO PERSON, NAMELY, LOAN COMPLIANCE SERVICES WITH RESPECT TO GOVERNMENT REGULATIONS AND LAWS, LOAN QUALIFICATION SERVICES WITH RESPECT TO LENDER REQUIREMENTS, LOAN PROMOTION COMPLIANCE SERVICES, LOAN SOURCE LISTING SERVICES, LOAN ORIGINATION SERVICES, LOAN TASK LIST SERVICES, NAMELY PROVIDING LISTS OF TASK TO BE COMPLETED INCIDENT TO LOANS AND LOAN CLOSINGS, LOAN STATUS TRACKING AND REPORTING SERVICES, LOAN DOCUMENT PREPARATION SERVICES, LOAN DOCUMENT COMPLETION SERVICES, LOAN COMMISSION PAYMENT SERVICES, AND PROVIDING INFORMATION AND ASSISTANCE IN PROCURING LICENSES FOR LOAN ORIGINATORS, BROKERS, AGENTS AND LENDERS; PROVIDING AN ONLINE COMPUTER DATABASE AND ONLINE INFORMATION, DATA, REPORTING, INSTRUCTIONS, NEWS, REFERENCES AND LISTS IN THE FIELDS OF LOAN COMPLIANCE WITH RESPECT TO GOVERNMENT REGULATIONS AND LAWS, LOAN QUALIFICATION WITH RESPECT TO LENDER REQUIREMENTS, LOAN PROMOTION COMPLIANCE, LOAN SOURCE LISTINGS, LOAN ORIGINATION, LOAN TASK LISTS, LOAN STATUS TRACKING AND REPORTING, LOAN DOCUMENT PREPARATION, LOAN DOCUMENT COMPLETION, LOAN COMMISSION PAYMENTS, AND LICENSE PROCUREMENT FOR LOAN ORIGINATORS, BROKERS, AGENTS AND LENDERS; AND CONSULTATION AND AUDITING SERVICES IN THE FIELDS OF LOAN COMPLIANCE WITH RESPECT TO GOVERNMENT REGULATIONS AND LAWS, LOAN QUALIFICATION WITH RESPECT TO LENDER REQUIREMENTS, LOAN SOURCE LISTINGS, LOAN ORIGINATION, LOAN TASK LISTS, LOAN STATUS TRACKING AND REPORTING, LOAN DOCUMENT PREPARATION, LOAN DOCUMENT COMPLETION, LOAN COMMISSION PAYMENTS, LICENSE PROCUREMENT FOR LOAN ORIGINATORS, BROKERS, AGENTS AND LENDERS, BROKER AND LENDER PERFORMANCE, AND LOAN ORIGINATOR, BROKER, AGENT AND LENDER COMPLIANCE AND ACTIVITIES (U.S. CLS. 100, 101 AND 102).

CLASS 41—EDUCATION AND ENTERTAINMENT

FOR EDUCATIONAL SERVICES, NAMELY PROVIDING COURSES OF INSTRUCTION AND TRAINING, ONLINE AND LIVE, IN THE FIELDS OF LOAN COMPLIANCE WITH RESPECT TO GOVERNMENT REGULATIONS AND LAWS, LOAN QUALIFICATION WITH RESPECT TO LENDER REQUIREMENTS, LOAN PROMOTION COMPLIANCE, LOAN SOURCE LISTINGS, LOAN ORIGINATION, LOAN TASK LISTS, LOAN STATUS TRACKING AND REPORTING, LOAN DOCUMENT PREPARATION, LOAN DOCUMENT COMPLETION, LOAN COMMISSION PAYMENTS, LICENSE PROCUREMENT FOR LOAN ORIGINATORS, BROKERS, AGENTS AND LENDERS, LOAN BROKER AND LENDER PERFORMANCE, AND LOAN ORIGINATOR, BROKER, AGENT AND LENDER COMPLIANCE AND ACTIVITIES (U.S. CLS. 100, 101 AND 107).

CLASS 35—ADVERTISING AND BUSINESS

FOR PROMOTING ECONOMIC DEVELOPMENT IN THE GREATER LAFAYETTE, LOUISIANA AREA (U.S. CLS. 100, 101 AND 102).
FIRST USE 1-26-1999; IN COMMERCE 1-27-1999.

CLASS 41—EDUCATION AND ENTERTAINMENT

FOR EDUCATIONAL AND TRAINING SERVICES, NAMELY, CLASSES AND SEMINARS IN THE FIELD OF TECHNOLOGY EDUCATION FOR THE ECONOMIC DEVELOPMENT OF LAFAYETTE, LOUISIANA AND WORKFORCE RETRAINING (U.S. CLS. 100, 101 AND 107).
FIRST USE 1-26-1999; IN COMMERCE 1-27-1999.

CLASS 42—SCIENTIFIC, COMPUTER AND LEGAL SERVICES

FOR ASSOCIATION SERVICES, NAMELY PROMOTING MORE EFFICIENT AND IMPROVED TELECOMMUNICATIONS CAPABILITIES IN LAFAYETTE, LOUISIANA (U.S. CLS. 100 AND 101).
FIRST USE 1-26-1999; IN COMMERCE 1-27-1999.

SN 76-157,085. BUFFER, MICHAEL, LOS ANGELES, CA. FILED 11-1-2000.

READY 2 RUMBLE

OWNER OF U.S. REG. NOS. 1,904,692, 2,416,799 AND OTHERS.

CLASS 25—CLOTHING

FOR CLOTHING, NAMELY, T-SHIRTS (U.S. CLS. 22 AND 39).
FIRST USE 1-31-2000; IN COMMERCE 1-31-2000.

CLASS 35—ADVERTISING AND BUSINESS

FOR ADVERTISING AND PROMOTING THE GOODS AND SERVICES OF OTHERS RENDERED BY LIVE ANNOUNCEMENTS AT OR IN CONNECTION WITH SPORTING, ENTERTAINMENT OR CULTURAL EVENTS, AND VIA PRE-RECORDED AUDIO, VIDEO, AND ELECTRONIC MEDIA, NAMELY, RADIO, TELEVISION, MOTION PICTURE FILMS, MOTION PICTURE TRAILERS, VIDEOTAPES, CD'S, THE GLOBAL COMPUTER NETWORK, COMPUTER SOFTWARE AND OTHER ELECTRONIC DISKS, NAMELY, LASER, CD-ROM, AND DVD, AT OR IN CONNECTION WITH SPORTING, ENTERTAINMENT OR CULTURAL EVENTS, PROGRAMS, PROCEEDINGS OR ACTIVITIES (U.S. CLS. 100, 101 AND 102).
FIRST USE 1-31-2000; IN COMMERCE 1-31-2000.

SN 76-157,278. DOLCOM LLC, BALTIMORE, MD. FILED 11-1-2000.

SN 76-158,849. BALLET MAKERS, INC., TOTOWA, NJ. FILED 11-3-2000.

TRIAL BUILDER



NO CLAIM IS MADE TO THE EXCLUSIVE RIGHT TO USE "TRIAL", APART FROM THE MARK AS SHOWN.

THE MARK CONSISTS OF A REPRESENTATION OF A LEAPING DANCE FIGURE.

CLASS 35—ADVERTISING AND BUSINESS

FOR ADVERTISING AGENCIES; DIRECT MAIL ADVERTISING; DISSEMINATION OF ADVERTISING FOR OTHERS VIA ON-LINE ELECTRONIC COMMUNICATIONS NETWORK; DISSEMINATION OF ADVERTISING MATTER; PROVIDING TELEVISION ADVERTISING TO OTHERS; CONDUCTING MARKET-ING STUDIES (U.S. CLS. 100, 101 AND 102).
FIRST USE 9-1-2000; IN COMMERCE 9-1-2000.

CLASS 41—EDUCATION AND ENTERTAINMENT

FOR INSTRUCTION IN THE FIELD OF CLINICAL TRIALS AND PATIENT RECRUITMENT (U.S. CLS. 100, 101 AND 107).
FIRST USE 9-1-2000; IN COMMERCE 9-1-2000.

CLASS 24—FABRICS

FOR TOWELS (U.S. CLS. 42 AND 50).
FIRST USE 6-0-1989; IN COMMERCE 6-0-1989.

CLASS 25—CLOTHING

FOR CLOTHING, NAMELY, BOOTLEG JAZZ PANTS, CAMISOLE TOPS, DRAWSTRING PANTS, T-SHIRTS AND SWEATSHIRTS (U.S. CLS. 22 AND 39).
FIRST USE 6-0-1989; IN COMMERCE 6-0-1989.

SN 76-158,143. VENTURE COATING TECHNOLOGIES, INC., JANESVILLE, WI. FILED 11-2-2000.

EXPRESSION

CLASS 16—PAPER GOODS AND PRINTED MATTER

FOR DRY MOUNTING TISSUE COATED ON BOTH SIDES WITH A HEAT ACTIVATED ADHESIVE FOR LAMINATING TO PAPERS, FILMS, TEXTILES, BRASS RUBBINGS, PARCHMENT, CANVAS, AND SILK (U.S. CLS. 2, 5, 22, 23, 29, 37, 38 AND 50).
FIRST USE 2-0-2000; IN COMMERCE 2-0-2000.

CLASS 17—RUBBER GOODS

FOR THERMAL LAMINATING FILM AND HEAT ACTIVATED INKJET LAMINATING FILM FOR USE IN THE THERMAL LAMINATION PROCESS, NAMELY THE ONE-SIDED AND TWO-SIDED LAMINATIONS OF PAPERS, FILMS, AND TEXTILES, PRESSURE-SENSITIVE LAMINATING FILM FOR ONE-SIDED AND TWO-SIDED LAMINATIONS OF PAPERS, FILMS, AND TEXTILES, PRESSURE SENSITIVE MOUNTING ADHESIVES FOR MOUNTING PRINTS TO PAPERS, FILMS AND TEXTILES (U.S. CLS. 1, 5, 12, 13, 35 AND 50).
FIRST USE 2-0-2000; IN COMMERCE 2-0-2000.

SN 76-158,947. REALITYBUY, INC., IRVINE, CA. BY CHANGE OF NAME REALITYBUY.COM, INC., IRVINE, CA. FILED 11-2-2000.



CLASS 9—ELECTRICAL AND SCIENTIFIC APPARATUS

FOR COMPUTER SOFTWARE WHICH CREATES THREE-DIMENSIONAL IMAGES OF PRODUCTS TO ENHANCE THE WEB SITES OF ON-LINE RETAILERS (U.S. CLS. 21, 23, 26, 36 AND 38).
FIRST USE 5-0-2000; IN COMMERCE 5-0-2000.

CLASS 42—SCIENTIFIC, COMPUTER AND LEGAL SERVICES

FOR CREATING THREE-DIMENSIONAL REPRESENTATIONS OF THE PRODUCTS OF OTHERS; COMPUTER SERVICES, NAMELY, DESIGNING AND IMPLEMENTING WEB STIES FOR OTHERS; DESIGNING COMPUTER SOFTWARE FOR OTHERS CONTAINING THREE-DIMENSIONAL IMAGES OF PRODUCTS FOR USE IN ON-LINE RETAILING (U.S. CLS. 100 AND 101).
FIRST USE 5-0-2000; IN COMMERCE 5-0-2000.

SN 76-160,390. SOUTHERN CONE COMMUNICATIONS COMPANY S.A., VITACURA, SANTIAGO, CHILE, FILED 11-7-2000.



NO CLAIM IS MADE TO THE EXCLUSIVE RIGHT TO USE "NETWORKS", APART FROM THE MARK AS SHOWN.

CLASS 9—ELECTRICAL AND SCIENTIFIC APPARATUS

FOR TELEPHONES, CELLULAR PHONES, COMPUTERS, PAGERS, FAX MACHINES AND FIBER OPTICS (U.S. CLS. 21, 23, 26, 36 AND 38).

CLASS 16—PAPER GOODS AND PRINTED MATTER

FOR PRINTED MATERIALS, NAMELY MAGAZINES, JOURNALS, BROCHURES AND LEAFLETS IN THE FIELD OF TELECOMMUNICATIONS (U.S. CLS. 2, 5, 22, 23, 29, 37, 38 AND 50).

CLASS 38—COMMUNICATION

FOR TELECOMMUNICATION SERVICES, NAMELY, ELECTRONIC TRANSMISSION OF VOICE, DATA AND IMAGES, CABLE TELEVISION BROADCASTING, RADIO BROADCASTING, TELEVISION BROADCASTING, TRANSMISSION OF DATA AND DOCUMENTS BY FIBER OPTIC NETWORKS, TELEPHONE COMMUNICATIONS SERVICES, ELECTRONIC TRANSMISSION OF MESSAGES AND IMAGES VIA COMPUTER TERMINALS, ELECTRONIC MAIL SERVICES, FACSIMILE TRANSMISSION, PROVIDING INFORMATION ABOUT TELECOMMUNICATIONS, MESSAGE SENDING, SATELLITE TRANSMISSION AND WIRE SERVICES (U.S. CLS. 100, 101 AND 104).

SN 76-160,691. SIEMENS AKTIENGESELLSCHAFT, MUNCHEN, FED REP GERMANY, FILED 11-7-2000.

MOTION-CONNECT

PRIORITY CLAIMED UNDER SEC. 44(D) ON FED REP GERMANY APPLICATION NO. 30051805.6/0, FILED 7-12-2000, REG. NO. 30051805.6, DATED 9-1-2000, EXPIRES 7-31-2010.

CLASS 9—ELECTRICAL AND SCIENTIFIC APPARATUS

FOR ELECTRIC LEADS, NAMELY, EXTENSION CABLES, CONTROL LINES, UNINSULATED ELECTRIC WIRE AND CABLE, POWER SUPPLY CORDS, JUMPER CABLES, ELECTRIC WIRE FOR USE IN LAND VEHICLES, BUILDING WIRE, MAGNET WIRE, ELECTRIC LEAD WIRE AND ELECTRIC CORD SETS; CABLES, CABLE DRUMS, ELECTRICAL CABLE FITTINGS, ELECTRICAL CONNECTORS FOR ATTACHING TO THE ENDS OF ELECTRICAL CABLES; ELECTRICAL INSTALLATION MATERIAL, NAMELY, SWITCHES, DIMMERS, SOCKETS, CONNECTORS, SWITCHED SOCKET-OUTLETS, SPLITTING BOXES, AERIAL SOCKETS, LOUDSPEAKER AND JUNCTION BOXES, COMMUNICATION PLUGS; SCREW-IN MINIATURE CIRCUIT BREAKERS, PROXIMITY SWITCHES, RESIDUAL CURRENT CIRCUIT BREAKERS, RELAYS, CONTACTORS, CABLE LUGS, CABLE JOINTS, CABLE BOXES (U.S. CLS. 21, 23, 26, 36 AND 38).

CLASS 17—RUBBER GOODS

FOR INSULATING MATERIAL FOR ELECTRIC LEADS, NAMELY, ELECTRIC INSULATORS, FABRICATED OF SYNTHETIC RESIN, MICA OR SILICONE RUBBER (U.S. CLS. 1, 5, 12, 13, 35 AND 50).

SN 76-160,915. KNOWLEDGE2SHARE.COM, COLLEGE STATION, TX, FILED 11-6-2000.



NO CLAIM IS MADE TO THE EXCLUSIVE RIGHT TO USE "KNOWLEDGE", APART FROM THE MARK AS SHOWN.

CLASS 9—ELECTRICAL AND SCIENTIFIC APPARATUS

FOR COMPUTER SOFTWARE, NAMELY ELECTRONIC DATABASES RECORDED ON COMPUTER MEDIA FEATURING ELECTRONIC TUTORING, ELECTRONIC PERFORMANCE SUPPORT, MULTIMEDIA TRAINING, ELECTRONIC TECHNICAL MANUALS, INTERACTIVE TRAINING SOFTWARE, ELECTRONIC BOOKS AND MANUALS AND ON-LINE KNOWLEDGE ASSESSMENT AND EVALUATION, ALL TO ASSIST IN THE ORGANIZATION AND MANAGEMENT OF DATA AND INTELLECTUAL PROPERTY AND DATA MINING AND RETRIEVAL, DOWNLOADABLE SOFTWARE FOR USE IN SEARCH MINING AND ORGANIZING DATA AND KNOWLEDGE (U.S. CLS. 21, 23, 26, 36 AND 38).

CLASS 42—SCIENTIFIC, COMPUTER AND LEGAL SERVICES

FOR COMPUTER SOFTWARE DESIGN FOR OTHERS, NAMELY CREATION OF LEARNING SYSTEMS COMPOSED OF ELECTRONIC TUTORING SOFTWARE, ELECTRONIC PERFORMANCE SUPPORT SOFTWARE, MULTIMEDIA TRAINING PROGRAMS, ELECTRONIC TECHNICAL MANUALS, INTERACTIVE TRAINING SOFTWARE, ELECTRONIC BOOKS AND MANUALS AND ON-LINE KNOWLEDGE ASSESSMENT AND EVALUATION SOFTWARE, AND SOFTWARE DATABASES AND DIGITAL KNOWLEDGE LIBRARIES FOR CLIENT SPECIFIC DATA AND INTELLECTUAL PROPERTY TO ASSIST IN THE ORGANIZATION AND MANAGEMENT OF DATA AND INTELLECTUAL PROPERTY AND DATA MINING AND RETRIEVAL INCLUDING INTERNET ACCESSIBLE SOFTWARE PROGRAMS FOR SEARCHING, MINING AND ORGANIZING DATA AND KNOWLEDGE WITHIN THOSE CLIENT OWNED LEARNING SYSTEMS, DIGITAL KNOWLEDGE LIBRARIES AND DATABASES (U.S. CLS. 100 AND 101).

SN 76-163,052. GILA RIVER INDIAN COMMUNITY, THE, SACATON, AZ. FILED 11-9-2000.



THE MARK IS A BASKET WEAVE DESIGN AND IS COMPRISED OF CONCENTRIC CIRCULAR BANDS IN THE MIDDLE OF WHICH IS A WINDMILL-LIKE FIGURE WITH FIVE SPOKES HAVING SQUARE ENDS COMING FROM IT.

SN 76-162,018. FILMFESTIVALS.COM, 75008 PARIS, FRANCE, FILED 11-7-2000.



NO CLAIM IS MADE TO THE EXCLUSIVE RIGHT TO USE "FILMFESTIVALS.COM", APART FROM THE MARK AS SHOWN.

CLASS 38—COMMUNICATION

FOR PROVIDING CHAT ROOMS AND BULLETIN BOARDS IN THE FIELD OF FILMS; BROADCASTING VIA THE INTERNET (U.S. CLS. 100, 101 AND 104). FIRST USE 0-0-1995; IN COMMERCE 0-0-1995.

CLASS 41—EDUCATION AND ENTERTAINMENT

FOR PROVIDING A WEBSITE FEATURING NEWS AND INFORMATION ABOUT FILMS, FILM REVIEWS, FILM SYNOPSES, AND INTERVIEWS; ORGANIZING FILM FESTIVALS; PROVIDING AN ARCHIVE AND DATABASE OF INFORMATION ABOUT FILMS (U.S. CLS. 100, 101 AND 107). FIRST USE 0-0-1995; IN COMMERCE 0-0-1995.

CLASS 14—JEWELRY

FOR JEWELRY (U.S. CLS. 2, 27, 28 AND 50).

CLASS 16—PAPER GOODS AND PRINTED MATTER

FOR PAPER GOODS AND PRINTED MATTER, NAMELY, STATIONARY, PENS, PENCILS, POSTERS, POSTCARDS, PLAYING CARDS, WRITING PAPER, ART PICTURES AND PRINTS (U.S. CLS. 2, 5, 22, 23, 29, 37, 38 AND 50).

CLASS 20—FURNITURE AND ARTICLES NOT OTHERWISE CLASSIFIED

FOR NON-METAL KEY CHAINS (U.S. CLS. 2, 13, 22, 25, 32 AND 50).

CLASS 21—HOUSEWARES AND GLASS

FOR GLASS HOUSEWARES, NAMELY, DRINKING GLASSES, MUGS, STATUES, STATUETTES, SCULPTURES, FIGURINES (U.S. CLS. 2, 13, 23, 29, 30, 33, 40 AND 50).

CLASS 24—FABRICS

FOR TOWELS (U.S. CLS. 42 AND 50).

CLASS 28—TOYS AND SPORTING GOODS

FOR SPORTING GOODS, NAMELY, GOLF CLUBS, GOLF BALLS, GOLF BAGS, GOLF GLOVES, GOLF CLUB COVERS (U.S. CLS. 22, 23, 38 AND 50).

CLASS 34—SMOKERS' ARTICLES

FOR SMOKING ARTICLES, NAMELY, LIGHTERS NOT MADE OF PRECIOUS METAL, MATCHES AND ASHTRAYS, NOT OF PRECIOUS METAL (U.S. CLS. 2, 8, 9 AND 17).

SN 76-163,476. DESIGNAFAIRS GMBH, MUNCHEN, FED REP GERMANY, FILED 11-10-2000.

SN 76-163,827. READINGVILLAGE.COM, INC., BAITING HOLLOW, NY. FILED 11-13-2000.

design
afairs

PRIORITY CLAIMED UNDER SEC. 44(D) ON FED REP GERMANY APPLICATION NO. 30036121, FILED 9-7-2000, REG. NO. 30036121, DATED 9-7-2000, EXPIRES 5-31-2010.

CLASS 9—ELECTRICAL AND SCIENTIFIC APPARATUS

FOR COMPUTER PROGRAMS, COMPACT DISCS AND MOTION PICTURE FILMS, RELATING TO MARKET RESEARCH, ANALYSIS AND ADVERTISING, BUSINESS ASSETS VALUATION, CORPORATE IMAGE, ORGANIZING AND CONDUCTING FAIRS AND EXHIBITIONS, AND PREPARING AND PLACING ADVERTISEMENTS (U.S. CLS. 21, 23, 26, 36 AND 38).

CLASS 16—PAPER GOODS AND PRINTED MATTER

FOR PRINTED MATTER, NAMELY, NEWSPAPERS, MAGAZINES, CATALOGUES, BROCHURES AND POSTERS RELATING TO MARKET RESEARCH, ANALYSIS AND ADVERTISING, BUSINESS ASSETS VALUATION, CORPORATE IMAGE, ORGANIZING AND CONDUCTING FAIRS AND EXHIBITIONS, AND PREPARING AND PLACING ADVERTISEMENTS (U.S. CLS. 2, 5, 22, 23, 29, 37, 38 AND 50).

CLASS 35—ADVERTISING AND BUSINESS

FOR BUSINESS MANAGEMENT CONSULTATION IN THE FIELD OF MARKET RESEARCH, ANALYSIS AND ADVERTISING, BUSINESS ASSETS VALUATION, AND CORPORATE IMAGE; ORGANIZING AND CONDUCTING FAIRS AND EXHIBITIONS IN THE FIELD OF MARKET RESEARCH, ANALYSIS AND ADVERTISING, BUSINESS ASSETS VALUATION, AND CORPORATE IMAGE; PREPARING AND PLACING ADVERTISEMENTS; AND PROVIDING INFORMATION REGARDING CORPORATE ORGANIZATION (U.S. CLS. 100, 101 AND 102).

CLASS 42—SCIENTIFIC, COMPUTER AND LEGAL SERVICES

FOR DESIGN SERVICES, NAMELY, DESIGNING CORPORATE WORKPLACES FOR OTHERS; CONSULTATION IN THE FIELDS OF CORPORATE DESIGN, INDUSTRIAL DESIGN, AND ERGONOMIC DESIGN OF WORKPLACES; DESIGN AND DEVELOPMENT OF COMPUTER SOFTWARE FOR OTHERS; CONSULTATION IN THE USE OF COMPUTER NETWORKS AND COMMUNICATIONS EQUIPMENT TO RUN BUSINESSES WITH GREATER INNOVATION AND EFFICIENCY (U.S. CLS. 100 AND 101).

POWER EMAIL

NO CLAIM IS MADE TO THE EXCLUSIVE RIGHT TO USE "E-MAIL", APART FROM THE MARK AS SHOWN.

CLASS 9—ELECTRICAL AND SCIENTIFIC APPARATUS

FOR COMPUTER HARDWARE AND SOFTWARE FOR RECORDING, TRANSMITTING AND REPRODUCING SOUNDS AND IMAGES ELECTRONICALLY, AND DESIGNED TO IMPROVE WRITING AND READING SKILLS (U.S. CLS. 21, 23, 26, 36 AND 38).

CLASS 41—EDUCATION AND ENTERTAINMENT

FOR EDUCATIONAL SERVICES, NAMELY AN INTERNET WEBSITE DESIGNED TO IMPROVE WRITING AND READING SKILLS THROUGH RECORDING, TRANSMITTING AND REPRODUCING SOUNDS AND IMAGES (U.S. CLS. 100, 101 AND 107).

SN 76-164,521. CYGENT, INC., SAN FRANCISCO, CA. FILED 11-13-2000.

Cygent

OWNER OF U.S. REG. NO. 2,453,731.

CLASS 9—ELECTRICAL AND SCIENTIFIC APPARATUS

FOR DOWNLOADABLE COMPUTER E-COMMERCE SOFTWARE APPLICATIONS THAT ENABLE COMMUNICATIONS PROVIDERS TO PERFORM ELECTRONIC BUSINESS TRANSACTIONS VIA A GLOBAL COMPUTER NETWORK AND COMPUTER E-COMMERCE SOFTWARE APPLICATIONS THAT ENABLE COMMUNICATIONS PROVIDERS TO PERFORM ELECTRONIC BUSINESS TRANSACTIONS VIA A GLOBAL COMPUTER NETWORK (U.S. CLS. 21, 23, 26, 36 AND 38).
FIRST USE 6-1-2000; IN COMMERCE 6-1-2000.

CLASS 41—EDUCATION AND ENTERTAINMENT

FOR TRAINING IN THE USE AND OPERATION OF COMMUNICATIONS SOFTWARE PRODUCTS FOR COMMUNICATIONS PROVIDERS (U.S. CLS. 100, 101 AND 107).
FIRST USE 6-1-2000; IN COMMERCE 6-1-2000.

CLASS 42—SCIENTIFIC, COMPUTER AND LEGAL SERVICES

FOR COMPUTER SERVICES, NAMELY INSTALLATION OF COMPUTER SOFTWARE THAT ALLOWS COMMUNICATIONS PROVIDERS TO PERFORM ELECTRONIC BUSINESS TRANSACTIONS VIA THE INTERNET; COMPUTERS SERVICES, NAMELY, MAINTENANCE OF COMPUTER SOFTWARE FOR COMMUNICATIONS PROVIDERS THAT ALLOWS COMMUNICATIONS PROVIDERS; UPDATING OF COMPUTER SOFTWARE FOR OTHERS, NAMELY, COMMUNICATIONS PROVIDERS IN ORDER FOR THEM TO PERFORM ELECTRONIC BUSINESS TRANSACTIONS VIA THE INTERNET; AND COMPUTER CONSULTATION SERVICES FOR COMMUNICATIONS PROVIDERS (U.S. CLS. 100 AND 101).

FIRST USE 6-1-2000; IN COMMERCE 6-1-2000.

SN 76-164,637. TIKI FARM, INC., SAN CLEMENTE, CA. FILED 11-14-2000.

TIKI FARM

NO CLAIM IS MADE TO THE EXCLUSIVE RIGHT TO USE "TIKI" (IN CONNECTION WITH CLASSES 11, 20, AND 21), APART FROM THE MARK AS SHOWN.

CLASS 9—ELECTRICAL AND SCIENTIFIC APPARATUS

FOR DECORATIVE MAGNETS, MOUSE PADS, CD HOLDERS (U.S. CLS. 21, 23, 26, 36 AND 38).

CLASS 11—ENVIRONMENTAL CONTROL APPARATUS

FOR LAMPS AND LAMP SHADES (U.S. CLS. 13, 21, 23, 31 AND 34).

CLASS 14—JEWELRY

FOR JEWELRY; JEWELRY IN THE NATURE OF NECKLACES, BRACELETS, RINGS, PENDANTS, TOE RINGS, EARRINGS, CHOKERS, WATCHBANDS, NAVEL RINGS, BROACHES, CUFF LINKS, ANKLE BRACELETS, TIE PINS AND TIE CLIPS; CLOCKS (U.S. CLS. 2, 27, 28 AND 50).

CLASS 16—PAPER GOODS AND PRINTED MATTER

FOR PAPER GOODS, NAMELY, PAPER NAPKINS, NOTE PADS, PAPER TABLECLOTHS, STICKERS, STATIONERY WRITING PAPER AND ENVELOPES, BUMPER STICKERS, DECALS, PAPER COASTERS, GIFTS CARDS; PENCIL HOLDERS, PEN HOLDERS, PAPER WEIGHTS; MOUNTED AND UNMOUNTED POSTERS; BOOKENDS (U.S. CLS. 2, 5, 22, 23, 29, 37, 38 AND 50).

CLASS 20—FURNITURE AND ARTICLES NOT OTHERWISE CLASSIFIED

FOR FURNITURE, BARS FOR SERVING BEVERAGES, BAR STOOLS, SHELVES, WOOD AND PLASTIC SCULPTURES, WOOD AND PLASTIC STATUES, WOOD AND PLASTIC DECORATIVE WALL MASKS, WOOD AND PLASTIC DECORATIVE POLES, DECORATIVE BEAD CURTAINS, WOOD DRESSER TOP BOXES USED FOR DECORATION AND TO STORE ITEMS, PLASTIC LICENSE PLATE FRAMES, WOOD AND PLASTIC FIGURINES, WOOD AND PLASTIC DOOR PULLS, TABLES, MAGAZINE RACKS, DECORATIVE PLASTIC SWITCHPLATE COVERS, OTTOMANS, PLASTIC KEY CHAINS, NOVELTY PLASTIC FIGURINES AND WOOD AND PLASTIC DOOR HANDLES (U.S. CLS. 2, 13, 22, 25, 32 AND 50).

CLASS 21—HOUSEWARES AND GLASS

FOR HOUSEWARE AND GLASSWARE, NAMELY, SHOT GLASSES, MUGS, PLASTIC COASTERS, PITCHERS, CUPS, BEVERAGE STIRRERS, SAUCERS, BEVERAGE GLASSWARE, PLATES, BOWLS, SERVING PLATTERS, TOWEL RACKS, SOAP DISHES, SOAP DISPENSERS, TOOTHBRUSH HOLDERS, TOILET PAPER HOLDERS, BOTTLE OPENERS, POTS, THERMAL INSULATED CONTAINERS FOR FOOD AND BEVERAGES, SERVING TRAYS NOT OF PRECIOUS METAL, BOTTLE STOPPERS NOT OF RUBBER, DRINKING STEINS, SPICE RACKS, COTTON SWAB HOLDERS, COASTERS NOT OF PAPER AND NOT OF TABLE LINEN, DECORATIVE STAINED GLASS, EARTHENWARE SCULPTURES, EARTHENWARE STATUES, EARTHENWARE FIGURINES, PLASTIC PLANTERS, DECORATIVE EARTHENWARE WALL MASKS AND DECORATIVE EARTHENWARE POLES (U.S. CLS. 2, 13, 23, 29, 30, 33, 40 AND 50).

CLASS 25—CLOTHING

FOR CLOTHING, NAMELY, T-SHIRTS, SWEATSHIRTS, POLO SHIRTS, TANK TOPS, SCARVES, PANTS, SHORTS, SOCKS, SWEATERS, DRESSES, SKIRTS, JACKETS AND BANDANAS; HEAD WEAR (U.S. CLS. 22 AND 39).

SN 76-166,289. HUBBELL INCORPORATED, ORANGE, CT. FILED 11-16-2000.

ENVIRORITE

CLASS 9—ELECTRICAL AND SCIENTIFIC APPARATUS

FOR ELECTRICAL DISTRIBUTION EQUIPMENT, NAMELY, ELECTRICAL CONTROLS FOR USE IN THE OPERATION OF LIGHT FIXTURES, MOTOR STARTERS, AND OTHER INDUSTRIAL DEVICES; ELECTRICAL FITTINGS USED FOR PROVIDING ACCESS AND CONNECTIVITY TO ELECTRICAL CONDUCTORS, ELECTRICAL SWITCH HOUSINGS, ELECTRICAL ENCLOSURES USED TO PROVIDE WIRING SPACE AND MOUNTING FOR CONTROL OPERATORS, CIRCUIT BREAKERS, OR CONDUCTORS; AND ELECTRICAL CONNECTORS (U.S. CLS. 21, 23, 26, 36 AND 38).

CLASS 11—ENVIRONMENTAL CONTROL APPARATUS

FOR ELECTRICAL LIGHTING FIXTURES (U.S. CLS. 13, 21, 23, 31 AND 34).

SN 76-167,053. ESPIAL GROUP INC., OTTAWA, ONTARIO, CANADA, FILED 11-9-2000.

DEVICETOP

CLASS 9—ELECTRICAL AND SCIENTIFIC APPARATUS

FOR COMPUTER PROGRAMS FOR USE IN THE FIELD OF NETWORK-ENABLED INFORMATION PRODUCTS, NAMELY, SOFTWARE WHICH FEATURES PLATFORM INDEPENDENT USER INTERFACES AND OPERATING SYSTEM SOFTWARE HAVING BROWSER INTERACTIVE CONTENT, APPLETS AND APPLICATIONS AND MANUALS SOLD THEREWITH AS A UNIT (U.S. CLS. 21, 23, 26, 36 AND 38).

FIRST USE 10-0-1998; IN COMMERCE 6-0-2000.

CLASS 41—EDUCATION AND ENTERTAINMENT

FOR TRAINING AND EDUCATION SERVICES, NAMELY, CONDUCTING COURSES, SEMINARS AND TRAINING EXERCISES IN THE FIELDS OF COMPUTERS, COMPUTER HARDWARE AND COMPUTER SOFTWARE (U.S. CLS. 100, 101 AND 107).

FIRST USE 10-0-1998; IN COMMERCE 6-0-2000.

CLASS 42—SCIENTIFIC, COMPUTER AND LEGAL SERVICES

FOR PROVIDING INFORMATION ON COMPUTER SOFTWARE, SOFTWARE DEVELOPMENT AND SOFTWARE PROGRAMMING VIA A GLOBAL COMPUTER NETWORK; COMPUTER SERVICES, NAMELY, COMPUTER PROGRAMMING FOR OTHERS IN THE FIELD OF INTERFACE DESIGN AND NETWORK SOFTWARE APPLICATIONS; COMPUTER SOFTWARE DESIGN AND COMPUTER SOFTWARE DEVELOPMENT SERVICES FOR OTHERS; COMPUTER CONSULTATION SERVICES AND CONSULTATION SERVICES REGARDING SOFTWARE FEATURING PLATFORM INDEPENDENT USER INTERFACES AND OPERATING SYSTEM SOFTWARE; INTERNET SERVICES, NAMELY, OPERATION OF A WEB PORTAL FOR SOFTWARE DEVELOPERS; TECHNICAL AND CUSTOMER SUPPORT SERVICES, NAMELY, TROUBLESHOOTING OF COMPUTER HARDWARE AND SOFTWARE PROBLEMS VIA TELEPHONE AND E-MAIL (U.S. CLS. 100 AND 101).

FIRST USE 10-0-1998; IN COMMERCE 6-0-2000.

CLASS 9—ELECTRICAL AND SCIENTIFIC APPARATUS

FOR DIGITAL RECORDING EQUIPMENT AND COMPUTERIZED RECORDING EQUIPMENT FOR RECORDING, TRANSMISSION, REPRODUCTION AND STORAGE OF SOUNDS AND IMAGES, NAMELY, MP3 FORMAT PLAYERS AND RECORDERS, COMPUTER HARDWARE AND SOFTWARE FOR DOWNLOADING, CONVERTING, PROCESSING AND PLAYING DIGITAL MUSIC, DVD RECORDERS AND PLAYERS, CD RECORDERS AND PLAYERS, KEYBOARD AMPLIFIERS, MIXERS, DIGITAL EFFECTS PRODUCERS FOR MUSICAL SOUND, PROGRAMMERS FOR ELECTRONIC KEYBOARDS, PROGRAMMERS FOR SYNTHESIZER MODULES, SIGNAL CONVERTERS, SYNCHRONIZING SIGNAL GENERATORS FOR MUSICAL INSTRUMENTS, ELECTRONIC RHYTHM GENERATORS FOR USE WITH ELECTRONIC KEYBOARD INSTRUMENTS, MICROPROCESSORS AND INTEGRATED CIRCUITS FOR DIGITAL MUSIC RECORDERS AND PLAYERS; BLANK CD'S AND DVD'S; PRE-RECORDED CD'S AND DVD'S CONTAINING MUSIC; PRE-RECORDED CD'S AND DVD'S FEATURING SAMPLERS CONTAINING MUSIC, VOICE AND/OR VARIOUS DIFFERENT SOUND EFFECTS (U.S. CLS. 21, 23, 26, 36 AND 38).

CLASS 15—MUSICAL INSTRUMENTS

FOR MUSICAL INSTRUMENTS; ELECTRONIC PIANOS, ORGANS AND KEYBOARDS; ELECTRONIC SYNTHESIZERS (U.S. CLS. 2, 21 AND 36).

SN 76-167,147. MONEY EXPERTS, INC., ROSEVILLE, CA. FILED 11-16-2000.

RETIREMETER

CLASS 9—ELECTRICAL AND SCIENTIFIC APPARATUS

FOR SOFTWARE FOR USE BY FINANCIAL SERVICES ADVISORS, FINANCIAL SERVICES FIRMS, ORGANIZATIONS AND INDIVIDUAL CONSUMERS FOR RETIREMENT PLANNING AND IN THE PREPARATION OF LONG TERM PLANNING STRATEGIES, INCOME PROJECTIONS, AND CALCULATIONS OF THE PROBABILITY OF RETIREMENT PORTFOLIOS ENDURING THROUGHOUT RETIREMENT, AND IN PROVIDING SERVICES TO INDIVIDUALS AND SMALL BUSINESSES IN THE PREPARATION OF TAX PROJECTIONS, DEBT PLANNING DOCUMENTS, NET SPENDABLE ANALYSES AND AMORTIZATION SCHEDULES (U.S. CLS. 21, 23, 26, 36 AND 38).

CLASS 36—INSURANCE AND FINANCIAL

FOR FINANCIAL SERVICES SOLUTIONS, NAMELY FINANCIAL MANAGEMENT AND FINANCIAL PLANNING SERVICES OFFERED VIA A GLOBAL COMPUTER NETWORK (U.S. CLS. 100, 101 AND 102).

SN 76-167,084. CLAVIA DIGITAL MUSICAL INSTRUMENTS AB, TA CLAVIA DMI AB, 102 65 STOCKHOLM, SWEDEN, FILED 11-16-2000.

nord electro

PRIORITY CLAIMED UNDER SEC. 44(D) ON SWEDEN APPLICATION NO. 00-04120, FILED 5-23-2000, REG. NO. 348342, DATED 8-31-2001, EXPIRES 8-31-2011.

OWNER OF U.S. REG. NOS. 2,095,206, 2,222,154 AND 2,460,690.

NO CLAIM IS MADE TO THE EXCLUSIVE RIGHT TO USE "ELECTRO", APART FROM THE MARK AS SHOWN. THE ENGLISH TRANSLATION OF "NORD" IS "NORTH".

SN 76-167,156. STAGED DIABETES MANAGEMENT LLC, DBA MATREX LIMITED LIABILITY COMPANY, FRANKLIN LAKES, NJ. FILED 11-17-2000.



CLASS 9—ELECTRICAL AND SCIENTIFIC APPARATUS

FOR COMPUTER SOFTWARE FOR USE IN THE PATIENT MANAGEMENT AND DATABASE MANAGEMENT OF PERSONS WITH DIABETES AND OTHER MEDICAL CONDITIONS (U.S. CLS. 21, 23, 26, 36 AND 38).

CLASS 16—PAPER GOODS AND PRINTED MATTER

FOR PRINTED INSTRUCTIONAL, EDUCATIONAL AND TEACHING MATERIAL RELATING TO DIABETES AND OTHER MEDICAL CONDITIONS (U.S. CLS. 2, 5, 22, 23, 29, 37, 38 AND 50).

SN 76-167,920. TOMY COMPANY, LTD., TOKYO, JAPAN, FILED 11-17-2000.

TOMY
Dream Energy

PRIORITY CLAIMED UNDER SEC. 44(D) ON JAPAN APPLICATION NO. 2000-94493, FILED 8-28-2000, REG. NO. 4527582, DATED 12-7-2001, EXPIRES 12-7-2011.

OWNER OF U.S. REG. NOS. 1,247,034, 2,187,523 AND OTHERS.

CLASS 9—ELECTRICAL AND SCIENTIFIC APPARATUS

FOR PHONOGRAPH RECORDS, OPTICAL DISCS, COMPACT DISCS AND AUDIO AND VIDEO TAPES, ALL BEARING PRE-RECORDED SOUND AND IMAGES AND ALL FEATURING STORIES OF INTEREST TO CHILDREN AND MUSIC OF INTEREST TO CHILDREN, BLANK COMPACT DISCS FOR RECORDING, METRONOMES, PHOTOGRAPHIC CAMERAS, DIGITAL CAMERAS, AND PORTABLE TELEPHONES (U.S. CLS. 21, 23, 26, 36 AND 38).

CLASS 28—TOYS AND SPORTING GOODS

FOR TOYS, GAMES, DOLLS AND PLAYTHINGS, NAMELY, TOY TRAINS, TOY VEHICLES, MECHANICAL TOY FIGURES, SOFT AND SQUEEZING TOY FIGURES, TOY FIGURES, TOY TELEPHONES, TOY CAMERAS, TOYS WHICH COMMUNICATE WITH PERSONS BY EXCHANGING INTEGRATED CIRCUIT CARD MEMORIZED MESSAGES, AND STAND ALONE VIDEO OUTPUT GAME MACHINES (U.S. CLS. 22, 23, 38 AND 50).

SN 76-168,306. AMERSHAM PHARMACIA BIOTECH AB, SE-751 84 UPPSALA, SWEDEN, FILED 11-20-2000.

MABSELECT

CLASS 1—CHEMICALS

FOR CHROMATOGRAPHY CHEMICALS, NAMELY, PACKING MEDIA FOR LARGE SCALE PURIFICATION OF MONOCLONAL ANTIBODIES BY PROCESSED CHROMATOGRAPHY (U.S. CLS. 1, 5, 6, 10, 26 AND 46). FIRST USE 3-20-2001; IN COMMERCE 3-20-2001.

CLASS 9—ELECTRICAL AND SCIENTIFIC APPARATUS

FOR PROCESSED CHROMATOGRAPHY APPARATUS, NAMELY, COLUMNS FOR LARGE SCALE PURIFICATION OF MONOCLONAL ANTIBODIES (U.S. CLS. 21, 23, 26, 36 AND 38). FIRST USE 3-20-2001; IN COMMERCE 3-20-2001.

SN 76-168,604. INFOGRAMMES EUROPE, SAINT CYROAUMONT D'OR, FRANCE, FILED 11-20-2000.

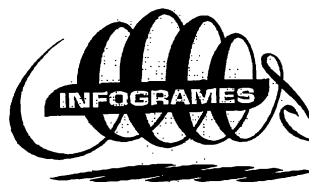

PRIORITY CLAIMED UNDER SEC. 44(D) ON FRANCE APPLICATION NO. 003031050, FILED 5-24-2000, REG. NO. 003031050, DATED 5-24-2000, EXPIRES 5-24-2010.

OWNER OF U.S. REG. NO. 2,369,664.

CLASS 9—ELECTRICAL AND SCIENTIFIC APPARATUS

FOR MAGNETIC, OPTICAL, DIGITAL, AND ELECTRONIC DATA CARRIERS, NAMELY, BLANK MAGNETIC DATA CARRIERS, OPTICAL SCANNERS, DIGITAL AUDIO TAPE PLAYERS AND COMPUTERS; MAGNETIC, OPTICAL DIGITAL DISKS, NAMELY BLANK DISKS FOR COMPUTERS, BLANK OPTICAL DISKS FOR COMPUTERS; OPTICAL GAME DISK AND DIGITAL VIDEO GAME DISK; COMPUTER MEMORIES, NAMELY, COMPUTER CHIPS; COMPUTER SOFTWARE FOR VIDEO GAMES; COMPUTER GAME SOFTWARE, MAGNETIC, OPTICAL AND DIGITAL CARRIERS FOR COMPUTER GAMES, NAMELY, VIDEO GAME CARTRIDGES, ELECTRONIC GAME PLAYER ADAPTED FOR USE WITH A TELEVISION RECEIVER, NAMELY VIDEO GAME MACHINES FOR USE WITH TELEVISIONS (U.S. CLS. 21, 23, 26, 36 AND 38).

CLASS 28—TOYS AND SPORTING GOODS

FOR STAND ALONE HOME VIDEO GAME CONSOLES; HAND HELD UNITS FOR PLAYING VIDEO GAMES (U.S. CLS. 22, 23, 38 AND 50).

CLASS 38—COMMUNICATION

FOR PROVIDING TELECOMMUNICATION CONNECTIONS TO A GLOBAL COMPUTER NETWORK; ELECTRONIC TRANSMISSION OF DATA, IMAGES AND SOUNDS VIA COMPUTER TERMINAL; ELECTRONIC TRANSMISSION FEATURING INTERACTIVE COMMUNICATION AND REAL TIME DATA TRANSMISSION BETWEEN COMPUTER USERS OR TELEVISION SETS CONNECTED TO AN ELECTRONIC TELECOMMUNICATIONS NETWORK; TELEVISION BROADCASTING; BROADCASTING ELECTRONIC GAME PROGRAMS VIA GLOBAL COMPUTER NETWORK; TELEVISION BROADCASTING OF ELECTRONIC GAMES (U.S. CLS. 100, 101 AND 104).

CLASS 41—EDUCATION AND ENTERTAINMENT

FOR COMPUTER TRAINING SERVICES (U.S. CLS. 100, 101 AND 107).
FIRST USE 11-1-1999; IN COMMERCE 5-1-2000.

CLASS 42—SCIENTIFIC, COMPUTER AND LEGAL SERVICES

FOR COMPUTER SOFTWARE DESIGN, PROGRAMMING, INTEGRATION AND CUSTOMISATION FOR OTHERS (U.S. CLS. 100 AND 101).
FIRST USE 11-1-1999; IN COMMERCE 5-1-2000.

SN 76-168,712. PASTINA CO., LTD., BANGKOK 10150, THAILAND, FILED 11-20-2000.

SN 76-169,440. EUNIVERSE, INC., LOS ANGELES, CA, FILED 11-21-2000.



OWNER OF THAILAND REG. NO. 122340, DATED 8-4-1999, EXPIRES 8-4-2009.

OWNER OF U.S. REG. NO. 2,403,879.

CLASS 20—FURNITURE AND ARTICLES NOT OTHERWISE CLASSIFIED

FOR PLASTIC BOXES (U.S. CLS. 2, 13, 22, 25, 32 AND 50).

CLASS 41—EDUCATION AND ENTERTAINMENT

FOR ENTERTAINMENT SERVICES, NAMELY PROVIDING ON-LINE INTERACTIVE MULTIMEDIA GAMES AND ANIMATED HUMOR AND INSPIRATIONAL WEB PAGES (U.S. CLS. 100, 101 AND 107).
FIRST USE 11-10-2000; IN COMMERCE 11-10-2000.

CLASS 21—HOUSEWARES AND GLASS

FOR PLATES, TRAYS, NAMELY CRUMB TRAYS, MEAL TRAYS, AND NON-METAL TRAYS FOR SERVING FOOD; BUCKETS; BASINS, NAMELY, HAND, SUGAR AND WASH BASINS, JUGS; PITCHERS; FLASKS FOR KEEPING WATER; VACUUM FLASKS FOR KEEPING FOOD COLD; PLASTIC BASKETS; PLASTIC CONTAINERS, NAMELY, PORTABLE PLASTIC CONTAINERS FOR STORING HOUSEHOLD AND KITCHEN GOODS; BOTTLE RACKS (U.S. CLS. 2, 13, 23, 29, 30, 33, 40 AND 50).

CLASS 42—SCIENTIFIC, COMPUTER AND LEGAL SERVICES

FOR COMPUTER SERVICES, NAMELY PROVIDING ON-LINE MAGAZINES AND NEWSLETTERS IN THE FIELDS OF ENTERTAINMENT AND CELEBRITY NEWS, HUMOR, COMPUTER AND CONSOLE GAMES, AND INSPIRATIONAL MESSAGES; AND ELECTRONIC NEWSLETTERS IN THE FIELDS OF ENTERTAINMENT AND HUMOR DELIVERED BY E-MAIL (U.S. CLS. 100 AND 101).
FIRST USE 11-10-2000; IN COMMERCE 11-10-2000.

SN 76-169,232. METAWORKS INC., HALIFAX, PROVINCE OF NOVA SCOTIA, CANADA, FILED 11-20-2000.

SN 76-170,314. FARMSAVER.COM, LLC, SEATTLE, WA, FILED 11-22-2000.



CLASS 9—ELECTRICAL AND SCIENTIFIC APPARATUS

FOR COMPUTER SOFTWARE, NAMELY, DATA COLLECTION AND MANAGEMENT SOFTWARE THAT PROVIDES REMOTE ACCESS TO COMPUTER TO CORPORATE DATA (U.S. CLS. 21, 23, 26, 36 AND 38).
FIRST USE 11-1-1999; IN COMMERCE 5-1-2000.

IT'S OUR MISSION, NOT A REACTION

CLASS 1—CHEMICALS

FOR FERTILIZERS AND FOLIAR MICRONUTRIENT PLANT FOOD SPRAY FOR AGRICULTURAL USE (U.S. CLS. 1, 5, 6, 10, 26 AND 46).

CLASS 5—PHARMACEUTICALS

FOR VETERINARY ANTIBIOTICS; FUNGICIDES; HERBICIDES AND PESTICIDES FOR AGRICULTURAL USE (U.S. CLS. 6, 18, 44, 46, 51 AND 52).

SN 76-170,431. LAMB, BRENDA C., WESTPORT, CT. FILED 11-22-2000.

EARTH PRINCIPLES**CLASS 6—METAL GOODS**

FOR STATUES AND FIGURINES OF NON-PRECIOUS METAL (U.S. CLS. 2, 12, 13, 14, 23, 25 AND 50).

CLASS 20—FURNITURE AND ARTICLES NOT OTHERWISE CLASSIFIED

FOR STATUES AND FIGURINES OF RESIN OR PLASTIC (U.S. CLS. 2, 13, 22, 25, 32 AND 50).

CLASS 24—FABRICS

FOR UPHOLSTERY FABRICS AND TEXTILE, WALL HANGINGS OF TEXTILE, CLOTH BANNERS, TABLE LINENS, BED SHEETS, AND BEDDING (U.S. CLS. 42 AND 50).

CLASS 27—FLOOR COVERINGS

FOR WALL HANGINGS NOT OF TEXTILE, NAMELY AMULETS OF CORD, METAL AND CRYSTAL (U.S. CLS. 19, 20, 37, 42 AND 50).

SN 76-172,167. DR. FRITZ FAULHABER GMBH & CO. KG FEINMECHANISCHE WERKSTAETTEN, 71101 SCHOE-NAICH, FED REP GERMANY, FILED 11-27-2000.

FAULHABER GROUP

PRIORITY CLAIMED UNDER SEC. 44(D) ON FED REP GERMANY APPLICATION NO. 30040558.8/0, FILED 5-27-2000, REG. NO. 30040558, DATED 1-16-2001, EXPIRES 5-31-2010.

OWNER OF U.S. REG. NO. 1,188,397.
NO CLAIM IS MADE TO THE EXCLUSIVE RIGHT TO USE "GROUP", APART FROM THE MARK AS SHOWN. SEC. 2(F) AS TO "FAULHABER".

CLASS 7—MACHINERY

FOR ELECTRIC MOTORS FOR MACHINES; ELECTRO MOTORS FOR MACHINES; TRANSMISSION GEARS FOR ELECTRIC DRIVES USED WITH ELECTRIC MOTORS FOR MACHINES; SERVO COMPONENTS FOR ELECTRIC DRIVES USED WITH ELECTRIC MOTORS FOR MACHINES, NAMELY, BRUSHLESS DIRECT CURRENT MOTORS, BRUSHLESS DIRECT CURRENT SERVO-MOTORS (U.S. CLS. 13, 19, 21, 23, 31, 34 AND 35).
FIRST USE 4-0-2000; IN COMMERCE 4-0-2000.

CLASS 9—ELECTRICAL AND SCIENTIFIC APPARATUS

FOR ELECTRIC CONTROLS FOR DRIVES; TACHOMETER GENERATORS; SERVO COMPONENTS FOR ELECTRIC DRIVES USED WITH ELECTRIC MOTORS FOR MACHINES, NAMELY, MAGNETIC ENCODERS, OPTICAL ENCODERS, MOTION CONTROLLERS, LINEAR CONTROLLERS, SERVO AMPLIFIERS (U.S. CLS. 21, 23, 26, 36 AND 38).
FIRST USE 4-0-2000; IN COMMERCE 4-0-2000.

SN 76-172,182. PLANET HOPE, LOS ANGELES, CA. FILED 11-29-2000.

PLANET HOPE**CLASS 18—LEATHER GOODS**

FOR HANDBAGS, DUFFLE BAGS (U.S. CLS. 1, 2, 3, 22 AND 41).

CLASS 24—FABRICS

FOR BLANKETS AND TROWS (U.S. CLS. 42 AND 50).

CLASS 25—CLOTHING

FOR CLOTHING, NAMELY, T-SHIRTS, SHIRTS, SHORTS, SKORTS, PANTS, DRESSES, SKIRTS, BLOUSES, HATS, CAPS, UNDERWEAR, BRAS, SLIPS, PANTYHOSE, SWEAT SHIRTS, SWEAT PANTS, BELTS, BOOTS, SANDALS, THONGS, PAJAMAS, ROBES, SLIPPERS, SCARVES, COATS, JACKETS, SWEATERS, SWIMWEAR, SOCKS, SHOES, GLOVES AND TIES (U.S. CLS. 22 AND 39).

SN 76-173,102. ENDESA MARKETPLACE, S.A., PASEO CASTELLANA, 95 28046 MADRID, SPAIN, FILED 11-29-2000.

EUTILIA

PRIORITY CLAIMED UNDER SEC. 44(D) ON SPAIN APPLICATION NO. 2355118, FILED 11-3-2000, REG. NO. 2355118, DATED 11-3-2000, EXPIRES 11-3-2010.

PRIORITY CLAIMED UNDER SEC. 44(D) ON SPAIN APPLICATION NO. 2355116, FILED 11-3-2000, REG. NO. 2355116, DATED 11-3-2000, EXPIRES 11-3-2010.

PRIORITY CLAIMED UNDER SEC. 44(D) ON SPAIN APPLICATION NO. 2355115, FILED 11-3-2000, REG. NO. 2355115, DATED 11-3-2000, EXPIRES 11-3-2010.

PRIORITY CLAIMED UNDER SEC. 44(D) ON SPAIN APPLICATION NO. 2355114, FILED 11-3-2000, REG. NO. 2355114, DATED 11-3-2000, EXPIRES 11-3-2010.

PRIORITY CLAIMED UNDER SEC. 44(D) ON SPAIN APPLICATION NO. 2355111, FILED 11-3-2000, REG. NO. 2355111, DATED 11-3-2000, EXPIRES 11-3-2010.

CLASS 35—ADVERTISING AND BUSINESS

FOR COMMUNICATION TRANSCRIPTION SERVICES, NAMELY, MESSAGE TRANSCRIPTION SERVICES; TELEPHONE ANSWERING SERVICES FOR ABSENT SUBSCRIBERS; DIRECT MAIL ADVERTISING SERVICES; MANAGEMENT OF COMPUTER FILES FOR OTHERS; PROMOTING THE GOODS AND SERVICES OF OTHERS BY PREPARING AND PLACING ADVERTISING IN AN ELECTRONIC MAGAZINE ON WEBSITES ACCESSED THROUGH A GLOBAL COMPUTER NETWORK; PLACING ADVERTISEMENTS FOR OTHERS ON WEBSITES ACCESSED THROUGH A GLOBAL COMPUTER NETWORK; DISSEMINATION OF ADVERTISING FOR OTHERS VIA WEBSITES ON A GLOBAL COMPUTER NETWORK; PROMOTING THE GOODS AND SERVICES OF THIRD PARTIES BY DELIVERING ADVERTISEMENTS AND PROMOTIONAL MATERIALS TO THIRD PARTIES VIA ELECTRONIC MAIL; PERSONNEL RECRUITMENT BY MEANS OF PHYSCOTECHNICAL PROCEDURE (U.S. CLS. 100, 101 AND 102).

CLASS 38—COMMUNICATION

FOR RADIO, TELEPHONE AND TELEGRAPH COMMUNICATION SERVICES; TELECOPY TRANSMISSIONS; TELEX SERVICES; CABLE TELEVISION TRANSMISSION; CABLE TELEVISION BROADCASTING; TELECOMMUNICATION AND COMMUNICATION SERVICES, NAMELY, ELECTRONIC TRANSMISSION OF DATA AND DOCUMENTS VIA COMPUTER TERMINALS (U.S. CLS. 100, 101 AND 104).

CLASS 39—TRANSPORTATION AND STORAGE

FOR PUBLIC UTILITY SERVICES IN THE NATURE OF DISTRIBUTION, TRANSPORTATION, AND STORAGE OF ELECTRICITY (U.S. CLS. 100 AND 105).

CLASS 40—MATERIAL TREATMENT

FOR GENERATION OF ELECTRICAL POWER (U.S. CLS. 100, 103 AND 106).

CLASS 42—SCIENTIFIC, COMPUTER AND LEGAL SERVICES

FOR ENGINEERING SERVICES, NAMELY, CONDUCTING TECHNICAL PROJECT STUDIES IN THE FIELD OF ENGINEERING AND COMPUTING; RESEARCH AND DEVELOPMENT OF NEW PRODUCTS FOR OTHERS; LANGUAGE TRANSLATION SERVICES; LEASING ACCESS TIME TO A COMPUTER DATABASE IN THE FIELD OF COMMERCIAL INFORMATION, BUSINESS INFORMATION AND TELECOMMUNICATIONS (U.S. CLS. 100 AND 101).

SN 76-173,184. NEUTROGENA CORPORATION, LOS ANGELES, CA. FILED 11-30-2000.

NEUTROGENA ANTI-WRINKLE ANTI-BLEMISH

OWNER OF U.S. REG. NOS. 590,385, 1,520,420 AND OTHERS.

NO CLAIM IS MADE TO THE EXCLUSIVE RIGHT TO USE "ANTI-WRINKLE ANTI-BLEMISH", APART FROM THE MARK AS SHOWN.

CLASS 3—COSMETICS AND CLEANING PREPARATIONS

FOR FACIAL SKIN CARE PREPARATIONS, NAMELY, FACIAL CLEANSER, PREMOISTENED COSMETIC WIPES AND PREMOISTENED COSMETIC FACIAL STRIPS, CLARIFYING FACIAL TREATMENT CREAM, CLARIFYING FACIAL TREATMENT GEL AND CLARIFYING FACIAL TREATMENT LOTION, ANTI-AGING CREAM, ANTI-AGING GEL, ANTI-AGING LOTION, NON-MEDICATED MOISTURIZING SKIN CREAM, GEL AND LOTION FOR THE FACE; COSMETICS, NAMELY, FOUNDATION, MAKEUP AND FACE POWDER; AND BODY CARE PREPARATIONS, NAMELY, BODY LOTION, BODY CREAM, BODY WASH, HAND CREAM, HAND LOTION (U.S. CLS. 1, 4, 6, 50, 51 AND 52).

CLASS 5—PHARMACEUTICALS

FOR MEDICATED FACIAL STRIPS FOR THE TREATMENT OF PIMPLES, ACNE AND BLEMISHES, MEDICATED FACE CREAM, GEL AND LOTION FOR THE TREATMENT OF ACNE, BLEMISHES AND PIMPLES (U.S. CLS. 6, 18, 44, 46, 51 AND 52).

SN 76-173,450. RENOVO LIMITED, MANCHESTER, UNITED KINGDOM, FILED 11-30-2000.

RENOVO

CLASS 5—PHARMACEUTICALS

FOR SURGICAL WOUND DRESSING PREPARATIONS, NAMELY FOR WOUND HEALING AND SCAR PREVENTION, ACCELERATION OF WOUND HEALING, SCAR IMPROVEMENT, WOUND HEALING AND SCAR SEVERITY PROGNOSTICS, WOUND HEALING AND SCAR DIAGNOSTICS; PREPARATIONS FOR USE IN ADHESION PREVENTION; ANTI-FIBROTIC PREPARATIONS (U.S. CLS. 6, 18, 44, 46, 51 AND 52).

CLASS 41—EDUCATION AND ENTERTAINMENT

FOR EDUCATIONAL AND TRAINING SERVICES, NAMELY CONDUCTING SEMINARS, CLASSES, WORKSHOPS AND LECTURES IN THE FIELDS OF BIOTECHNOLOGY, BIOSCIENCE, PHARMACY, PHARMACEUTICALS, PHARMACOLOGY, MEDICINE AND VETERINARY SCIENCE, WITH COURSE MATERIAL, INSTRUCTION AND INFORMATION PROVIDED ONLINE AND BY MEANS OF THE INTERNET (U.S. CLS. 100, 101 AND 107).

CLASS 42—SCIENTIFIC, COMPUTER AND LEGAL SERVICES

FOR SCIENTIFIC AND INDUSTRIAL RESEARCH IN THE FIELDS OF BIOTECHNOLOGY, BIOSCIENCE, PHARMACY, PHARMACEUTICALS, PHARMACOLOGY, MEDICINE AND VETERINARY SCIENCES (U.S. CLS. 100 AND 101).

SN 76-173,526. ENIRO AKTIEBOLAG, BROMMA, SWEDEN, FILED 11-30-2000.

ENIRO

PRIORITY CLAIMED UNDER SEC. 44(D) ON SWEDEN APPLICATION NO. 00-04538, FILED 6-7-2000, REG. NO. 346960, DATED 6-15-2001, EXPIRES 6-15-2011.

CLASS 9—ELECTRICAL AND SCIENTIFIC APPARATUS

FOR REGISTERED COMPUTER SOFTWARE FOR PROCESSING OF ELECTRONIC DOCUMENTATION IN THE FIELD OF COMPANY DATA, BUSINESS CONCEPTS, ACTIVITIES, PRODUCTS AND SERVICES, AND WRITTEN ACCOMPANYING MATERIAL THEREFOR SOLD AS A UNIT THEREWITH; MAGNETIC DATA CARRIERS, NAMELY PRE-RECORDED COMPUTER DISCS AND CASSETTE TAPES CONTAINING COMPANY DATA, BUSINESS CONCEPTS, ACTIVITIES, PRODUCTS AND SERVICES; PRE-RECORDED CD-ROMS, COMPACT DISCS, INTERACTIVE COMPACT DISCS, DISKETTES, CASSETTES AND DISCS CONTAINING COMPANY DATA, BUSINESS CONCEPTS, ACTIVITIES, PRODUCTS AND SERVICES (U.S. CLS. 21, 23, 26, 36 AND 38).

CLASS 16—PAPER GOODS AND PRINTED MATTER

FOR PRINTED MATTER, NAMELY DIRECTORIES CONTAINING COMPANY DATA, BUSINESS CONCEPTS, ACTIVITIES, PRODUCTS AND SERVICES; GRAPHIC PRINTED MATTER, NAMELY TELEPHONE CATALOGUES (U.S. CLS. 2, 5, 22, 23, 29, 37, 38 AND 50).

CLASS 35—ADVERTISING AND BUSINESS

FOR PREPARING AND PLACING FOR OTHERS ADVERTISEMENTS IN ALL MEDIA; BUSINESS MANAGEMENT CONSULTING IN CONNECTION WITH CATALOGUE SERVICES; COMPUTERIZED DATABASE MANAGEMENT; RENTAL OF ADVERTISING SPACE; PROVIDING STATISTICAL INFORMATION; TELEPHONE ANSWERING SERVICES FOR NON-AVAILABLE SUBSCRIBERS; COMPUTERIZED DATABASE MANAGEMENT IN THE NATURE OF THE COMPILATION, SYSTEMATIZATION AND RECORDING OF INFORMATION IN COMPUTER DATABASES; ELECTRONIC RETAILING SERVICES VIA TELEPHONE, MAIL AND COMPUTER SYSTEMS FEATURING COMPANY DATA, BUSINESS CONCEPTS, ACTIVITIES, PRODUCTS AND SERVICES; PROVIDING FINANCIAL STATISTIC INFORMATION VIA ELECTRONIC INTERFACE; PROVIDING A WEBSITE ON A GLOBAL COMPUTER NETWORK FEATURING COMPANY DATA, BUSINESS CONCEPTS, ACTIVITIES, PRODUCTS AND SERVICES (U.S. CLS. 100, 101 AND 102).

CLASS 36—INSURANCE AND FINANCIAL

FOR FINANCIAL MANAGEMENT; MONETARY EXCHANGE; CHARGE CARD, DEBIT-ACCOUNT CARD AND CREDIT-CARD SERVICES; COMPUTERIZED FINANCIAL SERVICES, NAMELY PROVIDING CREDIT STATEMENTS VIA COMPUTER COMMUNICATION; ELECTRONIC TRANSFER OF MONEY; FINANCIAL ELECTRONIC PAYMENT TRANSACTIONS VIA COMPUTER COMMUNICATION; FINANCIAL RESEARCH VIA ELECTRONIC INTERFACE; ANALYSIS AND CONSULTATION WITHIN THE FINANCIAL AREA (U.S. CLS. 100, 101 AND 102).

CLASS 38—COMMUNICATION

FOR TELECOMMUNICATION AND COMPUTER COMMUNICATION, NAMELY PERSONAL COMMUNICATION SERVICES; ELECTRONIC TRANSMISSION OF MESSAGES AND DATA VIA TELEPHONE NETWORKS; PROVIDING MULTIPLE-USER ACCESS TO A GLOBAL COMPUTER INFORMATION NETWORK; ELECTRONIC MAIL; TELEPHONE SERVICES FOR ACCOMPLISHMENT OF CONFERENCE CALLS FOR OTHERS; ELECTRONIC ORDER TRANSMISSION FOR BUSINESSES VIA COMPUTER COMMUNICATION, TELECOMMUNICATION AND RADIO COMMUNICATION AND WITH AUDIO-VISUAL COMMUNICATION DEVICES; TRANSMISSION OF DATA, DOCUMENTS AND MESSAGES VIA ELECTRONIC AND TELEPHONE-CONNECTED COMPUTER SYSTEMS AND VIA GLOBAL COMMUNICATION NETWORK SERVICES; TRANSMISSION OF TELEPHONE AND COMPUTER COMMUNICATION REGARDING PERSONAL IDENTIFICATION, NAMELY CALLER-ID SERVICES (U.S. CLS. 100, 101 AND 104).

CLASS 41—EDUCATION AND ENTERTAINMENT

FOR PUBLICATION OF CATALOGUES, SOUND DISCS, SOUND CASSETTES, LASER DISCS AND VIDEO CASSETTES; EDUCATIONAL SERVICES, NAMELY CONDUCTING CLASSES, SEMINARS, CONFERENCES AND WORKSHOPS IN THE FIELD OF MANAGEMENT OF COMPANY DATA, BUSINESS CONCEPTS, ACTIVITIES, PRODUCTS AND SERVICES; PROVIDING OF TRAINING IN THE USE AND OPERATION OF COMPUTERIZED PROCESSING OF COMPANY DATA, BUSINESS CONCEPTS, ACTIVITIES, PRODUCTS AND SERVICES (U.S. CLS. 100, 101 AND 107).

CLASS 42—SCIENTIFIC, COMPUTER AND LEGAL SERVICES

FOR INFORMATION-TECHNOLOGY SERVICES, NAMELY LEASING ACCESS TIME TO COMPUTER DATABASES; COMPUTER PROGRAMMING; PRINTING SERVICES; PROFESSIONAL CONSULTING ACTIVITIES FOR PRODUCTION, DEVELOPMENT AND MAINTENANCE, NAMELY UPDATING OF COMPUTER PROGRAMS RELATING TO PRINTED MATTERS, ESPECIALLY CATALOGUE INFORMATION AND TECHNICAL CONSULTANCY SERVICES RELATING TO COMPUTERS; EDITORIAL CONSULTATION AND TYPESETTING RESPECTING LAYOUTS FOR SYSTEMATIC MANUALS OF INSTRUCTION IN COMPUTERIZED FORM FOR USAGE AND PRODUCTS (U.S. CLS. 100 AND 101).

SN 76-173,652. ESCOFIER TECHNOLOGIE SA, 71100 CHALON-SUR-SAONE, FRANCE, FILED 11-30-2000.

SYNCROLL

OWNER OF FRANCE REG. NO. 1,722,764, DATED 12-13-1990, EXPIRES 12-13-2010.

CLASS 7—MACHINERY

FOR MACHINES AND MACHINE TOOLS FOR FORMING METAL ALLOY PARTS, AND REPLACEMENT PARTS THEREFOR (U.S. CLS. 13, 19, 21, 23, 31, 34 AND 35).

CLASS 42—SCIENTIFIC, COMPUTER AND LEGAL SERVICES

FOR PROVIDING TECHNICAL ASSISTANCE RELATING TO THE PRODUCTION OF METALS OR METALLIC ALLOYS BY COLD FORMING (U.S. CLS. 100 AND 101).

SN 76-173,789. GAUSA LLC, WASHINGTON, DC. FILED 12-1-2000.



NO CLAIM IS MADE TO THE EXCLUSIVE RIGHT TO USE "LLC", APART FROM THE MARK AS SHOWN.

CLASS 35—ADVERTISING AND BUSINESS

FOR BUSINESS CONSULTING SERVICES (U.S. CLS. 100, 101 AND 102).
FIRST USE 10-1-2000; IN COMMERCE 10-1-2000.

CLASS 38—COMMUNICATION

FOR ELECTRONIC MAIL SERVICES (U.S. CLS. 100, 101 AND 104).
FIRST USE 10-1-2000; IN COMMERCE 10-1-2000.

CLASS 42—SCIENTIFIC, COMPUTER AND LEGAL SERVICES

FOR COMPUTER SERVICES, NAMELY ACTING AS AN APPLICATION SERVICE PROVIDER (ASP), TO HOST AND DELIVER, VIA A GLOBAL COMPUTER INFORMATION NETWORK, A NETWORK-BASED SUITE OF APPLICATIONS THAT ALLOWS PRIVATE AND GROUP INTERACTION FOR DOCUMENT AND GRAPHIC FILE MANIPULATION AND EXCHANGE; AND COMPUTER SERVICES, NAMELY, DESIGNING, DEVELOPING, IMPLEMENTING, AND MAINTAINING WEB SITES, E-COMMERCE GATEWAYS, DATABASES AND OTHER E-COMMERCE SOFTWARE TO ALLOW USERS TO PERFORM ELECTRONIC BUSINESS, COMMUNICATION AND TRANSACTIONS VIA GLOBAL COMPUTER NETWORKS (U.S. CLS. 100 AND 101).
FIRST USE 10-1-2000; IN COMMERCE 10-1-2000.

SN 76-173,790. GAUSA LLC, WASHINGTON, DC. FILED 12-1-2000.



CLASS 38—COMMUNICATION

FOR ELECTRONIC MAIL SERVICES (U.S. CLS. 100, 101 AND 104).
FIRST USE 10-1-2000; IN COMMERCE 10-1-2000.

CLASS 42—SCIENTIFIC, COMPUTER AND LEGAL SERVICES

FOR COMPUTER SERVICES, NAMELY ACTING AS AN APPLICATION SERVICE PROVIDER (ASP), TO HOST AND DELIVER, VIA A GLOBAL COMPUTER INFORMATION NETWORK, A NETWORK-BASED SUITE OF APPLICATIONS THAT ALLOWS PRIVATE AND GROUP INTERACTION FOR DOCUMENT AND GRAPHIC FILE MANIPULATION AND EXCHANGE; AND COMPUTER SERVICES, NAMELY, DESIGNING, DEVELOPING, IMPLEMENTING, AND MAINTAINING WEB SITES, E-COMMERCE GATEWAYS, DATABASES AND OTHER E-COMMERCE SOFTWARE TO ALLOW USERS TO PERFORM ELECTRONIC BUSINESS, COMMUNICATION AND TRANSACTIONS VIA GLOBAL COMPUTER NETWORKS (U.S. CLS. 100 AND 101).
FIRST USE 10-1-2000; IN COMMERCE 10-1-2000.

SN 76-174,051. JACK RUSSELL TERRIER CLUB OF AMERICA, INC., THE, TIMONIUM, MD. FILED 12-1-2000.

**PRESERVE PROTECT &
WORK THE JACK RUSSELL
TERRIER**

OWNER OF U.S. REG. NOS. 1,271,222 AND 1,445,476.
NO CLAIM IS MADE TO THE EXCLUSIVE RIGHT TO USE "JACK RUSSELL TERRIER", APART FROM THE MARK AS SHOWN.

CLASS 35—ADVERTISING AND BUSINESS

FOR MAINTAINING A BREED REGISTRY OF THE JACK RUSSELL TERRIERS (U.S. CLS. 100, 101 AND 102).
FIRST USE 0-0-1984; IN COMMERCE 0-0-1984.

CLASS 41—EDUCATION AND ENTERTAINMENT

FOR PUBLICATION OF MAGAZINES, BROCHURES, PAMPHLETS AND OTHER WRITTEN MATERIALS ON THE SUBJECT OF THE JACK RUSSELL TERRIER, AND ORGANIZING TRIALS AND EXHIBITIONS OF JACK RUSSELL TERRIERS (U.S. CLS. 100, 101 AND 107).
FIRST USE 0-0-1984; IN COMMERCE 0-0-1984.

CLASS 42—SCIENTIFIC, COMPUTER AND LEGAL SERVICES

FOR ASSOCIATION SERVICES, NAMELY, PROMOTING THE INTERESTS AND WELFARE OF THE JACK RUSSELL TERRIER (U.S. CLS. 100 AND 101).
FIRST USE 0-0-1984; IN COMMERCE 0-0-1984.

SN 76-174,052. JACK RUSSELL TERRIER CLUB OF AMERICA, INC., THE, TIMONIUM, MD. FILED 12-1-2000.



NO CLAIM IS MADE TO THE EXCLUSIVE RIGHT TO USE "THE JACK RUSSELL TERRIER CLUB OF AMERICA FOUNDED 1976", APART FROM THE MARK AS SHOWN.

CLASS 35—ADVERTISING AND BUSINESS

FOR MAINTAINING A BREED REGISTRY OF THE JACK RUSSELL TERRIERS (U.S. CLS. 100, 101 AND 102). FIRST USE 0-0-1980; IN COMMERCE 0-0-1980.

CLASS 41—EDUCATION AND ENTERTAINMENT

FOR PUBLICATION OF MAGAZINES, BROCHURES, PAMPHLETS AND OTHER WRITTEN MATERIALS ON THE SUBJECT OF THE JACK RUSSELL TERRIER, AND ORGANIZING TRIALS AND EXHIBITIONS OF JACK RUSSELL TERRIERS (U.S. CLS. 100, 101 AND 107). FIRST USE 0-0-1980; IN COMMERCE 0-0-1980.

CLASS 42—SCIENTIFIC, COMPUTER AND LEGAL SERVICES

FOR ASSOCIATION SERVICES, NAMELY, PROMOTING THE INTERESTS AND WELFARE OF THE JACK RUSSELL TERRIER (U.S. CLS. 100 AND 101). FIRST USE 0-0-1980; IN COMMERCE 0-0-1980.

SN 76-174,190. COMPUTER AIDED REQUERIMENTS ENGINEERING TECHNOLOGIES, S.A., 03700 DENIA (ALICANTE), SPAIN, FILED 12-1-2000.

SOSY

PRIORITY CLAIMED UNDER SEC. 44(D) ON SPAIN APPLICATION NO. 2,320,757, FILED 6-1-2000, REG. NO. 2320757, DATED 2-16-2001, EXPIRES 6-1-2010.

PRIORITY CLAIMED UNDER SEC. 44(D) ON SPAIN APPLICATION NO. 2,320,756, FILED 6-1-2000, REG. NO. 2320756, DATED 2-16-2001, EXPIRES 6-1-2010.

PRIORITY CLAIMED UNDER SEC. 44(D) ON SPAIN APPLICATION NO. 2,320,755, FILED 6-1-2000, REG. NO. 2320755, DATED 1-1-2001, EXPIRES 6-1-2010.

CLASS 9—ELECTRICAL AND SCIENTIFIC APPARATUS

FOR COMPUTER PROGRAMS FOR AUTOMATING THE PRODUCTION OF SOFTWARE FOR USE IN THE DEVELOPMENT OF APPLICATIONS (U.S. CLS. 21, 23, 26, 36 AND 38).

CLASS 38—COMMUNICATION

FOR RENTAL OF TELECOMMUNICATION EQUIPMENT; ELECTRONIC COMMUNICATION OF DATA AND DOCUMENTS VIA COMPUTER TERMINALS, ELECTRONIC MAIL SERVICES, COMPUTER-AIDED TRANSMISSION OF MESSAGES AND IMAGES, ELECTRONIC TRANSMISSION OF MESSAGES, RENTAL OF MESSAGE TRANSMITTERS (U.S. CLS. 100, 101 AND 104).

CLASS 42—SCIENTIFIC, COMPUTER AND LEGAL SERVICES

FOR COMPUTER SOFTWARE DESIGN FOR OTHERS, COMPUTER CONSULTATION, RENTAL OF COMPUTERS, COMPUTER PROGRAMMING FOR OTHERS, LEASING ACCESS TIME TO A COMPUTER DATABASE ON PRODUCTION OF SOFTWARE THROUGH AUTOMATIC PROGRAMMING (U.S. CLS. 100 AND 101).

SN 76-174,414. TEXAS COUNTY AND DISTRICT RETIREMENT SYSTEM, AUSTIN, TX. FILED 12-1-2000.

TEXAS COUNTY & DISTRICT RETIREMENT SYSTEM

NO CLAIM IS MADE TO THE EXCLUSIVE RIGHT TO USE "RETIREMENT SYSTEM", APART FROM THE MARK AS SHOWN.
SEC. 2(F).

CLASS 16—PAPER GOODS AND PRINTED MATTER

FOR NEWSLETTERS AND BULLETINS IN THE FIELD OF ADMINISTRATION OF PUBLIC EMPLOYEE RETIREMENT, DEATH AND DISABILITY PROGRAMS (U.S. CLS. 2, 5, 22, 23, 29, 37, 38 AND 50). FIRST USE 0-0-1968; IN COMMERCE 0-0-1968.

CLASS 36—INSURANCE AND FINANCIAL

FOR ADMINISTRATION OF PUBLIC EMPLOYEE RETIREMENT, DEATH AND DISABILITY PROGRAMS (U.S. CLS. 100, 101 AND 102). FIRST USE 0-0-1968; IN COMMERCE 0-0-1968.

SN 76-175,737. IBIOMATICS LLC, CARY, NC. FILED 12-5-2000.

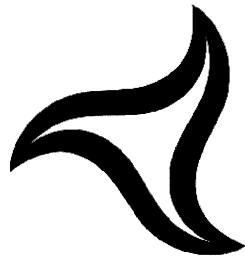

CLASS 38—COMMUNICATION

FOR TRANSMISSION OF INFORMATION AND DATA BY ELECTRONIC MEANS, PROVIDING MULTIPLE USER ACCESS TO A GLOBAL COMPUTER INFORMATION NETWORK, ALL IN THE FIELDS OF MEDICAL SCIENCES, LIFE SCIENCES, HEALTHCARE, BIOTECHNOLOGY, PHARMACEUTICALS, AND FOR USE IN CONNECTION WITH THE DISSEMINATION OF MEDICAL DEVICES, AND CONSULTING SERVICES RELATING TO THE AFORESAID SERVICES (U.S. CLS. 100, 101 AND 104).

CLASS 42—SCIENTIFIC, COMPUTER AND LEGAL SERVICES

FOR PROVIDING ON-LINE INFORMATION IN THE FIELDS OF MEDICAL SCIENCES, LIFE SCIENCES, HEALTHCARE, BIOTECHNOLOGY, PHARMACEUTICALS, AND FOR USE IN CONNECTION WITH THE DISSEMINATION OF MEDICAL DEVICES, AND CONSULTING SERVICES RELATED TO THE AFORESAID SERVICES (U.S. CLS. 100 AND 101).

SN 76-175,780. BENETTON GROUP S.P.A., 31050 PONZANO VENETO (TREVISO), ITALY, FILED 12-5-2000.

SYNERNET

PRIORITY CLAIMED UNDER SEC. 44(D) ON ITALY APPLICATION NO. TV2000C00045, FILED 7-28-2000, REG. NO. TV2000C00459, DATED 7-28-2000, EXPIRES 7-28-2010.

CLASS 18—LEATHER GOODS

FOR ANIMAL SKINS AND ANIMAL HIDES; LEATHER ARTICLES AND IMITATION LEATHER PRODUCTS, NAMELY, CREDIT CARD CASES, BILLFOLDS, FANNY PACKS, WAIST PACKS, DOCUMENT CASES, PASSPORT CASES, COSMETIC CASES SOLD EMPTY, PORTFOLIOS, TRAVELLING TRUNKS, SUITCASES, LUGGAGE, LUGGAGE TAGS, RUCKSACKS, BACKPACKS; BAGS, NAMELY, HANDBAGS, SHOULDER BAGS, CLUTCH BAGS, ALL PURPOSE SPORTS BAGS, ATTACHE CASES, SHOPPING BAGS, TOTE BAGS, TRAVELLING BAGS, BELT POUCHES, KNAPSACKS, HAVERSACKS AND PURSES; LEATHER KEY-CASES; WALLET; BRIEFCASES; UMBRELLAS; PARASOLS; WALKING STICKS (U.S. CLS. 1, 2, 3, 22 AND 41).

CLASS 25—CLOTHING

FOR CLOTHING, NAMELY, SHIRTS, PANTS, PANTY-HOSE, SNOW PANTS, SCARVES, PULLOVERS, WAIST-COATS, TROUSERS, VESTS, PARKAS, SWEATERS, BLAZERS, GAITERS, KNITWEAR, LEGGINGS, BELTS, SUSPENDERS, BANDS, BLOUSES, SOCKS, STOCKINGS, SKI SUITS, SPORTS-SUITS, CAPS WITH EAR FLAPS, BANDANAS, COLLARS, SUN VISORS, JERKINS, SLACKS, MITTENS, TANK TOPS, CARDIGANS, JUMPERS, NIGHTGOWNS, BODY SUITS, JOGGING SUITS, GLOVES, COATS, JACKETS AND WIND RESISTANT JACKETS, FOULARDS; SKI BOOTS; FOOTWEAR (U.S. CLS. 22 AND 39).

CLASS 28—TOYS AND SPORTING GOODS

FOR SPORTING ARTICLES, NAMELY, SKATEBOARDS, SNOWBOARDS, ROLLER SKATES, IN-LINE SKATES, ICE SKATES, TENNIS AND SQUASH RACKETS, PADDLEBALL AND BADMINTON RACKETS, RACQUETBALL AND TABLE TENNIS PADDLES, SNOW SKIS, SKI POLES, SKI AND SKI BOOTS CASES, SKI BINDINGS, SKI GOGGLES, SNOWBOARDS BINDINGS, ROLLER SKIS, SPORTS BALLS, SKI BOARDS, SHORT SKIS, WINDSURFING AND SURFING BOARDS, GOLF CLUBS, GOLF BAGS (U.S. CLS. 22, 23, 38 AND 50).

SN 76-177,442. KARLOFF, HOWARD O., LEWISVILLE, TX. FILED 12-4-2000.

CALIFORNIA BEACH NATURALS

CLASS 25—CLOTHING

FOR CLOTHING NAMELY SHIRTS, PANTS, HEADWEAR, SWIMWEAR, SHOES, RAINWEAR (U.S. CLS. 22 AND 39).

CLASS 32—LIGHT BEVERAGES

FOR LIGHT BEVERAGES NAMELY FRUIT DRINKS AND FRUIT JUICES (U.S. CLS. 45, 46 AND 48).

SN 76-177,750. GORGOS, EVELYN, 87711 MINDELHEIM, FED REP GERMANY, FILED 12-8-2000.

bio-mxc²

PRIORITY CLAIMED UNDER SEC. 44(D) ON ERP N CMNTY TM OFC APPLICATION NO. 001732221, FILED 6-30-2000, REG. NO. 1732221, DATED 9-5-2001, EXPIRES 9-5-2011.

CLASS 12—VEHICLES

FOR SPORTS BICYCLES AND PARTS, NAMELY, BICYCLE FRAMES, BICYCLE HANDLE BARS, BICYCLE PEDALS, BICYCLE RIMS, BICYCLE SADDLES, BICYCLE SADDLE COVERS, BICYCLE WHEELS, BICYCLE TIRES, BICYCLE TUBES (U.S. CLS. 19, 21, 23, 31, 35 AND 44).

CLASS 25—CLOTHING

FOR SPORTS SHOES FOR CYCLING AND RUNNING AND OUTDOOR SPORTS AND PARTS THEREOF, NAMELY, OUTSOLES, CLEATS, CLEAT SUPPORT PLATES, INNERSOLES; SPORTS CLOTHING, NAMELY ANORAKS FOR SPORTSWEAR, SPORT SHIRTS, SWEATSHIRTS, T-SHIRTS, UNDERCLOTHING, SOCKS, STOCKINGS FOR SPORTS, SPORTS CAPS, GLOVES AND MITTENS FOR SPORTS; CYCLIST'S CLOTHING, NAMELY, ANORAKS, SHORTS, SWEATSHIRTS, T-SHIRTS, UNDERCLOTHING, SOCKS, STOCKINGS, CAPS, GLOVES AND MITTENS (U.S. CLS. 22 AND 39).

CLASS 42—SCIENTIFIC, COMPUTER AND LEGAL SERVICES

FOR PRODUCT RESEARCH AND DEVELOPMENT IN THE FIELD OF CYCLING; HEALTH COUNSELING IN THE FIELD OF CYCLING (U.S. CLS. 100 AND 101).

SN 76-177,780. NATAM S.R.L., 20123 MILANO, ITALY, FILED 12-8-2000.

**CLASS 35—ADVERTISING AND BUSINESS**

FOR ADVERTISING AND BUSINESS MANAGEMENT CONSULTATION SERVICES, SYSTEMIZATION OF INFORMATION IN DATA BANK OF COMPUTERS, CONSULTATION IN THE FIELD OF E-COMMERCE AND E-BUSINESS; ASSISTANCE SERVICES, IN THE NATURE OF SOFTWARE, IN THE FIELD OF TREATING AND UTILIZATION OF INFORMATION AIMED AT THE INDIVIDUATION, SELECTION AND CHOICE OF PRODUCTS AND/OR INFORMATION THROUGH COMPUTERS (U.S. CLS. 100, 101 AND 102).

CLASS 38—COMMUNICATION

FOR TELECOMMUNICATION SERVICES, NAMELY, THE INTERACTIVE DIGITAL COMMUNICATION AND ELECTRONIC TRANSMISSION OF MESSAGES, DATA, IMAGES AND DOCUMENTS, THROUGH SYSTEMS OF SUPPORT AND SIMPLIFICATION FOR THE NAVIGATION IN INFORMATION AND DATABASE; PROVIDING INFORMATION CONCERNING TELECOMMUNICATIONS VIA THE INTERNET; PROVIDING MULTIPLE-USER ACCESS TO A GLOBAL COMPUTER INFORMATION NETWORK (U.S. CLS. 100, 101 AND 104).

CLASS 42—SCIENTIFIC, COMPUTER AND LEGAL SERVICES

FOR TECHNICAL CONSULTATION IN THE FIELD OF SUPPORT TO PRODUCTIVE, COMMERCIAL, MARKETING, DATA MANAGEMENT ACTIVITIES; TECHNICAL SUPPORT, NAMELY, IN THE FIELD OF ELECTRONIC DEVICES, INFORMATIVE SYSTEMS; COMPUTER PROGRAMMING FOR OTHERS (U.S. CLS. 100 AND 101).

SN 76-178,126. TM ENTERPRISES, LLC, RIDGEFIELD, CT. FILED 12-4-2000.



THE MARK CONSISTS OF A STYLIZED "T" (IN UPPER CASE CURSIVE) AND A STYLIZED "M" (IN LOWER CASE CURSIVE) WITH A CIRCLE OR MOON ABOVE EACH LETTER.

CLASS 41—EDUCATION AND ENTERTAINMENT

FOR EDUCATIONAL SERVICES, NAMELY CONDUCTING SEMINARS AND WORKSHOPS IN CLASSROOMS AND AUDITORIUMS FOR SCHOOL-AGE CHILDREN AND TEACHERS OF SCHOOL-AGE CHILDREN IN KINDERGARTEN THROUGH TWELFTH GRADE IN THE FIELDS OF POETRY, FICTION AND LITERATURE; PUBLISHING SERVICES, NAMELY, PUBLISHING OF THE BOOKS OF OTHERS IN THE FIELDS OF POETRY, FICTION AND LITERATURE FOR SCHOOL-AGE CHILDREN AND TEACHERS OF SCHOOL-AGE CHILDREN IN KINDERGARTEN THROUGH TWELFTH GRADE (U.S. CLS. 100, 101 AND 107).

CLASS 42—SCIENTIFIC, COMPUTER AND LEGAL SERVICES

FOR CONSULTING IN THE FIELDS OF CHILDREN'S EDUCATION AND ENTERTAINMENT (U.S. CLS. 100 AND 101).

SN 76-178,710. ALL-STATE INTERNATIONAL, INC., CRANFORD, NJ. FILED 12-11-2000.



NO CLAIM IS MADE TO THE EXCLUSIVE RIGHT TO USE "LEGAL", APART FROM THE MARK AS SHOWN.

CLASS 9—ELECTRICAL AND SCIENTIFIC APPARATUS

FOR BLANK AUDIO CASSETTES FOR DICTATION, BLANK FLOPPY DISKS AND DISKETTES FOR COMPUTERS, TYPEWRITERS AND WORD PROCESSORS AND MAGNETIC CODED CARDS (U.S. CLS. 21, 23, 26, 36 AND 38).

FIRST USE 2-1-2001; IN COMMERCE 2-1-2001.

CLASS 16—PAPER GOODS AND PRINTED MATTER

FOR OFFICE PAPER REQUISITES, NAMELY, TYPING PAPER, WRITING PAPER, PAPER PADS, CARBON PAPER, ONIONSKIN PAPER, RULED AND UNRULED PAPER, FACSIMILE PAPER, PHOTOCOPY PAPER, FILE JACKETS, FILE FOLDERS, FILE ENVELOPES, FILE LABELS, BUSINESS RECORD FORMS, TELEPHONE MESSAGE PADS, PREPRINTED FORMS FOR RECORDING INFORMATION, CLIPBOARDS FOR HOLDING PADS OF PAPER WITHOUT A BACK, LEDGER SHEETS, TIME RECORD SHEETS, CONTINUOUS FORM PAPER, FILE CARDS, LETTERHEAD PAPER, PRINTED AND ENGRAVED ENVELOPES, PLAIN ENVELOPES, PRINTED AND ENGRAVED LETTERHEADS AND BILLHEADS, BUSINESS CARDS, ANNOUNCEMENT CARDS AND FORMS, WILL SETS PRINCIPALLY CONSISTING OF DOCUMENTS, BILLING FORMS, CORPORATE OUTFITS PRINCIPALLY CONSISTING OF DOCUMENT FORMS AND STOCK CERTIFICATES, MULTI PART MEMO FORMS, LEGAL FORMS, STOCK TRANSFER LEDGERS, ACTIVITY REMINDER FORMS, PRINTED AND PLAIN MINUTES AND BY-LAWS, WORKSHEETS FOR PREPARATION OF MINUTES AND BY-LAWS, CORPORATE EMBOSSED SEALS, CARBONLESS FORMS, AND FORM LETTERS; OFFICE REQUISITES, NAMELY, EXHIBIT DIVIDERS MADE OF PAPER, BINDERS, PAPER HOLE PUNCHERS, PAPER CLIPS, DESK ORGANIZERS CONSISTING OF COMPARTMENTED TRAYS FOR HOLDING STATIONERY ITEMS SUCH AS PENS AND PAPER CLIPS, PAPER FASTENERS, GRADUATED RULERS, CLIPBOARDS, RUBBER BANDS, AND RUBBER STAMPS; BUSINESS ADVERTISING, MARKETING AND PROMOTIONAL ENSEMBLES, NAMELY, PRINTED PANEL FOLDERS, ENVELOPES AND TELEPHONE INDEX CARDS; OFFICE PRODUCTS, NAMELY, PENCIL SHARPENERS AND DESK ORGANIZERS; AND TYPEWRITER AND WORD PROCESSOR ACCESSORIES, NAMELY, PRINTWHEELS, TYPE ELEMENTS AND TYPE RIBBONS (U.S. CLS. 2, 5, 22, 23, 29, 37, 38 AND 50).

FIRST USE 2-1-2001; IN COMMERCE 2-1-2001.

CLASS 35—ADVERTISING AND BUSINESS

FOR MAIL ORDER DISTRIBUTORSHIP SERVICES IN THE FIELD OF OFFICE SUPPLIES TO OTHERS (U.S. CLS. 100, 101 AND 102).

FIRST USE 1-2-2001; IN COMMERCE 1-2-2001.

CLASS 40—MATERIAL TREATMENT

FOR ENGRAVING SERVICES, NAMELY, THE ENGRAVING OF LETTERHEADS, ENVELOPES, BUSINESS CARDS, ANNOUNCEMENTS, PROMOTIONAL ENSEMBLES, FORMS AND AGREEMENTS (U.S. CLS. 100, 103 AND 106).

FIRST USE 1-2-2001; IN COMMERCE 1-2-2001.

SN 76-179,203. AD4EVER INC., NEW YORK, NY. FILED 12-11-2000.

TOPLAYER

CLASS 9—ELECTRICAL AND SCIENTIFIC APPARATUS

FOR SOFTWARE FOR CREATING INTERACTIVE ADVERTISING, BRANDING AND COMMERCE APPLICATIONS AND REPORTS FOR DIFFERENT TYPES OF MEDIA, INCLUDING THE GLOBAL COMPUTER NETWORK (U.S. CLS. 21, 23, 26, 36 AND 38).

FIRST USE 12-12-2000; IN COMMERCE 12-12-2000.

CLASS 35—ADVERTISING AND BUSINESS

FOR INTERACTIVE ADVERTISING SERVICES FOR OTHERS, NAMELY CREATING AND DISSEMINATING INTERACTIVE ADVERTISING MATTER; CONSULTING, CREATING AND DELIVERING CORPORATE AND BRAND IDENTITY FOR OTHERS; ASSISTING OTHERS IN THE OPERATION OF E-COMMERCE, INCLUDING THROUGH ADVERTISEMENTS, DISCOUNT COUPONS AND SALE CAMPAIGNS; GENERATING REPORTS FOR OTHERS REGARDING CONSUMER BEHAVIOR PATTERNS - ALL THE ABOVE THROUGH DIFFERENT TYPES OF MEDIA, INCLUDING THROUGH THE GLOBAL COMPUTER NETWORK (U.S. CLS. 100, 101 AND 102).

FIRST USE 12-12-2000; IN COMMERCE 12-12-2000.

SN 76-179,427. INTO NETWORKS, INC., CAMBRIDGE, MA. FILED 12-13-2000.

**CLASS 9—ELECTRICAL AND SCIENTIFIC APPARATUS**

FOR COMPUTER SOFTWARE FOR ELECTRONIC TRANSMISSION AND DELIVERY OF EXECUTABLE SOFTWARE APPLICATIONS, DATA, AND MULTIMEDIA CONTENT OVER COMPUTER NETWORKS (U.S. CLS. 21, 23, 26, 36 AND 38).

CLASS 35—ADVERTISING AND BUSINESS

FOR DISTRIBUTORSHIP IN THE FIELD OF EXECUTABLE SOFTWARE APPLICATIONS, DATA, AND MULTIMEDIA CONTENT FOR ELECTRONIC TRANSMISSION AND DELIVERY OVER COMPUTER NETWORKS (U.S. CLS. 100, 101 AND 102).

CLASS 38—COMMUNICATION

FOR ELECTRONIC TRANSMISSION AND DELIVERY OF EXECUTABLE SOFTWARE APPLICATIONS, DATA, AND MULTIMEDIA CONTENT OVER COMPUTER NETWORKS (U.S. CLS. 100, 101 AND 104).

CLASS 42—SCIENTIFIC, COMPUTER AND LEGAL SERVICES

FOR COMPUTER CONSULTING SERVICES IN THE FIELD OF ELECTRONIC TRANSMISSION AND DELIVERY OF EXECUTABLE SOFTWARE APPLICATIONS, DATA, AND MULTIMEDIA CONTENT (U.S. CLS. 100 AND 101).

SN 76-179,767. U.S. PROS, INC., OKLAHOMA CITY, OK.
FILED 12-6-2000.

123TURF.COM

CLASS 35—ADVERTISING AND BUSINESS

FOR WHOLESALE DISTRIBUTORSHIP FEATURING TURF AND ORNAMENTAL APPLICATORS, INSECTICIDES, HERBICIDES; COMPUTERIZED ON-LINE RETAIL SERVICES IN THE FIELD OF PEST CONTROL, TURF AND ORNAMENTAL APPLICATORS, INSECTICIDES, HERBICIDES (U.S. CLS. 100, 101 AND 102).

CLASS 36—INSURANCE AND FINANCIAL

FOR FINANCIAL SERVICES, NAMELY, FINANCING SERVICES (U.S. CLS. 100, 101 AND 102).

SN 76-179,781. ISERVICEX.COM, INC., ATLANTA, GA.
FILED 12-12-2000.

ISERVICEX

CLASS 9—ELECTRICAL AND SCIENTIFIC APPARATUS

FOR COMPUTER SOFTWARE USED FOR THE PROCUREMENT, DELIVERY AND MANAGEMENT OF PROFESSIONAL SERVICES, NAMELY, USED FOR THE GENERATION OF ELECTRONIC REQUESTS FOR PROPOSALS, ELECTRONIC REQUESTS FOR INFORMATION, ONLINE PROPOSAL DEVELOPMENT AND USED FOR AUCTIONING PROFESSIONAL SERVICES (U.S. CLS. 21, 23, 26, 36 AND 38).

CLASS 35—ADVERTISING AND BUSINESS

FOR BUSINESS CONSULTING SERVICES IN THE FIELDS OF PROCUREMENT AND BUSINESS MANAGEMENT FOR PROFESSIONAL SERVICES (U.S. CLS. 100, 101 AND 102).

SN 76-181,131. ADUVA, INC., NEW YORK, NY. FILED 12-14-2000.

ADUWISE

CLASS 9—ELECTRICAL AND SCIENTIFIC APPARATUS

FOR COMPUTER PROGRAMS, NAMELY COMPUTER SOFTWARE TO FACILITATE COMPUTER USE AND OPERATION; COMPUTER SOFTWARE FOR DESKTOP, CLIENT AND SERVER APPLICATIONS FOR COMPUTER SYSTEMS AND COMPUTER PERIPHERALS; COMPUTER SOFTWARE FOR INSTALLING, MAINTAINING AND UPGRADING COMPUTER SOFTWARE, CLIENT AND SERVER APPLICATIONS AND COMPUTER HARDWARE, AND COMPUTER PERIPHERALS (U.S. CLS. 21, 23, 26, 36 AND 38).

CLASS 35—ADVERTISING AND BUSINESS

FOR BUSINESS MANAGEMENT AND BUSINESS ADMINISTRATION CONSULTING SERVICES PROVIDED VIA THE INTERNET; ONLINE STORE SERVICES FEATURING COMPUTER SOFTWARE; COMPUTER DATABASE MANAGEMENT SERVICES; MARKETING SERVICES, NAMELY, CAPTURING AND ANALYZING INFORMATION RELATING TO ONLINE TRANSACTIONS AND PROVIDING STATISTICAL INFORMATION BASED THEREON (U.S. CLS. 100, 101 AND 102).

CLASS 42—SCIENTIFIC, COMPUTER AND LEGAL SERVICES

FOR DATABASE DEVELOPMENT SERVICES; COMPUTER SERVICES PROVIDED VIA THE INTERNET, NAMELY, CUSTOM COMPUTER PROGRAMMING, COMPUTER SOFTWARE MAINTENANCE, PROVIDING CONSULTING SERVICES ABOUT COMPUTER HARDWARE DESIGN AND MAINTENANCE, UPGRADING, DOWNGRADING, IMPLEMENTING, REMOVAL, INSTALLATION AND PATCH OF COMPUTER SOFTWARE; COMPUTER DATA RECOVERY SERVICES; COMPUTER CONSULTING SERVICES (U.S. CLS. 100 AND 101).

SN 76-181,566. LOGMETRIX TECHNOLOGIES, 75018 PARIS, FRANCE, FILED 12-15-2000.

LOGMETRIX

OWNER OF FRANCE REG. NO. 99818145, DATED 10-18-1999, EXPIRES 10-18-2009.

CLASS 9—ELECTRICAL AND SCIENTIFIC APPARATUS

FOR DATA PROCESSING EQUIPMENT, NAMELY, COMPUTERS AND CALCULATORS; COMPUTER SOFTWARE FOR ANALYZING WEB SITE TRAFFIC AND MANAGING ELECTRONIC MAIL CAMPAIGNS; PRE-RECORDED DISKS, DISKETTES AND AUDIO DIGITAL DISKS FEATURING VIDEO GAMES (U.S. CLS. 21, 23, 26, 36 AND 38).

CLASS 38—COMMUNICATION

FOR TELECOMMUNICATIONS SERVICES, NAMELY, ELECTRONIC MAIL MESSAGING AND PROVIDING MULTIPLE USER ACCESS TO THE GLOBAL COMPUTER NETWORK (U.S. CLS. 100, 101 AND 104).

CLASS 42—SCIENTIFIC, COMPUTER AND LEGAL SERVICES

FOR SOFTWARE PROGRAMMING, DESIGN AND DEVELOPMENT FOR OTHERS; PROVIDING CONSULTING AND TECHNICAL ASSISTANCE IN THE FIELD OF COMPUTERS (U.S. CLS. 100 AND 101).

SN 76-181.691. PTT POST HOLDINGS B.V., HOOFDDORP, NETHERLANDS, FILED 12-15-2000.

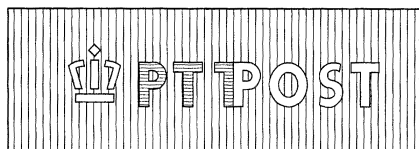

OWNER OF BENELUX REG. NO. 0651156, DATED 1-18-1999, EXPIRES 1-18-2009.

THE MARK IS LINED FOR THE COLORS RED AND BLUE.

CLASS 9—ELECTRICAL AND SCIENTIFIC APPARATUS

FOR COMPUTER EQUIPMENT, NAMELY, COMPUTER HARDWARE FOR THE PROCESSING OF MAIL, FOR THE FRANKING OF POSTAL ITEMS, AND FOR ELECTRONIC PAYMENT; COMPUTER SOFTWARE AND PROGRAMS, NAMELY, FOR THE PROCESSING OF MAIL, FOR THE FRANKING OF POSTAL ITEMS, AND FOR ELECTRONIC PAYMENT; COMPUTER HARDWARE AND SOFTWARE FOR CHECKING CORRECT FRANKING (U.S. CLS. 21, 23, 26, 36 AND 38).

CLASS 39—TRANSPORTATION AND STORAGE

FOR ARMORED CAR TRANSPORT; POSTAL SERVICES, NAMELY PARCEL AND MAIL DELIVERY AND STORAGE OF PARCELS AND MAIL; PACKAGING OF GOODS FOR TRANSPORT; CONSULTATION SERVICES, NAMELY, PROVIDING ADVICE ABOUT THE RENTING AND LEASING OF VEHICLES; PROVIDING INFORMATION CONCERNING THE AFOREMENTIONED SERVICES (U.S. CLS. 100 AND 105).

CLASS 42—SCIENTIFIC, COMPUTER AND LEGAL SERVICES

FOR TECHNICAL CONSULTATION AND RESEARCH AND DEVELOPMENT REGARDING THE TRANSPORT, SHIPMENT, STORAGE AND PACKAGING OF GOODS; COMPUTER PROGRAMMING FOR OTHERS; PROVIDING INFORMATION CONCERNING THE AFOREMENTIONED SERVICES; CONSULTATION, NAMELY, PROVIDING ADVICE ABOUT THE QUALITY, USE AND APPLICATIONS OF COMPUTER HARDWARE AND SOFTWARE FOR THE PROCESSING OF MAIL, THE FRANKING OF POSTAL ITEMS, ELECTRONIC PAYMENT AND POSTAL SERVICES (U.S. CLS. 100 AND 101).

SN 76-181.722. ADUVA, INC., NEW YORK, NY. FILED 12-14-2000.

ADUVIZE

CLASS 9—ELECTRICAL AND SCIENTIFIC APPARATUS

FOR COMPUTER PROGRAMS, NAMELY COMPUTER SOFTWARE TO FACILITATE COMPUTER USE AND OPERATION; COMPUTER SOFTWARE FOR DESKTOP, CLIENT AND SERVER APPLICATIONS FOR COMPUTER SYSTEMS AND COMPUTER PERIPHERALS; COMPUTER SOFTWARE FOR INSTALLING, MAINTAINING AND UPGRADING COMPUTER SOFTWARE, CLIENT AND SERVER APPLICATIONS AND COMPUTER HARDWARE, AND COMPUTER PERIPHERALS, ALL INCLUDED (U.S. CLS. 21, 23, 26, 36 AND 38).

CLASS 35—ADVERTISING AND BUSINESS

FOR BUSINESS MANAGEMENT AND BUSINESS ADMINISTRATION CONSULTING SERVICES PROVIDED VIA THE INTERNET; ONLINE STORE SERVICES FEATURING COMPUTER SOFTWARE; COMPUTER DATABASE MANAGEMENT SERVICES; MARKETING SERVICES, NAMELY, CAPTURING AND ANALYZING INFORMATION RELATING TO ONLINE TRANSACTIONS AND PROVIDING STATISTICAL INFORMATION BASED THEREON (U.S. CLS. 100, 101 AND 102).

CLASS 42—SCIENTIFIC, COMPUTER AND LEGAL SERVICES

FOR DATABASE DEVELOPMENT SERVICES; COMPUTER SERVICES PROVIDED VIA THE INTERNET, NAMELY, CUSTOM COMPUTER PROGRAMMING, COMPUTER SOFTWARE MAINTENANCE, PROVIDING CONSULTING SERVICES ABOUT COMPUTER HARDWARE DESIGN AND MAINTENANCE, UPGRADING, DOWNGRADING, IMPLEMENTING, REMOVAL, INSTALLATION AND PATCH OF COMPUTER SOFTWARE; COMPUTER DATA RECOVERY SERVICES; COMPUTER CONSULTING SERVICES (U.S. CLS. 100 AND 101).

SN 76-181.965. SMITHKLINE BEECHAM CORPORATION, PHILADELPHIA, PA. FILED 12-15-2000.

YOUR WELLNESS MATTERS

OWNER OF U.S. REG. NOS. 1,928,735, 2,030,617 AND 2,050,611.

CLASS 3—COSMETICS AND CLEANING PREPARATIONS

FOR TOOTHPASTE (U.S. CLS. 1, 4, 6, 50, 51 AND 52).

CLASS 5—PHARMACEUTICALS

FOR PHARMACEUTICAL PREPARATIONS, NAMELY, ANALGESICS, GASTROINTESTINAL PREPARATIONS, SMOKING CESSATION PREPARATIONS, SUPPLEMENTS, MEDICATED SKIN CARE PREPARATIONS, FEMININE HYGIENE PREPARATIONS, COUGH, COLD AND ALLERGY PREPARATIONS (U.S. CLS. 6, 18, 44, 46, 51 AND 52).

CLASS 21—HOUSEWARES AND GLASS

FOR TOOTHBRUSHES (U.S. CLS. 2, 13, 23, 29, 30, 33, 40 AND 50).

SN 76-181.967. SMITHKLINE BEECHAM CORPORATION, PHILADELPHIA, PA. FILED 12-15-2000.

MY WELLNESS MATTERS

OWNER OF U.S. REG. NOS. 1,928,735, 2,030,617 AND 2,050,611.

CLASS 3—COSMETICS AND CLEANING PREPARATIONS

FOR TOOTHPASTE (U.S. CLS. 1, 4, 6, 50, 51 AND 52).

CLASS 5—PHARMACEUTICALS

FOR PHARMACEUTICAL PREPARATIONS, NAMELY, ANALGESICS, GASTROINTESTINAL PREPARATIONS, SMOKING CESSATION PREPARATIONS, SUPPLEMENTS, MEDICATED SKIN CARE PREPARATIONS, FEMININE HYGIENE PREPARATIONS, COUGH, COLD AND ALLERGY PREPARATIONS (U.S. CLS. 6, 18, 44, 46, 51 AND 52).

CLASS 21—HOUSEWARES AND GLASS

FOR TOOTHBRUSHES (U.S. CLS. 2, 13, 23, 29, 30, 33, 40 AND 50).

SN 76-181,969. SMITHKLINE BEECHAM CORPORATION, PHILADELPHIA, PA. FILED 12-15-2000.

WELLNESS MATTERS

OWNER OF U.S. REG. NOS. 1,928,735, 2,030,617 AND 2,050,611.

CLASS 3—COSMETICS AND CLEANING PREPARATIONS

FOR TOOTHPASTE (U.S. CLS. 1, 4, 6, 50, 51 AND 52).

CLASS 5—PHARMACEUTICALS

FOR PHARMACEUTICAL PREPARATIONS, NAMELY, ANALGESICS, GASTROINTESTINAL PREPARATIONS, SMOKING CESSATION PREPARATIONS, SUPPLEMENTS, MEDICATED SKIN CARE PREPARATIONS, FEMININE HYGIENE PREPARATIONS, COUGH, COLD AND ALLERGY PREPARATIONS (U.S. CLS. 6, 18, 44, 46, 51 AND 52).

CLASS 21—HOUSEWARES AND GLASS

FOR TOOTHBRUSHES (U.S. CLS. 2, 13, 23, 29, 30, 33, 40 AND 50).

SN 76-182,196. AMERICAN UNIVERSITY, THE, WASHINGTON, DC. FILED 12-19-2000.

WAMU**CLASS 9—ELECTRICAL AND SCIENTIFIC APPARATUS**

FOR PRERECORDED COMPACT DISCS AND AUDIO CASSETTES IN THE FIELD OF MUSIC, PUBLIC AFFAIRS NEWS, TECHNOLOGY NEWS AND CULTURAL NEWS (U.S. CLS. 21, 23, 26, 36 AND 38).

FIRST USE 12-0-1985; IN COMMERCE 12-0-1985.

CLASS 38—COMMUNICATION

FOR RADIO BROADCASTING SERVICES AND ONLINE INTERNET RADIO BROADCASTING SERVICES (U.S. CLS. 100, 101 AND 104).

FIRST USE 0-0-1961; IN COMMERCE 0-0-1961.

CLASS 41—EDUCATION AND ENTERTAINMENT

FOR ENTERTAINMENT IN THE NATURE OF ONGOING RADIO PROGRAMS IN THE FIELD OF MUSIC, TALK RADIO, CULTURAL NEWS, PUBLIC AFFAIRS NEWS AND TECHNOLOGY NEWS (U.S. CLS. 100, 101 AND 107).

FIRST USE 0-0-1961; IN COMMERCE 0-0-1961.

SN 76-182,263. LAMBDA PHYSIK AG, D-37079 GOTTINGEN, FED REP GERMANY, FILED 12-18-2000.



PRIORITY CLAIMED UNDER SEC. 44(D) ON FED REP GERMANY APPLICATION NO. 30066788.4/0, FILED 9-6-2000.

OWNER OF U.S. REG. NOS. 1,538,751, 2,386,695 AND OTHERS.

THE MARK CONSISTS OF THE GREEK LETTER LAMBDA ENCLOSED WITHIN A CIRCLE.

CLASS 9—ELECTRICAL AND SCIENTIFIC APPARATUS

FOR LASER DEVICES FOR INDUSTRIAL AND SCIENTIFIC USE, NAMELY, EXCIMER LASERS (U.S. CLS. 21, 23, 26, 36 AND 38).

FIRST USE 7-0-1985; IN COMMERCE 7-0-1985.

CLASS 10—MEDICAL APPARATUS

FOR LASER DEVICES FOR MEDICAL USE, NAMELY, EXCIMER LASERS (U.S. CLS. 26, 39 AND 44).

FIRST USE 7-0-1985; IN COMMERCE 7-0-1985.

SN 76-182,303. EVEREST DOMAIN SERVICES, LLC, CHICAGO, IL. FILED 12-18-2000.

PERMANENT REGISTRATION**CLASS 9—ELECTRICAL AND SCIENTIFIC APPARATUS**

FOR COMPUTER SOFTWARE, NAMELY, COMPUTER SOFTWARE AND DATABASES FOR ACCEPTING AND RECORDING PAYMENTS FOR WEB-SITE IDENTIFIERS ON A GLOBAL COMPUTER NETWORK AND FOR AUTOMATICALLY PAYING ANY RENEWAL FEES FOR WEB-SITE IDENTIFIERS (U.S. CLS. 21, 23, 26, 36 AND 38).

CLASS 42—SCIENTIFIC, COMPUTER AND LEGAL SERVICES

FOR PROVIDING TEMPORARY USE OF NON-DOWNLOADABLE SOFTWARE FOR USE IN ACCEPTING AND RECORDING PAYMENTS FOR WEB-SITE IDENTIFIERS AND FOR AUTOMATICALLY PAYING RENEWAL FEES FOR SUCH WEB-SITE IDENTIFIERS (U.S. CLS. 100 AND 101).

SN 76-183,604. HUNTINGTON MEDICAL RESEARCH INSTITUTES, PASADENA, CA. FILED 12-19-2000.



SN 76-182,908. HIGH PERFORMANCE COACHING LIMITED, BUCKS, SL7 1BE, UNITED KINGDOM, FILED 12-20-2000.

SIX STEPS TO UNLIMITED PERFORMANCE

CLASS 9—ELECTRICAL AND SCIENTIFIC APPARATUS

FOR ELECTRONIC PUBLICATIONS, NAMELY, BOOKS, PERIODICALS, NEWSLETTERS, AND MANUALS IN THE FIELD OF BUSINESS MANAGEMENT; COMPUTER SOFTWARE FOR BUSINESS MANAGEMENT TRAINING (U.S. CLS. 21, 23, 26, 36 AND 38).

CLASS 16—PAPER GOODS AND PRINTED MATTER

FOR PRINTED MATTER AND PRINTED PUBLICATIONS, NAMELY, BOOKS, BOOKLETS, BROCHURES, LEAFLETS, PERIODICALS, NEWSLETTERS IN THE FIELD OF BUSINESS MANAGEMENT; PRINTED INSTRUCTIONAL AND TEACHING MATERIALS IN THE FIELD OF BUSINESS MANAGEMENT (U.S. CLS. 2, 5, 22, 23, 29, 37, 38 AND 50).

CLASS 35—ADVERTISING AND BUSINESS

FOR BUSINESS MANAGEMENT CONSULTATION (U.S. CLS. 100, 101 AND 102).

CLASS 41—EDUCATION AND ENTERTAINMENT

FOR EDUCATIONAL SERVICES, NAMELY, CONDUCTING CLASSES, TRAINING AND SEMINARS IN THE FIELD OF BUSINESS MANAGEMENT; COMPUTER EDUCATION BASED TRAINING; INFORMATION AND ADVICE IN RELATION TO EDUCATION AND TRAINING (U.S. CLS. 100, 101 AND 107).

CLASS 5—PHARMACEUTICALS

FOR PHARMACEUTICAL PREPARATIONS FOR THE TREATMENT OF CANCER, NEUROLOGICAL AND CARDIOVASCULAR DISEASES, AND GENETIC ABNORMALITIES (U.S. CLS. 6, 18, 44, 46, 51 AND 52).

CLASS 9—ELECTRICAL AND SCIENTIFIC APPARATUS

FOR COMPUTER SOFTWARE, FOR IMAGING PROCESSING, BIOINFORMATICS, AND CONTROL OF PHYSIOLOGICAL STIMULATION; MOTION PICTURE FILM DOCUMENTING BIOLOGICAL AND PHYSIOLOGICAL PHENOMENA, MEDICAL EDUCATION, AND PROMOTION OF PUBLIC UNDERSTANDING OF MEDICAL FACTS; PRERECORDED VIDEO TAPES FEATURING PUBLIC HEALTH, MEDICAL EDUCATION, AND FUND RAISING FOR CHARITABLE, MEMORIAL, EDUCATIONAL AND SCIENTIFIC PURPOSES (U.S. CLS. 21, 23, 26, 36 AND 38).

CLASS 10—MEDICAL APPARATUS

FOR PROSTHETIC DEVICES, NAMELY, ELECTRICAL DEVICES FOR STIMULATING THE NERVOUS SYSTEM (U.S. CLS. 26, 39 AND 44).

CLASS 16—PAPER GOODS AND PRINTED MATTER

FOR PRINTED MATTER, NAMELY, BOOKS ON MEDICAL EDUCATION, PUBLIC HEALTH, AND FUND RAISING FOR CHARITABLE, MEMORIAL, EDUCATIONAL, AND SCIENTIFIC PURPOSES AND FOR PUBLIC BENEFIT, MANUALS FOR MEDICAL EDUCATION, PUBLIC HEALTH, AND FUNDRAISING FOR CHARITABLE, MEMORIAL, EDUCATIONAL AND SCIENTIFIC PURPOSES; SHIPPING LABELS; PAPER IDENTIFICATION BADGES; AND CALENDARS (U.S. CLS. 2, 5, 22, 23, 29, 37, 38 AND 50).

CLASS 25—CLOTHING

FOR CLOTHING, NAMELY, SHIRTS, CAPS AND HEADWEAR, LABORATORY COATS, SURGICAL GOWNS, EMBLEMATIC PATCHES, AND LAPEL PINS (U.S. CLS. 22 AND 39).

CLASS 36—INSURANCE AND FINANCIAL

FOR FUNDRAISING FOR CHARITABLE, MEMORIAL, EDUCATIONAL, AND SCIENTIFIC PURPOSES, AND FOR NONPROFIT PUBLIC BENEFIT (U.S. CLS. 100, 101 AND 102).

CLASS 42—SCIENTIFIC, COMPUTER AND LEGAL SERVICES

FOR MEDICAL LABORATORY ANALYSES, AND MEDICAL RESEARCH RELATING TO MAGNETIC RESONANCE IMAGING AND SPECTROSCOPY, PROSTHETIC DEVICES, ONCOLOGY, GENETIC TESTING, AND CARDIOLOGY (U.S. CLS. 100 AND 101).

SN 76-184,477. PUBLIC SERVICE ENTERPRISE GROUP INCORPORATED, NEWARK, NJ. FILED 12-20-2000.



SN 76-183,677. OLD ALAZAN COMPANY, EL PASO, TX. FILED 12-13-2000.

Old Alazan

THE ENGLISH TRANSLATION OF THE WORD "ALAZAN" IN THE MARK IS "CHESTNUT", "REDDISH BROWN" OR "SORREL COLORED".

CLASS 35—ADVERTISING AND BUSINESS

FOR DISTRIBUTORSHIP SERVICES FEATURING FRESH CUT FLOWERS AND FRESH FLOWER ARRANGEMENTS (U.S. CLS. 100, 101 AND 102). FIRST USE 0-0-1995; IN COMMERCE 0-0-1996.

CLASS 41—EDUCATION AND ENTERTAINMENT

FOR RECREATIONAL DUDE RANCH ACTIVITIES, NAMELY, PROVIDING FACILITIES FOR HORSEBACK RIDING, HAY RIDES, AND CAMP-OUTS (U.S. CLS. 100, 101 AND 107). FIRST USE 0-0-1991; IN COMMERCE 0-0-1993.

CLASS 42—SCIENTIFIC, COMPUTER AND LEGAL SERVICES

FOR HOTEL AND RESTAURANT SERVICES; CATTLE BREEDING (U.S. CLS. 100 AND 101). FIRST USE 0-0-1995; IN COMMERCE 0-0-1996.

SN 76-183,984. ROYAL BANK OF CANADA, MONTREAL, QUEBEC H3C 3A9, CANADA, FILED 12-20-2000.

WORLDPROTECT

OWNER OF CANADA REG. NO. 532,593, DATED 9-13-2000, EXPIRES 9-13-2015.

CLASS 9—ELECTRICAL AND SCIENTIFIC APPARATUS

FOR SOFTWARE RELATING TO INSURANCE, NAMELY SOFTWARE WHICH ENABLES THE QUOTING AND BOOKING OF TRAVEL INSURANCE (U.S. CLS. 21, 23, 26, 36 AND 38).

CLASS 36—INSURANCE AND FINANCIAL

FOR TRAVEL INSURANCE SERVICES (U.S. CLS. 100, 101 AND 102).

OWNER OF U.S. REG. NOS. 943,409, 943,410 AND 1,626,321.

NO CLAIM IS MADE TO THE EXCLUSIVE RIGHT TO USE "GLOBAL", APART FROM THE MARK AS SHOWN.

THE ENERGY BURST DESIGN IS IN THE COLOR ORANGE. THE LETTERS ARE LINED FOR THE COLOR GRAY. THE WORD IS IN THE COLOR ORANGE.

CLASS 35—ADVERTISING AND BUSINESS

FOR OPERATION OF COGENERATION, THERMAL AND INDEPENDENT ELECTRIC POWER PRODUCTION FACILITIES FOR OTHERS (U.S. CLS. 100, 101 AND 102).

CLASS 37—CONSTRUCTION AND REPAIR

FOR CONSTRUCTION, AND MAINTENANCE OF COGENERATION, THERMAL AND INDEPENDENT ELECTRIC POWER PRODUCTION FACILITIES FOR OTHERS (U.S. CLS. 100, 103 AND 106).

CLASS 39—TRANSPORTATION AND STORAGE

FOR UTILITY SERVICES IN THE NATURE OF DISTRIBUTION AND TRANSMISSION OF ELECTRICITY AND THERMAL ENERGY TO A BROAD RANGE OF INDUSTRIAL, COMMERCIAL, INSTITUTIONAL AND RESIDENTIAL CUSTOMERS (U.S. CLS. 100 AND 105).

CLASS 40—MATERIAL TREATMENT

FOR PRODUCTION OF ENERGY IN THE FORM OF COGENERATION, THERMAL AND ELECTRIC POWER, WHETHER FOSSIL-FUELED, HYDRO, RENEWABLE ENERGIES OR OTHERWISE (U.S. CLS. 100, 103 AND 106).

CLASS 42—SCIENTIFIC, COMPUTER AND LEGAL SERVICES

FOR DESIGN FOR OTHERS IN THE FIELD OF COGENERATION, THERMAL AND INDEPENDENT ELECTRIC POWER PRODUCTION FACILITIES; ENGINEERING OF COGENERATION, THERMAL AND INDEPENDENT ELECTRIC POWER PRODUCTION FACILITIES FOR OTHERS (U.S. CLS. 100 AND 101).

SN 76-184,797. PAYCHEX PROPERTIES, INC., SANTA ANA, CA. BY ASSIGNMENT PAYCHEX, INC., ROCHESTER, NY. FILED 12-21-2000.

READYCHEX**CLASS 35—ADVERTISING AND BUSINESS**

FOR BOOKKEEPING FOR ELECTRONIC FUNDS TRANSFERS IN THE FIELD OF PAYROLL ACCOUNTS (U.S. CLS. 100, 101 AND 102).

FIRST USE 9-0-1999; IN COMMERCE 9-0-1999.

CLASS 36—INSURANCE AND FINANCIAL

FOR ELECTRONIC FUNDS TRANSFER SERVICES IN THE FIELD OF PAYROLL ACCOUNTS (U.S. CLS. 100, 101 AND 102).

FIRST USE 9-0-1999; IN COMMERCE 9-0-1999.

SN 76-184,871. TRANSCENTIVE, INC., SHELTON, CT. FILED 12-20-2000.

TRANSCENTIVE

CLASS 9—ELECTRICAL AND SCIENTIFIC APPARATUS

FOR COMPUTER SOFTWARE USED FOR MANAGING STOCK OPTIONS, EMPLOYEE COMPENSATION INCENTIVES, AND EQUITY COMPENSATION MANAGEMENT (U.S. CLS. 21, 23, 26, 36 AND 38).

FIRST USE 10-2-2000; IN COMMERCE 11-20-2000.

CLASS 36—INSURANCE AND FINANCIAL

FOR FINANCIAL SERVICES, NAMELY, MANAGING STOCK OPTIONS, EMPLOYEE COMPENSATION INCENTIVES, AND EQUITY COMPENSATION (U.S. CLS. 100, 101 AND 102).

FIRST USE 10-2-2000; IN COMMERCE 11-20-2000.

SN 76-184,944. BRIGHTPOINT, INC., INDIANAPOLIS, IN. FILED 12-22-2000.

BRIGHTPOINT DIRECT

OWNER OF U.S. REG. NOS. 2,170,782 AND 2,353,363.
NO CLAIM IS MADE TO THE EXCLUSIVE RIGHT TO USE "DIRECT", APART FROM THE MARK AS SHOWN.

CLASS 35—ADVERTISING AND BUSINESS

FOR DISTRIBUTORSHIPS IN THE FIELD OF WIRELESS COMMUNICATION EQUIPMENT, NAMELY, DISTRIBUTORSHIPS FOR WIRELESS TELEPHONES AND WIRELESS TELEPHONE BATTERY CHARGERS, BATTERY ELIMINATORS, REPLACEMENT BATTERIES, WATTAGE BOOSTERS, HANDS FREE HEADSETS AND KITS, HOLDERS AND CRADLES, CARRYING CASES AND BAGS, EARPHONES, MICROPHONES, CIGAR-ETTE LIGHTER ADAPTERS, ANTENNAE, HANG-UP CUPS, HANDSET EXTENSION CABLES, POWER CABLES AND DATA CABLES; MAIL ORDER CATALOG SERVICES FEATURING WIRELESS COMMUNICATION EQUIPMENT AND ACCESSORIES THEREFOR; COMPUTERIZED ON-LINE ORDERING AND PRODUCT ORDER FULFILLMENT SERVICES IN THE FIELD OF WIRELESS COMMUNICATION EQUIPMENT AND ACCESSORIES THEREFOR; INVENTORY MANAGEMENT OF WIRELESS COMMUNICATION EQUIPMENT AND ACCESSORIES THEREFOR FOR OTHERS; PACKAGING WIRELESS COMMUNICATION EQUIPMENT AND ACCESSORIES THEREFOR TO THE ORDER AND SPECIFICATION OF OTHERS; ACCOUNTS RECEIVABLE MANAGEMENT SERVICES IN THE FIELD OF WIRELESS COMMUNICATION EQUIPMENT AND ACCESSORIES THEREFOR (U.S. CLS. 100, 101 AND 102).

CLASS 36—INSURANCE AND FINANCIAL

FOR FINANCIAL SERVICES RELATING TO WIRELESS COMMUNICATION EQUIPMENT AND ACCESSORIES THEREFOR, NAMELY, CREDIT AND DEBT RECOVERY COLLECTION SERVICES, AND CREDIT RISK MANAGEMENT SERVICES (U.S. CLS. 100, 101 AND 102).

CLASS 37—CONSTRUCTION AND REPAIR

FOR REPAIR AND REFURBISHING OF WIRELESS COMMUNICATION EQUIPMENT AND ACCESSORIES THEREFOR (U.S. CLS. 100, 103 AND 106).

CLASS 39—TRANSPORTATION AND STORAGE

FOR INVENTORY STORAGE SERVICES, NAMELY, STORAGE OF WIRELESS COMMUNICATION EQUIPMENT AND ACCESSORIES THEREFOR FOR OTHERS (U.S. CLS. 100 AND 105).

CLASS 42—SCIENTIFIC, COMPUTER AND LEGAL SERVICES

FOR PACKAGING DESIGN FOR WIRELESS COMMUNICATION EQUIPMENT AND ACCESSORIES THEREFOR TO THE ORDER AND SPECIFICATION OF OTHERS (U.S. CLS. 100 AND 101).

SN 76-185,203. CLASSMATE, L.L.C., HOUSTON, TX. FILED 12-21-2000.

THE ALGEBRA 1 CLASSMATE

NO CLAIM IS MADE TO THE EXCLUSIVE RIGHT TO USE "ALGEBRA 1", APART FROM THE MARK AS SHOWN.

CLASS 9—ELECTRICAL AND SCIENTIFIC APPARATUS

FOR DOWNLOADABLE COMPUTER PROGRAMS, COMPUTER SOFTWARE, AND PRERECORDED CD ROMS WHICH OPERATE AS ELECTRONIC TEXTBOOKS FOR USE BY PRIMARY, SECONDARY, HIGH SCHOOL, COLLEGE AND UNIVERSITY, GRADUATE, AND POST-GRADUATE STUDENTS IN THE FIELDS OF ENGLISH, READING, ALGEBRA, TRIGONOMETRY, CALCULUS, BASIC MATH, SCIENCE, BIOLOGY, PHYSICS, AND OTHER SCIENCES (U.S. CLS. 21, 23, 26, 36 AND 38).

FIRST USE 5-1-2000; IN COMMERCE 5-1-2000.

CLASS 42—SCIENTIFIC, COMPUTER AND LEGAL SERVICES

FOR PROVIDING TEMPORARY USE OF ON-LINE NON-DOWNLOADABLE SOFTWARE FOR USE AS ELECTRONIC TEXTBOOKS BY PRIMARY, SECONDARY, HIGH SCHOOL, COLLEGE AND UNIVERSITY, GRADUATE, AND POST-GRADUATE STUDENTS IN THE FIELDS OF ENGLISH, READING, ALGEBRA, TRIGONOMETRY, CALCULUS, BASIC MATH, SCIENCE, BIOLOGY, PHYSICS, AND OTHER SCIENCES (U.S. CLS. 100 AND 101).

FIRST USE 5-1-2000; IN COMMERCE 5-1-2000.

SN 76-186,141. J.A. THOMAS & ASSOCIATES, INC., SMYRNA, GA. FILED 12-26-2000.

CLINICAL DOCUMENTATION MANAGEMENT PROGRAM

NO CLAIM IS MADE TO THE EXCLUSIVE RIGHT TO USE "MANAGEMENT PROGRAM", APART FROM THE MARK AS SHOWN.
SEC. 2(F).

SN 76-187,326. HATTERAS NETWORKS, INC., RESEARCH TRIANGLE PARK, NC. FILED 12-28-2000.

CLASS 41—EDUCATION AND ENTERTAINMENT

FOR TRAIN PHYSICIANS, NURSES AND HEALTH INFORMATION MANAGEMENT PROFESSIONAL IN COMPLIANT DOCUMENTATION TECHNIQUES IN THE FIELD OF HEALTHCARE IN AN EFFORT TO BUILD AND/OR COMPLEMENT HEALTHCARE COMPLIANCE PROGRAMS (U.S. CLS. 100, 101 AND 107).
FIRST USE 1-1-1992; IN COMMERCE 1-1-1992.



NO CLAIM IS MADE TO THE EXCLUSIVE RIGHT TO USE "NETWORKS", APART FROM THE MARK AS SHOWN.

CLASS 42—SCIENTIFIC, COMPUTER AND LEGAL SERVICES

FOR REVIEW AND ESTABLISH STANDARDS AND PRACTICES TO ASSURE COMPLIANCE WITH HEALTHCARE DOCUMENTATION LAW AND REGULATIONS; TECHNICAL CONSULTATION IN THE FIELD OF HEALTHCARE WHICH SUSTAINS DOCUMENTATION COMPLIANCE (U.S. CLS. 100 AND 101).
FIRST USE 1-1-1992; IN COMMERCE 1-1-1992.

CLASS 9—ELECTRICAL AND SCIENTIFIC APPARATUS

FOR COMPUTER HARDWARE, NETWORKING HARDWARE FOR USE IN THE FIELD OF TELECOMMUNICATIONS AND DATA NETWORKING; COMPUTER SOFTWARE FOR CONNECTING COMPUTER NETWORK USERS OVER COMPUTER NETWORKS (U.S. CLS. 21, 23, 26, 36 AND 38).

SN 76-186,789. HBH ENTERPRISES, SPRINGVILLE, UT.
FILED 12-27-2000.

PREMIUM GOLD

NO CLAIM IS MADE TO THE EXCLUSIVE RIGHT TO USE "PREMIUM", APART FROM THE MARK AS SHOWN.

CLASS 37—CONSTRUCTION AND REPAIR

FOR INSTALLATION, MAINTENANCE AND REPAIR SERVICES, NAMELY, PROVIDING INSTALLATION, MAINTENANCE AND REPAIR SERVICES TO CUSTOMERS IN THE FIELD OF TELECOMMUNICATIONS AND DATA NETWORKING (U.S. CLS. 100, 103 AND 106).

CLASS 41—EDUCATION AND ENTERTAINMENT

FOR EDUCATIONAL SERVICES, NAMELY, CONDUCTING SEMINARS, WORKSHOPS AND CLASSES IN THE FIELD OF TELECOMMUNICATIONS AND DATA NETWORKING (U.S. CLS. 100, 101 AND 107).

CLASS 3—COSMETICS AND CLEANING PREPARATIONS

FOR SHAMPOO FOR PETS, NAMELY, DOG SHAMPOO (U.S. CLS. 1, 4, 6, 50, 51 AND 52).

CLASS 42—SCIENTIFIC, COMPUTER AND LEGAL SERVICES

FOR DESIGN AND SUPPORT SERVICES, NAMELY, DESIGNING TELECOMMUNICATION NETWORKS AND DATA NETWORKS FOR OTHERS, PROVIDING TECHNICAL SUPPORT SERVICES TO OTHERS IN THE FIELD OF TELECOMMUNICATIONS AND DATA NETWORKING (U.S. CLS. 100 AND 101).

CLASS 11—ENVIRONMENTAL CONTROL APPARATUS

FOR AQUARIUM SIPHON WATER REMOVAL UNITS; AQUARIUM FILTERS AND FILTER CARTRIDGES (U.S. CLS. 13, 21, 23, 31 AND 34).

CLASS 16—PAPER GOODS AND PRINTED MATTER

FOR AQUARIUMS, FISH TANKS AND FISH BOWLS (U.S. CLS. 2, 5, 22, 23, 29, 37, 38 AND 50).

SN 76-187,561. MATERIAL HANDLING SUPPLY, INC., BROOKLAWN, NJ. FILED 12-29-2000.

CLASS 28—TOYS AND SPORTING GOODS

FOR TOYS FOR PETS AND ANIMALS, NAMELY, FABRIC TOYS, PLASTIC TOYS AND CHEW TOYS; AQUARIUM NETS FOR MOVING FISH (U.S. CLS. 22, 23, 38 AND 50).

CLASS 31—NATURAL AGRICULTURAL PRODUCTS

FOR PET FOOD NAMELY FISH FOOD, DOG FOOD AND CAT FOOD; EDIBLE PET TREATS AND PET BISCUITS (U.S. CLS. 1 AND 46).



● ● Material Handling Supply, Inc.

SEC. 2(F) AS TO "MATERIAL HANDLING SUPPLY, INC."

CLASS 35—ADVERTISING AND BUSINESS

FOR RETAIL STORE SERVICES AND ONLINE RETAIL STORE SERVICES FEATURING NEW AND USED LIFT TRUCKS, LIFT TRUCK PARTS, MATERIAL HANDLING EQUIPMENT, DOCK EQUIPMENT, HAND TRUCKS, SHELVING UNITS, AND WAREHOUSE RACKS (U.S. CLS. 100, 101 AND 102).

FIRST USE 11-5-1992; IN COMMERCE 11-5-1992.

CLASS 37—CONSTRUCTION AND REPAIR

FOR REPAIR AND MAINTENANCE SERVICING FOR LIFT TRUCKS, MATERIAL HANDLING EQUIPMENT AND VEHICLES; ON-SITE INSTALLATION OF WAREHOUSE CENTERS AND DISTRIBUTION CENTERS (U.S. CLS. 100, 103 AND 106).

FIRST USE 1-20-1993; IN COMMERCE 1-20-1993.

CLASS 39—TRANSPORTATION AND STORAGE

FOR RENTAL OF LIFT TRUCKS AND MATERIAL HANDLING EQUIPMENT (U.S. CLS. 100 AND 105).

FIRST USE 1-20-1993; IN COMMERCE 1-20-1993.

CLASS 41—EDUCATION AND ENTERTAINMENT

FOR TRAINING IN USE AND OPERATION OF LIFT TRUCKS AND MATERIAL HANDLING EQUIPMENT (U.S. CLS. 100, 101 AND 107).

FIRST USE 1-20-1993; IN COMMERCE 1-20-1993.

CLASS 42—SCIENTIFIC, COMPUTER AND LEGAL SERVICES

FOR ARCHITECTURAL CONSULTATION AND DESIGN SERVICES FOR OTHERS IN THE FIELD OF WAREHOUSE DISTRIBUTION CENTERS (U.S. CLS. 100 AND 101).

FIRST USE 1-20-1993; IN COMMERCE 1-20-1993.

CLASS 28—TOYS AND SPORTING GOODS

FOR DOLLS, DOLL ACCESSORIES, TOY ACTION FIGURES, STUFFED TOYS AND WIND-UP TOYS, JIGSAW PUZZLES AND PARTY FAVORS IN THE NATURE OF SMALL TOYS FEATURING TELEVISION PROGRAMS, TELEVISION AND THEATRICAL PERFORMERS, ACTORS, COMEDY PERFORMANCES, CONTESTS, CARTOONS, CULTURAL AND EDUCATIONAL PROGRAMS AND TELEVISION VARIETY SHOWS (U.S. CLS. 22, 23, 38 AND 50).

CLASS 38—COMMUNICATION

FOR BROADCASTING OF RADIO AND TELEVISION PROGRAMS VIA SATELLITE AND CABLE TRANSMISSION AND A GLOBAL COMPUTER NETWORK; TELEPHONE AND CELLULAR TELEPHONE COMMUNICATIONS VIA OPTICAL FIBERS; CABLE RADIO TRANSMISSION OF LOCALIZED SIGNALS; ELECTRONIC MAIL SERVICES (U.S. CLS. 100, 101 AND 104).

CLASS 40—MATERIAL TREATMENT

FOR CINEMATOGRAPHIC ADAPTATION AND EDITING OF TELEVISION AND RADIO PROGRAMS (U.S. CLS. 100, 103 AND 106).

CLASS 41—EDUCATION AND ENTERTAINMENT

FOR ENTERTAINMENT SERVICES, NAMELY, AN ONGOING VARIETY SHOW DISTRIBUTED OVER TELEVISION AND RADIO BY MEANS OF CABLE, SATELLITE AND A GLOBAL COMPUTER NETWORK, FEATURING LIVE MUSICAL AND DANCE PERFORMANCES, PERSONAL INTERVIEWS, NEWS REPORTS, COMEDY, CONTESTS, COMPETITIONS, DOCUMENTARIES, EDUCATION, AND CULTURE AND SPORTING EVENTS; PRODUCTION OF RADIO AND TELEVISION PROGRAMS FEATURING CINEMA, THEATER, MUSICALS AND AUDIOVISUAL WORKS, NAMELY, FILMS AND TAPED RECORDINGS; RECORD, VIDEOTAPE AND AUDIO PRODUCTION FEATURING MUSIC; RENTAL OF PRODUCTION EQUIPMENT NECESSARY FOR RADIO AND TELEVISION, NAMELY, RENTAL OF TELEVISION SETS; RENTAL OF DRESSING ROOMS; RENTAL OF STAGE SCENERY; RENTAL OF ORCHESTRAS; RENTAL OF CHORAL AND MUSICAL GROUPS; RENTAL OF THEATERS; DUBBING SERVICES (U.S. CLS. 100, 101 AND 107).

SN 76-187,595. TV AZTECA, S.A. DE C.V., MEXICO, MEXICO, FILED 12-28-2000.

AZTECA AMERICA

OWNER OF U.S. REG. NOS. 2,289,909, 2,289,910 AND 2,428,683.

NO CLAIM IS MADE TO THE EXCLUSIVE RIGHT TO USE "AMERICA", APART FROM THE MARK AS SHOWN. THE ENGLISH TRANSLATION OF "AZTECA" IS "AZTEC".

CLASS 16—PAPER GOODS AND PRINTED MATTER

FOR PRINTED MATTER AND PRINTED PUBLICATIONS, NAMELY, POSTERS, MAGAZINES AND BOOKS FEATURING TELEVISION PROGRAMS, TELEVISION AND THEATRICAL PERFORMERS, ACTORS, COMEDY PERFORMANCES, CONTESTS, CARTOONS, CULTURAL AND EDUCATIONAL PROGRAMS AND TELEVISION VARIETY SHOWS (U.S. CLS. 2, 5, 22, 23, 29, 37, 38 AND 50).

SN 76-188,205. EARTH & OCEAN SPORTS, INC., REDMOND, WA. FILED 12-29-2000.

SWIM MASTERS

NO CLAIM IS MADE TO THE EXCLUSIVE RIGHT TO USE "SWIM", APART FROM THE MARK AS SHOWN.

CLASS 19—NON-METALLIC BUILDING MATERIALS

FOR UNFITTED SPA COVERS (U.S. CLS. 1, 12, 33 AND 50).

CLASS 21—HOUSEWARES AND GLASS

FOR POOL AND SPA CLEANING SPONGES (U.S. CLS. 2, 13, 23, 29, 30, 33, 40 AND 50).

SN 76-188,289. TELME S.P.A., 20073 CODOGNO (LODI), ITALY, FILED 12-29-2000.



NO CLAIM IS MADE TO THE EXCLUSIVE RIGHT TO USE "ICE CREAM & WHIPPED CREAM EQUIPMENT", APART FROM THE MARK AS SHOWN.

CLASS 7—MACHINERY

FOR ICE CREAM AND WHIPPED CREAM MACHINES, NAMELY, ELECTRIC COMMERCIAL MIXERS, FOOD PROCESSORS AND CREAM WHIPPERS (U.S. CLS. 13, 19, 21, 23, 31, 34 AND 35).

CLASS 11—ENVIRONMENTAL CONTROL APPARATUS

FOR REFRIGERATED ELECTRIC BATCH FREEZERS FOR ICE CREAM; REFRIGERATED MACHINES FOR MAKING AND DISPENSING SOFT ICE CREAM (U.S. CLS. 13, 21, 23, 31 AND 34).

SN 76-188,774. ROBERT W. COLLINS, PH.D., P.C., DBA SOILING SOLUTIONS, SPING LAKE, MI. FILED 1-2-2001.

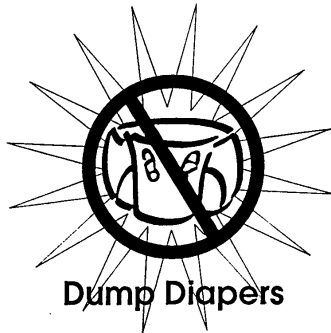

NO CLAIM IS MADE TO THE EXCLUSIVE RIGHT TO USE THE REPRESENTATION OF THE UNIVERSAL PROHIBITION SYMBOL, APART FROM THE MARK AS SHOWN.

CLASS 16—PAPER GOODS AND PRINTED MATTER

FOR TREATMENT BOOKLETS FOR THE TREATMENT OF CHILDREN WITH WETTING (ENURESIS) AND/OR SOILING (ENCOPRESIS) PROBLEMS (U.S. CLS. 2, 5, 22, 23, 29, 37, 38 AND 50).

FIRST USE 10-1-2000; IN COMMERCE 12-8-2000.

CLASS 42—SCIENTIFIC, COMPUTER AND LEGAL SERVICES

FOR PSYCHOLOGICAL COUNSELING, CONSULTATION AND HEALTHCARE TREATMENT OF CHILDREN WITH WETTING (ENURESIS) AND/OR SOILING (ENCOPRESIS) PROBLEMS (U.S. CLS. 100 AND 101).

FIRST USE 12-8-2000; IN COMMERCE 12-8-2000.

SN 76-189,964. ONCOMMAND CORPORATION, DENVER, CO. FILED 1-4-2001.

MUSIC ONCOMMAND

OWNER OF U.S. REG. NO. 2,245,482.
NO CLAIM IS MADE TO THE EXCLUSIVE RIGHT TO USE "MUSIC", APART FROM THE MARK AS SHOWN.

CLASS 9—ELECTRICAL AND SCIENTIFIC APPARATUS

FOR VIDEO DISTRIBUTION EQUIPMENT FOR PAY-PER-VIEW TELEVISION PROGRAMMING, NAMELY VIDEO SWITCHES, ELECTRONIC TELEVISION CONTROLLERS, TELEVISION SIGNAL MODULATORS, AND COMPUTER CONTROL SOFTWARE FOR OPERATING A HOTEL OR MOTEL-BASED PAY-PER-VIEW TELEVISION AND MUSIC, VIDEOGAME AND OTHER INTERACTIVE PROGRAMS VIA A DELIVERED PROGRAMMING DISTRIBUTION SYSTEM (U.S. CLS. 21, 23, 26, 36 AND 38).

CLASS 38—COMMUNICATION

FOR TRANSMITTING TELEVISION, VIDEO, MUSIC, VIDEOGAMES, AND MOVIES TO HOTELS AND MOTELS DELIVERED VIA AN INTERACTIVE CLOSED-CIRCUIT CABLE SYSTEM, SATELLITE SYSTEMS, AND THE GLOBAL COMPUTER NETWORK (U.S. CLS. 100, 101 AND 104).

CLASS 41—EDUCATION AND ENTERTAINMENT

FOR ENTERTAINMENT SERVICES, NAMELY DISTRIBUTION OF CABLE TELEVISION PROGRAMMING, PAY-PER-VIEW TELEVISION PROGRAMMING, INFORMATIONAL AND INTERACTIVE GAME VIDEO PROGRAMMING, MUSIC AND VIDEO-BASED HOTEL GUEST ENTERTAINMENT PROGRAMMING VIDEOGAME PROGRAMMING DELIVERED VIA CLOSED-CIRCUIT TELEVISION, CABLE SYSTEMS, SATELLITE, AND THE INTERNET (U.S. CLS. 100, 101 AND 107).

SN 76-190,108. ELIZA CORPORATION, BEVERLY, MA. FILED 1-5-2001.

A HEALTHY DISCUSSION

CLASS 9—ELECTRICAL AND SCIENTIFIC APPARATUS

FOR COMPUTER PROGRAMS FOR USE IN SPEECH RECOGNITION APPLICATIONS, CONVERTING SPEECH TO TEXT, CONVERTING TEXT TO SPEECH, SPEECH DIGITIZATION, AND SPEECH COMPRESSION, AND APPLICATION DESIGN INTERFACES INCLUDING SCRIPTED PROMPTS; COMPUTER TELEPHONY SOFTWARE TO ENABLE TELEPHONE ACTIVITIES TO BE PERFORMED THROUGH A COMPUTER; COMPUTER HARDWARE FOR SPEECH RECOGNITION APPLICATIONS; EQUIPMENT FOR SPEECH RECOGNITION APPLICATIONS, NAMELY, TELEPHONES INCLUDING FIXED, WIRELESS, AND MOBILE TELEPHONES, AS WELL AS INTERNET TELEPHONY, PERSONAL COMPUTERS AND COMPUTER SERVERS UTILIZING PROCESSORS, PERSONAL DIGITAL ASSISTANTS, AND OPERATING SYSTEMS (U.S. CLS. 21, 23, 26, 36 AND 38).

CLASS 42—SCIENTIFIC, COMPUTER AND LEGAL SERVICES

FOR APPLICATION SERVICE PROVIDER, NAMELY, DESIGNING, DEVELOPING, TESTING, AND HOSTING SPEECH RECOGNITION APPLICATIONS ON BEHALF OF CUSTOMERS, INCLUDING APPLICATION INTERFACE DESIGN, PHONETIC, VOCABULARY, AND GRAMMAR ADDITIONS AND IMPROVEMENTS, UPGRADES AND DEPLOYMENT TO NEW AND DIFFERENT HARDWARE PLATFORMS, TESTING AND MAINTENANCE INTEGRATION WITH TELEPHONE AND LOCAL AREA NETWORKS, WIDE AREA NETWORKS AND THE INTERNET (U.S. CLS. 100 AND 101).

SN 76-190,112. ONCOMMAND CORPORATION, DENVER, CO. FILED 1-5-2001.

CONCERTS ONCOMMAND

OWNER OF U.S. REG. NO. 2,245,482.
NO CLAIM IS MADE TO THE EXCLUSIVE RIGHT TO USE "CONCERTS", APART FROM THE MARK AS SHOWN.

CLASS 9—ELECTRICAL AND SCIENTIFIC APPARATUS

FOR VIDEO DISTRIBUTION EQUIPMENT FOR PAY-PER-VIEW TELEVISION PROGRAMMING, NAMELY VIDEO SWITCHES, ELECTRONIC TELEVISION CONTROLLERS, TELEVISION SIGNAL MODULATORS, AND COMPUTER CONTROL SOFTWARE FOR OPERATING A HOTEL OR MOTEL-BASED PAY-PER-VIEW TELEVISION AND MUSIC, VIDEOGAME AND OTHER INTERACTIVE PROGRAMS VIA A DELIVERED PROGRAMMING DISTRIBUTION SYSTEM (U.S. CLS. 21, 23, 26, 36 AND 38).

CLASS 38—COMMUNICATION

FOR TRANSMITTING TELEVISION, VIDEO, MUSIC, VIDEOGAMES, AND MOVIES TO HOTELS AND MOTELS DELIVERED VIA AN INTERACTIVE CLOSED-CIRCUIT CABLE SYSTEM, SATELLITE SYSTEMS, AND THE GLOBAL COMPUTER NETWORK (U.S. CLS. 100, 101 AND 104).

CLASS 41—EDUCATION AND ENTERTAINMENT

FOR ENTERTAINMENT SERVICES, NAMELY DISTRIBUTION OF CABLE TELEVISION PROGRAMMING, PAY-PER-VIEW TELEVISION PROGRAMMING, INFORMATIONAL AND INTERACTIVE GAME VIDEO PROGRAMMING, MUSIC AND VIDEO-BASED HOTEL GUEST ENTERTAINMENT PROGRAMMING VIDEOGAME PROGRAMMING DELIVERED VIA CLOSED-CIRCUIT TELEVISION, CABLE SYSTEMS, SATELLITE, AND THE INTERNET (U.S. CLS. 100, 101 AND 107).

SN 76-190,114. ONCOMMAND CORPORATION, DENVER, CO. FILED 1-5-2001.

SINGLES ONCOMMAND

OWNER OF U.S. REG. NO. 2,245,482.
NO CLAIM IS MADE TO THE EXCLUSIVE RIGHT TO USE "SINGLES", APART FROM THE MARK AS SHOWN.

CLASS 9—ELECTRICAL AND SCIENTIFIC APPARATUS

FOR VIDEO DISTRIBUTION EQUIPMENT FOR PAY-PER-VIEW TELEVISION PROGRAMMING, NAMELY VIDEO SWITCHES, ELECTRONIC TELEVISION CONTROLLERS, TELEVISION SIGNAL MODULATORS, AND COMPUTER CONTROL SOFTWARE FOR OPERATING A HOTEL OR MOTEL-BASED PAY-PER-VIEW TELEVISION AND MUSIC, VIDEOGAME AND OTHER INTERACTIVE PROGRAMS VIA A DELIVERED PROGRAMMING DISTRIBUTION SYSTEM (U.S. CLS. 21, 23, 26, 36 AND 38).

CLASS 38—COMMUNICATION

FOR TRANSMITTING TELEVISION, VIDEO, MUSIC, VIDEOGAMES, AND MOVIES TO HOTELS AND MOTELS DELIVERED VIA AN INTERACTIVE CLOSED-CIRCUIT CABLE SYSTEM, SATELLITE SYSTEMS, AND THE GLOBAL COMPUTER NETWORK (U.S. CLS. 100, 101 AND 104).

CLASS 41—EDUCATION AND ENTERTAINMENT

FOR ENTERTAINMENT SERVICES, NAMELY DISTRIBUTION OF CABLE TELEVISION PROGRAMMING, PAY-PER-VIEW TELEVISION PROGRAMMING, INFORMATIONAL AND INTERACTIVE GAME VIDEO PROGRAMMING, MUSIC AND VIDEO-BASED HOTEL GUEST ENTERTAINMENT PROGRAMMING VIDEOGAME PROGRAMMING DELIVERED VIA CLOSED-CIRCUIT TELEVISION, CABLE SYSTEMS, SATELLITE, AND THE INTERNET (U.S. CLS. 100, 101 AND 107).

SN 76-190,186. DEUTSCHE BANK AKTIENGESELLSCHAFT, D-60325 FRANKFURT AM MAIN, FED REP GERMANY, FILED 1-3-2001.

LEADING TO RESULTS

PRIORITY CLAIMED UNDER SEC. 44(D) ON FED REP GERMANY APPLICATION NO. 300582331/36, FILED 8-4-2000, REG. NO. 30058233, DATED 9-18-2000, EXPIRES 8-31-2010.

OWNER OF U.S. REG. NO. 2,408,252.

CLASS 35—ADVERTISING AND BUSINESS

FOR BUSINESS INVESTIGATIONS, BUSINESS MANAGEMENT CONSULTING, BUSINESS MANAGEMENT, ACCOUNTS RECEIVABLE SERVICES (U.S. CLS. 100, 101 AND 102).

CLASS 36—INSURANCE AND FINANCIAL

FOR FINANCING IN PARTICULAR LOAN FINANCING AND SECURITY SERVICES, NAMELY, GUARANTEEING LOANS, CREDIT CARD SERVICES, TRAVELERS; CHECK ISSUANCE, SECURITIES BROKERAGE, CURRENCY EXCHANGE TRANSACTIONS, INVESTMENT BROKERAGE, INVESTMENT CONSULTATION CREDIT COUNSELING, CREDIT BROKERAGE, CREDIT INQUIRY, SAFETY DEPOSIT BOX MORTGAGE BROKERAGE, LEASING OF REAL ESTATE VALUATION OF REAL PROPERTY, FINANCIAL MANAGEMENT, INSURANCE BROKERAGE (U.S. CLS. 100, 101 AND 102).

SN 76-190,287. ENERGY SAVERS UNLIMITED, INC., CARSON, CA. FILED 1-5-2001.

ESU REPTILE

NO CLAIM IS MADE TO THE EXCLUSIVE RIGHT TO USE "REPTILE", APART FROM THE MARK AS SHOWN.

CLASS 5—PHARMACEUTICALS

FOR DIETARY AND NUTRITIONAL SUPPLEMENTS FOR PET REPTILES (U.S. CLS. 6, 18, 44, 46, 51 AND 52).

CLASS 11—ENVIRONMENTAL CONTROL APPARATUS

FOR INCANDESCENT LAMPS FOR PET REPTILE CAGES; HEATERS FOR PET REPTILE CAGES; LIGHTS FOR PET REPTILE CAGES (U.S. CLS. 13, 21, 23, 31 AND 34).

CLASS 21—HOUSEWARES AND GLASS

FOR PET REPTILE CAGES, HOODS BEING PARTS OF PET REPTILE CAGES; REFLECTOR DOMES BEING PARTS OF PET REPTILE CAGES; SCREEN COVERS BEING PARTS OF PET REPTILE CAGES; ABRASIVE LINERS FOR PET REPTILE CAGES; WATER BOWLS FOR PET REPTILES (U.S. CLS. 2, 13, 23, 29, 30, 33, 40 AND 50).

CLASS 31—NATURAL AGRICULTURAL PRODUCTS

FOR PET REPTILE LITTER; PET REPTILE FOOD (U.S. CLS. 1 AND 46).

SN 76-191,005. KABUSHIKI KAISHA MORRIS, SAITAMAKEN, JAPAN, FILED 1-8-2001.

VARIVAS

OWNER OF JAPAN REG. NO. 4323802, DATED 10-8-1999, EXPIRES 10-8-2009.

OWNER OF JAPAN REG. NO. 4237203, DATED 2-5-1999, EXPIRES 2-5-2009.

OWNER OF JAPAN REG. NO. 2008951, DATED 4-28-1998, EXPIRES 4-28-2008.

CLASS 9—ELECTRICAL AND SCIENTIFIC APPARATUS

FOR SUNGLASSES, EYEGLASSES, EYEGLASS FRAMES, LIFE JACKETS, PROTECTIVE HELMETS, SIGNAL WHISTLES (U.S. CLS. 21, 23, 26, 36 AND 38).

CLASS 25—CLOTHING

FOR WET SUITS, HEAD BANDS, JACKETS, SUITS, SKIRTS, TROUSERS, OVERCOATS, TOPCOATS, MANTLES, RAINCOATS; SWEATERS, CARDIGANS, WAISTCOATS, OPEN-NECKED SHIRTS, BLOUSES, POLO SHIRTS, SHIRTS, CHEMISE, UNDERPANTS, PANTS, SWIMMING WEAR, SWIMMING CAPS; HOSE, GAITERS, SCARVES, GLOVES, NECKERCHIEFS, MUFFLERS, EAR MUFFS; HOODS, NIGHT CAPS, HATS AND CAPS; SUSPENDERS; BELTS; SHOES, BOOTS, GOLF SHOES, ANORAKS (U.S. CLS. 22 AND 39).

CLASS 28—TOYS AND SPORTING GOODS

FOR GOLF CLUBS, GOLF BALLS, CADDY BAGS, GOLF GLOVES, GOLF TEES; FISHING FLOATS, FISHING SINKERS, HAND-HELD FISHING NETS, FISHING LINES, FISHING RODS, FISHING HOOKS, FISHING BASKETS, FISHING REELS (U.S. CLS. 22, 23, 38 AND 50).

SN 76-192,094. GOLDEN BRIDGE TECHNOLOGY INC., WEST LONG BRANCH, NJ. FILED 1-10-2001.



CLASS 9—ELECTRICAL AND SCIENTIFIC APPARATUS

FOR COMPUTER HARDWARE; TELECOMMUNICATIONS COMPUTER SOFTWARE USED TO TRANSMIT INFORMATION, VOICE, AND DATA OVER TELECOMMUNICATIONS NETWORKS; TELECOMMUNICATIONS NETWORK MANAGEMENT COMPUTER SOFTWARE; COMPUTER SOFTWARE USED TO MANAGE, DIRECT, ROUTE, TRANSMIT AND RECEIVE TELEPHONE CALLS, ELECTRONIC MESSAGES, AND AUDIO AND DATA SIGNALS OVER TELECOMMUNICATIONS NETWORKS; TELECOMMUNICATIONS HARDWARE, NAMELY, TRANSMITTERS, RECEIVERS, AMPLIFIERS, SWITCHES, TELECOMMUNICATIONS EMULATORS, SIGNAL CONVERTERS, AND MULTIPLEXER DEVICES USED TO PACKETIZE VOICE SIGNALS OVER TELECOMMUNICATIONS NETWORKS; COMPUTER CHIPS; AND USER MANUALS SOLD AS A UNIT THEREWITH (U.S. CLS. 21, 23, 26, 36 AND 38).

FIRST USE 3-0-1999; IN COMMERCE 3-0-1999.

CLASS 42—SCIENTIFIC, COMPUTER AND LEGAL SERVICES

FOR TECHNICAL CONSULTING AND RESEARCH IN THE FIELD OF COMPUTER HARDWARE AND SOFTWARE, WIRELESS COMMUNICATIONS, TELECOMMUNICATIONS, COMMUNICATIONS NETWORKS, AND COMMUNICATIONS PROTOCOLS AND STANDARDS FOR OTHERS; DESIGN AND TESTING FOR NEW PRODUCT DEVELOPMENT IN THE FIELD OF TELECOMMUNICATIONS AND COMPUTER HARDWARE AND SOFTWARE FOR OTHERS; LICENSING OF INTELLECTUAL PROPERTY; PROVIDING AN ONLINE MAGAZINE IN THE FIELD OF TELECOMMUNICATIONS AND COMPUTER HARDWARE AND SOFTWARE; AND ENGINEERING SERVICES (U.S. CLS. 100 AND 101).

FIRST USE 3-0-1999; IN COMMERCE 3-0-1999.

SN 76-192,959. TRAVLO PRODUCTIONS, INC., ENCINO, CA. FILED 1-11-2001.

LADY MANHATTAN

NO CLAIM IS MADE TO THE EXCLUSIVE RIGHT TO USE "MANHATTAN", APART FROM THE MARK AS SHOWN.

CLASS 16—PAPER GOODS AND PRINTED MATTER

FOR PAPER BANNERS, POSTERS AND SIGNS (U.S. CLS. 2, 5, 22, 23, 29, 37, 38 AND 50).

CLASS 21—HOUSEWARES AND GLASS

FOR MUGS (U.S. CLS. 2, 13, 23, 29, 30, 33, 40 AND 50).

CLASS 16—PAPER GOODS AND PRINTED MATTER

FOR WRITING INSTRUMENTS, NAMELY, PENS, PENCILS, MARKERS, CRAYONS; STICKERS; STICKER BINDERS; STICKER BOOKS; NOTEBOOKS; NOTEBOOKS AND NECKLACE COMBINATIONS SOLD TOGETHER AS A UNIT; DRAWING AND DRAFTING RULERS; WIRE BOUND THEME BOOKS; PENCIL SHARPENERS; PAPER POUCHES FOR PACKAGING; STATIONERY SETS; ERASERS; ADDRESS BOOKS, JOURNALS; TEMPORARY TATTOOS; DAILY JOURNAL PLANNERS; CHILDREN'S BOOKS; PAMPHLETS, BROCHURES, AND NEWSLETTERS FOR CHILDREN ABOUT GIRL CARTOON CHARACTERS; PAPER PARTY BAGS, PAPER PARTY DECORATIONS, AND PAPER PARTY HATS (U.S. CLS. 2, 5, 22, 23, 29, 37, 38 AND 50).

CLASS 18—LEATHER GOODS

FOR TRUNK AND TRAVELING BAGS, UMBRELLAS, PARASOLS, LEATHER BACKPACKS AND LEATHER SHOPPING BAGS, ALL PURPOSE SPORTS BAGS, RUCKSACKS, WALKING STICKS, HOLDALLS, COSMETIC BAGS AND CASES SOLD EMPTY (U.S. CLS. 1, 2, 3, 22 AND 41).

CLASS 20—FURNITURE AND ARTICLES NOT OTHERWISE CLASSIFIED

FOR NON-METAL KEY-CHAINS (U.S. CLS. 2, 13, 22, 25, 32 AND 50).

SN 76-193,165. E.K. SUCCESS, LTD., CLIFTON, NJ. FILED 1-12-2001.

BCHGRL65

CLASS 3—COSMETICS AND CLEANING PREPARATIONS

FOR COSMETICS, NAMELY, CLEANSING PREPARATIONS, NAMELY, SKIN CLEANSERS; PERSONAL DEODORANTS; NAIL POLISH; LIPSTICK; LIP LINER; EYE SHADOW; EYE PENCIL; EYE LINER; EYEBROW PENCILS; FACE POWDER; BLUSH; PERFUME; BUBBLE BATH; SKIN AND HAIR CONDITIONERS; SKIN MOISTURIZER; SHOWER GEL; LIQUID SOAP; BODY SPRITZER; AND TALCUM POWDER (U.S. CLS. 1, 4, 6, 50, 51 AND 52).

CLASS 8—HAND TOOLS

FOR CUTLERY, NAMELY, FLATWARE (U.S. CLS. 23, 28 AND 44).

CLASS 9—ELECTRICAL AND SCIENTIFIC APPARATUS

FOR SUNGLASSES, VIDEOTAPES, CD-ROMS, AUDIO-TAPES, PRERECORDED TAPES, AND COMPACT DISCS FEATURING ANIMATED GIRL CHARACTERS; PHOTOGRAPHIC CAMERAS AND EXPOSED CAMERA FILM; BLANK MAGNETIC DATA CARRIERS; PHOTOGRAPHIC PROJECTORS; BLANK ELECTRONIC CHIP CARDS; VIDEO GAME CARTRIDGES AND VIDEO GAMES DISCS, COMPUTER GAME PROGRAMS AND COMPUTER GAME SOFTWARE AND COMPUTER GAME TAPES; DECORATIVE REFRIGERATOR MAGNETS, AND COVERS FOR WIRELESS PHONES (U.S. CLS. 21, 23, 26, 36 AND 38).

CLASS 11—ENVIRONMENTAL CONTROL APPARATUS

FOR LAMPS AND LAMP SHADES (U.S. CLS. 13, 21, 23, 31 AND 34).

CLASS 14—JEWELRY

FOR JEWELRY, CLOCKS, WATCHES, WRIST WATCHES, CUFF LINKS, TIE PINS (U.S. CLS. 2, 27, 28 AND 50).

CLASS 21—HOUSEWARES AND GLASS

FOR CONTAINERS FOR HOUSEHOLD OR KITCHEN USE, PLATES, DRINKING GLASSES, CUPS, MUGS, ORNAMENTS MADE OF CERAMIC, HAIR BRUSHES AND COMBS, NAIL BRUSHES, AND HOUSEHOLD UTENSILS, NAMELY, POT AND PAN SCRAPERS, ROLLING PINS, SPATULAS, TURNERS, AND WHISKS (U.S. CLS. 2, 13, 23, 29, 30, 33, 40 AND 50).

CLASS 24—FABRICS

FOR TABLECLOTHS, BED SHEETS, TEXTILE NAPKINS AND PLACE MATS (U.S. CLS. 42 AND 50).

CLASS 25—CLOTHING

FOR CLOTHING, NAMELY, T-SHIRTS, DRESSES, HATS, SWIMWEAR, FOOTWEAR, SOCKS, TIES AND SLIPPERS (U.S. CLS. 22 AND 39).

CLASS 26—FANCY GOODS

FOR HAIR BANDS, CLOTHING BUCKLES, HAIR BUCKLES, AND SHOE BUCKLES, BELT AND CLOTHING CLAPS (U.S. CLS. 37, 39, 40, 42 AND 50).

CLASS 28—TOYS AND SPORTING GOODS

FOR TOYS, NAMELY, DOLLS, BOARD GAMES, PLUSH TOYS, MOBILES, GYMNASTIC APPARATUS, SPORTING ARTICLES, NAMELY, BASEBALLS, SOFTBALLS, BASKETBALLS, CHRISTMAS TREE DECORATIONS, JIGSAW PUZZLES, TEDDY BEARS, BALLOONS, BODYBUILDING APPARATUS, NAMELY, EXERCISE BARS, AND EXERCISE BENCHES, GLOVES FOR GAMES, NAMELY, BASEBALL, SOFTBALL, AND GOLF GLOVES, HANDHELD UNIT FOR PLAYING ELECTRONIC GAMES, CARD GAMES, BAGS ADAPTED FOR HOLDING SPORTS EQUIPMENT, NAMELY, BASEBALL, SOFTBALL, AND GOLF (U.S. CLS. 22, 23, 38 AND 50).

CLASS 30—STAPLE FOODS

FOR FROZEN CONFECTIONS AND FLAVORED ICES, CHOCOLATE, COFFEE, TEA, COCOA, CEREAL BASED SNACK FOOD, READY TO EAT CEREAL DERIVED FOOD BARS, BREAD, CHOCOLATE EGGS, CONFECTIONERY SUGAR (U.S. CL. 46).

CLASS 41—EDUCATION AND ENTERTAINMENT

FOR PRODUCTION OF RADIO AND TELEVISION PROGRAMS, PRODUCTION OF VIDEOTAPE, PUBLICATION OF BOOKS, TEXT AND PRINTED MATTER, NAMELY, ANIMATED CHARACTERS, THEATER PRODUCTIONS, MOTION PICTURE FILM PRODUCTION, ORGANIZATION OF EXHIBITIONS FOR ENTERTAINMENT PURPOSES, ARRANGING AND CONDUCTING OF SPORTS COMPETITIONS, LIVE PERFORMANCES BY A MUSICAL BAND; ENTERTAINMENT, NAMELY, A CONTINUING CARTOON SHOW DISTRIBUTED OVER TELEVISION (U.S. CLS. 100, 101 AND 107).

SN 76-194,311. XIWAVE PLC, BATH, BA3 6SS, UNITED KINGDOM, FILED 1-16-2001.

XIWAVE

PRIORITY CLAIMED UNDER SEC. 44(D) ON ERPN CMNTY TM OFC APPLICATION NO. 1762285, FILED 7-18-2000, REG. NO. 1762285, DATED 7-18-2001, EXPIRES 7-18-2010.

CLASS 9—ELECTRICAL AND SCIENTIFIC APPARATUS

FOR COMPUTER SOFTWARE FOR USE IN VIDEO COMPRESSION, DATA COMPRESSION, MEDIA COMPRESSION, DATA EDITING AND MEDIA EDITING, INCLUDING SUCH SOFTWARE INSTALLED IN ELECTRONIC APPARATUS AND INSTRUMENTS, NAMELY SET-TOP BOXES, VIDEO COMPRESSION SILICON, MOBILE PHONES, AND PERSONAL DIGITAL ASSISTANTS; ENCODERS (U.S. CLS. 21, 23, 26, 36 AND 38).

CLASS 40—MATERIAL TREATMENT

FOR DIGITAL VIDEO AND DATA COMPRESSION SERVICES (U.S. CLS. 100, 103 AND 106).

CLASS 41—EDUCATION AND ENTERTAINMENT

FOR VIDEO PRODUCTION SERVICES; VIDEO EDITING SERVICES (U.S. CLS. 100, 101 AND 107).

SN 76-194,515. MOONROCK PAPER COMPANY, LLC, THE, BURLINGTON, MA. FILED 1-16-2001.

THE MOONROCK PAPER COMPANY

NO CLAIM IS MADE TO THE EXCLUSIVE RIGHT TO USE "PAPER COMPANY", APART FROM THE MARK AS SHOWN.

CLASS 11—ENVIRONMENTAL CONTROL APPARATUS

FOR HAND MADE PAPER LAMPS AND LAMP SHADES (U.S. CLS. 13, 21, 23, 31 AND 34).

CLASS 16—PAPER GOODS AND PRINTED MATTER

FOR HAND MADE WRITING PAPER; HAND MADE PAPER FOR PACKAGING AND WRAPPING; HAND MADE STATIONERY; HAND MADE PAPER GIFT BAGS; HAND MADE PAPER GIFT BOXES; HAND MADE PEN BOXES; HAND MADE PHOTO ALBUMS; HAND MADE GIFT WRAPPING PAPERS; HAND MADE PAPER BAGS FOR WINE; HAND DRAWN ART APPLIED TO HAND MADE PAPER; HAND MADE PAPER BOWS AND RIBBONS FOR GIFT WRAPPING; HAND MADE TISSUE PAPER; HAND MADE RAW PAPER FOR PRINTING PURPOSES; HAND MADE NOTEBOOKS; HAND MADE PHONE BOOKS; HAND MADE WEDDING BOOKS; HAND MADE INVITATIONS FOR WEDDINGS; ANNOUNCEMENT CARDS; CARDS FOR SPECIAL OCCASIONS; HAND MADE CARDS FOR SPECIAL OCCASIONS; HAND MADE PAPER GIFT BOXES; HAND MADE CARRYING CASES MADE OF PAPER; HAND MADE CARRYING CASES MADE OF PAPER FOR EYEGLASSES; HAND MADE CARRYING CASES MADE OF PAPER FOR COSMETICS; HAND MADE CARRYING CASES MADE OF PAPER FOR COMPACT DISCS (U.S. CLS. 2, 5, 22, 23, 29, 37, 38 AND 50).

CLASS 20—FURNITURE AND ARTICLES NOT OTHERWISE CLASSIFIED

FOR HAND MADE PICTURE FRAMES; HAND MADE PAPER PICTURE FRAMES; HAND MADE PAPER PHOTO FRAMES; HAND MADE JEWELRY BOXES NOT OF METAL (U.S. CLS. 2, 13, 22, 25, 32 AND 50).

SN 76-194,527. UNIVERSITY OF SOUTHERN MISSISSIPPI, THE, HATTIESBURG, MS. FILED 1-17-2001.

**CLASS 16—PAPER GOODS AND PRINTED MATTER**

FOR BUMPER STICKERS, WINDOW DECALS, PEN SETS, PENCILS, PAPER BANNERS, BANK CHECKS, GREETING CARDS, POSTCARDS, GRADUATION ANNOUNCEMENTS, PRINTED PAPER SIGNS (U.S. CLS. 2, 5, 22, 23, 29, 37, 38 AND 50).

FIRST USE 6-20-1988; IN COMMERCE 6-20-1988.

CLASS 20—FURNITURE AND ARTICLES NOT OTHERWISE CLASSIFIED

FOR PILLOWS, DIPLOMA FRAMES, PICTURE FRAMES, NON-METAL KEY CHAINS, STADIUM SEATS, PLASTIC YARD SIGNS, PLASTIC NOVELTY CAR LICENSE PLATES, PLASTIC CAR FLAGS, PLASTIC BANNER, NON-METAL MONEY CLIPS (U.S. CLS. 2, 13, 22, 25, 32 AND 50).

FIRST USE 6-20-1988; IN COMMERCE 6-20-1988.

CLASS 21—HOUSEWARES AND GLASS

FOR PORTABLE BEVERAGE COOLERS, INSULATING SLEEVE HOLDERS FOR BEVERAGE CANS, BEVERAGE GLASSWARE, MUGS (U.S. CLS. 2, 13, 23, 29, 30, 33, 40 AND 50).

FIRST USE 6-20-1988; IN COMMERCE 6-20-1988.

CLASS 25—CLOTHING

FOR T-SHIRTS, POLO SHIRTS, SWEATERS, JERSEYS, WINDSUITS, WARM-UPS, JACKETS, PONCHOS, OVERCOATS, RAINWEAR, SLEEPWARE, LINGERIE, NECKWEAR, INFANT BOOTIES, INFANT ROMPERS, INFANT SLEEPERS, BASEBALL CAPS, HEADWARE AND SOCKS (U.S. CLS. 22 AND 39).

FIRST USE 6-20-1988; IN COMMERCE 6-20-1988.

SN 76-194,530. UNIVERSITY OF SOUTHERN MISSISSIPPI, THE, HATTIESBURG, MS. FILED 1-17-2001.

THE UNIVERSITY OF SOUTHERN MISSISSIPPI

CLASS 16—PAPER GOODS AND PRINTED MATTER

FOR BUMPER STICKERS, WINDOW DECALS, PEN SETS, PENCILS, PAPER BANNERS, BANK CHECKS, GREETING CARDS, POSTCARDS, GRADUATION ANNOUNCEMENTS, PRINTED PAPER SIGNS (U.S. CLS. 2, 5, 22, 23, 29, 37, 38 AND 50).

FIRST USE 6-20-1988; IN COMMERCE 6-20-1988.

CLASS 20—FURNITURE AND ARTICLES NOT OTHERWISE CLASSIFIED

FOR FRAMES FOR DIPLOMAS, PICTURE FRAMES, NON-METAL KEY CHAINS, STADIUM SEATS, NON-METAL YARD SIGNS, PLASTIC NOVELTY CAR LICENSE PLATES, PLASTIC FLAGS FOR CARS, PLASTIC BANNERS, NON-METAL MONEY CLIPS (U.S. CLS. 2, 13, 22, 25, 32 AND 50).

FIRST USE 6-20-1988; IN COMMERCE 6-20-1988.

CLASS 21—HOUSEWARES AND GLASS

FOR PORTABLE BEVERAGE COOLERS, INSULATING SLEEVEHOLDERS FOR BEVERAGE CANS, BEVERAGE GLASSWARE, MUGS (U.S. CLS. 2, 13, 23, 29, 30, 33, 40 AND 50).

FIRST USE 6-20-1988; IN COMMERCE 6-20-1988.

CLASS 25—CLOTHING

FOR T-SHIRTS, POLO SHIRTS, SWEATERS, JERSEYS, WINDSUITS, WARM-UPS SUITS, JACKETS, PONCHOS, OVERCOATS, RAINWEAR, SLEEPWARE, LINGERIE, NECKWEAR, INFANT BOOTIES, INFANT ROMPERS, INFANT SLEEPERS, BASEBALL CAPS, HEADWEAR AND SOCKS (U.S. CLS. 22 AND 39).

FIRST USE 6-20-1988; IN COMMERCE 6-20-1988.

SN 76-194,835. INTERWAVE COMMUNICATIONS, INC., MENLO PARK, CA. FILED 1-17-2001.

BUSINESS MOBILITY

NO CLAIM IS MADE TO THE EXCLUSIVE RIGHT TO USE "BUSINESS", APART FROM THE MARK AS SHOWN.

CLASS 9—ELECTRICAL AND SCIENTIFIC APPARATUS

FOR COMPUTER HARDWARE AND SOFTWARE USED FOR WIRELESS COMMUNICATIONS APPLICATIONS (U.S. CLS. 21, 23, 26, 36 AND 38).

CLASS 35—ADVERTISING AND BUSINESS

FOR BUSINESS CONSULTING SERVICES IN THE FIELD OF WIRELESS COMMUNICATIONS (U.S. CLS. 100, 101 AND 102).

SN 76-194,960. STARBAND COMMUNICATIONS INC., MCLEAN, VA. FILED 1-16-2001.

STARBAND CAROUSEL

NO CLAIM IS MADE TO THE EXCLUSIVE RIGHT TO USE "CAROUSEL", APART FROM THE MARK AS SHOWN.

CLASS 35—ADVERTISING AND BUSINESS

FOR PROVIDING HOME SHOPPING SERVICES COVERING A WIDE VARIETY OF CONSUMER PRODUCTS BY TELEVISION, THE INTERNET, AND SATELLITE (U.S. CLS. 100, 101 AND 102).

CLASS 38—COMMUNICATION

FOR PROVIDING MULTIPLE-USER ACCESS TO THE INTERNET; BROADCASTING PROGRAMS VIA THE INTERNET AND THROUGH SATELLITE COMMUNICATIONS NETWORKS; CABLE TELEVISION BROADCASTING; TELEVISION BROADCASTING; PROVIDING SATELLITE COMMUNICATION AND TRANSMISSION SERVICES FOR THE TRANSFER AND DISSEMINATION OF SOFTWARE APPLICATIONS AND OTHER DATA FILES AND FOR ACCESS TO VARIOUS MULTIMEDIA SERVICES, NEWS, BANKING AND FINANCIAL SERVICES, AND FOR VIDEO-ON-DEMAND TRANSMISSION SERVICES FEATURING MOVIES, SPORTS AND CULTURAL EVENTS (U.S. CLS. 100, 101 AND 104).

CLASS 41—EDUCATION AND ENTERTAINMENT

FOR TELEVISION PROGRAMMING; CABLE TELEVISION PROGRAMMING; SCHEDULING PROGRAMS BROADCAST VIA THE INTERNET AND THROUGH SATELLITE COMMUNICATIONS NETWORKS; ENTERTAINMENT AND EDUCATION SERVICES, NAMELY, PROVIDING A WEBSITE FEATURING MUSICAL ENTERTAINMENT, GAMES AND NEWS; ARRANGING FOR TICKET RESERVATIONS FOR SHOWS AND OTHER ENTERTAINMENT EVENTS VIA THE INTERNET AND OTHER DATA COMMUNICATIONS NETWORKS (U.S. CLS. 100, 101 AND 107).

SN 76-195,530. HUNTLEIGH TECHNOLOGY PLC, BEDFORDSHIRE, LU1 1TD, ENGLAND, FILED 1-18-2001.



OWNER OF UNITED KINGDOM REG. NO. 2199919, DATED 6-11-1999, EXPIRES 6-11-2009.

CLASS 41—EDUCATION AND ENTERTAINMENT

FOR EDUCATION AND TRAINING FOR HEALTH CARE PROFESSIONALS IN PRESSURE AREA CARE AND PRESSURE CARE MANAGEMENT, NAMELY, CONDUCTING HEALTHCARE WORKSHOPS AND SEMINARS PROVIDING INFORMATION AND TRAINING TO HEALTH PROFESSIONALS AND INDIVIDUALS; PUBLICATION OF EDUCATIONAL MATERIAL IN THE FIELD OF HEALTH CARE AND CLINICAL SUPPORT, NAMELY, MANUALS AND GUIDES IN THE FIELD OF PRESSURE ULCERS AND THEIR PREVENTION AND TREATMENT (U.S. CLS. 100, 101 AND 107).

CLASS 42—SCIENTIFIC, COMPUTER AND LEGAL SERVICES

FOR CLINICAL SUPPORT SERVICES, NAMELY, HEALTH CARE PROFESSIONAL SERVICES; CLINICAL PRODUCT EVALUATION AND ASSESSMENT OF PRESSURE AREA MANAGEMENT HEALTH CARE EQUIPMENT FOR OTHERS, CONDUCTING CLINICAL RESEARCH AND TRAILS FOR OTHERS IN THE FIELD OF PRESSURE AREA MANAGEMENT HEALTH CARE EQUIPMENT (U.S. CLS. 100 AND 101).

SN 76-195,606. LURGI ENERGIE UND ENTSORGUNG GMBH, 40880 RATINGEN, FED REP GERMANY, FILED 1-16-2001.

CIRCOCLEAN

PRIORITY CLAIMED UNDER SEC. 44(D) ON FED REP GERMANY APPLICATION NO. 300522010/37, FILED 7-13-2000, REG. NO. 30052201, DATED 9-11-2000, EXPIRES 7-31-2010.

CLASS 37—CONSTRUCTION AND REPAIR

FOR BUILDING CONSTRUCTION AND REPAIR; INSTALLATION OF APPLIANCES FOR THE PURIFICATION OF FUMES; AND CONSTRUCTION PLANNING (U.S. CLS. 100, 103 AND 106).

CLASS 40—MATERIAL TREATMENT

FOR AIR PURIFICATION, NAMELY, PURIFICATION OF FUMES IN INCINERATING PLANTS FOR REGULAR AND HAZARDOUS WASTE AND PLANTS FOR THE DISPOSAL OF SLUDGE, AS WELL AS IN POWER PLANTS, CONCRETE FACTORIES, GLASS FACTORIES AND OTHER INDUSTRIAL PRODUCTION PLANTS (U.S. CLS. 100, 103 AND 106).

CLASS 42—SCIENTIFIC, COMPUTER AND LEGAL SERVICES

FOR ENGINEERING SERVICES; AND TECHNICAL CONSULTATION IN THE FIELD OF PLANTS FOR THE PURIFICATION OF FUMES FROM HARMFUL SUBSTANCES, ACIDIC COMPONENTS, AND DUST, AS WELL AS HEAVY METALS IN ORGANIC SUBSTANCES (U.S. CLS. 100 AND 101).

SN 76-195,789. PIANOVA MUSIKINSTRUMENTE GMBH, D-4330 MÜLHEIM, FED REP GERMANY, FILED 1-18-2001.



CLASS 15—MUSICAL INSTRUMENTS

FOR MUSICAL INSTRUMENTS, NAMELY, MANUALLY OPERATED PIANOS (U.S. CLS. 2, 21 AND 36).

CLASS 37—CONSTRUCTION AND REPAIR

FOR MAINTENANCE AND RESTORATION OF MANUALLY OPERATED PIANOS (U.S. CLS. 100, 103 AND 106).

SN 76-196,608. WESTMINSTER COLLEGE, SALT LAKE CITY, UT. FILED 1-19-2001.



CLASS 16—PAPER GOODS AND PRINTED MATTER

FOR PRINTED MATTER, NAMELY, POSTERS, STICKERS, DECALS, PROGRAMS FOR COLLEGIATE ATHLETIC COMPETITIONS AND CULTURAL ACTIVITIES, POSTCARDS, STATIONERY, AND SCHOOL SUPPLIES, NAMELY, FOLDERS, NOTEBOOKS AND BINDERS (U.S. CLS. 2, 5, 22, 23, 29, 37, 38 AND 50).

FIRST USE 5-30-1999; IN COMMERCE 5-30-1999.

CLASS 25—CLOTHING

FOR WEARING APPAREL NAMELY, T-SHIRTS, SHIRTS, SHORTS, PANTS, JACKETS, SWEATSHIRTS, HATS, CAPS, SWEATERS AND FOOTWEAR (U.S. CLS. 22 AND 39).

FIRST USE 5-30-1999; IN COMMERCE 5-30-1999.

CLASS 41—EDUCATION AND ENTERTAINMENT

FOR EDUCATIONAL AND ENTERTAINMENT SERVICES NAMELY, CONDUCTING EDUCATIONAL ACTIVITIES SUCH AS COURSES, SEMINARS, TRAINING PROGRAMS AND CONFERENCES AT THE POST-SECONDARY, UNDERGRADUATE AND GRADUATE LEVEL AND CONDUCTING AND SPONSORING COLLEGIATE ATHLETIC COMPETITIONS AND CULTURAL ACTIVITIES (U.S. CLS. 100, 101 AND 107).

FIRST USE 5-30-1999; IN COMMERCE 5-30-1999.

SN 76-196.609. WESTMINSTER COLLEGE, SALT LAKE CITY, UT. FILED 1-19-2001.

WESTMINSTER GRIFFINS**CLASS 16—PAPER GOODS AND PRINTED MATTER**

FOR PRINTED MATTER, NAMELY, POSTERS, STICKERS, DECALS, PROGRAMS FOR COLLEGIATE ATHLETIC COMPETITIONS AND CULTURAL ACTIVITIES, POSTCARDS, STATIONERY, AND SCHOOL SUPPLIES, NAMELY, FOLDERS, NOTEBOOKS AND BINDERS (U.S. CLS. 2, 5, 22, 23, 29, 37, 38 AND 50).

FIRST USE 5-30-1999; IN COMMERCE 5-30-1999.

CLASS 25—CLOTHING

FOR WEARING APPAREL NAMELY, T-SHIRTS, SHIRTS, SHORTS, PANTS, JACKETS, SWEATSHIRTS, HATS, CAPS, SWEATERS AND FOOTWEAR (U.S. CLS. 22 AND 39).

FIRST USE 5-30-1999; IN COMMERCE 5-30-1999.

CLASS 41—EDUCATION AND ENTERTAINMENT

FOR EDUCATIONAL AND ENTERTAINMENT SERVICES NAMELY, CONDUCTING EDUCATIONAL ACTIVITIES SUCH AS COURSES, SEMINARS, TRAINING PROGRAMS AND CONFERENCES AT THE POST-SECONDARY, UNDERGRADUATE AND GRADUATE LEVEL AND CONDUCTING AND SPONSORING COLLEGIATE ATHLETIC COMPETITIONS AND CULTURAL ACTIVITIES (U.S. CLS. 100, 101 AND 107).

FIRST USE 5-30-1999; IN COMMERCE 5-30-1999.

SN 76-196.696. ING. LORO PIANA & C. S.P.A., CORSO ROLANDI N. 10, ITALY, FILED 1-19-2001.

LIGHTFRAME

PRIORITY CLAIMED UNDER SEC. 44(D) ON ITALY APPLICATION NO. 003601, FILED 11-9-2000, REG. NO. 00839900, DATED 3-12-2001, EXPIRES 3-12-2011.

CLASS 23—YARNS AND THREADS

FOR YARNS AND THREADS (U.S. CL. 43).

CLASS 24—FABRICS

FOR FABRICS, NAMELY WOVEN FABRICS MADE OF WOOL, WORSTED FABRIC, BLENDS OF WOOL AND COTTON FABRIC, SILK AND WOOL BLEND FABRICS, COTTON KNIT FABRICS AND WOOL KNIT FABRICS (U.S. CLS. 42 AND 50).

CLASS 25—CLOTHING

FOR CLOTHING FOR MEN, WOMEN AND CHILDREN, NAMELY JACKETS, COATS, SKIRTS, TROUSERS, CLOAKS, MANTLES, OVERCOATS, KNITTED VESTS, SCARVES, MUFFLERS, SHAWLS, AND GLOVES; HEAD WEAR (U.S. CLS. 22 AND 39).

SN 76-197.065. GABRIEL PROPERTIES, INC., CHESTERFIELD, MO. FILED 1-19-2001.

NUVOX COMMUNICATIONS

NO CLAIM IS MADE TO THE EXCLUSIVE RIGHT TO USE "COMMUNICATIONS", APART FROM THE MARK AS SHOWN.

CLASS 38—COMMUNICATION

FOR COMPUTER SERVICES, NAMELY, PROVIDING MULTIPLE-USER ACCESS TO A GLOBAL COMPUTER NETWORK (U.S. CLS. 100, 101 AND 104).

CLASS 42—SCIENTIFIC, COMPUTER AND LEGAL SERVICES

FOR COMPUTER SERVICES, NAMELY, DESIGNING WEB-SITES FOR OTHERS AND HOSTING WEB-SITES OF OTHERS ON A COMPUTER SERVER FOR A GLOBAL COMPUTER NETWORK (U.S. CLS. 100 AND 101).

SN 76-197.631. SAFEWAY INC., PLEASANTON, CA. FILED 1-22-2001.

GIVING OUR BEST**CLASS 35—ADVERTISING AND BUSINESS**

FOR RETAIL GROCERY SERVICES; RETAIL PHARMACY SERVICES (U.S. CLS. 100, 101 AND 102).

CLASS 36—INSURANCE AND FINANCIAL

FOR FULL SERVICE BANKING; FINANCIAL SERVICES, NAMELY, PROVIDING AUTOMATED BANKING, FINANCIAL PLANNING AND TRANSACTION SERVICES, PROVIDING MORTGAGE LOAN AND INVESTMENT ADVISORY SERVICES, LINE OF CREDIT, ON-LINE BANKING SERVICES, AUTOMATED TELLER MACHINE SERVICES, AND ELECTRONIC FINANCIAL TRANSACTION CARD SERVICES (U.S. CLS. 100, 101 AND 102).

CLASS 40—MATERIAL TREATMENT

FOR PHOTOGRAPHIC FILM DEVELOPING, PROCESSING, AND PHOTO FINISHING SERVICES (U.S. CLS. 100, 103 AND 106).

CLASS 41—EDUCATION AND ENTERTAINMENT

FOR RENTAL OF VIDEO TAPES (U.S. CLS. 100, 101 AND 107).

SN 76-197,778. ORRICK INTERNATIONAL TRADING GROUP, INC., LOS ANGELES, CA. FILED 1-22-2001.



Orrick Valentine

NO CLAIM IS MADE TO THE EXCLUSIVE RIGHT TO USE "VALENTINE", APART FROM THE MARK AS SHOWN.

THE MARK CONSISTS OF A STYLIZED DESIGN OF THE LETTER "V" BEING PLACES ON THE TOP AND CENTER OVER THE WORDINGS "ORRICK VALENTINE", WHEREIN A WORDING "ORRICK" IS DISPOSED WITHIN THE FIRST SLANTED PORTION OF THE STYLIZED DESIGN OF THE LETTER "V".

CLASS 18—LEATHER GOODS

FOR VALENTINE'S DAY GIFT ITEMS, NAMELY LEATHER AND IMITATIONS OF LEATHER SOLD IN BULK; LEATHER OR IMITATION LEATHER ITEMS, NAMELY ATTACHE', CASES, DIAPER BAGS, BAGS FOR MOUNTAIN-CLIMBING, SATCHELS, NAME-CARD CASES, RUCKSACKS, WALLETS, BEACH BAGS, BRIEFCASES, SUITCASES, TICKET CASES, CREDIT CARD CASES, TRAVELING BAGS, TRAVELING TRUNKS, SCHOOL BAGS, HANDBAGS AND COSMETIC CASES SOLD EMPTY (U.S. CLS. 1, 2, 3, 22 AND 41).

CLASS 25—CLOTHING

FOR VALENTINE'S DAY GIFT ITEMS, NAMELY LEATHER BELTS AND WAIST BELTS MADE OF LEATHER OR IMITATION LEATHER (U.S. CLS. 22 AND 39).

SN 76-198,733. CARFIT INDUSTRIES, INC., AVENTURA, FL. FILED 1-22-2001.

**CLASS 12—VEHICLES**

FOR VEHICLE ACCESSORIES, NAMELY SEAT COVERS, WHEEL COVERS FOR VEHICLES, REAR VIEW MIRRORS (U.S. CLS. 19, 21, 23, 31, 35 AND 44). FIRST USE 10-1-2000; IN COMMERCE 10-1-2000.

CLASS 27—FLOOR COVERINGS

FOR VEHICLE ACCESSORIES, NAMELY FLOOR MATS FOR VEHICLES, CARPETS, RUGS, MATS AND MATTING (U.S. CLS. 19, 20, 37, 42 AND 50). FIRST USE 10-1-2000; IN COMMERCE 10-1-2000.

SN 76-199,963. DUKE REALTY LIMITED PARTNERSHIP, INDIANAPOLIS, IN. BY CHANGE OF NAME DUKE-WEEKS REALTY LIMITED PARTNERSHIP, INDIANAPOLIS, IN. FILED 1-25-2001.

DUKEREALTY.COM

OWNER OF U.S. REG. NOS. 2,336,268, 2,366,246 AND 2,366,324.

CLASS 36—INSURANCE AND FINANCIAL

FOR ACQUIRING, MANAGING, AND LEASING NON-RESIDENTIAL REAL ESTATE; PROVIDING ONLINE INFORMATION CONCERNING ACQUIRING, MANAGING, AND LEASING NON-RESIDENTIAL REAL ESTATE (U.S. CLS. 100, 101 AND 102).

CLASS 37—CONSTRUCTION AND REPAIR

FOR DEVELOPING NON-RESIDENTIAL REAL ESTATE; PROVIDING ONLINE INFORMATION CONCERNING DEVELOPING NON-RESIDENTIAL REAL ESTATE (U.S. CLS. 100, 103 AND 106).

SN 76-201,307. GIBSON GUITAR CORP., NASHVILLE, TN. FILED 1-29-2001.



OWNER OF U.S. REG. NOS. 510,594, 2,177,027 AND OTHERS.

CLASS 9—ELECTRICAL AND SCIENTIFIC APPARATUS

FOR ELECTRONIC SOUND EFFECTS PEDALS AND AMPLIFIERS FOR MUSICAL INSTRUMENTS (U.S. CLS. 21, 23, 26, 36 AND 38).

CLASS 15—MUSICAL INSTRUMENTS

FOR MUSICAL INSTRUMENTS, NAMELY GUITARS, BASSES, MANDOLINS, BANJOS, DRUMS, KEYBOARDS, AND PIANOS; AND PARTS AND ACCESSORIES FOR MUSICAL INSTRUMENTS, NAMELY, GUITAR STRINGS, STRAPS, PICKS, PICKUPS, MUSIC SYNTHESIZERS AND CASES (U.S. CLS. 2, 21 AND 36).

SN 76-202,327. KAMMER-FOX, URSULA M., SANTA MONICA, CA. AND FOX, CHARLES A., SANTA MONICA, CA. FILED 1-31-2001.

OOKS

CLASS 16—PAPER GOODS AND PRINTED MATTER

FOR PRINTED MATTER, NAMELY, BOOKS AND MAGAZINES FOR CHILDREN, POSTCARDS AND POSTERS (U.S. CLS. 2, 5, 22, 23, 29, 37, 38 AND 50).

CLASS 41—EDUCATION AND ENTERTAINMENT

FOR ENTERTAINMENT SERVICES, NAMELY, PRODUCING MOTION PICTURE FILMS AND TELEVISION SHOWS FOR CHILDREN (U.S. CLS. 100, 101 AND 107).

SN 76-202,381. MERIDIUS CORPORATION, TORONTO, ONTARIO, CANADA, FILED 1-29-2001.

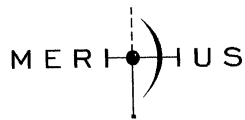

PRIORITY CLAIMED UNDER SEC. 44(D) ON CANADA APPLICATION NO. 1079666, FILED 10-23-2000.

CLASS 35—ADVERTISING AND BUSINESS

FOR BUSINESS DEVELOPMENT SERVICES, NAMELY CONSULTING SERVICES RELATED TO BUSINESS STRATEGY (U.S. CLS. 100, 101 AND 102).
FIRST USE 6-1-1997; IN COMMERCE 6-1-1997.

CLASS 36—INSURANCE AND FINANCIAL

FOR FINANCING SERVICES; VENTURE CAPITAL FUNDING AND INVESTING; AND ADVISING OTHERS ON FINANCE AND VENTURE CAPITAL FUNDING AND INVESTING (U.S. CLS. 100, 101 AND 102).
FIRST USE 6-1-1997; IN COMMERCE 6-1-1997.

SN 76-203,647. GOULD, KENNETH DAVID, NORTH BERGEN, NJ. FILED 2-1-2001.

KENHAPPEN

CLASS 35—ADVERTISING AND BUSINESS

FOR PROVIDING ONLINE INFORMATION IN THE FORM OF LINKS TO ONLINE SHOPPING SITES OF OTHERS (U.S. CLS. 100, 101 AND 102).

CLASS 42—SCIENTIFIC, COMPUTER AND LEGAL SERVICES

FOR WEB PAGE DESIGN SERVICES FOR OTHERS; PROVIDING ONLINE INFORMATION IN THE FORM OF LINKS TO NEWS MAGAZINES (U.S. CLS. 100 AND 101).

SN 76-203,716. UNIPLEX CORPORATION, PEWAUKEE, WI. FILED 1-31-2001.

UNIPLEX

CLASS 40—MATERIAL TREATMENT

FOR CUSTOM MANUFACTURE, ASSEMBLY AND PROTOTYPE FABRICATION OF A WIDE RANGE OF PRODUCTS BASED ON THE CUSTOMER'S NEEDS (U.S. CLS. 100, 103 AND 106).
FIRST USE 0-0-1973; IN COMMERCE 0-0-1973.

CLASS 42—SCIENTIFIC, COMPUTER AND LEGAL SERVICES

FOR ENGINEERING, CONSULTING IN THE FIELDS OF PRODUCT ENGINEERING, NEW PRODUCT DEVELOPMENT, MANUFACTURING AND ASSEMBLY, INCLUDING DESIGN AND OPERATION OF PROCESS LINES (U.S. CLS. 100 AND 101).
FIRST USE 0-0-1973; IN COMMERCE 0-0-1973.

SN 76-203,733. SLIMELIGHT LIMITED, LONDON EC1V 1NO, ENGLAND, FILED 2-1-2001.

SLIMELIGHT

CLASS 41—EDUCATION AND ENTERTAINMENT

FOR ENTERTAINMENT SERVICES IN THE NATURE OF LIVE MUSICAL PERFORMANCES, THEATRICAL AND MUSICAL PERFORMANCES, CINEMATIC AND VIDEO PERFORMANCES, BAND AND DANCE PERFORMANCES, NIGHTCLUB AND DISCOTHEQUE EVENTS, AND DISC JOCKEY SERVICES, PROVIDED IN NIGHTCLUBS, CAFES, BARS AND PUBLIC HOUSES (U.S. CLS. 100, 101 AND 107).

CLASS 42—SCIENTIFIC, COMPUTER AND LEGAL SERVICES

FOR CABARET AND DANCE CLUB SERVICES (U.S. CLS. 100 AND 101).

SN 76-204,373. WORKER'S COMPENSATION INSURANCE RATING BUREAU OF CALIFORNIA, SAN FRANCISCO, CA. FILED 2-2-2001.

WCIRBONLINE.ORG

OWNER OF U.S. REG. NO. 2,337,171.

CLASS 9—ELECTRICAL AND SCIENTIFIC APPARATUS

FOR ELECTRONIC DATABASE IN THE FIELD OF WORKERS' COMPENSATION INSURANCE RECORDED ON COMPUTER MEDIA (U.S. CLS. 21, 23, 26, 36 AND 38).

CLASS 16—PAPER GOODS AND PRINTED MATTER

FOR BROCHURES, MANUALS, PRINTED FORMS, REPORTS, BULLETINS, CATALOGUES, PRINTED SEMINAR NOTES, SEMINAR AND CONFERENCE MATERIALS, NAMELY WRITTEN INSTRUCTION MATERIALS AND PLASTIC TRANSPARENCIES, PRINTED GUIDES, REGULATORY FILINGS, AGENDAS, MINUTES AND REFERENCE MATERIALS IN THE FIELD OF WORKERS' COMPENSATION INSURANCE (U.S. CLS. 2, 5, 22, 23, 29, 37, 38 AND 50).

CLASS 36—INSURANCE AND FINANCIAL

FOR INSURANCE SERVICES, NAMELY PROVIDING INFORMATION RELATED TO WORKERS' COMPENSATION INSURANCE, SPECIFICALLY, PROVIDING INFORMATION AND CONSULTATION REGARDING WORKERS' COMPENSATION INSURANCE RATES, RATING EXPERIENCE INFORMATION, COVERAGE DATA, EMPLOYER CLASSIFICATIONS, STATISTICS, AND PROVIDING AN ON-LINE COMPUTER DATABASE IN THE FIELD OF WORKERS' COMPENSATION INSURANCE (U.S. CLS. 100, 101 AND 102).

CLASS 42—SCIENTIFIC, COMPUTER AND LEGAL SERVICES

FOR LEGAL CONSULTATION AND LEGAL INFORMATION REGARDING INSURANCE LAWS AND REGULATIONS IN THE FIELD OF WORKERS' COMPENSATION INSURANCE (U.S. CLS. 100 AND 101).

SN 76-204,673. SOCIETE DES PRODUITS NESTLE S.A., 1800 VEVEY, SWITZERLAND, FILED 2-5-2001.



NESPRESSO
PROFESSIONAL

OWNER OF U.S. REG. NOS. 1,607,148 AND 2,009,751.
NO CLAIM IS MADE TO THE EXCLUSIVE RIGHT TO USE "PROFESSIONAL", APART FROM THE MARK AS SHOWN.

CLASS 7—MACHINERY

FOR ELECTRIC COFFEE GRINDERS FOR COMMERCIAL AND DOMESTIC USE, ELECTRIC MACHINES FOR COFFEE EXTRACTION, NAMELY, CELLS FOR EXTRACTION (U.S. CLS. 13, 19, 21, 23, 31, 34 AND 35).

CLASS 9—ELECTRICAL AND SCIENTIFIC APPARATUS

FOR AUTOMATIC VENDING MACHINES FOR DISTRIBUTION OF COFFEE AND COFFEE CAPSULES (U.S. CLS. 21, 23, 26, 36 AND 38).

CLASS 11—ENVIRONMENTAL CONTROL APPARATUS

FOR ELECTRIC COFFEE MACHINES, COFFEE-POTS AND PERCOLATORS, AS WELL AS PARTS AND FITTINGS FOR THE AFORESAID GOODS (U.S. CLS. 13, 21, 23, 31 AND 34).

CLASS 21—HOUSEWARES AND GLASS

FOR HAND-OPERATED COFFEE GRINDERS; NON-ELECTRIC COFFEE MACHINES, COFFEE POTS AND PERCOLATORS, AS WELL AS PARTS AND FITTINGS FOR THE AFORESAID GOODS (U.S. CLS. 2, 13, 23, 29, 30, 33, 40 AND 50).

CLASS 30—STAPLE FOODS

FOR FILTERS AND CAPSULES CONTAINING COFFEE; COFFEE AND COFFEE EXTRACTS; TEA, SUGAR, CHOCOLATE (U.S. CL. 46).

CLASS 35—ADVERTISING AND BUSINESS

FOR ADVERTISING SERVICES, NAMELY, DISSEMINATION OF ADVERTISING FOR OTHERS VIA RADIO, TELEVISION, THEATRE PLAYBILLS, MAGAZINES, NEWSPAPERS AND THE INTERNET; DEVELOPING PROMOTIONAL CAMPAIGNS FOR THE FOODSTUFFS INDUSTRY; RENTAL AND LEASING OF AUTOMATIC VENDING MACHINES FOR THE DISTRIBUTION OF FOODSTUFFS AND BEVERAGES (U.S. CLS. 100, 101 AND 102).

CLASS 37—CONSTRUCTION AND REPAIR

FOR INSTALLATION, REPAIR, AND MAINTENANCE OF AUTOMATIC VENDING MACHINES FOR THE DISTRIBUTION OF FOODSTUFFS AND BEVERAGES; REPLENISHMENT OF AUTOMATIC VENDING MACHINES FOR THE DISTRIBUTION OF FOODSTUFFS AND BEVERAGES (U.S. CLS. 100, 103 AND 106).

CLASS 39—TRANSPORTATION AND STORAGE

FOR STORAGE AND TRANSPORT BY FERRY, BOAT, RAIL, AIR, TRUCK, AND VAN, OF FOOD AND BEVERAGES; DELIVERY OF BOOKS, BROCHURES, NEWSPAPERS, AUDIO, NAMELY, TAPES, CASSETTES, CDS, AND VIDEO, NAMELY, TAPES, CASSETTES, AND CDS, BY FERRY, BOAT, RAIL, AIR, TRUCK, AND VAN (U.S. CLS. 100 AND 105).

CLASS 41—EDUCATION AND ENTERTAINMENT

FOR PUBLICATION OF BOOKS, BROCHURES AND NEWSPAPERS; AUDIO AND VIDEO PRODUCTION SERVICES (U.S. CLS. 100, 101 AND 107).

CLASS 42—SCIENTIFIC, COMPUTER AND LEGAL SERVICES

FOR TECHNICAL CONSULTATION REGARDING THE USE AND MAINTENANCE OF AUTOMATIC VENDING MACHINES FOR THE DISTRIBUTION OF FOODSTUFFS AND BEVERAGES (U.S. CLS. 100 AND 101).

SN 76-205,163. MARS, INCORPORATED, MCLEAN, VA. FILED 2-5-2001.

**YOU DON'T EAT YOUR OWN
KIND, IT'S UNNATURAL**

CLASS 6—METAL GOODS

FOR METAL KEY CHAINS (U.S. CLS. 2, 12, 13, 14, 23, 25 AND 50).

CLASS 20—FURNITURE AND ARTICLES NOT OTHERWISE CLASSIFIED

FOR NON-METAL KEY CHAINS (U.S. CLS. 2, 13, 22, 25, 32 AND 50).

SN 76-205,914. MAIASTRA CORPORATION, NEW YORK, NY. FILED 2-7-2001.

SPONSORCLICK

OWNER OF FRANCE REG. NO. 003030810, DATED 5-22-2000, EXPIRES 5-22-2010.

CLASS 35—ADVERTISING AND BUSINESS

FOR PROVIDING AN ON-LINE COMPUTER DATABASE ON A GLOBAL COMPUTER NETWORK CREATED BY THE APPLICANT IN THE FIELD OF BUSINESS SPONSORSHIP (U.S. CLS. 100, 101 AND 102). FIRST USE 7-20-2000; IN COMMERCE 7-20-2000.

CLASS 38—COMMUNICATION

FOR TELECOMMUNICATIONS SERVICES, NAMELY, PROVIDING ON-LINE ELECTRONIC BULLETIN BOARDS FOR THE TRANSMISSION OF MESSAGES AMONG COMPUTER USERS CONCERNING BUSINESS SPONSORSHIP; TELECOMMUNICATIONS, NAMELY, PERSONAL COMMUNICATION SERVICES (U.S. CLS. 100, 101 AND 104). FIRST USE 7-20-2000; IN COMMERCE 7-20-2000.

SN 76-206,000. WITTMANN ROBOT SYSTEMS GMBH, 90571 SCHWAIG, FED REP GERMANY, FILED 2-7-2001.

FLOWCON

OWNER OF FED REP GERMANY REG. NO. 30059859, DATED 8-10-2000, EXPIRES 8-31-2010.

CLASS 7—MACHINERY

FOR MACHINES, NAMELY, INJECTION MOLDING MACHINES FOR PROCESSING PLASTICS (U.S. CLS. 13, 19, 21, 23, 31, 34 AND 35).

CLASS 9—ELECTRICAL AND SCIENTIFIC APPARATUS

FOR ELECTRIC CONTROLLERS FOR INJECTING MOLDING AND PROCESSING PLASTICS AND COMPUTERS FOR CONTROLLING INDUSTRIAL PROCESSES AND CONTROLLING INJECTION MOLDING AND PROCESSING PLASTICS (U.S. CLS. 21, 23, 26, 36 AND 38).

CLASS 40—MATERIAL TREATMENT

FOR MATERIAL WORKING, NAMELY, THE INJECTION MOLDING OF PLASTIC POLYMERS (U.S. CLS. 100, 103 AND 106).

SN 76-206,490. HALFORD COMPANY, NASHVILLE, TN. FILED 2-7-2001.

CD GUYS

NO CLAIM IS MADE TO THE EXCLUSIVE RIGHT TO USE "CD", APART FROM THE MARK AS SHOWN.

CLASS 9—ELECTRICAL AND SCIENTIFIC APPARATUS

FOR PRE-RECORDED PROMOTIONAL AUDIO PRODUCTS, NAMELY, COMPACT DISCS (U.S. CLS. 21, 23, 26, 36 AND 38).

CLASS 35—ADVERTISING AND BUSINESS

FOR PROMOTING THE GOODS AND SERVICES OF OTHERS THROUGH DISTRIBUTION OF PROMOTIONAL PRE-RECORDED AUDIO PRODUCTS, NAMELY, COMPACT DISCS (U.S. CLS. 100, 101 AND 102).

SN 76-206,681. GUSTAV ERNSTMEIER GMBH & CO. KG, 32049 HERFORD, FED REP GERMANY, FILED 2-8-2001.

ERATEX

OWNER OF FED REP GERMANY REG. NO. 300,43,076, DATED 9-9-2000, EXPIRES 6-30-2010.

CLASS 24—FABRICS

FOR COATED AND/OR IMPREGNATED FLAT TEXTILE MATERIALS FOR USE IN THE MANUFACTURE OF A WIDE VARIETY OF CONSUMER GOODS SUCH AS ABRASIVE BELTS, BOOK BINDINGS, PICTURE FRAMES, PICTURES, PACKAGING, CONFECTIONER'S DECORATOR BAGS, BELLOWS, EDGING STRIPS, BED UNDERLAYS, AND ARTIFICIAL SKINS AND COVERINGS FOR DUMMIES (U.S. CLS. 42 AND 50).

CLASS 40—MATERIAL TREATMENT

FOR TEXTILE TREATMENT SERVICES NAMELY FINISHING, COATING AND IMPREGNATING OF FLAT TEXTILE SURFACE STRUCTURES (U.S. CLS. 100, 103 AND 106).

SN 76-206,770. JOHN FINCH INTERNATIONAL, INC., CITY OF INDUSTRY, CA. FILED 2-6-2001.

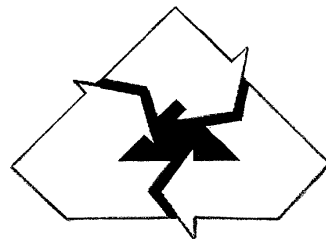

THE MARK CONSISTS OF A DISTINCTIVE TRUNCATED TRIANGULAR DESIGN.

CLASS 18—LEATHER GOODS

FOR BAGS, NAMELY, BACKPACKS, KNAPSACKS, BOOK BAGS, HANDBAGS, TOTE BAGS, AND CARRYALLS; AND LUGGAGE (U.S. CLS. 1, 2, 3, 22 AND 41).
FIRST USE 6-0-1998; IN COMMERCE 6-0-1998.

CLASS 25—CLOTHING

FOR CLOTHING, HEADWEAR AND FOOTWEAR; NAMELY PANTS, JEANS, SHORTS, TROUSERS, SLACKS; SHIRTS, T-SHIRTS, SWEATSHIRTS, POLO SHIRTS, SWEATERS, JACKETS, KNIT TOPS, TOPS; SKIRTS, DRESSES, TUNICS; SUITS, COORDINATED OUTFITS NAMELY TOP OR JACKET, WITH PANTS OR SKIRTS; WARM-UP OUTFITS NAMELY SWEAT SHIRT OR JACKET WITH PANTS OR SHORTS; CLOTHING ACCESSORIES NAMELY, FABRIC TUBES, SCARVES AND BANDEAUX; PAJAMAS, ROBES, NIGHTGOWNS, LEGGINGS, UNDERGARMENTS; RAINCOATS, COSTUMES, BELTS, TIES AND SWIMWEAR; HATS, BASEBALL CAPS, CAPS, BERETS, HEADBANDS, SWEATBANDS; MARTIAL ARTS UNIFORMS; SHOES, BOOTS, SLIPPERS, SANDALS, HOSIERY, AND SOCKS (U.S. CLS. 22 AND 39).
FIRST USE 6-0-1998; IN COMMERCE 6-0-1998.

SN 76-207,351. ESKA IMPLANTS GMBH & CO., LUBECK, FED REP GERMANY, FILED 2-8-2001.

ESKA AMERICA

OWNER OF U.S. REG. NOS. 1,449,480 AND 2,227,018.
NO CLAIM IS MADE TO THE EXCLUSIVE RIGHT TO USE "AMERICA", APART FROM THE MARK AS SHOWN.

CLASS 6—METAL GOODS

FOR BASE METALS AND THEIR ALLOYS FOR USE IN CASTING THE FORM OF SEMI-FINISHED AND FINISHED PRODUCTS, NAMELY, MEDICAL AND SURGICAL IMPLANTS, PROSTHESES AND ORTHESES (U.S. CLS. 2, 12, 13, 14, 23, 25 AND 50).

CLASS 10—MEDICAL APPARATUS

FOR PROSTHESES AND BONE IMPLANTS AND PARTS THEREOF (U.S. CLS. 26, 39 AND 44).

CLASS 41—EDUCATION AND ENTERTAINMENT

FOR EDUCATIONAL SERVICES, NAMELY, CONDUCTING SEMINARS, COURSES AND WORKSHOPS IN THE FIELD OF MEDICAL TECHNIQUES FOR MEDICAL IMPLANTS, BONE IMPLANTS, PROSTHESES AND IMPLANTATION (U.S. CLS. 100, 101 AND 107).

CLASS 42—SCIENTIFIC, COMPUTER AND LEGAL SERVICES

FOR MEDICAL CONSULTATION SERVICES IN THE FIELD OF MEDICAL IMPLANTS, BONE IMPLANTS, PROSTHESES AND IMPLANTATION (U.S. CLS. 100 AND 101).

SN 76-208,106. CROMPTON CORPORATION, GREENWICH, CT. FILED 2-9-2001.

FINDING BETTER SOLUTIONS**CLASS 1—CHEMICALS**

FOR HOUSE MARK FOR A FULL LINE OF CHEMICALS, NAMELY, SPECIALTY SILICONES, ORGANOFUNCTIONAL SILANES, SULFANATES, AMINO AND FATTY ACIDS, AMINO AND FATTY ACID DERIVATIVES, SURFACTANTS, ORGANICACIDS, STABILIZERS, INTERMEDIATES, AUXILIARIES, ANTIOXIDANTS, CURATIVES, HARDENERS, REGULANTS, ADJUVANTS, DESICCANTS, LIQUID POLYMERS, PRE-POLYMERS, ADDITIVES, RESINS, AND RESIN COMPOUNDS, AND INERT FILLERS FOR INDUSTRIAL AND AGRICULTURAL USES, FOR USE IN PAINTS, VARNISHES, CLEANERS, DETERGENTS, INDUSTRIAL DYES, PERSONAL CARE PRODUCTS, AND PHARMACEUTICAL PRODUCTS, AND FOR USE IN MANUFACTURING BUILDING MATERIALS (U.S. CLS. 1, 5, 6, 10, 26 AND 46).

CLASS 4—LUBRICANTS AND FUELS

FOR HOUSE MARK FOR OILS, GREASES AND LUBRICANTS FOR INDUSTRIAL USES (U.S. CLS. 1, 6 AND 15).

CLASS 5—PHARMACEUTICALS

FOR HOUSE MARK FOR HERBICIDES, FUNGICIDES, INSECTICIDES, MITICIDES, SURFACTANTS, AND OTHER PESTICIDES FOR USE IN HORTICULTURAL AND AGRICULTURAL INDUSTRIES (U.S. CLS. 6, 18, 44, 46, 51 AND 52).

CLASS 7—MACHINERY

FOR HOUSE MARK FOR POLYMER PROCESSING EQUIPMENT FOR INDUSTRIAL USES (U.S. CLS. 13, 19, 21, 23, 31, 34 AND 35).

CLASS 17—RUBBER GOODS

FOR HOUSE MARK FOR A FULL LINE OF SEMI-PROCESSED PLASTIC AND RUBBER POLYMER PRODUCTS FOR USE IN THE PLASTICS AND RUBBER MANUFACTURING INDUSTRIES (U.S. CLS. 1, 5, 12, 13, 35 AND 50).

SN 76-209,328. CHROME SYSTEMS CORPORATION, PORTLAND, OR. BY MERGER CHROME DATA CORPORATION, PORTLAND, OR. FILED 2-12-2001.

THE CHROME NETWORK**CLASS 35—ADVERTISING AND BUSINESS**

FOR COMPUTER SERVICES, NAMELY, PROVIDING A PLATFORM THAT ALLOWS MEMBER BUSINESSES TO EXCHANGE AND MATCH INFORMATION RELATING TO AUTOMOBILES, NAMELY, RESEARCHING, PRICING, LOCATING, BUYING AND ACCESSORIZING AUTOMOBILES, VIA A GLOBAL COMPUTER NETWORK (U.S. CLS. 100, 101 AND 102).

CLASS 36—INSURANCE AND FINANCIAL

FOR COMPUTER SERVICES, NAMELY, PROVIDING A PLATFORM THAT ALLOWS MEMBER BUSINESSES TO EXCHANGE AND MATCH INFORMATION RELATING TO AUTOMOBILES, NAMELY, FINANCING AND INSURING AUTOMOBILES, VIA A GLOBAL COMPUTER NETWORK (U.S. CLS. 100, 101 AND 102).

SN 76-210,926. F.A.O. SCHWARZ, NEW YORK, NY. FILED 2-15-2001.

FAO GIRL

OWNER OF U.S. REG. NO. 2,299,292.
NO CLAIM IS MADE TO THE EXCLUSIVE RIGHT TO USE "GIRL", APART FROM THE MARK AS SHOWN.

CLASS 3—COSMETICS AND CLEANING PREPARATIONS

FOR COSMETICS, NAMELY, NAIL POLISH, NAIL GLOSS, LIP GLOSS AND GEL, AND BODY GLITTER (U.S. CLS. 1, 4, 6, 50, 51 AND 52).

FIRST USE 5-28-1999; IN COMMERCE 5-28-1999.

CLASS 14—JEWELRY

FOR COSTUME JEWELRY, NAMELY, RINGS, NECKLACES AND BRACELETS (U.S. CLS. 2, 27, 28 AND 50).

FIRST USE 7-12-1999; IN COMMERCE 7-12-1999.

CLASS 16—PAPER GOODS AND PRINTED MATTER

FOR ARTS AND CRAFTS PAINT KITS; PHOTO ALBUMS, NOTEBOOKS AND PENS (U.S. CLS. 2, 5, 22, 23, 29, 37, 38 AND 50).

FIRST USE 6-10-1999; IN COMMERCE 6-10-1999.

CLASS 18—LEATHER GOODS

FOR BACKPACKS AND PURSES (U.S. CLS. 1, 2, 3, 22 AND 41).

FIRST USE 6-23-1999; IN COMMERCE 6-23-1999.

CLASS 20—FURNITURE AND ARTICLES NOT OTHERWISE CLASSIFIED

FOR WOODEN JEWELRY BOXES, PICTURE FRAMES, NON-METAL KEY CHAINS (U.S. CLS. 2, 13, 22, 25, 32 AND 50).

FIRST USE 7-6-1999; IN COMMERCE 7-6-1999.

CLASS 25—CLOTHING

FOR APPAREL, NAMELY SLEEP WEAR AND PAJAMAS, OUTERWEAR, NAMELY, HATS AND CAPS, ACTIVEWEAR, NAMELY, SWEAT SHIRTS, T-SHIRTS, SOCKS, HEAD BANDS, UNDERWEAR; AND EMBROIDERED CLOTHING, NAMELY SLEEP WEAR AND PAJAMAS, OUTERWEAR, NAMELY, HATS AND CAPS, ACTIVEWEAR, NAMELY, SWEAT SHIRTS, T-SHIRTS, SOCKS, HEAD BANDS, UNDERWEAR (U.S. CLS. 22 AND 39).

FIRST USE 5-7-1999; IN COMMERCE 5-7-1999.

CLASS 26—FANCY GOODS

FOR HAIR CLIPS, BARRETTES, PONY TAIL HOLDERS AND HAIR EXTENSIONS (U.S. CLS. 37, 39, 40, 42 AND 50).

FIRST USE 7-12-1999; IN COMMERCE 7-12-1999.

CLASS 28—TOYS AND SPORTING GOODS

FOR CHILDREN'S TOYS AND SPORTING GOODS, NAMELY, PLUSH ANIMALS, RAG DOLLS, DOLLS, BEADS, CHILDREN'S PLAY COSMETICS, SOCCER BALLS, VOLLEY BALLS, BASEBALLS, BASEBALL BATS AND GLOVES, JUMP ROPES AND FOUR SQUARE BALLS; HOBBY CRAFT KITS COMPRISING FOAM SHAPES, FOAM SHEETS, PIPE CLEANERS, SEQUINS, GLITTER GLUE, FEATHERS, CONFETTI, CRAFT STICKS, RIBBONS, FABRIC TRIM, YARNS, COLORED POMS, BEADS, WIGGLE EYES, FLOWER AND BUTTERFLY DANGLES AND FIGURATIVE LAMP SHADES (U.S. CLS. 22, 23, 38 AND 50).

FIRST USE 6-1-1999; IN COMMERCE 6-1-1999.

CLASS 35—ADVERTISING AND BUSINESS

FOR RETAIL STORE SERVICES AND CATALOGS FEATURING TOYS, ART AND CRAFTS SUPPLIES AND KITS, SLEEPING BAGS, COSTUME JEWELRY, COSMETICS, APPAREL, HAIR ACCESSORIES, PURSES AND BACKPACKS, ALL FOR GIRLS (U.S. CLS. 100, 101 AND 102).

FIRST USE 8-29-2000; IN COMMERCE 8-29-2000.

SN 76-211,107. FISCO TOOLS LIMITED, ESSEX, UNITED KINGDOM, FILED 2-15-2001.

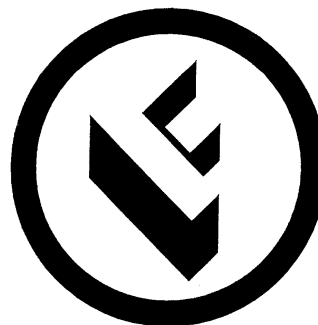

THE MARK CONSISTS OF A CIRCLE WITH A SYLIZED LETTER "F" IN THE MIDDLE.

CLASS 8—HAND TOOLS

FOR HAND TOOLS, NAMELY, HAMMERS, AXES, AND MARKING TOOLS FOR ROADS, FLOORS, WALLS AND OTHER SURFACES; SQUARES (U.S. CLS. 23, 28 AND 44).

CLASS 9—ELECTRICAL AND SCIENTIFIC APPARATUS

FOR TAPE MEASURES; SPIRIT LEVELS; GRADUATED RULERS; GEODESIC DEVICES, NAMELY, DISTANCE METERS, INCLINOMETERS AND SURVEYORS LEVELS, NAMELY, BOX LEVELS, BEAM LEVELS, BOAT LEVELS AND LASER LEVELS; ALL INTENDED FOR USE IN CONSTRUCTION, SURVEYING OR DOMESTIC MEASURING (U.S. CLS. 21, 23, 26, 36 AND 38).

SN 76-211,826. SALOMON S.A., 74370 METZ-TESSY, FRANCE, FILED 2-16-2001.

IVY

OWNER OF FRANCE REG. NO. 00/3047721, DATED 8-21-2000, EXPIRES 8-21-2010.

CLASS 18—LEATHER GOODS

FOR LEATHER AND IMITATIONS OF LEATHER SOLD IN BULK, TRAVEL AND LEATHER WORKING ARTICLES, NAMELY BRIEFCASES AND BRIEFCASE-TYPE PORTFOLIOS; ANIMAL SKINS, TRUNKS FOR TRAVEL AND TRAVELING BAGS; UMBRELLAS, PARASOLS AND WALKING STICKS; LEATHER LUGGAGE AND CLOTH BAGS, NAMELY SPORT BAGS, BACKPACKS, HANDBAGS, BAGS WORN AROUND THE WAIST, HAVERSACKS, CLUTCHES; SHOE BAGS FOR TRAVEL; SKI AND MOUNTAINEER BAGS, RUCKSACKS, SCHOOL BAGS, BAGS ON WHEELS, MONEY BAGS, EMPTY TOOL BAGS, GARMENT BAGS FOR TRAVELING, AND LEATHER STRAPS FOR TRAVEL BAGS, EMPTY PURSES NOT OF PRECIOUS MATERIAL (U.S. CLS. 1, 2, 3, 22 AND 41).

CLASS 28—TOYS AND SPORTING GOODS

FOR GAMES, NAMELY BOARD GAMES, CARD GAMES AND ACTION SKILL GAMES, SPORTING AND GYMNASIAC GOODS, WITH THE EXCEPTION OF CLOTHES, FOOT-WEAR AND COVERINGS, NAMELY SNOW SKIS AND WATER SKIS, SNOW BOARDS, BINDINGS FOR SKIS AND SURFING BOARDS, SKI POLES, DISKS, HANDLES, GRIPS OR HILTS FOR SKI POLES, SKI EDGES, CABLES TO ATTACH SKIS OR SKI SHOES OR BOOTS OR BOOTS TO THE SKIS, SKI BRAKES, ANTI-FRICTION MOUNTING AND PADS FOR SKI BINDINGS; ICE SKATES, LUGES, SNOW SLEDS FOR RECREATIONAL USE, SNOWSHOES, PROTECTIVE CASES AND TRAVEL BAGS FOR SKIS AND SKI BINDINGS, CANTING WEDGES FOR SKI BOOTS OR SKI BINDINGS ON THE SKI, HEELS AND TOES PIECES, SKI TIPS AND PROTECTION FOR SKI TIPS FOR SKIS, GATES AND POLES FOR MARKING A SLALOM COURSE, WAX FOR SKIS, GOLF CLUBS, GOLF BAGS; GAME BALLS, NAMELY FOR GOLF AND TENNIS, HOCKEY STICKS AND THEIR CASES OR COVERS, KNEE PROTECTORS FOR ATHLETIC USE, ELBOW PROTECTORS FOR ATHLETIC USE, SKI SCRAPERS, TENNIS RACKETS, TENNIS RACKET BAGS, IN-LINE AND ROLLER SKATES AND IN-LINE AND ROLLER SKATE COMPONENTS, NAMELY BRAKES, BRAKE LININGS, BRAKE AND WHEELS FRAMES AND WHEELS, PROTECTIVE STUFFING FOR SPORT CLOTHES, NAMELY ELBOW PROTECTORS, KNEE PROTECTORS, WRIST PROTECTORS WITH OR WITHOUT GLOVES; KITES (U.S. CLS. 22, 23, 38 AND 50).

SN 76-212,409. LINDEN OAKS CORPORATION, WILMINGTON, DE. FILED 2-20-2001.

THANK YOU

OWNER OF U.S. REG. NOS. 38,465 AND 1,188,837.

CLASS 29—MEATS AND PROCESSED FOODS

FOR FRUIT TOPPINGS AND FILLINGS, CANNED AND FROZEN VEGETABLES, CHILI WITH BEANS, CHILI, BEEF STEW, CHICKEN STEW, SOUP, ENTREES CONSISTING PRIMARILY OF POULTRY AND/OR MEAT, NAMELY: CHICKEN NOODLE DINNER, CHICKEN DINNER WITH VEGETABLES, NOODLE BEEF STROGANOFF, CHEESEBURGER MACARONI, SEASONED HERB NOODLES AND BEEF, CHILI MACARONI; SAUERKRAUT, AND MARINADES (U.S. CL. 46).

CLASS 30—STAPLE FOODS

FOR MAYONNAISE, MUSTARD, KETCHUP, SALSA, SALAD DRESSING, AND POPPED POPCORN (U.S. CL. 46).

SN 76-213,400. UNION GAS LIMITED, TORONTO, ONTARIO, CANADA, FILED 2-20-2001.

ENGEE ENERBEAR

CLASS 11—ENVIRONMENTAL CONTROL APPARATUS

FOR EQUIPMENT AND APPLIANCES POWERED BY NATURAL GAS AND/OR ELECTRICITY, NAMELY - OVENS; STOVES; COOKTOP RANGES; DISHWASHERS; CLOTHES DRYERS; CLOTHES WASHERS; OUTDOOR FIREPLACES, NAMELY PATIO CAMPFIRES AND CHIMENEAS; FIREPLACE INSERTS, ZERO-CLEARANCE FIREPLACES AND FREE-STANDING FIREPLACES, NAMELY HEAT EXCHANGERS, ARTIFICIAL GAS EMBERS AND ARTIFICIAL ELECTRICAL EMBERS; FURNACES; WATER HEATERS; WATER COOLERS; OUTDOOR COOKING GRILLS; GAS AND ELECTRIC POWERED CAMPFIRES AND CAMP-STOVES; BARBECUES; SPACE HEATERS; LIGHTING UNITS; WATER TREATMENT UNITS; AIR HANDLERS AND CONDITIONERS FOR DRYING, COOLING AND HEAT GENERATION; AND HEAT RECOVERY VENTILATION UNITS (U.S. CLS. 13, 21, 23, 31 AND 34).

CLASS 39—TRANSPORTATION AND STORAGE

FOR PUBLIC UTILITY SERVICES, NAMELY, THE TRANSMISSION, TRANSPORTATION, STORAGE AND DISTRIBUTION OF NATURAL GAS ENERGY, ELECTRICAL ENERGY AND WATER (U.S. CLS. 100 AND 105).

SN 76-213,740. PURONYX, INC., VISTA, CA. FILED 2-21-2001.

PURONYX

CLASS 5—PHARMACEUTICALS

FOR WOMEN'S HEALTHCARE OCCLUSIVE BANDAGE PRODUCTS, NAMELY, GLYCERIN GEL PAD ADHESIVES FOR ALL WOUNDS AND SKIN PROTECTION, INCLUDING EPISIOTOMY WOUNDS, HEMORRHOIDS, CAESAREAN SECTION WOUNDS AND BREAST SURGERY AND RELATED WOUNDS; OCCLUSIVE BANDAGE PRODUCTS, NAMELY, GLYCERIN GEL PAD ADHESIVES FOR CIRCUMCISION WOUNDS (U.S. CLS. 6, 18, 44, 46, 51 AND 52).

CLASS 10—MEDICAL APPARATUS

FOR BREAST PUMPS; MATERNITY SUPPORT PRODUCTS FOR USE DURING AND AFTER PREGNANCY, NAMELY, MATERNITY THERAPY BRAS, NURSING BRAS, ABDOMINAL SUPPORT GIRDLES, PREGNANCY SUPPORT BELTS, SUPPORT PANTIES, AND COMPRESSION HOSIERY (U.S. CLS. 26, 39 AND 44).

SN 76-215,066. CHILDREN'S MUSIC NETWORK, INC.,
EVANSTON, IL. FILED 2-26-2001.

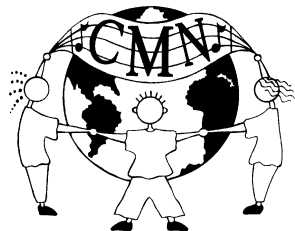

CLASS 16—PAPER GOODS AND PRINTED MATTER

FOR MAGAZINES AND BROCHURES IN THE FIELD OF MUSIC FOR CHILDREN (U.S. CLS. 2, 5, 22, 23, 29, 37, 38 AND 50).
FIRST USE 5-0-2000; IN COMMERCE 5-0-2000.

CLASS 42—SCIENTIFIC, COMPUTER AND LEGAL SERVICES

FOR ASSOCIATION SERVICES, NAMELY, PROMOTING THE INTERESTS OF PERFORMERS, SONGWRITERS, TEACHERS, RECORD PRODUCERS, RECORD DISTRIBUTORS, BROADCASTERS, FAMILIES, AND CHILDREN, AND PROMOTING THE FIELD OF CHILDREN'S MUSIC (U.S. CLS. 100 AND 101).
FIRST USE 5-0-2000; IN COMMERCE 5-0-2000.

SN 76-215,953. HORSESHOE GAMING HOLDING CORP.,
TINLEY PARK, IL. FILED 2-23-2001.

Jack Binion

OWNER OF U.S. REG. NO. 2,150,944.
THE NAME "JACK BINION" IDENTIFIES A LIVING INDIVIDUAL WHOSE CONSENT IS OF RECORD.

CLASS 41—EDUCATION AND ENTERTAINMENT

FOR CASINO AND GAMING SERVICES (U.S. CLS. 100, 101 AND 107).
FIRST USE 11-15-2000; IN COMMERCE 11-15-2000.

CLASS 42—SCIENTIFIC, COMPUTER AND LEGAL SERVICES

FOR HOTEL, RESTAURANT, AND BAR SERVICES (U.S. CLS. 100 AND 101).
FIRST USE 11-15-2000; IN COMMERCE 11-15-2000.

SN 76-216,717. ESECLENDING, LLC, BURLINGTON, VT.
FILED 2-28-2001.

DISCOVER THE PRINCIPAL DIFFERENCE

CLASS 35—ADVERTISING AND BUSINESS

FOR AUCTIONING OF SECURITIES CONDUCTED VIA THE INTERNET (U.S. CLS. 100, 101 AND 102).
FIRST USE 4-19-2000; IN COMMERCE 4-19-2000.

CLASS 36—INSURANCE AND FINANCIAL

FOR FINANCING SERVICES, DESIGNED TO FACILITATE THE LENDING OF SECURITIES FOR SHORT-TERM INVESTING, DIRECTED TO SECURITIES INVESTORS, CONDUCTED VIA THE INTERNET (U.S. CLS. 100, 101 AND 102).
FIRST USE 4-19-2000; IN COMMERCE 4-19-2000.

SN 76-216,718. ESECLENDING, LLC, BURLINGTON, VT.
FILED 2-28-2001.

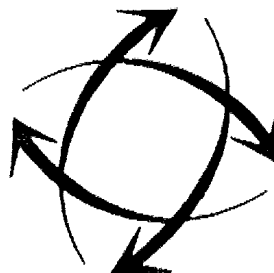

THE MARK CONSISTS OF FOUR ARROWS FORMING A STYLIZED CIRCLE.

CLASS 35—ADVERTISING AND BUSINESS

FOR AUCTIONING OF SECURITIES CONDUCTED VIA THE INTERNET (U.S. CLS. 100, 101 AND 102).
FIRST USE 4-19-2000; IN COMMERCE 4-19-2000.

CLASS 36—INSURANCE AND FINANCIAL

FOR FINANCING SERVICES, DESIGNED TO FACILITATE THE LENDING OF SECURITIES FOR SHORT-TERM INVESTING, DIRECTED TO SECURITIES INVESTORS, CONDUCTED VIA THE INTERNET (U.S. CLS. 100, 101 AND 102).
FIRST USE 4-19-2000; IN COMMERCE 4-19-2000.

SN 76-216,999. HAYCO MANUFACTURING LTD., WAN-CHAI, HONG KONG, FILED 2-27-2001.

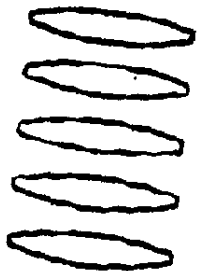

CLASS 8—HAND TOOLS

FOR OUTDOOR AND GARDEN TOOLS, NAMELY, SPADES, HOES, SHOVELS, RAKES, AND FORKS, AS WELL AS SUCH TOOLS SCALED FOR USE BY CHILDREN; CUTLERY, NAMELY, KITCHEN KNIVES, FORKS AND SPOONS; VEGETABLE BRUSHES WITH PEELERS (U.S. CLS. 23, 28 AND 44).

CLASS 20—FURNITURE AND ARTICLES NOT OTHERWISE CLASSIFIED

FOR PLASTIC HANDLES FOR BRUSHES (U.S. CLS. 2, 13, 22, 25, 32 AND 50).

CLASS 21—HOUSEWARES AND GLASS

FOR COOKING UTENSILS FOR BARBEQUE USE, NAMELY, TONGS AND FORKS; HAND-HELD BROOMS FOR SWEEPING LAWNS; BROOMS; BRUSHES FOR CLEANING CARPETS, FLOORS, WINDOWS, TOILETS, DISHES, AND GRILLS, AND BRUSHES WITH DETERGENT CONTAINERS FOR CLEANING SAME; HAND-HELD BRUSHES FOR PERSONAL USE IN BATHING AND MASSAGING; BRUSHES FOR CLOTHING AND SHOE CARE; MOPS, SWIVEL MOPS, AND MOPPING BRUSHES; SPATULAS; DUST PANS; RUG AND CARPET SWEEPERS; SQUEEGEES AND SPONGES AND COMBINATION SPONGES WITH SQUEEGEE BLADES FOR HOUSEHOLD USE; BASTING BRUSHES AND SPICE SHAKERS FOR BARBEQUE USE; AND HOUSEHOLD PLASTIC GLOVES AND GLOVES FOR USE IN GARDENING (U.S. CLS. 2, 13, 23, 29, 30, 33, 40 AND 50).

SN 76-217,061. IWATA, NAOMI, MINATU-KU TOKYO 106-0047, JAPAN, FILED 2-26-2001.

PECOLA

CLASS 9—ELECTRICAL AND SCIENTIFIC APPARATUS

FOR PRE-RECORDED VIDEO CASSETTES FEATURING CARTOON ANIMATIONS; COMPACT DISCS FEATURING CARTOON ANIMATIONS; AND CD-ROMS FEATURING CARTOON ANIMATIONS (U.S. CLS. 21, 23, 26, 36 AND 38).

CLASS 14—JEWELRY

FOR JEWELRY, NAMELY, DECORATIVE PINS; DECORATIVE LAPEL PINS; ORNAMENTAL PINS (U.S. CLS. 2, 27, 28 AND 50).

CLASS 16—PAPER GOODS AND PRINTED MATTER

FOR POSTERS, TRADING CARDS, STICKERS, COMIC BOOKS FEATURING CARTOON ANIMATIONS (U.S. CLS. 2, 5, 22, 23, 29, 37, 38 AND 50).

CLASS 25—CLOTHING

FOR MEN'S, WOMEN'S, CHILDREN'S, TODDLER'S AND INFANT'S CLOTHING AND OUTERWEAR, NAMELY SHIRTS, PANTS, SHORTS, TOPS, SETS CONSISTING OF PANTS AND TOPS, SWIM WEAR, JACKETS, COATS, PARKAS, SWEATERS, SCARVES, GLOVES, BELTS, SPORTSWEAR, NAMELY T-SHIRTS, SWEAT-SHIRTS, SWEAT PANTS, SWEAT SUITS AND SNEAKERS AND HEADGEAR, NAMELY, HATS SKI MASKS AND HEADBANDS (U.S. CLS. 22 AND 39).

CLASS 26—FANCY GOODS

FOR ORNAMENTAL NOVELTY PINS, DECORATIVE HAIR PINS (U.S. CLS. 37, 39, 40, 42 AND 50).

CLASS 28—TOYS AND SPORTING GOODS

FOR BOARD GAMES, ACTION FIGURES, DOLLS, WIND-UP TOYS (U.S. CLS. 22, 23, 38 AND 50).

SN 76-218,141. SIEMENS AKTIENGESELLSCHAFT, MUNCHEN, FED REP GERMANY, FILED 2-28-2001.

SIMOSTART MV

PRIORITY CLAIMED UNDER SEC. 44(D) ON FED REP GERMANY APPLICATION NO. 30074068.9/0, FILED 10-5-2000, REG. NO. 30074068, DATED 10-26-2000, EXPIRES 10-31-2010.

OWNER OF U.S. REG. NOS. 2,262,130, 2,382,225 AND 2,407,990.

NO CLAIM IS MADE TO THE EXCLUSIVE RIGHT TO USE "MV", APART FROM THE MARK AS SHOWN.

CLASS 7—MACHINERY

FOR ELECTRICAL MOTORS FOR MACHINES; STARTERS FOR MOTORS AND ENGINES (U.S. CLS. 13, 19, 21, 23, 31, 34 AND 35).

CLASS 9—ELECTRICAL AND SCIENTIFIC APPARATUS

FOR ELECTRONIC AND ELECTRICAL APPARATUS, DEVICES AND INSTRUMENTS, NAMELY, CONTROLS FOR ELECTRIC MOTORS AND ENGINES, CONVERTERS FOR MOTOR CURRENT GENERATION, ELECTRICAL CONTROLS FOR MACHINES, NAMELY, CLOSED-LOOP CONTROLS FOR CONTROLLING SPEED AND MACHINE BEARINGS; COMMUNICATION INTERFACES FOR MOTOR CONTROL, NAMELY, COMPUTER HARDWARE AND SOFTWARE FOR CONTROLLING AND MONITORING THE OPERATION OF ELECTRIC MOTORS FOR MACHINES (U.S. CLS. 21, 23, 26, 36 AND 38).

SN 76-218,185. KRAGEN, EMMA, BEVERLY HILLS, CA.
FILED 3-2-2001.

12 DOGS OF CHRISTMAS

CLASS 9—ELECTRICAL AND SCIENTIFIC APPARATUS

FOR SERIES OF PRE-RECORDED VIDEOCASSETTES, COMPACT DISCS, PHONOGRAPH RECORDS, CD-ROM DISCS AND DVD DISCS FEATURING MUSIC; DECORATIVE MAGNETS; COMPUTER SOFTWARE FOR USE AS SCREEN SAVERS; COMPUTER GAMES, NAMELY, COMPUTER GAME SOFTWARE, CARTRIDGES, CASSETTES, DISCS, AND TAPES, INTERACTIVE MULTIMEDIA COMPUTER GAME PROGRAMS, AND INTERACTIVE VIDEO GAMES OF VIRTUAL REALITY COMPRISED OF COMPUTER HARDWARE AND SOFTWARE; ELECTRONIC GAME PROGRAMS (U.S. CLS. 21, 23, 26, 36 AND 38).

CLASS 14—JEWELRY

FOR CLOCKS; WATCHES; CHARMS FOR BRACELETS; PENDANTS (U.S. CLS. 2, 27, 28 AND 50).

CLASS 16—PAPER GOODS AND PRINTED MATTER

FOR PAPER AND PAPER ARTICLES, NAMELY, GREETING CARDS, GIFT CARDS, POSTCARDS, PLAYING CARDS, CALENDARS, POSTERS, NOTE PADS, NOTEBOOKS, WRITING TABLETS, ADHESIVE STICKERS, BUMPER STICKERS, DECALS, GIFT WRAP, BOOKMARKS, PENCILS, PENS AND ERASERS (U.S. CLS. 2, 5, 22, 23, 29, 37, 38 AND 50).

CLASS 25—CLOTHING

FOR CLOTHING, NAMELY T-SHIRTS, SHIRTS, SWEATSHIRTS, SWEATPANTS, BOXER SHORTS, PAJAMAS, HATS, CAPS, TIES, SOCKS, JACKETS, TANK TOPS, APRONS, SHORTS, PANTS, SUSPENDERS, SWEATERS AND VESTS (U.S. CLS. 22 AND 39).

CLASS 28—TOYS AND SPORTING GOODS

FOR GAMES AND PLAYTHINGS, NAMELY BOARD GAMES, CHILDREN'S TOY PLAY HOUSE, INFLATABLE TOYS, STUFFED TOYS, PLASTIC TOYS, TOY ACTION FIGURES, TOY BALLOONS, TOY BALLS, TOY DOLLS, TOY PUPPETS, PLUSH TOYS, TOY PUZZLES; GYMNASIAC APPARATUS; CHRISTMAS TREE DECORATIONS; COMPUTER GAMES, NAMELY, TOY, NAMELY, BATTERY-POWERED COMPUTER GAME WITH LCD SCREEN WHICH FEATURES ANIMATION AND SOUND EFFECTS; ELECTRONIC GAMES, NAMELY, HAND HELD UNIT FOR PLAYING ELECTRONIC GAMES (U.S. CLS. 22, 23, 38 AND 50).

SN 76-218,199. B.F.GOODRICH COMPANY, THE, CHARLOTTE, NC. FILED 3-2-2001.



OWNER OF U.S. REG. NOS. 64,996, 1,423,775 AND OTHERS.

CLASS 8—HAND TOOLS

FOR MULTIPLE FUNCTION FOLDING POCKET TOOLS; POCKETKNIVES; MULTIPLE FUNCTION POCKET SIZE INSTRUMENTS CONSISTING OF VARIOUS IMPLEMENTS, NAMELY, NAIL FILE WITH SCREWDRIVER TIP, TOOTHPICK, STRAIGHT PIN, TWEEZERS, PEN, RULER, KNIFE BLADE AND SCISSORS (U.S. CLS. 23, 28 AND 44).

CLASS 14—JEWELRY

FOR CLOCKS; WATCHES; CLOCKS INCORPORATING CALCULATORS (U.S. CLS. 2, 27, 28 AND 50).

CLASS 16—PAPER GOODS AND PRINTED MATTER

FOR PENS; HIGHLIGHTING PENS; NOTE PADS; MEMO BOOKS; WRITING SETS CONSISTING PRIMARILY OF PENCILS, PENCIL SHARPENER, ERASER, AND DRAWING RULER; STATIONERY PORTFOLIOS; DOCUMENT HOLDERS; LUNCH BAGS (U.S. CLS. 2, 5, 22, 23, 29, 37, 38 AND 50).

CLASS 18—LEATHER GOODS

FOR BUSINESS CARD CASES; UMBRELLAS; GOLF SHOE BAGS FOR TRAVEL; PLASTIC TRADE SHOW TOTE BAGS; SUITCASES; DUFFEL BAGS; GARMENT BAGS FOR TRAVEL; LUGGAGE TAGS; WALLETS; ALL-PURPOSE ATHLETIC BAGS (U.S. CLS. 1, 2, 3, 22 AND 41).

CLASS 21—HOUSEWARES AND GLASS

FOR PORTABLE BEVERAGE COOLERS; PORTABLE COOLERS; MUGS; SPORTS BOTTLES SOLD EMPTY; VACUUM BOTTLES; INSULATING SLEEVE HOLDERS FOR BEVERAGE CANS (U.S. CLS. 2, 13, 23, 29, 30, 33, 40 AND 50).

CLASS 24—FABRICS

FOR TOWELS; FABRIC FLAGS AND BANNERS (U.S. CLS. 42 AND 50).

CLASS 25—CLOTHING

FOR CLOTHING, NAMELY, CAPS, SHIRTS, JACKETS, VESTS, SWEATERS, PANTS AND SKIRTS (U.S. CLS. 22 AND 39).

CLASS 28—TOYS AND SPORTING GOODS

FOR SPORTING GOODS, NAMELY, GOLF BALLS, TENNIS BALLS, GOLF TEES, AND DIVOT FIXERS (U.S. CLS. 22, 23, 38 AND 50).

SN 76-218,755. RUKEYSER, LOUIS, GREENWICH, CT.
FILED 3-2-2001.

LOUIS RUKEYSER'S

THE NAME "LOUIS RUKEYSER" IDENTIFIES A LIVING INDIVIDUAL WHOSE CONSENT IS OF RECORD.

CLASS 36—INSURANCE AND FINANCIAL

FOR PROVIDING FINANCIAL INVESTMENT ADVICE VIA A GLOBAL COMPUTER NETWORK, NAMELY, PROVIDING AN INTERACTIVE DATABASE WEBSITE FEATURING INFORMATION ABOUT FINANCIAL INVESTING (U.S. CLS. 100, 101 AND 102).

FIRST USE 9-0-2000; IN COMMERCE 9-0-2000.

CLASS 42—SCIENTIFIC, COMPUTER AND LEGAL SERVICES

FOR COMPUTER SERVICES, NAMELY, PROVIDING ON LINE NEWSLETTERS IN THE FIELD OF FINANCIAL INVESTING (U.S. CLS. 100 AND 101).
FIRST USE 9-0-2000; IN COMMERCE 9-0-2000.

SN 76-219,976. FUNDICIONES DEL ESTANDA, S.A., E-2020 BEASAIN, SPAIN, FILED 3-6-2001.



SN 76-219,421. PECHINEY PLASTIC PACKAGING, INC., NORWALK, CT. FILED 3-2-2001.



NO CLAIM IS MADE TO THE EXCLUSIVE RIGHT TO USE "AMERICAS", APART FROM THE MARK AS SHOWN.

CLASS 6—METAL GOODS

FOR METAL TUBING, METALLIC DISPENSER CAPS AND CAPS FOR TUBES AND BOTTLES, METAL BOXES, METALLIC PACKING CONTAINERS FOR THE STORAGE AND TRANSPORTATION OF GOODS; METALLIC SHEETS FOR PACKING IN THE STORAGE AND TRANSPORTATION OF GOODS; RAW OR SEMI-FINISHED BASE METALS AND THEIR ALLOYS, ROLLED AND CAST BUILDING MATERIALS, NAMELY SHEETS, SHEET METAL, SECTIONS, TUBES AND PARTS FOR SMELTING IN LIGHT METALS (U.S. CLS. 2, 12, 13, 14, 23, 25 AND 50).

CLASS 17—RUBBER GOODS

FOR PLASTIC MATERIALS USED IN MANUFACTURING, NAMELY, LAMINATED SHEETS IN EXTRUDED FORM; LAMINATED TUBES; TUBES MADE OF PLASTIC MATERIALS; SEMI-FINISHED PRODUCTS MADE OF PLASTIC, NAMELY, FILMS, SHEETS, CELLULAR MATERIALS IN ARTIFICIAL RESIN; MULTIPLAYER FILM COMPRISED OF PLASTIC SUITABLE FOR THE MANUFACTURE OF TUBULAR STRUCTURES; PLASTIC SEALS FOR SEALING ORIFICES OF PLASTIC TUBES; EXTRUDED PLASTIC IN THE FORM OF BARS, BLOCKS, PELLETS, RODS, SHEETS AND TUBES FOR USE IN MANUFACTURING AND GENERAL INDUSTRIAL USE; PLASTIC TUBES (U.S. CLS. 1, 5, 12, 13, 35 AND 50).

CLASS 20—FURNITURE AND ARTICLES NOT OTHERWISE CLASSIFIED

FOR BOXES AND PACKAGING CONTAINERS MADE OF PLASTIC; NON-METALLIC CAPS AND CAPSULES FOR CORKING CONTAINERS HAVING A LAMINATED BODY OF PLASTICS; CONTAINERS IN THE FORM OF TUBES OF THE SQUEEZE-TO-USE TYPE; TUBES FOR PRODUCT PACKAGING (U.S. CLS. 2, 13, 22, 25, 32 AND 50).

NO CLAIM IS MADE TO THE EXCLUSIVE RIGHT TO USE "FUNDICIONES", APART FROM THE MARK AS SHOWN.

THE MARK CONSISTS IN PART OF THE STYLIZED LETTER "E".

THE ENGLISH TRANSLATION OF "ESTANDA FUNDICIONES" IS "ESTANDA FOUNDRY".

CLASS 6—METAL GOODS

FOR GOODS PRODUCED BY SMELTING, NAMELY EROSION RESISTANT STEEL, REFRACTORY STEEL, CARBON STEEL, STAINLESS STEEL, AND MANGANESE STEEL, ALL IN ROD, SHEET, BAR AND/OR BILLET FORM; STEEL ALLOY FOR CASTING AND FURTHER MANUFACTURING; CHROME WHITE SMELTING ALLOY FOR CASTING AND FURTHER MANUFACTURING (U.S. CLS. 2, 12, 13, 14, 23, 25 AND 50).

CLASS 40—MATERIAL TREATMENT

FOR MATERIAL TREATMENT SERVICES, NAMELY SMELTING OF METALS INTO EROSION RESISTANT STEEL, REFRACTORY STEEL, CARBON STEEL, STAINLESS STEEL AND MANGANESE STEEL ALL IN ROD, SHEET, BAR AND/OR BILLET FORM; SMELTING OF METALS INTO STEEL ALLOY FOR CASTING AND FURTHER MANUFACTURING; SMELTING OF METALS INTO CHROME WHITE SMELTING ALLOY FOR CASTING AND FURTHER MANUFACTURING (U.S. CLS. 100, 103 AND 106).

SN 76-220,048. KESTREL TECHNOLOGIES, INC., NEW YORK, NY. FILED 3-5-2001.

KESTREL

OWNER OF U.S. REG. NO. 2,092,161.

CLASS 9—ELECTRICAL AND SCIENTIFIC APPARATUS

FOR COMPUTER HARDWARE AND COMPUTER SOFTWARE FOR USE IN AGGREGATING, COLLECTING, CATEGORIZING, CALCULATING, CONVERTING, STORING, MAINTAINING, TRACKING, MONITORING, ANALYZING, PROCESSING, FORECASTING, REPORTING, SUMMARIZING, DISPLAYING, DISSEMINATING, AND MANAGING DATA AND INFORMATION FOR USE BY OTHERS IN THE FIELDS OF COMPUTERS, COMPUTER SOFTWARE, COMPUTER PROGRAMMING, COMPUTER DATABASE MANAGEMENT, GLOBAL COMPUTER INFORMATION NETWORKS, FINANCE, INVESTMENT, BANKING, ACCOUNTING, SECURITIES, INSURANCE, E-COMMERCE TRANSACTIONS, E-BUSINESS TRANSACTIONS, ELECTRONIC COMMERCIAL TRANSACTIONS AND ELECTRONIC FINANCIAL TRANSACTIONS; COMPUTER SOFTWARE AND COMPUTER PROGRAMS FOR USE IN CAPITAL MANAGEMENT, FINANCIAL ANALYSIS, FINANCIAL CONSULTING, FINANCIAL MANAGEMENT, SECURITIES TRADING, INVESTMENT, BROKERAGE, ASSET MANAGEMENT AND RISK MANAGEMENT AND RELATED INSTRUCTION MANUALS AND USER GUIDES SOLD AS A UNIT THEREWITH (U.S. CLS. 21, 23, 26, 36 AND 38).

CLASS 42—SCIENTIFIC, COMPUTER AND LEGAL SERVICES

FOR CONSULTATION IN THE FIELDS OF COMPUTERS, COMPUTER SOFTWARE AND COMPUTER PROGRAMMING; COMPUTER SOFTWARE DEVELOPMENT AND DESIGN FOR OTHERS; COMPUTER PROGRAMMING FOR OTHERS; MAINTAINING COMPUTER SOFTWARE FOR OTHERS; UPDATING OF COMPUTER SOFTWARE; COMPUTER DATABASE DEVELOPMENT FOR OTHERS; TECHNICAL RESEARCH AND DEVELOPMENT SERVICES IN THE FIELDS OF COMPUTERS, COMPUTER SOFTWARE, COMPUTER PROGRAMMING, FINANCE, INVESTMENT, BANKING, ACCOUNTING, SECURITIES, INSURANCE, E-COMMERCE TRANSACTIONS, E-BUSINESS TRANSACTIONS, ELECTRONIC COMMERCIAL TRANSACTIONS AND ELECTRONIC FINANCIAL TRANSACTIONS (U.S. CLS. 100 AND 101).

SN 76-220,383. TEAM IN FOCUS, LLC, LAKE CITY, FL. FILED 3-6-2001.

TEAM IN FOCUS

NO CLAIM IS MADE TO THE EXCLUSIVE RIGHT TO USE "TEAM", APART FROM THE MARK AS SHOWN.

CLASS 9—ELECTRICAL AND SCIENTIFIC APPARATUS

FOR PRERECORDED AUDIO-VISUAL MEDIA, NAMELY AUDIO TAPES, COMPACT DISKS, AND COMPUTER CD-ROMS, FEATURING INSTRUCTIONAL AND EDUCATIONAL MATERIALS IN THE FIELD OF BUSINESS SUPPORT AND DEVELOPMENT (U.S. CLS. 21, 23, 26, 36 AND 38).

CLASS 16—PAPER GOODS AND PRINTED MATTER

FOR PRINTED INSTRUCTIONAL, EDUCATIONAL, AND TEACHING MATERIALS IN THE FIELD OF BUSINESS SUPPORT AND DEVELOPMENT (U.S. CLS. 2, 5, 22, 23, 29, 37, 38 AND 50).

SN 76-220,539. COMPRECORP, NEVADA CITY, CA. FILED 3-6-2001.

COMPRECORP**CLASS 9—ELECTRICAL AND SCIENTIFIC APPARATUS**

FOR COMPUTER SOFTWARE, NAMELY, SOFTWARE FOR INTELLIGENT AGENTS, NAMELY, ALGORITHMS THAT ENABLE MACHINES TO REASON LIKE HUMANS, COGNITIVE TECHNOLOGY, NAMELY, AN APPLICATION SPECIFIC SET OF ALGORITHMS THAT ALLOWS A MACHINE TO BEHAVE IN AN INTELLIGENT MANNER, AND ARTIFICIAL INTELLIGENCE (U.S. CLS. 21, 23, 26, 36 AND 38).

CLASS 42—SCIENTIFIC, COMPUTER AND LEGAL SERVICES

FOR COMPUTER CONSULTING IN THE FIELD OF KNOWLEDGE ENGINEERING AND INTELLIGENT AGENT APPLICATIONS, NAMELY, ALGORITHMS THAT ENABLE MACHINES TO REASON LIKE HUMANS (U.S. CLS. 100 AND 101).

SN 76-221,044. AARP, WASHINGTON, DC. FILED 3-8-2001.

LIFE@50+ A CELEBRATION OF YOU**CLASS 16—PAPER GOODS AND PRINTED MATTER**

FOR PRINTED PUBLICATIONS, NAMELY, NEWSLETTERS, BULLETINS, EMPLOYMENT GUIDES AND MAGAZINES FEATURING AND PROMOTING THE INTERESTS OF INDIVIDUALS AGED FIFTY AND OVER AND INFORMATION IN THE FIELDS OF CAREGIVING, EDUCATION, GRANDPARENTING, HEALTH, LIVING WITH A CHRONIC MEDICAL CONDITION, PARENTING, RETIREMENT, ELDERCARE, EMPLOYMENT, ASSISTED CARE FACILITIES, MATURE LIFESTYLES, MONEY, INVESTMENTS, TRAVEL, AND ELDER ASSISTANCE (U.S. CLS. 2, 5, 22, 23, 29, 37, 38 AND 50).

CLASS 35—ADVERTISING AND BUSINESS

FOR BUSINESS SERVICES, NAMELY, PROMOTING THE GOODS AND SERVICES OF OTHERS BY PREPARING AND PLACING ADVERTISEMENTS ON GLOBAL COMPUTER NETWORKS AND AT TRADE SHOWS, CONVENTIONS AND EXPOSITIONS; RETAIL STORE AND ONLINE RETAIL STORE SERVICES IN THE FIELD OF PHARMACEUTICAL AND HEALTH PRODUCTS; AND ARRANGING, CONDUCTING AND ORGANIZING TRADE SHOWS, CONVENTIONS AND EXPOSITIONS IN THE FIELD OF MATURE PERSONS AND PERSONS PREPARING FOR RETIREMENT, AND GOODS AND SERVICES INTENDED THEREFOR (U.S. CLS. 100, 101 AND 102).

CLASS 36—INSURANCE AND FINANCIAL

FOR PROVIDING REBATES AND DISCOUNTS AT PARTICIPATING ESTABLISHMENTS OF OTHERS THROUGH THE USE OF MEMBERSHIP CARDS AND MEMBERSHIP PROGRAMS; PROVIDING INFORMATION IN THE FIELD OF GROUP HEALTH INSURANCE, ANNUITIES AND RETIREMENT PLANS; PROVIDING INFORMATION IN THE FIELD OF MONEY MANAGEMENT, INVESTMENT AND INSURANCE; AND PROVIDING INFORMATION IN THE FIELD OF PREPAID PHARMACY PLANS AND CREDIT CARD SERVICES (U.S. CLS. 100, 101 AND 102).

CLASS 41—EDUCATION AND ENTERTAINMENT

FOR ARRANGING AND CONDUCTING EDUCATIONAL SEMINARS, CLASSES, AND WORK SHOPS FOR MATURE PERSONS AND PERSONS PREPARING FOR RETIREMENT IN THE FIELDS OF RETIREMENT, MATURE OR RETIRED LIFESTYLES, FINANCE, HEALTH, INSURANCE, MEDICINE, TRAVEL, VOLUNTEER ACTIVITIES, AGING AND FAMILY RELATIONSHIPS; AND DISTRIBUTION OF COURSE MATERIALS IN CONNECTION THEREWITH (U.S. CLS. 100, 101 AND 107).

CLASS 42—SCIENTIFIC, COMPUTER AND LEGAL SERVICES

FOR COMPUTER SERVICES, NAMELY, PROVIDING AN ONLINE MAGAZINE IN THE FIELDS OF RETIREMENT, MATURE OR RETIRED LIFESTYLES, FINANCE, HEALTH, INSURANCE, MEDICINE, TRAVEL, VOLUNTEER ACTIVITIES, AGING AND FAMILY RELATIONSHIPS; PROVIDING AN ONLINE DATABASE ON GLOBAL COMPUTER NETWORKS IN THE FIELD OF SENIOR CITIZENSHIP AND TOPICS RELATED TO AGING; AND ORGANIZING AND CONDUCTING COMMUNITY VOLUNTEER PROGRAMS (U.S. CLS. 100 AND 101).

SN 76-221,083. RUETZ, STEFAN, MUNICH, FED REP GERMANY, FILED 3-7-2001.

LOGISCENTS**CLASS 9—ELECTRICAL AND SCIENTIFIC APPARATUS**

FOR ELECTRONIC CONSOLE THAT EMITS FRAGRANCES AND SCENTS IN SYNCHRONIZATION WITH SOUND AND IMAGES AT LIVE AND NON-LIVE SHOWS, EVENTS, PRESENTATIONS AND PERFORMANCES (U.S. CLS. 21, 23, 26, 36 AND 38).

CLASS 21—HOUSEWARES AND GLASS

FOR AEROSOL DISPENSERS NOT FOR MEDICAL USE (U.S. CLS. 2, 13, 23, 29, 30, 33, 40 AND 50).

CLASS 41—EDUCATION AND ENTERTAINMENT

FOR ENTERTAINMENT SERVICES, NAMELY, PROVIDING FRAGRANCE AND SCENTS IN SYNCHRONIZATION WITH SOUND AND IMAGES AT LIVE AND NON-LIVE SHOWS, EVENTS, PRESENTATIONS AND PERFORMANCES BY MEANS OF ELECTRONIC SCENT EMITTING CONSOLES (U.S. CLS. 100, 101 AND 107).

SN 76-221,084. RUETZ, STEFAN, MUNICH, FED REP GERMANY, FILED 3-7-2001.

MOBILESCENTS**CLASS 9—ELECTRICAL AND SCIENTIFIC APPARATUS**

FOR ELECTRONIC CONSOLE THAT EMITS FRAGRANCES AND SCENTS IN SYNCHRONIZATION WITH SOUND AND IMAGES AT LIVE AND NON-LIVE SHOWS, EVENTS, PRESENTATIONS AND PERFORMANCES (U.S. CLS. 21, 23, 26, 36 AND 38).

CLASS 21—HOUSEWARES AND GLASS

FOR AEROSOL DISPENSERS NOT FOR MEDICAL USE (U.S. CLS. 2, 13, 23, 29, 30, 33, 40 AND 50).

CLASS 41—EDUCATION AND ENTERTAINMENT

FOR ENTERTAINMENT SERVICES, NAMELY, PROVIDING FRAGRANCE AND SCENTS IN SYNCHRONIZATION WITH SOUND AND IMAGES AT LIVE AND NON-LIVE SHOWS, EVENTS, PRESENTATIONS AND PERFORMANCES BY MEANS OF ELECTRONIC SCENT EMITTING CONSOLES (U.S. CLS. 100, 101 AND 107).

SN 76-221,488. DECRANE AIRCRAFT HOLDINGS, INC., EL SEGUNDO, CA. FILED 3-8-2001.

CABIN IN A BOX**CLASS 37—CONSTRUCTION AND REPAIR**

FOR UPGRADING AND RETROFITTING OF PRODUCTS FOR THE CORPORATE AIRCRAFT INDUSTRY, NAMELY, AIRCRAFT AND CABIN FURNISHINGS, LIGHTING, COMMUNICATION SYSTEMS, IN-FLIGHT ENTERTAINMENT EQUIPMENT, FUEL TANK SYSTEMS AND POWER UNITS, CABIN SHELLS, SIDEWALLS AND PARTITIONS, AUDIO-VISUAL EQUIPMENT, FLIGHT DECK INSTRUMENTATION AND INSTRUMENTATION DISPLAY COMPONENTS, GLOBAL POSITIONING EQUIPMENT AND TRAFFIC COLLISION AVOIDANCE EQUIPMENT, AVIONICS SYSTEMS (U.S. CLS. 100, 103 AND 106).

CLASS 40—MATERIAL TREATMENT

FOR CUSTOM MANUFACTURE OF PRODUCTS FOR THE CORPORATE AIRCRAFT INDUSTRY, NAMELY, AIRCRAFT AND CABIN FURNISHINGS, LIGHTING, COMMUNICATION SYSTEMS, IN-FLIGHT ENTERTAINMENT EQUIPMENT, FUEL TANK SYSTEMS AND POWER UNITS, CABIN SHELLS, SIDEWALLS AND PARTITIONS, AUDIO-VISUAL EQUIPMENT, FLIGHT DECK INSTRUMENTATION AND INSTRUMENTATION DISPLAY COMPONENTS, GLOBAL POSITIONING EQUIPMENT AND TRAFFIC COLLISION AVOIDANCE EQUIPMENT, AVIONICS SYSTEMS (U.S. CLS. 100, 103 AND 106).

CLASS 42—SCIENTIFIC, COMPUTER AND LEGAL SERVICES

FOR AIRCRAFT EQUIPMENT DESIGN AND AIRCRAFT INTERIOR DESIGN FOR THE CORPORATE AIRCRAFT INDUSTRY, NAMELY, DEVELOPING AND ENGINEERING AIRCRAFT AND CABIN FURNISHINGS, LIGHTING, COMMUNICATION SYSTEMS, IN-FLIGHT ENTERTAINMENT EQUIPMENT, FUEL TANK SYSTEMS AND POWER UNITS, CABIN SHELLS, SIDEWALLS AND PARTITIONS, AUDIO-VISUAL EQUIPMENT, FLIGHT DECK INSTRUMENTATION AND INSTRUMENTATION DISPLAY COMPONENTS, GLOBAL POSITIONING EQUIPMENT AND TRAFFIC COLLISION AVOIDANCE EQUIPMENT, AVIONICS SYSTEMS; ENGINEERING SERVICES; PRODUCT DEVELOPMENT SERVICES FOR OTHERS IN THE CORPORATE AIRCRAFT INDUSTRY; TESTING, ANALYSIS AND EVALUATION OF THE GOODS AND SERVICES OF OTHERS IN THE CORPORATE AIRCRAFT INDUSTRY FOR THE PURPOSE OF CERTIFICATION (U.S. CLS. 100 AND 101).

SN 76-221,933. 4 GIRLS, LLC, ORLANDO, FL. FILED 3-8-2001.



NO CLAIM IS MADE TO THE EXCLUSIVE RIGHT TO USE "CARD", APART FROM THE MARK AS SHOWN.

CLASS 9—ELECTRICAL AND SCIENTIFIC APPARATUS

FOR MAGNETIC ENCODED CARDS (U.S. CLS. 21, 23, 26, 36 AND 38).

CLASS 36—INSURANCE AND FINANCIAL

FOR FINANCIAL SERVICES, NAMELY ISSUING AND SERVICING PRE-PAID CARDS AND STORED VALUE CARDS AND PROVIDING FINANCIAL INFORMATION VIA A GLOBAL COMPUTER NETWORK (U.S. CLS. 100, 101 AND 102).

SN 76-221,934. 4 GIRLS, LLC, ORLANDO, FL. FILED 3-8-2001.

ZEOCARD

CLASS 9—ELECTRICAL AND SCIENTIFIC APPARATUS

FOR MAGNETIC ENCODED CARDS (U.S. CLS. 21, 23, 26, 36 AND 38).

CLASS 36—INSURANCE AND FINANCIAL

FOR FINANCIAL SERVICES, NAMELY, ISSUING AND SERVICING PRE-PAID CARDS AND STORED VALUE CARDS AND PROVIDING FINANCIAL INFORMATION VIA A GLOBAL COMPUTER NETWORK (U.S. CLS. 100, 101 AND 102).

SN 76-222,379. STRESSWAVE, INC., KENT, WA. FILED 3-8-2001.

STRESSWAVE

CLASS 35—ADVERTISING AND BUSINESS

FOR LICENSING OF TOOLS AND EQUIPMENT IN THE FIELD OF AUTOMATED MANUFACTURING, FASTENING, AND ASSEMBLY DEVICES, INCLUDING END EFFECTOR AND INDENTING DEVICES, RELATED TO METHODS AND APPARATUS FOR IMPROVING FATIGUE LIFE IN MATERIALS SUBJECT TO MECHANICAL STRESSES AND/OR CYCLIC LOADING (U.S. CLS. 100, 101 AND 102).

CLASS 42—SCIENTIFIC, COMPUTER AND LEGAL SERVICES

FOR CONSULTATION, ANALYSIS, PRODUCT AND MATERIAL DESIGN ASSISTANCE, PRODUCTION EVALUATION, AND THE LICENSING OF INTELLECTUAL PROPERTY RELATED TO METHODS AND APPARATUS FOR IMPROVING FATIGUE LIFE IN MATERIALS SUBJECT TO MECHANICAL STRESSES AND/OR CYCLIC LOADING (U.S. CLS. 100 AND 101).

SN 76-223,560. FROST INCORPORATED, GRAND RAPIDS, MI. FILED 3-13-2001.

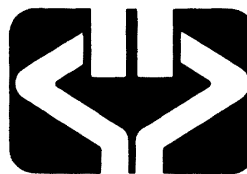

THE MARK CONSISTS OF A STYLIZED REPRESENTATION OF A PAIR OF TROLLEY WHEELS AND BRACKET ASSEMBLY.

CLASS 6—METAL GOODS

FOR METAL CHAINS, METAL CHAIN ATTACHMENT BRACKETS, CONVEYOR RAILS AND I-BEAMS (U.S. CLS. 2, 12, 13, 14, 23, 25 AND 50).

FIRST USE 0-0-1982; IN COMMERCE 0-0-1982.

CLASS 7—MACHINERY

FOR MATERIAL HANDLING MACHINES AND SYSTEM COMPONENTS, NAMELY, CONVEYORS AND REPLACEMENT PARTS THEREFOR, CONVEYOR WHEELS, CONVEYOR ROLLERS, CAM FOLLOWERS, TROLLEY WHEELS, BALL BEARINGS, ROLLER BEARINGS, NEEDLE BEARINGS, BRACKETS, TROLLEY BRACKETS AND LUBRICATORS (U.S. CLS. 13, 19, 21, 23, 31, 34 AND 35).

FIRST USE 0-0-1982; IN COMMERCE 0-0-1982.

SN 76-223,982. PATERSON ARRAN LIMITED, WEST LOTHIAN, SCOTLAND, UNITED KINGDOM, FILED 3-14-2001.

BRONTE

OWNER OF UNITED KINGDOM REG. NO. 2208316, DATED 9-22-2000, EXPIRES 9-11-2009.

OWNER OF UNITED KINGDOM REG. NO. B1540661, DATED 2-2-1996, EXPIRES 7-3-2010.

CLASS 29—MEATS AND PROCESSED FOODS

FOR MARMALADES AND PRESERVES (U.S. CL. 46).

CLASS 30—STAPLE FOODS

FOR BISCUITS, SHORTBREAD, COOKIES, OAT-CAKES, SHORTCAKE, MUSTARDS AND CHUTNEYS (U.S. CL. 46).

SN 76-224,572. ASCII GROUP, INC., THE, BETHESDA, MD.
FILED 3-14-2001.



CLASS 35—ADVERTISING AND BUSINESS

FOR PROMOTING THE GOODS AND SERVICES OF OTHERS IN THE FIELD OF COMPUTER GOODS AND SERVICES THROUGH ADVERTISEMENTS ON CUSTOMIZED WEBSITES OVER A GLOBAL COMPUTER NETWORK, AND OPERATING AN ELECTRONIC MARKET PLACES FOR SELLERS OF GOODS AND SERVICES IN THE FIELD OF COMPUTER GOODS AND SERVICES OVER A GLOBAL COMPUTER NETWORK; PROVIDING A WEBSITE USED TO PLACE ONLINE ORDERS IN THE FIELD OF COMPUTER PRODUCTS AND SERVICES (U.S. CLS. 100, 101 AND 102).

CLASS 42—SCIENTIFIC, COMPUTER AND LEGAL SERVICES

FOR PROVIDING A WEBSITE FEATURING INFORMATION IN THE FIELD OF COMPUTERS (U.S. CLS. 100 AND 101).

SN 76-224,752. RTR PACKAGING CORP., NEW YORK, NY.
FILED 3-15-2001.

MONKEY RESEARCH

CLASS 16—PAPER GOODS AND PRINTED MATTER

FOR PAPER, PLASTIC, AND VINYL SHOPPING BAGS (U.S. CLS. 2, 5, 22, 23, 29, 37, 38 AND 50).

CLASS 18—LEATHER GOODS

FOR TEXTILE SHOPPING BAGS (U.S. CLS. 1, 2, 3, 22 AND 41).

CLASS 35—ADVERTISING AND BUSINESS

FOR ADVERTISING SERVICES, NAMELY, CREATING MARKETING CONCEPTS THAT ENABLE CLIENTS TO MAXIMIZE THEIR PROMOTIONAL POTENTIAL THROUGH USE OF SHOPPING BAGS AND PACKAGING MATERIALS, NAMELY, BAGS, BOXES, WRAPPING TISSUE, RIBBONS, AND GIFTWRAP (U.S. CLS. 100, 101 AND 102).

CLASS 42—SCIENTIFIC, COMPUTER AND LEGAL SERVICES

FOR CUSTOMIZED PRINTING SERVICES, NAMELY, DESIGNING AND PRINTING ADVERTISING AND PROMOTIONAL INFORMATION FOR OTHERS ON PAPER, PLASTIC, FABRIC AND VINYL SHOPPING BAGS AND PACKAGING MATERIAL, NAMELY, BAGS, BOXES, WRAPPING TISSUE, RIBBONS AND GIFTWRAP (U.S. CLS. 100 AND 101).

SN 76-224,970. VALOR TELECOMMUNICATIONS, LLC.,
WASHINGTON, DC. FILED 3-15-2001.

SERVING NEW MEXICO WITH PRIDE

CLASS 16—PAPER GOODS AND PRINTED MATTER

FOR PUBLICATIONS, NAMELY TELEPHONE DIRECTORIES (U.S. CLS. 2, 5, 22, 23, 29, 37, 38 AND 50).
FIRST USE 9-1-2000; IN COMMERCE 9-1-2000.

CLASS 38—COMMUNICATION

FOR LOCAL, LONG DISTANCE AND ENHANCED TELECOMMUNICATIONS SERVICES, NAMELY, THE ELECTRONIC TRANSMISSION OF MESSAGES, DATA, VOICE AND VIDEO (U.S. CLS. 100, 101 AND 104).
FIRST USE 9-1-2000; IN COMMERCE 9-1-2000.

SN 76-224,971. VALOR TELECOMMUNICATIONS, LLC.,
WASHINGTON, DC. FILED 3-15-2001.

SERVING OKLAHOMA WITH PRIDE

CLASS 16—PAPER GOODS AND PRINTED MATTER

FOR PUBLICATIONS, NAMELY TELEPHONE DIRECTORIES (U.S. CLS. 2, 5, 22, 23, 29, 37, 38 AND 50).
FIRST USE 7-1-2000; IN COMMERCE 7-1-2000.

CLASS 38—COMMUNICATION

FOR LOCAL, LONG DISTANCE AND ENHANCED TELECOMMUNICATIONS SERVICES, NAMELY, THE ELECTRONIC TRANSMISSION OF MESSAGES, DATA, VOICE AND VIDEO (U.S. CLS. 100, 101 AND 104).
FIRST USE 7-1-2000; IN COMMERCE 7-1-2000.

SN 76-224,973. VALOR TELECOMMUNICATIONS, LLC.,
WASHINGTON, DC. FILED 3-15-2001.

SERVING TEXAS WITH PRIDE

CLASS 16—PAPER GOODS AND PRINTED MATTER

FOR PUBLICATIONS, NAMELY TELEPHONE DIRECTORIES (U.S. CLS. 2, 5, 22, 23, 29, 37, 38 AND 50).
FIRST USE 9-1-2000; IN COMMERCE 9-1-2000.

CLASS 38—COMMUNICATION

FOR LOCAL, LONG DISTANCE AND ENHANCED TELECOMMUNICATIONS SERVICES, NAMELY, THE ELECTRONIC TRANSMISSION OF MESSAGES, DATA, VOICE AND VIDEO (U.S. CLS. 100, 101 AND 104).
FIRST USE 9-1-2000; IN COMMERCE 9-1-2000.

SN 76-225,000. MASTERCARD INTERNATIONAL INCORPORATED, PURCHASE, NY. FILED 3-12-2001.



OWNER OF U.S. REG. NOS. 1,186,117, 1,292,519 AND 1,604,606.

NO CLAIM IS MADE TO THE EXCLUSIVE RIGHT TO USE "SMALL BUSINESS", APART FROM THE MARK AS SHOWN.

CLASS 35—ADVERTISING AND BUSINESS

FOR PROMOTING THE SALE OF THE GOODS AND SERVICES OF OTHERS THROUGH ELECTRONIC LINKS TO MERCHANTS AND RETAILER WEB SITES (U.S. CLS. 100, 101 AND 102).

FIRST USE 12-0-1999; IN COMMERCE 12-0-1999.

CLASS 36—INSURANCE AND FINANCIAL

FOR FINANCIAL SERVICES, NAMELY, PROVIDING CREDIT CARD, DEBIT CARD AND CHARGE CARD SERVICES, CASH ADVANCES RENDERED BY CREDIT OR DEBIT CARDS; ELECTRONIC FUNDS AND CURRENCY TRANSFER SERVICES; AUTOMATED TELLER MACHINE SERVICE; AND TRANSACTION AUTHORIZATION AND SETTLEMENT SERVICES (U.S. CLS. 100, 101 AND 102).

FIRST USE 12-0-1999; IN COMMERCE 12-0-1999.

SN 76-225,070. HEALTH CRAFT, INC., TAMPA, FL. FILED 3-15-2001.

SILVER CLASSIC

OWNER OF U.S. REG. NOS. 2,006,804, 2,315,069 AND 2,322,055.

NO CLAIM IS MADE TO THE EXCLUSIVE RIGHT TO USE "SILVER", APART FROM THE MARK AS SHOWN.

CLASS 8—HAND TOOLS

FOR FLATWARE, NAMELY KNIVES, FORKS, SPOONS AND SALAD TONGS (U.S. CLS. 23, 28 AND 44).

CLASS 21—HOUSEWARES AND GLASS

FOR TABLEWARE, NAMELY, DISHES, PLATES, SAUCERS, CUPS, BOWLS, PLATTERS, CREAMERS, TRAYS, SUGAR DISHES, BUTTER DISHES, SERVING SPOONS AND CAKE/PIE SERVER; AND BAKEWARE FOR KITCHEN USE (U.S. CLS. 2, 13, 23, 29, 30, 33, 40 AND 50).

SN 76-225,634. NEW.NET, INC., SHERMAN OAKS, CA. FILED 3-19-2001.



CLASS 35—ADVERTISING AND BUSINESS

FOR COMMERCIAL INFORMATION AND DIRECTORY AGENCY SERVICES VIA THE INTERNET FEATURING DIRECTORIES FOR LOCATING DOMAIN NAMES AND DEMOGRAPHIC INFORMATION ENTITIES; COMPUTER SERVICES, NAMELY, PROVIDING A DIRECTORY OF BUSINESS ORGANIZATION AND BUSINESS RESOURCES (U.S. CLS. 100, 101 AND 102).

CLASS 42—SCIENTIFIC, COMPUTER AND LEGAL SERVICES

FOR PROVIDING A DIRECTORY OF PERSONAL ADDRESSES (U.S. CLS. 100 AND 101).

SN 76-225,837. IMMUNE SOLUTIONS, INC., SAN FRANCISCO, CA. FILED 3-15-2001.

BRIGHTERION

CLASS 9—ELECTRICAL AND SCIENTIFIC APPARATUS

FOR COMPUTER SOFTWARE TO PREVENT COMPUTER NETWORK-BASED FRAUD, NAMELY, SOFTWARE THAT EXAMINERS TRANSACTIONAL DATA TO DETECT BEHAVIOR INDICATIVE OF FRAUDULENT ACTIVITY; AND FILTERING SOFTWARE DESIGNED TO BLOCK USERS FROM GAINING ACCESS TO WEBSITES HAVING SPECIFIED CONTENT (U.S. CLS. 21, 23, 26, 36 AND 38).

CLASS 42—SCIENTIFIC, COMPUTER AND LEGAL SERVICES

FOR PROVIDING COMPUTER NETWORK SECURITY TECHNOLOGY CONSULTING SERVICES (U.S. CLS. 100 AND 101).

SN 76-228,445. SIEMENS AKTIENGESELLSCHAFT, MUNCHEN, FED REP GERMANY, FILED 3-21-2001.

LITHOSHARE

PRIORITY CLAIMED UNDER SEC. 44(D) ON FED REP GERMANY APPLICATION NO. 30084567.7/1, FILED 11-16-2000, REG. NO. 30084567, DATED 1-2-2001, EXPIRES 11-30-2010.

CLASS 9—ELECTRICAL AND SCIENTIFIC APPARATUS

FOR MEDICAL DEVICES FOR USE IN THE DIAGNOSIS AND TREATMENT OF UROLOGICAL DISEASE, NAMELY, COMPUTERS AND COMPUTER SOFTWARE FOR USE IN RECORDING, TRANSMITTING, EVALUATING AND DISPLAYING DATA OBTAINED FROM MEDICAL, ELECTROMEDICAL AND SURGICAL DEVICES (U.S. CLS. 21, 23, 26, 36 AND 38).

CLASS 10—MEDICAL APPARATUS

FOR MEDICAL, ELECTROMEDICAL AND SURGICAL DEVICES AND APPLIANCES FOR THE DIAGNOSIS AND TREATMENT OF UROLOGICAL DISEASES, NAMELY, DIAGNOSIS AND TREATMENT SYSTEMS COMPRISED OF LITHOTRIPSY DEVICES, X-RAY AND FLUOROSCOPIC IMAGING DEVICES, ULTRASOUND DEVICES AND PROBES, PROSTATE THERMOTHERAPY DEVICES AND ENDOSCOPES AND VARIOUS COMBINATIONS OF SOME OR ALL OF THESE DEVICES (U.S. CLS. 26, 39 AND 44).

SN 76-229,180. PEPSICO, INC., PURCHASE, NY. FILED 3-23-2001.



THE MARK CONSISTS OF THE WORDING "FRESQUI-BON" AND A LEAF.
THE ENGLISH TRANSLATION OF THE MARK IS "FRESH GOOD".

CLASS 30—STAPLE FOODS

FOR FLAVORED LIQUID SOLD IN PACKAGES TO BE FROZEN THEREIN FOR MAKING FROZEN CONFECTIONS (U.S. CL. 46).

CLASS 32—LIGHT BEVERAGES

FOR FRUIT FLAVORED SOFT DRINKS AND SYRUPS AND POWDERED MIXES FOR MAKING SOFT DRINKS (U.S. CLS. 45, 46 AND 48).

SN 76-230,096. RIVERSOFT TECHNOLOGIES LIMITED, RICHMOND, SURREY, TW9 4LN, UNITED KINGDOM, FILED 3-26-2001.

NMOS

CLASS 9—ELECTRICAL AND SCIENTIFIC APPARATUS

FOR COMPUTER PROGRAMS AND SOFTWARE FOR NETWORK DISCOVERY, MONITORING, AND POLLING IN THE FIELD OF NETWORK MANAGEMENT; COMPUTER PROGRAMS FOR NETWORK DISCOVERY, MONITORING, AND POLLING IN THE FIELD OF NETWORK MANAGEMENT AND DATA IN THE FIELD OF INFORMATION TECHNOLOGY RECORDED IN COMPUTER ACCESSIBLE FORM, NAMELY CD-ROM; SOFTWARE RELATING TO THE MANAGEMENT OF DEVICES AND SERVICES IN A COMMUNICATIONS NETWORK (U.S. CLS. 21, 23, 26, 36 AND 38).

CLASS 42—SCIENTIFIC, COMPUTER AND LEGAL SERVICES

FOR COMPUTER SERVICES, NAMELY DESIGN AND INSTALLATION OF COMPUTER SOFTWARE; TECHNICAL CONSULTANCY SERVICES IN RESPECT OF SOFTWARE RELATING TO THE MANAGEMENT OF DEVICES AND SERVICES IN A COMMUNICATIONS NETWORK; TECHNICAL CONSULTANCY SERVICES RELATING TO COMPUTER SOFTWARE AND COMPUTER DESIGN; MAINTENANCE OF COMPUTER SOFTWARE; UPDATING AND UPGRADING OF COMPUTER SOFTWARE; PROVIDING INFORMATION VIA AN INTERNET WEBSITE RELATING TO INFORMATION TECHNOLOGY, COMPUTERS, COMPUTER SOFTWARE, COMPUTER SYSTEMS AND COMPUTER NETWORKS; TECHNICAL CONSULTANCY AND ADVISORY SERVICES RELATING TO DESIGN AND INSTALLATION OF COMPUTER SOFTWARE (U.S. CLS. 100 AND 101).

SN 76-230,679. PRIMELAYER SOFTWARE, INC., DOVER, DE. FILED 3-26-2001.

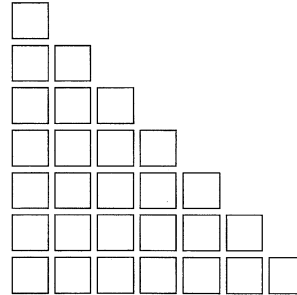
**CLASS 9—ELECTRICAL AND SCIENTIFIC APPARATUS**

FOR COMPUTER SOFTWARE AND EMBEDDED COMPUTER SOFTWARE FOR USE IN MANAGING, DRIVING AND CONTROLLING PROCESSOR-BASED COMMUNICATIONS PRODUCTS IN THE FIELD OF COMMUNICATIONS AND NETWORKING; DOWNLOADABLE SOFTWARE FOR INTEGRATION INTO COMMUNICATIONS APPARATUS AND COMMUNICATIONS PRODUCTS, FOR USE IN MANAGING, DRIVING, AND CONTROLLING PROCESSOR-BASED COMMUNICATIONS PRODUCTS IN THE FIELD OF COMMUNICATIONS AND NETWORKING; COMPUTER SOFTWARE AND EMBEDDED COMPUTER SOFTWARE FOR USE IN DEVELOPING, CONFIGURING, MANUFACTURING AND INSTALLING PROCESSOR-BASED COMMUNICATIONS PRODUCTS IN THE FIELD OF COMMUNICATIONS AND NETWORKING; DOWNLOADABLE SOFTWARE FOR INTEGRATION INTO COMMUNICATIONS APPARATUS AND COMMUNICATIONS PRODUCTS, FOR USE IN DEVELOPING, CONFIGURING, MANUFACTURING AND INSTALLING PROCESSOR-BASED COMMUNICATIONS PRODUCTS IN THE FIELD OF COMMUNICATIONS AND NETWORKING; AND INTEGRATED CIRCUITS FOR USE IN THE FIELD OF COMMUNICATIONS AND NETWORKING (U.S. CLS. 21, 23, 26, 36 AND 38).

CLASS 42—SCIENTIFIC, COMPUTER AND LEGAL SERVICES

FOR COMPUTER PROGRAMMING SERVICES FOR OTHERS; TECHNICAL CONSULTING AND ASSISTANCE SERVICES, NAMELY, DESIGN AND DEVELOPMENT OF COMPUTER SOFTWARE AND HARDWARE FOR OTHERS, AND RESEARCH RELATING THERETO, IN THE FIELD OF COMMUNICATIONS AND NETWORKING (U.S. CLS. 100 AND 101).

SN 76-230,865. WAGAMAMA LIMITED, LONDON W1N 7PA, UNITED KINGDOM. FILED 3-13-2001.

POSITIVE EATING + POSITIVE LIVING

CLASS 25—CLOTHING

FOR CLOTHING, FOOTWEAR AND HEADWEAR, NAMELY, SWEAT SUITS, SWEATSHIRTS, SWEAT TROUSERS, SCARVES, T-SHIRTS, SOCKS, SHORTS, SHIRTS AND CASUAL JACKETS (U.S. CLS. 22 AND 39).

CLASS 42—SCIENTIFIC, COMPUTER AND LEGAL SERVICES

FOR CAFES AND CAFETERIA SERVICES; CANTEEN SERVICES; CATERING SERVICES; RESTAURANTS AND SELF-SERVICE RESTAURANT SERVICES; SNACK BARS (U.S. CLS. 100 AND 101).

SN 76-232,146. TEAM WORK CORPORATION LIMITED, QUARRY BAY, HONG KONG, FILED 3-28-2001.



THE MARK CONSISTS OF THE TERM "TEAMWORK" IN STYLIZED LETTERING CONTAINED IN A RECTANGLE.

CLASS 35—ADVERTISING AND BUSINESS

FOR ARTIST MANAGEMENT; TALENT AGENCIES (U.S. CLS. 100, 101 AND 102).

CLASS 41—EDUCATION AND ENTERTAINMENT

FOR ORGANIZATION OF ENTERTAINMENT COMPETITIONS IN THE FIELDS OF MUSIC, THEATRE AND MOTION PICTURES; MOTION PICTURE FILM PRODUCTION; PRODUCTION OF RADIO AND TELEVISION PROGRAMS; PRODUCTION OF MUSICAL AND THEATRICAL SHOWS; PRODUCTION OF CONCERTS; THEATRE PRODUCTIONS; PRODUCTION OF AUDIO RECORDS AND VIDEOS (U.S. CLS. 100, 101 AND 107).

SN 76-232,421. E.K. SUCCESS, LTD., CLIFTON, NJ. FILED 3-29-2001.

ANGLGRL22

CLASS 3—COSMETICS AND CLEANING PREPARATIONS

FOR COSMETICS, NAMELY, CLEANSING PREPARATIONS, NAMELY, SKIN CLEANSERS; PERSONAL DEODORANTS; NAIL POLISH; LIPSTICK; LIP LINER; EYE SHADOW; EYE PENCIL; EYE LINER; EYEBROW PENCILS; FACE POWDER; BLUSH; PERFUME; BUBBLE BATH; SKIN AND HAIR CONDITIONERS; SKIN MOISTURIZER; SHOWER GEL; LIQUID SOAP; BODY SPRITZER; AND TALCUM POWDER (U.S. CLS. 1, 4, 6, 50, 51 AND 52).

CLASS 8—HAND TOOLS

FOR CUTLERY, NAMELY, FLATWARE (U.S. CLS. 23, 28 AND 44).

CLASS 9—ELECTRICAL AND SCIENTIFIC APPARATUS

FOR SUNGLASSES; VIDEOTAPES, CD-ROMS, AUDIO-TAPES, PRERECORDED TAPES, AND COMPACT DISCS FEATURING ANIMATED GIRL CHARACTERS; PHOTOGRAPHIC CAMERAS AND EXPOSED CAMERA FILM; BLANK MAGNETIC DATA CARRIERS; PHOTOGRAPHIC PROJECTORS; BLANK ELECTRONIC CHIP CARDS; VIDEO GAME CARTRIDGES AND VIDEO GAMES DISCS, COMPUTER GAME PROGRAMS AND COMPUTER GAME SOFTWARE AND COMPUTER GAMES TAPES; DECORATIVE REFRIGERATOR MAGNETS, AND COVER FOR WIRELESS PHONES (U.S. CLS. 21, 23, 26, 36 AND 38).

CLASS 11—ENVIRONMENTAL CONTROL APPARATUS

FOR LAMPS AND LAMP SHADES (U.S. CLS. 13, 21, 23, 31 AND 34).

CLASS 14—JEWELRY

FOR JEWELRY, CLOCKS, WATCHES, WRIST WATCHES, CUFF LINKS, TIE PINS (U.S. CLS. 2, 27, 28 AND 50).

CLASS 16—PAPER GOODS AND PRINTED MATTER

FOR WRITING INSTRUMENTS, NAMELY, PENS, PENCILS, MARKERS, CRAYONS; STICKERS; STICKER BINDERS; STICKER BOOKS; NOTE BOOKS; NOTEBOOKS AND NECKLACE COMBINATIONS SOLD TOGETHER AS A UNIT; DRAWING AND DRAFTING RULERS; WIRE BOUND THEME BOOKS; PENCIL SHARPENERS; PAPER POUCHES FOR PACKAGING; STATIONERY SETS; ERASERS; ADDRESS BOOKS, JOURNALS; TEMPORARY TATTOOS; DAILY JOURNAL PLANNERS; CHILDREN'S BOOKS; PAMPHLETS, BROCHURES, AND NEWSLETTERS FOR CHILDREN ABOUT GIRL CARTOON CHARACTERS; PAPER PARTY BAGS, PAPER PARTY DECORATIONS, AND PAPER PARTY HATS (U.S. CLS. 2, 5, 22, 23, 29, 37, 38 AND 50).

CLASS 18—LEATHER GOODS

FOR TRUNK AND TRAVELING BAGS, UMBRELLAS, PARASOLS, LEATHER BACKPACKS AND LEATHER SHOPPING BAGS, ALL PURPOSE SPORTS BAGS, RUCKSACKS, WALKING STICKS, HOLDALLS, COSMETIC BAGS AND CASES SOLD EMPTY (U.S. CLS. 1, 2, 3, 22 AND 41).

CLASS 20—FURNITURE AND ARTICLES NOT OTHERWISE CLASSIFIED

FOR NON-METAL KEY CHAINS (U.S. CLS. 2, 13, 22, 25, 32 AND 50).

CLASS 21—HOUSEWARES AND GLASS

FOR CONTAINERS FOR HOUSEHOLD OR KITCHEN USE, PLATES, DRINKING GLASSES, CUPS, MUGS, ORNAMENTS MADE OF CERAMIC, HAIR BRUSHES AND COMBS, NAIL BRUSHES, AND HOUSEHOLD UTENSILS, NAMELY, POT AND PAN SCRAPERS, ROLLING PINS, SPATULAS, TURNERS, AND WHISKS (U.S. CLS. 2, 13, 23, 29, 30, 33, 40 AND 50).

CLASS 24—FABRICS

FOR TABLECLOTHS, BED SHEETS, TEXTILE NAPKINS AND PLACE MATS (U.S. CLS. 42 AND 50).

CLASS 25—CLOTHING

FOR CLOTHING, NAMELY, T-SHIRTS, DRESSES, HATS, SWIMWEAR, FOOTWEAR, SOCKS, TIES AND SLIPPERS (U.S. CLS. 22 AND 39).

CLASS 26—FANCY GOODS

FOR HAIR BANDS, CLOTHING BUCKLES, HAIR BUCKLES, AND SHOE BUCKLES, BELT AND CLOTHING CLASPS (U.S. CLS. 37, 39, 40, 42 AND 50).

CLASS 28—TOYS AND SPORTING GOODS

FOR TOYS, NAMELY, DOLLS, BOARD GAMES, PLUSH TOYS, MOBILES, GYMNAS TIC APPARATUS, SPORTING ARTICLES, NAMELY, BASEBALLS, SOFTBALLS, BASKETBALLS, CHRISTMAS TREE DECORATIONS, JIGSAW PUZZLES, TEDDY BEARS, BALLOONS, BODYBUILDING APPARATUS, NAMELY, EXERCISE BARS, AND EXERCISE BENCHES, GLOVES FOR GAMES, NAMELY, BASEBALL, SOFTBALL, AND GOLF GLOVES, HANDHELD UNIT FOR PLAYING ELECTRONIC GAMES, CARD GAMES, BAGS ADAPTED FOR HOLDING SPORTS EQUIPMENT, NAMELY, BASEBALL, SOFTBALL, AND GOLF (U.S. CLS. 22, 23, 38 AND 50).

CLASS 30—STAPLE FOODS

FOR FROZEN CONFECTIONS AND FLAVORED ICES, CHOCOLATE, COFFEE, TEA, COCOA, CEREAL BASED SNACK FOOD, READY TO EAT CEREAL DERIVED FOOD BARS, BREAD, CHOCOLATE EGGS, CONFECTIONERY SUGAR (U.S. CL. 46).

CLASS 41—EDUCATION AND ENTERTAINMENT

FOR PRODUCTION OF RADIO AND TELEVISION PROGRAMS, PRODUCTION OF VIDEOTAPE, PUBLICATION OF BOOKS, TEXT AND PRINTED MATTER, NAMELY, ANIMATED CHARACTERS; THEATER PRODUCTIONS, MOTION PICTURE FILM PRODUCTION, ORGANIZATION OF EXHIBITIONS FOR ENTERTAINMENT PURPOSES, ARRANGING AND CONDUCTING OF SPORTS COMPETITIONS, LIVE PERFORMANCES BY A MUSICAL BAND; ENTERTAINMENT, NAMELY A CONTINUING CARTOON SHOW DISTRIBUTED OVER TELEVISION (U.S. CLS. 100, 101 AND 107).

SN 76-232,999. CO-OP AMERICA FOUNDATION, INC., WASHINGTON, DC. FILED 3-30-2001.

WOODWISE**CLASS 9—ELECTRICAL AND SCIENTIFIC APPARATUS**

FOR DOWNLOADABLE ELECTRONIC PUBLICATIONS, NAMELY GUIDEBOOKS, INSTRUCTIONAL MATERIALS, AND DIRECTORIES IN THE FIELD OF ENVIRONMENTALLY RESPONSIBLE PAPER, PAPER SUBSTITUTES, AND OTHER FOREST PRODUCTS AND ADVICE FOR REDUCING CONSUMPTION THEREOF (U.S. CLS. 21, 23, 26, 36 AND 38).

FIRST USE 0-0-1998; IN COMMERCE 0-0-1998.

CLASS 16—PAPER GOODS AND PRINTED MATTER

FOR PUBLICATIONS, NAMELY GUIDEBOOKS, INSTRUCTIONAL MATERIALS, AND DIRECTORIES IN THE FIELD OF ENVIRONMENTALLY RESPONSIBLE PAPER, PAPER SUBSTITUTES, AND OTHER FOREST PRODUCTS AND ADVICE FOR REDUCING CONSUMPTION THEREOF (U.S. CLS. 2, 5, 22, 23, 29, 37, 38 AND 50).

FIRST USE 0-0-1998; IN COMMERCE 0-0-1998.

SN 76-233,391. MORONGO BAND OF MISSION INDIANS, BANNING, CA. FILED 3-30-2001.



NO CLAIM IS MADE TO THE EXCLUSIVE RIGHT TO USE "CASINO", APART FROM THE MARK AS SHOWN.

CLASS 32—LIGHT BEVERAGES

FOR DRINKING WATER (U.S. CLS. 45, 46 AND 48). FIRST USE 0-0-1998; IN COMMERCE 0-0-1998.

CLASS 41—EDUCATION AND ENTERTAINMENT

FOR ENTERTAINMENT IN THE NATURE OF A CASINO FACILITY (U.S. CLS. 100, 101 AND 107). FIRST USE 0-0-1994; IN COMMERCE 1-0-1994.

SN 76-233,679. WEAVER, LISA MICHELLE, FAIRFIELD, CA. FILED 4-2-2001.



THE DESIGN CONSISTS OF A PREGNANT WOMAN LAYING ON HER SIDE RESTING ON A BED MADE OF THE WORDS "BED REST BABIES".

CLASS 37—CONSTRUCTION AND REPAIR

FOR PERSONALIZED DOMESTIC HOME HELP SERVICE FOR PREGNANT WOMEN, NAMELY HOME CLEANING (U.S. CLS. 100, 103 AND 106).

CLASS 39—TRANSPORTATION AND STORAGE

FOR TRANSPORTATION TO MEDICAL VISITS VIA AUTOMOBILE FOR PREGNANT WOMEN (U.S. CLS. 100 AND 105).

CLASS 42—SCIENTIFIC, COMPUTER AND LEGAL SERVICES

FOR PERSONALIZED DOMESTIC HOME HELP SERVICE FOR PREGNANT WOMEN, NAMELY PERSONAL GROCERY SHOPPING FOR OTHERS, FOOD PREPARATION, HOME CHILD CARE, AND ERRAND RUNNING TO THE POST OFFICE, PHARMACY, DRY CLEANERS, AND GROCERY STORE (U.S. CLS. 100 AND 101).

SN 76-236,812. CMP MEDIA LLC, MANHASSET, NY. FILED 4-5-2001.

CMP TECHNOLOGY

NO CLAIM IS MADE TO THE EXCLUSIVE RIGHT TO USE "TECHNOLOGY", APART FROM THE MARK AS SHOWN.

SN 76-234,518. RUBBEMETWORK.COM, LLC, ATLANTA, GA. FILED 4-2-2001.

WHERE VALUE DRIVES BUSINESS**CLASS 9—ELECTRICAL AND SCIENTIFIC APPARATUS**

FOR E-COMMERCE SOFTWARE TO ALLOW USERS TO PERFORM ELECTRONIC BUSINESS-TO-BUSINESS TRANSACTIONS VIA THE INTERNET (U.S. CLS. 21, 23, 26, 36 AND 38).

CLASS 16—PAPER GOODS AND PRINTED MATTER

FOR PRINT PUBLICATIONS, NAMELY, MAGAZINES IN THE FIELD OF HIGH TECHNOLOGY (U.S. CLS. 2, 5, 22, 23, 29, 37, 38 AND 50).

CLASS 42—SCIENTIFIC, COMPUTER AND LEGAL SERVICES

FOR ONLINE INFORMATION SERVICES, NAMELY, PROVIDING INFORMATION IN THE FIELD OF THE HIGH TECHNOLOGY AND INFORMATION TECHNOLOGY INDUSTRIES VIA THE INTERNET (U.S. CLS. 100 AND 101).

CLASS 35—ADVERTISING AND BUSINESS

FOR PROVIDING ELECTRONIC BUSINESS-TO-BUSINESS COMMERCE SERVICES, NAMELY, ON-LINE FACILITIES FOR THE ADVERTISING, SELLING, NEGOTIATION, PURCHASING, AUCTIONING, AND TRADING OF GOODS AND SERVICES BY BUSINESSES AND THEIR SUPPLIERS VIA A MULTI-USER GLOBAL COMPUTER INFORMATION NETWORK (U.S. CLS. 100, 101 AND 102).

SN 76-237,205. DIRK ZELLER, P.C., BEND, OR. FILED 4-9-2001.

SALES CHAMPIONS

NO CLAIM IS MADE TO THE EXCLUSIVE RIGHT TO USE "SALES", APART FROM THE MARK AS SHOWN.

SN 76-235,143. RAD-SPORT-ARNOLD GMBH, D-56073 KOBLENZ, FED REP GERMANY, FILED 4-4-2001.

ERGOSPEED**CLASS 12—VEHICLES**

FOR BICYCLES, BICYCLE FRAMES, BICYCLE ACCESSORIES, NAMELY WHEELS, RIMS, TIRES, GEARS, BRAKES, BRAKE LININGS, BRAKE GRIPS, PEDALS, CHAINS, LUGGAGE CARRIERS, CHILD SEATS, SADDLES, SADDLE SUPPORTS, TRAILER COUPLINGS, SHOCK ABSORBERS, VIBRATION DAMPERS, REAR-VIEW MIRRORS, HORNS, BELLS, FRONT PARTS, HUBS, PINIONS, CHAIN BLADES, CRANKS, BOTTLE HOLDERS, GEARSHIFTS, HANDLE BAR TAPES, HANDLE BARS, HANDLE BAR TOPS, HANDLE GRIPS, GEARSHIFT HANDLE GRIPS, SAFETY AND RETAINING BELTS, BICYCLE FORKS, BAG AND BOTTLE HOLDERS, BICYCLE AIR PUMPS (U.S. CLS. 19, 21, 23, 31, 35 AND 44).

CLASS 35—ADVERTISING AND BUSINESS

FOR BUSINESS MANAGEMENT CONSULTATION (U.S. CLS. 100, 101 AND 102).

FIRST USE 6-1-1998; IN COMMERCE 6-1-1998.

CLASS 41—EDUCATION AND ENTERTAINMENT

FOR EDUCATIONAL SERVICES, NAMELY PROVIDING SALES TRAINING SERVICES (U.S. CLS. 100, 101 AND 107).

FIRST USE 6-1-1998; IN COMMERCE 6-1-1998.

SN 76-237,339. VOLVO PERSONVAGNAR AB, GOTEBORG, SWEDEN, FILED 4-10-2001.

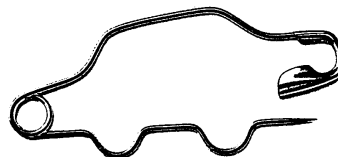
**CLASS 42—SCIENTIFIC, COMPUTER AND LEGAL SERVICES**

FOR ENGINEERING CONSULTING SERVICES WITH ATHLETES ON THE USE AND MOUNTING OF BICYCLES, BICYCLE PARTS AND ACCESSORIES AND THE ADAPTION BY THE ATHLETES OF INDIVIDUAL BICYCLE COMPONENTS TO INDIVIDUAL PREFERENCES, DEPENDING ON THE BODY MEASUREMENTS AND WEIGHT OF THE ATHLETES (U.S. CLS. 100 AND 101).

THE MARK CONSISTS OF A FANCIFUL DEPICTION OF A SAFETY PIN IN THE SHAPE OF AN AUTOMOBILE.

CLASS 12—VEHICLES

FOR HIGHWAY TRUCKS AND TRACTORS, BUSES AND AUTOMOBILES AND STRUCTURAL PARTS FOR SUCH HIGHWAY TRUCKS AND TRACTORS, BUSES AND AUTOMOBILES (U.S. CLS. 19, 21, 23, 31, 35 AND 44).

CLASS 16—PAPER GOODS AND PRINTED MATTER

FOR PRINTED PROMOTIONAL ITEMS, NAMELY, MAGAZINES, CATALOGUES, AND NEWSLETTERS CONTAINING INFORMATION ABOUT AUTOMOBILES, BUSES AND OVER-THE-HIGHWAY TRUCKS AND TRACTORS (U.S. CLS. 2, 5, 22, 23, 29, 37, 38 AND 50).

CLASS 25—CLOTHING

FOR SWEATSHIRTS, T-SHIRTS, HEADGEAR, NAMELY, HATS AND FOOTWEAR (U.S. CLS. 22 AND 39).

CLASS 41—EDUCATION AND ENTERTAINMENT

FOR PARTY PLANNING FOR THE PURPOSES OF PROMOTING VEHICLE SAFETY (U.S. CLS. 100, 101 AND 107).

SN 76-237,645. CLAIRE'S BOUTIQUES INC., HOFFMAN ESTATES, IL. FILED 4-9-2001.

DRIVING DIVA**CLASS 12—VEHICLES**

FOR STEERING WHEEL COVERS AND SEATBELT COVERS (U.S. CLS. 19, 21, 23, 31, 35 AND 44).

CLASS 20—FURNITURE AND ARTICLES NOT OTHERWISE CLASSIFIED

FOR NOVELTY WINDSHIELD DECORATIONS IN THE NATURE OF STUFFED DICE (U.S. CLS. 2, 13, 22, 25, 32 AND 50).

SN 76-237,674. TRIANTAFILLOU, NICK, OMAHA, NE. FILED 4-9-2001.

KING KONG

OWNER OF U.S. REG. NOS. 2,382,076 AND 2,422,491.

CLASS 41—EDUCATION AND ENTERTAINMENT

FOR ENTERTAINMENT SERVICES, NAMELY, ENTERTAINMENT IN THE NATURE OF AMUSEMENT PARKS AND RIDES (U.S. CLS. 100, 101 AND 107).

CLASS 42—SCIENTIFIC, COMPUTER AND LEGAL SERVICES

FOR HOTEL, RESTAURANT AND BAR SERVICES (U.S. CLS. 100 AND 101).

SN 76-237,721. KOHLBRAT & BUNZ GESELLSCHAFT M.B.H., A-5550 RADSTADT, AUSTRIA, FILED 4-9-2001.

REDEVAC

PRIORITY CLAIMED UNDER SEC. 44(D) ON AUSTRIA APPLICATION NO. AM7371/2000, FILED 10-10-2000, REG. NO. 195260, DATED 4-5-2001, EXPIRES 4-30-2010.

CLASS 9—ELECTRICAL AND SCIENTIFIC APPARATUS

FOR LIFE-JACKETS; PROTECTIVE CLOTHING (U.S. CLS. 21, 23, 26, 36 AND 38).

CLASS 10—MEDICAL APPARATUS

FOR ORTHOPEDIC SUPPORT BANDAGES; ORTHOPEDIC ARTICLES, NAMELY, STRETCHERS FOR PATIENT TRANSPORT; MEDICAL DEVICES, NAMELY, BODY-SHAPED MATTRESSES AND VESTS USED FOR THE STABILIZATION OF PARTS OF THE BODY FOR USE IN RESCUE OPERATIONS (U.S. CLS. 26, 39 AND 44).

CLASS 25—CLOTHING

FOR CLOTHING, NAMELY, CARDIGANS (U.S. CLS. 22 AND 39).

SN 76-238,151. TELECO, INC., GREENVILLE, SC. FILED 4-10-2001.

TELECO *More Than Just Talk*

OWNER OF U.S. REG. NOS. 1,267,436, 2,429,455 AND OTHERS.

CLASS 9—ELECTRICAL AND SCIENTIFIC APPARATUS

FOR WIRED AND WIRELESS TELEPHONES AND TELEPHONE SYSTEMS COMPRISING OF KEY, HYBRID, AND PBX SYSTEMS; VOICE MAIL SYSTEMS COMPRISED OF COMPUTER HARDWARE AND SOFTWARE FOR ROUTING INCOMING CALLS AND RECORDING VOICE MESSAGES; AUTO-ATTENDANT SYSTEMS COMPRISED OF COMPUTER HARDWARE AND SOFTWARE FOR ROUTING INCOMING CALLS AND RECORDING VOICE MESSAGES; TELEPHONE ADMINISTRATIVE SOFTWARE FOR END USER TO MODIFY PROGRAMMING ON PHONE SYSTEM; VOICE PROCESSING SYSTEMS, NAMELY SPEECH RECOGNITION CIRCUITS, SPEECH SYNTHESIZERS, AND SPEECH SCRAMBLERS AND DE-SCRAMBLERS; CALL MANAGEMENT SOFTWARE AND HARDWARE FOR MERGING E-MAIL, FAX, CALENDAR REMINDERS AND CONTACTS; AND CALL MANAGEMENT SOFTWARE AND HARDWARE FOR VIDEOCONFERENCING (U.S. CLS. 21, 23, 26, 36 AND 38).

FIRST USE 6-1-2000; IN COMMERCE 6-1-2000.

CLASS 35—ADVERTISING AND BUSINESS

FOR DISTRIBUTORSHIP SERVICE IN THE FIELD OF TELECOMMUNICATIONS EQUIPMENT (U.S. CLS. 100, 101 AND 102).

FIRST USE 6-1-2000; IN COMMERCE 6-1-2000.

CLASS 37—CONSTRUCTION AND REPAIR

FOR INSTALLATION AND MAINTENANCE OF TELEPHONES, TELEPHONE SYSTEMS HARDWARE, DATA CABLING AND NETWORK CABLING HARDWARE (U.S. CLS. 100, 103 AND 106).

FIRST USE 6-1-2000; IN COMMERCE 6-1-2000.

CLASS 38—COMMUNICATION

FOR PROVIDING TELECOMMUNICATION SERVICES, NAMELY, LOCAL PHONE SERVICE, LONG DISTANCE, PHONE SERVICES, VIDEOCONFERENCING (U.S. CLS. 100, 101 AND 104).

FIRST USE 6-1-2000; IN COMMERCE 6-1-2000.

CLASS 42—SCIENTIFIC, COMPUTER AND LEGAL SERVICES

FOR INSTALLATION AND MAINTENANCE OF SOFTWARE FOR TELEPHONE SYSTEMS, VOICE MAIL, AUTO-ATTENDANT VOICE PROCESSING SYSTEMS, CALL MANAGEMENT SYSTEMS, DATA CABLING AND NETWORK CABLING, TELEPHONE ADMINISTRATIVE SOFTWARE, VIDEO CONFERENCING SYSTEMS (U.S. CLS. 100 AND 101).

FIRST USE 6-1-2000; IN COMMERCE 6-1-2000.

SN 76-238,737. YAHOO! INC., SUNNYVALE, CA. FILED 4-10-2001.

**CLASS 9—ELECTRICAL AND SCIENTIFIC APPARATUS**

FOR COMPUTER SOFTWARE, NAMELY, SOFTWARE TO ENABLE PEOPLE TO LOCATE OTHER GAME PLAYERS AND PLAY GAMES OVER COMMUNICATIONS NETWORKS (U.S. CLS. 21, 23, 26, 36 AND 38).

FIRST USE 9-0-2000; IN COMMERCE 9-0-2000.

CLASS 41—EDUCATION AND ENTERTAINMENT

FOR COMPUTER SERVICES AND ONLINE COMPUTER SERVICES TO ENABLE PEOPLE TO LOCATE OTHER GAME PLAYERS AND PLAY GAMES OVER COMMUNICATIONS NETWORKS (U.S. CLS. 100, 101 AND 107).

FIRST USE 9-0-2000; IN COMMERCE 9-0-2000.

SN 76-239,358. POLYONE CORPORATION, AVON LAKE, OH. FILED 4-12-2001.

POLYPEARL**CLASS 1—CHEMICALS**

FOR CHEMICAL ADDITIVES FOR USE IN THE MANUFACTURE OF POLYMERS (U.S. CLS. 1, 5, 6, 10, 26 AND 46).

CLASS 2—PAINTS

FOR COLOR CONCENTRATES FOR USE IN THE FURTHER MANUFACTURE OF POLYMERS (U.S. CLS. 6, 11 AND 16).

SN 76-239,513. POLYONE CORPORATION, AVON LAKE, OH. FILED 4-12-2001.

POLYPEARL PLUS**CLASS 1—CHEMICALS**

FOR CHEMICAL ADDITIVES FOR USE IN THE MANUFACTURE OF POLYMERS (U.S. CLS. 1, 5, 6, 10, 26 AND 46).

CLASS 2—PAINTS

FOR AND COLOR CONCENTRATES FOR USE IN THE FURTHER MANUFACTURE OF POLYMERS (U.S. CLS. 6, 11 AND 16).

SN 76-240,199. NATIONAL ASSOCIATION OF TELEVISION PROGRAM EXECUTIVES, INC., SANTA MONICA, CA. FILED 4-4-2001.

PITCH ME!

NO CLAIM IS MADE TO THE EXCLUSIVE RIGHT TO USE "PITCH", APART FROM THE MARK AS SHOWN.

CLASS 9—ELECTRICAL AND SCIENTIFIC APPARATUS

FOR VIDEO RECORDINGS IN THE FIELD OF TELEVISION SHOW IDEA COMPETITIONS (U.S. CLS. 21, 23, 26, 36 AND 38).

FIRST USE 0-0-1997; IN COMMERCE 0-0-1997.

CLASS 41—EDUCATION AND ENTERTAINMENT

FOR ENTERTAINMENT SERVICES IN THE NATURE OF A COMPETITION IN THE FIELD OF TELEVISION SHOW IDEAS (U.S. CLS. 100, 101 AND 107).

FIRST USE 0-0-1997; IN COMMERCE 0-0-1997.

SN 76-240,633. ASKHARRIS.COM, LLP, HOUSTON, TX.
FILED 4-12-2001.

ONE PAY +

NO CLAIM IS MADE TO THE EXCLUSIVE RIGHT TO USE "PAY", APART FROM THE MARK AS SHOWN.

CLASS 9—ELECTRICAL AND SCIENTIFIC APPARATUS

FOR AUTOMATIC KIOSK FOR THE REMOTE ELECTRONIC PAYMENT OF BILLS COMPRISING COMPUTER HARDWARE, SOFTWARE, TOUCH SCREENS, KEY PADS AND CHECK SCANNING DEVICES FOR THE PROCESSING AND HANDLING OF FINANCIAL TRANSACTIONS (U.S. CLS. 21, 23, 26, 36 AND 38).

CLASS 36—INSURANCE AND FINANCIAL

FOR ELECTRONIC BILL PAYMENT SERVICES, NAMELY, ELECTRONIC PROCESSING AND TRANSMISSION OF BILL PAYMENT DATA (U.S. CLS. 100, 101 AND 102).

SN 76-241,879. GCS GROUP, INC., PITTSBURGH, PA. FILED 4-17-2001.

ESTEAM

CLASS 9—ELECTRICAL AND SCIENTIFIC APPARATUS

FOR COMPUTER SOFTWARE, NAMELY, COMPUTER SOFTWARE FOR USE IN THE HUMAN SERVICES FIELD WHICH PERFORMS THE FOLLOWING FUNCTIONS (I) BILLING AND FINANCIAL MANAGEMENT; (II) QUALITY ASSURANCE; AND (III) PROVIDING AND AIDING IN THE USE OF ELECTRONIC CLINICAL RECORDS (U.S. CLS. 21, 23, 26, 36 AND 38).

CLASS 35—ADVERTISING AND BUSINESS

FOR BUSINESS CONSULTING SERVICES IN THE HUMAN SERVICES FIELD (U.S. CLS. 100, 101 AND 102).

CLASS 42—SCIENTIFIC, COMPUTER AND LEGAL SERVICES

FOR INFORMATION TECHNOLOGY CONSULTING SERVICES IN THE HUMAN SERVICES FIELD (U.S. CLS. 100 AND 101).

SN 76-241,959. OMGEO LLC, NEW YORK, NY. FILED 4-16-2001.

OMGEO

CLASS 9—ELECTRICAL AND SCIENTIFIC APPARATUS

FOR COMPUTER SOFTWARE USED FOR FINANCIAL TRANSACTIONS IN THE FIELD OF SECURITIES TRADE PROCESSING AND TRADE MANAGEMENT (U.S. CLS. 21, 23, 26, 36 AND 38).

CLASS 36—INSURANCE AND FINANCIAL

FOR PROVIDING FINANCIAL INFORMATION AND SERVICES IN THE NATURE OF FINANCIAL TRADE MANAGEMENT, FINANCIAL INVESTMENT RESEARCH, FINANCIAL REPORTS AND ADVISORY AND CONSULTATION SERVICES IN CONNECTION WITH ALL THE FOREGOING (U.S. CLS. 100, 101 AND 102).

CLASS 38—COMMUNICATION

FOR ELECTRONIC TRANSMISSION OF SECURITIES TRADING INSTRUCTION DATA VIA COMPUTER WORKSTATIONS, THE INTERNET AND DIRECT LEASE-LINE CONNECTIONS (U.S. CLS. 100, 101 AND 104).

SN 76-242,432. U.S. ENVIRONMENTAL PROTECTION AGENCY, WASHINGTON, DC. AND U.S. DEPARTMENT OF TRANSPORTATION, WASHINGTON, DC. FILED 3-9-2001.

COMMUTER CHOICE

NO CLAIM IS MADE TO THE EXCLUSIVE RIGHT TO USE "COMMUTER", APART FROM THE MARK AS SHOWN.

CLASS 35—ADVERTISING AND BUSINESS

FOR PROMOTING THE COMMUTING PROGRAMS OR INITIATIVES OF OTHER PUBLIC OR PRIVATE ENTITIES THROUGH THE DISTRIBUTION OF PRINTED MATERIALS AND OTHER MEDIA REGARDING A BROAD RANGE OF OPTIONS THAT PEOPLE CAN USE IN GETTING TO WORK (U.S. CLS. 100, 101 AND 102).

FIRST USE 6-19-1996; IN COMMERCE 6-19-1996.

CLASS 41—EDUCATION AND ENTERTAINMENT

FOR EDUCATIONAL SERVICES, NAMELY, CONDUCTING WORKSHOPS, FORUMS, SEMINARS AND CLASSES REGARDING A BROAD RANGE OF OPTIONS THAT PEOPLE CAN USE IN GETTING TO WORK (U.S. CLS. 100, 101 AND 107).

FIRST USE 6-19-1996; IN COMMERCE 6-19-1996.

SN 76-242,520. GCS GROUP, INC., PITTSBURGH, PA. FILED 4-18-2001.

GETTING TO THE POINT OF HUMAN SERVICES

CLASS 9—ELECTRICAL AND SCIENTIFIC APPARATUS

FOR COMPUTER SOFTWARE, NAMELY, COMPUTER SOFTWARE FOR USE IN THE HUMAN SERVICES FIELD WHICH PERFORMS THE FOLLOWING FUNCTIONS (I) BILLING AND FINANCIAL MANAGEMENT; (II) QUALITY ASSURANCE; AND (III) PROVIDING AND AIDING IN THE USE OF ELECTRONIC CLINICAL RECORDS (U.S. CLS. 21, 23, 26, 36 AND 38).

CLASS 35—ADVERTISING AND BUSINESS

FOR BUSINESS CONSULTING SERVICES IN THE HUMAN SERVICES FIELD (U.S. CLS. 100, 101 AND 102).

CLASS 42—SCIENTIFIC, COMPUTER AND LEGAL SERVICES

FOR INFORMATION TECHNOLOGY CONSULTING SERVICES IN THE HUMAN SERVICES FIELD (U.S. CLS. 100 AND 101).

SN 76-244,300. MISS-LOU BLUEBERRY GROWERS ASSOCIATION, POPLARVILLE, MS. FILED 5-1-2000.

SN 76-243,378. WSC, INC., SAN ANGELO, TX. FILED 4-19-2001.



NO CLAIM IS MADE TO THE EXCLUSIVE RIGHT TO USE "INC.", APART FROM THE MARK AS SHOWN.

CLASS 35—ADVERTISING AND BUSINESS

FOR BUSINESS MANAGEMENT SERVICES IN THE FIELD OF TELECOMMUNICATIONS SYSTEMS (U.S. CLS. 100, 101 AND 102).
FIRST USE 11-1-2000; IN COMMERCE 11-1-2000.

CLASS 37—CONSTRUCTION AND REPAIR

FOR INSTALLATION AND MAINTENANCE OF TELECOMMUNICATIONS SYSTEMS (U.S. CLS. 100, 103 AND 106).
FIRST USE 11-1-2000; IN COMMERCE 11-1-2000.

CLASS 42—SCIENTIFIC, COMPUTER AND LEGAL SERVICES

FOR CUSTOM DESIGN, ANALYSIS, DATA CONVERSION, AND TECHNICAL SUPPORT OF TELECOMMUNICATION SYSTEMS; TESTING AND EVALUATION OF TELECOMMUNICATION SYSTEMS FOR THE PURPOSE OF CERTIFICATION (U.S. CLS. 100 AND 101).
FIRST USE 11-1-2000; IN COMMERCE 11-1-2000.



NO CLAIM IS MADE TO THE EXCLUSIVE RIGHT TO USE "BLUEBERRY GROWERS ASSOCIATION", "BLUEBERRIES" AND THE REPRESENTATION OF A BLUEBERRY, APART FROM THE MARK AS SHOWN.

CLASS 29—MEATS AND PROCESSED FOODS

FOR FROZEN BLUEBERRIES (U.S. CL. 46).
FIRST USE 6-1-1985; IN COMMERCE 6-30-1992.

CLASS 31—NATURAL AGRICULTURAL PRODUCTS

FOR FRESH BLUEBERRIES (U.S. CLS. 1 AND 46).
FIRST USE 6-1-1985; IN COMMERCE 6-30-1992.

SN 76-244,465. NEOPOST INC., HAYWARD, CA. FILED 4-20-2001.

CLICK 'N SNAP**CLASS 2—PAINTS**

FOR INKJET CARTRIDGES (U.S. CLS. 6, 11 AND 16).

CLASS 9—ELECTRICAL AND SCIENTIFIC APPARATUS

FOR ELECTRONIC MAILING MACHINES, POSTAGE METERS AND PARTS THEREFOR (U.S. CLS. 21, 23, 26, 36 AND 38).

SN 76-245,029. LIGHTTRANS GMBH, 1A D-07745 JENA, FED REP GERMANY, FILED 4-23-2001.

VOL4

CLASS 9—ELECTRICAL AND SCIENTIFIC APPARATUS

FOR COMPUTER SOFTWARE, NAMELY, PROGRAMS FOR CALCULATING OPTICAL SUBASSEMBLIES AND OPTICAL ELEMENTS SUCH AS LIGHT SOURCES, LASER RESONATORS, OBJECTIVES, LENSES, DIAPHRAGMS, PRISMS, REFLECTORS, FILTERS, BEAM SPLITTERS, DIFFRACTIVE OPTICAL ELEMENTS, GRATINGS, DIFFUSERS AND DETECTORS; PROGRAMS FOR DRAFTING AND OPTIMIZING OPTICAL ARRANGEMENTS WITH RESPECT TO THE CONSTRUCTION OF OPTICAL COMPONENTS AND THE INTERACTION OF OPTICAL COMPONENTS; PROGRAMS FOR THE SIMULATION OF EXPERIMENTS OR SERIES OF EXPERIMENTS IN THE VIRTUAL OPTIC LABORATORY; TEACHING PROGRAMS FOR DISSEMINATING KNOWLEDGE AND SKILLS FOR THE CONSTRUCTION, CONFIGURATION, ARRANGEMENT, OPERATION OF OPTICAL SUBASSEMBLIES AND OPTICAL COMPONENT PARTS AND THEIR INTERACTION; EQUIPMENT FOR RECORDING, TRANSMISSION AND REPRODUCTION OF SOUND AND IMAGES, NAMELY VIDEO CASSETTE RECORDERS AND COMPACT DISC PLAYERS; FIRE EXTINGUISHING EQUIPMENT, NAMELY FIRE EXTINGUISHERS AND SPRINKLERS; CALCULATING MACHINES; DATA PROCESSING EQUIPMENT, NAMELY ROUTERS AND COMPUTER TERMINALS; AND COMPUTERS CONTAINING OPTICAL SUBASSEMBLIES AND OPTICAL ELEMENTS SUCH AS LIGHT SOURCES, LASER RESONATORS, OBJECTIVES, LENSES, DIAPHRAGMS, PRISMS, REFLECTORS, FILTERS, BEAM SPLITTERS, DIFFRACTIVE OPTICAL ELEMENTS, GRATINGS, DIFFUSERS, DETECTORS (U.S. CLS. 21, 23, 26, 36 AND 38).

CLASS 41—EDUCATION AND ENTERTAINMENT

FOR TRAINING AND INSTRUCTION IN CONNECTION WITH COMPUTER PROGRAMS FOR CALCULATING OPTICAL SUBASSEMBLIES AND OPTICAL COMPONENT PARTS AND FOR SIMULATION OF EXPERIMENTS OR SERIES OF EXPERIMENTS IN THE VIRTUAL OPTIC LABORATORY; EDUCATIONAL DEMONSTRATIONS FOR THE OPERATION OF OPTICAL SUBASSEMBLIES AND OPTICAL ELEMENTS AND THEIR INTERACTION (U.S. CLS. 100, 101 AND 107).

CLASS 42—SCIENTIFIC, COMPUTER AND LEGAL SERVICES

FOR DEVELOPMENT OF COMPUTER SOFTWARE FOR OTHERS, NAMELY, PROGRAMS FOR CALCULATING OPTICAL SUBASSEMBLIES AND OPTICAL ELEMENTS SUCH AS LIGHT SOURCES, LASER RESONATORS, OBJECTIVES, LENSES, DIAPHRAGMS, PRISMS, REFLECTORS, FILTERS, BEAM SPLITTERS, DIFFRACTIVE OPTICAL ELEMENTS, GRATINGS, DIFFUSERS, DETECTORS; DEVELOPMENT OF PROGRAMS FOR OTHERS FOR DRAFTING AND OPTIMIZING OPTICAL ARRANGEMENTS WITH RESPECT TO THE CONSTRUCTION OF THE OPTICAL COMPONENT PARTS AND THE COOPERATION OF THE OPTICAL COMPONENT PARTS; DEVELOPMENT OF PROGRAMS FOR OTHERS FOR THE SIMULATION OF EXPERIMENTS OR SERIES OF EXPERIMENTS IN THE VIRTUAL OPTIC LABORATORY; DEVELOPMENT OF TEACHING PROGRAMS FOR OTHERS FOR DIS-

SEMINATING KNOWLEDGE AND SKILLS FOR THE CONSTRUCTION, CONFIGURATION, ARRANGEMENT, OPERATION OF OPTICAL SUBASSEMBLIES AND OPTICAL COMPONENT PARTS AND THEIR INTERACTION; RESEARCH AND DEVELOPMENT FOR NEW PRODUCTS OF OTHERS, NAMELY, OPTICAL SUBASSEMBLIES AND OPTICAL ELEMENTS SUCH AS LIGHT SOURCES, LASER RESONATORS, OBJECTIVES, LENSES, DIAPHRAGMS, PRISMS, REFLECTORS, FILTERS, BEAM SPLITTERS, DIFFRACTIVE OPTICAL ELEMENTS, GRATINGS, DIFFUSERS, DETECTORS, AND THE LIKE (U.S. CLS. 100 AND 101).

SN 76-245,245. ASTRUM S.A.S., 78146 VELIZY - VILLACOUBLAY, FRANCE, FILED 4-24-2001.

ROS - 2000

CLASS 7—MACHINERY

FOR THRUSTERS FOR MACHINES, NAMELY, A GASEOUS PROPELLANT HALL EFFECT TYPE THRUSTER UNIT FOR A SPACE PLATFORM AND PARTS AND FITTINGS THEREFOR (U.S. CLS. 13, 19, 21, 23, 31, 34 AND 35).

CLASS 12—VEHICLES

FOR THRUSTERS FOR VEHICLES, NAMELY, A GASEOUS PROPELLANT HALL EFFECT TYPE THRUSTER UNIT FOR A SPACE VEHICLE AND STRUCTURAL PARTS AND FITTINGS THEREFOR (U.S. CLS. 19, 21, 23, 31, 35 AND 44).

SN 76-246,998. DAKOTA DIGITAL, INC., SIOUX FALLS, SD, FILED 4-26-2001.

DAKOTA DIGITAL

SEC. 2(F).

CLASS 9—ELECTRICAL AND SCIENTIFIC APPARATUS

FOR AUTOMOTIVE, MOTORCYCLE AND CAR AUDIO INSTRUMENTATION, NAMELY, CAR AUDIO VOLTMETERS, AMPLIFIER TEMPERATURE GAUGES, AMPLIFIER CURRENT METERS, AND SPL (SOUND PRESSURE LEVEL) METERS; AND VEHICLE ACCESSORIES, NAMELY, CRUISE CONTROL, POWER WINDOW SYSTEMS, REMOTE ENTRY SYSTEMS, DOOR RELEASE MOTOR, TRUNK LIFT MOTORS AND KITS, GEAR SHIFT POSITION SENDING UNITS, VEHICLE SPEED SENSOR (VSS) INTERFACES AND CALIBRATION MODULES, ENGINE CONTROL MODULE (ECM) INTERFACES, AIR RIDE HEIGHT CONTROL, LED VEHICLE LIGHTING, ALUMINUM INSTRUMENT AND GLOVE BOX AND RADIO PANELS AND KNOBS AND BEZELS (U.S. CLS. 21, 23, 26, 36 AND 38).
FIRST USE 1-20-1987; IN COMMERCE 1-20-1987.

CLASS 35—ADVERTISING AND BUSINESS

FOR ON-LINE AND MAIL ORDER RETAIL AND WHOLESALE SERVICES FEATURING VEHICLE AND MOTORCYCLE ACCESSORIES (U.S. CLS. 100, 101 AND 102).
FIRST USE 1-20-1987; IN COMMERCE 1-20-1987.

SN 76-248,487. PAUL VOSS GMBH & CO. KG, D-57413 FINNENTROP-HEGGEN, FED REP GERMANY, FILED 4-30-2001.

SECUFLEX

OWNER OF FED REP GERMANY REG. NO. 30080053, DATED 12-4-2000, EXPIRES 10-31-2010.

CLASS 6—METAL GOODS

FOR AWNINGS, AWNING ARMS, AND FOLDING AWNING ARMS OF METAL COMPOSITION (U.S. CLS. 2, 12, 13, 14, 23, 25 AND 50).

CLASS 22—CORDAGE AND FIBERS

FOR AWNINGS, AWNING ARMS AND FOLDING AWNING ARMS OF NON-METAL COMPOSITION (U.S. CLS. 1, 2, 7, 19, 22, 42 AND 50).

SN 76-248,630. MILES, KIMBERLY K., WASHINGTON, DC. FILED 4-30-2001.

LIFE CHOICES COUNSELING

NO CLAIM IS MADE TO THE EXCLUSIVE RIGHT TO USE "COUNSELING", APART FROM THE MARK AS SHOWN.

CLASS 16—PAPER GOODS AND PRINTED MATTER

FOR PRINTED MANUALS, WORKBOOKS DEALING WITH HYPNOSIS (U.S. CLS. 2, 5, 22, 23, 29, 37, 38 AND 50).

FIRST USE 1-0-1998; IN COMMERCE 4-0-1999.

CLASS 41—EDUCATION AND ENTERTAINMENT

FOR EDUCATIONAL SERVICES, NAMELY, CONDUCTING HYPNOSIS WORKSHOPS, TRAINING CLASSES, AND SEMINARS (U.S. CLS. 100, 101 AND 107). FIRST USE 1-0-1998; IN COMMERCE 4-0-1999.

SN 76-249,559. WYNN DESIGN AND DEVELOPMENT, LLC, LAS VEGAS, NV. FILED 4-30-2001.

WYNN DESIGN AND DEVELOPMENT

NO CLAIM IS MADE TO THE EXCLUSIVE RIGHT TO USE "DESIGN AND DEVELOPMENT", APART FROM THE MARK AS SHOWN.

CLASS 6—METAL GOODS

FOR METAL CHAINS, METAL PIGGY BANKS, METAL DECORATIVE BOXES AND METAL JEWELRY BOXES, METAL MONEY CLIPS AND SCULPTURES OF NON-PRECIOUS METAL (U.S. CLS. 2, 12, 13, 14, 23, 25 AND 50).

CLASS 8—HAND TOOLS

FOR TABLEWARE, NAMELY, KNIVES, FORKS AND SPOONS (U.S. CLS. 23, 28 AND 44).

CLASS 16—PAPER GOODS AND PRINTED MATTER

FOR PENS, PENCILS, PLAYING CARDS, STATIONERY, NAMELY, LETTERHEAD AND ENVELOPES, NOTE CARDS, NOTE PADS, NOTE BOOKS, APPOINTMENT BOOKS, POSTCARDS, CHILDREN'S ACTIVITY BOOKS, COLORING BOOKS, PEN AND PENCIL HOLDERS AND RUBBER STAMPS; PAPER COASTERS (U.S. CLS. 2, 5, 22, 23, 29, 37, 38 AND 50).

CLASS 18—LEATHER GOODS

FOR TOTE BAGS, DUFFLE BAGS, BACK PACKS, BEACH BAGS, FANNY PACKS, HAND BAGS, WALLETTS, BILLFOLDS, CARD CASES, TOILETRY CASES SOLD EMPTY, GARMENT BAGS AND UMBRELLAS (U.S. CLS. 1, 2, 3, 22 AND 41).

CLASS 21—HOUSEWARES AND GLASS

FOR GLASSWARE, BEVERAGEWARE, TABLEWARE, MUGS, STEINS, CUPS, PLATES, MEAL OR CRUMB TRAYS, COOKIE JARS, GLASS WATER BOTTLES SOLD EMPTY, INSULATED BEVERAGE HOLDERS, VASES, PLASTIC COASTERS, BOTTLE OPENERS, CORK SCREWS, NON-METAL DECORATIVE BOXES, HAIR BRUSHES, HAIR COMBS AND NON-METAL PIGGY BANKS (U.S. CLS. 2, 13, 23, 29, 30, 33, 40 AND 50).

CLASS 25—CLOTHING

FOR WEARING APPAREL, NAMELY, POLO SHIRTS, T-SHIRTS, TANK TOPS, SHIRTS, JACKETS, JOGGING SUITS, SWEAT SHIRTS, SWEAT PANTS, JEANS, PANTS, ROBES, SLEEPWEAR, ROMPERS, SCARVES, SOCKS, SLIPPERS, HATS, CAPS AND BELTS (U.S. CLS. 22 AND 39).

SN 76-249,590. DISCOVERY COMMUNICATIONS, INC., BETHESDA, MD. FILED 4-30-2001.

WILD DISCOVERY

OWNER OF U.S. REG. NOS. 2,174,728, 2,244,685 AND 2,286,757.

CLASS 18—LEATHER GOODS

FOR LUGGAGE; SCHOOL BAGS, SCHOOL BOOK BAGS, BACKPACKS, ATHLETIC BAGS, FANNY PACKS, UMBRELLAS, POCKETBOOKS, ALL PURPOSE SPORTS BAGS, BEACH BAGS, GYM BAGS, DUFFLE BAGS, OVERNIGHT BAGS, TOILETRY CASES SOLD EMPTY, TRAVEL BAGS, TOTE BAGS, BEACH UMBRELLAS, PURSES, HANDBAGS, KEY CASES, KNAPSACKS, WALLETTS, CARRY-ON BAGS (U.S. CLS. 1, 2, 3, 22 AND 41).

CLASS 21—HOUSEWARES AND GLASS

FOR MUGS, DRINKING GLASSES, PAPER CUPS, PAPER PLATES, PITCHERS, PLASTIC BOTTLES SOLD EMPTY, THERMAL INSULATED CONTAINERS FOR BEVERAGES, LUNCH BOXES, CERAMIC FIGURINES, CHINA, GLASS, CRYSTAL AND PORCELAIN ORNAMENTS, EXCLUSIVE OF CHRISTMAS TREE ORNAMENTS, COSMETIC BRUSHES AND HAIR BRUSHES (U.S. CLS. 2, 13, 23, 29, 30, 33, 40 AND 50).

CLASS 28—TOYS AND SPORTING GOODS

FOR PLUSH TOYS, SOFT SCULPTURE TOYS, GAMES, NAMELY, BOARD GAMES, CARD GAMES, PARLOR GAMES, ACTION GAMES, ACTION SKILL GAMES, HAND HELD UNIT FOR PLAYING ELECTRONIC AND VIDEO GAMES, OUTDOOR ACTIVITY GAMES IN THE NATURE OF SWIMMING GAMES, CLIMBING GAMES AND WATER RELATED GAMES; MANIPULATIVE GAMES, ROLE PLAYING GAMES, MODELS, NAMELY, TOY MODEL VEHICLES AND RELATED ACCESSORIES SOLD AS UNITS, MODEL TRAIN SETS, MODEL AIRPLANES, PUZZLES, NAMELY, JIGSAW PUZZLES, MANIPULATIVE PUZZLES, THREE-DIMENSIONAL PUZZLES, TOY ACTION FIGURES AND ACCESSORIES THEREFORE, PLAY FIGURES, WATER SQUIRTING TOYS, BATHTUB TOYS, DOLLS DOLL CLOTHES AND DOLL ACCESSORIES, CHILDREN'S MULTI-ACTIVITY TOYS, PARTY FAVORS IN THE NATURE OF SMALL TOYS (U.S. CLS. 22, 23, 38 AND 50).

CLASS 16—PAPER GOODS AND PRINTED MATTER

FOR BROCHURES AND BOOKLETS RELATING TO COMPUTER AND VIDEO GAMES; VIDEO GAME STRATEGY GUIDE BOOKS; VIDEO GAME STRATEGY GUIDE MAGAZINES; CARD GAME STRATEGY GUIDE BOOKS; CARD GAME STRATEGY GUIDE MAGAZINES; CARD GAME INSTRUCTION BOOKS; CARD GAME INSTRUCTION MAGAZINES; POSTERS; PLAYING CARDS AND INSTRUCTION MANUAL SOLD THEREWITH; COMPUTER GAME INSTRUCTION MANUALS; PRINTED GAME INSTRUCTION SHEETS; PRINTED SCORING SHEETS; TRADING CARDS; CALENDARS; LOOSE-LEAF BINDERS AND STATIONERY (U.S. CLS. 2, 5, 22, 23, 29, 37, 38 AND 50).

CLASS 28—TOYS AND SPORTING GOODS

FOR STAND ALONE VIDEO GAME MACHINES; HAND-HELD UNITS FOR PLAYING ELECTRONIC GAMES; BOARD GAMES AND INSTRUCTIONAL MANUALS SOLD AS A UNIT THEREWITH; CARD GAMES; DICE; PROMOTIONAL GAME MATERIALS; GAME EQUIPMENT, NAMELY, CHIPS; TOYS, NAMELY, ACTION FIGURES, DOLLS AND PLAYSETS THEREFOR (U.S. CLS. 22, 23, 38 AND 50).

SN 76-250,441. WHIPPLEHILL COMMUNICATIONS, INC., BEDFORD, NH. FILED 5-3-2001.

WHIPPLEHILL**CLASS 35—ADVERTISING AND BUSINESS**

FOR COMPUTER SERVICES, NAMELY, GLOBAL COMPUTER NETWORK WEB SITE DATABASE MANAGEMENT (U.S. CLS. 100, 101 AND 102).
FIRST USE 9-0-1998; IN COMMERCE 9-0-1998.

CLASS 42—SCIENTIFIC, COMPUTER AND LEGAL SERVICES

FOR COMPUTER SERVICES, NAMELY, CREATING AND MAINTAINING WEB SITES FOR SCHOOLS; CONSULTING SERVICES IN THE FIELD OF SCHOOL WEBSITE DESIGN AND MAINTENANCE; PROVIDING TEMPORARY USE OF ON-LINE NON-DOWNLOADABLE SOFTWARE FOR USE IN DATABASE MANAGEMENT IN THE FIELD OF SCHOOL WEB SITE DESIGN AND MANAGEMENT (U.S. CLS. 100 AND 101).
FIRST USE 9-0-1998; IN COMMERCE 9-0-1998.

SN 76-252,745. KONAMI CORPORATION, MINATO-KU, TOKYO, JAPAN, FILED 5-4-2001.

PETIT DRAGON**CLASS 9—ELECTRICAL AND SCIENTIFIC APPARATUS**

FOR COMPUTER PRODUCTS, NAMELY, COMPUTER GAME PROGRAMS; VIDEO GAME CARTRIDGES; VIDEO GAME CD-ROMS; VIDEO GAME MACHINES FOR USE WITH TELEVISIONS; COMPUTER GAME CD-ROMS; VIDEO GAME PROGRAMS; VIDEO GAME PROGRAMS FOR USE WITH TELEVISION SETS; VIDEO GAME JOYSTICKS (U.S. CLS. 21, 23, 26, 36 AND 38).

SN 76-253,056. KONAMI CORPORATION, MINATO-KU, TOKYO, JAPAN, FILED 5-4-2001.

MAHA VAILO**CLASS 9—ELECTRICAL AND SCIENTIFIC APPARATUS**

FOR COMPUTER PRODUCTS, NAMELY, COMPUTER GAME PROGRAMS; VIDEO GAME CARTRIDGES; VIDEO GAME CD-ROMS; VIDEO GAME MACHINES FOR USE WITH TELEVISIONS; COMPUTER GAME CD-ROMS; VIDEO GAME PROGRAMS; VIDEO GAME PROGRAMS FOR USE WITH TELEVISION SETS; VIDEO GAME JOYSTICKS (U.S. CLS. 21, 23, 26, 36 AND 38).

CLASS 16—PAPER GOODS AND PRINTED MATTER

FOR BROCHURES AND BOOKLETS RELATING TO COMPUTER AND VIDEO GAMES; VIDEO GAME STRATEGY GUIDE BOOKS; VIDEO GAME STRATEGY GUIDE MAGAZINES; CARD GAME STRATEGY GUIDE BOOKS; CARD GAME STRATEGY GUIDE MAGAZINES; CARD GAME INSTRUCTION BOOKS; CARD GAME INSTRUCTION MAGAZINES; POSTERS; PLAYING CARDS AND INSTRUCTION MANUAL SOLD THEREWITH; COMPUTER GAME INSTRUCTION MANUALS; PRINTED GAME INSTRUCTION SHEETS; PRINTED SCORING SHEETS; TRADING CARDS; CALENDARS; LOOSE-LEAF BINDERS AND STATIONERY (U.S. CLS. 2, 5, 22, 23, 29, 37, 38 AND 50).

CLASS 28—TOYS AND SPORTING GOODS

FOR STAND ALONE VIDEO GAME MACHINES; HAND-HELD UNITS FOR PLAYING ELECTRONIC GAMES; BOARD GAMES AND INSTRUCTIONAL MANUALS SOLD AS A UNIT THEREWITH; CARD GAMES; DICE; PROMOTIONAL GAME MATERIALS; GAME EQUIPMENT, NAMELY, CHIPS; TOYS, NAMELY, ACTION FIGURES, DOLLS AND PLAYSETS THEREFOR (U.S. CLS. 22, 23, 38 AND 50).

SN 76-253,193. KONAMI CORPORATION, TOKYO, JAPAN,
FILED 5-4-2001.

SN 76-255,156. I VIAGGI DEL VENTAGLIO S.P.A., I-20146
MILANO, ITALY, FILED 5-10-2001.

BOAR SOLDIER

CLASS 9—ELECTRICAL AND SCIENTIFIC APPARATUS

FOR COMPUTER PRODUCTS, NAMELY, COMPUTER GAME PROGRAMS; VIDEO GAME CARTRIDGES; VIDEO GAME CD-ROMS; VIDEO GAME MACHINES FOR USE WITH TELEVISIONS; COMPUTER GAME CD-ROMS; VIDEO GAME PROGRAMS; VIDEO GAME PROGRAMS FOR USE WITH TELEVISION SETS; VIDEO GAME JOYSTICKS (U.S. CLS. 21, 23, 26, 36 AND 38).

CLASS 16—PAPER GOODS AND PRINTED MATTER

FOR BROCHURES AND BOOKLETS RELATING TO COMPUTER AND VIDEO GAMES; VIDEO GAME STRATEGY GUIDE BOOKS; VIDEO GAME STRATEGY GUIDE MAGAZINES; CARD GAME STRATEGY GUIDE BOOKS; CARD GAME STRATEGY GUIDE MAGAZINES; CARD GAME INSTRUCTION BOOKS; CARD GAME INSTRUCTION MAGAZINES; POSTERS; PLAYING CARDS AND INSTRUCTION MANUAL SOLD THEREWITH; COMPUTER GAME INSTRUCTION MANUALS; PRINTED GAME INSTRUCTION SHEETS; PRINTED SCORING SHEETS; TRADING CARDS; CALENDARS; LOOSE-LEAF BINDERS AND STATIONERY (U.S. CLS. 2, 5, 22, 23, 29, 37, 38 AND 50).

CLASS 28—TOYS AND SPORTING GOODS

FOR STAND-ALONE VIDEO GAME MACHINES; HAND-HELD UNITS FOR PLAYING ELECTRONIC GAMES; BOARD GAMES AND INSTRUCTIONAL MANUALS SOLD AS A UNIT THEREWITH; CARD GAMES; DICE; PROMOTIONAL GAME MATERIALS; GAME EQUIPMENT, NAMELY, CHIPS; TOYS, NAMELY, ACTION FIGURES, DOLLS AND PLAYSETS THEREFOR (U.S. CLS. 22, 23, 38 AND 50).

SN 76-254,515. BARNES & NOBLE, INC., NEW YORK, NY.
FILED 5-9-2001.

LITERARY ADVENTURES

NO CLAIM IS MADE TO THE EXCLUSIVE RIGHT TO USE "LITERARY", APART FROM THE MARK AS SHOWN.

CLASS 16—PAPER GOODS AND PRINTED MATTER

FOR PRINTED MATERIALS, NAMELY, BOOKS, MAGAZINES AND NEWSLETTERS IN THE FIELD OF TRAVEL (U.S. CLS. 2, 5, 22, 23, 29, 37, 38 AND 50).

CLASS 41—EDUCATION AND ENTERTAINMENT

FOR EDUCATIONAL SERVICES, NAMELY, CONDUCTING CLASSES, SEMINARS, EVENTS, MEETINGS AND WORKSHOPS WITH AUTHORS IN THE FIELDS OF TRAVEL AND LITERATURE AND DISTRIBUTING COURSE MATERIALS IN CONNECTION THEREWITH (U.S. CLS. 100, 101 AND 107).



PRIORITY CLAIMED UNDER SEC. 44(D) ON ITALY APPLICATION NO. MI2001C00118, FILED 2-2-2001, REG. NO. 00846570, DATED 2-2-2001, EXPIRES 2-2-2011.

NO CLAIM IS MADE TO THE EXCLUSIVE RIGHT TO USE "VENTA" OR "DIVING", APART FROM THE MARK AS SHOWN.

THE TRANSLITERATION OF THE SPANISH WORD "VENTA" MEANS "THE ACT OR PRACTICE OF SELLING".

CLASS 9—ELECTRICAL AND SCIENTIFIC APPARATUS

FOR DIVING SUITS AND DIVING GLOBES; DIVERS' MASKS; RESPIRATORS FOR DIVERS; NAUTICAL APPARATUS AND INSTRUMENTS, NAMELY, AIR TANKS FOR USE IN SCUBA DIVING AND MARINE DEPTH FINDERS; PHOTOGRAPHIC APPARATUS AND INSTRUMENTS, NAMELY, CAMERAS, FLASHBULBS, AND FILM; CINEMATOGRAPHIC APPARATUS AND INSTRUMENTS, NAMELY, VIDEO CAMERAS AND FILM PORTRAIT CAMERAS; OPTICAL APPARATUS AND INSTRUMENTS, NAMELY, LENS SIGHT AND OPTICAL CHARACTER RECOGNITION APPARATUS; APPARATUS AND INSTRUMENTS USED TO SUPERVISE SCUBA DIVERS, NAMELY, GLOBAL POSITIONING SYSTEM CONSISTING OF COMPUTERS, COMPUTER SOFTWARE, TRANSMITTERS, RECEIVERS AND NETWORK INTERFACE DEVICES; LIFE-SAVING APPARATUS AND INSTRUMENTS, NAMELY, LIFE JACKETS AND LIFE PRESERVERS; TEACHING APPARATUS AND INSTRUMENTS, NAMELY, BUOYANCY COMPENSATOR DEVICES FOR DIVERS AND UNDERWATER BREATHING LINES FOR USE BETWEEN INSTRUCTOR AND STUDENT; MAGNETIC DATA CARRIERS, ACOUSTIC DISCS FEATURING DIVING INSTRUCTIONS, COMPUTERS; COMPUTER SOFTWARE FOR USE IN NAVIGATING A DIVING BOAT (U.S. CLS. 21, 23, 26, 36 AND 38).

CLASS 41—EDUCATION AND ENTERTAINMENT

FOR PROVIDING EDUCATION AND TRAINING FOR OTHERS IN THE FIELD OF SCUBA DIVING INSTRUCTION AND WATER SAFETY; ENTERTAINMENT SERVICES, NAMELY, RIVER REGATTAS AND DIVING EXHIBITIONS; ORGANIZING COMMUNITY SPORTING AND CULTURAL EVENTS; HOLIDAY CAMP SERVICES (ENTERTAINMENT); PROVIDING FACILITIES FOR SPORTS TOURNAMENTS FOR SCUBA DIVING; CONDUCTING OF DIVING CENTER; TRAINING AND ADVANCED COURSES FOR DIVING ACTIVITY; RENTAL OF SCUBA DIVERS' EQUIPMENT (U.S. CLS. 100, 101 AND 107).

SN 76-255,197. ZEIT AG, CH-6210 SURSSE, SWITZERLAND,
FILED 5-10-2001.



NO CLAIM IS MADE TO THE EXCLUSIVE RIGHT TO USE "ZEIT," "AG" AND "SWITZERLAND", APART FROM THE MARK AS SHOWN.

THE ENGLISH TRANSLATION OF THE TERM "ZEIT" IS "TIME".

CLASS 35—ADVERTISING AND BUSINESS

FOR PERSONNEL MANAGEMENT CONSULTATION; BUSINESS MANAGEMENT AND CONSULTATION (U.S. CLS. 100, 101 AND 102).

CLASS 42—SCIENTIFIC, COMPUTER AND LEGAL SERVICES

FOR COMPUTER SOFTWARE CONSULTATION AND DEVELOPMENT OF COMPUTER PROGRAMS FOR USE IN THE RECORDING AND/OR MANAGEMENT OF TIME AND OTHER TIME-RELATED SERVICES AND/OR PURPOSES (U.S. CLS. 100 AND 101).

SN 76-255,331. YAN CAN COOK, INC., DBA YAN CAN COOK, FOSTER CITY, CA. FILED 5-10-2001.

MASTER CHEF YAN PRESENTS

OWNER OF U.S. REG. NOS. 2,311,369, 2,367,762 AND 2,437,935.

THE REFERENCE TO "MASTER CHEF YAN" IN THE MARK IDENTIFIES A LIVING INDIVIDUAL WHOSE CONSENT IS OF RECORD.

CLASS 29—MEATS AND PROCESSED FOODS

FOR FROZEN, PREPARED AND PACKAGED FOODS, NAMELY, MEALS CONSISTING PRIMARILY OF MEAT, FISH, POULTRY OR VEGETABLES (U.S. CL. 46).

CLASS 30—STAPLE FOODS

FOR FROZEN, PREPARED AND PACKAGED FOODS, NAMELY, MEALS CONSISTING PRIMARILY OF PASTA OR RICE (U.S. CL. 46).

SN 76-257,327. LIT-PAC, INC., TAYLOR, MI. FILED 5-15-2001.

INSIDE THE BOX THINKING

CLASS 40—MATERIAL TREATMENT

FOR CUSTOM MANUFACTURE OF PAPER PACKAGING AND PRODUCTS FOR OTHERS (U.S. CLS. 100, 103 AND 106).

FIRST USE 10-24-2000; IN COMMERCE 10-24-2000.

CLASS 42—SCIENTIFIC, COMPUTER AND LEGAL SERVICES

FOR CUSTOM DESIGN OF PAPER PACKAGING AND PRODUCTS FOR OTHERS (U.S. CLS. 100 AND 101).
FIRST USE 10-24-2000; IN COMMERCE 10-24-2000.

SN 76-257,616. UNIVERSITY OF WASHINGTON, SEATTLE, WA. FILED 5-10-2001.

WHERE THE MUSIC MATTERS

CLASS 38—COMMUNICATION

FOR RADIO AND INTERNET BROADCASTING (U.S. CLS. 100, 101 AND 104).
FIRST USE 11-9-1991; IN COMMERCE 11-9-1991.

CLASS 41—EDUCATION AND ENTERTAINMENT

FOR PROVIDING A WEB SITE OF INFORMATION RELATED TO MUSIC AND MUSIC-RELATED CONTENT (U.S. CLS. 100, 101 AND 107).
FIRST USE 1-0-1996; IN COMMERCE 1-0-1996.

SN 76-260,398. ICUE CORP, SOUTHAMPTON, PA. BY CHANGE OF NAME FAX BUREAU, INC., SOUTHAMPTON, PA. FILED 5-21-2001.

ICUE

CLASS 35—ADVERTISING AND BUSINESS

FOR BUSINESS MARKETING CONSULTING SERVICES; COMPUTERIZED DATABASE MANAGEMENT; RECORDS MANAGEMENT SERVICES, NAMELY CONFIGURATION CONTROL, CUSTOMIZATION, INDEXING AND ARCHIVING OF DOCUMENTS FOR OTHERS (U.S. CLS. 100, 101 AND 102).

CLASS 38—COMMUNICATION

FOR COMMUNICATIONS SERVICES, NAMELY ELECTRONIC TRANSMISSION OF DATA AND DOCUMENTS (U.S. CLS. 100, 101 AND 104).

SN 76-260,892. DESTINY FAMILY CHURCH, INC., BROKEN ARROW, OK. FILED 5-24-2001.

THIS GENERATION

OWNER OF U.S. REG. NO. 1,940,762.

CLASS 25—CLOTHING

FOR CLOTHING, NAMELY T-SHIRTS, SWEATSHIRTS, AND CAPS (U.S. CLS. 22 AND 39).
FIRST USE 1-1-1985; IN COMMERCE 1-1-1985.

CLASS 38—COMMUNICATION

FOR CHRISTIAN RADIO AND TELEVISION BROADCASTING (U.S. CLS. 100, 101 AND 104).
FIRST USE 1-1-1985; IN COMMERCE 1-1-1985.

CLASS 42—SCIENTIFIC, COMPUTER AND LEGAL SERVICES

FOR EVANGELISTIC AND MINISTERIAL SERVICES PROMOTING THE GOSPEL OF JESUS CHRIST AND MATERIALS DISTRIBUTED IN CONNECTION THEREWITH (U.S. CLS. 100 AND 101).
FIRST USE 1-1-1985; IN COMMERCE 1-1-1985.

SN 76-261,463. TECNICAS MODULARES E INDUSTRIALES, S.A., 08400 GRANOLLERS, SPAIN, FILED 5-23-2001.

**TEMOINSA**

THE MARK CONSISTS OF THE LETTERS "TMI" OUTLINED IN THE COLOR BLUE AND SHOWN WITHIN A MISCELLANEOUS OVAL DESIGN IN THE COLOR GRAY, AND THE TERM "TEMOINSA" SHOWN IN SOLID BLUE LETTERING BENEATH THE DESIGN ELEMENT, THE MARK CONTAINS THE COLORS BLUE AND GRAY AND COLOR IS CLAIMED AS A FEATURE OF THE MARK.
THE WORDING "TEMOINSA" HAS NO MEANING OTHER THAN TRADEMARK SIGNIFICANCE.

CLASS 37—CONSTRUCTION AND REPAIR

FOR BUILDING, REPAIRING, MAINTENANCE, RENOVATION, REFURBISHING AND REHABILITATION OF RAILWAY COACHES (U.S. CLS. 100, 103 AND 106).
FIRST USE 4-0-1999; IN COMMERCE 9-0-1999.

CLASS 42—SCIENTIFIC, COMPUTER AND LEGAL SERVICES

FOR ENGINEERING AND DESIGN OF SYSTEMS AND MODULAR ASSEMBLIES FOR INTERIORS OF RAILWAY COACHES (U.S. CLS. 100 AND 101).
FIRST USE 4-0-1999; IN COMMERCE 9-0-1999.

SN 76-261,702. LP INNOVATIONS, INC., CANTON, MA. FILED 5-23-2001.

SECUREX**CLASS 37—CONSTRUCTION AND REPAIR**

FOR LOSS PREVENTION AND ALARM COMPANY SERVICES, NAMELY, ALARM SYSTEM INSTALLATION AND MAINTENANCE (U.S. CLS. 100, 103 AND 106).
FIRST USE 12-0-2000; IN COMMERCE 12-0-2000.

CLASS 42—SCIENTIFIC, COMPUTER AND LEGAL SERVICES

FOR LOSS PREVENTION AND ALARM COMPANY SERVICES, NAMELY, MONITORING (U.S. CLS. 100 AND 101).
FIRST USE 12-0-2000; IN COMMERCE 12-0-2000.

SN 76-262,791. FRED MEYER STORES, INC., PORTLAND, OR. FILED 5-25-2001.

CURFEW COLORS

OWNER OF U.S. REG. NOS. 1,727,713 AND 2,461,594.
NO CLAIM IS MADE TO THE EXCLUSIVE RIGHT TO USE "COLORS", APART FROM THE MARK AS SHOWN.

CLASS 3—COSMETICS AND CLEANING PREPARATIONS

FOR LIPSTICK; LIP GLOSS; EYE SHADOW; COSMETIC PENCILS, NAMELY, EYE AND LIP; EYE DUST; BODY GLITTER; FACE POWDER; NAIL ENAMEL; NAIL POLISH; COSMETIC COMPACTS, CONTAINING EYE SHADOW AND LIP GLOSS; COSMETIC GIFT SETS CONTAINING VARIOUS COSMETICS (U.S. CLS. 1, 4, 6, 50, 51 AND 52).

CLASS 21—HOUSEWARES AND GLASS

FOR COSMETIC BRUSHES (U.S. CLS. 2, 13, 23, 29, 30, 33, 40 AND 50).

CLASS 35—ADVERTISING AND BUSINESS

FOR RETAIL STORE SERVICES IN THE FIELD OF COSMETICS (U.S. CLS. 100, 101 AND 102).

SN 76-263,078. P.J. LISAC & ASSOCIATES, INC., CLACKAMAS, OR. FILED 5-24-2001.

VEGGEMON**CLASS 16—PAPER GOODS AND PRINTED MATTER**

FOR PAPER GOODS, NAMELY, BOOKMARKS, POSTERS, NEWSLETTERS FEATURING INFORMATION ABOUT SOYBEAN PRODUCTS, COMIC BOOKS, AND STICKERS (U.S. CLS. 2, 5, 22, 23, 29, 37, 38 AND 50).

CLASS 25—CLOTHING

FOR CLOTHING, NAMELY, SHIRTS, PANTS, CAPS, AND NECKWEAR (U.S. CLS. 22 AND 39).

CLASS 28—TOYS AND SPORTING GOODS

FOR PLAYTHINGS, NAMELY DOLLS, STUFFED TOYS, TOY FIGURES, AND BOARD GAMES (U.S. CLS. 22, 23, 38 AND 50).

CLASS 29—MEATS AND PROCESSED FOODS

FOR SOYBEAN DERIVATIVE NONDAIRY CHEESE SUBSTITUTE PRODUCTS, NAMELY, SOY FOOD BEVERAGES, MEAT AND MEAT SUBSTITUTES (U.S. CL. 46).

SN 76-264,466. NEV FUTURE SHAPES PTY LTD, MERMAID BEACH, 4218 QLD, AUSTRALIA, FILED 5-30-2001.

NEV

OWNER OF AUSTRALIA REG. NO. 543201, DATED 10-2-1990, EXPIRES 10-2-2007.

OWNER OF AUSTRALIA REG. NO. 543199, DATED 10-2-1990, EXPIRES 10-2-2007.

CLASS 25—CLOTHING

FOR CLOTHING, NAMELY, SHORTS, BOARD SHORTS, WALK SHORTS, TROUSERS, SWIMWEAR, TRACK PANTS, DRESSES, SKIRTS, DRESS SHIRTS, T-SHIRTS, SWEAT SHIRTS, SOCKS, CAPS, VISORS, HATS AND FOOTWEAR (U.S. CLS. 22 AND 39).

CLASS 28—TOYS AND SPORTING GOODS

FOR SPORTING GOODS, NAMELY, SURFBOARDS, SURFBOARD FINS, SURFSKIS, BODY BOARDS, MALIBU BOARDS, LONG BOARDS, SAIL BOARDS AND STRUCTURAL PARTS FOR THE AFOREMENTIONED GOODS; LEG ROPES AND TETHERS FOR BOARDS; WAXES FOR BOARDS AND SKIS (U.S. CLS. 22, 23, 38 AND 50).

SN 76-264,690. HEYANITA INC., LOS ANGELES, CA. FILED 5-30-2001.



CLASS 38—COMMUNICATION

FOR ELECTRONIC TRANSMISSION OF DATA AND DOCUMENTS VIA COMPUTER TERMINALS, SPECIFICALLY, ALLOWING ACCESS TO AND RETRIEVAL OF DATA AND INFORMATION FROM THE INTERNET, LOCAL COMPUTER NETWORKS, OR ELECTRONIC DATABASES THROUGH THE USE OF VOICE-ACTIVATED NETWORK PORTALS, COMPUTERS, PERSONAL DIGITAL ASSISTANTS, AND MOBILE OR CONVENTIONAL TELEPHONES (U.S. CLS. 100, 101 AND 104).

FIRST USE 2-7-2000; IN COMMERCE 2-7-2000.

CLASS 42—SCIENTIFIC, COMPUTER AND LEGAL SERVICES

FOR COMPUTER SERVICES, NAMELY, PROVIDING SEARCH ENGINES FOR OBTAINING DATA ON A GLOBAL COMPUTER NETWORK; COMPUTER SOFTWARE DEVELOPMENT SERVICES, NAMELY, DEVELOPING SOFTWARE ALLOWING ACCESS TO AND RETRIEVAL OF DATA AND INFORMATION THROUGH THE USE OF VOICE-ACTIVATED NETWORK PORTALS, COMPUTERS, PERSONAL DIGITAL ASSISTANTS, AND MOBILE OR CONVENTIONAL TELEPHONES (U.S. CLS. 100 AND 101).

FIRST USE 2-7-2000; IN COMMERCE 2-7-2000.

SN 76-265,823. PRIMAL ELEMENTS, INC., GARDEN GROVE, CA. FILED 6-1-2001.

IN A LATHER

CLASS 3—COSMETICS AND CLEANING PREPARATIONS

FOR NON-MEDICATED BATH SOAPS AND TOILET SOAPS; NON-MEDICATED SKIN CREAMS AND LOTION; PERFUME AND PERFUME OILS (U.S. CLS. 1, 4, 6, 50, 51 AND 52).

CLASS 4—LUBRICANTS AND FUELS

FOR CANDLES (U.S. CLS. 1, 6 AND 15).

SN 76-265,939. MADISON SQUARE GARDEN CHEERING FOR CHILDREN FOUNDATION, NEW YORK, NY. FILED 6-1-2001.

MADISON SQUARE GARDEN CHEERING FOR CHILDREN FOUNDATION

OWNER OF U.S. REG. NOS. 1,354,235, 2,020,986 AND 2,247,939.

NO CLAIM IS MADE TO THE EXCLUSIVE RIGHT TO USE "FOUNDATION", APART FROM THE MARK AS SHOWN.

CLASS 25—CLOTHING

FOR CLOTHING, NAMELY, SHIRTS, T-SHIRTS, PANTS, JACKETS AND CAPS (U.S. CLS. 22 AND 39).

FIRST USE 1-0-1998; IN COMMERCE 1-0-1998.

CLASS 36—INSURANCE AND FINANCIAL

FOR CHARITABLE FUNDRAISING (U.S. CLS. 100, 101 AND 102).

FIRST USE 12-0-1997; IN COMMERCE 12-0-1997.

CLASS 42—SCIENTIFIC, COMPUTER AND LEGAL SERVICES

FOR CHARITABLE SERVICES, NAMELY, PROVIDING EDUCATIONAL MATERIALS, AFTER-SCHOOL EDUCATIONAL AND ENTERTAINMENT PROGRAMS TO BENEFIT CHILDREN (U.S. CLS. 100 AND 101).

FIRST USE 12-0-1997; IN COMMERCE 12-0-1997.

SN 76-266,562. AIRPRIME, INC., SANTA CLARA, CA. FILED 6-4-2001.

AIRPRIME

CLASS 9—ELECTRICAL AND SCIENTIFIC APPARATUS

FOR COMPUTER SOFTWARE, NAMELY, SOFTWARE FOR USE IN FACILITATING WIRELESS COMMUNICATION AND DATA TRANSMISSION BETWEEN PORTABLE HARDWARE DEVICES VIA WIRELESS FREQUENCY BANDS; COMPUTER HARDWARE, NAMELY, MODULES FOR USE IN FACILITATING WIRELESS COMMUNICATION BETWEEN PORTABLE HARDWARE DEVICES VIA WIRELESS FREQUENCY BANDS (U.S. CLS. 21, 23, 26, 36 AND 38).

CLASS 35—ADVERTISING AND BUSINESS

FOR LICENSING OF COMPUTER HARDWARE AND SOFTWARE FOR USE IN FACILITATING WIRELESS COMMUNICATION AND DATA TRANSMISSION BETWEEN PORTABLE HARDWARE DEVICES VIA WIRELESS FREQUENCY BANDS (U.S. CLS. 100, 101 AND 102).

CLASS 38—COMMUNICATION

FOR ELECTRONIC TRANSMISSION OF MESSAGES AND DATA VIA WIRELESS FREQUENCY BANDS (U.S. CLS. 100, 101 AND 104).

CLASS 42—SCIENTIFIC, COMPUTER AND LEGAL SERVICES

FOR COMPUTER SERVICES, NAMELY DESIGN FOR OTHERS OF COMPUTER HARDWARE AND SOFTWARE FOR USE IN FACILITATING WIRELESS COMMUNICATION AND DATA TRANSMISSION BETWEEN PORTABLE HARDWARE DEVICES VIA WIRELESS FREQUENCY BANDS (U.S. CLS. 100 AND 101).

CLASS 38—COMMUNICATION

FOR PROVIDING ON-LINE ELECTRONIC BULLETIN BOARDS AND CHAT ROOMS FOR TRANSMISSION OF MESSAGES AMONG COMPUTER USERS CONCERNING COMPUTERS AND STUDY GROUPS AND INSTRUCTOR SUPPORT FOR COMPUTER AND INFORMATION TECHNOLOGY CLASSES (U.S. CLS. 100, 101 AND 104).

CLASS 41—EDUCATION AND ENTERTAINMENT

FOR EDUCATIONAL SERVICES, NAMELY, CONDUCTING COURSES RELATED TO THE USE OF COMPUTER SOFTWARE AND HARDWARE AND PROVIDING TRAINING IN PROFESSIONAL SKILLS IN THE USE OF COMPUTER SOFTWARE AND HARDWARE; PROVIDING ON-LINE COURSES IN THE USE OF COMPUTER SOFTWARE AND HARDWARE AND THE ON-LINE DISTRIBUTION OF COURSE MATERIALS TOGETHER THEREWITH (U.S. CLS. 100, 101 AND 107).

SN 76-267,599. KAUFMAN, RON, SINGAPORE 469977, SINGAPORE, FILED 6-6-2001.

UP YOUR SERVICE!**CLASS 9—ELECTRICAL AND SCIENTIFIC APPARATUS**

FOR PRERECORDED PHONOGRAPH RECORDS, VIDEOTAPES, AUDIOTAPES, AUDIO CASSETTES, VIDEOCASSETTES, COMPACT DISCS, AND DVD'S FEATURING INFORMATION RELATING TO BUSINESS MANAGEMENT AND ORGANIZATIONAL DEVELOPMENT (U.S. CLS. 21, 23, 26, 36 AND 38).

CLASS 16—PAPER GOODS AND PRINTED MATTER

FOR SERIES OF NON-FICTION BOOKS FOR BUSINESS MANAGEMENT AND ORGANIZATIONAL DEVELOPMENT; GREETING CARDS, BUMPER STICKERS, BOOK COVERS, NOTEBOOKS, PENCILS, AND PENS (U.S. CLS. 2, 5, 22, 23, 29, 37, 38 AND 50).

CLASS 41—EDUCATION AND ENTERTAINMENT

FOR EDUCATIONAL AND ENTERTAINMENT SERVICES, NAMELY, CONDUCTING PRESENTATIONS, WORKSHOPS, AND ONGOING TELEVISION AND RADIO SHOWS IN THE FIELD OF BUSINESS MANAGEMENT AND ORGANIZATIONAL DEVELOPMENT (U.S. CLS. 100, 101 AND 107).

CLASS 42—SCIENTIFIC, COMPUTER AND LEGAL SERVICES

FOR COMPUTER SERVICES, NAMELY, PROVIDING INTERNET-BASED FACILITIES FOR THE DELIVERY OF TRAINING CONTENT TO STUDENTS IN THE FIELD OF COMPUTER TRAINING, NAMELY, MANAGING AND TRACKING STUDENTS' PERFORMANCE WHEN TAKING WEB-BASED TRAINING COURSES, AND ALLOWING STUDENTS, INSTRUCTORS, AND ADMINISTRATORS TO ACCESS DATA THAT REPRESENTS THE RESULTS OF COURSEWARE TAKEN OVER A GLOBAL COMPUTER NETWORK, AND MAKE QUERIES AGAINST THIS STORED DATA TO ALLOW EVALUATIONS TO BE PERFORMED AGAINST THE EFFECTIVENESS OF WEB-BASED TRAINING; PROVIDING INTERACTIVE, ON-LINE NEWSLETTERS THAT ARE ACCESSED VIA A GLOBAL COMPUTER NETWORK AND FEATURING INFORMATION ON COMPUTERS; PROVIDING INTERACTIVE, ON-LINE TECHNICAL REFERENCES AND LINKS TO INFORMATION RELATED TO COMPUTERS AND INFORMATION TECHNOLOGY; AND PROVIDING ON-LINE TECHNICAL SUPPORT (U.S. CLS. 100 AND 101).

SN 76-269,017. ARCHEMIX CORPORATION, BOSTON, MA. FILED 6-8-2001.

SN 76-268,836. NEW HORIZONS EDUCATION CORPORATION, ANAHEIM, CA. FILED 6-8-2001.

**NEW HORIZONS
CLASSROOM LEARNING**

OWNER OF U.S. REG. NOS. 1,337,233, 2,064,665 AND 2,281,596.

NO CLAIM IS MADE TO THE EXCLUSIVE RIGHT TO USE "CLASSROOM LEARNING", APART FROM THE MARK AS SHOWN.

CLASS 16—PAPER GOODS AND PRINTED MATTER

FOR PRINTED INSTRUCTIONAL MATERIALS PERTAINING TO THE USE OF COMPUTER SOFTWARE AND HARDWARE (U.S. CLS. 2, 5, 22, 23, 29, 37, 38 AND 50).

RIBOREPORTER**CLASS 5—PHARMACEUTICALS**

FOR MEDICAL DIAGNOSTIC REAGENTS; BIOSENSORS AND MOLECULAR PROFILING ARRAYS AND ASSAYS FOR MEDICAL DIAGNOSTIC USE (U.S. CLS. 6, 18, 44, 46, 51 AND 52).

CLASS 42—SCIENTIFIC, COMPUTER AND LEGAL SERVICES

FOR PHARMACEUTICAL DEVELOPMENT AND RESEARCH FOR OTHERS; RESEARCH AND DEVELOPMENT OF NEW PRODUCTS FOR OTHERS IN THE FIELDS OF PHARMACEUTICALS, DRUG DISCOVERY AND DIAGNOSTIC TECHNOLOGIES (U.S. CLS. 100 AND 101).

SN 76-269,215. COLEMAN POWERMATE, INC., KEARNEY, NE. FILED 6-8-2001.

POWERMATE

CLASS 4—LUBRICANTS AND FUELS

FOR LUBRICATING OILS FOR USE WITH MACHINERY (U.S. CLS. 1, 6 AND 15).
FIRST USE 4-0-1995; IN COMMERCE 4-0-1995.

CLASS 7—MACHINERY

FOR NOZZLES FOR AIR SANDERS; REGULATORS FOR USE WITH AIR TOOLS; HOSE CONNECTORS AND COUPLERS FOR USE WITH AIR TOOLS; GRINDING STONES FOR USE WITH AIR TOOLS; SPRAY GUNS, CAULKING GUNS; SAND BLASTERS; COMBINATION FILTER, REGULATOR AND LUBRICATOR FOR USE WITH AIR TOOLS; MAGNETIC STARTERS, CHISELS FOR USE WITH AIR HAMMERS; SOCKET SETS FOR USE WITH AIR TOOLS; PORTABLE AIR TANKS FOR USE WITH AIR TOOLS (U.S. CLS. 13, 19, 21, 23, 31, 34 AND 35).
FIRST USE 4-0-1995; IN COMMERCE 4-0-1995.

CLASS 9—ELECTRICAL AND SCIENTIFIC APPARATUS

FOR AIR TANKS USED IN DIVING (U.S. CLS. 21, 23, 26, 36 AND 38).
FIRST USE 4-0-1995; IN COMMERCE 4-0-1995.

CLASS 17—RUBBER GOODS

FOR AIR HOSES (U.S. CLS. 1, 5, 12, 13, 35 AND 50).
FIRST USE 4-0-1995; IN COMMERCE 4-0-1995.

SN 76-269,533. TCHOUNGUI, GISELE, DBA "ENTREPRISE GLOBAL TRADE", QUEBEC, CANADA, FILED 6-8-2001.

TRYUS LIKUS

PRIORITY CLAIMED UNDER SEC. 44(D) ON CANADA APPLICATION NO. 1100869, FILED 4-27-2001.

CLASS 35—ADVERTISING AND BUSINESS

FOR IMPORT AND EXPORT AGENCIES; DEVELOPING PROMOTIONAL CAMPAIGNS FOR BUSINESS; PUBLIC RELATIONS; MARKET RESEARCH; MARKET ANALYSIS; PROMOTING THE SALE OF GOODS AND SERVICES OF OTHERS THROUGH FESTIVALS, DIRECT MAIL MARKETING, AND EDUCATIONAL FUNDING; TYPING; PROOFREADING; ELECTRONIC PROCESSING OF DOCUMENTS FOR OTHERS, NAMELY COMPUTERIZED WORD PROCESSING, DATA PROCESSING SERVICES, DOCUMENT REPRODUCTION, AND RECORDS MANAGEMENT SERVICES, NAMELY, DOCUMENT INDEXING FOR OTHERS (U.S. CLS. 100, 101 AND 102).
FIRST USE 9-0-1997; IN COMMERCE 9-0-1997.

CLASS 36—INSURANCE AND FINANCIAL

FOR CHARITABLE FUND RAISING (U.S. CLS. 100, 101 AND 102).
FIRST USE 9-0-1997; IN COMMERCE 9-0-1997.

CLASS 42—SCIENTIFIC, COMPUTER AND LEGAL SERVICES

FOR CUSTOM WRITING SERVICES; WRITTEN TEXT EDITING; TECHNICAL WRITING FOR OTHERS; LANGUAGE TRANSLATION (U.S. CLS. 100 AND 101).
FIRST USE 9-0-1997; IN COMMERCE 9-0-1997.

SN 76-269,819. BANK ONE CORPORATION, CHICAGO, IL. FILED 6-11-2001.

AUDITOR ASSISTANT

NO CLAIM IS MADE TO THE EXCLUSIVE RIGHT TO USE "AUDITOR", APART FROM THE MARK AS SHOWN.

CLASS 9—ELECTRICAL AND SCIENTIFIC APPARATUS

FOR COMPUTER SOFTWARE FOR USE IN AUDIT PLANNING, AUDIT EXECUTION, AND DOCUMENT STORAGE (U.S. CLS. 21, 23, 26, 36 AND 38).
FIRST USE 2-0-1998; IN COMMERCE 2-0-1998.

CLASS 42—SCIENTIFIC, COMPUTER AND LEGAL SERVICES

FOR COMPUTER CONSULTATION AND COMPUTER SOFTWARE DESIGN SERVICES RELATING TO AUDIT PLANNING, AUDIT EXECUTION AND DOCUMENT STORAGE (U.S. CLS. 100 AND 101).
FIRST USE 2-0-1998; IN COMMERCE 2-0-1998.

SN 76-270,115. HERCULES PRODUCTS, INC., AVENTURA, FL. FILED 6-12-2001.

HERCULES CAR

NO CLAIM IS MADE TO THE EXCLUSIVE RIGHT TO USE "CAR", APART FROM THE MARK AS SHOWN.

CLASS 12—VEHICLES

FOR AUTOMOBILE ACCESSORIES, NAMELY, AUTOMOBILE WIPERS AND WIPER BLADES; AUTOMOBILE SEAT COVERS; AND AUTOMOBILE REAR VIEW MIRRORS (U.S. CLS. 19, 21, 23, 31, 35 AND 44).
FIRST USE 5-2-2001; IN COMMERCE 5-2-2001.

CLASS 17—RUBBER GOODS

FOR TINTED, LAMINATED, AND REFLECTIVE PLASTIC FILMS FOR USE ON AUTOMOBILE WINDOWS (U.S. CLS. 1, 5, 12, 13, 35 AND 50).
FIRST USE 5-2-2001; IN COMMERCE 5-2-2001.

CLASS 20—FURNITURE AND ARTICLES NOT OTHERWISE CLASSIFIED

FOR AUTOMOBILE SHADES (U.S. CLS. 2, 13, 22, 25, 32 AND 50).
FIRST USE 5-2-2001; IN COMMERCE 5-2-2001.

CLASS 27—FLOOR COVERINGS

FOR AUTOMOBILE MATS AND CARPETING (U.S. CLS. 19, 20, 37, 42 AND 50).
FIRST USE 5-2-2001; IN COMMERCE 5-2-2001.

SN 76-270,932. NEXANT, INC., SAN FRANCISCO, CA. FILED 6-12-2001.



OWNER OF U.S. REG. NO. 2,387,648.

CLASS 9—ELECTRICAL AND SCIENTIFIC APPARATUS

FOR COMPUTER SOFTWARE FOR USE IN THE ANALYSIS OF POWER SYSTEM NETWORK OPERATION FOR THE ENERGY INDUSTRY (U.S. CLS. 21, 23, 26, 36 AND 38).

CLASS 35—ADVERTISING AND BUSINESS

FOR BUSINESS AND ECONOMIC MANAGEMENT CONSULTATION SERVICES TO THE ENERGY, CHEMICAL, PETROLEUM, AND ENVIRONMENTAL MANAGEMENT INDUSTRIES; PROVIDING BUSINESS INFORMATION TO OTHERS VIA THE INTERNET FOR USE IN THE ENERGY, CHEMICAL, PETROLEUM, AND ENVIRONMENTAL MANAGEMENT INDUSTRIES (U.S. CLS. 100, 101 AND 102).

CLASS 36—INSURANCE AND FINANCIAL

FOR FINANCIAL CONSULTATION SERVICES TO THE ENERGY, CHEMICAL, PETROLEUM, AND ENVIRONMENTAL MANAGEMENT INDUSTRIES; PROVIDING FINANCIAL INFORMATION TO OTHERS VIA THE INTERNET FOR USE IN THE ENERGY, CHEMICAL, PETROLEUM, AND ENVIRONMENTAL MANAGEMENT INDUSTRIES (U.S. CLS. 100, 101 AND 102).

CLASS 42—SCIENTIFIC, COMPUTER AND LEGAL SERVICES

FOR ENGINEERING AND TECHNICAL CONSULTATION, AND RESEARCH AND DEVELOPMENT SERVICES, TO THE ENERGY, CHEMICAL, PETROLEUM, AND ENVIRONMENTAL MANAGEMENT INDUSTRIES; PROVIDING TECHNICAL AND ENGINEERING INFORMATION TO OTHERS VIA THE INTERNET FOR USE IN THE ENERGY, CHEMICAL, PETROLEUM, AND ENVIRONMENTAL MANAGEMENT INDUSTRIES (U.S. CLS. 100 AND 101).

SN 76-271,052. WALWORKS CORPORATION, INC., NASHVILLE, TN. FILED 6-13-2001.



NO CLAIM IS MADE TO THE EXCLUSIVE RIGHT TO USE "WALLPAPER SOLUTIONS" IN INTERNATIONAL CLASS 1, AND "WALLPAPER" IN INTERNATIONAL CLASS 8, APART FROM THE MARK AS SHOWN.

CLASS 1—CHEMICALS

FOR ADHESIVES AND CHEMICALS FOR APPLYING AND REMOVING WALL COVERINGS, WALLPAPERS AND BORDERS (U.S. CLS. 1, 5, 6, 10, 26 AND 46).

CLASS 8—HAND TOOLS

FOR HAND-POWERED TOOLS FOR APPLYING AND REMOVING WALL COVERINGS, WALLPAPER AND BORDERS, NAMELY BRUSHES, SPONGES, AND SCRAPER, LEVELING AND SMOOTHING TOOLS (U.S. CLS. 23, 28 AND 44).

SN 76-274,320. ABELL CORPORATION, MONROE, LA. FILED 6-20-2001.



CLASS 20—FURNITURE AND ARTICLES NOT OTHERWISE CLASSIFIED

FOR MOLDED POLYOLEFIN TANKS AND CONTAINERS USED FOR TRANSPORTING LIQUIDS AND SOLIDS (U.S. CLS. 2, 13, 22, 25, 32 AND 50).
FIRST USE 3-8-2000; IN COMMERCE 3-8-2000.

CLASS 40—MATERIAL TREATMENT

FOR CUSTOM MOLDING SERVICES, NAMELY, ROTOMOLDING SERVICES UNDER CONTRACT TO OTHERS (U.S. CLS. 100, 103 AND 106).
FIRST USE 3-8-2000; IN COMMERCE 3-8-2000.

SN 76-274,718. DIAMOND, NEIL, SANTA MONICA, CA. FILED 6-20-2001.

NEIL DIAMOND

CLASS 9—ELECTRICAL AND SCIENTIFIC APPARATUS

FOR SERIES OF MUSICAL SOUND RECORDINGS, MUSICAL VIDEO RECORDINGS, DOWNLOADABLE MUSICAL SOUND RECORDINGS, DOWNLOADABLE MUSICAL VIDEO RECORDINGS, SUNGLASSES AND EYEGLASSES (U.S. CLS. 21, 23, 26, 36 AND 38).
FIRST USE 0-0-1963; IN COMMERCE 0-0-1963.

CLASS 16—PAPER GOODS AND PRINTED MATTER

FOR POSTERS, PRINTED MATERIALS, NAMELY, CALENDARS, STATIONERY; SCHOOL SUPPLIES, NAMELY WRITING INSTRUMENTS; SHEET MUSIC; SONG BOOKS, NOTEPADS, STICKERS, ADDRESS BOOKS, APPOINTMENT BOOKS, DECALS, ART ETCHINGS, BOOKMARKS, BUMPER STICKERS, CARICATURES, TOUR BOOKS, TOUR PROGRAMS, PHOTO ANTHOLOGY BOOKS AND BIOGRAPHY BOOKS (U.S. CLS. 2, 5, 22, 23, 29, 37, 38 AND 50).
FIRST USE 0-0-1966; IN COMMERCE 0-0-1966.

CLASS 25—CLOTHING

FOR CLOTHING, NAMELY T-SHIRTS, JACKETS, HEADWEAR, SHIRTS (U.S. CLS. 22 AND 39).
FIRST USE 0-0-1976; IN COMMERCE 0-0-1976.

CLASS 38—COMMUNICATION

FOR STREAMING OF AUDIO AND VIDEO MATERIAL ON THE INTERNET ON THE SUBJECT OF MUSICAL ARTISTS AND THEIR RECORDINGS (U.S. CLS. 100, 101 AND 104).
FIRST USE 6-20-2001; IN COMMERCE 6-20-2001.

CLASS 41—EDUCATION AND ENTERTAINMENT

FOR PRODUCTION OF MUSICAL SOUND AND VIDEO RECORDINGS; ENTERTAINMENT SERVICES, NAMELY, PROVIDING A WEBSITE OF INFORMATION ON MUSICAL ARTISTS, THEIR RECORDINGS, THEIR BIOGRAPHIES, AND OTHER INFORMATION ON MUSICAL ARTISTS AND MUSICAL SOUND AND VIDEO RECORDINGS, LIVE MUSICAL PERFORMANCES AND CONDUCTING A SERIES OF LIVE MUSICAL CONCERTS, MUSIC PUBLISHING SERVICES (U.S. CLS. 100, 101 AND 107).

FIRST USE 0-0-1967; IN COMMERCE 0-0-1967.

SN 76-274,872. ARTISAN ENTERTAINMENT INC., SANTA MONICA, CA. FILED 6-21-2001.

YOGA FUSION

NO CLAIM IS MADE TO THE EXCLUSIVE RIGHT TO USE "YOGA", APART FROM THE MARK AS SHOWN.

CLASS 9—ELECTRICAL AND SCIENTIFIC APPARATUS

FOR PRE-RECORDED VIDEO CASSETTES AND DVDS IN THE FIELD OF EXERCISE AND FITNESS (U.S. CLS. 21, 23, 26, 36 AND 38).

CLASS 41—EDUCATION AND ENTERTAINMENT

FOR CONDUCTING CLASSES IN THE FIELD OF EXERCISE AND FITNESS (U.S. CLS. 100, 101 AND 107).

SN 76-275,185. REEBOK INTERNATIONAL LIMITED, LANCASTER LA1 1GF, ENGLAND, FILED 6-25-2001.

REEBOK UNIVERSITY

OWNER OF U.S. REG. NOS. 1,133,704, 2,217,838 AND OTHERS.

NO CLAIM IS MADE TO THE EXCLUSIVE RIGHT TO USE "UNIVERSITY", APART FROM THE MARK AS SHOWN.

CLASS 9—ELECTRICAL AND SCIENTIFIC APPARATUS

FOR VIDEO CASSETTES IN THE FIELD OF FITNESS (U.S. CLS. 21, 23, 26, 36 AND 38).
FIRST USE 1-0-1993; IN COMMERCE 1-0-1993.

CLASS 16—PAPER GOODS AND PRINTED MATTER

FOR INSTRUCTIONAL MANUALS IN THE FIELD OF FITNESS, AND POSTERS (U.S. CLS. 2, 5, 22, 23, 29, 37, 38 AND 50).

FIRST USE 1-0-1993; IN COMMERCE 1-0-1993.

CLASS 41—EDUCATION AND ENTERTAINMENT

FOR ORGANIZING AND CONDUCTING CLASSES, SEMINARS, AND WORKSHOPS IN THE FIELD OF FITNESS (U.S. CLS. 100, 101 AND 107).

FIRST USE 1-0-1993; IN COMMERCE 1-0-1993.

SN 76-276,027. TATARI, M. GHIATH, D-65428 RUSSELSHEIM, FED REP GERMANY, FILED 6-25-2001.

MAX GORDON

OWNER OF FED REP GERMANY REG. NO. 39873513, DATED 3-9-1999, EXPIRES 12-31-2008.

THE NAME "MAX GORDON" DOES NOT IDENTIFY A LIVING INDIVIDUAL.

CLASS 3—COSMETICS AND CLEANING PREPARATIONS

FOR PERFUMERY, COSMETICS (U.S. CLS. 1, 4, 6, 50, 51 AND 52).

CLASS 14—JEWELRY

FOR JEWELRY (U.S. CLS. 2, 27, 28 AND 50).

CLASS 25—CLOTHING

FOR CLOTHING, NAMELY, SHIRTS, PULLOVERS, SLACKS, TROUSERS, JACKETS, SCARFS, HEAD-SCARFS, T-SHIRTS, PANTS, VETS, SHORTS, BELTS, SOCKS, STOCKINGS; FOOTWEAR; HEADGEAR, NAMELY, HATS, HEADBANDS, CAPS, AND HOODS (U.S. CLS. 22 AND 39).

SN 76-276,369. METROPOLITAN TRANSPORTATION AUTHORITY, NEW YORK, NY. FILED 6-22-2001.

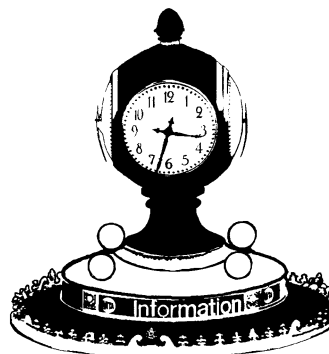

THE STIPLING IS A FEATURE OF THE MARK AND NOT INTENDED TO INDICATE COLOR.

THE MARK IS COMPRISED OF A TWO-DIMENSIONAL REPRESENTATION OF THE THREE DIMENSIONAL INFORMATION BOOTH CLOCK LOCATED WITHIN THE MAIN CONCOURSE AT GRAND CENTRAL TERMINAL.

CLASS 16—PAPER GOODS AND PRINTED MATTER

FOR PAPERWEIGHTS, POSTERS, POSTCARDS, ART PRINTS, STATIONERY AND PLAYING CARDS (U.S. CLS. 2, 5, 22, 23, 29, 37, 38 AND 50).

CLASS 25—CLOTHING

FOR CLOTHING, NAMELY, T-SHIRTS, SHIRTS, SWEATSHIRTS, CAPS AND HATS (U.S. CLS. 22 AND 39).

CLASS 28—TOYS AND SPORTING GOODS

FOR CHRISTMAS TREE ORNAMENTS (U.S. CLS. 22, 23, 38 AND 50).

CLASS 36—INSURANCE AND FINANCIAL

FOR LEASING OF RETAIL SPACE, REAL ESTATE MANAGEMENT AND RETAIL MALL MANAGEMENT SERVICES (U.S. CLS. 100, 101 AND 102).

CLASS 39—TRANSPORTATION AND STORAGE

FOR RAILROAD TRANSPORTATION SERVICES AND OPERATION OF A RAILROAD TERMINAL (U.S. CLS. 100 AND 105).

CLASS 42—SCIENTIFIC, COMPUTER AND LEGAL SERVICES

FOR PROVIDING FACILITIES AND SPACE FOR EXHIBITIONS, FESTIVALS AND CONCERTS (U.S. CLS. 100 AND 101).

SN 76-276,745. BEST GMBH, FED REP GERMANY, FILED 6-26-2001.

BEST SCREENPROOF

CLASS 9—ELECTRICAL AND SCIENTIFIC APPARATUS

FOR COMPUTER SOFTWARE, FOR USE IN THE FIELDS OF DESKTOP PUBLISHING, ELECTRONIC PUBLISHING, PLOTTING, GRAPHICAL MANIPULATION AND TYPESETTING, FOR CONTROLLING AND MANAGING COLOR OUTPUT TO COMPUTER PRINTERS AND PRINTER INTERFACES (U.S. CLS. 21, 23, 26, 36 AND 38).

CLASS 16—PAPER GOODS AND PRINTED MATTER

FOR COMPUTER PROGRAM MANUALS FOR USE WITH DATABASE MANAGEMENT AND PRINTING SOFTWARE USED IN THE FIELDS OF DESKTOP PUBLISHING, ELECTRONIC PUBLISHING, PLOTTING, GRAPHICAL MANIPULATION AND TYPESETTING; CATALOGS FEATURING COMPUTER SOFTWARE; BROCHURES AND LEAFLETS WITH INFORMATION REGARDING DATABASE MANAGEMENT AND PRINTING SOFTWARE USED IN THE FIELDS OF DESKTOP PUBLISHING, ELECTRONIC PUBLISHING, PLOTTING, GRAPHICAL MANIPULATION AND TYPESETTING (U.S. CLS. 2, 5, 22, 23, 29, 37, 38 AND 50).

CLASS 42—SCIENTIFIC, COMPUTER AND LEGAL SERVICES

FOR COMPUTER PROGRAMMING FOR OTHERS; TECHNICAL SUPPORT SERVICES, NAMELY, TROUBLESHOOTING OF COMPUTER SOFTWARE PROBLEMS; PROVIDING ON-LINE SUPPORT SERVICES FOR COMPUTER SOFTWARE USERS, NAMELY, CONSULTING SERVICES, TROUBLESHOOTING SERVICES AND HELP DESK SERVICES; PROVIDING AN ON-LINE DATABASE ACCESSIBLE OVER A GLOBAL COMPUTER NETWORK IN THE FIELD OF SOFTWARE USED FOR DESKTOP PUBLISHING, ELECTRONIC PUBLISHING, PLOTTING, GRAPHICAL MANIPULATION AND TYPESETTING (U.S. CLS. 100 AND 101).

SN 76-277,773. MEDPANEL, INC., CAMBRIDGE, MA. FILED 6-28-2001.

MP MARKETCAST

CLASS 38—COMMUNICATION

FOR PROVIDING AN ASYNCHRONOUS THREADED DISCUSSION VIA A GLOBAL COMPUTER NETWORK FOR THE TRANSMISSION OF MESSAGES AMONG COMPUTER USERS CONCERNING MEDICAL INFORMATION, NAMELY, AN ONLINE FORUM ALLOWING COMPANIES, EDUCATIONAL INSTITUTIONS, AND GOVERNMENTAL BODIES TO PARTICIPATE IN A THREADED DISCUSSION IN THE FIELD OF MEDICINE (U.S. CLS. 100, 101 AND 104).

FIRST USE 11-1-2000; IN COMMERCE 11-1-2000.

CLASS 42—SCIENTIFIC, COMPUTER AND LEGAL SERVICES

FOR PROVIDING MEDICAL INFORMATION, NAMELY, PROVIDING OPINIONS OF PHYSICIANS TO COMPANIES, EDUCATIONAL INSTITUTIONS, AND GOVERNMENTAL BODIES VIA A GLOBAL COMPUTER NETWORK (U.S. CLS. 100 AND 101).

FIRST USE 11-1-2000; IN COMMERCE 11-1-2000.

SN 76-277,979. NAM LIONG ENTERPRISE CO., LTD., YUNG KANG CITY, TAINAN, TAIWAN, FILED 6-28-2001.

SEAMATE

CLASS 9—ELECTRICAL AND SCIENTIFIC APPARATUS

FOR DIVING EQUIPMENT, NAMELY, HELMETS, GLOVES, BOOTS, DIVING SUITS, REGULATOR MOUTHPIECE; SAFETY JACKETS; LIFE BUOYS (U.S. CLS. 21, 23, 26, 36 AND 38).

CLASS 25—CLOTHING

FOR PANTIES; SWIMSUITS; SHIRTS; T SHIRTS; SNOWSUITS; LOUNGEWEAR; DANCING DRESS; AEROBIC DANCING DRESS; RAIN COATS; SPORTSWEAR, NAMELY, SHIRTS AND PANTS; SHOES; SANDALS; CANVAS SHOES; SPORTS SHOES; RUBBER SHOES; RUNNING SHOES; BOOTS; SNEAKERS; CLIMBING BOOTS; SKI BOOTS; CASUAL SHOES, BEACH SANDALS; INSOLES; VAMPS; SHOE TONGUES (U.S. CLS. 22 AND 39).

CLASS 28—TOYS AND SPORTING GOODS

FOR ATHLETIC EQUIPMENT, NAMELY, KNEEPADS FOR SPORTING USE, WRIST PROTECTORS FOR SPORTING USE, CHEST PROTECTORS, HAND PROTECTORS, ELBOW PADS, ARM PROTECTORS, LEG GUARDS, SHIN GUARDS, ANKLE EXTENSIONS, HIP PADS, ABDOMEN PADS; BAGS FOR HOLDING EQUIPMENT FOR TENNIS, BASEBALL, VOLLEYBALL, SOFTBALL, BOWLING, TABLE TENNIS, AND BADMINTON; DIVING EQUIPMENT, NAMELY, GOGGLES, MASKS, RUBBER FLIPPERS (U.S. CLS. 22, 23, 38 AND 50).

SN 76-277,980. NAM LIONG ENTERPRISE CO., LTD., YUNG KANG CITY, TAINAN, TAIWAN, FILED 6-28-2001.



THE MARK CONSISTS IN PART OF A STYLIZED REPRESENTATION OF THE LETTERS 'NL'.

CLASS 9—ELECTRICAL AND SCIENTIFIC APPARATUS

FOR DIVING EQUIPMENT, NAMELY, HELMETS, GLOVES, BOOTS, DIVING SUITS, REGULATOR MOUTHPIECE; SAFETY JACKETS; LIFE BUOYS (U.S. CLS. 21, 23, 26, 36 AND 38).

CLASS 25—CLOTHING

FOR PANTIES; SWIMSUITS; SHIRTS; T-SHIRTS; SNOWSUITS; LOUNGEWEAR; DANCING DRESS; AEROBIC DANCING DRESS; RAIN COATS; SPORTSWEAR, NAMELY, SHIRTS AND PANTS; SHOES; SANDALS; CANVAS SHOES; SPORTS SHOES; RUBBER SHOES; RUNNING SHOES; BOOTS; SNEAKERS; CLIMBING BOOTS; SKI BOOTS; CASUAL SHOES; BEACH SANDALS; INSOLES; VAMPS; SHOE TONGUES (U.S. CLS. 22 AND 39).

CLASS 28—TOYS AND SPORTING GOODS

FOR ATHLETIC EQUIPMENT, NAMELY, KNEEPADS FOR SPORTING USE, WRIST PROTECTORS FOR SPORTING USE, CHEST PROTECTORS, HAND PROTECTORS, ELBOW PADS, ARM PROTECTORS, LEG GUARDS, SHIN GUARDS, ANKLE EXTENSIONS, HIP PADS, ABDOMEN PADS; BAGS FOR HOLDING EQUIPMENT FOR TENNIS, BASEBALL, VOLLEYBALL, SOFTBALL, BOWLING, TABLE TENNIS, AND BADMINTON; DIVING EQUIPMENT, NAMELY, GOGGLES, MASKS, RUBBER FLIPPERS (U.S. CLS. 22, 23, 38 AND 50).

SN 76-282,468. PARFUMERIE DOUGLAS GMBH, 58099 HAGEN, FED REP GERMANY, FILED 7-10-2001.

DOUGLAS ACADEMY

OWNER OF FED REP GERMANY REG. NO. 30051532, DATED 10-12-2000, EXPIRES 7-31-2010.

OWNER OF U.S. REG. NOS. 1,284,711 AND 1,289,434. NO CLAIM IS MADE TO THE EXCLUSIVE RIGHT TO USE "ACADEMY", APART FROM THE MARK AS SHOWN.

CLASS 3—COSMETICS AND CLEANING PREPARATIONS

FOR PERFUME, ESSENTIAL OILS FOR PERSONAL USE, BODY LOTIONS, ANTI-AGING CREAMS, ANTI-WRINKLE CREAMS, BODY CREAMS, BODY MASK CREAMS, COLD CREAMS, CUTICLE CREAMS, EYE CREAMS, HAIR REMOVING CREAMS, HAND CREAMS, LIP CREAMS, NAIL CREAMS, NIGHT CREAMS, NON-MEDICATED FOOT CREAMS, NON-MEDICATED HAIR CARE AND HAIR CONDITIONING PREPARATIONS, HAIR TONICS, NON-MEDICATED SCALP TREATMENT CREAMS, SHAVING CREAMS, SKIN CLEANSING CREAMS, SKIN CREAMS, VANISHING CREAMS, BODY MASK CREAMS, BODY MASK LOTIONS, BODY MASK POWDERS, EYE MAKEUP, EYE MAKEUP REMOVER, FACIAL MAKEUP, FOUNDATION MAKEUP, MAKEUP, AND DENTIFRICES (U.S. CLS. 1, 4, 6, 50, 51 AND 52).

CLASS 41—EDUCATION AND ENTERTAINMENT

FOR EDUCATION SERVICES IN THE NATURE OF LECTURES AND LABORATORY WORK IN RELATION TO THE APPLICATION OF SKIN CARE BEAUTY COSMETIC PRODUCTS AND DECORATIVE COSMETIC PRODUCTS (U.S. CLS. 100, 101 AND 107).

CLASS 42—SCIENTIFIC, COMPUTER AND LEGAL SERVICES

FOR HAIRDRESSING AND BEAUTY SALON SERVICES, BEAUTY CARE ADVISORY SERVICES, AND NUTRITION ADVISORY SERVICES (U.S. CLS. 100 AND 101).

SN 76-282,469. PARFUMERIE DOUGLAS GMBH, 58099 HAGEN, FED REP GERMANY, FILED 7-10-2001.

DOUGLAS BEAUTY ACADEMY

OWNER OF FED REP GERMANY REG. NO. 30051531, DATED 12-10-2000, EXPIRES 7-31-2010.

OWNER OF U.S. REG. NOS. 1,284,711 AND 1,289,434. NO CLAIM IS MADE TO THE EXCLUSIVE RIGHT TO USE "BEAUTY ACADEMY", APART FROM THE MARK AS SHOWN.

CLASS 3—COSMETICS AND CLEANING PREPARATIONS

FOR PERFUME, ESSENTIAL OILS FOR PERSONAL USE, BODY LOTIONS, ANTI-AGING CREAMS, ANTI-WRINKLE CREAMS, BODY CREAMS, BODY MASK CREAMS, COLD CREAMS, CUTICLE CREAMS, EYE CREAMS, HAIR REMOVING CREAMS, HAND CREAMS, LIP CREAMS, NAIL CREAMS, NIGHT CREAMS, NON-MEDICATED FOOT CREAMS, NON-MEDICATED HAIR CARE AND HAIR CONDITIONING PREPARATIONS, HAIR TONICS, NON-MEDICATED SCALP TREATMENT CREAMS, SHAVING CREAMS, SKIN CLEANSING CREAMS, SKIN CREAMS, VANISHING CREAMS, BODY MASK CREAMS, BODY MASK LOTIONS, BODY MASK POWDERS, EYE MAKEUP, EYE MAKEUP REMOVER, FACIAL MAKEUP, FOUNDATION MAKEUP, MAKEUP, AND DENTIFRICES (U.S. CLS. 1, 4, 6, 50, 51 AND 52).

CLASS 41—EDUCATION AND ENTERTAINMENT

FOR EDUCATION SERVICES IN THE NATURE OF LECTURES AND LABORATORY WORK IN RELATION TO THE APPLICATION OF SKIN CARE BEAUTY COSMETIC PRODUCTS AND DECORATIVE COSMETIC PRODUCTS (U.S. CLS. 100, 101 AND 107).

CLASS 42—SCIENTIFIC, COMPUTER AND LEGAL SERVICES

FOR HAIRDRESSING AND BEAUTY SALON SERVICES, BEAUTY CARE ADVISORY SERVICES, AND NUTRITION ADVISORY SERVICES (U.S. CLS. 100 AND 101).

SN 76-282,565. I HUNT MEDIA, LLC, CHANHASSEN, MN. FILED 7-9-2001.

I HUNT

CLASS 9—ELECTRICAL AND SCIENTIFIC APPARATUS

FOR PRERECORDED VIDEOTAPES RELATED TO THE SPORT OF HUNTING, BINOCULARS; OPTICAL AND TELESCOPIC LENS SIGHTS (U.S. CLS. 21, 23, 26, 36 AND 38).

CLASS 16—PAPER GOODS AND PRINTED MATTER

FOR BOOKS, NEWSLETTERS, MAGAZINES, ALL IN THE FIELD OF HUNTING, BUMPER STICKERS AND WINDOW DECALS (U.S. CLS. 2, 5, 22, 23, 29, 37, 38 AND 50).

CLASS 25—CLOTHING

FOR MEN'S, WOMEN'S, AND CHILDREN'S CLOTHING, NAMELY, SHIRTS, PANTS, HATS, CAPS, SHOES, BOOTS, JACKETS, COATS, SWEATSHIRTS AND SWEATPANTS (U.S. CLS. 22 AND 39).

CLASS 41—EDUCATION AND ENTERTAINMENT

FOR ENTERTAINMENT SERVICES IN THE NATURE OF ONGOING TELEVISION PROGRAMS IN THE FIELD OF HUNTING, PUBLICATION OF BOOKS, MAGAZINES AND NEWSLETTERS IN THE FIELD OF HUNTING, AND ORGANIZING EXHIBITIONS IN THE FIELD OF HUNTING (U.S. CLS. 100, 101 AND 107).

SN 76-285,219. METATOMIX, INC., WALTHAM, MA. FILED 7-13-2001.

**BUSINESS VISIBILITY
DASHBOARD**

NO CLAIM IS MADE TO THE EXCLUSIVE RIGHT TO USE "BUSINESS VISIBILITY", APART FROM THE MARK AS SHOWN.

CLASS 9—ELECTRICAL AND SCIENTIFIC APPARATUS

FOR COMPUTER HARDWARE AND COMPUTER SOFTWARE USED FOR THE COMPILATION, ORGANIZATION AND MANAGEMENT OF BUSINESS INFORMATION REGARDING CUSTOMERS AND SUPPLIERS AND THEIR RESPECTIVE PRODUCTS AND SERVICES IN THE FIELDS OF ELECTRONIC COMMERCE, MARKETING, AND BUSINESS MANAGEMENT INFORMATION SYSTEMS (U.S. CLS. 21, 23, 26, 36 AND 38).

CLASS 35—ADVERTISING AND BUSINESS

FOR BUSINESS CONSULTING SERVICES IN THE FIELDS OF ELECTRONIC COMMERCE, MANAGEMENT INFORMATION SYSTEMS, AND THE COMPILATION, ORGANIZATION, MANAGEMENT AND USE OF INFORMATION REGARDING CUSTOMERS AND SUPPLIERS AND THEIR RESPECTIVE PRODUCTS AND SERVICES (U.S. CLS. 100, 101 AND 102).

SN 76-286,648. AGI CORPORATION, TAOYUAN HSIEN, TAIWAN, FILED 7-18-2001.

AgiSyn

CLASS 2—PAINTS

FOR PAINT PRIMER; PRINTERS' INK; SHELLAC FOR USE AS A SURFACE COATING; SHELLAC FOR USE IN THE MANUFACTURE OF HAIR SPRAYS; UNDERCOATING FOR SURFACES TO BE PAINTED; VARNISH; WOOD PRESERVATIVES (U.S. CLS. 6, 11 AND 16).

CLASS 17—RUBBER GOODS

FOR SEMI-FINISHED ACRYLIC MOLDED PLASTIC SUBSTANCES, FOR USE IN AUTOMOBILE PV, PP, AND PE; ACRYLIC RESIN SHEETING FOR USE IN THE MANUFACTURE OF LAMINATED GLASS; ACRYLIC SHEETING FOR USE IN THE MANUFACTURE OF UV VARNISH AND UV COATING; ADHESIVE BANDS FOR SEALING CARTONS FOR INDUSTRIAL OR COMMERCIAL USE; ADHESIVE SEALANT AND CAULKING COMPOUND; ADHESIVE SEALANTS FOR GENERAL USE; CELLULOSE ACETATE FILM USED IN THE MANUFACTURE OF ADHESIVE TAPE; ADHESIVE TAPE FOR INDUSTRIAL OR COMMERCIAL USE; ADHESIVE TAPE FOR INDUSTRIAL OR COMMERCIAL PACKING USE; ADHESIVE TAPE FOR ADHESIVE TAPE FOR SEALING CARTONS FOR INDUSTRIAL OR COMMERCIAL USE; MASKING FILM FOR USE IN PHOTOGRAPHY AND GRAPHIC ARTS; PLASTIC FILM FOR INDUSTRIAL AND COMMERCIAL PACKAGING USE; FILM USED AS INDUSTRIAL OR COMMERCIAL PACKING; JOINT PACKING FOR FPP INDUSTRIAL; GRAPHITE PACKING FOR PUMPS, GASKETS, AND VALVES; PLASTIC PACKING FOR SHIPPING CONTAINERS; ASBESTOS PACKING FOR VALVES AND PISTONS; PACKING MATERIAL FOR FORMING SEALS, NAMELY, PLASTIC PACKING FOR ELECTRONIC INDUSTRY; PACKING PADDING OF PLASTIC FOR SHIPPING CONTAINERS; PACKING PADDING OF RUBBER FOR SHIPPING CONTAINERS; POLYURETHANE FILE FOR USE IN GLASS LAMINATIONS; RUBBER BAGS FOR MERCHANDISE PACKAGING, NAMELY, ENVELOPES OR POUCHES (U.S. CLS. 1, 5, 12, 13, 35 AND 50).

SN 76-286,784. MIDDLE TENNESSEE STATE UNIVERSITY, MURFREESBORO, TN. FILED 7-18-2001.



CLASS 16—PAPER GOODS AND PRINTED MATTER

FOR PAPER GOODS AND PRINTED MATTER, NAMELY SPIRAL NOTEBOOKS, RING BINDERS, PENS, PENCILS, AND DECALS (U.S. CLS. 2, 5, 22, 23, 29, 37, 38 AND 50).

FIRST USE 3-1-1998; IN COMMERCE 3-1-1998.

CLASS 25—CLOTHING

FOR CLOTHING, NAMELY, ATHELETIC UNIFORMS, CAPS, CHEERLEADING UNIFORMS, GYM SHORTS, RAINWEAR, SHIRTS, SLEEPWEAR, SWEATSHIRTS, AND TEE-SHIRTS (U.S. CLS. 22 AND 39).

FIRST USE 3-1-1998; IN COMMERCE 3-1-1998.

SN 76-287,044. DAIMLERCHRYSLER AG, 70567 STUTTGART, FED REP GERMANY, FILED 7-18-2001.

CECELL

PRIORITY CLAIMED UNDER SEC. 44(D) ON FED REP GERMANY APPLICATION NO. 30103097.912, FILED 1-18-2001, REG. NO. 30103097, DATED 3-26-2001, EXPIRES 6-30-2009.

CLASS 12—VEHICLES

FOR AUTOMOBILES AND STRUCTURAL PARTS THEREFOR (U.S. CLS. 19, 21, 23, 31, 35 AND 44).

CLASS 28—TOYS AND SPORTING GOODS

FOR TOY MODEL AUTOMOBILES (U.S. CLS. 22, 23, 38 AND 50).

CLASS 37—CONSTRUCTION AND REPAIR

FOR REPAIR AND MAINTENANCE OF AUTOMOBILES (U.S. CLS. 100, 103 AND 106).

SN 76-289,878. LOWE OCEAN HAMMOCK, LTD., LOS ANGELES, CA. FILED 7-25-2001.

CINNAMON BEACH

CLASS 36—INSURANCE AND FINANCIAL

FOR REAL ESTATE MANAGEMENT SERVICES, REAL ESTATE BROKERAGE SERVICES AND REAL ESTATE LEASING SERVICES (U.S. CLS. 100, 101 AND 102).

CLASS 37—CONSTRUCTION AND REPAIR

FOR REAL ESTATE DEVELOPMENT SERVICES (U.S. CLS. 100, 103 AND 106).

SN 76-290,078. ERNST & YOUNG U.S. LLP, NEW YORK, NY. FILED 7-24-2001.

PEOPLE POINT

CLASS 35—ADVERTISING AND BUSINESS

FOR BUSINESS CONSULTING SERVICES IN THE FIELD OF HUMAN RESOURCES, NAMELY, EVALUATING PERSONNEL (U.S. CLS. 100, 101 AND 102).

CLASS 41—EDUCATION AND ENTERTAINMENT

FOR EDUCATIONAL SERVICES, NAMELY, CONDUCTING SEMINARS IN THE FIELD OF LEADERSHIP DEVELOPMENT AND EVALUATION, AND PROVIDING COURSE MATERIALS IN CONNECTION THEREWITH (U.S. CLS. 100, 101 AND 107).

CLASS 42—SCIENTIFIC, COMPUTER AND LEGAL SERVICES

FOR PROVIDING TEMPORARY USE OF ONLINE NON-DOWNLOADABLE SOFTWARE FOR ALLOWING EMPLOYEES TO EVALUATE COMPANY LEADERS AND KEY PERSONNEL (U.S. CLS. 100 AND 101).

SN 76-290,651. KROGER CO. OF MICHIGAN, THE, LIVONIA, MI. BY ASSIGNMENT FRED MEYER STORES, INC., PORTLAND, OR. FILED 7-24-2001.

HD DESIGNS OUTDOORS

NO CLAIM IS MADE TO THE EXCLUSIVE RIGHT TO USE "DESIGNS OUTDOORS", APART FROM THE MARK AS SHOWN.

CLASS 21—HOUSEWARES AND GLASS

FOR ACRYLIC DRINKWARE (U.S. CLS. 2, 13, 23, 29, 30, 33, 40 AND 50).

CLASS 28—TOYS AND SPORTING GOODS

FOR GAME PLAYING EQUIPMENT FOR VOLLEYBALL, BADMINTON, HORSESHOES, LAWN TENNIS, BOCCÉ BALL, CROQUET, TETHER BALL, TABLE TENNIS AND RING TOSS (U.S. CLS. 22, 23, 38 AND 50).

SN 76-291,280. PAIR-OF-DIMES, LLC, DBA THE OLSEN GROUP, BAINBRIDGE ISLAND, WA. FILED 7-26-2001.

MYLIFEROX

CLASS 9—ELECTRICAL AND SCIENTIFIC APPARATUS

FOR COMPUTER SOFTWARE, NAMELY, COMPUTER OPERATED DEVELOPMENT TOOL SET ACCESSED VIA APPLICANT'S WEB SITE FOR IMPLEMENTING A USER'S PERSONAL PERFORMANCE PARAMETERS AND MONITORING RESULTS (U.S. CLS. 21, 23, 26, 36 AND 38).

CLASS 41—EDUCATION AND ENTERTAINMENT

FOR EDUCATIONAL SERVICES IN THE FIELD OF CONDUCTING EDUCATION SEMINARS, NAMELY, SELF-ENHANCEMENT SEMINARS AND PERSONAL DEVELOPMENT, INCLUDING INSTRUCTIONAL WORKBOOKS DISTRIBUTED AS PART OF THE SEMINAR OR WORKSHOP AND COMPUTERIZED DEVELOPMENT TOOL SET ACCESSED VIA APPLICANT'S WEB SITE AS PART OF THE SEMINAR OR WORKSHOP (U.S. CLS. 100, 101 AND 107).

SN 76-291,421. IMMOBILIARIA APOPA, S.A. DE C.V., SAN SALVADOR, EL SALVADOR, FILED 7-27-2001.

HILCASA

OWNER OF EL SALVADOR REG. NO. 011992003737, DATED 1-17-1997, EXPIRES 1-17-2007.

CLASS 23—YARNS AND THREADS

FOR COTTON THREAD AND POLYESTER THREAD (U.S. CL. 43).

CLASS 24—FABRICS

FOR TEXTILE FABRIC FOR THE MANUFACTURE OF CLOTHING, COTTON FABRIC AND POLYESTER FABRIC (U.S. CLS. 42 AND 50).

SN 76-291,480. DESIGN ROOM, INC., CLEVELAND, OH. FILED 7-30-2001.



THE STIPPLING IS FOR SHADING PURPOSES ONLY AND DOES NOT INDICATE COLOR.

CLASS 35—ADVERTISING AND BUSINESS

FOR ADVERTISING SERVICES, NAMELY PREPARATION OF ADVERTISEMENTS AND BUSINESS PROMOTION MATERIALS FOR OTHERS FOR USE IN PRINT ADVERTISING, INTERNET ADVERTISING, TRADE SHOW ADVERTISING AND OTHER ELECTRONIC ADVERTISING (U.S. CLS. 100, 101 AND 102).

CLASS 42—SCIENTIFIC, COMPUTER AND LEGAL SERVICES

FOR GRAPHIC DESIGN SERVICES, NAMELY PREPARATION OF GRAPHICS FOR OTHERS FOR USE IN BUSINESS PROMOTION AND COMMUNICATION MATERIALS (U.S. CLS. 100 AND 101).

SN 76-292,107. WOODS OF WINDSOR LIMITED, READING BERKSHIRE, UNITED KINGDOM, FILED 7-30-2001.



lee stafford

THE NAME "LEE STAFFORD" IDENTIFIES A LIVING INDIVIDUAL WHOSE CONSENT IS OF RECORD. THE MARK CONSISTS OF THE IMAGE OF A DOG OVER THE WORDS "LEE STAFFORD"

CLASS 21—HOUSEWARES AND GLASS

FOR HAIR COMBS; HAIR BRUSHES; EYELASH COMBS; CASES FOR COMBS AND BRUSHES (U.S. CLS. 2, 13, 23, 29, 30, 33, 40 AND 50).

CLASS 26—FANCY GOODS

FOR HAIR ACCESSORIES, NAMELY, HAIR GRIPS, HAIR BANDS, AND HAIR ORNAMENTS (U.S. CLS. 37, 39, 40, 42 AND 50).

SN 76-294,180. BRIGGS & STRATTON CORPORATION, WAUWATOSA, WI. FILED 8-1-2001.

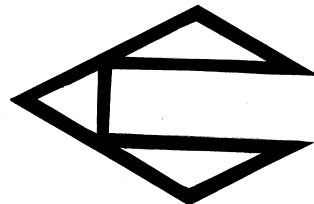

THE MARK CONSISTS OF THREE TRIANGLES.

CLASS 7—MACHINERY

FOR INTERNAL COMBUSTION ENGINES NOT FOR LAND VEHICLES; OUTDOOR POWER EQUIPMENT, NAMELY, ENGINE POWERED LAWN AND GARDEN TILLERS, POWER LEAF BLOWERS, LAWN AND GARDEN SHREDDERS, LAWN AND GARDEN EDGERS, ENGINE DRIVEN GENERATORS, MULTI-PURPOSE HIGH PRESSURE WASHERS, AIR COMPRESSORS, FLUID PUMPS, CHAIN SAWS AND SNOW BLOWERS; COMPRESSORS FOR MACHINES; ELECTRIC GENERATORS; LAWN MOWERS; ELECTRIC MOTORS FOR MACHINES; INTERNAL COMBUSTION ENGINES FOR LAND VEHICLES; AND STRUCTURAL PARTS FOR THE AFORESAID GOODS (U.S. CLS. 13, 19, 21, 23, 31, 34 AND 35).

CLASS 9—ELECTRICAL AND SCIENTIFIC APPARATUS

FOR ELECTRIC ARC WELDERS, ELECTRONIC CONTROLS FOR MOTORS, BATTERIES AND STRUCTURAL PARTS THEREFOR (U.S. CLS. 21, 23, 26, 36 AND 38).

CLASS 12—VEHICLES

FOR MOTORIZED SCOOTERS; MOTOR BIKES; MOTORCYCLES; VEHICLE TRANSMISSIONS; LAWN TRACTORS; AND STRUCTURAL PARTS FOR THE AFORESAID GOODS (U.S. CLS. 19, 21, 23, 31, 35 AND 44).

SN 76-295,295. COCA-COLA COMPANY, THE, ATLANTA, GA. FILED 8-3-2001.

COCA-COLA FAN LOT

OWNER OF U.S. REG. NOS. 238,145, 1,752,201 AND OTHERS.

NO CLAIM IS MADE TO THE EXCLUSIVE RIGHT TO USE "FAN LOT", APART FROM THE MARK AS SHOWN.

CLASS 32—LIGHT BEVERAGES

FOR SOFT DRINKS, SYRUPS AND CONCENTRATES FOR USE IN THE PREPARATION OF SOFT DRINKS (U.S. CLS. 45, 46 AND 48).

FIRST USE 3-1-2000; IN COMMERCE 3-1-2000.

CLASS 41—EDUCATION AND ENTERTAINMENT

FOR ENTERTAINMENT SERVICES IN THE NATURE OF AN INTERACTIVE AREA AT BASEBALL STADIUMS, NAMELY A STRUCTURE COMPOSED OF WOOD BEAMS, CLIMBING AREAS AND SLIDES; ENTERTAINMENT IN THE NATURE OF A YOUTH BASEBALL THEME PARK FEATURING MINIATURE BASEBALL FIELDS ON WHICH CHILDREN CAN HIT, RUN AND CATCH BASEBALLS; AND ENTERTAINMENT SERVICES, NAMELY, PROVIDING STATIC EXHIBITS OF EMBOSSED SIGNATURES OF FAMOUS BASEBALL PLAYERS THAT CAN BE RUBBED TO CREATE AUTOGRAPHS (U.S. CLS. 100, 101 AND 107).

FIRST USE 3-1-2000; IN COMMERCE 3-1-2000.

SN 76-295,619. LANE LABS-USA, INC., ALLENDALE, NJ. FILED 8-8-2001.

TOKI

THE ENGLISH TRANSLATION OF "TOKI" IS "YOUR FACE LOOKS LIKE PORCELAIN".

CLASS 3—COSMETICS AND CLEANING PREPARATIONS

FOR WRINKLE REMOVING SKIN CARE PREPARATIONS (U.S. CLS. 1, 4, 6, 50, 51 AND 52).

CLASS 5—PHARMACEUTICALS

FOR DIETARY SUPPLEMENT (U.S. CLS. 6, 18, 44, 46, 51 AND 52).

SN 76-297,388. WEDEVAG TOOLS AB, 711 72 VEDEVAG, SWEDEN, FILED 8-8-2001.



"WEDEVAG" MEANS "FOREST LAKE" IN SWEDISH.

CLASS 7—MACHINERY

FOR METAL CUTTING MACHINE TOOLS, NAMELY, TWIST DRILLS, TWIST DRILL POINT GRINDING MACHINES, ROAMERS AND BROACHES (U.S. CLS. 13, 19, 21, 23, 31, 34 AND 35).

FIRST USE 0-0-1791; IN COMMERCE 0-0-1960.

CLASS 8—HAND TOOLS

FOR METAL CUTTING HAND POWDERED TOOLS, NAMELY, TWIST DRILLS, TWIST DRILL POINT GRINDING TOOLS, ROAMERS AND BROACHES (U.S. CLS. 23, 28 AND 44).

FIRST USE 0-0-1791; IN COMMERCE 0-0-1960.

SN 76-297,389. WEDEVAG TOOLS AB, 711 72 VEDEVAG, SWEDEN, FILED 8-8-2001.

WEDEVAG

"WEDEVAG" MEANS "FOREST LAKE" IN SWEDISH.

CLASS 7—MACHINERY

FOR METAL CUTTING MACHINE TOOLS, NAMELY, TWIST DRILLS, TWIST DRILL POINT GRINDING MACHINES, ROAMERS AND BROACHES (U.S. CLS. 13, 19, 21, 23, 31, 34 AND 35).

FIRST USE 0-0-1791; IN COMMERCE 0-0-1960.

CLASS 8—HAND TOOLS

FOR METAL CUTTING HAND POWERED TOOLS, NAMELY, TWIST DRILLS, TWIST DRILL POINT GRINDING TOOLS, ROAMERS AND BROACHES (U.S. CLS. 23, 28 AND 44).

FIRST USE 0-0-1791; IN COMMERCE 0-0-1960.

SN 76-298,594. MICKEY'S LINEN & TOWEL SUPPLY, INC., CHICAGO, IL. FILED 8-13-2001.

CARETEX

CLASS 37—CONSTRUCTION AND REPAIR

FOR COMMERCIAL LAUNDRY SERVICES FOR UNIFORM CLOTHING AND LINEN (U.S. CLS. 100, 103 AND 106).

CLASS 42—SCIENTIFIC, COMPUTER AND LEGAL SERVICES

FOR LINEN AND UNIFORM RENTAL SERVICES (U.S. CLS. 100 AND 101).

SN 76-299,705. HALTER PROPERTIES LLC, PASO ROBLES, CA. FILED 8-13-2001.

DOS WYSS

THE ENGLISH TRANSLATION OF "DOS" IS "TWO".

CLASS 31—NATURAL AGRICULTURAL PRODUCTS

FOR FRESH GRAPES (U.S. CLS. 1 AND 46).

CLASS 33—WINES AND SPIRITS

FOR WINES (U.S. CLS. 47 AND 49).

CLASS 35—ADVERTISING AND BUSINESS

FOR DISTRIBUTORSHIPS IN THE FIELDS OF WINES AND GRAPES IN BULK (U.S. CLS. 100, 101 AND 102).

CLASS 42—SCIENTIFIC, COMPUTER AND LEGAL SERVICES

FOR CULTIVATION OF GRAPES TO ORDER AND SPECIFICATION OF OTHERS AND VINEYARD SERVICES (U.S. CLS. 100 AND 101).

SN 76-299,806. CORN PRODUCTS INTERNATIONAL, INC., BEDFORD PARK, IL. FILED 8-14-2001.

BIOLIGO

CLASS 1—CHEMICALS

FOR OLIGOSACCHARIDES FOR USE IN THE MANUFACTURE OF DAIRY PRODUCTS, PRESERVES, BAKED GOODS AND CONFECTIONERY, PET FOODS AND NON-ALCOHOLIC BEVERAGES (U.S. CLS. 1, 5, 6, 10, 26 AND 46).

CLASS 29—MEATS AND PROCESSED FOODS

FOR DAIRY PRODUCTS EXCLUDING ICE CREAM, ICE MILK AND FROZEN YOGURT, AND FRUIT PRESERVES CONTAINING OLIGOSACCHARIDES AS AN INTEGRAL COMPONENT THEREOF (U.S. CL. 46).

CLASS 30—STAPLE FOODS

FOR BREAD, BISCUITS, CAKES, PASTRY AND CONFECTIONERY CHIPS FOR BAKING, AND TEA-BASED BEVERAGES WITH FRUIT FLAVORING CONTAINING OLIGOSACCHARIDES AS AN INTEGRAL COMPONENT THEREOF (U.S. CL. 46).

CLASS 31—NATURAL AGRICULTURAL PRODUCTS

FOR OLIGOSACCHARIDES SOLD AS AN INTEGRAL COMPONENT OF PET FOODS (U.S. CLS. 1 AND 46).

CLASS 32—LIGHT BEVERAGES

FOR NON-ALCOHOLIC MALT BEVERAGES, VEGETABLE JUICE AND COLAS CONTAINING OLIGOSACCHARIDES AS AN INTEGRAL COMPONENT THEREOF (U.S. CLS. 45, 46 AND 48).

SN 76-300,575. LIFELONG LEARNING, INC., DBA PROJECT CRISS, KALISPELL, MT. FILED 8-17-2001.

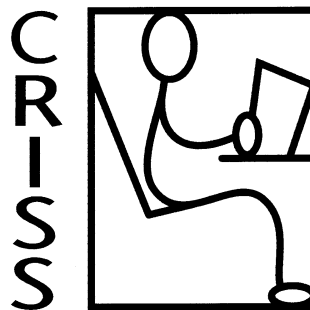

CLASS 35—ADVERTISING AND BUSINESS

FOR RETAIL STORE SERVICES FEATURING WATER BOTTLES, COFFEE MUGS, T-SHIRTS, AND COMPUTER SUPPLIES (U.S. CLS. 100, 101 AND 102).

CLASS 41—EDUCATION AND ENTERTAINMENT

FOR EDUCATIONAL SERVICES, NAMELY, TRAINING TEACHERS IN LEARNING STRATEGIES ACROSS THE CURRICULUM AND ACROSS K-12 GRADE LEVELS; COURSE MATERIALS IN THE NATURE OF TRAINING MANUALS, POSTERS, AND OTHER PAPER SUPPORT MATERIALS ARE PROVIDED THEREWITH (U.S. CLS. 100, 101 AND 107).

SN 76-302,722. VEGA WAVE SYSTEMS, INC., WARREN-VILLE, IL. FILED 8-21-2001.

SN 76-304,849. ONTARIO KNIFE COMPANY, FRANKLIN-VILLE, NY. FILED 8-24-2001.



CLASS 9—ELECTRICAL AND SCIENTIFIC APPARATUS

FOR COMPONENTS AND EQUIPMENT USED IN OPTICAL COMMUNICATIONS SYSTEMS, NAMELY, OPTICAL TRANSMITTERS, OPTICAL RECEIVERS, OPTICAL MODULATORS, OPTICAL SWITCHES, INTEGRATED OPTICAL CIRCUITS; COMPONENTS AND EQUIPMENT USED IN WIRELESS COMMUNICATIONS SYSTEMS, NAMELY, TRANSISTORS AND INTEGRATED CIRCUITS FOR RADIO-FREQUENCY AMPLIFIERS, OSCILLATORS, FILTERS, MIXERS, TRANSMITTERS, AND RECEIVERS (U.S. CLS. 21, 23, 26, 36 AND 38).

CLASS 40—MATERIAL TREATMENT

FOR MANUFACTURE OF OPTICAL AND WIRELESS COMMUNICATIONS COMPONENTS AND EQUIPMENT TO THE SPECIFICATIONS AND ORDERS OF OTHERS (U.S. CLS. 100, 103 AND 106).

CLASS 42—SCIENTIFIC, COMPUTER AND LEGAL SERVICES

FOR DESIGN OF OPTICAL AND WIRELESS COMMUNICATIONS COMPONENTS AND EQUIPMENT FOR OTHERS (U.S. CLS. 100 AND 101).

SN 76-304,609. ENTREPRENEUR AMERICA, LLC, HAMILTON, MT. FILED 8-24-2001.

ROARING LION

CLASS 35—ADVERTISING AND BUSINESS

FOR BUSINESS CONSULTING AND MANAGEMENT (U.S. CLS. 100, 101 AND 102).

CLASS 36—INSURANCE AND FINANCIAL

FOR FINANCIAL MANAGEMENT AND INVESTING SERVICES; VENTURE CAPITAL FUNDING SERVICES TO EMERGING AND START-UP COMPANIES, VENTURE CAPITAL SERVICES, NAMELY, PROVIDING FINANCING TO EMERGING AND START-UP COMPANIES (U.S. CLS. 100, 101 AND 102).

TRU-EDGE

CLASS 8—HAND TOOLS

FOR KITCHEN KNIVES, TABLE KNIVES, BUTCHER KNIVES, SHOE KNIVES, GRAPE KNIVES, PITTING SPOONS, COTTON SAMPLING KNIVES, CORN AND VEGETABLE KNIVES, BEET TOPPING KNIVES, PALLETTE KNIVES, CLEAVERS, PUTTY KNIVES AND PAINT AND WALL SCRAPERS (U.S. CLS. 23, 28 AND 44).

FIRST USE 7-1-1912; IN COMMERCE 7-1-1912.

CLASS 21—HOUSEWARES AND GLASS

FOR HOUSEHOLD UTENSILS, NAMELY SPATULAS (U.S. CLS. 2, 13, 23, 29, 30, 33, 40 AND 50).

FIRST USE 7-1-1912; IN COMMERCE 7-1-1912.

SN 76-304,920. DECISION TECHNOLOGIES INTERNATIONAL, INC., WAPPINGERS FALLS, NY. FILED 8-28-2001.



Decision Technologies INTERNATIONAL

NO CLAIM IS MADE TO THE EXCLUSIVE RIGHT TO USE "DECISION TECHNOLOGIES INTERNATIONAL", APART FROM THE MARK AS SHOWN.

CLASS 9—ELECTRICAL AND SCIENTIFIC APPARATUS

FOR COMPUTER E-COMMERCE SOFTWARE TO ALLOW USERS TO PERFORM ELECTRONIC BUSINESS TRANSACTIONS VIA A GLOBAL COMPUTER NETWORK (U.S. CLS. 21, 23, 26, 36 AND 38).

CLASS 42—SCIENTIFIC, COMPUTER AND LEGAL SERVICES

FOR CONSULTING SERVICES IN THE FIELD OF DESIGN, SELECTION, IMPLEMENTATION AND USE OF COMPUTER HARDWARE AND SOFTWARE SYSTEMS FOR OTHERS (U.S. CLS. 100 AND 101).

SN 76-304,961. WRIGHT, ELDON, PORTAGE, IN. FILED 8-27-2001.

REUNION TRUE SOUTHERN GOSPEL, THE WAY IT USED TO BE

NO CLAIM IS MADE TO THE EXCLUSIVE RIGHT TO USE "SOUTHERN GOSPEL", APART FROM THE MARK AS SHOWN.

CLASS 9—ELECTRICAL AND SCIENTIFIC APPARATUS

FOR AUDIO TAPES AND COMPACT DISCS OF TRADITIONAL SOUTHERN GOSPEL MUSIC PRESENTED BY A MUSICAL GROUP (U.S. CLS. 21, 23, 26, 36 AND 38).

FIRST USE 9-9-1997; IN COMMERCE 9-9-1997.

CLASS 41—EDUCATION AND ENTERTAINMENT

FOR ENTERTAINMENT SERVICES, NAMELY, LIVE PRESENTATION BY A MUSICAL GROUP OF TRADITIONAL SOUTHERN GOSPEL MUSIC (U.S. CLS. 100, 101 AND 107).

FIRST USE 9-9-1997; IN COMMERCE 9-9-1997.

SN 76-307,345. WESSELMANN, PAUL T., MADISON, WI. FILED 8-30-2001.

THE RIPPLES PROJECT**CLASS 16—PAPER GOODS AND PRINTED MATTER**

FOR CARDS AND POSTERS CONTAINING INSPIRATIONAL CONTENT INCLUDING QUOTES, POEMS, SONG LYRICS, AND ESSAYS (U.S. CLS. 2, 5, 22, 23, 29, 37, 38 AND 50).

FIRST USE 7-10-2000; IN COMMERCE 7-18-2000.

CLASS 42—SCIENTIFIC, COMPUTER AND LEGAL SERVICES

FOR COMPUTER SERVICES, NAMELY PROVIDING INSPIRATIONAL CONTENT, QUOTES, POEMS, SONG LYRICS AND ESSAYS VIA THE INTERNET AND ELECTRONIC MAIL (U.S. CLS. 100 AND 101).

FIRST USE 2-7-2000; IN COMMERCE 2-7-2000.

SN 76-307,683. CUSTOM GREENERY, INC., CHATTANOOGA, TN. FILED 8-31-2001.



**CUSTOM
GREENERY**

SEC. 2(F) AS TO "CUSTOM GREENERY".

CLASS 26—FANCY GOODS

FOR ARTIFICIAL PLANTS AND FLOWERS (U.S. CLS. 37, 39, 40, 42 AND 50).

FIRST USE 4-1-1995; IN COMMERCE 6-10-1995.

CLASS 40—MATERIAL TREATMENT

FOR MANUFACTURE OF ARTIFICIAL PLANTS AND FLOWERS TO THE ORDER AND/OR SPECIFICATION OF OTHERS (U.S. CLS. 100, 103 AND 106).

FIRST USE 4-1-1995; IN COMMERCE 6-10-1995.

SN 76-308,195. HORMEL FOODS, LLC, AUSTIN, MN. FILED 8-30-2001.

CHILI MASTER

OWNER OF U.S. REG. NO. 1,907,894.

NO CLAIM IS MADE TO THE EXCLUSIVE RIGHT TO USE "CHILI", APART FROM THE MARK AS SHOWN.

CLASS 29—MEATS AND PROCESSED FOODS

FOR CHILI WITH OR WITHOUT BEANS (U.S. CL. 46).

CLASS 30—STAPLE FOODS

FOR SAUCE AND SEASONING MIXTURE WITH OR WITHOUT BEANS AND/OR TOMATOES USED FOR MAKING A HOMESTYLE CHILI (U.S. CL. 46).

SN 76-308,431. VISUAL COORDINATIONS BY CAROLE TALBOTT, INC., HOLLYWOOD, FL. FILED 8-31-2001.

VISUAL COORDINATIONS**CLASS 41—EDUCATION AND ENTERTAINMENT**

FOR EDUCATIONAL SERVICES, NAMELY, CONDUCTING TRAINING SEMINARS, CLASSES AND WORKSHOPS IN THE FIELD OF INTERIOR DECORATING, FURNITURE, ART AND ACCESSORY ARRANGEMENT, (U.S. CLS. 100, 101 AND 107).

FIRST USE 2-26-1996; IN COMMERCE 2-26-1996.

CLASS 42—SCIENTIFIC, COMPUTER AND LEGAL SERVICES

FOR INTERIOR DESIGN, DECORATING AND CUSTOM DESIGN SERVICES; FURNITURE, ART AND ACCESSORY PLACEMENT SERVICES; CUSTOM FLORAL ARRANGEMENT DESIGN SERVICES (U.S. CLS. 100 AND 101).

FIRST USE 2-26-1996; IN COMMERCE 2-26-1996.

SN 76-310,030. TELUS CORPORATION, EDMONTON, ALBERTA T5J 0N5, CANADA, FILED 9-7-2001.

TELUS

OWNER OF U.S. REG. NO. 2,396,640.

CLASS 9—ELECTRICAL AND SCIENTIFIC APPARATUS

FOR DOWNLOADABLE ELECTRONIC PUBLICATIONS IN THE NATURE OF DIRECTORIES AND ADVERTISEMENTS FOR THE SALE OF PRODUCTS AND SERVICES OF OTHERS (U.S. CLS. 21, 23, 26, 36 AND 38).

CLASS 16—PAPER GOODS AND PRINTED MATTER

FOR PRINTED TELEPHONE DIRECTORIES AND ADVERTISEMENTS FOR THE SALE OF PRODUCTS AND SERVICES FOR OTHERS (U.S. CLS. 2, 5, 22, 23, 29, 37, 38 AND 50).

CLASS 35—ADVERTISING AND BUSINESS

FOR ADVERTISING SERVICES, NAMELY THE PRODUCTION AND DISTRIBUTION OF ADVERTISEMENTS FOR THE SALE OF PRODUCTS AND SERVICES FOR OTHERS (U.S. CLS. 100, 101 AND 102).

SN 76-310,335. CERBUCO BREWING INC., W. TORONTO, ONTARIO M5L 1A9, CANADA, FILED 9-7-2001.

MAYABE**CLASS 25—CLOTHING**

FOR WEARING APPAREL FOR MEN AND WOMEN, NAMELY, T-SHIRTS, SWEATSHIRTS, SHIRTS OF ALL KINDS; SWEAT PANTS, SWEAT SUITS, TRACK SUITS, SKI SUITS, SKI JACKETS, SKI PANTS, BATHING SUITS, SHORTS, VESTS, SWEATERS, PANTS, COATS, JACKETS, GLOVES, WRISTBANDS, LEG WARMERS, TIES, BELTS, SUSPENDERS, HEADWEAR, NAMELY, HATS, CAPS, VISORS, EAR MUFFS, HEAD BANDS (U.S. CLS. 22 AND 39).

CLASS 32—LIGHT BEVERAGES

FOR BREWED ALCOHOLIC BEVERAGES, NAMELY, BEER; ALE; PORTER; STOUT AND MALT LIQUOR (U.S. CLS. 45, 46 AND 48).

SN 76-310,594. DLJ LONG TERM INVESTMENT CORPORATION, CHICAGO, IL. FILED 9-7-2001.

PERSHING JAPAN LIMITED

OWNER OF U.S. REG. NO. 2,245,524.
NO CLAIM IS MADE TO THE EXCLUSIVE RIGHT TO USE "JAPAN LIMITED", APART FROM THE MARK AS SHOWN.

CLASS 16—PAPER GOODS AND PRINTED MATTER

FOR BOOKS, PAMPHLETS, PRINTED BULLETINS, MAGAZINES, PRINTED REPORTS, NEWSLETTERS AND BROCHURES CONCERNING FINANCIAL SERVICES AND TOPICS OF INTEREST TO INVESTORS (U.S. CLS. 2, 5, 22, 23, 29, 37, 38 AND 50).

CLASS 36—INSURANCE AND FINANCIAL

FOR BROKERAGE AND DEALER SERVICES IN SECURITIES, BONDS, MUTUAL FUNDS, OTHER INVESTMENT FUNDS, AND COMMODITIES; FINANCIAL ADVISORY AND CONSULTING SERVICES; FINANCIAL INVESTMENT AND MANAGEMENT SERVICES; FINANCIAL RESEARCH AND INFORMATION SERVICES (U.S. CLS. 100, 101 AND 102).

SN 76-312,966. NETBUL ILETISIM HIZMETLERI BILGI VE REKLAM TICARET ANONIM SIRKETI, NISANTASI - ISTANBUL, TURKEY, FILED 9-17-2001.

WWW.NETBUL.COM**CLASS 35—ADVERTISING AND BUSINESS**

FOR ADVERTISING SERVICES, NAMELY, DISSEMINATION OF ADVERTISING FOR OTHERS VIA THE INTERNET; BUSINESS MANAGEMENT SERVICES; BUSINESS ADMINISTRATION SERVICES (U.S. CLS. 100, 101 AND 102).

CLASS 38—COMMUNICATION

FOR TELECOMMUNICATIONS, NAMELY, LONG DISTANCE TELEPHONE SERVICES; CELLULAR PHONE SERVICES; PROVIDING CONNECTIONS TO THE INTERNET; PAGING SERVICES (U.S. CLS. 100, 101 AND 104).

CLASS 42—SCIENTIFIC, COMPUTER AND LEGAL SERVICES

FOR RESTAURANT SERVICES, NAMELY, PROVIDING OF FOOD AND DRINK FOR OTHERS; PROVIDING TEMPORARY HOUSING ACCOMMODATION FOR OTHERS; HYGIENIC AND BEAUTY SERVICES FOR OTHERS; LEGAL SERVICES; PROVIDING OF RESEARCH SERVICES FOR OTHERS IN THE FIELD OF SCIENCE AND INDUSTRIAL TECHNOLOGY; COMPUTER PROGRAMMING FOR OTHERS (U.S. CLS. 100 AND 101).

SN 76-313,125. RACINE INDUSTRIES, INC., RACINE, WI. FILED 9-17-2001.

24/7**CLASS 3—COSMETICS AND CLEANING PREPARATIONS**

FOR CARPET CLEANING PREPARATIONS (U.S. CLS. 1, 4, 6, 50, 51 AND 52).

CLASS 7—MACHINERY

FOR ELECTRIC CARPET CLEANING MACHINERY (U.S. CLS. 13, 19, 21, 23, 31, 34 AND 35).

SN 76-314,609. INSIGHTEC - IMAGE GUIDED TREATMENT LTD., TIRAT CARMEL 39120, ISRAEL, FILED 9-18-2001.

EXABLATE 2000**CLASS 9—ELECTRICAL AND SCIENTIFIC APPARATUS**

FOR COMPUTER SOFTWARE FOR CONTROLLING AND OPERATING IMAGE-GUIDED FOCUSED ULTRASOUND SYSTEMS, AND USER MANUALS SOLD AS A UNIT THEREWITH (U.S. CLS. 21, 23, 26, 36 AND 38).

CLASS 10—MEDICAL APPARATUS

FOR IMAGE-GUIDED FOCUSED ULTRASOUND DIAGNOSTIC APPARATUS FOR THERAPEUTIC AND DIAGNOSTIC MEDICAL PROCEDURES, AND USER MANUALS SOLD AS A UNIT THEREWITH (U.S. CLS. 26, 39 AND 44).

SN 76-315,426. D.F.G. FOODS, L.L.C., OKLAHOMA CITY, OK. FILED 9-21-2001.

RESTAURANIC**CLASS 29—MEATS AND PROCESSED FOODS**

FOR PREPARED, FROZEN AND NON-FROZEN PACKAGED APPETIZERS, HORS D'OEUVRES, SIDE DISHES AND DINNER ENTREES, ALL CONSISTING PRIMARILY OF MEAT, FISH, POULTRY AND/OR FRUITS (U.S. CL. 46).

FIRST USE 8-30-1974; IN COMMERCE 11-17-1980.

CLASS 30—STAPLE FOODS

FOR PREPARED, FROZEN AND NON-FROZEN PACKAGED APPETIZERS, HORS D'OEUVRES, SIDE DISHES AND DINNER ENTREES, ALL CONSISTING PRIMARILY OF BREAD PRODUCTS, STUFFING, RICE, PASTRIES, DOUGHS, SAUCES AND/OR SPICES (U.S. CL. 46).

FIRST USE 8-30-1974; IN COMMERCE 11-17-1980.

SN 76-314,620. INSIGHTEC - IMAGE GUIDED TREATMENT LTD., TIRAT CARMEL 39120, ISRAEL, FILED 9-18-2001.

EXABLATE**CLASS 9—ELECTRICAL AND SCIENTIFIC APPARATUS**

FOR COMPUTER SOFTWARE FOR CONTROLLING AND OPERATING IMAGE-GUIDED FOCUSED ULTRASOUND SYSTEMS, AND USER MANUALS SOLD AS A UNIT THEREWITH (U.S. CLS. 21, 23, 26, 36 AND 38).

CLASS 10—MEDICAL APPARATUS

FOR IMAGE-GUIDED FOCUSED ULTRASOUND DIAGNOSTIC APPARATUS FOR THERAPEUTIC AND DIAGNOSTIC MEDICAL PROCEDURES, AND USER MANUALS SOLD AS A UNIT THEREWITH (U.S. CLS. 26, 39 AND 44).

SN 76-315,613. NATIONAL FOOD PROCESSORS ASSOCIATION, WASHINGTON, DC. FILED 9-21-2001.

SN 76-315,173. DNA WEAR, INC., RICHMOND, CA. FILED 9-21-2001.

ARCHETYPE**CLASS 25—CLOTHING**

FOR MEN'S, WOMEN'S AND CHILDREN'S CLOTHING, NAMELY, PANTS, JEANS, DRESS SLACKS, KNICKERS, SWEATERS, SKIRTS, DRESSES, SHIRTS, BLOUSES, JERSEYS, VEST, JACKETS, COATS, SUITS, SPORT COATS, LEGGINGS, LEOTARDS, SHORTS, UNDERWEAR, LINGERIE, BRASSIERES, HATS, CAPS, SWIMMING AND BATHING SUITS, UNIFORMS, AND MILITARY UNIFORMS (U.S. CLS. 22 AND 39).

CLASS 35—ADVERTISING AND BUSINESS

FOR RETAIL CLOTHING STORE SERVICES (U.S. CLS. 100, 101 AND 102).

CLASS 40—MATERIAL TREATMENT

FOR CUSTOM MANUFACTURING OF CLOTHING (U.S. CLS. 100, 103 AND 106).

CLASS 42—SCIENTIFIC, COMPUTER AND LEGAL SERVICES

FOR DESIGN FOR OTHERS IN THE FIELD OF CLOTHING (U.S. CLS. 100 AND 101).

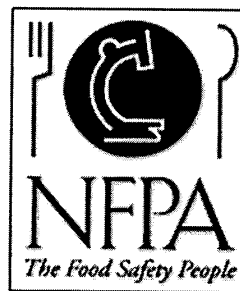

OWNER OF U.S. REG. NO. 2,356,353.
NO CLAIM IS MADE TO THE EXCLUSIVE RIGHT TO USE "THE FOOD SAFETY PEOPLE", APART FROM THE MARK AS SHOWN.

CLASS 41—EDUCATION AND ENTERTAINMENT

FOR PROVIDING SEMINARS, WORKSHOPS AND CONFERENCES ON TOPICS OF INTEREST TO THE FOOD AND FOOD PROCESSING INDUSTRIES, NAMELY FOOD SAFETY AND HANDLING, NUTRITION, FOOD SCIENCE, AND REGULATORY AND CONSUMER AFFAIRS (U.S. CLS. 100, 101 AND 107).

FIRST USE 4-0-1998; IN COMMERCE 4-0-1998.

CLASS 42—SCIENTIFIC, COMPUTER AND LEGAL SERVICES

FOR ASSOCIATION SERVICES, NAMELY, PROMOTING THE INTERESTS OF THE FOOD AND FOOD PROCESSING INDUSTRIES IN THE AREAS OF FOOD SAFETY AND HANDLING, NUTRITION, FOOD SCIENCE, AND REGULATORY AND CONSUMER AFFAIRS; PROVIDING A WIDE RANGE OF INFORMATION VIA THE INTERNET AND OTHER MEANS ON FOOD SAFETY AND HANDLING, NUTRITION, FOOD SCIENCE, AND REGULATORY AND CONSUMER AFFAIRS ISSUES; AND PROMOTING PUBLIC AWARENESS OF FOOD HANDLING AND FOOD SAFETY ISSUES AND PRACTICES (U.S. CLS. 100 AND 101).
FIRST USE 4-0-1998; IN COMMERCE 4-0-1998.

SN 76-316,609. BLOOM ENGINEERING COMPANY, INC., PITTSBURGH, PA. FILED 9-24-2001.

BLOOM**CLASS 9—ELECTRICAL AND SCIENTIFIC APPARATUS**

FOR ELECTRONIC CONTROLS FOR INDUSTRIAL COMBUSTION SYSTEMS (U.S. CLS. 21, 23, 26, 36 AND 38).
FIRST USE 0-0-1936; IN COMMERCE 0-0-1936.

CLASS 11—ENVIRONMENTAL CONTROL APPARATUS

FOR INDUSTRIAL BURNERS, HEAT EXCHANGERS, VALVES FOR USE IN COMBUSTION SYSTEMS (U.S. CLS. 13, 21, 23, 31 AND 34).
FIRST USE 0-0-1936; IN COMMERCE 0-0-1936.

CLASS 17—RUBBER GOODS

FOR PRE-CAST REFRACTORY REINFORCED PIPE INSULATION (U.S. CLS. 1, 5, 12, 13, 35 AND 50).
FIRST USE 0-0-1936; IN COMMERCE 0-0-1936.

CLASS 42—SCIENTIFIC, COMPUTER AND LEGAL SERVICES

FOR ENGINEERING SERVICES IN THE AREA OF INDUSTRIAL COMBUSTION (U.S. CLS. 100 AND 101).
FIRST USE 0-0-1936; IN COMMERCE 0-0-1936.

SN 76-317,586. RBC MINISTRIES, GRAND RAPIDS, MI. FILED 9-26-2001.

NUESTRO PAN DIARIO

OWNER OF U.S. REG. NOS. 725,657 AND 731,961.
THE ENGLISH TRANSLATION OF THE MARK IS "OUR DAILY BREAD".

CLASS 16—PAPER GOODS AND PRINTED MATTER

FOR PERIODICAL RELATING TO RELIGIOUS SUBJECTS (U.S. CLS. 2, 5, 22, 23, 29, 37, 38 AND 50).
FIRST USE 1-0-1996; IN COMMERCE 1-0-1996.

CLASS 41—EDUCATION AND ENTERTAINMENT

FOR RELIGIOUS RADIO PROGRAM (U.S. CLS. 100, 101 AND 107).
FIRST USE 1-0-1996; IN COMMERCE 1-0-1996.

SN 76-319,357. PURPLEYOGI, INC., MOUNTAIN VIEW, CA. FILED 9-28-2001.

DISCOVER MORE**CLASS 9—ELECTRICAL AND SCIENTIFIC APPARATUS**

FOR SOFTWARE FOR COLLECTING, LINKING, ORGANIZING AND PRIORITIZING DATA FROM MULTIPLE SOURCES INTO A HIERARCHICAL DISPLAY; CONTENT AND DATA MANAGEMENT SOFTWARE; SOFTWARE FOR ENHANCING CUSTOMER RELATIONSHIP MANAGEMENT SOFTWARE, SALES FORCE AUTOMATION SOFTWARE, CORPORATE PORTALS, SEARCH ENGINES AND NEW AGGREGATION SERVICES (U.S. CLS. 21, 23, 26, 36 AND 38).

CLASS 42—SCIENTIFIC, COMPUTER AND LEGAL SERVICES

FOR CUSTOMER SUPPORT SERVICES, NAMELY, SOFTWARE INSTALLATION, INTEGRATION, MAINTENANCE, UPGRADING AND TROUBLESHOOTING (U.S. CLS. 100 AND 101).

SN 76-320,876. DNA WEAR, INC., RICHMOND, CA. FILED 10-3-2001.

ARCHETYPE SOLUTIONS**CLASS 25—CLOTHING**

FOR MEN'S, WOMEN'S AND CHILDREN'S CLOTHING, NAMELY, PANTS, JEANS, DRESS SLACKS, KNICKERS, SWEATERS, SKIRTS, DRESSES, SHIRTS, BLOUSES, JERSEYS, VEST, JACKETS, COATS, SUITS, SPORT COATS, LEGGINGS, LEOTARDS, SHORTS, UNDERWEAR, LINGERIE, BRASSIERES, HATS, CAPS, SWIMMING AND BATHING SUITS, UNIFORMS, AND MILITARY UNIFORMS (U.S. CLS. 22 AND 39).

CLASS 35—ADVERTISING AND BUSINESS

FOR RETAIL CLOTHING STORE SERVICES (U.S. CLS. 100, 101 AND 102).

CLASS 40—MATERIAL TREATMENT

FOR CUSTOM MANUFACTURING OF CLOTHING (U.S. CLS. 100, 103 AND 106).

CLASS 42—SCIENTIFIC, COMPUTER AND LEGAL SERVICES

FOR CUSTOM CLOTHING DESIGN SERVICES FOR OTHERS; PROVIDING CUSTOM SIZING OF CLOTHING VIA THE INTERNET (U.S. CLS. 100 AND 101).

SN 76-320,878. DNA WEAR, INC., RICHMOND, CA. FILED 10-3-2001.

SN 76-326,544. CROMPTON CORPORATION, GREENWICH, CT. FILED 10-16-2001.

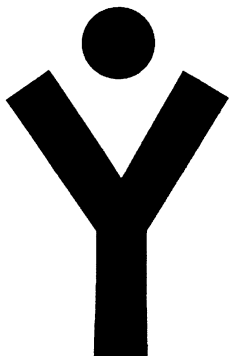

CLASS 25—CLOTHING

FOR MEN'S, WOMEN'S AND CHILDREN'S CLOTHING, NAMELY, PANTS, JEANS, DRESS SLACKS, KNICKERS, SWEATERS, SKIRTS, DRESSES, SHIRTS, BLOUSES, JERSEYS, VEST, JACKETS, COATS, SUITS, SPORT COATS, LEGGINGS, LEOTARDS, SHORTS, UNDERWEAR, LINGERIE, BRASSIERES, HATS, CAPS, SWIMMING AND BATHING SUITS, UNIFORMS, AND MILITARY UNIFORMS (U.S. CLS. 22 AND 39).

CLASS 35—ADVERTISING AND BUSINESS

FOR RETAIL CLOTHING STORE SERVICES (U.S. CLS. 100, 101 AND 102).

CLASS 40—MATERIAL TREATMENT

FOR CUSTOM MANUFACTURING OF CLOTHING (U.S. CLS. 100, 103 AND 106).

CLASS 42—SCIENTIFIC, COMPUTER AND LEGAL SERVICES

FOR CUSTOM CLOTHING DESIGN SERVICES FOR OTHERS; PROVIDING CUSTOM SIZING OF CLOTHING VIA THE INTERNET (U.S. CLS. 100 AND 101).

SN 76-324,260. WALTERS, CHARLES R., NEW YORK, NY. FILED 10-10-2001.

MONEY MASTERFUL

NO CLAIM IS MADE TO THE EXCLUSIVE RIGHT TO USE "MONEY", APART FROM THE MARK AS SHOWN.

CLASS 36—INSURANCE AND FINANCIAL

FOR FINANCIAL AND INVESTMENT CONSULTING; INVESTMENT MANAGEMENT AND STOCK AND SECURITIES BROKERAGE (U.S. CLS. 100, 101 AND 102).

CLASS 41—EDUCATION AND ENTERTAINMENT

FOR SEMINARS AND LECTURES IN THE FIELD OF INVESTMENT MANAGEMENT AND STOCK AND SECURITIES BROKERAGE (U.S. CLS. 100, 101 AND 107).

PEARLENE

CLASS 1—CHEMICALS

FOR SYNTHETIC RESINS, NAMELY, POROUS CARRIER RESINS FOR ABSORBING SILANES FOR USE IN CROSSLINKING POLYOLEFINS FOR USE IN THE MANUFACTURE OF A WIDE VARIETY OF GOODS; AND UNPROCESSED RESINS, NAMELY, POROUS CARRIER RESINS FOR ABSORBING SILANES FOR USE IN CROSSLINKING POLYOLEFINS FOR USE IN THE MANUFACTURE OF A WIDE VARIETY OF GOODS (U.S. CLS. 1, 5, 6, 10, 26 AND 46).

CLASS 42—SCIENTIFIC, COMPUTER AND LEGAL SERVICES

FOR TECHNICAL CONSULTATION SERVICES IN THE FIELD OF CHEMICAL PROCESSING FOR IN-LINE BLENDING OF CARRIER RESINS IN PRODUCT MANUFACTURING FOR A WIDE VARIETY OF GOODS (U.S. CLS. 100 AND 101).

SN 76-326,769. LB GARDENS, INC., BROOKLYN, NY. FILED 10-18-2001.

L & B SPUMONI GARDENS

NO CLAIM IS MADE TO THE EXCLUSIVE RIGHT TO USE "SPUMONI", APART FROM THE MARK AS SHOWN.

CLASS 39—TRANSPORTATION AND STORAGE

FOR PIZZA DELIVERY SERVICES (U.S. CLS. 100 AND 105).
FIRST USE 1-1-1938; IN COMMERCE 1-1-1938.

CLASS 42—SCIENTIFIC, COMPUTER AND LEGAL SERVICES

FOR CATERING SERVICES AND RESTAURANT SERVICES FEATURING HOME DELIVERY (U.S. CLS. 100 AND 101).
FIRST USE 1-1-1938; IN COMMERCE 1-1-1938.

SN 76-327,315. TRILEGIANT CORPORATION, NORWALK, CT. FILED 10-18-2001.

GREATOPTIONSTRAVEL.COM

CLASS 35—ADVERTISING AND BUSINESS

FOR PROVIDING ELECTRONICALLY BY MEANS OF AN INTERNET WEB SITE A CONSUMER MEMBERSHIP PROGRAM ENTITLING THE PARTICIPANTS TO RECEIVE DISCOUNTS ON ADULT-ORIENTED TRAVEL, DINING, HOTEL ACCOMMODATIONS, SPAS AND HEALTH CLUBS, FINANCIAL SERVICES, PRESCRIPTION DRUGS, AND PERSONAL GROWTH AND ENJOYMENT PRODUCTS AND SERVICES; AND PROVIDING BUYING CLUB INFORMATION REGARDING SUCH DISCOUNTS (U.S. CLS. 100, 101 AND 102).

CLASS 39—TRANSPORTATION AND STORAGE

FOR TRAVEL INFORMATION SERVICES, NAMELY, PROVIDING TRIP ROUTING INFORMATION; TRAVEL AGENCY SERVICES, NAMELY, MAKING RESERVATIONS AND BOOKINGS FOR TRANSPORTATION, AND CAR AND LIMOUSINE RENTAL; AND PROVIDING EMERGENCY TRAVEL SERVICES INCLUDING TRAVEL ASSISTANCE AND SUPPORT AND RETURN OF LOST PERSONAL PROPERTY; ALL PROVIDED ELECTRONICALLY BY MEANS OF THE INTERNET (U.S. CLS. 100 AND 105).

CLASS 42—SCIENTIFIC, COMPUTER AND LEGAL SERVICES

FOR TRAVEL AGENCY SERVICES, NAMELY, MAKING RESERVATIONS AND BOOKINGS AT HOTELS, MOTELS, SPAS, RESORTS AND OTHER LODGING; ON-LINE TRAVEL AGENCY SERVICES, NAMELY, MONITORING ELECTRONIC COMMUNICATIONS FROM PARTICIPANTS AND NOTIFYING EMERGENCY FACILITIES; ALL PROVIDED ELECTRONICALLY BY MEANS OF THE INTERNET (U.S. CLS. 100 AND 101).

SN 76-330,060. DUCKBACK PRODUCTS, INC., CHICO, CA. FILED 10-25-2001.

SUPERDECK**CLASS 1—CHEMICALS**

FOR WATERPROOF, MILDEW RESISTING AND ULTRAVIOLET REFLECTIVE CHEMICAL COMPOSITIONS FOR WOOD PRODUCTS (U.S. CLS. 1, 5, 6, 10, 26 AND 46).

FIRST USE 1-15-1998; IN COMMERCE 1-15-1998.

CLASS 2—PAINTS

FOR INTERIOR AND EXTERIOR SHELLACS, FINISHES, STAINS, VARNISHES, FILLERS AND PRIMERS FOR USE AS SURFACE COATINGS ON WOODS; OILS FOR PRESERVATION OF WOODS; PAINT FILLS FOR WOOD; WOOD PRESERVATIVES; WOOD PRESERVATIVES FOR FENCES AND OTHER WOOD PRODUCTS; COATINGS FOR USE ON WOOD (U.S. CLS. 6, 11 AND 16).

FIRST USE 1-15-1989; IN COMMERCE 1-15-1989.

CLASS 3—COSMETICS AND CLEANING PREPARATIONS

FOR STRIPPING AND CLEANING PREPARATIONS FOR USE ON WOOD; WOOD BRIGHTENERS; STAIN REMOVERS, PAINT AND VARNISH STRIPPING OR REMOVING PREPARATIONS FOR USE ON WOOD (U.S. CLS. 1, 4, 6, 50, 51 AND 52).

FIRST USE 1-15-1989; IN COMMERCE 1-15-1989.

SN 76-330,218. DUN & BRADSTREET CORPORATION, THE, MURRAY HILL, NJ. FILED 10-26-2001.

D & B LOGO

NO CLAIM IS MADE TO THE EXCLUSIVE RIGHT TO USE "LOGO", APART FROM THE MARK AS SHOWN.

CLASS 9—ELECTRICAL AND SCIENTIFIC APPARATUS

FOR COMPUTER SOFTWARE PROGRAMS IN THE FIELD OF SEARCHING AND RETRIEVING INFORMATION ON BUSINESS ACTIVITY CLASSIFICATIONS; SOFTWARE FOR MANAGING SUPPLIER DATA BASE INFORMATION (U.S. CLS. 21, 23, 26, 36 AND 38).

CLASS 35—ADVERTISING AND BUSINESS

FOR PROVIDING SALES AND MARKET REPORTS TO THE ORDER AND/OR SPECIFICATION OF OTHERS; PROVIDING GENERAL BUSINESS INFORMATION CONCERNING SALES, SIZE AND POSITION; CONDUCTING MARKETING STUDIES; PROVIDING BUSINESS INFORMATION SERVICES PERTAINING TO MARKETING, DEMOGRAPHICS AND STATISTICAL FIELDS; ASSIGNING AND SUPPLYING IDENTIFICATION NUMBERS FOR USE BY BUSINESS ENTERPRISES FOR THE PURPOSE OF FACILITATING THE AUTOMATION OF THE PAYMENT OF ACCOUNTS PAYABLE AND OTHER BUSINESS PURPOSES AND THE OBTAINING OF BUSINESS STATISTICS AND INFORMATION; SUPPLYING SALE AND MARKETING INFORMATION CONCERNING THE BUSINESS COMMUNITY ACCORDING TO THE REQUIREMENT OF CUSTOMERS, MAILING LISTS PREPARATION SERVICES; COMPUTERIZED MARKETING CONSULTING SERVICES RENDERED TO BUSINESSES, NAMELY, PROVIDING INFORMATION THAT IDENTIFY CORPORATE LINES OF BUSINESS AND RELATIONSHIPS BETWEEN NATIONAL AND INTERNATIONAL COMPANIES, PROVIDING DEMOGRAPHIC INFORMATION ON DIFFERENT BUSINESSES IN SPECIFIC GEOGRAPHIC AREAS, GATHERING AND DISSEMINATION OF ADVERTISING MATTER OF OTHERS, PREPARATION OF LISTS OF COMPANIES FOR OTHERS; PROVIDING BUSINESS INFORMATION BY MEANS OF TELEPHONIC PRE-RECORDED MESSAGES; EVALUATION OF SUPPLIERS OF GOODS AND SERVICES WITH REGARD TO OVERALL FINANCIAL, OPERATIONAL AND RISK LEVEL (U.S. CLS. 100, 101 AND 102).

CLASS 36—INSURANCE AND FINANCIAL

FOR PROVIDING INFORMATION ON CREDIT AND COLLECTIONS OF BUSINESSES; COLLECTION AGENCY SERVICES; PROVIDING CREDIT RECOVERY AND COLLECTION SERVICES; FURNISHING CREDIT RATING REPORTS; FINANCIAL REPORTS INCLUDING COLLECTING AND REPORTING CREDIT, SALES, FINANCIAL AND CREDIT AND FINANCIAL ANALYSIS; FINANCIAL MARKETING AND RESEARCH; PROVIDING CREDIT RATING AND FINANCIAL REPORTING AND ANALYSIS; CONDUCTING A CHARITABLE GIFT MATCHING PROGRAM; PROVIDING FINANCIAL CREDIT HISTORY INFORMATION SERVICES; PROVIDING INFORMATION SERVICES AND INVESTMENT RATING SERVICES, NAMELY, CREDIT INFORMATION SERVICES RENDERED BY COMPUTER SOFTWARE; DEBT COLLECTION SERVICES; PROVIDING CREDIT REPORTS AND CREDIT RATING INFORMATION BY MEANS OF TELEPHONIC PRE-RECORDED MESSAGES; CREDIT RISK ANALYSIS (U.S. CLS. 100, 101 AND 102).

SN 76-330,490. ENCLOS CORP., BLOOMINGTON, MN. FILED 10-26-2001.

**THE VISIBLE DIFFERENCE
IN CURTAINWALL**

NO CLAIM IS MADE TO THE EXCLUSIVE RIGHT TO USE "CURTAINWALL", APART FROM THE MARK AS SHOWN.

CLASS 37—CONSTRUCTION AND REPAIR

FOR INSTALLATION OF CURTAINWALL AND EXTERIOR CLADDING SYSTEMS (U.S. CLS. 100, 103 AND 106).

CLASS 40—MATERIAL TREATMENT

FOR FABRICATION OF CURTAINWALL AND EXTERIOR CLADDING SYSTEMS; GLAZING SERVICES (U.S. CLS. 100, 103 AND 106).

CLASS 42—SCIENTIFIC, COMPUTER AND LEGAL SERVICES

FOR DESIGN AND ENGINEERING SERVICES IN THE FIELDS OF CURTAINWALL, GLAZING AND EXTERIOR CLADDING SYSTEMS (U.S. CLS. 100 AND 101).

SN 76-331,013. NEBRASKA WESLEYAN UNIVERSITY, LINCOLN, NE. FILED 10-26-2001.



NO CLAIM IS MADE TO THE EXCLUSIVE RIGHT TO USE "PRAIRIE WOLVES", APART FROM THE MARK AS SHOWN.

CLASS 16—PAPER GOODS AND PRINTED MATTER

FOR NOTEBOOKS, NOTEPADS, ENVELOPES, STATIONERY, FOLDERS, POSTERS, CALENDARS, TRADING CARDS, POSTCARDS, DECALS, STICKERS, PENCILS, PENS, BINDERS AND PRINTED PUBLICATIONS, NAMELY MAGAZINES, NEWSLETTERS, BOOKS, AND PROGRAMS RELATED TO ACTIVITIES OF OR SPONSORED BY THE UNIVERSITY (U.S. CLS. 2, 5, 22, 23, 29, 37, 38 AND 50).
FIRST USE 10-7-2000; IN COMMERCE 10-7-2000.

CLASS 25—CLOTHING

FOR CLOTHING, NAMELY, CAPS, JACKETS, SHIRTS, SWEAT PANTS AND SWEATSHIRTS, T-SHIRTS, BOXER SHORTS AND INFANTWEAR (U.S. CLS. 22 AND 39).
FIRST USE 10-7-2000; IN COMMERCE 10-7-2000.

CLASS 41—EDUCATION AND ENTERTAINMENT

FOR SPORTING ACTIVITIES, NAMELY, ARRANGING AND CONDUCTING ATHLETIC EVENTS AND TOURNAMENTS AND LIVE MUSICAL PERFORMANCES (U.S. CLS. 100, 101 AND 107).
FIRST USE 10-7-2000; IN COMMERCE 10-7-2000.

SN 76-331,602. LAKELAND ELECTRIC, CITY OF LAKE-
LAND, LAKE-
LAND, FL. FILED 10-30-2001.

**YOUR ESSENTIAL LINK TO
A QUALITY LIFE****CLASS 39—TRANSPORTATION AND STORAGE**

FOR PUBLIC UTILITIES SERVICES, NAMELY, ELECTRIC POWER DISTRIBUTION (U.S. CLS. 100 AND 105).

CLASS 40—MATERIAL TREATMENT

FOR PUBLIC UTILITIES SERVICES, NAMELY ELECTRIC POWER GENERATION (U.S. CLS. 100, 103 AND 106).

SN 76-333,476. SUNGARD DEVELOPMENT CORPORATION, WILMINGTON, DE. FILED 11-1-2001.

SUNGARD STREAM

OWNER OF U.S. REG. NOS. 1,225,489, 2,433,644 AND OTHERS.

CLASS 9—ELECTRICAL AND SCIENTIFIC APPARATUS

FOR COMPUTER SOFTWARE USED TO PROCESS TRADE TRANSACTIONS INVOLVING FINANCIAL INSTRUMENTS, AND FOR MANAGING INFORMATION AND DOCUMENTATION RELATED TO FINANCIAL INSTRUMENT TRADING AND THE REGULATION OF FINANCIAL INSTRUMENT TRADING (U.S. CLS. 21, 23, 26, 36 AND 38).

CLASS 42—SCIENTIFIC, COMPUTER AND LEGAL SERVICES

FOR APPLICATION SERVICE PROVIDER SERVICES, NAMELY HOSTING AND SERVING COMPUTER SOFTWARE FOR USE BY OTHERS TO PROCESS TRADE TRANSACTIONS INVOLVING FINANCIAL INSTRUMENTS, AND TO MANAGE INFORMATION AND DOCUMENTATION RELATED TO THE AUTOMATED TRADING, SETTLEMENT, REPORTING, ACCOUNTING, ACCOUNT REPORTING, AND REGULATION OF FINANCIAL INSTRUMENT TRADING (U.S. CLS. 100 AND 101).

SN 76-333,564. CROSCILL, INC., NEW YORK, NY. FILED 11-2-2001.

**COUTURE COLLECTION BY
CROSCILL**

NO CLAIM IS MADE TO THE EXCLUSIVE RIGHT TO USE "COUTURE COLLECTION", APART FROM THE MARK AS SHOWN.

CLASS 20—FURNITURE AND ARTICLES NOT OTHERWISE CLASSIFIED

FOR DECORATIVE PILLOWS (U.S. CLS. 2, 13, 22, 25, 32 AND 50).

CLASS 21—HOUSEWARES AND GLASS

FOR BATHROOM ACCESSORIES, NAMELY, TISSUE BOXES, WASTEBASKETS, TOOTHBRUSH-TUMBLER HOLDERS, TUMBLERS, COTTON BALL AND SWAB HOLDERS, VANITY TRAYS, SOAP DISHES, AND SOAP DISPENSERS (U.S. CLS. 2, 13, 23, 29, 30, 33, 40 AND 50).

CLASS 24—FABRICS

FOR BED LINENS, NAMELY, COMFORTERS, BED SPREADS, COMFORTER COVERS, BED SHEETS, PILLOW CASES, PILLOW SHAMS, DUST RUFFLES AND DUVET COVERS; TABLE LINENS, NAMELY, FABRIC NAPKINS, PLACEMATS, TABLECLOTHS AND TABLE ROUNDS; FABRIC SHOWER CURTAINS; FABRIC BLANKET TROWS; TOWELS, NAMELY, BATH TOWELS, HAND TOWELS, WASHCLOTHS AND FINGERTIP TOWELS; FABRIC WINDOW TREATMENTS, NAMELY, CURTAINS, CURTAIN TIE BACKS, DRAPERIES, VALANCES, PANELS AND SWAGS (U.S. CLS. 42 AND 50).

CLASS 27—FLOOR COVERINGS

FOR BATH RUGS AND WALLPAPER (U.S. CLS. 19, 20, 37, 42 AND 50).

SN 76-333,739. FRIENDS OF THE HUNLEY, INC., CHARLESTON, SC. FILED 11-2-2001.

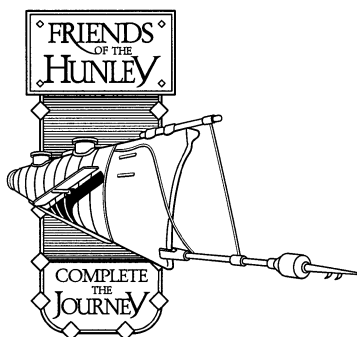

THE LINING IS A FEATURE OF THE MARK AND DOES NOT INDICATE COLOR.

CLASS 35—ADVERTISING AND BUSINESS

FOR RETAIL STORE SERVICES AND ON-LINE RETAIL STORE SERVICES IN THE FIELD OF CLOTHING, CLOTH ARTICLES, NOVELTIES, COMMEMORATIVE COINS, MEDALLIONS, JEWELRY, PRINTED MATERIALS, CERAMIC ARTICLES, GLASSWARE, PAPER PRODUCTS, SOUVENIRS (U.S. CLS. 100, 101 AND 102).

FIRST USE 7-0-1999; IN COMMERCE 7-0-1999.

CLASS 36—INSURANCE AND FINANCIAL

FOR CHARITABLE FUND RAISING SERVICES, NAMELY, ARRANGING AND CONDUCTING FUND-RAISING SERVICES FOR THE PRESERVATION AND/OR REHABILITATION OF THE CONFEDERATE SUBMARINE THE H.L. HUNLEY, NAMELY, THE PROVISION OF SUCH SERVICES THROUGH THE USE OF THE INTERNET (U.S. CLS. 100, 101 AND 102).

FIRST USE 7-0-1999; IN COMMERCE 7-0-1999.

CLASS 41—EDUCATION AND ENTERTAINMENT

FOR CHARITABLE MUSEUM SERVICES, NAMELY, EXHIBITIONS CONCERNING THE CONFEDERATE SUBMARINE THE H.L. HUNLEY AND PROVIDING ITEMS OF HISTORIC OR SCIENTIFIC IMPORTANCE OR VALUE FOR RESEARCH AND STUDY; EDUCATIONAL SERVICES, NAMELY CONDUCTING MUSEUM TOURS AND SEMINARS IN THE FIELD OF PRE-CIVIL WAR AND CIVIL WAR ERA HISTORY AND DISTRIBUTING EDUCATIONAL MATERIALS IN CONNECTION THEREWITH, NAMELY, EDUCATIONAL MATERIALS RELATING TO THE CONFEDERATE SUBMARINE THE H.L. HUNLEY (U.S. CLS. 100, 101 AND 107).

FIRST USE 7-0-1999; IN COMMERCE 7-0-1999.

SN 76-333,942. SUR LA TABLE, INC., SEATTLE, WA. FILED 11-5-2001.

SLT

CLASS 29—MEATS AND PROCESSED FOODS

FOR FOOD PRODUCTS, NAMELY, PROCESSED NUTS, COOKING AND SALAD OILS (U.S. CL. 46).

FIRST USE 10-11-2001; IN COMMERCE 10-11-2001.

CLASS 30—STAPLE FOODS

FOR VINEGAR (U.S. CL. 46).

FIRST USE 10-11-2001; IN COMMERCE 10-11-2001.

SN 76-334,042. PACIFIC COAST FEATHER COMPANY, SEATTLE, WA. FILED 11-5-2001.

PACIFIC COAST GRAND

CLASS 20—FURNITURE AND ARTICLES NOT OTHERWISE CLASSIFIED

FOR PILLOWS, FEATHERBEDS (U.S. CLS. 2, 13, 22, 25, 32 AND 50).

CLASS 24—FABRICS

FOR COMFORTERS, BED SHEETS, PILLOWCASES, DUVET COVERS AND PILLOW SHAMS (U.S. CLS. 42 AND 50).

SN 76-335,151. OKENA, INC., WALTHAM, MA. FILED 11-6-2001.

INCORE

CLASS 9—ELECTRICAL AND SCIENTIFIC APPARATUS

FOR COMPUTER SOFTWARE FOR USE IN IDENTIFYING, DETECTING, PREVENTING AND REMOVING COMPUTER VIRUSES, INTRUSIONS AND OTHER SECURITY RISKS AND FOR ALERTING THE USER OF SUCH VIRUSES AS WELL AS OTHER ANOMALOUS CONDITIONS (U.S. CLS. 21, 23, 26, 36 AND 38).

CLASS 42—SCIENTIFIC, COMPUTER AND LEGAL SERVICES

FOR PROVIDING MAINTENANCE AND UPGRADE SERVICES IN THE AREA OF COMPUTER SOFTWARE USED TO PROTECT COMPUTERS FROM VIRUSES, INTRUSIONS AND OTHER SECURITY RISKS (U.S. CLS. 100 AND 101).

SN 76-336,293. MUDD, LLC, NEW YORK, NY. FILED 11-9-2001.

MUDD SPORT

NO CLAIM IS MADE TO THE EXCLUSIVE RIGHT TO USE "SPORT", APART FROM THE MARK AS SHOWN.

CLASS 18—LEATHER GOODS

FOR HANDBAGS, WALLETS, PURSES, TOTES, BACKPACKS, COSMETICS CASES SOLD EMPTY (U.S. CLS. 1, 2, 3, 22 AND 41).

CLASS 25—CLOTHING

FOR SHOES, ATHLETIC SHOES, BOOTS, SANDALS, JEANS, PANTS, SHORTS, SHIRTS, T-SHIRTS, SWEATERS, TANK TOPS, SKIRTS, JACKETS, COATS, VESTS, HATS, CAMISOLES, BRAS, PANTIES (U.S. CLS. 22 AND 39).

SN 76-335,358. SPACEPROJEKT, INC., SAN FRANCISCO, CA. FILED 11-7-2001.

HAASPROJEKT**CLASS 3—COSMETICS AND CLEANING PREPARATIONS**

FOR COSMETICS, NAMELY COLOGNE, PERFUME, TONER AND SHAMPOO (U.S. CLS. 1, 4, 6, 50, 51 AND 52).

SN 76-336,326. CEYONIQ INC., HERNDON, VA. FILED 11-13-2001.

CLASS 25—CLOTHING

FOR CLOTHING, NAMELY CAPS, HOODS, JERSEYS, TOPS AND WRAPS (U.S. CLS. 22 AND 39).

CEYONIQ**CLASS 9—ELECTRICAL AND SCIENTIFIC APPARATUS**

FOR COMPUTER SOFTWARE PROGRAMS AND USER MANUALS SOLD AS A UNIT IN THE FIELDS OF DOCUMENT, REPORT AND WORKFLOW MANAGEMENT AND BUSINESS PROCESS CONTROL AND MANAGEMENT; STORAGE AND RETRIEVAL OF DOCUMENTS AND MULTIMEDIA DATA; AND COMPREHENSIVE MULTIMEDIA CONTENT MANAGEMENT SYSTEMS (U.S. CLS. 21, 23, 26, 36 AND 38).

SN 76-336,224. KENEXA CORPORATION, WAYNE, PA. FILED 11-9-2001.

KENEXA MINUTEMENTOR**CLASS 9—ELECTRICAL AND SCIENTIFIC APPARATUS**

FOR COMPUTER DATABASE MANAGEMENT SOFTWARE FOR USE IN THE FIELD OF EMPLOYEE ASSESSMENT, TRAINING, AND RECRUITMENT, USED TO AUTOMATE AND FACILITATE THE EMPLOYEE RECRUITING PROCESS, MANAGE AND TRACK INFORMATION REGARDING EMPLOYEES, USED TO FACILITATE THE PROCESS OF MATCHING EMPLOYEE MENTORS TO OTHER EMPLOYEES OR CANDIDATES, AUTOMATE THE GROWTH AND DEVELOPMENT OF EMPLOYEES OR CANDIDATES, PROVIDE EMPLOYEE ASSESSMENT AND SURVEY TOOLS FOR EMPLOYERS, AND MANAGE ON-LINE EMPLOYEE TRAINING AND DEVELOPMENT (U.S. CLS. 21, 23, 26, 36 AND 38).

CLASS 37—CONSTRUCTION AND REPAIR

FOR COMPUTER SERVICES, NAMELY MAINTENANCE AND REPAIR OF COMPUTER OPTICAL DISK DRIVES (U.S. CLS. 100, 103 AND 106).

CLASS 42—SCIENTIFIC, COMPUTER AND LEGAL SERVICES

FOR PROVIDING TEMPORARY USE OF ON-LINE NON-DOWNLOADABLE SOFTWARE FOR DATABASE MANAGEMENT IN THE FIELD OF EMPLOYEE ASSESSMENT, TRAINING, AND RECRUITMENT, USED TO AUTOMATE AND FACILITATE THE EMPLOYEE RECRUITING PROCESS, MANAGE AND TRACK INFORMATION REGARDING EMPLOYEES, USED TO FACILITATE THE PROCESS OF MATCHING EMPLOYEE MENTORS TO OTHER EMPLOYEES OR CANDIDATES, AUTOMATE THE GROWTH AND DEVELOPMENT OF EMPLOYEES OR CANDIDATES, PROVIDE EMPLOYEE ASSESSMENT AND SURVEY TOOLS FOR EMPLOYERS, AND MANAGE ON-LINE EMPLOYEE TRAINING AND DEVELOPMENT (U.S. CLS. 100 AND 101).

CLASS 42—SCIENTIFIC, COMPUTER AND LEGAL SERVICES

FOR PROVIDING TECHNICAL INFORMATION IN THE FIELD OF DOWNLOADABLE SOFTWARE APPLICATIONS VIA A GLOBAL COMPUTER INFORMATION NETWORK; CONSULTING IN THE FIELD OF COMPREHENSIVE MULTIMEDIA CONTENT MANAGEMENT; CUSTOM-DESIGN OF COMPUTER SOFTWARE SERVICES IN THE FIELD OF COMPREHENSIVE DOCUMENT MANAGEMENT; AND COMPUTER SOFTWARE UPDATE SERVICES (U.S. CLS. 100 AND 101).

SN 76-336,436. MIQUEST, CORP., GRAND RAPIDS, MI. FILED 11-13-2001.

MIQUEST**CLASS 9—ELECTRICAL AND SCIENTIFIC APPARATUS**

FOR CIRCUIT BOARDS (U.S. CLS. 21, 23, 26, 36 AND 38).
FIRST USE 10-0-1984; IN COMMERCE 10-0-1984.

CLASS 42—SCIENTIFIC, COMPUTER AND LEGAL SERVICES

FOR CUSTOM DESIGN OF CIRCUIT BOARDS FOR OTHERS (U.S. CLS. 100 AND 101).
FIRST USE 10-0-1984; IN COMMERCE 10-0-1984.

SN 76-336,839. KONAMI CORPORATION, TOKYO, JAPAN,
FILED 11-13-2001.

WICKED DRAGON WITH THE ERSATZ HEAD

CLASS 9—ELECTRICAL AND SCIENTIFIC APPARATUS

FOR COMPUTER PRODUCTS, NAMELY, COMPUTER GAME PROGRAMS; VIDEO GAME CARTRIDGES; VIDEO GAME CD-ROMS; VIDEO GAME MACHINES FOR USE WITH TELEVISIONS; COMPUTER GAME CD-ROMS; VIDEO GAME PROGRAMS; VIDEO GAME PROGRAMS FOR USE WITH TELEVISION SETS; VIDEO GAME JOYSTICKS (U.S. CLS. 21, 23, 26, 36 AND 38).

CLASS 16—PAPER GOODS AND PRINTED MATTER

FOR BROCHURES AND BOOKLETS RELATING TO COMPUTER AND VIDEO GAMES; VIDEO GAME STRATEGY GUIDE BOOKS; VIDEO GAME STRATEGY GUIDE MAGAZINES; CARD GAME STRATEGY GUIDE BOOKS; CARD GAME STRATEGY GUIDE MAGAZINES; CARD GAME INSTRUCTION BOOKS; CARD GAME INSTRUCTION MAGAZINES; POSTERS; PLAYING CARDS AND INSTRUCTION MANUAL SOLD THEREWITH; COMPUTER GAME INSTRUCTION MANUALS; PRINTED GAME INSTRUCTION SHEETS; PRINTED SCORING SHEETS; TRADING CARDS; CALENDARS; LOOSE-LEAF BINDERS AND STATIONERY (U.S. CLS. 2, 5, 22, 23, 29, 37, 38 AND 50).

CLASS 28—TOYS AND SPORTING GOODS

FOR STAND-ALONE VIDEO GAME MACHINES; HAND-HELD UNITS FOR PLAYING ELECTRONIC GAMES; BOARD GAMES AND INSTRUCTIONAL MANUALS SOLD AS A UNIT THEREWITH; CARD GAMES; DICE; PROMOTIONAL GAME MATERIALS; GAME EQUIPMENT, NAMELY, CHIPS; TOYS, NAMELY ACTION FIGURES; DOLLS AND PLAYSETS THEREFOR (U.S. CLS. 22, 23, 38 AND 50).

SN 76-336,840. KONAMI CORPORATION, TOKYO, JAPAN,
FILED 11-13-2001.

DRAGONESS THE WICKED KNIGHT

CLASS 9—ELECTRICAL AND SCIENTIFIC APPARATUS

FOR COMPUTER PRODUCTS, NAMELY, COMPUTER GAME PROGRAMS; VIDEO GAME CARTRIDGES; VIDEO GAME CD-ROMS; VIDEO GAME MACHINES FOR USE WITH TELEVISIONS; COMPUTER GAME CD-ROMS; VIDEO GAME PROGRAMS; VIDEO GAME PROGRAMS FOR USE WITH TELEVISION SETS; VIDEO GAME JOYSTICKS (U.S. CLS. 21, 23, 26, 36 AND 38).

CLASS 16—PAPER GOODS AND PRINTED MATTER

FOR BROCHURES AND BOOKLETS RELATING TO COMPUTER AND VIDEO GAMES; VIDEO GAME STRATEGY GUIDE BOOKS; VIDEO GAME STRATEGY GUIDE MAGAZINES; CARD GAME STRATEGY GUIDE BOOKS; CARD GAME STRATEGY GUIDE MAGAZINES; CARD GAME INSTRUCTION BOOKS; CARD GAME INSTRUCTION MAGAZINES; POSTERS; PLAYING CARDS AND INSTRUCTION MANUAL SOLD THEREWITH; COMPUTER GAME INSTRUCTION MANUALS; PRINTED GAME INSTRUCTION SHEETS; PRINTED SCORING SHEETS; TRADING CARDS; CALENDARS; LOOSE-LEAF BINDERS AND STATIONERY (U.S. CLS. 2, 5, 22, 23, 29, 37, 38 AND 50).

CLASS 28—TOYS AND SPORTING GOODS

FOR STAND-ALONE VIDEO GAME MACHINES; HAND-HELD UNITS FOR PLAYING ELECTRONIC GAMES; BOARD GAMES AND INSTRUCTIONAL MANUALS SOLD AS A UNIT THEREWITH; CARD GAMES; DICE; PROMOTIONAL GAME MATERIALS; GAME EQUIPMENT, NAMELY, CHIPS; TOYS, NAMELY ACTION FIGURES; DOLLS AND PLAYSETS THEREFOR (U.S. CLS. 22, 23, 38 AND 50).

SN 76-337,571. NAVISYS INC., EDISON, NJ. FILED 11-13-2001.

HOW INSURERS PROFIT FROM TECHNOLOGY

CLASS 35—ADVERTISING AND BUSINESS

FOR BUSINESS CONSULTING SERVICES RENDERED TO THE INSURANCE INDUSTRY IN THE FIELD OF ANNUITIES, LIFE INSURANCE AND HEALTH INSURANCE; BUSINESS CONSULTING SERVICES RENDERED TO THE INSURANCE INDUSTRY IN THE FIELD OF INSURANCE AND FINANCIAL SERVICES FOR LIFE INSURANCE POLICY ADMINISTRATION, LIFE INSURANCE POLICY SALES ILLUSTRATION, ELECTRONIC COMMERCE, UNDERWRITING, CLAIMS ADJUDICATION AND BENEFIT ADMINISTRATION, FINANCIAL REPORTING, CEDED REINSURANCE ADMINISTRATION, AND ANNUITY PAYOUT ADMINISTRATION (U.S. CLS. 100, 101 AND 102).

CLASS 42—SCIENTIFIC, COMPUTER AND LEGAL SERVICES

FOR COMPUTER CONSULTATION; COMPUTER PROGRAMMING FOR OTHERS, NAMELY CREATING CUSTOMIZED COMPUTER PROGRAMS TO ASSIST LIFE AND HEALTH INSURERS TO ADMINISTER LIFE AND ANNUITY PRODUCTS; PROVIDING TECHNICAL SUPPORT SERVICES, NAMELY TROUBLE SHOOTING OF COMPUTER SOFTWARE (U.S. CLS. 100 AND 101).

SN 76-337,900. WASHINGTON POST COMPANY, THE,
WASHINGTON, DC. FILED 11-15-2001.

OUT OF THE GENE POOL

CLASS 16—PAPER GOODS AND PRINTED MATTER

FOR PRINTED MATTER, NAMELY, A NEWSPAPER COMIC STRIP; CARTOON (U.S. CLS. 2, 5, 22, 23, 29, 37, 38 AND 50).

CLASS 42—SCIENTIFIC, COMPUTER AND LEGAL SERVICES

FOR COMPUTER SERVICES, NAMELY, PROVIDING A COMIC STRIP AND CARTOON VIA A GLOBAL COMPUTER INFORMATION NETWORK (U.S. CLS. 100 AND 101).

SN 76-338,766. CHARLES SCHWAB & CO., INC., SAN FRANCISCO, CA. FILED 11-16-2001.

WOULDN'T IT BE GREAT IF THE PERSON YOU TRUST MOST WAS YOUR BROKER

CLASS 36—INSURANCE AND FINANCIAL

FOR BROKERAGE SERVICES IN THE FIELDS OF FINANCIAL SECURITIES, STOCKS, BONDS, MUTUAL FUNDS, MONEY MARKET FUNDS, COMMODITIES, FUTURES, STOCK OPTIONS, AND INDICES OF FINANCIAL SECURITIES; INVESTMENT SERVICES IN THE FIELDS OF FINANCIAL SECURITIES, STOCKS, BONDS, MUTUAL FUNDS, MONEY MARKET FUNDS, COMMODITIES, FUTURES, STOCK OPTIONS, AND INDICES OF FINANCIAL SECURITIES; FINANCIAL PORTFOLIO MANAGEMENT SERVICES; FINANCIAL ANALYSIS AND CONSULTATION; FINANCIAL PLANNING; FINANCIAL RESEARCH (U.S. CLS. 100, 101 AND 102).
FIRST USE 9-23-2001; IN COMMERCE 9-23-2001.

SN 76-338,060. MUDD, LLC, NEW YORK, NY. FILED 11-15-2001.

MUDD
★ S.P.O.R.T ★

NO CLAIM IS MADE TO THE EXCLUSIVE RIGHT TO USE "SPORT", APART FROM THE MARK AS SHOWN.

CLASS 41—EDUCATION AND ENTERTAINMENT

FOR EDUCATIONAL SERVICES, NAMELY, CONDUCTING SEMINARS, CLASSES, CONFERENCES, AND WORKSHOPS IN THE FIELDS OF INVESTMENT, FINANCE, FINANCIAL PLANNING, PORTFOLIO MANAGEMENT, RETIREMENT PLANNING, MONEY MANAGEMENT, INVESTMENT STRATEGY AND ASSET ALLOCATION (U.S. CLS. 100, 101 AND 107).
FIRST USE 9-23-2001; IN COMMERCE 9-23-2001.

CLASS 18—LEATHER GOODS

FOR HANDBAGS, WALLETS, PURSES, TOTES, BACKPACKS, COSMETICS CASES SOLD EMPTY (U.S. CLS. 1, 2, 3, 22 AND 41).

SN 76-339,031. MACROBERTS, SHAWN, SOUTH LAKE TAHOE, CA. FILED 11-16-2001.

SUBMISSION

CLASS 25—CLOTHING

FOR SHOES, ATHLETIC SHOES, BOOTS, SANDALS, JEANS, PANTS, SHORTS, SHIRTS, T-SHIRTS, SWEATERS, TANK TOPS, SKIRTS, JACKETS, COATS, VESTS, HATS, CAMISOLES, BRAS, PANTIES (U.S. CLS. 22 AND 39).

CLASS 9—ELECTRICAL AND SCIENTIFIC APPARATUS

FOR CDS COMPRISING MUSICAL RECORDINGS (U.S. CLS. 21, 23, 26, 36 AND 38).

CLASS 41—EDUCATION AND ENTERTAINMENT

FOR ENTERTAINMENT, NAMELY, LIVE PERFORMANCES BY A MUSICAL BAND (U.S. CLS. 100, 101 AND 107).

SN 76-338,691. SLEEP SOLUTIONS, INC., PALO ALTO, CA. FILED 11-14-2001.

QSG

CLASS 10—MEDICAL APPARATUS

FOR MEDICAL DEVICES FOR DIAGNOSIS OF SLEEP DISORDERS (U.S. CLS. 26, 39 AND 44).

SN 76-339,575. PFIZER INC., NEW YORK, NY. FILED 11-19-2001.

BECAUSE EACH DAY COUNTS

CLASS 42—SCIENTIFIC, COMPUTER AND LEGAL SERVICES

FOR SLEEP DISORDER TESTING SERVICES (U.S. CLS. 100 AND 101).

CLASS 16—PAPER GOODS AND PRINTED MATTER

FOR PRINTED PUBLICATIONS, NAMELY, MANUALS, INFORMATIONAL BOOKLETS, BROCHURES, LEAFLETS AND POSTERS, ALL ON THE TOPIC OF PREMENSTRUAL DYSPHORIC DISORDER (U.S. CLS. 2, 5, 22, 23, 29, 37, 38 AND 50).

CLASS 41—EDUCATION AND ENTERTAINMENT

FOR EDUCATIONAL SERVICES, NAMELY AN EDUCATIONAL PROGRAM CONSISTING OF SEMINARS, WORKSHOPS AND/OR TRAINING SESSIONS FOR PHYSICIANS AND PATIENTS ON THE TOPIC OF TREATING PREMENSTRUAL DYSPHORIC DISORDER (U.S. CLS. 100, 101 AND 107).

CLASS 42—SCIENTIFIC, COMPUTER AND LEGAL SERVICES

FOR DISEASE MANAGEMENT SERVICES AND MEDICAL INFORMATION SERVICES, NAMELY, PROVIDING HEALTH INFORMATION TO PHYSICIANS AND PATIENTS ON THE TOPIC OF TREATING PREMENSTRUAL DYSPHORIC DISORDER (U.S. CLS. 100 AND 101).

SN 76-339,771. HIDDENMIND TECHNOLOGY, INC., CARY, NC. FILED 11-15-2001.



The logo for HiddenMind features the word "HiddenMind" in a bold, sans-serif font. A thin, curved line arches over the word, starting above the "H" and ending above the "d".

OWNER OF U.S. REG. NO. 2,443,954.

CLASS 9—ELECTRICAL AND SCIENTIFIC APPARATUS

FOR COMPUTER SOFTWARE DEVELOPMENT TOOLS AND COMPUTER OPERATING PROGRAMS TO ENABLE THE DESIGN, DEVELOPMENT, AND DEPLOYMENT OF ADVANCED INFORMATION AND WORKFLOW SOFTWARE IN WIRED, VOICE AND WIRELESS ENVIRONMENTS THAT CAN INTEROPERATE ON A DIVERSE ARRAY OF WIRED AND WIRELESS DEVICES, NAMELY COMPUTERS, TELEPHONE HANDSETS, PAGERS AND HAND-HELD ORGANIZERS (U.S. CLS. 21, 23, 26, 36 AND 38).
FIRST USE 6-29-2001; IN COMMERCE 6-29-2001.

CLASS 42—SCIENTIFIC, COMPUTER AND LEGAL SERVICES

FOR COMPUTER SERVICES, NAMELY, COMPUTER SOFTWARE DEVELOPMENT FOR OTHERS (U.S. CLS. 100 AND 101).
FIRST USE 8-0-2000; IN COMMERCE 8-0-2000.

SN 76-340,138. WASHINGTON POST COMPANY, THE, WASHINGTON, DC. FILED 11-20-2001.

THE HUMBLE STUMBLE

CLASS 16—PAPER GOODS AND PRINTED MATTER

FOR PRINTED MATTER, NAMELY, A NEWSPAPER COMIC STRIP; CARTOON (U.S. CLS. 2, 5, 22, 23, 29, 37, 38 AND 50).

CLASS 42—SCIENTIFIC, COMPUTER AND LEGAL SERVICES

FOR COMPUTER SERVICES, NAMELY, PROVIDING A COMIC STRIP AND CARTOON VIA A GLOBAL COMPUTER INFORMATION NETWORK (U.S. CLS. 100 AND 101).

SN 76-340,271. PLEASANT COMPANY, MIDDLETON, WI. FILED 11-20-2001.



The logo for "bitty baby" features the word "bitty" in a lowercase, rounded, sans-serif font, followed by "baby" in a similar font. Above the "i" in "bitty" is a stylized heart shape with a small leaf-like element extending from its top.

OWNER OF U.S. REG. NOS. 1,990,314, 2,509,608 AND OTHERS.

NO CLAIM IS MADE TO THE EXCLUSIVE RIGHT TO USE "BABY", APART FROM THE MARK AS SHOWN.

CLASS 16—PAPER GOODS AND PRINTED MATTER

FOR CHILDREN'S FICTION AND ACTIVITY BOOKS (U.S. CLS. 2, 5, 22, 23, 29, 37, 38 AND 50).

CLASS 25—CLOTHING

FOR CHILDREN'S CLOTHING, NAMELY, DRESSES, JUMPERS, SKIRTS, PANTS, SHIRTS, T-SHIRTS, BLOUSES, KNIT TOPS, SWEATSHIRTS, SWEATPANTS, PLAYSUITS, SOCKS, SWEATERS, JACKETS, COATS, GLOVES, MITTENS, ROBES, PAJAMAS, NIGHTGOWNS, HATS, CAPS, AND EARMUFFS (U.S. CLS. 22 AND 39).

CLASS 28—TOYS AND SPORTING GOODS

FOR DOLLS, DOLL OUTFITS, DOLL ACCESSORIES, DOLL FURNITURE, STUFFED TOY ANIMALS, ACCESSORIES FOR STUFFED TOY ANIMALS, TOY FURNITURE AND TOY DISHES TO ACCOMPANY STUFFED TOY ANIMALS (U.S. CLS. 22, 23, 38 AND 50).

CLASS 35—ADVERTISING AND BUSINESS

FOR MAIL ORDER CATALOG SERVICES, RETAIL STORE SERVICES, AND ON-LINE RETAIL STORE SERVICES FEATURING CHILDREN'S FICTION AND ACTIVITY BOOKS; CHILDREN'S CLOTHING, NAMELY, DRESSES, JUMPERS, SKIRTS, PANTS, SHIRTS, T-SHIRTS, BLOUSES, KNIT TOPS, SWEATSHIRTS, SWEATPANTS, PLAYSUITS, SOCKS, SWEATERS, JACKETS, COATS, GLOVES, MITTENS, ROBES, PAJAMAS, NIGHTGOWNS, SLEEPERS, HATS, CAPS, AND EARMUFFS; DOLLS, DOLL OUTFITS, DOLL ACCESSORIES, DOLL FURNITURE, STUFFED TOY ANIMALS, ACCESSORIES FOR STUFFED TOY ANIMALS, TOY FURNITURE AND TOY DISHES TO ACCOMPANY STUFFED TOY ANIMALS (U.S. CLS. 100, 101 AND 102).

SN 76-341,270. TAVER, MARINA, NORTH HOLLYWOOD, CA. FILED 11-21-2001.

SN 76-342,116. SMITHKLINE BEECHAM CORPORATION, RESEARCH TRIANGLE PARK, NC. FILED 11-27-2001.



THE MARK CONSISTS OF THE MISCELLANEOUS DESIGN OF A SAFETY PIN, AS SHOWN IN THE DRAWING.

CLASS 18—LEATHER GOODS

FOR WALLETS FOR MEN, HANDBAGS FOR WOMEN, WALLETS FOR WOMEN, CHILDREN'S SCHOOL BAGS, AND TOTE BAGS (U.S. CLS. 1, 2, 3, 22 AND 41).

CLASS 25—CLOTHING

FOR CONTEMPORARY APPAREL FOR MEN, NAMELY, SHIRTS, T-SHIRTS, PANTS, SHORTS, BLAZERS, VESTS, SWEATERS, TIES, ROBES, UNDERGARMENTS, HATS, SOCKS, BELTS FOR USE WITH CLOTHING, AND SHOES; AND CONTEMPORARY APPAREL FOR WOMEN, NAMELY, BLOUSES, T-SHIRTS, SKIRTS, PANTS, SHORTS, DRESSES, JACKETS, COATS, SWEATERS, LINGERIE, ROBES, UNDERGARMENTS, HATS, SOCKS, SHOES, AND BELTS FOR USE WITH CLOTHING; AND CONTEMPORARY APPAREL FOR CHILDREN, NAMELY, SHIRTS, SHORTS, JACKETS, JUMPSUITS, PANTS, SWEATERS, ROBES, UNDERGARMENTS, HATS, AND SHOES; AND CONTEMPORARY APPAREL FOR INFANTS; NAMELY, JUMPSUITS, ROBES, DRESSES, SOCKS, AND SHOES (U.S. CLS. 22 AND 39).

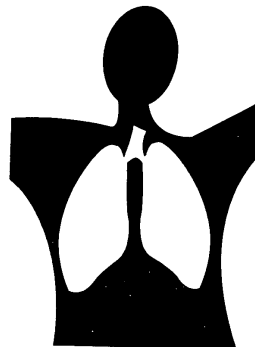

CLASS 9—ELECTRICAL AND SCIENTIFIC APPARATUS

FOR COMPUTER PROGRAMS FOR THE ANALYZING, STORING, AND PROCESSING OF MEDICAL AND SCIENTIFIC INFORMATION (U.S. CLS. 21, 23, 26, 36 AND 38).

CLASS 16—PAPER GOODS AND PRINTED MATTER

FOR PRINTED MATTER, NAMELY, BROCHURES, INSTRUCTIONAL MANUALS, AND MAGAZINES FEATURING MEDICAL AND SCIENTIFIC INFORMATION (U.S. CLS. 2, 5, 22, 23, 29, 37, 38 AND 50).

CLASS 42—SCIENTIFIC, COMPUTER AND LEGAL SERVICES

FOR PROVIDING MEDICAL AND SCIENTIFIC INFORMATION SERVICES (U.S. CLS. 100 AND 101).

SN 76-344,355. NUTRI PHARMA INC., WILMINGTON, DE. FILED 12-3-2001.

VERVIVA

CLASS 5—PHARMACEUTICALS

FOR MEAL REPLACEMENT AND DIETARY SUPPLEMENT DRINK MIXES, NUTRITIONAL BARS FOR USE AS A MEAL REPLACEMENT, DIETARY FOOD SUPPLEMENTS (U.S. CLS. 6, 18, 44, 46, 51 AND 52).

CLASS 38—COMMUNICATION

FOR PROVIDING ON-LINE FORUMS FOR TRANSMISSION OF MESSAGES AMONG COMPUTER USERS CONCERNING DIETING, HEALTH AND NUTRITION (U.S. CLS. 100, 101 AND 104).

CLASS 42—SCIENTIFIC, COMPUTER AND LEGAL SERVICES

FOR DIET PLANNING, SUPERVISION, AND NUTRITIONAL COUNSELING SERVICES; PROVIDING AN ON-LINE DATABASE AND WEB SITE FEATURING INFORMATION ON DIETING, HEALTH, AND NUTRITIONAL (U.S. CLS. 100 AND 101).

SN 76-344,397. COVENANT COMMUNICATIONS INC.,
AMERICAN FORK, UT. FILED 11-30-2001.

PRIMARY PARTNERS

CLASS 9—ELECTRICAL AND SCIENTIFIC APPARATUS

FOR SERIES OF MULTIMEDIA SOFTWARE RECORDED ON CD-ROM'S FEATURING RELIGIOUS TOPICS (U.S. CLS. 21, 23, 26, 36 AND 38).
FIRST USE 3-1-1995; IN COMMERCE 5-2-1994.

CLASS 16—PAPER GOODS AND PRINTED MATTER

FOR SERIES OF RELIGIOUS BOOKS AND WORKBOOKS (U.S. CLS. 2, 5, 22, 23, 29, 37, 38 AND 50).
FIRST USE 3-1-1995; IN COMMERCE 5-2-1994.

SN 76-344,889. GLOBAL HOLIDAYS INC., MINNEAPOLIS,
MN. FILED 12-5-2001.

WORLDWISE

CLASS 39—TRANSPORTATION AND STORAGE

FOR TRAVEL RELATED SERVICES, NAMELY ARRANGING TRAVEL TOURS (U.S. CLS. 100 AND 105).

CLASS 43—HOTEL AND RESTAURANT SERVICES

FOR TRAVEL RELATED SERVICES, NAMELY MAKING RESERVATIONS AND BOOKINGS FOR TEMPORARY LODGING (U.S. CLS. 100 AND 101).

SN 76-345,858. SWC ENTERPRISES, INC., BERWYN, PA.
FILED 12-6-2001.

SHIP'N SHORE

OWNER OF U.S. REG. NO. 1,779,703.

CLASS 14—JEWELRY

FOR JEWELRY (U.S. CLS. 2, 27, 28 AND 50).

CLASS 16—PAPER GOODS AND PRINTED MATTER

FOR WRITING INSTRUMENTS, NAMELY, PENS; PENCILS AND MECHANICAL PENCILS; FOLDERS AND PORTFOLIOS FOR PAPERS; LETTER OPENERS; CALENDARS; PEN AND PENCIL HOLDERS; PAPER CLIP HOLDERS; PAPER WEIGHTS; PLAYING CARDS; PAPER NAPKINS; POSTCARDS; POSTERS AND ADHESIVE STICKERS (U.S. CLS. 2, 5, 22, 23, 29, 37, 38 AND 50).

CLASS 18—LEATHER GOODS

FOR PURSES AND HANDBAGS; WALLETS; CREDIT CARD HOLDERS; BUSINESS FOLDERS, NAMELY, BRIEF CASE TYPE PORTFOLIOS, BRIEF CARDS, ATTACHE CASES; GARMENT BAGS FOR TRAVEL, ALL PURPOSE SPORTING GOODS BAGS, GYM BAGS AND ALL PURPOSE GEAR CARRYING BAGS MADE OF LEATHER, VINYL AND FABRIC; UMBRELLAS; LUGGAGE TAGS AND LUGGAGE (U.S. CLS. 1, 2, 3, 22 AND 41).

CLASS 20—FURNITURE AND ARTICLES NOT OTHERWISE CLASSIFIED

FOR FURNITURE, MIRRORS, PICTURE FRAMES (U.S. CLS. 2, 13, 22, 25, 32 AND 50).

CLASS 24—FABRICS

FOR BED COVERS, NAMELY BED BLANKETS, DUVETS, COMFORTERS, THROWS, AND QUILTS; BED LINENS, NAMELY BED SHEETS, PILLOW CASES, COMFORTER COVERS, DUVET COVERS, BLANKET COVERS, SHAMS, BED SPREADS, BED SKIRTS, DUST RUFFLES, AND BED CANOPIES; BATH LINENS, NAMELY FACE TOWELS, HAND TOWELS, BODY TOWELS, FACE CLOTHS, BATH SHEETS, AND BATH MATS MADE OF TEXTILE; TABLE LINENS, NAMELY TABLE CLOTHS, TABLE NAPKINS, TABLE RUNNERS, PLACE MATS MADE OF TEXTILE, AND COASTERS MADE OF TEXTILE; WINDOW TREATMENTS MADE OF TEXTILE, NAMELY CURTAINS, DRAPERIES, AND VALANCES; UNFITTED FABRIC FURNITURE COVERS; WALL HANGINGS MADE OF TEXTILE; AND FABRICS, NAMELY BOLTING CLOTH, FABRIC FOR USE IN THE MANUFACTURE OF CLOTHING, AND FABRIC FOR UPHOLSTERY AND DRAPERY (U.S. CLS. 42 AND 50).

CLASS 26—FANCY GOODS

FOR LACE AND EMBROIDERY, RIBBONS AND BRAID; BUTTONS, HOOKS AND EYES, PINS AND NEEDLES; ARTIFICIAL FLOWERS (U.S. CLS. 37, 39, 40, 42 AND 50).

CLASS 35—ADVERTISING AND BUSINESS

FOR RETAIL STORE SERVICES FEATURING CLOTHING AND FOOTWEAR; FASHION ACCESSORIES; LUGGAGE; AND HOUSEWARES; ON-LINE RETAIL STORE SERVICES FEATURING CLOTHING AND FOOTWEAR, FASHION ACCESSORIES, LUGGAGE AND HOUSEWARES (U.S. CLS. 100, 101 AND 102).

SN 76-346,102. JEWELAMERICA, INC., NEW YORK, NY.
FILED 12-10-2001.

SHINE ON CREATIONS

CLASS 14—JEWELRY

FOR JEWELRY (U.S. CLS. 2, 27, 28 AND 50).

CLASS 42—SCIENTIFIC, COMPUTER AND LEGAL SERVICES

FOR WHOLESALE DISTRIBUTORSHIP OF JEWELRY (U.S. CLS. 100 AND 101).

SN 76-347,751. MONMOUTH COLLEGE, THE, MONMOUTH, IL. FILED 12-11-2001.

FIGHTING SCOTS

CLASS 25—CLOTHING

FOR CLOTHING, NAMELY T-SHIRTS, SWEAT-SHIRTS, SKIRTS, KNIT SHIRTS, BLOUSES, SWEATERS, TANK TOPS, JERSEYS, VESTS, CAPS, HATS, BELTS, PANTS, SHORTS, GLOVES, MITTENS, TIES, SUSPENDERS, SCARVES, SOCKS, PONCHOS, JACKETS, COATS, KNITTED COATS AND SWEATERS, BANDANNAS, JOGGING AND WARM-UP SUITS, ATHLETIC JERSEYS, HEAD WEAR AND PAINTERS' CAPS, CHILDRENS' AND INFANT CLOTHING, NAMELY, INFANT AND CHILDREN'S SHIRTS, SHORTS, PANTS, JACKETS, BABY CLOTH BIBS, AND INFANT FOOTWEAR; SLEEPWEAR, NAMELY NIGHTSHIRTS, PAJAMAS AND BABY BUNTING; AND FOOTWEAR, NAMELY, SHOES, SANDALS AND SNEAKERS (U.S. CLS. 22 AND 39).

CLASS 41—EDUCATION AND ENTERTAINMENT

FOR EDUCATIONAL SERVICES, NAMELY, PROVIDING COURSES OF INSTRUCTION AT THE COLLEGE LEVEL; ORGANIZING COLLEGE SPORTING EXHIBITIONS AND EVENTS; PROVIDING RECREATIONAL SPORTING ACTIVITIES; AND PROVIDING EDUCATIONAL DRAMATIC AND MUSICAL EVENTS (U.S. CLS. 100, 101 AND 107).

SN 76-349,005. DTN WEATHER SERVICES, LLC, BURNSVILLE, MN. FILED 12-12-2001.

MXVISION

CLASS 9—ELECTRICAL AND SCIENTIFIC APPARATUS

FOR SOFTWARE FOR PROCESSING AND DISPLAYING WEATHER INFORMATION (U.S. CLS. 21, 23, 26, 36 AND 38).

CLASS 42—SCIENTIFIC, COMPUTER AND LEGAL SERVICES

FOR WEATHER FORECASTING SERVICES, NAMELY DISTRIBUTION OF WEATHER INFORMATION (U.S. CLS. 100 AND 101).

SN 76-355,646. DTN WEATHER SERVICES, LLC, BURNSVILLE, MN. FILED 1-4-2002.

MXVISION STORMGUARD

CLASS 9—ELECTRICAL AND SCIENTIFIC APPARATUS

FOR COMPUTER SOFTWARE FOR DISPLAYING WEATHER INFORMATION (U.S. CLS. 21, 23, 26, 36 AND 38).

CLASS 42—SCIENTIFIC, COMPUTER AND LEGAL SERVICES

FOR WEATHER FORECASTING AND REPORTING SERVICES, NAMELY PROVIDING WEATHER DATA REGARDING CURRENT CONDITIONS AND FORECASTS TO SUBSCRIBERS VIA CELLULAR COMMUNICATION DEVICES SUCH AS CELLULAR TELEPHONES AND COMPUTERS SUCH AS PERSONAL DIGITAL ASSISTANTS (U.S. CLS. 100 AND 101).

SN 78-000,552. ANIMAL HEALTH PUBLICATIONS, LLC, PRESTON, ID. FILED 3-22-2000.

INFOVETS

CLASS 9—ELECTRICAL AND SCIENTIFIC APPARATUS

FOR (BASED ON INTENT TO USE) COMPACT DISCS FEATURING INFORMATION ON DOGS, CATS, COWS, HORSES, SMALL RUMINANTS, SHEEP, LLAMAS, AND GOATS AND EXOTIC ANIMALS, BIRDS, FISH, RODENTS, AND FERRETS (U.S. CLS. 21, 23, 26, 36 AND 38).

CLASS 16—PAPER GOODS AND PRINTED MATTER

FOR (BASED ON USE IN COMMERCE) BOOKS, NAMELY, REFERENCE MANUALS FEATURING INFORMATION ON DOGS, CATS, COWS, AND HORSES; (BASED ON INTENT TO USE) BOOKS, NAMELY, REFERENCE MANUALS FEATURING INFORMATION ON SMALL RUMINANTS, SHEEP, LLAMAS, AND GOATS, AND EXOTIC ANIMALS, BIRDS, FISH, RODENTS, AND FERRETS (U.S. CLS. 2, 5, 22, 23, 29, 37, 38 AND 50).

FIRST USE 1-10-2000; IN COMMERCE 1-15-2000.

CLASS 42—SCIENTIFIC, COMPUTER AND LEGAL SERVICES

FOR (BASED ON USE IN COMMERCE) PROVIDING AN ON-LINE SEARCHABLE ELECTRONIC DATABASE AND WEBSITE ON THE INTERNET, BOTH FEATURING INFORMATION IN THE FIELD OF REFERENCE MATERIALS ON DOGS, CATS, COWS, AND HORSES; (BASED ON INTENT TO USE) PROVIDING AN ON-LINE SEARCHABLE ELECTRONIC DATABASE AND WEBSITE ON THE INTERNET, BOTH FEATURING INFORMATION IN THE FIELD OF REFERENCE MATERIALS ON SMALL RUMINANTS, SHEEP LLAMAS, AND GOATS AND EXOTIC ANIMALS, BIRDS, FISH, RODENTS, AND FERRETS (U.S. CLS. 100 AND 101).

FIRST USE 1-10-2000; IN COMMERCE 1-15-2000.

SN 78-004,202. UNLIMITED ACQUISITION CONSULTING, INC., NEW CASTLE, DE. FILED 4-14-2000.

UNLIMITED ACQUISITION CONSULTING, INC.

NO CLAIM IS MADE TO THE EXCLUSIVE RIGHT TO USE "ACQUISITION CONSULTING, INC.", APART FROM THE MARK AS SHOWN.

CLASS 36—INSURANCE AND FINANCIAL

FOR LEASING OF REAL ESTATE AND REAL PROPERTY (U.S. CLS. 100, 101 AND 102).

FIRST USE 1-3-2000; IN COMMERCE 2-21-2000.

CLASS 37—CONSTRUCTION AND REPAIR

FOR SITE SELECTION OF REAL ESTATE AND REAL PROPERTY (U.S. CLS. 100, 103 AND 106).
FIRST USE 1-3-2000; IN COMMERCE 2-21-2000.

SN 78-017,520. UNIVERSAL TALKWARE CORPORATION,
MINNEAPOLIS, MN. FILED 7-19-2000.

PRESSBOX**CLASS 9—ELECTRICAL AND SCIENTIFIC APPARATUS**

FOR INTEGRATED TELECOMMUNICATIONS COMPUTERS CONTAINING TELEPHONES, VIDEO SCREENS, MODEMS, COMPUTER DRIVES, FACSIMILE MACHINES, AND SCANNERS AND PERIPHERALS AND ASSOCIATED COMPUTER SOFTWARE TO ACCESS A GLOBAL COMPUTER NETWORK FOR USE IN HOMES, HOTELS, AND OFFICES FOR ACCESSING SITES ON THE WORLD WIDE WEB FOR OBTAINING NEWS, WEATHER AND OTHER INFORMATION, FOR ELECTRONIC BANKING AND ACCESSING GLOBAL COMPUTER NETWORKS, FOR VOICE AND VOICE MAIL COMMUNICATIONS, FOR ON-LINE GLOBAL COMMUNICATIONS NETWORKS AND TELEPHONE COMMUNICATIONS, AND FOR RECEIVING AND TRANSMITTING ELECTRONIC MAIL COMMUNICATIONS; TELECOMMUNICATIONS AND COMPUTER SOFTWARE AND PROGRAMS, NAMELY COMPUTER ELECTRONIC MAIL PROGRAMS, ELECTRONIC BROWSING SOFTWARE, COMPUTER VOICE MAIL PROGRAMS, COMPUTER ADDRESS BOOK PROGRAMS, COMPUTER CALENDAR PROGRAMS AND USER MANUALS SOLD IN CONNECTION THEREWITH; TELEPHONES; SATELLITE DISHES, RECEIVER UNITS AND TERMINALS, AND PARTS, ACCESSORIES AND SOFTWARE FOR OPERATION THEREOF; EQUIPMENT FOR RECEIVING, PROCESSING, AND TRANSMITTING TELECOMMUNICATIONS AND WIRELESS SIGNALS, NAMELY, TELEPHONES, FACSIMILE MACHINES, COMPUTERS, RADIOS, TELEVISIONS, CABLE SET-TOP BOXES, USER TERMINALS, ANTENNAS, MODEMS, RECEIVER CIRCUITS, MODULES, SWITCHES, PROCESSORS, TRANSMITTERS, RECEIVERS, VIDEO DISPLAY DEVICES, WIRELESS BROAD-BAND COMMUNICATIONS HARDWARE AND SOFTWARE, AND SATELLITE STATIONS (U.S. CLS. 21, 23, 26, 36 AND 38).

SN 78-012,623. INNOVATA BIOMED LIMITED, ST. ALBANS,
UNITED KINGDOM, FILED 6-14-2000.

TECHNOHALER

OWNER OF UNITED KINGDOM REG. NO. 2068677,
DATED 4-16-1996, EXPIRES 4-16-2006.

CLASS 5—PHARMACEUTICALS

FOR INHALERS FOR DELIVERY OF PHARMACEUTICAL PREPARATIONS TO THE LUNGS FOR TREATMENT OF PULMONARY OR SYSTEMIC DISEASES (U.S. CLS. 6, 18, 44, 46, 51 AND 52).

CLASS 10—MEDICAL APPARATUS

FOR MEDICAL AND SURGICAL APPARATUS, NAMELY, INHALERS FOR THERAPEUTIC USE SOLD EMPTY AND PARTS THEREFOR (U.S. CLS. 26, 39 AND 44).

SN 78-015,334. PRODUCTOS ALIMENTICIOS BOCADELI,
S.A. DE C.V., SOYAPANGO, EL SALVADOR, FILED 7-3-
2000.

**CLASS 29—MEATS AND PROCESSED FOODS**

FOR MEAT, FISH, POULTRY AND GAME; MEAT EXTRACTS; PRESERVED, DRIED AND COOKED FRUITS AND VEGETABLES; JELLIES, JAMS, FRUIT SAUCES; EGGS, MILK, AND MILK PRODUCTS; EDIBLE OILS AND FATS (U.S. CL. 46).

CLASS 30—STAPLE FOODS

FOR COFFEE, TEA, COCOA, SUGAR, RICE, TAPIOCA, SAGO, ARTIFICIAL COFFEE; FLOUR AND PREPARATIONS MADE FROM CEREALS, BREAD, PASTRY AND CONFECTIONERY, HONEY, TREACLE; YEAST, BAKING-POWDER; SALT, MUSTARD; VINEGAR, SPICES; ICE (U.S. CL. 46).

CLASS 38—COMMUNICATION

FOR COMMUNICATIONS SERVICES, NAMELY PROVIDING TELECOMMUNICATIONS CONNECTIONS VIA TELEPHONE, SATELLITE, CABLE AND ON-LINE GLOBAL COMMUNICATIONS NETWORKS FOR OBTAINING NEWS, WEATHER AND OTHER INFORMATION, ELECTRONIC BANKING AND ACCESSING ELECTRONIC COMMERCE SITES, FOR BROWSING ON-LINE GLOBAL COMMUNICATIONS NETWORKS, FOR TELEPHONE AND VOICE MAIL TELECOMMUNICATIONS, FOR ON-LINE GLOBAL NETWORK COMMUNICATIONS AND FOR RECEIVING AND TRANSMITTING ELECTRONIC MAIL COMMUNICATIONS; PROVIDING TELECOMMUNICATIONS CONNECTIONS TO A GLOBAL COMPUTER NETWORK FEATURING COMPUTER DATABASES; PROVIDING ON-LINE ELECTRONIC BULLETIN BOARDS FOR TRANSMISSION OF MESSAGES AMONG COMPUTER USERS CONCERNING TOPICS OF GENERAL INTERESTS; AND PROVIDING ON-LINE FACILITIES FOR REAL-TIME INTERACTION WITH OTHER COMPUTER USERS CONCERNING TOPICS OF MUTUAL INTEREST (U.S. CLS. 100, 101 AND 104).

CLASS 42—SCIENTIFIC, COMPUTER AND LEGAL SERVICES

FOR CREATING INDEXES OF INFORMATION, WORLD WIDE WEB SITES AND OTHER RESOURCES AVAILABLE ON GLOBAL COMPUTER NETWORKS FOR OTHERS; SEARCHING, BROWSING AND RETRIEVING INFORMATION, WORLD WIDE WEBSITES AND OTHER RESOURCES AVAILABLE ON GLOBAL COMPUTER NETWORKS FOR OTHERS; DATING SERVICES; AND HOSTING WEB SITES OF OTHERS ON A COMPUTER SERVER VIA GLOBAL COMPUTER NETWORKS (U.S. CLS. 100 AND 101).

SN 78-027,136. GUASCO, RICHARD, PLEASANTON, CA.
FILED 9-21-2000.

PURE HELL

CLASS 16—PAPER GOODS AND PRINTED MATTER

FOR POSTERS AND ART PRINTS (U.S. CLS. 2, 5, 22, 23, 29, 37, 38 AND 50).

CLASS 25—CLOTHING

FOR T-SHIRTS, HATS AND BASEBALL CAPS (U.S. CLS. 22 AND 39).

SN 78-027,487. ALEXANDRAZ.COM LIMITED, KOWLOON,
HONG KONG, FILED 9-25-2000.

ALEXANDRAZ

CLASS 25—CLOTHING

FOR CLOTHING, NAMELY WOMEN'S, MEN'S, BOYS AND GIRLS SHOES; SOCKS; HOSIERY; SCARVES; BATHING SUITS; CAPS; DRESSES; JEANS; PANTS; SKIRTS; SHIRTS; SUITS; SWEATERS; T-SHIRTS; LINGERIE; BRAS; UNDERWEAR; NIGHT GOWNS; JACKETS; SKI JACKETS; SLEEPWEAR, EVENING GOWNS AND TUXEDOS (U.S. CLS. 22 AND 39).

CLASS 35—ADVERTISING AND BUSINESS

FOR RETAIL CLOTHING STORES, COMPUTERIZED ON-LINE RETAIL SERVICES IN THE FIELD OF MEN'S, WOMEN'S, BOYS' AND GIRLS' CLOTHING (U.S. CLS. 100, 101 AND 102).

SN 78-031,730. MAN RAY TRUST, NEW YORK, NY. FILED
10-20-2000.

MAN RAY

OWNER OF U.S. REG. NO. 2,341,362.

CLASS 9—ELECTRICAL AND SCIENTIFIC APPARATUS

FOR VIDEO AND AUDIO RECORDINGS ON TAPES AND PRE-RECORDED CASSETTES, COMPACT DISCS AND CD-ROMS FEATURING ART, MUSIC, MUSICAL AND DRAMATICS WORKS, CULTURAL AND ART HISTORY AND PHILOSOPHY, AND DRAMATIC AND DOCUMENTARY FILMS (U.S. CLS. 21, 23, 26, 36 AND 38).

CLASS 14—JEWELRY

FOR JEWELRY MADE OF PRECIOUS METALS AND THEIR ALLOYS OR COATED THEREWITH; WATCHES, CLOCKS (U.S. CLS. 2, 27, 28 AND 50).

CLASS 16—PAPER GOODS AND PRINTED MATTER

FOR POSTERS, CALENDARS, POST CARDS, MOUNTED AND UNMOUNTED PHOTOGRAPHS, PHOTOGRAPH ALBUMS, AUTOGRAPH ALBUMS, DIARIES, STATIONERY, ARTISTS' MATERIALS, SPECIFICALLY PAINTS, INKS, COLORED PENCILS AND PENS, PAPER AND DRAWING PADS; PAINT BRUSHES, BOOKS, WRITING INSTRUMENTS, DRAWING RULERS, NOTE CARDS, NOTE PADS, NOTE BOOKS, PLAYING CARDS (U.S. CLS. 2, 5, 22, 23, 29, 37, 38 AND 50).

CLASS 25—CLOTHING

FOR CLOTHING FOR MEN, WOMEN AND CHILDREN, NAMELY, T-SHIRTS, DRESSES, SKIRTS, SHIRTS, SWEATERS, SWEATSHIRTS, BLOUSES, PANTS, SHORTS, JACKETS, PARKAS, COATS, PAJAMAS, UNDERWEAR, LINGERIE, HOSIERY; BELTS, SCARVES, TIES, BOW TIES, SOCKS; HATS, CAPS, GLOVES, MITTENS; FOOTWEAR (U.S. CLS. 22 AND 39).

CLASS 42—SCIENTIFIC, COMPUTER AND LEGAL SERVICES

FOR RESTAURANT SERVICES; NIGHTCLUB SERVICES FEATURING PRE-RECORDED AND LIVE MUSICAL PERFORMANCE BY MUSICAL BANDS, ROCK GROUPS AND VOCAL PERFORMANCES (U.S. CLS. 100 AND 101).

SN 78-035,374. MGM TELEVISION ENTERTAINMENT INC.,
SANTA MONICA, CA. FILED 11-15-2000.



CLASS 9—ELECTRICAL AND SCIENTIFIC APPARATUS

FOR COMPUTER GAME CASSETTES, CARTRIDGES, PROGRAMS, TAPES AND CD-ROMS; VIDEO AND COMPUTER GAME CASSETTES AND CARTRIDGES ADAPTED FOR USE WITH TELEVISION RECEIVERS; VIDEO OUTPUT GAME MACHINES FOR USE WITH TELEVISIONS; COMPUTER HARDWARE AND SOFTWARE FOR MULTIMEDIA COMPUTER GAMES AND INTERACTIVE COMPUTER GAMES (U.S. CLS. 21, 23, 26, 36 AND 38).

CLASS 28—TOYS AND SPORTING GOODS

FOR TOYS, GAMES, AND PLAYTHINGS, NAMELY, ACTION FIGURE TOYS AND ACCESSORIES THEREFOR; MECHANICAL ACTION TOYS; ELECTRIC ACTION TOYS; ACTION SKILL GAMES; BOARD GAMES; CARD GAMES; ELECTRONIC GAME EQUIPMENT CONTAINING MEMORY DEVICES, NAMELY, HANDHELD UNITS WITH A WATCH FUNCTION, HANDHELD UNITS FOR PLAYING ELECTRONIC AND VIDEO GAMES, STAND ALONE VIDEO GAME MACHINES, COIN-OPERATED VIDEO GAMES AND HAND HELD UNITS FOR PLAYING ELECTRONIC COMPUTER GAMES; SPORTS BALLS; PLAYGROUND BALLS; FOAM BALLS; TOY BASKETBALL HOOP SETS; BASKETBALL BACKBOARDS; SKATEBOARDS; PLAY ACTION FIGURES, FIGURINES AND ACCESSORIES THEREFOR, NAMELY, TOY FIGURES WITH MAGNETIC FEATURES; TALKING TOYS; HOBBY CRAFT KITS FOR MAKING DOLLS AND FIGURINES; TOY BANKS; BATH TUB TOYS; CHILDREN'S MULTIPLE ACTIVITY TOYS; WATER SQUIRTING TOYS; WIND-UP TOYS; JIGSAW AND MANIPULATIVE PUZZLES; MECHANICAL TOYS; BATTERY-OPERATED TOYS; DOLLS AND PUPPETS AND ACCESSORIES THEREFOR; KITES; PAPER AND PLASTIC PARTY FAVORS IN THE NATURE OF SMALL TOYS AND NOISEMAKERS; STUFFED AND PLUSH TOYS; LATEX SQUEEZE TOYS; MUSICAL TOYS; FACE MASKS, COSTUME MASKS; FLYING DISCS; CHRISTMAS TREE DECORATIONS; TOY GUNS; TOY MUSICAL INSTRUMENTS; TOY CARS, TRUCKS AND OTHER TOY VEHICLES; INFLATABLE BATH, SWIMMING AND RIDE-ON TOYS (U.S. CLS. 22, 23, 38 AND 50).

CLASS 9—ELECTRICAL AND SCIENTIFIC APPARATUS

FOR PRE-RECORDED AUDIO CASSETTE TAPES, PRE-RECORDED VIDEO TAPES, PRE-RECORDED DVD'S, PRE-RECORDED COMPACT DISCS AND COMPUTER SOFTWARE IN THE FIELD OF FINANCIAL PLANNING AND LIFE INSURANCE PROGRAMS (U.S. CLS. 21, 23, 26, 36 AND 38).

CLASS 16—PAPER GOODS AND PRINTED MATTER

FOR BOOKS AND PUBLICATIONS, NAMELY, NEWSLETTERS, PAMPHLETS, BROCHURES AND MAGAZINES, IN THE FIELD OF FINANCIAL PLANNING AND LIFE INSURANCE PROGRAMS (U.S. CLS. 2, 5, 22, 23, 29, 37, 38 AND 50).

CLASS 41—EDUCATION AND ENTERTAINMENT

FOR EDUCATIONAL SERVICES, NAMELY CONDUCTING COURSES AND SEMINARS IN THE FIELD OF FINANCIAL PLANNING AND LIFE INSURANCE PROGRAMS, AND PROVIDING TRAINING IN THE FIELD OF FINANCIAL PLANNING AND LIFE INSURANCE PROGRAMS OVER A GLOBAL COMPUTER NETWORK (U.S. CLS. 100, 101 AND 107).

SN 78-038,373. SYNGENTA PARTICIPATIONS AG, BASEL, SWITZERLAND, FILED 12-8-2000.

CISAM**CLASS 9—ELECTRICAL AND SCIENTIFIC APPARATUS**

FOR COMPUTER SOFTWARE AND COMPACT DISCS CONTAINING INFORMATION, ADVICE AND PROVIDING TRAINING WITH RESPECT TO THE GROWING OF CROPS, SEEDS AND OTHER PLANTS AND THE APPLICATION OF PLANT AND SEED PROTECTION PRODUCTS (U.S. CLS. 21, 23, 26, 36 AND 38).

CLASS 42—SCIENTIFIC, COMPUTER AND LEGAL SERVICES

FOR INTEGRATED SCIENTIFIC RESEARCH ON PESTS IN GREENHOUSES AND FIELD CROPS (U.S. CLS. 100 AND 101).

SN 78-039,010. ALLIANZ LIFE INSURANCE COMPANY OF NORTH AMERICA, MINNEAPOLIS, MN. FILED 12-12-2000.

LIFE INSURANCE MASTERS

NO CLAIM IS MADE TO THE EXCLUSIVE RIGHT TO USE "LIFE INSURANCE", APART FROM THE MARK AS SHOWN.

SN 78-039,188. BRED BANQUE POPULAIRE, PARIS, FRANCE, FILED 12-13-2000.

TRUST ME CARD

PRIORITY CLAIMED UNDER SEC. 44(D) ON FRANCE APPLICATION NO. 003034842, FILED 6-14-2000, REG. NO. 003034842, DATED 6-14-2000, EXPIRES 6-14-2010.

PRIORITY CLAIMED UNDER SEC. 44(D) ON FRANCE APPLICATION NO. 003034842, FILED 6-14-2000, REG. NO. 003034842, DATED 6-14-2000, EXPIRES 6-14-2010.

PRIORITY CLAIMED UNDER SEC. 44(D) ON FRANCE APPLICATION NO. 003034842, FILED 6-14-2000, REG. NO. 003034842, DATED 6-14-2000, EXPIRES 6-14-2010.

PRIORITY CLAIMED UNDER SEC. 44(D) ON FRANCE APPLICATION NO. 003034842, FILED 6-14-2000, REG. NO. 003034842, DATED 6-14-2000, EXPIRES 6-14-2010.

PRIORITY CLAIMED UNDER SEC. 44(D) ON FRANCE APPLICATION NO. 003034842, FILED 6-14-2000, REG. NO. 003034842, DATED 6-14-2000, EXPIRES 6-14-2010.

NO CLAIM IS MADE TO THE EXCLUSIVE RIGHT TO USE "CARD", APART FROM THE MARK AS SHOWN.

CLASS 9—ELECTRICAL AND SCIENTIFIC APPARATUS

FOR APPARATUS FOR RECORDING, TRANSMISSION OR REPRODUCTION OF SOUND OR IMAGES, NAMELY, COMPUTERS, TELEPHONES AND DIGITAL DATA PROCESSORS; AUTOMATIC VENDING MACHINES AND MECHANISMS FOR COIN-OPERATED APPARATUS; CASH REGISTERS; CALCULATING MACHINES; DATA PROCESSING EQUIPMENT, NAMELY, DATA PROCESSORS AND COMPUTERS; MAGNETIC ENCODED CARDS; INTEGRATED CIRCUIT CARDS; MAGNETIC IDENTITY CARDS; MICROPROCESSORS; MAGNETIC DATA CARRIERS CONTAINING RECORDED INFORMATION AND DATA RELATED TO TELEPAYMENT AND DEMATERIALIZATION OF INVOLVING; RECORDING DISCS CONTAINING PRE-RECORDED INFORMATION AND DATA RELATED TO TELEPAYMENT AND DEMATERIALIZATION OF INVOICING (U.S. CLS. 21, 23, 26, 36 AND 38).

CLASS 16—PAPER GOODS AND PRINTED MATTER

FOR STATIONERY, PERIODICALS, NAMELY, MAGAZINES IN THE FIELD OF TELEPAYMENT; PRINTED MATTER, NAMELY, BROCHURES IN THE FIELD OF TELEPAYMENT; PRINTERS TYPE (U.S. CLS. 2, 5, 22, 23, 29, 37, 38 AND 50).

CLASS 35—ADVERTISING AND BUSINESS

FOR COMPUTERIZED DATABASE FILE MANAGEMENT; ADVERTISING SERVICES, NAMELY, PREPARING AND PLACING OF ADVERTISEMENTS FOR OTHERS; BUSINESS MANAGEMENT, BUSINESS ADMINISTRATION; PROVIDING BUSINESS INFORMATION, NAMELY, DISTRIBUTION OF BROCHURES, BUSINESS CONSULTANCY, BUSINESS INQUIRIES FOR OTHERS (U.S. CLS. 100, 101 AND 102).

CLASS 36—INSURANCE AND FINANCIAL

FOR BANKING; FINANCIAL AFFAIRS, NAMELY, FINANCIAL ANALYSIS AND CONSULTATION; MONETARY AFFAIRS, NAMELY, MONEY EXCHANGE; REAL ESTATE AFFAIRS, NAMELY REAL ESTATE MANAGEMENT; INSURANCE SERVICES, NAMELY, INSURANCE UNDERWRITING IN THE FIELD OF TELEPAYMENT (U.S. CLS. 100, 101 AND 102).

CLASS 38—COMMUNICATION

FOR ELECTRONIC TRANSMISSION OF BANKING AND FINANCIAL INFORMATION BY TELEMATIC WAYS, COMMUNICATIONS BY TELEPHONE BY RECEPTION OR BY EMISSION, BY VOICE RESPONSE AND BY TELEMATIC WAYS; ELECTRONIC TRANSMISSION OF SECURED MESSAGES AND IMAGES BY COMPUTER TERMINALS (U.S. CLS. 100, 101 AND 104).

SN 78-041,492. OSYPKA MEDICAL, INC., LA JOLLA, CA. FILED 1-3-2001.

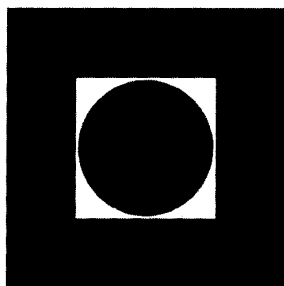
**CLASS 9—ELECTRICAL AND SCIENTIFIC APPARATUS**

FOR COMPUTER HARDWARE AND SOFTWARE USED BY MEDICAL PRACTITIONERS OF DATA PROCESSING (U.S. CLS. 21, 23, 26, 36 AND 38).

CLASS 10—MEDICAL APPARATUS

FOR MEDICAL AND SURGICAL APPARATUS, NAMELY, CARDIAC RHYTHM MANAGEMENT APPARATUS, NAMELY, CARDIAC PACEMAKERS AND PACING SYSTEMS ANALYZERS; MEDICAL MONITORING APPARATUS, NAMELY CARDIOVASCULAR MONITORS AND ACCESSORIES THEREFOR, NAMELY, ELECTRODES, SENSORS, CATHETERS AND PROBES; AND OPERATIONAL COMPUTER SOFTWARE FOR THE AFORESAID GOODS (U.S. CLS. 26, 39 AND 44).

SN 78-042,569. WEBMAGIC VENTURES, LLC, PASADENA, CA. FILED 1-10-2001.

KLOV**CLASS 35—ADVERTISING AND BUSINESS**

FOR PROVIDING INFORMATION ON SHOPPING OPPORTUNITIES PROVIDED BY OTHERS; PROVIDING ONLINE DIRECTORY INFORMATION SERVICES ALSO FEATURING HYPERLINKS TO OTHER WEBSITES; BUSINESS MARKETING CONSULTING SERVICES (U.S. CLS. 100, 101 AND 102).

FIRST USE 11-9-1995; IN COMMERCE 11-9-1995.

CLASS 41—EDUCATION AND ENTERTAINMENT

FOR PROVIDING INFORMATION ON GAMES PROVIDED BY OTHERS (U.S. CLS. 100, 101 AND 107).

FIRST USE 11-9-1995; IN COMMERCE 11-9-1995.

SN 78-046,822. FLEXIS, INC., PALO ALTO, CA. BY CHANGE OF NAME I-DNA, INC., PALO ALTO, CA. FILED 2-6-2001.

FLEXIS, INC.

NO CLAIM IS MADE TO THE EXCLUSIVE RIGHT TO USE "INC.", APART FROM THE MARK AS SHOWN.

CLASS 9—ELECTRICAL AND SCIENTIFIC APPARATUS

FOR COMPUTER SOFTWARE, NAMELY, DATABASE MANAGEMENT SYSTEMS AND APPLICATIONS, INFORMATION MANAGEMENT SYSTEMS AND APPLICATIONS, KNOWLEDGE MANAGEMENT SYSTEMS AND APPLICATIONS, DOCUMENT AND DATA MANAGEMENT APPLICATIONS, DOCUMENT AND DATA EXCHANGE APPLICATIONS, DOCUMENT IMAGING AND ARCHIVING, DISTRIBUTED NETWORKING SOFTWARE, INFORMATION EXCHANGE SOFTWARE, SEARCH ENGINE SOFTWARE, DYNAMIC BROWSER AND PORTAL SOFTWARE (U.S. CLS. 21, 23, 26, 36 AND 38).

CLASS 35—ADVERTISING AND BUSINESS

FOR ACCOUNTING INFORMATION PORTALS (U.S. CLS. 100, 101 AND 102).

CLASS 36—INSURANCE AND FINANCIAL

FOR INSURANCE INFORMATION PORTALS (U.S. CLS. 100, 101 AND 102).

CLASS 42—SCIENTIFIC, COMPUTER AND LEGAL SERVICES

FOR COMPUTER SOFTWARE CONSULTING, NAMELY, DATABASE, INFORMATION AND KNOWLEDGE MANAGEMENT CONSULTING; HOSTING THE WEB SITES OF OTHERS; DESIGNING AND IMPLEMENTING WEB SITES, WEB PAGES AND WEB PORTALS FOR OTHERS; MEDICAL INFORMATION PORTALS; LEGAL INFORMATION PORTALS (U.S. CLS. 100 AND 101).

SN 78-048,118. DATA CONVERSION, INC., CAMBRIDGE, MA. FILED 2-13-2001.

ZENANT**CLASS 35—ADVERTISING AND BUSINESS**

FOR ACCOUNTING SERVICES; TRANSCRIPTION SERVICES; OPERATION OF TELEPHONE CALL CENTERS FOR OTHERS; BUSINESS MANAGEMENT CONSULTATION; COMPUTERIZED DATABASE MANAGEMENT (U.S. CLS. 100, 101 AND 102).

CLASS 42—SCIENTIFIC, COMPUTER AND LEGAL SERVICES

FOR CONSULTING SERVICES IN THE FIELD OF DESIGN, SELECTION, IMPLEMENTATION AND USE OF COMPUTER HARDWARE AND SOFTWARE SYSTEMS FOR OTHERS; COMPUTER GRAPHICS SERVICES, NAMELY, CAD/CAM MODELING; TECHNICAL SUPPORT, NAMELY, TROUBLESHOOTING OF COMPUTER HARDWARE AND SOFTWARE PROBLEMS; DATA CONVERSION OF COMPUTER PROGRAM DATA OR INFORMATION; COMPUTER SYSTEMS ANALYSIS; DESIGN AND TESTING OF NEW PRODUCTS FOR OTHERS NAMELY, COMPUTER SOFTWARE; MAPPING SERVICES; COMPUTER NETWORK DESIGN FOR OTHERS; COMPUTER SERVICES, NAMELY, DESIGNING AND IMPLEMENTING NETWORK WEBPAGES FOR OTHERS; MAINTENANCE OF COMPUTER SOFTWARE; COMPUTER SOFTWARE DESIGN FOR OTHERS; COMPUTER SOFTWARE CONSULTATION; COMPUTER SOFTWARE DEVELOPMENT; INSTALLATION OF COMPUTER SOFTWARE, NAMELY, INSTALLATION OF GEOGRAPHICAL INFORMATION SYSTEMS GIS; DATA WAREHOUSING (U.S. CLS. 100 AND 101).

SN 78-048,431. PASS!TIME MARKETING, SAN JOSE, CA. FILED 2-14-2001.

PAR**CLASS 35—ADVERTISING AND BUSINESS**

FOR CARTOON CHARACTER LICENSING (U.S. CLS. 100, 101 AND 102).

CLASS 41—EDUCATION AND ENTERTAINMENT

FOR ENTERTAINMENT SERVICES, NAMELY, PERSONAL APPEARANCES BY A SPORT MASCOT FOR THE GAME OF GOLF (U.S. CLS. 100, 101 AND 107).

SN 78-048,665. BERGNER, GEORGE, BOONVILLE, CA. FILED 2-15-2001.

**DOMAINE
DOROTHÉ**

NO CLAIM IS MADE TO THE EXCLUSIVE RIGHT TO USE "DOMAINE", APART FROM THE MARK AS SHOWN.

THE MARK IS PRESENTED WITHOUT ANY CLAIM AS TO SPECIAL FORM

THE ENGLISH TRANSLATION OF THE FRENCH WORDS "DOMAINE DOROTHE" IN THE MARK IS "DOROTH ESTATE"

CLASS 31—NATURAL AGRICULTURAL PRODUCTS

FOR NATURAL AGRICULTURAL PRODUCTS, NAMELY FRESH GRAPES (U.S. CLS. 1 AND 46).

CLASS 33—WINES AND SPIRITS

FOR WINE AND SPIRITS, NAMELY WINES, LIQUEURS AND DISTILLED SPIRITS (U.S. CLS. 47 AND 49).

CLASS 41—EDUCATION AND ENTERTAINMENT

FOR CONDUCTING ENTERTAINMENT EXHIBITIONS IN THE NATURE OF WINE FESTIVALS (U.S. CLS. 100, 101 AND 107).

SN 78-049,017. ARTIZON LLC, RALEIGH, NC. FILED 2-19-2001.

ARTIZON**CLASS 38—COMMUNICATION**

FOR BROADCASTING SERVICES (U.S. CLS. 100, 101 AND 104).

CLASS 41—EDUCATION AND ENTERTAINMENT

FOR VIDEO EDITING SERVICES, PRODUCTION OF AUDIO RECORDINGS AND VIDEOTAPES, SCRIPTS WRITING, STORYBOARDING, AND COMPOSITION OF MUSIC FOR OTHERS (U.S. CLS. 100, 101 AND 107).

SN 78-049,487. PASS!TIME MARKETING, SAN JOSE, CA. FILED 2-21-2001.

KNOCKDOWN**CLASS 35—ADVERTISING AND BUSINESS**

FOR ADVERTISING SLOGAN AND CARTOON CHARACTER LICENSING (U.S. CLS. 100, 101 AND 102).

CLASS 41—EDUCATION AND ENTERTAINMENT

SN 78-051,599. LA MONT LLC, MADISON, WI. FILED 3-6-2001.

FOR ENTERTAINMENT SERVICES, NAMELY, PERSONAL APPEARANCES BY A SPORT MASCOT FOR FIGHTING SPORTS (U.S. CLS. 100, 101 AND 107).

SN 78-051,598. LA MONT LLC, MADISON, WI. FILED 3-6-2001.



CLASS 9—ELECTRICAL AND SCIENTIFIC APPARATUS

CLASS 9—ELECTRICAL AND SCIENTIFIC APPARATUS

FOR CIRCUIT BOARDS, NAMELY DATA ACQUISITION CIRCUITRY; MONITORING CIRCUITRY (U.S. CLS. 21, 23, 26, 36 AND 38).

FOR CIRCUIT BOARDS, NAMELY DATA ACQUISITION CIRCUITRY; MONITORING CIRCUITRY (U.S. CLS. 21, 23, 26, 36 AND 38).

CLASS 10—MEDICAL APPARATUS

CLASS 10—MEDICAL APPARATUS

FOR MEDICAL DEVICES, NAMELY, NEUROPHYSIOLOGY AMPLIFIERS FOR MONITORING THE ELECTROENCEPHALOGRAPH (EEG), POLYSOMNOGRAM (PSG) AMBULATORY EEG OR ELECTROCARDIOGRAM (ECG), INFRA-RED ELECTRO-NYSTAGMOGRAM (ENG); MEDICAL DIAGNOSTIC EQUIPMENT, NAMELY, NEUROPHYSIOLOGICAL AND CARDIAC MONITORING APPARATUS; DIGITAL VIDEO PATIENT MONITORING SYSTEMS COMPRISING PATIENT NEUROPHYSIOLOGY AMPLIFIERS, JACKBOXES, ELECTRODE SETS, PATIENTS EXTENSION CABLES, COMPUTER INTERFACE CARDS, COMPUTERS, DISK DRIVES, MONITORS AND KEYBOARDS, AND MEDICAL COMPUTER SOFTWARE FOR MONITORING, RECORDING, TRANSMITTING, WIRELESS TELEMETRY, NETWORKING, TELEMEDICINE, AND REPLAYING HUMAN EEG AND ECG AND OTHER PHYSIOLOGICAL SIGNALS; AND DIGITAL VIDEO PATIENT MONITORING EQUIPMENT, NAMELY, DIGITAL EEG AND PSG, WHICH ACQUIRE, DISPLAY, RECORD, REPLAY, ANALYZE AND ARCHIVE PATIENT DATA, AUDIO AND VIDEO IMAGES, NAMELY, DIGITAL EEG AND PSG ACQUISITION OR READER STATION, DVD ROM PLAYER, RECORDER AND ARCHIVER FOR MONITORING, RECORDING, TRANSMITTING WIRELESS TELEMETRY, NETWORKING, TELEMEDICINE AND REPLAYING HUMAN EEG AND ECG AND OTHER PHYSIOLOGICAL SIGNALS; ELECTRONIC MEDICAL APPARATUS FOR MONITORING NEUROPHYSIOLOGICAL RESPONSE, AND INFRA-RED ELECTRO-NYSTAGMOGRAPHY (ENG) APPARATUS FOR AUDIOLOGICAL DIAGNOSTICS; INFRA-RED MEDICAL APPARATUS FOR VESTIBULAR-OCULAR CONTROL DIAGNOSTICS (U.S. CLS. 26, 39 AND 44).

FOR MEDICAL DEVICES, NAMELY, NEUROPHYSIOLOGY AMPLIFIERS FOR MONITORING THE ELECTROENCEPHALOGRAPH (EEG), POLYSOMNOGRAM (PSG), AMBULATORY EEG OR ELECTROCARDIOGRAM (ECG), INFRA-RED ELECTRO-NYSTAGMOGRAM (ENG); MEDICAL DIAGNOSTIC EQUIPMENT, NAMELY, NEUROPHYSIOLOGICAL AND CARDIAC MONITORING APPARATUS; DIGITAL VIDEO PATIENT MONITORING SYSTEMS COMPRISING PATIENT NEUROPHYSIOLOGY AMPLIFIERS, JACKBOXES, ELECTRODE SETS, PATIENT EXTENSION CABLES, COMPUTER INTERFACE CARDS, COMPUTERS, DISK DRIVES, MONITORS AND KEYBOARDS, AND MEDICAL COMPUTER SOFTWARE FOR MONITORING, RECORDING, TRANSMITTING, WIRELESS TELEMETRY, NETWORKING, TELEMEDICINE, AND REPLAYING HUMAN EEG AND ECG AND OTHER PHYSIOLOGICAL SIGNALS; AND DIGITAL VIDEO PATIENT MONITORING EQUIPMENT, NAMELY, DIGITAL EEG AND PSG, WHICH ACQUIRE DISPLAY, RECORD, REPLAY, ANALYZE AND ARCHIVE PATIENT DATA, AUDIO AND VIDEO IMAGES, NAMELY, DIGITAL EEG AND PSG ACQUISITION OR READER STATION, DVD ROM PLAYER, RECORDER AND ARCHIVER FOR MONITORING, RECORDING, TRANSMITTING WIRELESS TELEMETRY, NETWORKING, TELEMEDICINE AND REPLAYING HUMAN EEG AND ECG AND OTHER PHYSIOLOGICAL SIGNALS; ELECTRONIC MEDICAL APPARATUS FOR MONITORING NEUROPHYSIOLOGICAL RESPONSE, AND INFRA-RED ELECTRO-NYSTAGMOGRAPHY (ENG) APPARATUS FOR AUDIOLOGICAL DIAGNOSTICS; INFRA-RED MEDICAL APPARATUS FOR VESTIBULAR-OCULAR CONTROL DIAGNOSTICS (U.S. CLS. 26, 39 AND 44).

SN 78-054,772. FOLEY, ALYSON, NEW YORK, NY. FILED 3-23-2001.



NO CLAIM IS MADE TO THE EXCLUSIVE RIGHT TO USE "NEW YORK", APART FROM THE MARK AS SHOWN.

CLASS 18—LEATHER GOODS

FOR HANDBAGS AND WALLETS (U.S. CLS. 1, 2, 3, 22 AND 41).
FIRST USE 1-0-2000; IN COMMERCE 3-0-2000.

CLASS 25—CLOTHING

FOR BELTS, T-SHIRTS, SKIRTS, PANTS AND SHIRTS (U.S. CLS. 22 AND 39).
FIRST USE 1-0-2000; IN COMMERCE 3-0-2000.

SN 78-058,476. ROOFIXER.COM, INC., SANTA ANA, CA. AND ROOFIXER.COM, INC., SANTA ANA, CA. AND ROOFIXER.COM HOME WARRANTY COMPANY OF GEORGIA, INC., SANTA ANA, CA. FILED 4-14-2001.



NO CLAIM IS MADE TO THE EXCLUSIVE RIGHT TO USE "ROOFIXER.COM", APART FROM THE MARK AS SHOWN.

THE LINING IS A FEATURE OF THE MARK AND DOES NOT INDICATE COLOR.

CLASS 36—INSURANCE AND FINANCIAL

FOR INSURANCE SERVICES, NAMELY, UNDERWRITING SERVICE CONTRACTS ON ROOFING SYSTEMS ON NEW AND EXISTING COMMERCIAL, INDUSTRIAL, AND RESIDENTIAL ROOFING SYSTEMS; PROVIDING SERVICE CONTRACTS COVERING COMMERCIAL, INDUSTRIAL, AND RESIDENTIAL ROOFING SYSTEMS; SERVICE CONTRACT CLAIMS ADMINISTRATION, NAMELY, PROCESSING AND PAYING CLAIMS FILED UNDER SERVICE CONTRACTS COVERING COMMERCIAL, INDUSTRIAL, AND RESIDENTIAL ROOFING SYSTEMS (U.S. CLS. 100, 101 AND 102).

FIRST USE 11-27-2000, THE MARK WAS USED ANYWHERE IN A DIFFERENT FORM OTHER THAN THAT SOUGHT TO BE REGISTERED ON 08/16/1999 ; IN COMMERCE 11-27-2000, THE MARK WAS USED ANYWHERE IN A DIFFERENT FORM OTHER THAN THAT SOUGHT TO BE REGISTERED IN COMMERCE ON 08/16/1999.

CLASS 37—CONSTRUCTION AND REPAIR

FOR INSTALLATION AND REPAIR OF ROOFING (U.S. CLS. 100, 103 AND 106).
FIRST USE 11-27-2000; IN COMMERCE 11-27-2000.

SN 78-058,571. AG MULTIMEDIA LTD., NEW YORK, NY. FILED 4-16-2001.

PASS MARKETING

NO CLAIM IS MADE TO THE EXCLUSIVE RIGHT TO USE "MARKETING", APART FROM THE MARK AS SHOWN.

CLASS 35—ADVERTISING AND BUSINESS

FOR PROMOTING AND ADVERTISING THE GOODS AND SERVICES OF OTHERS, DESIGNING PROMOTIONAL CAMPAIGNS FOR DISTRIBUTION IN PRINT, TELEVISION AND RADIO MEDIA AND OVER GLOBAL COMPUTER AND BUSINESS CONSULTATION SERVICES. (U.S. CLS. 100, 101 AND 102).

CLASS 38—COMMUNICATION

FOR COMMUNICATIONS SERVICES OVER RADIO; PROVIDING MULTIPLE-USER ACCESS TO A GLOBAL COMPUTER INFORMATION NETWORK; PROVIDING TELECOMMUNICATIONS CONNECTIONS TO A GLOBAL COMPUTER NETWORK; TELEVISION BROADCASTING. (U.S. CLS. 100, 101 AND 104).

CLASS 41—EDUCATION AND ENTERTAINMENT

FOR ENTERTAINMENT SERVICES, NAMELY PRODUCTION OF TELEVISION PROGRAMS, VIDEO TAPES, CD-ROMS, DIGITAL VIDEO DISCS (DVD), CASSETTES; PRODUCTION OF TELEVISION PROGRAMS AND MOTION PICTURES FOR OTHERS. (U.S. CLS. 100, 101 AND 107).

SN 78-058,844. GELBARD, JEFFREY, HAYDENVILLE, MA. FILED 4-17-2001.

WORDBOX

CLASS 9—ELECTRICAL AND SCIENTIFIC APPARATUS

FOR COMPUTER SOFTWARE AND SYSTEMS FOR USE IN COLLABORATIVE, NETWORK-BASED LANGUAGE TRANSLATION AND LOCALIZATION (U.S. CLS. 21, 23, 26, 36 AND 38).

CLASS 42—SCIENTIFIC, COMPUTER AND LEGAL SERVICES

FOR COMPUTER SERVICES, NAMELY, PROVIDING TEMPORARY USE OF ON-LINE, NON-DOWNLOADABLE SOFTWARE FOR USE IN COLLABORATIVE, NETWORK-BASED LANGUAGE TRANSLATION AND LOCALIZATION (U.S. CLS. 100 AND 101).

SN 78-058,901. FULL MOON BIO, SUNNYVALE, DE. FILED 4-17-2001.

FULL MOON BIO

NO CLAIM IS MADE TO THE EXCLUSIVE RIGHT TO USE "BIO", APART FROM THE MARK AS SHOWN.

CLASS 1—CHEMICALS

FOR REAGENTS AND CONSUMABLES FOR MEASURING BIOLOGIC MATERIALS (U.S. CLS. 1, 5, 6, 10, 26 AND 46).

CLASS 9—ELECTRICAL AND SCIENTIFIC APPARATUS

FOR BIOTECHNOLOGICAL INSTRUMENTS AND DEVICES NAMELY MICROARRAY SCANNERS, SPOTTERS AND SUPPORTING CONSUMABLES AND ACCESSORIES, FOR MEASURING BIOLOGIC MATERIALS (U.S. CLS. 21, 23, 26, 36 AND 38).

SN 78-060,570. PILLER-GMBH, OSTERODE AM HARZ, FED REP GERMANY, FILED 4-26-2001.

DYNASINE

PRIORITY CLAIMED UNDER SEC. 44(D) ON FED REP GERMANY APPLICATION NO. 30081653.7, FILED 11-6-2000, REG. NO. 30081653, DATED 11-6-2000, EXPIRES 11-30-2010.

PRIORITY CLAIMED UNDER SEC. 44(D) ON FED REP GERMANY APPLICATION NO. 30081653.7, FILED 11-6-2000, REG. NO. 30081653, DATED 11-6-2000, EXPIRES 11-30-2010.

CLASS 7—MACHINERY

FOR ROTATING ELECTRIC MACHINES FOR USE AS POWER CONVERTERS (U.S. CLS. 13, 19, 21, 23, 31, 34 AND 35).

CLASS 9—ELECTRICAL AND SCIENTIFIC APPARATUS

FOR ELECTRIC CIRCUITS FOR OPERATING ELECTRIC POWER SUPPLY NETWORKS; ELECTRIC CONTROLLERS FOR OPERATING ELECTRIC POWER SUPPLY NETWORKS; ELECTRIC POWER CONDITIONERS; ELECTRIC CIRCUITS FOR IMPROVING CURRENT AND VOLTAGE FOR INDUSTRIAL APPLICATIONS; POWER SUPPLY DEVICES; UNINTERRUPTABLE POWER SUPPLIES; ELECTRIC FREQUENCY, VOLTAGE AND POWER CONVERTERS (U.S. CLS. 21, 23, 26, 36 AND 38).

SN 78-060,767. ZENTARIS AG, FRANKFURT, FED REP GERMANY, FILED 4-27-2001.

ZENTARIS

PRIORITY CLAIMED UNDER SEC. 44(D) ON FED REP GERMANY APPLICATION NO. 30082696, FILED 11-9-2000, REG. NO. 30082696, DATED 4-11-2001, EXPIRES 11-30-2010.

CLASS 1—CHEMICALS

FOR FULL LINE OF CHEMICALS USED IN INDUSTRY AND SCIENCE (U.S. CLS. 1, 5, 6, 10, 26 AND 46).

CLASS 5—PHARMACEUTICALS

FOR FULL LINE OF PHARMACEUTICAL AND SANITARY PREPARATIONS (U.S. CLS. 6, 18, 44, 46, 51 AND 52).

CLASS 10—MEDICAL APPARATUS

FOR FULL LINE OF SURGICAL, MEDICAL AND DENTAL APPARATUS AND INSTRUMENTS (U.S. CLS. 26, 39 AND 44).

CLASS 42—SCIENTIFIC, COMPUTER AND LEGAL SERVICES

FOR SCIENTIFIC AND INDUSTRIAL RESEARCH AND CONSULTING (U.S. CLS. 100 AND 101).

SN 78-064,332. PEREGRINE FINANCIAL GROUP, INC., CHICAGO, IL. FILED 5-18-2001.



THE MARK CONSISTS OF THE GRAPHIC IMAGE OF A FALCON IN PROFILE, WITH HEAD DOWN, WINGS SPREAD IN FLIGHT AND TALONS EXTENDED FORWARD. COLOR IS NOT CLAIMED AS A FEATURE OF THE MARK.

CLASS 36—INSURANCE AND FINANCIAL

FOR BROKERAGE AND DEALER SERVICES IN THE FIELD OF SECURITIES AND COMMODITIES INVESTING (U.S. CLS. 100, 101 AND 102).

FIRST USE 2-1-1990; IN COMMERCE 2-1-1990.

CLASS 42—SCIENTIFIC, COMPUTER AND LEGAL SERVICES

FOR PROVIDING TEMPORARY USE OF ON-LINE, NON-DOWNLOADABLE SOFTWARE FOR ONLINE TRADING, NAMELY, TRANSACTION ORDER ENTRY, ORDER ROUTING AND ORDER CONFIRMATION SERVICES TO CUSTOMERS IN THE FIELD OF SECURITIES AND COMMODITIES INVESTING (U.S. CLS. 100 AND 101).

FIRST USE 2-1-1990; IN COMMERCE 2-1-1990.

SN 78-064,794. EK FINANCES, PARIS, FRANCE, FILED 5-21-2001.

HAREL

OWNER OF FRANCE REG. NO. 1479074, DATED 5-11-1998, EXPIRES 5-11-2008.

CLASS 14—JEWELRY

FOR JEWELRY, PRECIOUS STONES; CHRONOMETERS, WATCHES (U.S. CLS. 2, 27, 28 AND 50).

CLASS 18—LEATHER GOODS

FOR LEATHER AND IMITATIONS OF LEATHER, AND GOODS MADE OF THESE MATERIALS, NAMELY, HANDBAGS, BRIEFCASES, WALLETS, PURSES, BELTS; ANIMAL SKINS AND HIDES; TRUNKS AND TRAVELING BAGS; UMBRELLAS, PARASOLS AND WALKING STICKS; WHIPS, HARNESS AND SADDLERY (U.S. CLS. 1, 2, 3, 22 AND 41).

CLASS 25—CLOTHING

FOR CLOTHING, NAMELY, SUITS, TROUSERS, DRESSES, SKIRTS, SHIRTS, BLOUSES, PANTS, SOCKS; FOOTWEAR; HEADGEAR, NAMELY, HATS AND CAPS (U.S. CLS. 22 AND 39).

SN 78-065,572. ALLIANCE OF PROFESSIONALS & CONSULTANTS, INC., RALEIGH, NC. FILED 5-24-2001.

**CLASS 35—ADVERTISING AND BUSINESS**

FOR E-COMMERCE SERVICES, NAMELY, PROVIDING BUSINESS CONSULTATION IN THE FIELD OF E-COMMERCE (U.S. CLS. 100, 101 AND 102).
FIRST USE 11-15-1998; IN COMMERCE 11-17-1998.

CLASS 42—SCIENTIFIC, COMPUTER AND LEGAL SERVICES

FOR COMPUTER CONSULTATION (U.S. CLS. 100 AND 101).
FIRST USE 11-15-1998; IN COMMERCE 11-17-1998.

SN 78-066,970. ITERATIONS, L.L.C., PALO ALTO, CA. FILED 6-1-2001.

GROUP GENIUS

SEC. 2(F).

CLASS 35—ADVERTISING AND BUSINESS

FOR BUSINESS CONSULTATION SERVICES IN THE FIELD OF GROUP MODELING AND ENACTING HIGHER-ORDER SOLUTIONS FOR A VARIETY OF DECISIONS USING TIME COMPRESSION, SYSTEMIC WORKFLOW, DYNAMIC FEEDBACK, INDIVIDUAL CREATIVITY AND COLLECTIVE CREATIVITY, AMONG OTHER TECHNIQUES (U.S. CLS. 100, 101 AND 102).
FIRST USE 3-1-1980; IN COMMERCE 7-1-1983.

CLASS 41—EDUCATION AND ENTERTAINMENT

FOR EDUCATIONAL SERVICES, NAMELY, CONDUCTING SEMINARS, WORKSHOPS AND CONFERENCES IN THE FIELD OF GROUP MODELING AND ENACTING HIGHER-ORDER SOLUTIONS FOR A VARIETY OF DECISIONS USING TIME COMPRESSION, SYSTEMIC WORKFLOW, DYNAMIC FEEDBACK, INDIVIDUAL CREATIVITY AND COLLECTIVE CREATIVITY, AMONG OTHER TECHNIQUES (U.S. CLS. 100, 101 AND 107).
FIRST USE 3-1-1980; IN COMMERCE 7-1-1983.

SN 78-068,299. INOVX SOLUTIONS, IRVINE, CA. FILED 6-9-2001.

INOVX

CLASS 9—ELECTRICAL AND SCIENTIFIC APPARATUS

FOR COMPUTER SOFTWARE TO ACCESS, REVIEW AND MANAGE INDUSTRIAL, MANUFACTURING, AND PROCESS PLANT VISUAL DATA, AND TO INTEGRATE INDUSTRIAL, MANUFACTURING, AND PROCESS PLANT VISUAL DATA WITH OPERATION, MAINTENANCE, ENGINEERING AND CONSTRUCTION INFORMATION (U.S. CLS. 21, 23, 26, 36 AND 38).
FIRST USE 12-1-1999; IN COMMERCE 12-1-1999.

CLASS 42—SCIENTIFIC, COMPUTER AND LEGAL SERVICES

FOR ENGINEERING AND INFORMATION TECHNOLOGY CONSULTING SERVICES TO DOCUMENT THE PHYSICAL AS-BUILT CONDITION OF PROCESS PLANTS AND INDUSTRIAL FACILITIES, AND TO INTEGRATE INDUSTRIAL, MANUFACTURING, AND PROCESS PLANT VISUAL DATA WITH OPERATION, MAINTENANCE, ENGINEERING, AND CONSTRUCTION INFORMATION (U.S. CLS. 100 AND 101).
FIRST USE 12-1-1999; IN COMMERCE 12-1-1999.

SN 78-068,305. INOVX SOLUTIONS, IRVINE, CA. FILED 6-9-2001.

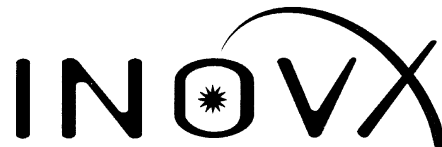
**CLASS 9—ELECTRICAL AND SCIENTIFIC APPARATUS**

FOR COMPUTER SOFTWARE TO ACCESS, REVIEW AND MANAGE INDUSTRIAL, MANUFACTURING, AND PROCESS PLANT VISUAL DATA, AND TO INTEGRATE INDUSTRIAL, MANUFACTURING, AND PROCESS PLANT VISUAL DATA WITH OPERATION, MAINTENANCE, ENGINEERING AND CONSTRUCTION INFORMATION (U.S. CLS. 21, 23, 26, 36 AND 38).
FIRST USE 12-1-1999; IN COMMERCE 12-1-1999.

CLASS 42—SCIENTIFIC, COMPUTER AND LEGAL SERVICES

FOR ENGINEERING AND INFORMATION TECHNOLOGY CONSULTING SERVICES TO DOCUMENT THE PHYSICAL AS-BUILT CONDITION OF PROCESS PLANTS AND INDUSTRIAL FACILITIES, AND TO INTEGRATE INDUSTRIAL, MANUFACTURING, AND PROCESS PLANT VISUAL DATA WITH OPERATION, MAINTENANCE, ENGINEERING, AND CONSTRUCTION INFORMATION (U.S. CLS. 100 AND 101).

FIRST USE 12-1-1999; IN COMMERCE 12-1-1999.

SN 78-072,578. BOOHER CONSULTANTS, INC., COLLEYVILLE, TX. FILED 7-6-2001.



BOOHER
CONSULTANTS, INC.

SN 78-069,730. MIDCAL PACKAGING TECHNOLOGIES, MODESTO, CA. FILED 6-18-2001.

NO CLAIM IS MADE TO THE EXCLUSIVE RIGHT TO USE "CONSULTANTS, INC.", APART FROM THE MARK AS SHOWN.
SEC. 2(F).

SUBER-RAIN**CLASS 20—FURNITURE AND ARTICLES NOT OTHERWISE CLASSIFIED**

FOR CORKS, CORKS FOR BOTTLES, CORKS FOR WINES AND SPARKLING WINES (U.S. CLS. 2, 13, 22, 25, 32 AND 50).

CLASS 40—MATERIAL TREATMENT

FOR MATERIAL TREATMENT IN THE NATURE OF APPLYING PROTECTIVE COATINGS TO CORKS, CORKS FOR BOTTLES, CORKS FOR WINES AND SPARKLING WINES (U.S. CLS. 100, 103 AND 106).

CLASS 35—ADVERTISING AND BUSINESS

FOR BUSINESS CONSULTING SERVICES IN THE FIELD OF BUSINESS WRITING, TECHNICAL WRITING, GRAMMAR, ORAL PRESENTATIONS, CUSTOMER SERVICE, INTERPERSONAL SKILLS, LISTENING, CONFLICT RESOLUTION, MEETINGS, GENDER COMMUNICATION DIFFERENCES, AND PERSONAL PRODUCTIVITY (U.S. CLS. 100, 101 AND 102).

FIRST USE 1-1-1990; IN COMMERCE 1-1-1990.

CLASS 41—EDUCATION AND ENTERTAINMENT

FOR EDUCATIONAL SERVICES, NAMELY, CONDUCTING TRAINING CLASSES, SEMINARS AND WORKSHOPS IN THE FIELD OF BUSINESS WRITING, TECHNICAL WRITING, GRAMMAR, ORAL PRESENTATIONS, CUSTOMER SERVICE, INTERPERSONAL SKILLS, LISTENING, CONFLICT RESOLUTION, MEETINGS, GENDER COMMUNICATION DIFFERENCES, AND PERSONAL PRODUCTIVITY (U.S. CLS. 100, 101 AND 107).

FIRST USE 1-1-1990; IN COMMERCE 1-1-1990.

SN 78-071,342. COW CREEK BAND OF UMPQUA TRIBE OF INDIANS, ROSEBURG, OR. FILED 6-27-2001.

7 FEATHERS TRUCK & TRAVEL CENTER

NO CLAIM IS MADE TO THE EXCLUSIVE RIGHT TO USE "TRUCK & TRAVEL CENTER", APART FROM THE MARK AS SHOWN.

CLASS 37—CONSTRUCTION AND REPAIR

FOR AUTOMOBILE SERVICE STATION SERVICES (U.S. CLS. 100, 103 AND 106).
FIRST USE 8-12-1998; IN COMMERCE 8-12-1998.

CLASS 42—SCIENTIFIC, COMPUTER AND LEGAL SERVICES

FOR TRUCK STOPS (U.S. CLS. 100 AND 101).
FIRST USE 8-12-1998; IN COMMERCE 8-12-1998.

SN 78-073,332. PEREGRINE FINANCIAL GROUP, INC., CHICAGO, IL. FILED 7-11-2001.

FOREXPLORER**CLASS 36—INSURANCE AND FINANCIAL**

FOR BROKERAGE AND DEALER SERVICES IN THE FIELD OF SECURITIES AND COMMODITIES INVESTING (U.S. CLS. 100, 101 AND 102).

FIRST USE 4-1-1999; IN COMMERCE 4-1-1999.

CLASS 42—SCIENTIFIC, COMPUTER AND LEGAL SERVICES

FOR COMPUTER SERVICES, NAMELY, PROVIDING ON-LINE FACILITIES FEATURING TRANSACTION ORDER ENTRY, ORDER ROUTING AND ORDER CONFIRMATION SERVICES TO CUSTOMERS IN THE FIELD OF SECURITIES AND COMMODITIES INVESTING (U.S. CLS. 100 AND 101).

FIRST USE 4-1-1999; IN COMMERCE 4-1-1999.

SN 78-074,043. ZOYTO, INC., HOUSTON, TX. FILED 7-16-2001.

THE FUTURE OF FULFILLMENT

CLASS 35—ADVERTISING AND BUSINESS

FOR ORDER FULFILLMENT SERVICES, BUSINESS CONSULTATION OF FULFILLMENT RELATED SERVICES, OPERATION OF TELEPHONE CALL CENTERS FOR OTHERS, PACKAGING ARTICLES TO THE ORDER AND SPECIFICATION OF OTHERS, PROCESSING MANUFACTURERS' REBATES AND COUPONS, AND TELEPHONE ORDER-TAKING SERVICES FOR OTHERS (U.S. CLS. 100, 101 AND 102).

FIRST USE 12-16-1998; IN COMMERCE 12-16-1998.

CLASS 40—MATERIAL TREATMENT

FOR ASSEMBLY OF PRODUCTS FOR OTHERS (U.S. CLS. 100, 103 AND 106).

FIRST USE 12-16-1998; IN COMMERCE 12-16-1998.

CLASS 42—SCIENTIFIC, COMPUTER AND LEGAL SERVICES

FOR COMPUTER SERVICES, NAMELY, DESIGNING AND IMPLEMENTING WEB SITES FOR OTHERS; COMPUTER SERVICES, NAMELY, MANAGING WEB SITES FOR OTHERS (U.S. CLS. 100 AND 101).

FIRST USE 12-16-1998; IN COMMERCE 12-16-1998.

SN 78-074,536. PELLA CORPORATION, PELLA, IA. FILED 7-18-2001.

INTEGRAL LIGHT TECHNOLOGY

CLASS 6—METAL GOODS

FOR METAL WINDOWS AND DOORS, NAMELY STRUCTURE THAT RECREATES THE CHARM AND HISTORICAL ACCURACY OF TRUE DIVIDED LIGHT YET ADDS A NEW DIMENSION OF ENERGY EFFICIENCY AND PERFORMANCE, SOLD AS A UNIT (U.S. CLS. 2, 12, 13, 14, 23, 25 AND 50).

FIRST USE 0-0-1990; IN COMMERCE 0-0-1990.

CLASS 19—NON-METALLIC BUILDING MATERIALS

FOR NON-METAL WINDOWS AND DOORS, NAMELY STRUCTURE THAT RECREATES THE CHARM AND HISTORICAL ACCURACY OF TRUE DIVIDED LIGHT YET ADDS A NEW DIMENSION OF ENERGY EFFICIENCY AND PERFORMANCE, SOLD AS A UNIT (U.S. CLS. 1, 12, 33 AND 50).

FIRST USE 0-0-1990; IN COMMERCE 0-0-1990.

SN 78-076,445. BOUSTEAD, JOHN, BISMARCK, ND. FILED 7-30-2001.

DAKOTA COWBOY

NO CLAIM IS MADE TO THE EXCLUSIVE RIGHT TO USE "DAKOTA", APART FROM THE MARK AS SHOWN.

CLASS 29—MEATS AND PROCESSED FOODS

FOR SOUPS, NAMELY, SOUP MIXES AND CANNED SOUPS; JERKY; HOT DOGS; HAMBURGER MEAT; DRIED FRUIT; POTATO CHIPS; BANANA CHIPS; FROZEN, SHELF-STABLE, REFRIGERATED AND PACKAGED PRE-COOKED MEALS AND FOODS, NAMELY MEALS CONSISTING PRIMARILY OF MEAT, FISH, POULTRY OR VEGETABLES; AND PROCESSED NUTS (U.S. CL. 46).

CLASS 30—STAPLE FOODS

FOR BAKING MIXES, NAMELY, BREAD AND CAKE MIXES; PANCAKE MIXES, SAUCES INCLUDING BARBECUE SAUCE, HOT SAUCE AND STEAK SAUCE; SAUCE MIXES; HAMBURGER SANDWICHES; HOT DOG SANDWICHES; BREAD ROLLS, NAMELY, HOT DOG BUNS AND HAMBURGER BUNS; BREAD, PROCESSED CEREALS, NAMELY, HOT, COLD AND DRY CEREALS; HONEY; PASTA; COFFEE; TEA; CRACKERS; KETCHUP; MUSTARD; MARINADES; CORN CHIPS; CEREAL-BASED FOOD BARS; AND CANDY BARS (U.S. CL. 46).

SN 78-081,022. DANAS, GONZALES & RODRIGUEZ, KATY, TX. FILED 8-24-2001.

STRESSED-OUT-SOLUTIONS

CLASS 39—TRANSPORTATION AND STORAGE

FOR DELIVERY OF GIFT BASKETS WITH SELECTED ITEMS REGARDING A PARTICULAR OCCASION OR THEME, NAMELY STRESS RELIEF (U.S. CLS. 100 AND 105).

CLASS 42—SCIENTIFIC, COMPUTER AND LEGAL SERVICES

FOR PREPARATION OF GIFT BASKETS WITH SELECTED ITEMS REGARDING A PARTICULAR OCCASION OR THEME, NAMELY STRESS RELIEF (U.S. CLS. 100 AND 101).

SN 78-084,231. ORIGINAL SINE RECORDS, GOLDEN, CO. FILED 9-17-2001.

VIOLET EDGE

CLASS 9—ELECTRICAL AND SCIENTIFIC APPARATUS

FOR PRE-RECORDED AUDIO TAPES AND COMPACT DISCS FEATURING MUSIC (U.S. CLS. 21, 23, 26, 36 AND 38).

CLASS 25—CLOTHING

FOR T-SHIRTS, SWEAT SHIRTS, JACKETS AND CAPS (U.S. CLS. 22 AND 39).

CLASS 41—EDUCATION AND ENTERTAINMENT

FOR ENTERTAINMENT SERVICES, NAMELY, LIVE PERFORMANCES BY A VOCAL AND INSTRUMENTAL GROUP (U.S. CLS. 100, 101 AND 107).

SN 78-086,660. TRAKUS, INC., MEDFORD, MA. FILED 10-3-2001.

TRAKUS

CLASS 9—ELECTRICAL AND SCIENTIFIC APPARATUS

FOR COMPUTER HARDWARE AND SOFTWARE USED TO ACQUIRE, PROCESS, DISTRIBUTE, STORE, AND DISPLAY DATA RELATING TO SPORTING EVENTS (U.S. CLS. 21, 23, 26, 36 AND 38).

FIRST USE 11-24-1998; IN COMMERCE 11-24-1998.

CLASS 38—COMMUNICATION

FOR BROADCASTING SPORTING EVENT DATA VIA A GLOBAL COMPUTER NETWORK, TELEVISION, INTERACTIVE TELEVISION, IN VENUE ELECTRONIC DISPLAYS, AND WIRELESS COMPUTER NETWORKS (U.S. CLS. 100, 101 AND 104).

FIRST USE 11-24-1998; IN COMMERCE 11-24-1998.

CLASS 41—EDUCATION AND ENTERTAINMENT

FOR COMPUTER DATABASES AND VIDEO GAMES FEATURING GRAPHICS, ANIMATIONS, REPORTS, ANALYSES, VIDEO, AUDIO, AND DATA RELATING TO SPORTING EVENTS (U.S. CLS. 100, 101 AND 107).

FIRST USE 11-24-1998; IN COMMERCE 11-24-1998.

SN 78-087,887. FISERV, INC., BROOKFIELD, WI. FILED 10-11-2001.

DX FICHE

NO CLAIM IS MADE TO THE EXCLUSIVE RIGHT TO USE "DX", APART FROM THE MARK AS SHOWN.

CLASS 9—ELECTRICAL AND SCIENTIFIC APPARATUS

FOR CD-ROMS CONTAINING CLIENT DATA TO ASSIST BUSINESSES WITH DOCUMENT AND HIGH VOLUME COMPUTER OUTPUT STORAGE AND RETRIEVAL (U.S. CLS. 21, 23, 26, 36 AND 38).

CLASS 35—ADVERTISING AND BUSINESS

FOR DATA PROCESSING SERVICES, NAMELY PROCESSING AND ARCHIVING, ON CD-ROM MEDIA, DATASTREAMS RECEIVED FROM CUSTOMERS TO AUTOMATE HIGH VOLUME DOCUMENT ARCHIVING AND RETRIEVAL (U.S. CLS. 100, 101 AND 102).

SN 78-090,883. FEDERAL EXPRESS CORPORATION, MEMPHIS, TN. FILED 10-30-2001.

FEDEX FIELDHOUSE

NO CLAIM IS MADE TO THE EXCLUSIVE RIGHT TO USE "FIELDHOUSE" APART FROM THE MARK AS SHOWN FOR THE SERVICES IN INTERNATIONAL CLASSES 35 AND 41.

CLASS 21—HOUSEWARES AND GLASS

FOR FOOD AND BEVERAGE CONTAINERS (U.S. CLS. 2, 13, 23, 29, 30, 33, 40 AND 50).

CLASS 25—CLOTHING

FOR CLOTHING, NAMELY, SHIRTS, SHORTS, PANTS, JACKETS, HATS, SOCKS, SHOES, BELTS, UNDERWEAR, RAINWEAR AND LOUNGEWEAR (U.S. CLS. 22 AND 39).

CLASS 35—ADVERTISING AND BUSINESS

FOR PROMOTING SPORTS, RECREATIONAL, CULTURAL AND ENTERTAINMENT EVENTS OF OTHERS (U.S. CLS. 100, 101 AND 102).

CLASS 41—EDUCATION AND ENTERTAINMENT

FOR PROVIDING FACILITIES FOR SPORTS, RECREATIONAL, CULTURAL AND ENTERTAINMENT SERVICES (U.S. CLS. 100, 101 AND 107).

SN 78-090,957. GENERAL COSMETICS CORPORATION, NEW YORK, NY. FILED 10-31-2001.

SILENT SHORES

CLASS 3—COSMETICS AND CLEANING PREPARATIONS

FOR FOOT LOTION, HAND LOTION, BODY LOTION, BODY MIST, LIQUID SOAP, FOAMING SOAP, SHOWER GEL, BAR SOAP, HAIR SHAMPOOS, CONDITIONERS, INCENSE, POTPOURRI (U.S. CLS. 1, 4, 6, 50, 51 AND 52).

CLASS 4—LUBRICANTS AND FUELS

FOR CANDLES (U.S. CLS. 1, 6 AND 15).

SN 78-091,867. MADONION.COM INC, ESPOO, FINLAND, FILED 11-6-2001.

PCMARK

CLASS 9—ELECTRICAL AND SCIENTIFIC APPARATUS

FOR COMPUTER SOFTWARE FOR COMPUTER PERFORMANCE MEASUREMENT; COMPUTER SOFTWARE TO ASSIST CONSUMERS IN SELECTING COMPUTER HARDWARE FOR PURCHASE VIA THE GLOBAL COMPUTER NETWORK (U.S. CLS. 21, 23, 26, 36 AND 38).

CLASS 25—CLOTHING

FOR CLOTHING, NAMELY - T-SHIRTS, HATS, SWEATSHIRTS, SOCKS AND JACKETS (U.S. CLS. 22 AND 39).

SN 78-093,796. GENERAL COSMETICS CORPORATION,
NEW YORK, NY. FILED 11-16-2001.

LOST LAGOON

CLASS 3—COSMETICS AND CLEANING PREPARATIONS

FOR FOOT LOTION, HAND LOTION, BODY LOTION, BODY MIST, LIQUID SOAP, FOAMING SOAP, SHOWER GEL, BAR SOAP, HAIR SHAMPOOS, CONDITIONERS, INCENSE, POTPOURRI (U.S. CLS. 1, 4, 6, 50, 51 AND 52).

CLASS 4—LUBRICANTS AND FUELS

FOR CANDLES (U.S. CLS. 1, 6 AND 15).

SN 78-096,517. TOO, INC., COLUMBUS, OH. FILED 12-4-2001.

TOO

CLASS 3—COSMETICS AND CLEANING PREPARATIONS

FOR PERSONAL CARE PRODUCTS, NAMELY, AFTERSHAVE, ANTIPERSPIRANT, ARTIFICIAL NAILS, ASTRINGENT FOR THE FACE, ASTRINGENT FOR THE SKIN, BATH OIL, BATH BEADS, BATH SALTS, BLUSH, BODY GLITTER, BODY OIL, BODY SCRUB, BUBBLE BATH, COLOGNE, CREAM FOR THE BODY, CREAM FOR THE CUTICLES, CREAM FOR THE EYES, CREAM FOR THE FACE, CREAM FOR THE HANDS, DEODORANT, ESSENTIAL OILS, EXFOLIATORS FOR THE SKIN, EYE GELS, EYE MAKEUP PENCILS, EYE SHADOW, FACE HIGHLIGHTER, FACIAL MASKS, FACE MIST, FACE SCRUB, FOOT SOAK, FOUNDATION, FRAGRANT BODY SPLASH, FRAGRANT BODY MIST, HAIR CONDITIONER, HAIR DYES, HAIR GLITTER, HAIR HIGHLIGHTER, HAIR MASCARA, HAIR POMADE, HAIR RINSES, HAIR REMOVING CREAMS, HAIR SHAMPOO, HAIR SPRAY, HAIR STRAIGHTENER, HAIR STYLING GEL, HAIR STYLING MOUSSE, LOTION FOR THE BODY, LOTION FOR THE HANDS, LOTION FOR THE FACE, LIP BALM, LIP GLOSS, LIP LINER, LIP MAKEUP PENCILS, LIPSTICK, MAKEUP FOR THE BODY, MAKEUP FOR THE FACE, MAKEUP REMOVER, MASCARA, NAIL CORRECTOR PENS, NAIL POLISH, NAIL POLISH REMOVER, NAIL STENCILS, NON-MEDICATED BLEMISH STICK, NON-MEDICATED CLEANSER FOR THE FACE, NON-MEDICATED FOOT SPRAY, NON-MEDICATED MOOD ENHANCING MASSAGE OINTMENT, NON-MEDICATED MOOD ENHANCING SKIN CREAM, OIL BLOTTING SHEETS FOR THE SKIN, PERFUME, POWDER FOR THE BODY, POWDER FOR THE FACE, POWDER FOR THE FEET, PUMICE STONES FOR PERSONAL USE, SALT SCRUBS FOR THE SKIN, SHAVING CREAM, SHOWER GEL, SKIN BRONZING CREAM, SOAP FOR THE BODY, SOAP FOR THE FACE, SOAP FOR THE HANDS, SUN BLOCK FOR THE BODY, SUN BLOCK FOR THE FACE, SUNTAN LOTION FOR THE BODY, SUNTAN LOTION FOR THE FACE, SUNLESS TANNING LOTION FOR

THE BODY, SUNLESS TANNING LOTION FOR THE FACE, PRE-SUNTANNING LOTION FOR THE BODY, PRE-SUNTANNING LOTION FOR THE FACE, POST-SUNTANNING LOTION FOR THE BODY, POST-SUNTANNING LOTION FOR THE FACE AND TALCUM POWDER (U.S. CLS. 1, 4, 6, 50, 51 AND 52).

CLASS 25—CLOTHING

FOR CLOTHING, NAMELY, BATHROBES, BEACH COVER-UPS, BEACHWEAR, BELTS, BLAZERS, BLOUSES, BODY SHAPERS, BODY SUITS, BOXER SHORTS, BRAS, BUSTIERS, CAMISOLES, CAPS, COATS, DRESSES, FOOTWEAR, FOUNDATION GARMENTS, GARTER BELTS, GIRDLES, GLOVES, GOWNS, HALTER TOPS, HATS, HEADBANDS, HOSIERY, JACKETS, JEANS, JOGGING SUITS, KNEE HIGHS, KNIT SHIRTS, KNIT TOPS, LEOTARDS, LINGERIE, LOUNGEWEAR, MITTENS, NEGLIGEEES, NIGHT GOWNS, NIGHT SHIRTS, PAJAMAS, PANTIES, PANTS, PANTYHOSE, SARONGS, SCARVES, SHIRTS, SHORTS, SKIRTS, SLACKS, SLEEPWEAR, SLIPS, STOCKINGS, SUITS, SWEAT PANTS, SWEAT SHIRTS, SWEAT SHORTS, SWEAT SUITS, SWEATERS, SWIM WEAR, T-SHIRTS, TANK TOPS, TAP PANTS, TEDDIES, TIES, TIGHTS, UNDERPANTS, UNDERSHIRTS, UNDERWEAR AND VESTS (U.S. CLS. 22 AND 39).

CLASS 35—ADVERTISING AND BUSINESS

FOR RETAIL STORE SERVICES, ON-LINE CATALOG SERVICES AND MAIL ORDER CATALOG SERVICES FEATURING PERSONAL CARE PRODUCTS, HOME FRAGRANCE PRODUCTS, JEWELRY, WATCHES, PACKS, BAGS, WALLETS AND CLOTHING (U.S. CLS. 100, 101 AND 102).

SN 78-096,811. AMERICAN PROMOTIONAL EVENTS, INC., FLORENCE, AL. FILED 12-5-2001.

THE AMERICAN SPIRIT

CLASS 13—FIREARMS

FOR FIREWORKS (U.S. CLS. 2 AND 9).

CLASS 35—ADVERTISING AND BUSINESS

FOR RETAIL STORE SERVICES FEATURING FIREWORKS (U.S. CLS. 100, 101 AND 102).

* * * * *

SECTION 2.— INTERNATIONAL CLASSIFICATION

The short titles associated below with the international class numbers are terms designed merely for quick identification and are not an official part of the international classification. The full names of international classes are given in section 6.1 of the trademark rules of practice.

The designation "U.S. Cl." appearing in this section refers to the U.S. class in effect prior to Sep. 1, 1973 rather than the international class which applies to applications filed on or after that date. For adoption of international classification see notice in the OFFICIAL GAZETTE of Jun. 26, 1973 (911 O.G. TM 210).

Application in one class

CLASS 1—CHEMICALS

SN 75-494,963. BIOQUEST, LLC, RENO, NV. BY ASSIGNMENT BIOQUEST, RENO, NV. FILED 6-2-1998.

ONE SHOT

FOR WATER TREATMENT CHEMICALS FOR SPAS AND HOT-TUBS, NAMELY, BROMINE CHEMICALS FOR USE AS WATER SANITIZERS, WATER CONDITIONING PREPARATIONS, PH BALANCE PREPARATIONS, TOTAL ALKALINITY BALANCE PREPARATIONS, PH LOCKING PREPARATIONS, WATER MINERAL INHIBITING CHEMICALS, SCALE INHIBITING PREPARATIONS, SODIUM DICHLOR CHEMICALS FOR USE AS WATER SANITIZERS AND WATER TEST KITS FOR EVALUATING AND MONITORING THE CHEMISTRY OF WATER COMPRISED OF WATER TEST STRIPS (U.S. CLS. 1, 5, 6, 10, 26 AND 46).
FIRST USE 5-1-1996; IN COMMERCE 5-1-1996.

SN 75-679,021. DAVEY TREE EXPERT COMPANY, THE, KENT, OH. FILED 4-12-1999.

PALM ARBOR GREEN

OWNER OF U.S. REG. NO. 766,975.
NO CLAIM IS MADE TO THE EXCLUSIVE RIGHT TO USE "PALM", APART FROM THE MARK AS SHOWN.
FOR TREE FOOD FOR PALM TREES (U.S. CLS. 1, 5, 6, 10, 26 AND 46).
FIRST USE 8-0-1999; IN COMMERCE 8-0-1999.

SN 75-929,666. MANTEL, MIKE, DBA MANHATTAN CHEMICAL, REDONDO BEACH, CA. FILED 2-22-2000.

BURN OUT BLUEBERRY

NO CLAIM IS MADE TO THE EXCLUSIVE RIGHT TO USE "BLUEBERRY", APART FROM THE MARK AS SHOWN.
FOR CHEMICAL ADDITIVE TO FRAGRANCE MOTOR FUEL (U.S. CLS. 1, 5, 6, 10, 26 AND 46).

CLASS 1—(Continued).

SN 75-980,157. MILTENYI BIOTEC GMBH, 51429 BERGISCH GLADBACH, FED REP GERMANY, FILED 12-3-1998.

MACS

FOR SCIENTIFIC REAGENTS FOR CONDUCTING MAGNETIC CELL SORTING IN BIOTECHNOLOGY LABORATORIES (U.S. CLS. 1, 5, 6, 10, 26 AND 46).
FIRST USE 5-0-1988; IN COMMERCE 9-9-1988.

SN 76-054,648. S.A. REVERTE PRODUCTOS MINERALES, 43720 CASTELLET I LA GORNAL (TARRAGONA), SPAIN, FILED 5-22-2000.

CALCIPORE

PRIORITY CLAIMED UNDER SEC. 44(D) ON SPAIN APPLICATION NO. 2.293.106, FILED 2-22-2000, REG. NO. 2293106, DATED 2-22-2000, EXPIRES 2-22-2010.
FOR CHEMICALS, NAMELY, CALCIUM CARBONATE FOR USE IN THE MANUFACTURE OF BREATHABLE FILMS (U.S. CLS. 1, 5, 6, 10, 26 AND 46).

SN 76-085,595. AUMALE SYNERGIES, 75001 PARIS, FRANCE, FILED 7-7-2000.

STARMAG

FOR FERTILIZER CONTAINING MAGNESIUM FOR AGRICULTURAL USE AND FOR USE IN THE FERTILIZER INDUSTRY AND AGRICULTURAL LIME CONTAINING MAGNESIUM FOR AGRICULTURAL USE (U.S. CLS. 1, 5, 6, 10, 26 AND 46).

CLASS 1—(Continued).

SN 76-089,327. KAO KABUSHIKI KAISHA, TA KAO CORPORATION, TOKYO, JAPAN, FILED 7-14-2000.

MAGNOL

FOR FRAGRANCES FOR USE IN MANUFACTURE OF PERFUME, EAU DE COLOGNE AND COSMETICS, TOILET SOAPS, BODY SHAMPOO, HAIR CARE PRODUCTS, LAUNDRY DETERGENTS, FABRIC SOFTENERS, DISHWASHING DETERGENTS, ALL-PURPOSE CLEANERS, AIR FRESHENERS, DEODORIZERS, AND FOOD FLAVORING (U.S. CLS. 1, 5, 6, 10, 26 AND 46).
FIRST USE 10-0-1985; IN COMMERCE 0-0-1995.

SN 76-109,386. ACCUSTANDARD, INC., NEW HAVEN, CT. FILED 8-16-2000.

ACES

FOR CHEMICAL ANALYTIC STANDARDS FOR USE IN SCIENTIFIC OR RESEARCH LABORATORIES (U.S. CLS. 1, 5, 6, 10, 26 AND 46).
FIRST USE 8-14-1997; IN COMMERCE 8-14-1997.

SN 76-114,468. MG INDUSTRIES, MALVERN, PA. FILED 8-16-2000.

AUTOGAS

FOR GASES USED FOR CALIBRATION OF EMISSIONS TESTING EQUIPMENT FOR AUTOMOBILES (U.S. CLS. 1, 5, 6, 10, 26 AND 46).

SN 76-118,058. NORAC TECHNOLOGIES INC., EDMONTON, ALBERTA, T6N 1H9, CANADA, FILED 8-28-2000.

LABEX

FOR ANTI-OXIDANTS USED TO INCREASE SHELF LIFE, STABILIZE COLOUR AND AROMA OF PRODUCTS AND INGREDIENTS FOR THE FOOD, PHARMACEUTICAL, BIOTECH AND COSMETIC INDUSTRIES, FOR INDUSTRIAL AND COMMERCIAL USE (U.S. CLS. 1, 5, 6, 10, 26 AND 46).

SN 76-118,152. STRATAGENE, LA JOLLA, CA. FILED 8-25-2000.

BRILLIANT

FOR KITS FOR AMPLIFYING AND DETECTING DNA TARGETS, COMPRISED PRIMARILY OF LABORATORY REAGENTS, FOR USE IN LIFE SCIENCES RESEARCH; AND SCIENTIFIC LABORATORY REAGENTS (U.S. CLS. 1, 5, 6, 10, 26 AND 46).
FIRST USE 9-0-2000; IN COMMERCE 9-0-2000.

CLASS 1—(Continued).

SN 76-127,832. VDF FUTURECEUTICALS, MOMENCE, IL. FILED 9-12-2000.

COLLAGAIN

FOR CHEMICAL PREPARATIONS, NAMELY, POTASSIUM, ASCORBATE, AND BORATE FOR USE IN THE COSMETIC AND MEDICAL INDUSTRIES (U.S. CLS. 1, 5, 6, 10, 26 AND 46).
FIRST USE 8-22-2000; IN COMMERCE 8-22-2000.

SN 76-138,643. SHRADER CANADA LIMITED, OAKVILLE, ONTARIO, CANADA, FILED 10-2-2000.

**TUNE-UP
IN A CAN**

**Feel It
In The
Seat
Of Your
pants!**

**Essayez-le!
Vous
L'aimerez!**

OWNER OF CANADA REG. NO. TMA531,281, DATED 8-16-2000, EXPIRES 8-16-2010.

THE FRENCH WORDING "ESSAYEZ-LE! VOUS L'AIMEREZ!" TRANSLATES IN ENGLISH TO "TRY IT, YOU'LL LIKE IT".

FOR ENVIRONMENT FRIENDLY AFTER MARKET AUTOMOTIVE CAR CARE PRODUCTS, NAMELY A PROPRIETARY CHEMICAL MIX WHICH ACTS AS A FUEL ECONOMIZING AGENT, REDUCER OF HARMFUL EMISSIONS, AND IMPROVER OF ENGINE PERFORMANCE BY INCREASING THE MILEAGE AND REDUCING HYDROCARBON EMISSIONS (U.S. CLS. 1, 5, 6, 10, 26 AND 46).

SN 76-139,876. OMS INVESTMENTS, INC., WILMINGTON, DE. FILED 10-2-2000.

**THE MIRACLE IS IN THE
MIX!**

FOR POTTING MIX; POTTING MIX CONTAINING FERTILIZERS AND OTHER SOIL AMENDMENTS FOR DOMESTIC USE (U.S. CLS. 1, 5, 6, 10, 26 AND 46).

CLASS 1—(Continued).

SN 76-147,178. DEGUSSA-HULS AKTIENGESELLSCHAFT, FRANKFURT, FED REP GERMANY, FILED 10-10-2000.

NOBLYST

OWNER OF FED REP GERMANY REG. NO. 30015308.2, DATED 1-2-2000, EXPIRES 1-31-2010.
FOR CHEMICAL PRODUCTS, NAMELY, CATALYSTS AND CATALYST SUPPORTS FOR USE IN THE PRODUCTION OF INDUSTRIAL CHEMICALS (U.S. CLS. 1, 5, 6, 10, 26 AND 46).

SN 76-157,421. KANEKA CORPORATION, KITA-KU, OSAKA, JAPAN, FILED 11-1-2000.

ENPLEX

FOR HEAT-RESISTANT SYNTHETIC RESINS USED IN THE MANUFACTURE OF MOLDED PRODUCTS (U.S. CLS. 1, 5, 6, 10, 26 AND 46).

SN 76-170,495. ALCOA WORLD ALUMINA LLC, PITTSBURGH, PA. FILED 11-27-2000.

HY BRITE

OWNER OF U.S. REG. NO. 759,868.
FOR ALUMINA HYDRATE SLURRIES FOR USE IN MANUFACTURING PAPER (U.S. CLS. 1, 5, 6, 10, 26 AND 46).
FIRST USE 11-16-2000; IN COMMERCE 11-16-2000.

SN 76-170,584. AGCONCEPTS, L.L.C., OVERLAND PARK, KS. FILED 11-24-2000.

SUN SET +

FOR CHEMICALS, NAMELY, A BLEND OF SPRAY OIL AND NONIONIC SURFACTANTS WHICH HELPS TO IMPROVE APPLICATION PERFORMANCE; USED IN CONNECTION WITH AGRICULTURAL, INDUSTRIAL, FORESTRY, TURF AND ORNAMENTAL AND RIGHTS-OF-WAY INDUSTRIES (U.S. CLS. 1, 5, 6, 10, 26 AND 46).

CLASS 1—(Continued).

SN 76-174,868. GABRIEL, TYRONNE, CANOGA PARK, CA. FILED 11-30-2000.



NO CLAIM IS MADE TO THE EXCLUSIVE RIGHT TO USE "CARBON" AND "ACTIVATED CARBON", APART FROM THE MARK AS SHOWN.

EAGLE'S HEAD ON BLUE CREST WITH WORDS ACTIVATED CARBON INSIDE AND THE WORDS AMERICAN CARBON.

FOR ACTIVATED CARBON USED IN REMOVING ORGANIC COMPOUNDS AND CHLORINE FROM DRINKING WATER AND WASTE-WATER AND USED FOR AIR PURIFICATION (U.S. CLS. 1, 5, 6, 10, 26 AND 46).

FIRST USE 5-20-1966; IN COMMERCE 5-20-1966.

SN 76-197,802. NORTH AMERICAN SALT COMPANY, JOHNSON, KS. BY CHANGE OF NAME IMC SALT, INC., OVERLAND PARK, KS. FILED 1-23-2001.

ASPEN

FOR DE-ICING AND ICE PREVENTION PREPARATION FOR ROADWAYS AND SIDEWALKS AND OTHER PAVED SURFACES (U.S. CLS. 1, 5, 6, 10, 26 AND 46).
FIRST USE 10-0-2000; IN COMMERCE 10-0-2000.

SN 76-203,042. SOLUTIA INC., ST. LOUIS, MO. FILED 1-31-2001.

PC-1844

FOR CHEMICAL FOAM SUPPRESSANTS FOR USE WITH OILS, LUBRICANTS, TRANSMISSION FLUIDS, REACTOR COOLANT FLUIDS, HYDRAULIC FLUIDS, AND HEAT EXCHANGE FLUIDS (U.S. CLS. 1, 5, 6, 10, 26 AND 46).

FIRST USE 5-0-1999; IN COMMERCE 5-0-1999.

CLASS 1—(Continued).

SN 76-217,889. ROCHE VITAMINS INC., PARSIPPANY, NJ. FILED 3-1-2001.

HEALTH BENEFICIALS

NO CLAIM IS MADE TO THE EXCLUSIVE RIGHT TO USE "HEALTH", APART FROM THE MARK AS SHOWN. FOR BOTANICAL EXTRACTS AND CHEMICAL INGREDIENTS FOR USE IN THE MANUFACTURE OF DIETARY SUPPLEMENTS, FOODS, COSMETICS, AND PET FOODS (U.S. CLS. 1, 5, 6, 10, 26 AND 46).

SN 76-218,239. B.F.GOODRICH COMPANY, THE, CHARLOTTE, NC. FILED 3-2-2001.



OWNER OF U.S. REG. NOS. 64,996, 1,423,775 AND OTHERS. FOR CHEMICAL PREPARATIONS FOR INDUSTRIAL USE, NAMELY - URETHANE MATERIALS FOR USE IN THE MANUFACTURE OF COATINGS AND ELASTOMERS; ADHESIVES AND COATINGS FOR USE ON MARINE PRODUCTS; CHEMICAL PREPARATIONS FOR USE ON DE-ICERS FOR AEROSPACE VEHICLES; AND COMPOSITE MATERIALS, POLYIMIDE-BASED COMPOSITES, AND INORGANIC POLYMER MATERIALS FOR HIGH-TEMPERATURE APPLICATIONS, INCLUDING INSULATIVE AND FIREPROOFING APPLICATIONS (U.S. CLS. 1, 5, 6, 10, 26 AND 46).

SN 76-252,872. LONZA INC., FAIR LAWN, NJ. FILED 5-7-2001.

CATAGARD

FOR CHEMICAL ENZYME INHIBITOR FOR USE IN THE PULP AND PAPER AND TEXTILE INDUSTRIES (U.S. CLS. 1, 5, 6, 10, 26 AND 46). FIRST USE 6-14-2001; IN COMMERCE 6-14-2001.

SN 76-260,063. JENSEN, STEVEN KENNETH, ANTIOCH, CA. FILED 5-22-2001.

SHOOT THE BREEZE

FOR CHEMICAL SPRAY USED TO DETERMINE APPROXIMATE WIND SPEED AND DIRECTION (U.S. CLS. 1, 5, 6, 10, 26 AND 46).

CLASS 1—(Continued).

SN 76-302,374. OMS INVESTMENTS, INC., WILMINGTON, DE. FILED 8-21-2001.

INSTANT ACTION

FOR PLANT FOOD (U.S. CLS. 1, 5, 6, 10, 26 AND 46).

SN 76-318,421. GENERAL HYDROPONICS, INC., SEBASTOPOL, CA. FILED 9-28-2001.

GENX

FOR PLANT NUTRIENTS FOR AGRICULTURAL AND DOMESTIC USE (U.S. CLS. 1, 5, 6, 10, 26 AND 46).

SN 76-322,272. GERVASI, RICHARD A., PHOENIXVILLE, PA. FILED 10-5-2001.

SAFESHOW

FOR PERSONAL SAFETY KITS FOR ATTACHMENT TO LOCK BOXES AND FOR USE BY REAL ESTATE AGENTS, CONSISTING PRIMARILY OF PEPPER SPRAY AND A FLASHLIGHT (U.S. CLS. 1, 5, 6, 10, 26 AND 46).

SN 76-333,169. WATER REMEDIATION TECHNOLOGY, LLC, ARVADA, CO. FILED 11-1-2001.

WRT

FOR ZEOLITE-BASED MATERIALS FOR USE IN REMOVAL OF CHEMICAL COMPOUNDS AND TRACE ELEMENTS FROM AQUEOUS SOLUTIONS AND MEDIA (U.S. CLS. 1, 5, 6, 10, 26 AND 46).

SN 76-340,043. FUJI CHEMICAL INDUSTRIES (U.S.A.) INC., ROBBINSVILLE, NJ. FILED 11-21-2001.

BERRYMAX

FOR RASPBERRY SEED OIL AND RASPBERRY SEED OIL POWDER SOLD IN BULK FOR USE IN THE MANUFACTURE OF PERSONAL CARE PRODUCTS, FOOD, PHARMACEUTICALS AND NUTRACEUTICAL PRODUCTS (U.S. CLS. 1, 5, 6, 10, 26 AND 46).

CLASS 1—(Continued).

SN 76-350,295. TEC SPECIALTY PRODUCTS, INC., SAINT PAUL, MN. FILED 12-19-2001.

GROUTRITE

FOR WATER-BASED SILICONE SOLUTION APPLIED PRIOR TO GROUTING TO PREVENT STAINING BY GROUT AND IMPROVE EASE OF GROUT HAZE CLEANUP (U.S. CLS. 1, 5, 6, 10, 26 AND 46).

CLASS 1—(Continued).

SN 78-069,879. DESERT WHALE JOJOBA COMPANY, INC., TUCSON, AZ. FILED 6-19-2001.

JOJOBA PRO - AA

NO CLAIM IS MADE TO THE EXCLUSIVE RIGHT TO USE "JOJOBA", APART FROM THE MARK AS SHOWN.

FOR AQUEOUS SOLUTION OF AMINO ACIDS DERIVED FROM THE SEEDS OF THE JOJOBA PLANT (SIMMONDSIA CHINENSIS) USED AS AN INGREDIENT IN COSMETIC AND PERSONAL CARE PRODUCTS (U.S. CLS. 1, 5, 6, 10, 26 AND 46).

FIRST USE 4-24-2001; IN COMMERCE 4-24-2001.

SN 78-036,727. RDI CONSTRUCTION, INC., SOUTH POINT, OH. FILED 11-28-2000.

SN 78-072,924. BIOSUN SYSTEMS CORPORATION, MAPLE GROVE, MN. FILED 7-9-2001.

ENVIROPRODUCTION

FOR COMPOSITIONS OF BACTERIA, ENZYMES AND BLENDS THEREOF FOR CONTROLLING ODORS AND REDUCING SOLIDS FOR USE IN THE AGRICULTURAL AND WASTE TREATMENT INDUSTRIES (U.S. CLS. 1, 5, 6, 10, 26 AND 46).

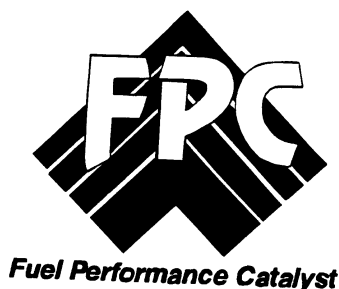

NO CLAIM IS MADE TO THE EXCLUSIVE RIGHT TO USE "FUEL PERFORMANCE CATALYST", APART FROM THE MARK AS SHOWN.

FOR CATALYSTS AND ADDITIVES FOR MOTOR VEHICLE FUELS FOR IMPROVING FUEL FOR PERFORMANCE, REDUCING HARMFUL EMISSIONS AND EXTENDING ENGINE LIFE (U.S. CLS. 1, 5, 6, 10, 26 AND 46).

FIRST USE 8-1-1984; IN COMMERCE 8-1-1984.

SN 78-096,572. S. D. WARREN SERVICES COMPANY, BOSTON, MA. FILED 12-4-2001.

SOMERSET SYNERGY

OWNER OF U.S. REG. NOS. 566,041, 1,689,020 AND OTHERS.

FOR BLEACHED PULP PRODUCED FROM WOOD AND/OR FIBROUS PLANT MATERIAL FOR USE IN MANUFACTURE (U.S. CLS. 1, 5, 6, 10, 26 AND 46).

FIRST USE 1-29-2001; IN COMMERCE 2-1-2001.

SN 78-069,871. DESERT WHALE JOJOBA COMPANY, INC., TUCSON, AZ. FILED 6-19-2001.

JOJOBA PRO - HP

NO CLAIM IS MADE TO THE EXCLUSIVE RIGHT TO USE "JOJOBA", APART FROM THE MARK AS SHOWN.

FOR AQUEOUS SOLUTION OF HYDROLYZED PROTEINS DERIVED FROM THE SEEDS OF THE JOJOBA PLANT (SIMMONDSIA CHINENSIS) USED AS AN INGREDIENT IN COSMETIC AND PERSONAL CARE PRODUCTS (U.S. CLS. 1, 5, 6, 10, 26 AND 46).

FIRST USE 4-24-2001; IN COMMERCE 4-24-2001.

CLASS 2—PAINTS

SN 76-035,117. JAMES HARDIE RESEARCH PTY LIMITED, ROSEHILL, NEW SOUTH WALES 2142, AUSTRALIA, FILED 4-26-2000.

HARDISTAIN

OWNER OF U.S. REG. NOS. 1,443,202, 1,664,138 AND OTHERS.

FOR PAINTS, STAINS AND PROTECTIVE AND DECORATIVE COATINGS FOR PROPRIETARY FIBER-CEMENT BUILDING PRODUCTS (U.S. CLS. 6, 11 AND 16).

CLASS 2—(Continued).

SN 76-054,631. ZEON CORPORATION, TOKYO, JAPAN, BY CHANGE OF NAME NIPPON ZEON CO., LTD., TOKYO, JAPAN, FILED 5-19-2000.

ZEON

FOR TONERS FOR ELECTROPHOTOGRAPHY (U.S. CLS. 6, 11 AND 16).

SN 76-059,066. EASTHILL GROUP, INC., MALVERN, PA. FILED 5-26-2000.

TiCoat⁴⁷

FOR PROTECTIVE PAINT-TYPE COATINGS FOR USE ON PAINTED AND METAL SURFACES, NAMELY, AUTOMOBILE PARTS AND AUTOMOBILE BODY PARTS (U.S. CLS. 6, 11 AND 16).

SN 76-116,791. HILLYARD ENTERPRISES, INC., ST. JOSEPH, MO. FILED 8-24-2000.

UPHOLD

OWNER OF U.S. REG. NO. 1,139,364.
FOR COATING IN THE NATURE OF A WOOD FLOOR FINISH (U.S. CLS. 6, 11 AND 16).
FIRST USE 2-27-1979; IN COMMERCE 2-27-1979.

SN 76-160,233. RML PRODUCTS INC., LAS VEGAS, NV. FILED 11-6-2000.

SLIP NO MORE

NO CLAIM IS MADE TO THE EXCLUSIVE RIGHT TO USE "SLIP", APART FROM THE MARK AS SHOWN.

FOR MOP ON AND SPRAY ON LIQUID APPLICATION IN THE NATURE OF A COATING TO PREVENT SLIPS AND FALLS ON BATHTUBS, SHOWERS AND INDOOR AND OUTDOOR FLOORING (U.S. CLS. 6, 11 AND 16).

CLASS 2—(Continued).

SN 76-168,750. CALIFORNIA PACIFIC RESEARCH INC., RENO, NV. FILED 11-20-2000.

RUST BULLET

NO CLAIM IS MADE TO THE EXCLUSIVE RIGHT TO USE "RUST", APART FROM THE MARK AS SHOWN.
FOR CORROSION INHIBITING PAINT TYPE COATING FOR USE IN THE STRUCTURAL AND FABRICATION METALS INDUSTRY (U.S. CLS. 6, 11 AND 16).
FIRST USE 11-1-2000; IN COMMERCE 11-6-2000.

SN 76-201,823. DUNN-EDWARDS CORPORATION, LOS ANGELES, CA. FILED 1-29-2001.



FOR PAINT FOR USE ON METAL (U.S. CLS. 6, 11 AND 16).

SN 76-330,120. TNEPEC COMPANY INC., KANSAS CITY, MO. FILED 10-29-2001.

PERIMEPRIME

FOR PROTECTIVE COATINGS, NAMELY A PAINT-TYPE URETHANE PRIMER FOR APPLICATION TO METAL SURFACES (U.S. CLS. 6, 11 AND 16).

CLASS 3—COSMETICS AND CLEANING PREPARATIONS

SN 75-554,952. JTM PRODUCTS, INC., CLEVELAND, OH. FILED 9-17-1998.

AMBER SOAP

NO CLAIM IS MADE TO THE EXCLUSIVE RIGHT TO USE "SOAP", APART FROM THE MARK AS SHOWN.

FOR VEGETABLE-OIL-BASED, MULTI-PURPOSE CLEANING PREPARATION FOR HOUSEHOLD AND COMMERCIAL USE (U.S. CLS. 1, 4, 6, 50, 51 AND 52).

CLASS 3—(Continued).

SN 75-555,888. HERBA LAB INC., VANCOUVER, BRITISH COLUMBIA, CANADA, BY CHANGE OF NAME HERBA-CUTICAL SKIN CARE LTD., VANCOUVER, BRITISH COLUMBIA, CANADA, FILED 9-21-1998.

HERBACORT

PRIORITY CLAIMED UNDER SEC. 44(D) ON CANADA APPLICATION NO. 890404, FILED 9-16-1998, REG. NO. 543983, DATED 4-20-2001, EXPIRES 4-20-2016.

FOR NON-MEDICATED HERBAL SKIN CARE PRODUCT, NAMELY, AN OINTMENT FOR RELIEF FROM ECZEMA, DERMATITIS, ACNE, PSORIASIS, ITCHING, INSECT BITES, MINOR CUTS, MINOR BURNS, ACHES AND MUSCLE SORENESS (U.S. CLS. 1, 4, 6, 50, 51 AND 52).

SN 75-694,965. BUGATTI, CHARLES, PACIFIC PALISADES, CA. AND BUGATTI, STEPHANIE, PACIFIC PALISADES, CA. FILED 4-30-1999.

BUGATTI

SEC. 2(F).

FOR HAIR CARE PRODUCTS, NAMELY, HAIR SHAMPOO, HAIR CONDITIONER, HAIR GEL, HAIR SPRAY AND HAIR AND FACE MIST (U.S. CLS. 1, 4, 6, 50, 51 AND 52).

FIRST USE 0-0-1972; IN COMMERCE 0-0-1972.

SN 75-813,727. APOLLO PRODUCTS, INC., KANSAS CITY, MO. FILED 10-30-1999.

LACE RELEASE PLUS

NO CLAIM IS MADE TO THE EXCLUSIVE RIGHT TO USE "LACE", APART FROM THE MARK AS SHOWN.

FOR HAIRPIECE ADHESIVE REMOVER (U.S. CLS. 1, 4, 6, 50, 51 AND 52).

FIRST USE 1-3-1999; IN COMMERCE 1-3-1999.

SN 75-814,819. PROSCIENCE INCORPORATED, DON MILLS, ONTARIO L3A 1A3, CANADA, FILED 10-5-1999.

COOL SHAVE

PRIORITY CLAIMED UNDER SEC. 44(D) ON CANADA APPLICATION NO. 1029584, FILED 9-21-1999, REG. NO. TMA553156, DATED 10-31-2001, EXPIRES 10-31-2016.

NO CLAIM IS MADE TO THE EXCLUSIVE RIGHT TO USE "SHAVE", APART FROM THE MARK AS SHOWN.

FOR SHAVING PRODUCTS NAMELY FACE CARE CREAMS AND LOTIONS (U.S. CLS. 1, 4, 6, 50, 51 AND 52).

CLASS 3—(Continued).

SN 75-919,660. POLARDREAMS INTERNATIONAL LIMITED, FAIRFIELD, IA. FILED 2-15-2000.

(70% RELAXED)

FOR COLOGNES, AND PERFUMES, POTPOURRI AND SACHETS, BATH AND BEAUTY PRODUCTS, NAMELY, BATH CRYSTALS, BATH GEL, BATH OIL, BAR SKIN SOAP, CREAM BATH, FOAM BATH SOAK, MILK BATH, BATH FIZZ BALLS, AND SHOWER GELS; PERSONAL CARE AND BODY CARE PRODUCTS, NAMELY, PUMICE STONES FOR PERSONAL USE, MASSAGE OILS, BODY BUTTER, BODY LOTION, BODY POWDER, BODY SOUFFLE; BODY SPRAY, BODY MIST, BODY WASH, CREAM LOTION FOR THE SKIN, FOOT LOTION, MUSCLE SOAK SALTS, OIL BEADS FOR THE BATH, SKIN LOTIONS, HAND CREAM AND EYE MASKS, AROMATHERAPY PRODUCTS FEATURING ESSENTIAL OILS FOR PERSONAL USE (U.S. CLS. 1, 4, 6, 50, 51 AND 52).

FIRST USE 7-8-1998; IN COMMERCE 7-8-1998.

SN 75-920,900. CIRCLE OF BEAUTY, INC., NEW YORK, NY. FILED 2-16-2000.

EYE SUPPLY

NO CLAIM IS MADE TO THE EXCLUSIVE RIGHT TO USE "EYE", APART FROM THE MARK AS SHOWN.

FOR COSMETICS, NAMELY, EYE CREAM (U.S. CLS. 1, 4, 6, 50, 51 AND 52).

SN 76-084,117. HERBALIFE INTERNATIONAL, INC., LOS ANGELES, CA. FILED 7-3-2000.

Radiant 

FOR SKIN CARE PRODUCTS, NAMELY, FACIAL CREAMS, FACIAL CLEANSERS, LOTIONS, MOISTURIZERS AND TONERS (U.S. CLS. 1, 4, 6, 50, 51 AND 52).

CLASS 3—(Continued).

SN 76-091,716. BRAXTON, COLSTON & STAFFORD INSTITUTE, THE, BEVERLY HILLS, CA. FILED 7-19-2000.



FOR HAIR CARE PRODUCTS, NAMELY, RELAXERS, STRAIGHTENERS, SHAMPOOS, CONDITIONERS, RINSES, GELS, SCALP POMADES, HAIR POMADES, HAIR FRAGRANCES, HAIR GLOSSES, ACTIVATORS, VOLUMIZERS, NEUTRALIZERS, OILS, WAXES FOR SHINING HAIR, HAIR REMOVAL WAXES, SUN SCREENS, DETANGLERS, GREASES, LOTIONS, OINTMENTS, PERMANENTS, HAIR SPRAYS, MOUSSES, CREAMS, THICKENERS, BALMS, MOISTURIZERS, COLORANTS, EMULSIONS, HAIR TREATMENTS, NAMELY LEAVE-IN CONDITIONERS, HOT OIL-TREATMENTS AND HAIR RINSES; SKIN CARE PRODUCTS, NAMELY, SKIN WASHES, SKIN POMADES, LIP POMADES, ANTIPERSPIRANTS, DEODORANTS, LOTIONS, SHAVING CREAMS, SHAVING GELS, CLEANSERS, SUNSCREENS, SOAPS, HAIR REMOVAL WAXES, WAXES FOR SKIN CONDITIONING, MOISTURIZERS, SKIN LUBRICATORS, REFRESHERS, PEELS, MASKS, EXFOLIANTS, SKIN SMOOTHERS, FRAGRANCES AND CREAMS; COSMETICS, NAMELY, BLUSHES, PENCILS, MASCARAS, EYE SHADOWS, EYE LINERS, FOUNDATIONS, BATH POWDERS, BODY POWDERS AND FACE POWDERS, LIPSTICKS, NAIL POLISH, ASTRINGENTS, TONERS, LIQUID MAKE-UP, MAKE-UP PASTES, PERFUMES, EYE-SHADOWS, NAIL POLISH REMOVERS, DEODORANT STICKS, FOUNDATION STICKS, EYE SHADOW STICKS, NAIL STRENGTHENERS, AND NAIL GLOSSES (U.S. CLS. 1, 4, 6, 50, 51 AND 52).

SN 76-129,263. YVES SAINT LAURENT PARFUMS, 92521 NEUILLY CEDEX, FRANCE, FILED 9-15-2000.

HAUTE LEGERETE

PRIORITY CLAIMED UNDER SEC. 44(D) ON FRANCE APPLICATION NO. 00/3,016,829, FILED 3-24-2000, REG. NO. 003016829, DATED 3-24-2000, EXPIRES 3-24-2010.

THE ENGLISH TRANSLATION OF THE PHRASE "HAUTE LEGERETE" IS "HIGH LIGHTNESS".

FOR SOAPS; PERFUMES; COLOGNE; EAU DE TOILETTE; EAU DE COLOGNE; BODY SPLASH; ESSENTIAL OILS FOR PERSONAL USE; COSMETICS PRODUCTS, NAMELY, COSMETIC PENCILS, FOUNDATION, LIPSTICK, MASCARA, NAIL POLISH, FACE AND BODY POWDER, LIP BALMS, EYE SHADOW AND EYELINER; HAIR LOTIONS; DENTIFRICES; MAKEUP (U.S. CLS. 1, 4, 6, 50, 51 AND 52).

CLASS 3—(Continued).

SN 76-137,570. DIAMOND PRODUCTS COMPANY, INC., THE, TAMPA, FL. FILED 9-28-2000.

SILVER BRILLIANCE

NO CLAIM IS MADE TO THE EXCLUSIVE RIGHT TO USE "SILVER", APART FROM THE MARK AS SHOWN.

FOR HAIR SHAMPOO, HAIR CONDITIONER, HAIR SPRAY, AND HAIR STYLING PREPARATIONS (U.S. CLS. 1, 4, 6, 50, 51 AND 52).

SN 76-166,536. HANS SCHWARZKOPF GMBH & CO., 22763 HAMBURG, FED REP GERMANY, FILED 11-16-2000.



**Color
105**
WWW.COLOR105.COM

PRIORITY CLAIMED UNDER SEC. 44(D) ON FED REP GERMANY APPLICATION NO. 300481748/03, FILED 6-28-2000, REG. NO. 30048174, DATED 12-20-2000, EXPIRES 6-30-2010.

OWNER OF U.S. REG. NOS. 613,665, 2,299,418 AND OTHERS.

NO CLAIM IS MADE TO THE EXCLUSIVE RIGHT TO USE "COLOR", APART FROM THE MARK AS SHOWN.

THE ENGLISH TRANSLATION OF "SCHWARZKOPF" IS "BLACK HEAD".

FOR NON-MEDICATED HAIR CARE AND COLORING PREPARATIONS, NAMELY HAIR COLOR AND CONDITIONER (U.S. CLS. 1, 4, 6, 50, 51 AND 52).

SN 76-177,766. BEIERSDORF AKTIENGESELLSCHAFT, 20245 HAMBURG, FED REP GERMANY, FILED 12-8-2000.

BASIS TOUCH OF MINT

NO CLAIM IS MADE TO THE EXCLUSIVE RIGHT TO USE "MINT", APART FROM THE MARK AS SHOWN.

FOR BODY, SKIN AND BEAUTY CARE PREPARATIONS, NAMELY, EXFOLIATORS AND MOISTURIZERS (U.S. CLS. 1, 4, 6, 50, 51 AND 52).

CLASS 3—(Continued).

SN 76-200,193. VICARIO, VICTORIANO MARTINEZ, 08185 LLICA DE VALL (BARCELONA), SPAIN, FILED 1-25-2001.



THE MARK CONSISTS OF THE WORD "BIOKERA" AND THE DESIGN OF AN OAK LEAF.

FOR HAIR PRODUCTS, NAMELY, HAIR CONDITIONING CREAM, HAIR SHAMPOO, HAIR LOTION, ANTI-DANDRUFF CONDITIONING CREAM, ANTI-DANDRUFF SHAMPOO, ANTI-DANDRUFF LOTION, HAIR LOSS SHAMPOO, HAIR LOSS LOTION, MOISTURIZING SHAMPOO, TRIPLE ACTION CONDITIONER, SPLIT END RESTRUCTURER (U.S. CLS. 1, 4, 6, 50, 51 AND 52).

SN 76-200,194. VICARIO, VICTORIANO MARTINEZ, 08185 LLICA DE VALL (BARCELONA), SPAIN, FILED 1-25-2001.

Salerm
Pro•line

FOR DEODORANT SOAP, TOILET SOAP, SKIN SOAP, SADDLE SOAP, MEDICATED SOAP, SHAVING SOAP, HAND SOAP; PERFUME, COLOGNE, EAU DE PARFUM, EAU DE COLOGNE, EAU DE TOILETTE AND TOILET WATER; ESSENTIAL OILS FOR PERSONAL USE; COSMETICS, HAIR LOTIONS; DENTIFRICES (U.S. CLS. 1, 4, 6, 50, 51 AND 52).

CLASS 3—(Continued).

SN 76-201,261. PARFUMS GIVENCHY S.A., 92300 LEVAL-LOIS-PERRET, FRANCE, FILED 1-29-2001.



PRIORITY CLAIMED UNDER SEC. 44(D) ON FRANCE APPLICATION NO. 003050974, FILED 9-12-2000, REG. NO. 003050974, DATED 9-12-2000, EXPIRES 9-12-2010.

SEC. 2(F).
FOR PERFUMES; EAU DE PERFUME; BATH AND SHOWER GEL; BODY CREAM; PERFUMED VEIL FOR THE BODY; SCENTED BODY SPRAY (U.S. CLS. 1, 4, 6, 50, 51 AND 52).

SN 76-207,217. ESTEE LAUDER INC., NEW YORK, NY, FILED 2-8-2001.

COLORCLICK

FOR COSMETICS (U.S. CLS. 1, 4, 6, 50, 51 AND 52).

SN 76-207,218. ESTEE LAUDER INC., NEW YORK, NY, FILED 2-8-2001.

**PRESCRIPTIVES
COLORCLICK**

OWNER OF U.S. REG. NOS. 1,116,537, 2,406,017 AND OTHERS.
FOR COSMETICS (U.S. CLS. 1, 4, 6, 50, 51 AND 52).

SN 76-213,368. PRODUITS PAUL NIEHANS S.A., CH-1227 GENEVA, SWITZERLAND, FILED 2-21-2001.

PAUL NIEHANS

OWNER OF SWITZERLAND REG. NO. 468327, DATED 3-7-1997, EXPIRES 3-7-2007.

THE NAME IN THE MARK DOES NOT IDENTIFY A LIVING INDIVIDUAL.

FOR PERFUMES, ESSENTIAL OILS FOR PERSONAL USE, FACIAL AND BODY SOAP; PREPARATIONS AND LOTIONS FOR THE HAIR AND THE SCALP; LOTIONS, CREAMS AND GELS FOR FACIAL AND BODY USE (U.S. CLS. 1, 4, 6, 50, 51 AND 52).

CLASS 3—(Continued).

SN 76-213,384. MANNING-LOVETT, MARION, WARWICK, RI. FILED 2-20-2001.

ESARE

FOR SKIN CARE PRODUCTS, NAMELY, MOISTURIZERS, EXFOLIATORS, SUN SCREENS, REVITALIZERS, CLEANSERS, CLARIFIERS, CREAMS, LOTIONS, CONDITIONERS, SKIN ABRASIVE PREPARATIONS, AND COSMETIC PREPARATIONS FOR SKIN RENEWAL (U.S. CLS. 1, 4, 6, 50, 51 AND 52).

SN 76-218,135. ORIGINS NATURAL RESOURCES INC., NEW YORK, NY. FILED 3-1-2001.

EVERYTHING NICE

FOR COSMETICS; SKIN CARE CREAMS, LOTIONS, GELS, OILS, TONICS, TONERS; SKIN MASKS; FACE AND BODY CLEANERS; HAIR SHAMPOOS AND CONDITIONERS; BATH GRAINS, OILS, GELS, SALTS, POWDERS; PERFUMES AND COLOGNES (U.S. CLS. 1, 4, 6, 50, 51 AND 52).

SN 76-218,136. ORIGINS NATURAL RESOURCES INC., NEW YORK, NY. FILED 3-1-2001.

JOIN THE FIRM

FOR COSMETICS; SKIN CARE CREAMS, LOTIONS, GELS, OILS, TONICS, TONERS; SKIN MASKS; FACE AND BODY CLEANERS; HAIR SHAMPOOS AND CONDITIONERS; BATH GRAINS, OILS, GELS, SALTS, POWDERS; PERFUMES AND COLOGNES (U.S. CLS. 1, 4, 6, 50, 51 AND 52).

SN 76-219,886. ACUITY BRANDS, INC., ATLANTA, GA. BY ASSIGNMENT; BY CHANGE OF NAME NSI ENTERPRISES, INC., ATLANTA, GA. FILED 3-5-2001.



OWNER OF U.S. REG. NO. 1,843,394.
NO CLAIM IS MADE TO THE EXCLUSIVE RIGHT TO USE "PLUMBER'S", APART FROM THE MARK AS SHOWN.

FOR CHEMICAL PREPARATIONS FOR USE IN UN-CLOGGING PIPES AND DRAINS (U.S. CLS. 1, 4, 6, 50, 51 AND 52).

CLASS 3—(Continued).

SN 76-220,603. TONI & GUY (USA) LIMITED, LONDON, WCIN 2PL, ENGLAND, FILED 3-5-2001.

MASTERMIND

FOR HAIR CARE PRODUCTS, NAMELY, HAIR SHAMPOO, HAIR CONDITIONER, HAIR TONIC, HAIR GEL, HAIR SPRAY, HAIR MOUSSE, HAIR POMADE, HAIR DYE, HAIR COLOR GEL, HAIR SCULPTING GEL AND HAIR LOTION; SKIN CARE PRODUCTS, NAMELY, SKIN CLEANSER, SKIN MOISTURIZER, SKIN CREAM, SKIN TONER AND SKIN LOTION; AND COSMETIC PRODUCTS, NAMELY, LIPSTICKS, LIPLINERS, LIP PENCILS, EYESHADOW, EYE MAKEUP, EYE PENCILS, EYE MASCARA, EYE LINER, MAKEUP FOUNDATION, FACE POWDER AND BLUSHES (U.S. CLS. 1, 4, 6, 50, 51 AND 52).

SN 76-221,447. ST. TROPEZ, INC., SANTA CLARITA, CA. FILED 3-8-2001.

WHIPPED BRONZE

NO CLAIM IS MADE TO THE EXCLUSIVE RIGHT TO USE "BRONZE", APART FROM THE MARK AS SHOWN.

FOR COSMETICS, NAMELY, AFTER SUN LOTIONS, NAMELY CREAMS AND LOTIONS, AROMATHERAPY OILS, BLUSHES, SKIN CLEANSERS, COSMETIC KITS CONSISTING OF LOTIONS, CREAMS AND GELS, CREAMS FOR FACE AND SKIN, ESSENTIAL OILS FOR PERSONAL USE, EXFOLIATION SCRUBS FOR SKIN, EYE SHADOWS, GELS FOR FACE AND SKIN, HAND CREAMS, LIP BALMS, LIP CREAMS, LIP GLOSS, LIP LINERS, LIPSTICKS, LOTIONS FOR FACE AND SKIN, LOOSE AND PRESSED FACE POWDERS, ESSENTIAL OILS, PERFUMERY, MAKEUP, SKIN MOISTURIZERS, AROMATIC SACHETS, SELF TANNING LOTIONS, SELF TANNING MOUSSES, SOAPS, BODY SPRAYS, SUN BLOCKS, SUN TANNING PREPARATIONS; SUN SCREENING PREPARATIONS; SUN TAN ACCELERATOR PREPARATIONS, NAMELY SPRAYS, LOTIONS AND CREAMS, TISSUES IMPREGNATED WITH COSMETIC LOTIONS, TISSUES IMPREGNATED WITH SELF TANNING LOTIONS, TISSUES IMPREGNATED WITH SUN BLOCKS AND TISSUES IMPREGNATED WITH SUN SCREENS (U.S. CLS. 1, 4, 6, 50, 51 AND 52).

FIRST USE 3-12-2001; IN COMMERCE 3-15-2001.

SN 76-225,668. ORIGINS NATURAL RESOURCES INC., NEW YORK, NY. FILED 3-16-2001.

GINGER GLIMMER

NO CLAIM IS MADE TO THE EXCLUSIVE RIGHT TO USE "GINGER", APART FROM THE MARK AS SHOWN.

FOR SKIN CARE CREAMS, LOTIONS, GELS, OILS, TONICS, TONERS; FACE BODY EXFOLIATING CREAMS, LOTIONS, GELS, OILS, SKIN MASKS; FACE AND BODY CLEANERS; HAIR SHAMPOOS AND CONDITIONERS; BATH GRAINS, OILS, GELS, SALTS, POWDERS; COSMETICS; PERFUMES AND COLOGNES (U.S. CLS. 1, 4, 6, 50, 51 AND 52).

CLASS 3—(Continued).

SN 76-231,254. CHEMCLEAN CORPORATION, SPRINGFIELD GARDENS, NY. FILED 3-27-2001.

CLEANZIME

FOR CLEANING SOLUTIONS, NAMELY MULTI-ENZYMATIC SOLUTIONS USED FOR THE REMOVAL OF ORGANIC CONTAMINANTS IN MANUAL IMMERSION, AUTOMATIC INSTRUMENT WASHERS AND ULTRASONIC MACHINES (U.S. CLS. 1, 4, 6, 50, 51 AND 52).

SN 76-235,413. PAUL MARCEL, INC., MIAMI, FL. FILED 4-4-2001.

PAUL MARCEL

"PAUL MARCEL" DOES NOT IDENTIFY A LIVING INDIVIDUAL.
FOR PERFUME (U.S. CLS. 1, 4, 6, 50, 51 AND 52).

SN 76-241,665. PACIFIC CORPORATION, SEOUL, REPUBLIC OF KOREA, FILED 4-17-2001.

**WHITEGEN
INTENSIVE**

FOR SKIN TONERS, ESSENCES FOR SKIN CARE, NAMELY, SKIN NUTRITIONAL MOISTURIZING SERUM, SKIN LOTIONS, SKIN WHITENING NOURISHING CREAMS, SKIN CLEANSING FOAMS, COSMETIC SOAPS, CLEANSING CREAMS, SHAMPOOS, FACIAL MASKS, AND FOUNDATION CREAMS (U.S. CLS. 1, 4, 6, 50, 51 AND 52).

SN 76-242,973. BOURJOIS, 92200 NEUILLY SUR SEINE, FRANCE, FILED 4-17-2001.

MILLE ET UNE NACRES

PRIORITY CLAIMED UNDER SEC. 44(D) ON FRANCE APPLICATION NO. 003058377, FILED 10-17-2000, REG. NO. 003058377, DATED 10-17-2000, EXPIRES 10-17-2010.

THE ENGLISH TRANSLATION OF "MILLE ET UNE NACRES" IS "A THOUSAND AND ONE MOTHER-OF-PEARL".

FOR SKIN SOAPS, SHOWER GEL, SHOWER MILK AND SHOWER CREAM, PERSONAL DEODORANTS AND DEODORANT CREAM, BODY OIL, PERFUMES, BODY CREAM, BODY EMULSION, SKIN LOTION, BODY LOTIONS (U.S. CLS. 1, 4, 6, 50, 51 AND 52).

CLASS 3—(Continued).

SN 76-243,030. CHANEL, INC., NEW YORK, NY. FILED 4-19-2001.

EXTRA CILS BASE

NO CLAIM IS MADE TO THE EXCLUSIVE RIGHT TO USE "CILS BASE", APART FROM THE MARK AS SHOWN. THE ENGLISH TRANSLATION OF THE MARK "CILS" IS "LASH".

FOR COSMETICS, NAMELY EYELASH GROOMING PREPARATION (U.S. CLS. 1, 4, 6, 50, 51 AND 52).
FIRST USE 10-0-1999; IN COMMERCE 10-0-1999.

SN 76-263,849. NU-CALGON WHOLESALER, INC., ST. LOUIS, MO. FILED 5-29-2001.

KLEEN-N-TOSS

FOR TOWELETTES PERMEATED WITH HAND SOAP FOR WASHING HANDS FOR USE BY INDUSTRIAL HEATING, VENTILATION, AND AIR CONDITIONING EQUIPMENT TECHNICIANS (U.S. CLS. 1, 4, 6, 50, 51 AND 52).

FIRST USE 12-8-2000; IN COMMERCE 12-8-2000.

SN 76-270,784. JOHN FRIEDA PROFESSIONAL HAIR CARE, INC., WILTON, CT. FILED 6-13-2001.

RIPPLE EFFECT

FOR NON-MEDICATED HAIR STYLING PREPARATIONS (U.S. CLS. 1, 4, 6, 50, 51 AND 52).

SN 76-271,875. OVERLORD CW CORPORATION, NEW YORK, NY. FILED 6-4-2001.

霸王 OVERLORD

THE NON-LATIN CHARACTERS IN THE MARK TRANSLITERATE TO "LITAO" WHICH MEANS "BEAUTIFUL WAVES".

FOR HAIR SHAMPOO, HAIR CONDITIONER, FACIAL CLEANERS, SKIN CLEANSING LOTION, SKIN SOAP, LAUNDRY DETERGENT, FACIAL LOTION, BODY LOTION, LIPSTICK, FACIAL MASKS, NAIL ENAMEL, PERFUME, HAIR MOUSSE, AND TOOTH-PASTE (U.S. CLS. 1, 4, 6, 50, 51 AND 52).

CLASS 3—(Continued).

SN 76-272,141. MAKE-UP ART COSMETICS INC., NEW YORK, NY. FILED 6-16-2001.

MOISTURE FEED

NO CLAIM IS MADE TO THE EXCLUSIVE RIGHT TO USE "MOISTURE", APART FROM THE MARK AS SHOWN. FOR SKIN CARE PREPARATIONS, NAMELY, MOISTURIZERS, TONERS, GELS, LOTIONS, AND CLEANSERS (U.S. CLS. 1, 4, 6, 50, 51 AND 52).

SN 76-278,786. Y.Z.Y. INC., MIAMI, FL. FILED 6-29-2001.

HOTAN

FOR COLOGNE, PERFUME, EAU DE TOILETTE (U.S. CLS. 1, 4, 6, 50, 51 AND 52).
FIRST USE 6-1-2001; IN COMMERCE 6-1-2001.

SN 76-284,131. NEUTROGENA CORPORATION, LOS ANGELES, CA. FILED 7-13-2001.

NEUTROGENA HEALTH STICKS

OWNER OF U.S. REG. NOS. 590,385, 1,520,420 AND OTHERS.

NO CLAIM IS MADE TO THE EXCLUSIVE RIGHT TO USE "HEALTH STICKS", APART FROM THE MARK AS SHOWN.

FOR COSMETICS (U.S. CLS. 1, 4, 6, 50, 51 AND 52).

SN 76-297,021. TCHEUPDJIAN, LEON, ARLINGTON HEIGHTS, IL. FILED 8-9-2001.

GARCON

THE ENGLISH TRANSLATION OF GARCON IS "WAITER" OR "LITTLE BOY".

FOR MEN'S SKIN CARE PREPARATIONS (U.S. CLS. 1, 4, 6, 50, 51 AND 52).

SN 76-300,546. PACIFICOIR, INC., PARK CITY, UT. FILED 8-16-2001.

AUNT EMMA'S

FOR GREASE AND OIL ABSORBING PREPARATIONS, FOR USE IN KITCHENS, COMPOSED OF COCONUT COIR AND PEAT MOSS (U.S. CLS. 1, 4, 6, 50, 51 AND 52).

CLASS 3—(Continued).

SN 76-306,642. SALSA FOR HAIR, INC., MIAMI, FL. FILED 8-30-2001.

Olivier Dachkin

THE NAME "OLIVIER DACHKIN" DOES NOT IDENTIFY A LIVING INDIVIDUAL.

FOR HAIR SHAMPOO, CONDITIONER, SPRAY, RELAXER, PERMANENT, AND GEL (U.S. CLS. 1, 4, 6, 50, 51 AND 52).

FIRST USE 8-10-2001; IN COMMERCE 8-10-2001.

SN 76-319,377. U.S. PERFUME HOUSE, INC., BROOKLYN, NY. FILED 10-1-2001.

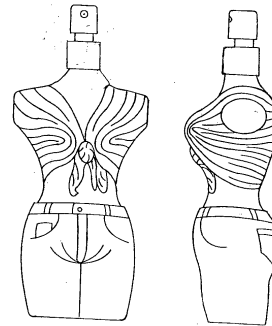

THE LINING IN THE DRAWING DEPICTS CREASES IN THE HALTER-TOP AND JEANS AND IS A FEATURE OF THE MARK.

THE MARK CONSISTS OF THE CONFIGURATION OF THE CONTAINER FOR THE GOODS, NAMELY, PERFUMES. THE BOTTLE IS TRANSLUCENT. THE BOTTLE IN THE STYLIZED SHAPE OF THE FEMALE TORSO DRESSED IN A HALTER-TOP TIED AT THE FRONT MIDSECTION AND WEARING A PAIR OF JEANS. THE HALTER-TOP AND JEANS ARE SLIGHTLY FROSTED. THE DRAWING SHOWS THE FRONT AND ONE SIDE OF THE MARK.

FOR FRAGRANCES, NAMELY, PERFUMES (U.S. CLS. 1, 4, 6, 50, 51 AND 52).

FIRST USE 4-6-2001; IN COMMERCE 4-6-2001.

SN 76-319,970. GRUNER + JAHR PRINTING & PUBLISHING CO., NEW YORK, NY. FILED 10-1-2001.

YM

OWNER OF U.S. REG. NOS. 2,343,150, 2,471,446 AND OTHERS.

FOR EYE MASKS (U.S. CLS. 1, 4, 6, 50, 51 AND 52).

FIRST USE 7-1-2001; IN COMMERCE 7-1-2001.

CLASS 3—(Continued).

SN 76-323,161. GIRL MANIA, INC., LOS ANGELES, CA. FILED 10-9-2001.



FOR HAIR CARE PRODUCTS, NAMELY, HAIR SHAMPOO, HAIR CONDITIONER, HAIR SPRAY AND HAIR STYLING PREPARATIONS; COSMETICS; SKIN CARE PRODUCTS, NAMELY, SOAPS, SKIN LOTIONS, BODY LOTIONS, SKIN CREAMS, SKIN MASKS, SKIN SERUMS, SKIN SCRUBS, SKIN OILS, SKIN BATH SOLUTIONS, FRAGRANCES, AND EYE MASKS (U.S. CLS. 1, 4, 6, 50, 51 AND 52).

SN 76-327,740. UN-DU PRODUCTS, INC., DALLAS, TX. FILED 10-19-2001.

PHOTOCARE

FOR CLEANING PREPARATION FOR PHOTOGRAPHS (U.S. CLS. 1, 4, 6, 50, 51 AND 52).

SN 76-331,365. TANNER, ANDRE, ZURICH, SWITZERLAND, FILED 10-29-2001.

ALPRAUSCH

FOR COSMETICS; ESSENTIAL OILS FOR PERSONAL USE; PERFUME; SOAPS, NAMELY, SKIN SOAPS, TOILET SOAPS, SHAVINGS SOAPS, MEDICATED SOAPS, HAND SOAPS, DEODORANT SOAPS, ANTI-BACTERIAL SOAPS, ANTIBACTERIAL SKIN SOAPS, DETERGENT SOAPS, AND DISINFECTANT SOAPS (U.S. CLS. 1, 4, 6, 50, 51 AND 52).

SN 76-338,167. PHONESKILL, INC., CHICAGO, IL. FILED 11-15-2001.

MEDCALM

FOR FRAGRANT BODY OILS FOR PERSONAL USE (U.S. CLS. 1, 4, 6, 50, 51 AND 52).

CLASS 3—(Continued).

SN 76-338,211. JACOBS, RANDY J., MURRIETA, CA. FILED 11-16-2001.



FOR SKIN MOISTURIZER (U.S. CLS. 1, 4, 6, 50, 51 AND 52).

SN 76-338,563. PHONESKILL, INC., CHICAGO, IL. FILED 11-15-2001.

MIRACLECALM

FOR FRAGRANT BODY OILS FOR PERSONAL USE (U.S. CLS. 1, 4, 6, 50, 51 AND 52).

SN 76-338,848. PHONESKILL, INC., CHICAGO, IL. FILED 11-15-2001.

THERACALM

FOR FRAGRANT BODY OILS FOR PERSONAL USE (U.S. CLS. 1, 4, 6, 50, 51 AND 52).

SN 76-340,408. NATERRA INTERNATIONAL, INC., DALLAS, TX. FILED 11-19-2001.

TREE HUT

FOR SKIN CARE PRODUCTS, NAMELY SKIN CLEANSER, SKIN LOTION, SKIN MOISTURIZER, SKIN CREAM, SKIN TONER, NIGHT CREAM, BODY CREAM, BUBBLE BATH, NON-MEDICATED BATH SALTS, LIQUID SOAPS FOR THE HANDS, FACE AND BODY, AND SKIN SOAPS (U.S. CLS. 1, 4, 6, 50, 51 AND 52).

SN 76-341,966. L'OREAL, PARIS, FRANCE, FILED 11-27-2001.

EYEPLAY

FOR MASCARA AND EYELINER (U.S. CLS. 1, 4, 6, 50, 51 AND 52).

CLASS 3—(Continued).

SN 76-342,363. CAMBRIDGE DIAGNOSTIC PRODUCTS, INC., FORT LAUDERDALE, FL. FILED 11-26-2001.

ERADA-STAIN

FOR CLEANER FOR USE ON HANDS, PLASTIC, GLASSWARE AND LABORATORY EQUIPMENT; STAIN REMOVER (U.S. CLS. 1, 4, 6, 50, 51 AND 52).
FIRST USE 3-0-1970; IN COMMERCE 3-0-1970.

SN 76-342,572. L'OREAL USA CREATIVE, INC., NEW YORK, NY. FILED 11-28-2001.

SPIKETRIX

OWNER OF U.S. REG. NOS. 1,277,705, 2,226,310 AND OTHERS.
FOR HAIR STYLING PREPARATION (U.S. CLS. 1, 4, 6, 50, 51 AND 52).

SN 76-342,949. ALDI INC., BATAVIA, IL. FILED 11-30-2001.

TUNDRA

FOR LAUNDRY-BLEACH (U.S. CLS. 1, 4, 6, 50, 51 AND 52).

SN 76-343,086. GLIDDEN COMPANY, THE, CLEVELAND, OH. FILED 11-29-2001.

HYDROSTRIP

FOR PAINT STRIPPER (U.S. CLS. 1, 4, 6, 50, 51 AND 52).
FIRST USE 8-0-2001; IN COMMERCE 8-0-2001.

SN 78-039,983. AVON PRODUCTS, INC., NEW YORK, NY. FILED 12-20-2000.

TIME TO SHINE

FOR NON-MEDICATED HAIR CARE PREPARATIONS, NAMELY, SHAMPOO (U.S. CLS. 1, 4, 6, 50, 51 AND 52).

CLASS 3—(Continued).

SN 78-040,372. SUPERSONIC, IVY, NEW YORK, NY. FILED 12-21-2000.

LIQUIDENIUM

FOR COSMETIC PRODUCTS, NAMELY BODY PAINT CONSISTING OF COSMETIC PAINT AND/OR LIQUID LATEX THAT IS APPLIED TO AND ADHERES DIRECTLY TO THE SKIN WHICH MAY BE APPLIED BY FINGERTIP, BRUSH, SPONGE, OR CLOTH AND COMES IN A VARIETY OF COLORS WITH BASE HUES RED, GREEN, AND YELLOW (U.S. CLS. 1, 4, 6, 50, 51 AND 52).

SN 78-078,111. BROWNING, PAUL, T., TRAFALGAR, IN. FILED 8-8-2001.

BASS BOAT SAVER

NO CLAIM IS MADE TO THE EXCLUSIVE RIGHT TO USE "BASS BOAT", APART FROM THE MARK AS SHOWN.
FOR BASS BOAT SAVER IS A LIQUID CLEANER/PROTECTANT FOR BOAT FINISHES (U.S. CLS. 1, 4, 6, 50, 51 AND 52).

SN 78-078,395. AUSTRALIAN ALL NATURAL PTY LTD., SANDRINGHAM, VICTORIA, 3191, AUSTRALIA, FILED 8-9-2001.

Return to Nature

THE MARK CONSISTS OF A SHADED RECTANGLE CARRIER DESIGN WITH A STYLIZED HUMAN FIGURE DESIGN.

FOR SKIN CARE PREPARATIONS; BODY BALM; FOOT CARE PREPARATIONS; HAIR CARE PREPARATIONS; SHAMPOOS AND CONDITIONERS; SOAPS (U.S. CLS. 1, 4, 6, 50, 51 AND 52).

SN 78-086,085. ECOLAB INC, ST. PAUL, MN. FILED 9-28-2001.

WHOOPS!

FOR STAIN REMOVER FOR CARPETS, UPHOLSTERY AND CLOTHING (U.S. CLS. 1, 4, 6, 50, 51 AND 52).

CLASS 3—(Continued).

SN 78-086,460. TOO, INC., COLUMBUS, OH. FILED 10-2-2001.

SHOWER CRAZE

NO CLAIM IS MADE TO THE EXCLUSIVE RIGHT TO USE "SHOWER", APART FROM THE MARK AS SHOWN. FOR PERSONAL CARE PRODUCTS, NAMELY, SHOWER GEL (U.S. CLS. 1, 4, 6, 50, 51 AND 52).

SN 78-091,440. USA LABS, INC., MEDLEY, FL. FILED 11-2-2001.

what a
dish!

FOR DETERGENT FOR WASHING DISHES (U.S. CLS. 1, 4, 6, 50, 51 AND 52).

SN 78-091,443. USA LABS, INC., MEDLEY, FL. FILED 11-2-2001.

Show It!

FOR ALL PURPOSE CLEANER (U.S. CLS. 1, 4, 6, 50, 51 AND 52).

CLASS 3—(Continued).

SN 78-091,924. MOELLEKEN, WOLFGANG W., SANTA BARBARA, CA. FILED 11-6-2001.

HERMYSTIQUE

FOR SKIN CARE PREPARATIONS, NAMELY FACE CREAMS, GELS, AND LOTIONS; ANTI-WRINKLE CREAMS, GELS, AND LOTIONS; SKIN PIGMENT LIGHTENING CREAMS, GELS AND LOTIONS; SUN SCREEN, SUN BLOCK, SELF TANNING CREAMS, GELS AND LOTIONS; SKIN CLEANSING CREAMS, GELS AND LOTIONS; SKIN CONDITIONING CREAMS, GELS AND LOTIONS; SKIN MOISTURIZING CREAMS, GELS AND LOTIONS; NON-MEDICATED ANTI-BLEMISH CREAMS, GELS AND LOTIONS (U.S. CLS. 1, 4, 6, 50, 51 AND 52).

SN 78-092,387. VIACOM INTERNATIONAL INC., NEW YORK, NY. FILED 11-8-2001.

**THE ADVENTURES OF
JIMMY NEUTRON BOY
GENIUS**

FOR BATH PRODUCTS, NAMELY, TOOTHPASTE, SKIN SOAP, SKIN LOTION, HAIR SHAMPOO AND HAIR CONDITIONERS (U.S. CLS. 1, 4, 6, 50, 51 AND 52).

SN 78-092,640. R RIEVELEY & ASSOCIATES, BLAINE, WA. FILED 11-9-2001.

LARISSE

FOR SKIN CARE PRODUCTS, NAMELY, ANTI-AGING CREAMS, ASTRINGENTS FOR COSMETIC PURPOSES, BEAUTY MASKS, SKIN CLEANSING LOTION, COLD CREAM, SKIN CONDITIONER OR MOISTURIZER, EYE CREAM, NIGHT CREAM, VANISHING CREAM, FACIAL CLEANSERS, FACIAL CREAMS, FACIAL EMULSIONS, FACIAL MASKS, FACIAL SCRUBS; BODY CARE PRODUCTS, NAMELY, BODY CREAMS AND LOTIONS, BODY EMULSIONS, BODY MASKS, BODY OIL, BODY POWDER, BODY SCRUBS, PERSONAL DEODORANT, HAND CREAM, CREAMS FOR CELLULITE REDUCTION, DEPILATORY CREAMS, HAIR REMOVING CREAM, PEDICURE CREAM, FOOT CREAMS, MASSAGE LOTION, FOOT LOTION; BATH PRODUCTS, NAMELY, SOAP SOLID AND LIQUID, BATH BEADS, BATH CRYSTALS, BATH FOAM, BATH GEL, BATH OIL, BUBBLE BATH, EFFERVESCENT BATH SOLIDS, BATH PEARLS, BATH POWDER, BATH SALTS, BODY WASHES, SHOWER GEL, NON-MEDICATED BODY SOAKS; COSMETICS, NAMELY, CONCEALERS NAMELY FOR THE SKIN, FACE AND BODY, BLUSH, BLUSHER, EYE GELS, EYE PENCILS, EYE MAKE-UP REMOVER, LIP GLOSS, LIPSTICK, LIP LINERS, LIP SEALERS, EAU DE PERFUME, COLOGNE, EAU DE TOILETTE, ESSENTIAL OILS FOR PERSONAL USE, ESSENTIAL OILS FOR USE IN THE MANUFACTURE OF SCENTED PRODUCTS, POTPOURRI; HAIR CARE PRODUCTS, NAMELY, HAIR CARE PREPARATIONS, HAIR CLEANING PREPARATIONS, HAIR COLOURS, HAIR CONDITIONERS, HAIR LOTIONS, HAIR MOUSSE, HAIR RINSES, HAIR STYLING PREPARATIONS; PRE-SUN PRODUCTS, NAMELY, SUN BLOCK, SUN SCREEN, SUN CREAMS, SUN TAN LOTION, SUN TAN GEL, SUN TAN OIL, AFTER-SUN LOTIONS, AND SELF-TANNING LOTIONS (U.S. CLS. 1, 4, 6, 50, 51 AND 52).

CLASS 3—(Continued).

SN 78-092,727. PROCTER & GAMBLE COMPANY, THE, CINCINNATI, OH. FILED 11-12-2001.

PAMPERS NATURAL ALOE TOUCH

OWNER OF U.S. REG. NOS. 745,513, 2,153,065 AND 2,304,486.

NO CLAIM IS MADE TO THE EXCLUSIVE RIGHT TO USE "ALOE", APART FROM THE MARK AS SHOWN.

FOR DISPOSABLE, PRE-MOISTENED BABY WIPES (U.S. CLS. 1, 4, 6, 50, 51 AND 52).

SN 78-096,468. ALBERTO-CULVER COMPANY, MELROSE PARK, IL. FILED 12-4-2001.

PURSONALS

FOR FEMININE DEODORANT SPRAYS (U.S. CLS. 1, 4, 6, 50, 51 AND 52).

SN 78-096,506. PT. BEA SARI JELITA, SEMARANG, INDONESIA, FILED 12-4-2001.

MEDICAM

FOR ANTI-BACTERIAL SOAP, DEODORANT SOAP, DETERGENT SOAP, MEDICATED SOAP, SKIN SOAP, TOILET SOAP, LAUNDRY DETERGENT, AND TOOTH PASTE (U.S. CLS. 1, 4, 6, 50, 51 AND 52).

CLASS 4—LUBRICANTS AND FUELS

SN 76-102,918. CONOCO INC., PONCA CITY, OK. FILED 8-3-2000.



OWNER OF U.S. REG. NOS. 521,617, 1,911,017 AND OTHERS.

FOR FUEL OIL, AUTOMOTIVE GREASES, AUTOMOTIVE LUBRICANTS, AND FUELS, NAMELY, GASOLINE (U.S. CLS. 1, 6 AND 15).

FIRST USE 2-28-2001; IN COMMERCE 2-28-2001.

CLASS 4—(Continued).

SN 76-118,754. HERCULES INCORPORATED, WILMINGTON, DE. FILED 8-29-2000.

TURBOLINE

FOR PERFORMANCE ADDITIVES FOR FUELS USED IN TURBINE ENGINES (U.S. CLS. 1, 6 AND 15).
FIRST USE 6-1-1999; IN COMMERCE 6-1-1999.

SN 76-190,090. T N J CIGAR CO. INC., AMITYVILLE, NY. FILED 1-5-2001.

LITTLE CIGAR FACTORY

FOR CIGARS, HUMIDORS LIGHTERS (NOT OF PRECIOUS METALS) AND CIGAR CUTTERS (U.S. CLS. 1, 6 AND 15).

FIRST USE 10-1-1997; IN COMMERCE 11-1-1997.

SN 76-293,385. KISS MY FACE CORPORATION, GARDINER, NY. FILED 8-1-2001.

S'CANDLES

FOR CANDLES (U.S. CLS. 1, 6 AND 15).

SN 76-308,096. AOS THERMAL COMPOUNDS, LLC, EATONTOWN, NJ. FILED 9-1-2001.



FOR THERMAL HEAT SINK COMPOUNDS NAMELY, THERMAL GREASE FOR USE IN MOUNTING TRANSISTORS, DIODES, RECTIFIER AND RESISTORS AND FOR USE IN A THERMAL JOINT FOR ANY ELECTRONIC APPARATUS WHERE EFFICIENT COOLING IS DESIRED (U.S. CLS. 1, 6 AND 15).

FIRST USE 1-11-2001; IN COMMERCE 1-11-2001.

CLASS 4—(Continued).

SN 76-338,168. POWER BUYING DEALERS, USA, INC., OAKBROOK, IL. FILED 11-15-2001.

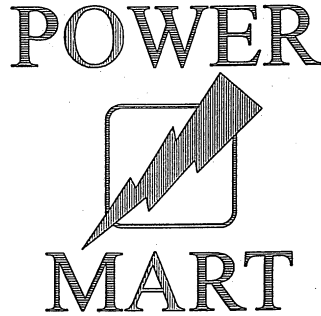

THE MARK AS IT APPEARS ON THE DRAWING IS LINED/SHADED TO DESIGNATE COLOR AS INDICATED BELOW. SAID DESIGNATED COLORS BEING A CLAIMED FEATURE OF THE MARK - LIGHTNING BOLT - RED "O" IN "POWER" - RED "A" IN "MART" - RED ALL OTHER LINES AND LETTERS - BLUE.

FOR MOTOR OIL AND TRANSMISSION FLUID (U.S. CLS. 1, 6 AND 15).

CLASS 5—(Continued).

SN 75-579,211. H BIO-JUVEN PTY LTD, VICTORIA 3072, AUSTRALIA, FILED 10-29-1998.

H BIO-JUVEN PLANTOLIN

FOR PHARMACEUTICAL PREPARATIONS FOR THE TREATMENT OF ARTHRITIS, RHEUMATISM, SCIATICA, AND SKIN DISEASES AND CONDITIONS; MEDICATED SHAMPOOS, CONDITIONERS, AND SHAMPOO/CONDITIONERS; MEDICATED SKIN, MOUTH, AND LIP BALMS; THERAPEUTIC PREPARATIONS FOR THE BATH, NAMELY, HAND, NAIL, AND BODY CREAMS AND LOTIONS (U.S. CLS. 6, 18, 44, 46, 51 AND 52).

SN 75-664,990. ESPE DENTAL AG, D-82229 SEEFELD, FED REP GERMANY, FILED 3-22-1999.

REFERENCE

CLASS 5—PHARMACEUTICALS

SN 75-099,911. ORICA AUSTRALIA PTY. LTD., MELBOURNE, VICTORIA, AUSTRALIA. BY CHANGE OF NAME ICI AUSTRALIA OPERATIONS PROPRIETARY LIMITED, VICTORIA, AUSTRALIA, FILED 5-7-1996.

HEPAZEM

PRIORITY CLAIMED UNDER SEC. 44(D) ON AUSTRALIA APPLICATION NO. 681642, FILED 12-21-1995, REG. NO. 681642, DATED 12-21-1995, EXPIRES 12-21-2005.

FOR PHARMACEUTICAL PREPARATIONS USED IN THE TREATMENT OF LIVER DISORDERS (U.S. CLS. 6, 18, 44, 46, 51 AND 52).

OWNER OF FED REP GERMANY REG. NO. 39725402, DATED 7-29-1997, EXPIRES 6-30-2007.

FOR DENTAL MATERIALS, NAMELY, MATERIALS FOR TOOTH FILLINGS, DENTAL CEMENTS, DENTAL LACQUERS, COMPOSITE RESINS FOR DENTAL USE, IMPRESSION MATERIAL FOR DENTAL USES, EMBEDDING MATERIAL FOR DENTAL USES, MATERIAL FOR SETTING AND CREATING TOOTH CROWNS AND TOOTH BRIDGES FOR DENTAL AND DENTAL TECHNICAL USES, BONDING MATERIAL FOR DENTAL USE, MATERIALS FOR SETTING AND CREATING MARYLAND BRIDGES FOR DENTAL AND DENTAL TECHNICAL USES (U.S. CLS. 6, 18, 44, 46, 51 AND 52).

SN 75-810,332. GMN INC., ENCINITAS, CA. FILED 10-20-1999.

SN 75-533,046. AVIRON, MOUNTAIN VIEW, CA. FILED 8-7-1998.

AVIRON

FOR VACCINES USED TO TREAT INFECTIOUS CONDITIONS (U.S. CLS. 6, 18, 44, 46, 51 AND 52).

THERMASLIM

FOR NUTRITIONAL SUPPLEMENT (U.S. CLS. 6, 18, 44, 46, 51 AND 52).

CLASS 5—(Continued).

SN 76-002,322. C.R. BARD, INC., MURRAY HILL, NJ. FILED 3-16-2000.

SURGICAL INNOVATIONS**TISSUE SOLUTIONS**

NO CLAIM IS MADE TO THE EXCLUSIVE RIGHT TO USE "SURGICAL" AND "TISSUE SOLUTIONS", APART FROM THE MARK AS SHOWN.

THE STIPLING IS FOR SHADING PURPOSES.

THE MARK CONSISTS OF THREE IDENTICAL UNDULATED RECTANGULAR SHAPES PLACED ONE ON TOP OF THE OTHER IN A LAYERED EFFECT.

FOR NON-ARTIFICIAL DERMAL COLLAGEN MATRIX, NAMELY, SHEETS, PATCHES AND MEMBRANES INTENDED FOR SUBSEQUENT SKIN IMPLANTATION FOR USE IN RECONSTRUCTION, REPAIR AND/OR REPLACEMENT OF SOFT TISSUE DEFICIENCIES (U.S. CLS. 6, 18, 44, 46, 51 AND 52).

SN 76-005,969. NUTRACEUTIX, INC., REDMOND, WA. FILED 3-21-2000.

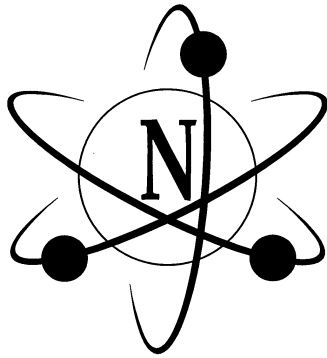

FOR DIETARY SUPPLEMENTS AND VITAMIN AND MINERAL SUPPLEMENTS (U.S. CLS. 6, 18, 44, 46, 51 AND 52).

SN 76-034,860. SIERIC CORPORATION, HAYWARD, CA. FILED 4-25-2000.

FIZZACAL HEALTH

NO CLAIM IS MADE TO THE EXCLUSIVE RIGHT TO USE "HEALTH", APART FROM THE MARK AS SHOWN.

FOR DIETARY FOOD SUPPLEMENTS AND MULTIVITAMINS IN THE FORM OF EFFERVESCENT POWDER AND TABLETS TO ASSIST WITH VITAMIN DEFICIENCIES AND DAILY VITAMIN AND HERBAL MAINTENANCE (U.S. CLS. 6, 18, 44, 46, 51 AND 52).

CLASS 5—(Continued).

SN 76-074,497. MERZ + CO. GMBH & CO., 60318 FRANKFURT AM MAIN, FED REP GERMANY, FILED 6-21-2000.

EBIXA

OWNER OF FED REP GERMANY REG. NO. 39758823, DATED 4-15-1998, EXPIRES 12-31-2007.

FOR PHARMACEUTICAL PREPARATIONS, NAMELY, ANTIDEMENTIA DRUGS (U.S. CLS. 6, 18, 44, 46, 51 AND 52).

SN 76-079,758. PREMIER RESEARCH LABORATORIES, L.P., ROUND ROCK, TX. FILED 6-28-2000.

NEEMASTAT

FOR DIETARY SUPPLEMENTS (U.S. CLS. 6, 18, 44, 46, 51 AND 52).

FIRST USE 6-12-2000; IN COMMERCE 6-12-2000.

SN 76-091,455. ABLE LABORATORIES, INC., SOUTH PLAINFIELD, NJ. FILED 7-18-2000.

ABLETEX

FOR PHARMACEUTICAL PREPARATIONS FOR THE TREATMENT OF COUGH AND COLD SYMPTOMS (U.S. CLS. 6, 18, 44, 46, 51 AND 52).

FIRST USE 7-1-2000; IN COMMERCE 7-1-2000.

SN 76-103,390. CLOVER CORPORATION LIMITED, NORTH SYDNEY, NSW 2060, AUSTRALIA, FILED 8-3-2000.



NO CLAIM IS MADE TO THE EXCLUSIVE RIGHT TO USE "NATURAL HI DHA", APART FROM THE MARK AS SHOWN.

THE MARK CONSISTS OF WORDS "NATURAL HI"; THE LETTERS "DHA"; REPRESENTATION OF A THREE LEAF CLOVER AND DEVICE.

FOR FOOD AND BEVERAGES FOR MEDICALLY RESTRICTED DIETS; DIETARY FOOD SUPPLEMENTS; BABY AND INFANT FOOD FORMULAE; NUTRITIONAL ADDITIVES FOR LIVESTOCK FEED; MEDICINAL OILS, NAMELY FISH OIL, COD LIVER OIL, TUNA OIL AND EVENING PRIMROSE OIL FOR USE AS A DIETARY SUPPLEMENT; MICRO-ENCAPSULATED OILS AND EMULSIFIED OILS FOR USE AS DIETARY SUPPLEMENTS; NUTRITIONAL AND DIETARY SUPPLEMENTS IN CAPSULE AND TABLET FORM (U.S. CLS. 6, 18, 44, 46, 51 AND 52).

CLASS 5—(Continued).

SN 76-106,721. TEVA PHARMACEUTICAL INDUSTRIES LTD., JERUSALEM, ISRAEL, FILED 8-9-2000.

AGILECT

PRIORITY CLAIMED UNDER SEC. 44(D) ON ISRAEL APPLICATION NO. 139,845, FILED 7-9-2000, REG. NO. 139845, DATED 7-3-2001, EXPIRES 7-9-2007.

FOR PHARMACEUTICAL PREPARATIONS FOR THE TREATMENT OF PARKINSON DISEASE AND OTHER CENTRAL NERVOUS SYSTEM DISORDERS (U.S. CLS. 6, 18, 44, 46, 51 AND 52).

SN 76-115,585. XECHEM INTERNATIONAL INC., NEW BRUNSWICK, NJ. FILED 8-23-2000.

ANTIOX ONCE

FOR NUTRACEUTICALS FOR USE AS A DIETARY SUPPLEMENT (U.S. CLS. 6, 18, 44, 46, 51 AND 52).

SN 76-122,509. SANOFI-SYNTHELABO, PARIS, FRANCE, FILED 9-5-2000.

FASURIA

FOR PHARMACEUTICAL PREPARATION FOR THE PREVENTION OR TREATMENT OF HYPERURICEMIA (U.S. CLS. 6, 18, 44, 46, 51 AND 52).

SN 76-122,510. SANOFI-SYNTHELABO, PARIS, FRANCE, FILED 9-5-2000.

ELITEK

OWNER OF U.S. REG. NO. 2,106,677.
FOR PHARMACEUTICAL PREPARATION FOR THE PREVENTION OR TREATMENT OF HYPERURICEMIA (U.S. CLS. 6, 18, 44, 46, 51 AND 52).

SN 76-127,574. HERAEUS-KULZER, INC., ARMONK, NY. BY MERGER, BY CHANGE OF NAME J. F. JELENKO & CO., ARMONK, NY. FILED 9-14-2000.

JELDENT

OWNER OF U.S. REG. NO. 151,150.
FOR RESINS AND ACTIVATORS FOR RESINS FOR USE IN DENTURE GUM CONSTRUCTION (U.S. CLS. 6, 18, 44, 46, 51 AND 52).
FIRST USE 2-24-1999; IN COMMERCE 2-24-1999.

CLASS 5—(Continued).

SN 76-145,020. BRACCO S.P.A., 20134 MILAN, ITALY, FILED 10-12-2000.

BOPTAMIR

OWNER OF ITALY REG. NO. 604167, DATED 10-4-1993, EXPIRES 3-6-2003.

FOR CONTRAST MEDIA FOR IN-VIVO IMAGING (U.S. CLS. 6, 18, 44, 46, 51 AND 52).

SN 76-145,021. BRACCO S.P.A., 20134 MILAN, ITALY, FILED 10-12-2000.

BOPTAMIRON

OWNER OF ITALY REG. NO. 604169, DATED 10-4-1993, EXPIRES 3-6-2003.

FOR CONTRAST MEDIA FOR IN-VIVO IMAGING (U.S. CLS. 6, 18, 44, 46, 51 AND 52).

SN 76-145,022. BRACCO S.P.A., 20134 MILAN, ITALY, FILED 10-12-2000.

BOPTAMERON

OWNER OF ITALY REG. NO. 604168, DATED 10-4-1993, EXPIRES 3-6-2003.

FOR CONTRAST MEDIA FOR IN-VIVO IMAGING (U.S. CLS. 6, 18, 44, 46, 51 AND 52).

SN 76-152,164. HEALTH & INTEGRITY CORP, BELLEVUE, WA. FILED 10-23-2000.

ELECTRICAL NUTRITION

NO CLAIM IS MADE TO THE EXCLUSIVE RIGHT TO USE "NUTRITION", APART FROM THE MARK AS SHOWN.

FOR DIETARY SUPPLEMENTS (U.S. CLS. 6, 18, 44, 46, 51 AND 52).

FIRST USE 10-0-1997; IN COMMERCE 10-0-1997.

SN 76-153,874. BARR LABORATORIES, INC., POMONA, NY. FILED 10-25-2000.

MYLOCEL

FOR PHARMACEUTICAL PREPARATIONS, NAMELY, AN ANTINEOPLASTICS (U.S. CLS. 6, 18, 44, 46, 51 AND 52).

CLASS 5—(Continued).

SN 76-161,773. TEXAS BIOTECHNOLOGY CORPORATION, HOUSTON, TX. FILED 11-8-2000.

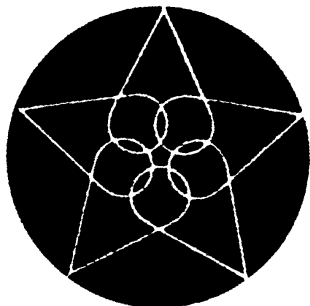

THE DRAWING OF THE CIRCLE IN THE MARK IS LINED FOR THE COLOR GREY; THE INSCRIBED STAR DESIGN IS A FINE YELLOW LINE. COLOR IS CLAIMED AS A FEATURE OF THE MARK.

FOR PHARMACEUTICAL PREPARATIONS FOR THE TREATMENT OF CARDIOVASCULAR, INFLAMMATORY AND RESPIRATORY DISEASES OR CONDITIONS (U.S. CLS. 6, 18, 44, 46, 51 AND 52).

SN 76-168,214. BOEHRINGER INGELHEIM PHARMA KG, D-55216 INGELHEIM AM RHEIN, FED REP GERMANY, FILED 11-20-2000.

LERXIN

OWNER OF FED REP GERMANY REG. NO. 39800344, DATED 4-9-1998, EXPIRES 1-31-2008.

FOR PHARMACEUTICAL PREPARATIONS FOR THE TREATMENT OF THE CENTRAL AND PERIPHERAL NERVOUS SYSTEM (U.S. CLS. 6, 18, 44, 46, 51 AND 52).

SN 76-177,774. VITAQUEST INTERNATIONAL, INC., WEST CALDWELL, NJ. FILED 12-8-2000.

SUPER WEIGHT LOSS

NO CLAIM IS MADE TO THE EXCLUSIVE RIGHT TO USE "WEIGHT LOSS", APART FROM THE MARK AS SHOWN.

FOR DIETARY SUPPLEMENT (U.S. CLS. 6, 18, 44, 46, 51 AND 52).

FIRST USE 3-1-1995; IN COMMERCE 3-1-1995.

SN 76-177,872. LICONSA, LIBERACION CONTROLADA DE SUSTANCIAS ACTIVAS, S.A., 08028 BARCELONA, SPAIN, FILED 12-8-2000.

LICONSA

FOR PHARMACEUTICAL PRODUCTS, NAMELY, ITRACONAZOL PELLETS FOR THE TREATMENT OF FUNGUS (U.S. CLS. 6, 18, 44, 46, 51 AND 52).

FIRST USE 0-0-1997; IN COMMERCE 0-0-1997.

CLASS 5—(Continued).

SN 76-180,701. SOLVAY PHARMACEUTICALS B.V., WEESP, NETHERLANDS, FILED 12-14-2000.

SOVIVA

PRIORITY CLAIMED UNDER SEC. 44(D) ON BENELUX APPLICATION NO. 0974384, FILED 9-29-2000, REG. NO. 0672409, DATED 9-29-2000, EXPIRES 9-19-2010.

FOR PHARMACEUTICAL PREPARATIONS AND SUBSTANCES, NAMELY PSYCHOACTIVE DRUGS FOR THE TREATMENT OF ANXIETY, DEPRESSION AND OBSSIVE-COMPULSIVE DISORDERS (U.S. CLS. 6, 18, 44, 46, 51 AND 52).

SN 76-183,392. MARIE, SYLVIA, SEBASTOPOL, CA. FILED 12-19-2000.

LIVING EARTH ESSENCES

FOR DIETARY SUPPLEMENTS, NAMELY, FLOWER ESSENCES AND PLANT ESSENCES, PREPARED FROM PLANT INFUSIONS IN WATER, GENERALLY PRESERVED WITH BRANDY, FOR PERSONAL DIETARY USE (U.S. CLS. 6, 18, 44, 46, 51 AND 52).

FIRST USE 4-1-1994; IN COMMERCE 2-10-1995.

SN 76-193,103. ASTRAZENECA AB, S-151 85 SODERTALJE, SWEDEN, FILED 1-12-2001.

ORAL DTI

NO CLAIM IS MADE TO THE EXCLUSIVE RIGHT TO USE "ORAL", APART FROM THE MARK AS SHOWN.

FOR PHARMACEUTICAL PREPARATIONS FOR THE TREATMENT OF CARDIO VASCULAR DISEASES AND DISORDERS (U.S. CLS. 6, 18, 44, 46, 51 AND 52).

SN 76-202,794. COLOPLAST A/S, DK-3050 HUMLEBAEK, DENMARK, FILED 1-30-2001.

AMIVIA

PRIORITY CLAIMED UNDER SEC. 44(D) ON UNITED KINGDOM APPLICATION NO. 2.246.191, FILED 9-20-2000, REG. NO. 2246191, DATED 9-20-2000, EXPIRES 9-20-2010.

FOR MEDICAL AND SURGICAL WOUND DRESSINGS, MEDICAL AND SURGICAL WOUND FILLER IN THE FORM OF ROPE, RIBBON, PASTE OR WADDING (U.S. CLS. 6, 18, 44, 46, 51 AND 52).

CLASS 5—(Continued).

SN 76-227,582. SAGMEL, INC., LIBERTYVILLE, IL. FILED 3-16-2001.

SAGMEL

FOR OVER-THE-COUNTER PHARMACEUTICAL PREPARATIONS NAMELY, ANTACIDS, ANALGESICS, COUGH AND COLD PRODUCTS, VITAMINS AND NUTRITIONAL SUPPLEMENTS, ANTIHEMMORHOIDAL AND CARDIOVASCULAR PRODUCTS (U.S. CLS. 6, 18, 44, 46, 51 AND 52).

SN 76-243,488. PFIZER INC., NEW YORK, NY. FILED 4-19-2001.

ENVACAR

OWNER OF U.S. REG. NO. 778,085.
FOR PHARMACEUTICAL PREPARATIONS FOR THE TREATMENT OF CARDIOVASCULAR DISEASE, CENTRAL NERVOUS SYSTEM DISEASES AND DISORDERS, NEUROLOGICAL DISORDERS, UROLOGICAL DISORDERS, URINARY DISORDERS, GASTROINTESTINAL DISORDERS, MUSCULOSKELETAL DISORDERS, ALZHEIMER'S, DIABETES, HYPERTENSION, ERECTILE DYSFUNCTION, SEXUAL DYSFUNCTION, STROKE, CANCER, MIGRAINES, PAIN, OBESITY, INFLAMMATION AND INFLAMMATORY DISEASES, RESPIRATORY AND INFECTIOUS DISEASES, AND IMMUNOLOGICAL, BACTERIAL, VIRAL AND FUNGAL DISORDERS; PHARMACEUTICAL PREPARATIONS, NAMELY, CHOLESTEROL PREPARATIONS, SMOKING CESSATION PREPARATIONS, TISSUE AND SKIN REPAIR PREPARATIONS, DERMATOLOGICAL PREPARATIONS, AND GYNECOLOGICAL PREPARATIONS (U.S. CLS. 6, 18, 44, 46, 51 AND 52).

SN 76-265,020. NEUROBIOLOGICAL TECHNOLOGIES, INC., RICHMOND, CA. FILED 5-30-2001.

XERECEPT

FOR PHARMACEUTICAL PREPARATIONS FOR THE TREATMENT OF EDEMAS (U.S. CLS. 6, 18, 44, 46, 51 AND 52).

SN 76-284,283. S. C. JOHNSON & SON, INC., RACINE, WI. FILED 7-12-2001.

PRESS 'N FRESH

FOR AIR FRESHENERS (U.S. CLS. 6, 18, 44, 46, 51 AND 52).

CLASS 5—(Continued).

SN 76-285,102. AGRO LOGISTIC SYSTEMS, INC., DIAMOND BAR, CA. FILED 7-16-2001.

ECOSIDE

FOR PEST CONTROL CHEMICAL FOR HOME, GARDEN, LAWN, AND TURF USE (U.S. CLS. 6, 18, 44, 46, 51 AND 52).

SN 76-291,952. SNEEZE FORMULA, INC., PHOENIX, AZ. FILED 7-26-2001.

DR. HARRIS' ORIGINAL ALLERGY FORMULA

NO CLAIM IS MADE TO THE EXCLUSIVE RIGHT TO USE "ORIGINAL ALLERGY FORMULA", APART FROM THE MARK AS SHOWN.

"DR. HARRIS" IS THE NAME OF A LIVING INDIVIDUAL WHOSE CONSENT IS OF RECORD.

FOR NATURAL ORGANIC AND HERBAL SUPPLEMENTS TO RELIEVE ALLERGIC AND SINUS SYMPTOMS (U.S. CLS. 6, 18, 44, 46, 51 AND 52).

FIRST USE 12-10-1996; IN COMMERCE 12-10-1996.

SN 76-301,564. VIRTUAL IMAGING CONSULTANTS OF AMERICA, LLC, MINEOLA, NY. FILED 8-20-2001.

EZ PREP

NO CLAIM IS MADE TO THE EXCLUSIVE RIGHT TO USE "PREP", APART FROM THE MARK AS SHOWN.

FOR KITS FOR USE PRIOR TO RADIOGRAPHIC EXAMINATION OF HUMAN ANATOMY PRIMARILY COMPRISED OF PHARMACEUTICAL PREPARATIONS, MEDICALLY RESTRICTED FOODS AND INFORMATION PAMPHLETS FOR USE IN CONNECTION THEREWITH (U.S. CLS. 6, 18, 44, 46, 51 AND 52).

SN 76-312,501. CAROL BOND HEALTH FOODS, INC., LIBERTY, TX. FILED 9-14-2001.

THISTLEX

FOR DIETARY AND NUTRITIONAL SUPPLEMENTS (U.S. CLS. 6, 18, 44, 46, 51 AND 52).

FIRST USE 8-31-2001; IN COMMERCE 8-31-2001.

CLASS 5—(Continued).

SN 76-322,990. GARY NULL & ASSOCIATES, INC., NEW YORK, NY. FILED 10-9-2001.

GARY NULL'S BIO AVAILABLE QUERCETIN

OWNER OF U.S. REG. NOS. 1,339,984, 2,340,776 AND OTHERS.

NO CLAIM IS MADE TO THE EXCLUSIVE RIGHT TO USE "BIO AVAILABLE QUERCETIN", APART FROM THE MARK AS SHOWN.

THE NAME "GARY NULL" IDENTIFIES A LIVING INDIVIDUAL WHOSE CONSENT IS OF RECORD.

FOR NUTRITIONAL SUPPLEMENTS, VITAMINS, MINERAL SUPPLEMENTS, HERBAL EXTRACTS FOR USE AS NUTRITIONAL SUPPLEMENTS, AND BEVERAGE MIXTURES, NAMELY, NUTRITIONAL DRINK MIXES FOR USE AS MEAL REPLACEMENTS (U.S. CLS. 6, 18, 44, 46, 51 AND 52).

SN 76-323,438. PLANET BABY. INC., BOULDER, CO. FILED 10-9-2001.

PLANET BABY

NO CLAIM IS MADE TO THE EXCLUSIVE RIGHT TO USE "BABY", APART FROM THE MARK AS SHOWN.

FOR BABY FOOD (U.S. CLS. 6, 18, 44, 46, 51 AND 52).

SN 76-325,948. CERES FERTILITY, SAN DIEGO, CA. FILED 10-10-2001.

OvuSure

FOR IN-VITRO OVULATION PREDICTION TEST KIT (U.S. CLS. 6, 18, 44, 46, 51 AND 52).

SN 76-328,667. MAKHTESHIM-AGAN OF NORTH AMERICA INC., NEW YORK, NY. FILED 10-23-2001.

ARAVA

FOR NON-AGRICULTURAL HERBICIDES FOR USE ON RAILROADS AND INDUSTRIAL RIGHTS OF WAY (U.S. CLS. 6, 18, 44, 46, 51 AND 52).

CLASS 5—(Continued).

SN 76-328,690. DOW AGROSCIENCES LLC, INDIANAPOLIS, IN. FILED 10-19-2001.

GOVERN

FOR PESTICIDES AND PREPARATIONS FOR DESTROYING VERMIN, NAMELY HERBICIDES, INSECTICIDES AND FUNGICIDES FOR USE IN AGRICULTURE, HORTICULTURE, FORESTRY, TURF AND ORNAMENTAL, COMMERCIAL, INDUSTRIAL AND DOMESTIC APPLICATIONS (U.S. CLS. 6, 18, 44, 46, 51 AND 52).

SN 76-336,814. GREAT LAKES PRODUCTS, INC., INDIANAPOLIS, IN. FILED 11-13-2001.

JUNGLE JUICE

FOR AIR FRESHENER (U.S. CLS. 6, 18, 44, 46, 51 AND 52).

SN 76-339,901. ASPEN VETERINARY RESOURCES, LTD., GREELEY, CO. FILED 11-19-2001.

FLUMAX

FOR INJECTABLE ANTI-INFLAMMATORY PHARMACEUTICAL FOR LIVESTOCK (U.S. CLS. 6, 18, 44, 46, 51 AND 52).

SN 76-340,038. 9068-8409 QUEBEC INC., AKA P.M.B. INTERNATIONAL, LAVAL QUEBEC, CANADA, FILED 11-19-2001.

MICRO-CAL

FOR FOOD SUPPLEMENTS (U.S. CLS. 6, 18, 44, 46, 51 AND 52).

CLASS 5—(Continued).

SN 76-340,930. ZIAJA LTD. ZAKLAD PRODUKCJI LEKOW SPOLKA Z O.O., GDANSK 80-298, POLAND, FILED 11-23-2001.

Luk

FOR MEDICATED HAIR PREPARATIONS, NAMELY, MEDICATED SHAMPOOS, DANDRUFF SHAMPOOS, CONDITIONERS, LOTIONS; MEDICATED SKIN CARE PREPARATIONS, NAMELY, CREAMS, BALMS, CLEANSERS, TONIC LOTIONS, MASKS, MILKS, GELS, POWDERS; ANTIBACTERIAL PHARMACEUTICALS, ANTIBACTERIAL WASHES; SANITARY PRODUCTS, NAMELY, SANITARY SPRAYS; MEDICATED DENTIFRICES, NAMELY, TOOTH GELS, TOOTH PASTES, MOUTH WASHES (U.S. CLS. 6, 18, 44, 46, 51 AND 52).
FIRST USE 3-31-1998; IN COMMERCE 11-30-2000.

SN 76-345,694. RAND, WILLOW, DALLAS, TX. FILED 12-6-2001.

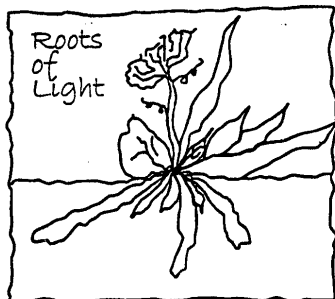

OWNER OF U.S. REG. NO. 2,461,449.
THE COLORS OF THE MARK ARE AS FOLLOWS: THE FLOWER IN THE DESIGN, WHICH APPEARS TO BE UPRIGHT, OPENING TO THE LEFT IS PINK, WITH A GREEN STEM. BEGINNING WITH THE FOLIAGE TO THE RIGHT OF THE FLOWER, GOING CLOCKWISE, THE FIRST LEAF IS BLUE, NEXT THERE IS A SHORT GREEN LEAF. THE REST OF THE LEAVES ARE YELLOW, RED, PURPLE, GREEN, RED, ORANGE, RED, BLUE, YELLOW, AND THE LEAF LOCATED TO THE LEFT OF THE FLOWER IS GREEN.

FOR HERBAL SUPPLEMENTS (U.S. CLS. 6, 18, 44, 46, 51 AND 52).
FIRST USE 8-0-1993; IN COMMERCE 8-0-1993.

SN 76-345,816. MALIBU NATURALS, L.L.C., CANTON, OH. FILED 12-7-2001.

GS-EXTRA

FOR DIETARY SUPPLEMENTS (U.S. CLS. 6, 18, 44, 46, 51 AND 52).
FIRST USE 10-1-2001; IN COMMERCE 10-1-2001.

CLASS 5—(Continued).

SN 78-022,733. BOEHRINGER INGELHEIM PHARMACEUTICALS, INC., RIDGEFIELD, CT. FILED 8-24-2000.

OXYGEN FOR A HEALTHY BRAIN

FOR DIETARY SUPPLEMENTS, NAMELY DIETARY SUPPLEMENTS CONTAINING EXTRACT OF GINKGO BILOBA, EITHER ALONE OR IN COMBINATION WITH EXTRACT OF GINSENG (U.S. CLS. 6, 18, 44, 46, 51 AND 52).

SN 78-038,375. SYNGENTA PARTICIPATIONS AG, BASEL, SWITZERLAND, FILED 12-8-2000.

HELIX XTRA

FOR SEED TREATMENT PESTICIDES FOR AGRICULTURAL USE (U.S. CLS. 6, 18, 44, 46, 51 AND 52).

SN 78-038,967. NUTRICIA INTERNATIONAL B.V., ZOETERMEER, NETHERLANDS, FILED 12-12-2000.

TENTRINI

FOR PHARMACEUTICAL PRODUCTS, NAMELY, LIQUID FOOD FOR ENTERAL FEEDING; PHARMACEUTICAL PREPARATIONS FOR USE IN THE TREATMENT OF UNDERNUTRITION, MALNUTRITION, ANOREXIA, AND/OR DEHYDRATION; FOOD SUPPLEMENTS; VITAMINS; DIETICS AND FORTIFYING SUBSTANCES ADOPTED FOR MEDICAL USE, NAMELY, USE, LIQUID FOOD DRINKS; FOOD FOR BABIES, INFANTS AND INVALIDS (U.S. CLS. 6, 18, 44, 46, 51 AND 52).

SN 78-044,623. BRISTOL-MYERS SQUIBB COMPANY, NEW YORK, NY. FILED 1-24-2001.

SPRIZEL

FOR PHARMACEUTICAL PREPARATIONS FOR THE TREATMENT OF CARDIOVASCULAR DISEASES, CENTRAL NERVOUS SYSTEM DISEASES AND DISORDERS, STROKE, CANCER, INFLAMMATION AND INFLAMMATORY DISEASES, RESPIRATORY AND INFECTIOUS DISEASES AND AUTO-IMMUNE DISEASES (U.S. CLS. 6, 18, 44, 46, 51 AND 52).

CLASS 5—(Continued).

SN 78-045,642. PHARMACIA CORPORATION, PEAPACK, NJ. FILED 1-30-2001.

PARUS

FOR PHARMACEUTICAL PREPARATIONS FOR THE TREATMENT OF ARTHRITIS, PAIN, INFLAMMATION, CARDIOVASCULAR DISEASES, ONCOLOGY, OPHTHALMOLOGICAL CONDITIONS, CENTRAL NERVOUS SYSTEM DISORDERS (U.S. CLS. 6, 18, 44, 46, 51 AND 52).

SN 78-046,393. NATURAL CARE PRODUCTS, INC., ENGLEWOOD, FL. FILED 2-2-2001.

SOYSEED

FOR SOY-BASED NUTRITIONAL SUPPLEMENT AND FLAXSEED SOLD AS A PACKAGED COMBINATION (U.S. CLS. 6, 18, 44, 46, 51 AND 52).

SN 78-057,778. WANG, JONATHAN HWAN, FREMONT, CA. FILED 4-10-2001.

ALLERTEA

FOR HEALTH PRODUCTS AND HERBAL TEA PRODUCTS, NAMELY, HERBAL TEAS FOR MEDICINAL PURPOSES (U.S. CLS. 6, 18, 44, 46, 51 AND 52).

SN 78-058,595. NOVARTIS AG, BASEL, SWITZERLAND, FILED 4-16-2001.

ZORTRESS

PRIORITY CLAIMED UNDER SEC. 44(D) ON SWITZERLAND APPLICATION NO. 02696/2001, FILED 3-15-2001, REG. NO. 483099, DATED 3-15-2001, EXPIRES 3-15-2011.

FOR PHARMACEUTICAL PREPARATIONS FOR THE TREATMENT OF DISORDERS OF THE CENTRAL NERVOUS SYSTEM, THE IMMUNE SYSTEM, THE CARDIO-VASCULAR SYSTEM, THE RESPIRATORY SYSTEM, THE MUSCULO-SKELETAL SYSTEM, FOR THE TREATMENT OF INFLAMMATORY DISORDERS, AND FOR USE IN DERMATOLOGY ONCOLOGY, AND OPHTHALMOLOGY (U.S. CLS. 6, 18, 44, 46, 51 AND 52).

SN 78-058,958. BAUM KENNETH E, DANA POINT, CA. FILED 4-18-2001.

BIO DYNAMICS

FOR NUTRITIONAL SUPPLEMENTS (U.S. CLS. 6, 18, 44, 46, 51 AND 52).
FIRST USE 2-1-2001; IN COMMERCE 2-1-2001.

CLASS 5—(Continued).

SN 78-061,608. BERTEK PHARMACEUTICALS INC., MORGANTOWN, WV. FILED 5-2-2001.

SEBATE

FOR PHARMACEUTICAL PREPARATION FOR USE IN THE TREATMENT OF SEVERE RECALCITRANT NODULAR ACNE (U.S. CLS. 6, 18, 44, 46, 51 AND 52).

SN 78-068,754. MICHEL GRISE CONSULTANT INC., SAINTE-JULIE QUEBEC, CANADA, FILED 6-12-2001.

AGRUMAX

FOR FOOD SUPPLEMENT WITH GERMICIDAL AND ANTIVIRAL PROPERTIES, NAMELY CITRUS SEED EXTRACTS (U.S. CLS. 6, 18, 44, 46, 51 AND 52).

SN 78-081,810. AVENTIS PHARMACEUTICALS INC., BRIDGEWATER, NJ. FILED 8-30-2001.



OWNER OF U.S. REG. NOS. 781,684, 2,048,348 AND OTHERS.

NO CLAIM IS MADE TO THE EXCLUSIVE RIGHT TO USE "ONE WITH BREAKFAST" AND "ONE WITH DINNER", APART FROM THE MARK AS SHOWN.

THE MARK CONSISTS OF THE STYLIZED WORDS "ONE WITH BREAKFAST OS-CAL ONE WITH DINNER" AND THE DESIGN OF A SUN/STAR AND MOON ON AN ORBIT.

FOR VITAMIN AND MINERAL SUPPLEMENTS (U.S. CLS. 6, 18, 44, 46, 51 AND 52).

SN 78-082,423. SMITHKLINE BEECHAM P.L.C., BRENTFORD, MIDDLESEX, UNITED KINGDOM, FILED 9-4-2001.

CORSODYL

OWNER OF UNITED KINGDOM REG. NO. 1031766, DATED 6-28-1974, EXPIRES 6-28-2005.

FOR PHARMACEUTICAL PREPARATIONS FOR USE IN THE CARE AND TREATMENT OF THE TEETH, GUMS AND MOUTH (U.S. CLS. 6, 18, 44, 46, 51 AND 52).

CLASS 5—(Continued).

SN 78-089,870. FERGUSON, JEREL, SCOTT, SAN DIEGO, CA. FILED 10-24-2001.

YOHIMBURN

FOR DIETARY SUPPLEMENT IN THE NATURE OF A TOPICAL PEPPERMINT, ALOE, GLYCERIN AND YOHIMBINE SOLUTION FOR LOCALIZED FAT BURNING (U.S. CLS. 6, 18, 44, 46, 51 AND 52).

FIRST USE 9-1-2001; IN COMMERCE 9-1-2001.

SN 78-091,882. SYNGENTA PARTICIPATIONS AG, BASEL, SWITZERLAND, FILED 11-6-2001.

ENGE0

FOR INSECTICIDE(S) FOR AGRICULTURAL, DOMESTIC AND COMMERCIAL USE (U.S. CLS. 6, 18, 44, 46, 51 AND 52).

SN 78-091,922. VITA CUBE SYSTEMS, INC., DENVER, CO. FILED 11-6-2001.

THE POWER OF SCIENCE

FOR DIETARY SUPPLEMENTS IN THE FORM OF TABLETS, CAPSULES, LIQUIDS, POWDERS, AND BARS (U.S. CLS. 6, 18, 44, 46, 51 AND 52).

SN 78-094,551. PFIZER INC, MORRIS PLAINS, NJ. FILED 11-21-2001.

QUESPRI

FOR PHARMACEUTICAL PREPARATIONS FOR THE TREATMENT OF CARDIOVASCULAR DISEASE, CENTRAL NERVOUS SYSTEM DISEASES AND DISORDERS, NEUROLOGICAL DISORDERS, UROLOGICAL DISORDERS, GASTROINTESTINAL DISORDERS, MUSCULOSKELETAL DISORDERS, ALLERGIES, DIABETES, HYPERTENSION, ERECTILE DYSFUNCTION, SEXUAL DYSFUNCTION, STROKE, CANCER, MIGRAINES, PAIN, INFLAMMATION AND INFLAMMATORY DISEASES, RESPIRATORY AND INFECTIOUS DISEASES, AND IMMUNOLOGICAL, BACTERIAL, VIRAL AND FUNGAL DISORDERS; PHARMACEUTICAL PREPARATIONS FOR THE TREATMENT OF GENERAL ANXIETY AND PANIC DISORDERS (U.S. CLS. 6, 18, 44, 46, 51 AND 52).

SN 78-094,595. ICN PHARMACEUTICALS, INC., COSTA MESA, CA. FILED 11-21-2001.

ANCOBON

FOR ANTIFUNGAL PREPARATION (U.S. CLS. 6, 18, 44, 46, 51 AND 52).

FIRST USE 4-18-1969; IN COMMERCE 4-18-1969.

CLASS 5—(Continued).

SN 78-096,503. WARNER-LAMBERT COMPANY, MORRIS PLAINS, NJ. FILED 12-4-2001.

NEOSPORIN LT

OWNER OF U.S. REG. NO. 572,764.
FOR PREPARATION FOR THE TREATMENT OF COLD SORES AND DRY OR CHAPPED LIPS (U.S. CLS. 6, 18, 44, 46, 51 AND 52).

SN 78-096,510. GIL PHARMACEUTICAL CORP., PONCE, PUERTO RICO, FILED 12-4-2001.

GILTUSS

FOR PHARMACEUTICAL FORMULATION FOR COLD AND COUGH (U.S. CLS. 6, 18, 44, 46, 51 AND 52).

SN 78-096,576. MEDTECH PRODUCTS, INC., NORWALK, CT. FILED 12-4-2001.

ARTHX

OWNER OF U.S. REG. NOS. 2,367,470 AND 2,367,471.
FOR DIETARY SUPPLEMENTS (U.S. CLS. 6, 18, 44, 46, 51 AND 52).

CLASS 6—METAL GOODS

SN 75-547,684. TAIWAN FU HSING INDUSTRY CO., LTD., KAOHSIUNG HSIEN, TAIWAN, FILED 9-3-1998.

LEGACY

FOR LOCK-SET, DOOR LOCK, CYLINDRICAL LOCK, LEVER LOCK, TUBULAR LOCK, LOCK CORE, KEY, AUTOMOBILE LOCK, ALL MADE OF METAL (U.S. CLS. 2, 12, 13, 14, 23, 25 AND 50).

CLASS 6—(Continued).

SN 75-939,666. NICHOLS, BRAD, ALBERTA, TOE 1N0, CANADA, FILED 3-9-2000.

BRADBUILT 24

PRIORITY CLAIMED UNDER SEC. 44(D) ON CANADA APPLICATION NO. 1028967, FILED 9-15-1999, REG. NO. TMA549,121, DATED 8-1-2001, EXPIRES 8-1-2016.

NO CLAIM IS MADE TO THE EXCLUSIVE RIGHT TO USE "24", APART FROM THE MARK AS SHOWN.

FOR HAND-OPERATED METAL HOSE WINDING REELS USED TO STORE INDUSTRIAL AND FIRE-FIGHTING HOSES AND HOSES USED FOR AIR, WATER, OIL, GREASE, OR CHEMICALS (U.S. CLS. 2, 12, 13, 14, 23, 25 AND 50).

SN 75-942,292. A. FINKL & SONS CO., CHICAGO, IL. FILED 3-13-2000.

RA40

FOR ALLOY STEEL IN ROD, BAR AND BLOCK FORM (U.S. CLS. 2, 12, 13, 14, 23, 25 AND 50).
FIRST USE 11-30-1997; IN COMMERCE 11-30-1997.

SN 75-943,160. TETRA LAVAL HOLDINGS & FINANCE S.A., CH-1009 PULLY, SWITZERLAND, FILED 3-14-2000.

TETRA ALSAFE

FOR EQUIPMENT FOR ASEPTIC STORAGE OF LIQUID FOOD PRODUCTS, NAMELY METAL TANKS (U.S. CLS. 2, 12, 13, 14, 23, 25 AND 50).

SN 76-001,747. CDS NU-STEEL PTY LTD, IN THE STATE OF QUEENSLAND, AUSTRALIA, FILED 3-16-2000.



PRIORITY CLAIMED UNDER SEC. 44(D) ON AUSTRALIA APPLICATION NO. 821,250, FILED 1-25-2000, REG. NO. 821250, DATED 1-25-2000, EXPIRES 1-25-2010.

NO CLAIM IS MADE TO THE EXCLUSIVE RIGHT TO USE "HOMES", APART FROM THE MARK AS SHOWN.

FOR METAL BUILDING CONSTRUCTION MATERIALS, NAMELY, STEEL FRAME WORKS, STEEL KIT FORM BUILDINGS AND BUILDING CONSTRUCTION SYSTEMS, ROOFING, ROOFING ASSEMBLIES AND COMPONENTS THEREFOR, ALL CLADDING, FLOORING AND FLOORING ASSEMBLIES AND COMPONENTS THEREFOR, BEAMS, BOX SPANS, STRUCTURAL MEMBERS, WALL PANELS, DOORS AND WINDOWS (U.S. CLS. 2, 12, 13, 14, 23, 25 AND 50).

CLASS 6—(Continued).

SN 76-081,091. ACME CASTINGS, INC., HUNTINGTON PARK, CA. FILED 6-28-2000.



NO CLAIM IS MADE TO THE EXCLUSIVE RIGHT TO USE "CASTINGS, INC.", APART FROM THE MARK AS SHOWN.

FOR METAL CASTINGS (U.S. CLS. 2, 12, 13, 14, 23, 25 AND 50).

FIRST USE 5-1-2000; IN COMMERCE 5-1-2000.

SN 76-138,622. CORNELIUS INDUSTRIES INC., ST. CATHERINES, ON L2M 6S7, CANADA, FILED 10-2-2000.



NO CLAIM IS MADE TO THE EXCLUSIVE RIGHT TO USE "HOME", APART FROM THE MARK AS SHOWN.

FOR METAL SWIMMING POOLS WITH FITTED VINYL LINERS THEREFOR SOLD TOGETHER AS A UNIT (U.S. CLS. 2, 12, 13, 14, 23, 25 AND 50).

FIRST USE 0-0-1997; IN COMMERCE 0-0-1997.

SN 76-146,362. TSHIELD, INC., PALM BEACH GARDENS, FL. FILED 10-16-2000.



THE MARK IS LINED FOR COLOR RED.
FOR METAL GOODS USED IN WALL CONSTRUCTION, NAMELY METAL EDGE FRAMES FITTED ON WALL BASES TO PROTECT WALLS AGAINST THE ENVIRONMENT AND INSECTS (U.S. CLS. 2, 12, 13, 14, 23, 25 AND 50).

FIRST USE 3-21-2000; IN COMMERCE 3-21-2000.

CLASS 6—(Continued).

SN 76-161,289. U.S. FENCE, LLC, MIDDLEBURG HEIGHTS, OH. FILED 11-7-2000.



NO CLAIM IS MADE TO THE EXCLUSIVE RIGHT TO USE "VINYL POST HARDWARE" AND "MOUNT A VINYL POST TO ANY SURFACE", APART FROM THE MARK AS SHOWN.

THE LINING SHOWN IN THE DRAWING IS A FEATURE OF THE MARK AND IS NOT INTENDED TO INDICATE COLOR.

FOR METAL HARDWARE FOR VINYL FENCE POSTS, NAMELY, MOUNTS FOR POSTS (U.S. CLS. 2, 12, 13, 14, 23, 25 AND 50).

SN 76-172,924. COPPIL GROUP, LLC, GREENBRIAR, TN. FILED 11-29-2000.

E-Z OUT KEY CHAIN

NO CLAIM IS MADE TO THE EXCLUSIVE RIGHT TO USE "KEY CHAIN", APART FROM THE MARK AS SHOWN.

FOR METAL KEY CHAINS (U.S. CLS. 2, 12, 13, 14, 23, 25 AND 50).

SN 76-176,193. O'BRIEN BRASS COMPANY, TWINSBURG, OH. FILED 12-5-2000.

OB

FOR BRASS FITTINGS FOR HYDRAULIC AND PNEUMATIC SYSTEMS IN THE AUTOMOTIVE AND INDUSTRIAL FIELDS (U.S. CLS. 2, 12, 13, 14, 23, 25 AND 50).

FIRST USE 12-5-2000; IN COMMERCE 12-5-2000.

CLASS 6—(Continued).

SN 76-189,914. THOMAS & BETTS INTERNATIONAL, INC., SPARKS, NV. FILED 1-4-2001.

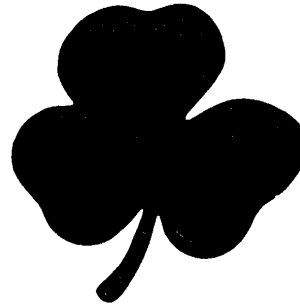

FOR METAL PIPE AND CONDUIT FITTINGS FOR USE IN BUILDING CONSTRUCTION; METAL ELBOWS FOR PIPES FOR USE IN BUILDING CONSTRUCTION (U.S. CLS. 2, 12, 13, 14, 23, 25 AND 50).

FIRST USE 0-0-1984; IN COMMERCE 0-0-1984.

SN 76-200,715. STEEL KING INDUSTRIES, INC., STEVENS POINT, WI. FILED 1-26-2001.

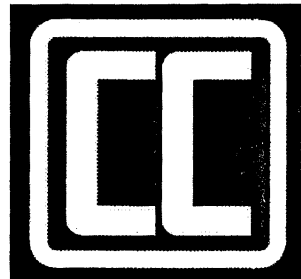

FOR COLUMN REINFORCEMENTS FOR METAL RACKS USED TO STORE INDUSTRIAL GOODS (U.S. CLS. 2, 12, 13, 14, 23, 25 AND 50).

FIRST USE 6-0-2000; IN COMMERCE 6-0-2000.

SN 76-205,619. VOEST-ALPINE SCHIENEN GMBH & CO. KG, A-8700 LOEBEN, AUSTRIA, FILED 2-6-2001.

DOBAIN

PRIORITY CLAIMED UNDER SEC. 44(D) ON AUSTRIA APPLICATION NO. 5924/2000, FILED 8-14-2000, REG. NO. 193147, DATED 1-5-2001, EXPIRES 1-5-2011.

FOR METAL RAILS AND SPECIALTY ALLOY RAILS (U.S. CLS. 2, 12, 13, 14, 23, 25 AND 50).

CLASS 6—(Continued).

SN 76-215,790. MARKO DOORS & GATES, INC., WEST PALM BEACH, FL. FILED 2-26-2001.



NO CLAIM IS MADE TO THE EXCLUSIVE RIGHT TO USE "STORM SECURITY BRACE", APART FROM THE MARK AS SHOWN.

FOR METAL GARAGE DOOR BRACING HARDWARE, NAMELY, STRUTS, POSTS, ANCHORS, HINGES, TRACK JAM BRACKETS, TOP BRACKETS, BOTTOM BRACKETS, PIN ANGLES, RETAINERS, GUIDES AND CLIPS (U.S. CLS. 2, 12, 13, 14, 23, 25 AND 50).

FIRST USE 12-1-1996; IN COMMERCE 1-1-1997.

CLASS 6—(Continued).

NAMELY WIRE ROPE CLIPS, WIRE ROPE THIMBLES, CLOTHESLINE HOOKS; METAL CUP HOOKS; METAL EYE BOLTS; METAL GATE HOOKS AND EYES; METAL S-HOOKS; METAL SCREW EYES; METAL SCREW HOOKS; METAL SWAG HOOKS; METAL TURN-BUCKLES; METAL U-BOLTS; PICTURE HANGERS AND ACCESSORIES, NAMELY METAL D-RINGS, HARD WALL HANGERS, MOLDING HOOKS, PLATE HANGERS, PUSH-IN HOOKS, PUSH PINS, SAFETY CUP HOOKS, SAFETY MUG HOOKS, SCREW EYES OVAL, SUCTION CUP WITH HOOKS, UTILITY HANGERS, ANGLE DRIVE HANGERS, PICTURE FRAME SPENDERS, SELF LEVELERS, PICTURE FRAME RINGS; METAL WIRE; METAL PICTURE WIRE, NAMELY COPPER WIRE AND GALVANIZED WIRE; NAILS; METAL TACKS; METAL BRADS; METAL COTTER PINS; METAL PIPE CLIPS; METAL PULLEYS; METAL CHAIN; METAL BARS AND METAL TUBULAR EXTRUSIONS OF VARIOUS CROSS-SECTIONAL SHAPES FOR FURTHER MANUFACTURE AND METAL PIPES (U.S. CLS. 2, 12, 13, 14, 23, 25 AND 50).

SN 76-239,251. MOONLIGHT PUBLISHING, INC., PORTLAND, OR. FILED 4-12-2001.



MOONLIGHT DESIGNS

SN 76-238,682. CROWN BOLT, INC., CERRITOS, CA. FILED 4-10-2001.



NO CLAIM IS MADE TO THE EXCLUSIVE RIGHT TO USE "PRO CONSTRUCTION PRODUCTS", APART FROM THE MARK AS SHOWN.

FOR FASTENERS MADE OF METAL, NAMELY, THREADED FASTENERS, NUTS, BOLTS, SCREWS, WASHERS, ANCHORS, AUGUR ANCHORS, TOGGLE BOLTS, LAG SHIELDS, PINS, TACKS AND BRADS, METAL CHAINS; METAL HARDWARE, NAMELY, PULLEYS, METAL RINGS; METAL CHAIN ACCESSORIES, NAMELY, ANCHOR SHACKLES, CLEVIS GRAB HOOKS, CLEVIS SLIP HOOKS, ROPE HOOKS, FIXED EYE SAFETY HOODS, CONNECTING LINKS, QUICK LINKS, REPAIR LINKS, SNAPS, DOUBLE CAP SNAPS, DOUBLE END BOLT SNAPS, OPEN EYE BOLT SNAPS, SWIVELS, OPEN EYE CHAIN SWIVEL, ROUND EYE DOUBLE SWIVEL, STRAP EYE DOUBLE SWIVEL, OPEN EYE SWIVEL BOLT SNAP, OPEN EYE SWIVEL SPRING SNAP, QUICK RELEASE SWIVEL ROUND EYE, ROUND EYE BOLT SNAP, ROUND EYE QUICK SNAP, ROUND EYE SWIVEL BOLT SNAP, ROUND EYE SWIVEL QUICK SNAP, ROUND EYE SWIVEL SPRING SNAP, ROUND EYE TRIGGER SWIVEL SNAP, SPRING STRAP EYE SWIVEL SNAP, STRAP EYE BOLT SNAP, STRAP EYE SPRING SNAP, SWIVEL CAP SNAP ROUND EYE, SWIVEL SPRING SNAP ROUND EYE, SWIVEL STRAP BOLT SNAP SQUARE EYE, SHACKLES, SWIVEL SNAP SHACKLE, SCREW PIN SHACKLE, SNAP BUTTON, SWAGE SLEEVE FITTING, SNAP LINKS, WIRE EYE STRAP; WIRE ROPE AND ACCESSORIES,

NO CLAIM IS MADE TO THE EXCLUSIVE RIGHT TO USE "DESIGNS", APART FROM THE MARK AS SHOWN.

FOR CONTAINERS, NAMELY, GENERAL PURPOSE METAL STORAGE BINS (U.S. CLS. 2, 12, 13, 14, 23, 25 AND 50).

SN 76-240,541. VAUGHN, RICHARD S., BURLINGTON, NC. AND MOSER, ERIC P., BURLINGTON, NC. FILED 4-11-2001.

DRAFTSTOPPER

FOR METAL FOLDABLE AND CLOSABLE STAIRWAYS (U.S. CLS. 2, 12, 13, 14, 23, 25 AND 50).

SN 76-241,689. MINERA ESCONDIDA LTDA., SANTIAGO, CHILE, FILED 4-6-2001.

ESOX

FOR COPPER PRODUCED BY SULFURIC ACID LEACHING, SOLVENT EXTRACTION AND ELECTROWINNING FOR GENERAL MANUFACTURING USES (U.S. CLS. 2, 12, 13, 14, 23, 25 AND 50).

CLASS 6—(Continued).

SN 76-250,304. BALDWIN HARDWARE CORPORATION, READING, PA. FILED 5-3-2001.

ASTORIA

FOR METAL DOOR HARDWARE, NAMELY LOCKS, LATCHES, HINGES AND KICKPLATES (U.S. CLS. 2, 12, 13, 14, 23, 25 AND 50).

SN 76-255,174. SAF T SIGNS, FREELAND, MI. FILED 5-11-2001.

EVOLUTION

FOR METAL TREE STEPS, METAL TREE STEP SUPPORTS, METAL TREE STANDS FOR HUNTERS, METAL SUPPORTS FOR TREE STANDS FOR HUNTERS, METAL SUPPORTS FOR ARCHERY EQUIPMENT, METAL SUPPORTS FOR FIRE ARMS, AND METAL SUPPORTS FOR CAMOUFLAGE ELEMENTS, NAMELY, PORTABLE ENCLOSURES AND PORTABLE ROOFS (U.S. CLS. 2, 12, 13, 14, 23, 25 AND 50).

SN 76-274,521. BOBBYBOX, LLC, WICHITA, KS. FILED 6-21-2001.



FOR MAIL BOXES AND CONTAINERS MADE OF METAL FOR HOLDING MAIL AND PACKAGES (U.S. CLS. 2, 12, 13, 14, 23, 25 AND 50).

SN 76-307,098. BETTER WIRE PRODUCTS, INC., BUFFALO, NY. FILED 8-30-2001.



FOR FABRICATED METAL WIRE FORMS, NAMELY STACKING WIRES, MULCH PINS AND SOD STAPLES, (U.S. CLS. 2, 12, 13, 14, 23, 25 AND 50).
FIRST USE 4-4-2000; IN COMMERCE 4-4-2000.

CLASS 6—(Continued).

SN 76-320,490. EDGEWATER MFG. CO., INC., WESTWOOD, NJ. FILED 10-3-2001.



NO CLAIM IS MADE TO THE EXCLUSIVE RIGHT TO USE "USA", APART FROM THE MARK AS SHOWN.
FOR ELECTRICAL METAL PIPE FITTINGS (U.S. CLS. 2, 12, 13, 14, 23, 25 AND 50).

SN 76-329,294. BWG BUTZBACHER WEICHENBAU GMBH, D-35510 BUTZBACH, FED REP GERMANY, FILED 10-24-2001.

FAKOP

OWNER OF FED REP GERMANY REG. NO. 2062821, DATED 4-20-1994, EXPIRES 10-22-2003.

FOR RAILWAY SUPERSTRUCTURES FORMED OF METAL, NAMELY RAILS, MANUALLY OPERATED SWITCHES, CROSSINGS, SLIDE CHAIRS, SWITCH CLAMPS, BLADE ROLLERS, FROG TIPS AND FEATHERED JOINTS (U.S. CLS. 2, 12, 13, 14, 23, 25 AND 50).

SN 76-335,989. SUMIDEN WIRE PRODUCTS CORPORATION, STOCKTON, CA. FILED 11-8-2001.

SWPC

OWNER OF U.S. REG. NO. 1,176,827.
FOR NON-ELECTRIC COATED AND UNCOATED MULTI STRAND AND SINGLE STRAND WIRE; NON-ELECTRIC COATED AND UNCOATED WIRE (U.S. CLS. 2, 12, 13, 14, 23, 25 AND 50).
FIRST USE 1-2-1980; IN COMMERCE 1-2-1980.

SN 76-337,986. BENECOR, INC., WICHITA, KS. FILED 11-14-2001.

BENEFLANGE

FOR LIGHTWEIGHT STRUCTURAL MATERIALS MADE OF METAL OR METAL MATRIX COMPOSITES, NAMELY, PANELS, CORES, AND HONEYCOMBS FOR USE IN FURTHER MANUFACTURE OF CONSTRUCTION (U.S. CLS. 2, 12, 13, 14, 23, 25 AND 50).

CLASS 6—(Continued).

SN 76-348,543. MASTER LOCK COMPANY, MILWAUKEE, WI. FILED 12-13-2001.

TRIUMPH

FOR METAL SECURITY LOCKS (U.S. CLS. 2, 12, 13, 14, 23, 25 AND 50).
FIRST USE 8-1-2001; IN COMMERCE 8-1-2001.

SN 78-049,425. EMHART INC., NEWARK, DE. FILED 2-21-2001.

KWIKSET ULTRA-MAX SECURITY

OWNER OF U.S. REG. NOS. 518,394, 1,646,595 AND OTHERS.

NO CLAIM IS MADE TO THE EXCLUSIVE RIGHT TO USE "SECURITY", APART FROM THE MARK AS SHOWN.

FOR METAL DOOR HARDWARE, NAMELY, KNOBS, LEVERS, LEVER SETS, HANDLES, HANDLE SETS, DEAD BOLTS, KEYS AND KEY BLANKS (U.S. CLS. 2, 12, 13, 14, 23, 25 AND 50).

SN 78-049,436. EMHART INC., NEWARK, DE. FILED 2-21-2001.

KWIKSET MAXIMUM SECURITY

OWNER OF U.S. REG. NOS. 518,394, 1,646,595 AND OTHERS.

NO CLAIM IS MADE TO THE EXCLUSIVE RIGHT TO USE "MAXIMUM SECURITY", APART FROM THE MARK AS SHOWN.

FOR METAL DOOR HARDWARE, NAMELY, KNOBS, LEVERS, LEVER SETS, HANDLES, HANDLE SETS, DEAD BOLTS, KEYS AND KEY BLANKS (U.S. CLS. 2, 12, 13, 14, 23, 25 AND 50).

SN 78-049,437. EMHART INC., NEWARK, DE. FILED 2-21-2001.

KWIKSET SECURITY

OWNER OF U.S. REG. NOS. 518,394, 1,646,595 AND OTHERS.

NO CLAIM IS MADE TO THE EXCLUSIVE RIGHT TO USE "SECURITY", APART FROM THE MARK AS SHOWN.

FOR METAL DOOR HARDWARE, NAMELY, KNOBS, LEVERS, LEVER SETS, HANDLES, HANDLE SETS, DEAD BOLTS, KEYS AND KEY BLANKS (U.S. CLS. 2, 12, 13, 14, 23, 25 AND 50).

CLASS 6—(Continued).

SN 78-064,966. MEDIEVAL PRODUCTIONS, CHESTER, NY. FILED 5-22-2001.



THE MARK CONSISTS OF A FLOWERING THISTLE PLANT BENEATH THE STYLIZED LETTERS "PP".

FOR ORIGINAL SCULPTURES MADE OF NON-PRECIOUS METALS, NAMELY, PEWTER (U.S. CLS. 2, 12, 13, 14, 23, 25 AND 50).

FIRST USE 8-4-1999; IN COMMERCE 8-4-1999.

CLASS 7—MACHINERY

SN 75-166,475. SANDVIK AB, S-811 81 SANDVIKEN, SWEDEN, FILED 9-13-1996.

ALPHA

FOR POWER OPERATED MACHINE TOOLS, NAMELY, DRILLS FOR CUTTING METAL IN INDUSTRIAL APPLICATIONS (U.S. CLS. 13, 19, 21, 23, 31, 34 AND 35).

FIRST USE 3-0-1983; IN COMMERCE 3-0-1983.

SN 75-422,962. MAGUIRE PRODUCTS, INC., MEDIA, PA. FILED 1-23-1998.

RADIAL

SEC. 2(F).

FOR MACHINES FOR GRINDING SOLID WASTE AND SCRAP PLASTIC INTO GRANULES FOR RECYCLING VIA MOLDING OR EXTRUSION (U.S. CLS. 13, 19, 21, 23, 31, 34 AND 35).

FIRST USE 5-20-1998; IN COMMERCE 5-20-1998.

CLASS 7—(Continued).

SN 75-540,710. FUCHSBICHLER, KEVIN JOHAN, BRUCE ROCK 6418, AUSTRALIA, FILED 8-21-1998.

GRANNI POT

OWNER OF AUSTRALIA REG. NO. 615128, DATED 10-29-1993, EXPIRES 10-29-2010.

NO CLAIM IS MADE TO THE EXCLUSIVE RIGHT TO USE "POT", APART FROM THE MARK AS SHOWN.

FOR MIXING AND DISSOLVING MACHINES FOR AGRICULTURAL AND/OR HORTICULTURAL USE, NAMELY, APPARATUS FOR MIXING AND DISSOLVING CHEMICALS AND/OR PARTICULATE MATERIALS AND PARTS AND ATTACHMENTS THEREFOR (U.S. CLS. 13, 19, 21, 23, 31, 34 AND 35).

SN 75-872,707. PRESSURE GUARD, PLANO, TX. FILED 12-14-1999.

PRESSUREGUARD

FOR MACHINES FOR PRESSURIZING PNEUMATIC TIRES (U.S. CLS. 13, 19, 21, 23, 31, 34 AND 35).

SN 75-886,221. ALLIED CONSTRUCTION PRODUCTS, INC., CLEVELAND, OH. FILED 1-3-2000.



THE MARK CONSISTS OF A STYLIZED DEPICTION OF A MAN IN A HARD HAT.

FOR GROUSER BARS USED AS REPLACEMENTS ON TRACK SHOES OF CRAWLER TYPE CONSTRUCTION MACHINES; ADJUSTABLE HYDRAULIC POWERED MACHINES FOR TRENCH SHORING AND BRACING; HYDRAULICALLY OPERATED IMPACT HAMMERS; POWER OPERATED EDGE HARDENED STEEL PAVEMENT CUTTERS AND FORGED OR CAST SHAPED SUPPORTS THEREFOR; PNEUMATICALLY OPERATED UNDERGROUND PIERCING TOOLS; VIBRATORY COMPACTORS; MACHINE PARTS, NAMELY, BOOM MOUNTED GRAPPLES AND SHEARS; BOOM SYSTEMS COMPOSED OF STATIONARY BASE, BOOM, AND STICK USED IN THE MINING INDUSTRY, THE QUARRY INDUSTRY AND FOR MATERIAL TRANSFER APPLICATIONS; HYDRAULIC POWER UNITS FOR CONSTRUCTION MACHINES; AND REPLACEMENT PARTS FOR ALL OF THE AFORESAID GOODS (U.S. CLS. 13, 19, 21, 23, 31, 34 AND 35).

FIRST USE 4-1-1996; IN COMMERCE 4-1-1996.

CLASS 7—(Continued).

SN 75-907,764. ARC ABRASIVES, INC., TROY, OH. FILED 2-2-2000.

OCTAPADS

OWNER OF U.S. REG. NO. 2,266,749.
FOR ABRASIVE PADS FOR USE WITH POWER-OPERATED MACHINERY (U.S. CLS. 13, 19, 21, 23, 31, 34 AND 35).

FIRST USE 6-11-1999; IN COMMERCE 6-11-1999.

SN 75-943,156. TETRA LAVAL HOLDINGS & FINANCE S.A., CH-1009 PULLY, SWITZERLAND, FILED 3-14-2000.

TETRA ALMIX

FOR APPARATUS FOR THE RECOMBINATION OR RECONSTITUTION OF LIQUID FOOD PRODUCTS COMPRISED OF TANKS, MIXERS, PIPES, AND ROTARY KNIVES (U.S. CLS. 13, 19, 21, 23, 31, 34 AND 35).

SN 75-943,159. TETRA LAVAL HOLDINGS & FINANCE S.A., CH-1009 PULLY, SWITZERLAND, FILED 3-14-2000.

TETRA ALBLEND

FOR APPARATUS FOR BLENDING OF LIQUID FOOD PRODUCTS COMPRISED OF TANKS, MIXERS, PUMPS, INLETS, METERS AND CONTROLLERS (U.S. CLS. 13, 19, 21, 23, 31, 34 AND 35).

SN 76-005,012. BALDWIN GRAPHIC SYSTEMS, INC., SHELTON, CT. FILED 3-20-2000.

QUIKPAC

FOR AUTOMATIC BLANKET CLEANER CLEANING CARTRIDGES, NAMELY, PRE-MOISTENED CLEANING CARTRIDGES USED IN THE PRINTING INDUSTRY (U.S. CLS. 13, 19, 21, 23, 31, 34 AND 35).

CLASS 7—(Continued).

SN 76-013,133. AMERICAN ACTUATOR, LLC, TOLEDO, OH. FILED 3-30-2000.



NO CLAIM IS MADE TO THE EXCLUSIVE RIGHT TO USE "AMERICAN ACTUATOR", APART FROM THE MARK AS SHOWN.

FOR GEAR PUMPS FOR MACHINES AND LAND VEHICLES (U.S. CLS. 13, 19, 21, 23, 31, 34 AND 35).

SN 76-023,338. PRECISION DISPENSING SYSTEMS LIMITED, PALMERSTON NORTH, NEW ZEALAND, FILED 1-27-2000.

INFLEX

FOR ELECTRONIC TUBE PUMPS AND REPLACEMENT PARTS THEREFOR; DISPENSING MACHINES AND PRESSURE WASHING MACHINES (U.S. CLS. 13, 19, 21, 23, 31, 34 AND 35).

SN 76-032,143. WULFTEC INTERNATIONAL INC., AYER'S CLIFF, PROVINCE OF QUEBEC, CANADA, FILED 4-21-2000.

RAPID-THREAD

PRIORITY CLAIMED UNDER SEC. 44(D) ON CANADA APPLICATION NO. TMO1043780, FILED 1-21-2000, REG. NO. TMA552445, DATED 10-16-2001, EXPIRES 10-16-2016.

FOR INDUSTRIAL STRETCH WRAP MACHINE PARTS, NAMELY, CARRIAGE FOR PRESTRETCHING FILM USED FOR PALLET WRAPPING (U.S. CLS. 13, 19, 21, 23, 31, 34 AND 35).

SN 76-033,637. J & R ENGINEERING CO., INC., MUKWONAGO, WI. FILED 4-19-2000.

LIFT-N-LOCK

SEC. 2(F).
FOR TELESCOPING BOOM ASSEMBLIES AND LIFT EQUIPMENT, NAMELY HYDRAULIC BOOM GANTRIES (U.S. CLS. 13, 19, 21, 23, 31, 34 AND 35).

FIRST USE 1-0-1988; IN COMMERCE 1-0-1988.

CLASS 7—(Continued).

SN 76-103,476. ULTRA-TOOL INTERNATIONAL INCORPORATED, HUNTINGTON BEACH, CA. FILED 8-4-2000.

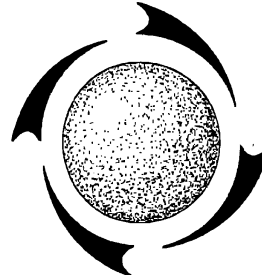
**TOOL ALLIANCE**

NO CLAIM IS MADE TO THE EXCLUSIVE RIGHT TO USE "TOOL", APART FROM THE MARK AS SHOWN.

THE STIPPLING IS FOR SHADING PURPOSES ONLY AND DOES NOT INDICATE COLOR.

FOR POWER OPERATED METAL CUTTING TOOLS, NAMELY BORERS, BURRS, COUNTERSINKS, CYLINDERS, DRILLS, END MILLS, KEYSEAT CUTTERS, RADIUS CUTTERS, REAMERS, ROTARY FILES, ROUTERS, AND ROTARY SAWS (U.S. CLS. 13, 19, 21, 23, 31, 34 AND 35).

FIRST USE 0-0-1999; IN COMMERCE 0-0-1999.

SN 76-128,759. FAIP NORTH AMERICA, INC., PALATINE, IL. FILED 9-18-2000.

TRADESMAN

FOR PRESSURE WASHERS AND REPLACEMENT PARTS THEREFORE (U.S. CLS. 13, 19, 21, 23, 31, 34 AND 35).

FIRST USE 1-0-1998; IN COMMERCE 1-0-1998.

SN 76-139,633. PROAIR GMBH GERATEBAU, 88260 ARGENTH-EGLOFS, FED REP GERMANY, FILED 10-3-2000.

FLIPPER

PRIORITY CLAIMED UNDER SEC. 44(D) ON FED REP GERMANY APPLICATION NO. 30025795.3/0, FILED 4-3-2000, REG. NO. 30025795, DATED 8-22-2000, EXPIRES 4-30-2010.

FOR AUXILIARY APPARATUS FOR WATER VACUUM CLEANERS AND VACUUM CLEANERS FOR CLEANING CARPETS AND HARD FLOORS BY BRINGING OUT LIQUID ON A SURFACE AND ABSORBING IT THEREFROM, NAMELY, A TANK, A PUMP AND A SPRAY AND SUCTION ASSEMBLY CONSISTING OF CONNECTING HOSE, STACKABLE TUBES AND SUCTION NOZZLES AND SPRAY NOZZLES (U.S. CLS. 13, 19, 21, 23, 31, 34 AND 35).

FIRST USE 0-0-1995; IN COMMERCE 7-6-2000.

CLASS 7—(Continued).

SN 76-140,402. IIT MANUFACTURING ENTERPRISES, INC., WILMINGTON, DE. FILED 10-5-2000.

ENGINEERED FOR LIFE

FOR SPA, POOL, BATH AND AQUATIC PRODUCTS, NAMELY, CYCLE VALVE ASSEMBLIES COMPRISED OF VALVES, PRESSURE GAUGES, PUMPS; JET AND JET VALVE ASSEMBLIES COMPRISED OF NUTS, RINGS, HANDLES, MANIFOLDS, JETS, LOCKS; AIR INJECTORS; CONTROLS; MANIFOLDS; DRAIN AND SUCTION ASSEMBLIES COMPRISED OF COVERS, FITTINGS, TEES, PLUGS, NUTS, GASKETS; AIR CONTROLS; VALVE ASSEMBLIES COMPRISED OF HANDLES, COVERS, FITTINGS, NUTS, O'RINGS, WASHERS, ROTORS, PLUGS; AIR BLOWERS AND AIR BLOWER MOTORS; WHIRLPOOL BATH HEATERS; AIR SWITCHES; WALL FITTING ASSEMBLIES COMPRISED OF FITTINGS, EYEBALLS, NUTS, GASKETS, RINGS; BLOWER ASSEMBLIES COMPRISED OF BLOWERS, PORTS; SLIP SOCKET ASSEMBLIES COMPRISED OF SOCKET BODIES, GASKETS, LOCK NUTS, FITTINGS; INJECTOR JET ASSEMBLIES COMPRISED OF JETS, NOZZLES, FITTINGS, CHECK VALVES; AND PARTS THEREFOR, NAMELY, NOZZLES, ORIFICE REDUCERS, SKIMMERS, PVC COUPLINGS, ELBOWS, TEES, REDUCERS, BARBS AND PUMP STANDS (U.S. CLS. 13, 19, 21, 23, 31, 34 AND 35).

FIRST USE 0-0-1998; IN COMMERCE 0-0-1998.

SN 76-146,313. MOHRLANG MANUFACTURING, INC., BRUSH, CO. FILED 10-12-2000.

VERTA MIX

NO CLAIM IS MADE TO THE EXCLUSIVE RIGHT TO USE "MIX", APART FROM THE MARK AS SHOWN.

FOR MECHANICAL MIXING AND FEEDING MACHINE FOR CATTLE FEED (U.S. CLS. 13, 19, 21, 23, 31, 34 AND 35).

FIRST USE 4-24-2000; IN COMMERCE 4-24-2000.

SN 76-171,487. BETCO CORPORATION, TOLEDO, OH. FILED 11-27-2000.

FOREMAN

FOR FLOOR CLEANING MACHINES (U.S. CLS. 13, 19, 21, 23, 31, 34 AND 35).

FIRST USE 12-20-2000; IN COMMERCE 12-20-2000.

CLASS 7—(Continued).

SN 76-173,062. ALFA AUTO MACHINERY CO., LTD., TAIPEI HSIEN, TAIWAN, FILED 11-29-2000.



THE MARK CONSISTS OF TWO STYLIZED DEPICTIONS OF THE WORD "ALFA".

FOR POWER OPERATED INDUSTRIAL ROBOTS; CONVEYORS; POWER OPERATED CRUSHING MACHINES USED TO CRUSH WASTE MATERIAL IN THE PLASTIC INDUSTRY; INDUSTRIAL PRESSES, NAMELY, ADAPTABLE PRESSES FOR USE IN THE PLASTICS INDUSTRY AND INSERT MACHINES FOR INSERTING PARTS IN MOLDS IN THE PLASTIC INDUSTRY (U.S. CLS. 13, 19, 21, 23, 31, 34 AND 35).

FIRST USE 12-1-1999; IN COMMERCE 12-1-1999.

SN 76-194,436. H-TECH, INC., WILMINGTON, DE. FILED 1-16-2001.

POOL GATOR

NO CLAIM IS MADE TO THE EXCLUSIVE RIGHT TO USE "POOL", APART FROM THE MARK AS SHOWN.

FOR UNDERWATER SWIMMING POOL CLEANING MACHINES FOR CLEANING THE SURFACE OF A SWIMMING POOL (U.S. CLS. 13, 19, 21, 23, 31, 34 AND 35).

SN 76-204,593. ATELIER MECANIQUE J. PRECISION INC., ST. HUBERT, PROVINCE OF QUEBEC, CANADA, FILED 2-2-2001.



NO CLAIM IS MADE TO THE EXCLUSIVE RIGHT TO USE "ADVANCED VALVES" AND "VALVETRAIN", APART FROM THE MARK AS SHOWN.

FOR MOTORCYCLE ENGINE VALVES AND VALVE GUIDES (U.S. CLS. 13, 19, 21, 23, 31, 34 AND 35).

FIRST USE 1-0-2000; IN COMMERCE 1-0-2000.

SN 76-217,875. EDGE CRAFT CORPORATION, AVONDALE, PA. FILED 3-1-2001.

ULTRA STROP

NO CLAIM IS MADE TO THE EXCLUSIVE RIGHT TO USE "STROP", APART FROM THE MARK AS SHOWN.

FOR ELECTRIC SHARPENERS FOR KNIVES AND OTHER CUTTING TOOLS (U.S. CLS. 13, 19, 21, 23, 31, 34 AND 35).

CLASS 7—(Continued).

SN 76-217,879. EDGECRAFT CORPORATION, AVONDALE, PA. FILED 3-1-2001.

STEEL'N STROP

NO CLAIM IS MADE TO THE EXCLUSIVE RIGHT TO USE "STROP", APART FROM THE MARK AS SHOWN.
FOR ELECTRIC SHARPENERS FOR KNIVES AND OTHER CUTTING TOOLS (U.S. CLS. 13, 19, 21, 23, 31, 34 AND 35).

SN 76-223,393. KONINKLIJKE PHILIPS ELECTRONICS N.V., EINDHOVEN, NETHERLANDS, FILED 3-9-2001.

MICROSTORE

PRIORITY CLAIMED UNDER SEC. 44(D) ON BENELUX APPLICATION NO. 0973438, FILED 9-15-2000, REG. NO. 0676901, DATED 6-0-2001, EXPIRES 9-15-2010.
FOR ELECTRIC FOOD PROCESSORS (U.S. CLS. 13, 19, 21, 23, 31, 34 AND 35).

SN 76-228,150. R&M MATERIALS HANDLING, INC., SPRINGFIELD, OH. FILED 3-20-2001.

QX

FOR CRANES AND HOISTS, STRUCTURAL COMPONENTS AND PARTS THEREOF (U.S. CLS. 13, 19, 21, 23, 31, 34 AND 35).
FIRST USE 4-0-2001; IN COMMERCE 4-0-2001.

SN 76-240,138. ASSEMBLEON N.V., EINDHOVEN, NETHERLANDS, FILED 4-12-2001.

ASSEMBLEON

PRIORITY CLAIMED UNDER SEC. 44(D) ON BENELUX APPLICATION NO. 0975602, FILED 10-17-2000, REG. NO. 0678844, DATED 10-17-2000, EXPIRES 10-17-2010.
FOR MACHINES FOR INSTALLING AND/OR ASSEMBLING AND MOUNTING, INCLUDING SOLDERING, OF COMPONENTS ON PRINTED CIRCUIT BOARDS; MACHINES FOR ASSEMBLING PRINTED CIRCUIT BOARDS; PARTS OF THE AFORESAID MACHINES (U.S. CLS. 13, 19, 21, 23, 31, 34 AND 35).

CLASS 7—(Continued).

SN 76-242,232. SHOP-VAC CORPORATION, WILLIAMSPORT, PA. FILED 4-17-2001.



NO CLAIM IS MADE TO THE EXCLUSIVE RIGHT TO USE "LOCKON", APART FROM THE MARK AS SHOWN.
THE MARK CONSISTS OF WORD "LOCKON" WITH A DIAMOND SHAPED DESIGN BEHIND THE LETTER "O" IN THE WORD "ON". ADDITIONALLY, THE LETTER "O" IN THE WORD "ON" HAS FOUR ARROWS PROTRUDING FROM IT AT VARIOUS ANGLES.
FOR HOSE SECURING DEVICE FOR WET/DRY VACUUM CLEANERS (U.S. CLS. 13, 19, 21, 23, 31, 34 AND 35).
FIRST USE 9-0-1999; IN COMMERCE 9-0-1999.

SN 76-254,577. ITEMA AMERICA, INC., SPARTANBURG, SC. FILED 5-9-2001.



THE MARK CONSISTS IN PART OF THE STYLIZED LETTER "I."
FOR TEXTILE MACHINES, NAMELY, TEXTILE WEAVING MACHINES, SPINNING MACHINES, WINDING MACHINES, TWISTING MACHINES, AND PARTS THEREFOR (U.S. CLS. 13, 19, 21, 23, 31, 34 AND 35).

SN 76-254,578. ITEMA AMERICA, INC., SPARTANBURG, SC. FILED 5-9-2001.

ITEMA

FOR TEXTILE MACHINES, NAMELY, TEXTILE WEAVING MACHINES, SPINNING MACHINES, WINDING MACHINES, TWISTING MACHINES, AND PARTS THEREFOR (U.S. CLS. 13, 19, 21, 23, 31, 34 AND 35).

CLASS 7—(Continued).

SN 76-261,106. FLEXAUST COMPANY, INC., THE, WARSAW, IN. FILED 5-23-2001.

RACEFLEX

FOR VEHICLE HOSES FOR USE IN AUTOMOBILE COOLING SYSTEMS (U.S. CLS. 13, 19, 21, 23, 31, 34 AND 35).

SN 76-282,759. WEILER CORPORATION, CRESCO, PA. FILED 7-9-2001.

HURRICANE

FOR WIRE POWER BRUSH FOR USE WITH POWER DRIVEN AIR OR ELECTRIC HAND TOOLS (U.S. CLS. 13, 19, 21, 23, 31, 34 AND 35).
FIRST USE 0-0-1994; IN COMMERCE 0-0-1994.

SN 76-282,760. WEILER CORPORATION, CRESCO, PA. FILED 7-9-2001.

ANDERLON

FOR POWER-OPERATED NYLON ABRASIVE FILAMENT BRUSHES (U.S. CLS. 13, 19, 21, 23, 31, 34 AND 35).
FIRST USE 0-0-1982; IN COMMERCE 0-0-1982.

SN 76-290,819. SUGINO MACHINE LIMITED, TOYAMAKEN, JAPAN, FILED 7-25-2001.

SUGINO MACHINE LIMITED

OWNER OF U.S. REG. NO. 1.237.063.
NO CLAIM IS MADE TO THE EXCLUSIVE RIGHT TO USE "MACHINE LIMITED", APART FROM THE MARK AS SHOWN.

THE ENGLISH TRANSLATION OF "SUGINO" IS "FIELD OR PLAIN OF JAPANESE CEDAR, CRYPTOMERIA".

FOR MACHINE TOOLS; NAMELY, DRILLING MACHINES, BORING MACHINES, GRINDING MACHINES, CHAMFERING MACHINES, TAPPING MACHINES, JET CLEAN MACHINES AND JET CUTTING MACHINES (U.S. CLS. 13, 19, 21, 23, 31, 34 AND 35).
FIRST USE 1-1-1974; IN COMMERCE 1-1-1974.

CLASS 7—(Continued).

SN 76-294,051. STM POWER, INC., ANN ARBOR, MO. FILED 8-1-2001.



The logo for STM POWER features the letters "STM" in a large, bold, italicized sans-serif font above the word "POWER" in a smaller, bold, sans-serif font. Both are contained within a thick, black, horizontal rectangular bar.

OWNER OF U.S. REG. NO. 2,076,037.
NO CLAIM IS MADE TO THE EXCLUSIVE RIGHT TO USE "POWER", APART FROM THE MARK AS SHOWN.
FOR EXTERNAL HEAT ENGINE FOR USE IN CONVERTING HEAT ENERGY INTO ELECTRICITY OR THERMAL ENERGY FROM SOURCES INCLUDING, THE COMBUSTION OF A LIQUID GAS OR SOLID FUEL, SOLAR ENERGY OR WASTE HEAT (U.S. CLS. 13, 19, 21, 23, 31, 34 AND 35).
FIRST USE 6-1-2000; IN COMMERCE 6-1-2000.

SN 76-295,751. TOP INNOVATIONS, INC., RIVERSIDE, MO. FILED 8-8-2001.

STEAM MOUSE

NO CLAIM IS MADE TO THE EXCLUSIVE RIGHT TO USE "STEAM", APART FROM THE MARK AS SHOWN.
FOR STEAM CLEANERS (U.S. CLS. 13, 19, 21, 23, 31, 34 AND 35).

SN 76-296,798. ARMOR MARKET CO., LTD., WALNUT, CA. FILED 8-6-2001.

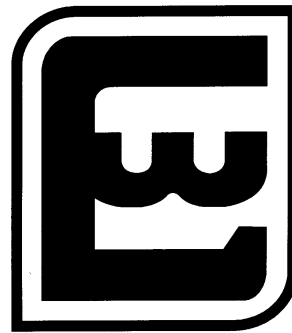

FOR HYDRAULIC DOOR CLOSER (U.S. CLS. 13, 19, 21, 23, 31, 34 AND 35).

CLASS 7—(Continued).

SN 76-297,799. SWISHER MOWER & MACHINE COMPANY, INC., WARRENSBURG, MO. FILED 8-13-2001.

PREDATOR

FOR WALK BEHIND LAWN MOWERS; AND GRASS AND WEED POWER TRIMMERS (U.S. CLS. 13, 19, 21, 23, 31, 34 AND 35).
FIRST USE 1-0-2000; IN COMMERCE 1-0-2000.

SN 76-298,217. DIAMOND PRODUCTS INTERNATIONAL, INC., HOUSTON, TX. FILED 8-3-2001.

DIAMOND PRODUCTS INTERNATIONAL

FOR DOWNHOLE DRILLING TOOLS, NAMELY, DOWN HOLE DRILLING BITS (U.S. CLS. 13, 19, 21, 23, 31, 34 AND 35).
FIRST USE 8-0-1994; IN COMMERCE 8-0-1994.

SN 76-303,366. ZEROMICRON INC., SAN JOSE, CA. FILED 8-22-2001.

ZEROMICRON

FOR SEMICONDUCTOR WAFER POLISHING TEM-PLATES (U.S. CLS. 13, 19, 21, 23, 31, 34 AND 35).
FIRST USE 7-13-2001; IN COMMERCE 7-13-2001.

SN 76-303,793. MACHINED CASTINGS INCORPORATED, DBA MARATHON ENGINE SYSTEMS, WATERFORD, WI. FILED 8-23-2001.

COMGEN

FOR DISTRIBUTED POWER GENERATION PRODUCTS, NAMELY, GENERATOR SETS, ELECTRIC GENERATORS, GENERATOR DRIVERS, ENGINES AND TURBINE ENGINES FOR GENERATOR DRIVERS, AND PARTS THEREFOR (U.S. CLS. 13, 19, 21, 23, 31, 34 AND 35).

SN 76-314,315. DYNABRADE, INC., CLARENCE, NY. FILED 9-19-2001.

DYNORBITAL-SPIRIT

OWNER OF U.S. REG. NO. 1,331,720.
FOR AIR-OPERATED POWER RANDOM ORBITAL SANDERS (U.S. CLS. 13, 19, 21, 23, 31, 34 AND 35).

CLASS 7—(Continued).

SN 76-322,369. BISHOP-WISECARVER CORPORATION, PITTSBURG, CA. FILED 10-9-2001.

BISHOP-WISECARVER CORPORATION

NO CLAIM IS MADE TO THE EXCLUSIVE RIGHT TO USE "CORPORATION", APART FROM THE MARK AS SHOWN.

FOR LINEAR MOTION SYSTEMS FOR MECHANICAL APPLICATIONS COMPRISING GUIDE WHEELS, SLIDES, TRACKS, TRACK PLATES, BUSHINGS, WHEEL BEARINGS, LUBRICATORS, BELTS AND SUPPORT BEAMS (U.S. CLS. 13, 19, 21, 23, 31, 34 AND 35).
FIRST USE 9-10-1996; IN COMMERCE 10-0-1998.

SN 76-322,800. E-Z GROUT CORPORATION, WATERFORD, OH. FILED 10-9-2001.

MUD HOG

OWNER OF U.S. REG. NO. 2,421,996.
FOR CONCRETE MIXERS (U.S. CLS. 13, 19, 21, 23, 31, 34 AND 35).
FIRST USE 8-13-2001; IN COMMERCE 8-13-2001.

SN 76-323,549. RICE LAKE WEIGHING SYSTEMS, INC., RICE LAKE, WI. FILED 10-10-2001.

ATOM-MISER

OWNER OF U.S. REG. NO. 1,632,160.
FOR PNEUMATIC SPRAY GUN PARTS FOR PNEUMATIC SPRAY GUNS FOR PAINTING, NAMELY, REPLACEABLE MODULAR CARTRIDGE ASSEMBLIES COMPOSED OF AIR CAPS, RINGS, FLUID TIPS, NOZZLE SEAL, AIR DIRECTING SEALS, AIR DIRECTING SEALS, HIGH PRESSURE NEEDLE SEALS, "E" RINGS, NEEDLE SPRINGS, NEEDLE PACKING SEAL, AND AIR DIRECTING PLUGS (U.S. CLS. 13, 19, 21, 23, 31, 34 AND 35).
FIRST USE 2-8-1990; IN COMMERCE 2-8-1990.

SN 76-327,915. SHINGLE SHUCKER, INCORPORATED, DBA PRAIRIE CITY MANUFACTURING CORPORATION, DAYTON, OH. FILED 10-19-2001.

SS#1

FOR POWER OPERATED TOOLS, NAMELY, SHINGLE STRIPPERS (U.S. CLS. 13, 19, 21, 23, 31, 34 AND 35).

CLASS 7—(Continued).

SN 76-329,022. AMERICAN PNEUMATIC TOOL COMPANY, GARDENA, CA. FILED 10-24-2001.

MANTIS

FOR POWER CONSTRUCTION TOOLS, NAMELY, PAVING BREAKERS (U.S. CLS. 13, 19, 21, 23, 31, 34 AND 35).

SN 76-329,671. AMERICAN SAW & MFG. COMPANY, INC., EAST LONGMEADOW, MA. FILED 10-26-2001.

LENOX LIGHTNING BAND

NO CLAIM IS MADE TO THE EXCLUSIVE RIGHT TO USE "BAND", APART FROM THE MARK AS SHOWN.

FOR HAND TOOLS, NAMELY POWER SAWS (U.S. CLS. 13, 19, 21, 23, 31, 34 AND 35).

SN 76-331,824. FLASHPOINT, INC., SARASOTA, FL. FILED 10-30-2001.

EPLUG

FOR SPARK PLUGS (U.S. CLS. 13, 19, 21, 23, 31, 34 AND 35).

SN 76-336,353. WEATHERFORD/LAMB, INC., HOUSTON, TX. FILED 11-9-2001.

SEAWOLF

FOR PORTABLE ON-SITE MACHINES FOR PRODUCING INERT GAS FOR USE IN PURGING, GAS INJECTIONS, PIPELINE DE-WATERING AND DRYING APPLICATIONS IN THE OIL AND GAS INDUSTRY (U.S. CLS. 13, 19, 21, 23, 31, 34 AND 35).

FIRST USE 4-0-2001; IN COMMERCE 4-0-2001.

SN 76-336,537. MILLCREEK MANUFACTURING COMPANY, LEOLA, PA. FILED 11-13-2001.

BERM MASTER

NO CLAIM IS MADE TO THE EXCLUSIVE RIGHT TO USE "BERM", APART FROM THE MARK AS SHOWN.

FOR CONSTRUCTION MACHINE USED FOR THE CONSTRUCTION AND FORMATION OF A WATER PERMEABLE WINDROW OF A COMPOST, MULCH, FIBER, OR OTHER MATERIAL FOR THE PURPOSE OF CONTAINING OR CONTROLLING SOIL EROSION, SEDIMENT AND POLLUTANT RUNOFF (U.S. CLS. 13, 19, 21, 23, 31, 34 AND 35).

CLASS 7—(Continued).

SN 76-339,111. IKS CORPORATION, CINCINNATI, OH. FILED 11-16-2001.

ACT

FOR INDUSTRIAL MACHINE KNIVES USED IN CONNECTION WITH CHIPPING (U.S. CLS. 13, 19, 21, 23, 31, 34 AND 35).

SN 76-339,200. DIRECT RADIATOR, INC., DBA VENGARD, INC., DENVER, CO. FILED 11-19-2001.

VENGARD

FOR RADIATORS FOR MOTORS AND ENGINES (U.S. CLS. 13, 19, 21, 23, 31, 34 AND 35).

SN 76-339,201. DIRECT RADIATOR, INC., DBA VENGARD, INC., DENVER, CO. FILED 11-19-2001.



THE MARK CONSISTS OF THE WORD "VENGARD" IN FANCIFUL TYPE, INCLUDING A LARGE "V" AND A DRAWING OF A GLOBE ATOP THE LEFT ARM OF THE "V".

FOR RADIATORS FOR MOTORS AND ENGINES (U.S. CLS. 13, 19, 21, 23, 31, 34 AND 35).

SN 76-342,787. ACE-HI CORPORATION, PALISADES PARK, NJ. FILED 11-29-2001.



FOR COMMERCIAL STEAM PRESSING MACHINES FOR GARMENTS AND PARTS THEREFOR (U.S. CLS. 13, 19, 21, 23, 31, 34 AND 35).

FIRST USE 6-0-1996; IN COMMERCE 6-0-1996.

CLASS 7—(Continued).

SN 76-344,605. AG-BAG INTERNATIONAL LIMITED, WARRENTON, OR. FILED 12-3-2001.

PAC 2 POWER

FOR BAGGING MACHINE (U.S. CLS. 13, 19, 21, 23, 31, 34 AND 35).

SN 78-016,212. AIR TREE OZONE TECHNOLOGY CO., TAIPEI HSIEN, TAIWAN, FILED 7-11-2000.



PRIORITY CLAIMED UNDER SEC. 44(D) ON TAIWAN APPLICATION NO. 089002631, FILED 1-18-2000, REG. NO. 945646, DATED 6-16-2001, EXPIRES 1-31-2011.

THE LINING SHOWN IN THE DRAWING IS INTENDED TO INDICATE COLORS BLUE AND RED.

FOR CLOTHES WASHING MACHINES FEATURING OZONE GENERATORS; RICE WASHING MACHINES FEATURING OZONE GENERATORS; AND ELECTRONIC VEGETABLE KEEPERS FEATURING OZONE GENERATORS (U.S. CLS. 13, 19, 21, 23, 31, 34 AND 35).

SN 78-027,197. ORTHMAN MANUFACTURING, INC., LEXINGTON, NE. FILED 9-22-2000.



FOR FARM IMPLEMENTS; NAMELY, TILLAGE EQUIPMENT, NAMELY, TILLERS; AND FERTILIZER EQUIPMENT, NAMELY, FERTILIZER APPLICATORS (U.S. CLS. 13, 19, 21, 23, 31, 34 AND 35).

FIRST USE 4-21-2000; IN COMMERCE 4-21-2000.

CLASS 7—(Continued).

SN 78-072,928. POJU R. STEPHANSEN AS, BORGES, NORWAY, FILED 7-9-2001.

TEKKEM

PRIORITY CLAIMED UNDER SEC. 44(D) ON NORWAY APPLICATION NO. 200102319, FILED 2-16-2001, REG. NO. 210538, DATED 9-20-2001, EXPIRES 9-20-2011.

FOR MACHINES FOR LIME SLAKING (U.S. CLS. 13, 19, 21, 23, 31, 34 AND 35).

CLASS 8—HAND TOOLS

SN 75-839,529. ALP INDUSTRIES, INC., COATESVILLE, PA. FILED 11-3-1999.

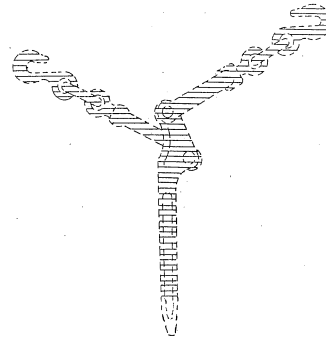

THE DRAWING IS LINED FOR THE COLOR BLUE. THE MARK CONSISTS OF THE COLOR BLUE AS APPLIED TO THE SURFACE OF A LOAD BINDER. THE DOTTED OUTLINE OF THE GOODS IS INTENDED TO SHOW THE LOCATION OF THE MARK ON THE GOODS AND IS NOT A PART OF THE MARK.

SEC. 2(F).

FOR HAND TOOLS FOR LOAD SECUREMENT, NAMELY, LOAD BINDERS (U.S. CLS. 23, 28 AND 44). FIRST USE 11-1-1990; IN COMMERCE 11-1-1990.

SN 76-147,472. MAASDAM POW'R-PULL INCORPORATED, BURBANK, CA. FILED 10-16-2000.

MAASDAM POW'R-PULL

NO CLAIM IS MADE TO THE EXCLUSIVE RIGHT TO USE "POWER PULL", APART FROM THE MARK AS SHOWN.

FOR HAND OPERATED HOIST WINCHES; HAND OPERATED CABLE PULLERS (U.S. CLS. 23, 28 AND 44). FIRST USE 7-29-1946; IN COMMERCE 7-29-1946.

CLASS 8—(Continued).

SN 76-162,309. LITTLE TIKES COMPANY, THE, HUDSON, OH. FILED 11-9-2000.

LITTLE TIKES KIDS

FOR MANICURE SETS; TABLEWARE AND FEEDING UTENSILS, NAMELY, FORKS, SPOONS AND KNIVES; GARDENING TOOLS, NAMELY, WEEDING FORKS, RAKES, SHOVELS, SPADES AND HOES (U.S. CLS. 23, 28 AND 44).

SN 76-209,113. C. H. HANSON, FRANKLIN PARK, IL. FILED 2-12-2001.

QUICK-FIL

FOR CARPENTRY LAYOUT HAND-OPERATED TOOLS NOT FOR MEASURING PURPOSES, NAMELY, LINE DEVICES COMPRISING CHALK AND STRING, AND REFILLS THEREFORE (U.S. CLS. 23, 28 AND 44).

SN 76-225,237. WITTENBERG, ROBERT H., WINONA, MN. FILED 3-15-2001.

TURF MENDER

NO CLAIM IS MADE TO THE EXCLUSIVE RIGHT TO USE "TURF", APART FROM THE MARK AS SHOWN. FOR HAND HELD SEEDING AND TILLING TOOL (U.S. CLS. 23, 28 AND 44). FIRST USE 3-13-2001; IN COMMERCE 3-13-2001.

SN 76-226,573. KIJIMA SEIKO CO., LTD., HYOGO-KEN, JAPAN, FILED 3-16-2001.

KIJIMA

FOR HAND TOOLS, NAMELY, BOW SAWS, JIG-SAWS, SAW BLADES, SAW HOLDERS AND SAWS (U.S. CLS. 23, 28 AND 44).

CLASS 8—(Continued).

SN 76-254,129. ELYSEE COSMETICS LTD., ENFIELD, MIDDLESEX, EN3 7XF, ENGLAND, FILED 5-8-2001.

E-PEN

FOR ELECTRICAL APPLIANCES AND APPARATUS, NAMELY, GALVANIC HAIR REMOVER FOR USE IN THE FIELD OF PERSONAL CARE, GROOMING AND BEAUTY TREATMENT (U.S. CLS. 23, 28 AND 44).

SN 76-277,677. NATURAL SCIENCE INDUSTRIES, LTD., WEST HEMPSTEAD, NY. FILED 6-28-2001.

WIRE WRITER

NO CLAIM IS MADE TO THE EXCLUSIVE RIGHT TO USE "WIRE", APART FROM THE MARK AS SHOWN. FOR HAND-OPERATED TOOL FOR DISPENSING WIRE FOR WIRE CRAFTS (U.S. CLS. 23, 28 AND 44).

SN 76-304,770. WOLF-GARTEN GMBH & CO. KG, D-57518 BETZDORF/DE, FED REP GERMANY, FILED 8-24-2001.

multi-star

PRIORITY CLAIMED UNDER SEC. 44(D) ON FED REP GERMANY APPLICATION NO. 30114161.4/0, FILED 3-2-2001, REG. NO. 30114161, DATED 7-5-2001, EXPIRES 3-31-2011.

OWNER OF U.S. REG. NO. 1,684,304. FOR MANUALLY OPERATED GARDEN TOOLS, NAMELY ADJUSTMENT CULTIVATORS, AERATORS, ROTARY GARDENING TILLERS, RAKES, SMALL-SCALE RAKES, HAND-HELD FURROWING TOOL, RIDGERS, AND GRUBBERS; HANDLE ATTACHMENTS FOR SUCH DEVICES AND WOODEN, METAL, AND ALUMINUM HANDLES (U.S. CLS. 23, 28 AND 44).

SN 76-333,253. KAHN, PETER P., BROOKHAVEN HAMLET, NY. FILED 11-5-2001.

LUGG'A BITT

FOR TOOL POUCHES FOR ATTACHMENT TO TOOL BELTS (U.S. CLS. 23, 28 AND 44). FIRST USE 3-0-2001; IN COMMERCE 3-0-2001.

CLASS 8—(Continued).

SN 76-344,601. INTERNATIONAL DEVELOPMENT CORPORATION, SOUTHLAKE, TX. FILED 12-3-2001.

COOK'S PICK

FOR CUTLERY AND CUTLERY SETS (U.S. CLS. 23, 28 AND 44).

SN 78-054,775. DELTA INDUSTRIES INTERNATIONAL, INC., KING OF PRUSSIA, PA. FILED 3-23-2001.

HURRICANE

FOR MANUALLY PRESSURIZED HAND SPRAYERS (U.S. CLS. 23, 28 AND 44).
FIRST USE 2-5-1968; IN COMMERCE 2-5-1968.

CLASS 9—ELECTRICAL AND SCIENTIFIC APPARATUS

SN 75-240,503. WESTELL TECHNOLOGIES, INC., AURORA, IL. FILED 2-12-1997.

SMARTLINK

SEC. 2(F).
FOR ROUTING SWITCHES FOR HIGH SPEED DATA AND COMMUNICATION TRANSPORT LINES (U.S. CLS. 21, 23, 26, 36 AND 38).
FIRST USE 7-0-1994; IN COMMERCE 7-0-1994.

SN 75-402,424. ABN AMRO BANK N.V., CHICAGO, IL. FILED 12-9-1997.

FACET

FOR COMPUTER SOFTWARE FOR USE IN ACCESSING AND VERIFYING BANKING ACCOUNT INFORMATION AND CONDUCTING BANKING TRANSACTIONS (U.S. CLS. 21, 23, 26, 36 AND 38).
FIRST USE 5-15-1997; IN COMMERCE 5-15-1997.

CLASS 9—(Continued).

SN 75-464,976. SUNDANCE ENTERPRISES, INC., SUNDANCE, UT. FILED 4-9-1998.

SUNDANCE CHANNEL PICTURES

OWNER OF U.S. REG. NOS. 1,431,477, 2,147,141 AND OTHERS.
NO CLAIM IS MADE TO THE EXCLUSIVE RIGHT TO USE "PICTURES", APART FROM THE MARK AS SHOWN.
FOR PRE-RECORDED VIDEO TAPES AND LASER DISKS FEATURING DRAMA, COMEDY, DOCUMENTARY, ADVENTURE, ROMANCE, SPORTS, MUSIC, SUSPENSE, ANIMATED, FAMILY AND CHILDRENS' SUBJECTS (U.S. CLS. 21, 23, 26, 36 AND 38).

SN 75-464,977. SUNDANCE ENTERPRISES, INC., SUNDANCE, UT. FILED 4-9-1998.

SUNDANCE CHANNEL PRODUCTIONS

OWNER OF U.S. REG. NOS. 1,431,477, 2,147,141 AND OTHERS.
NO CLAIM IS MADE TO THE EXCLUSIVE RIGHT TO USE "PRODUCTIONS", APART FROM THE MARK AS SHOWN.
FOR PRE-RECORDED VIDEO TAPES AND LASER DISKS FEATURING DRAMA, COMEDY, DOCUMENTARY, ADVENTURE, ROMANCE, SPORTS, MUSIC, SUSPENSE, ANIMATED, FAMILY AND CHILDRENS' SUBJECTS (U.S. CLS. 21, 23, 26, 36 AND 38).

SN 75-464,978. SUNDANCE ENTERPRISES, INC., SUNDANCE, UT. FILED 4-9-1998.

SUNDANCE CHANNEL PRESENTS...

OWNER OF U.S. REG. NOS. 1,431,477, 2,147,141 AND OTHERS.
FOR PRE-RECORDED VIDEO TAPES AND LASER DISKS FEATURING DRAMA, COMEDY, DOCUMENTARY, ADVENTURE, ROMANCE, SPORTS, MUSIC, SUSPENSE, ANIMATED, FAMILY AND CHILDRENS' SUBJECTS (U.S. CLS. 21, 23, 26, 36 AND 38).

CLASS 9—(Continued).

SN 75-469,521. COMMETREX CORPORATION, NORCROSS, GA. FILED 4-17-1998.

OPEN TELECOMMUNICATIONS FRAMEWORK

SEC. 2(F).
FOR COMPUTER SOFTWARE, NAMELY, THAT USED IN COMPUTER SYSTEMS THAT PROVIDE VOICE, DATA, FAX AND TELEPHONE SWITCHING FUNCTIONS IN MULTI-LINE COMMUNICATION SYSTEMS (U.S. CLS. 21, 23, 26, 36 AND 38).
FIRST USE 5-11-1999; IN COMMERCE 5-11-1999.

SN 75-510,789. GLOBESPAN SEMICONDUCTOR INC., RED BANK, NJ. FILED 6-30-1998.

XDSL2

FOR TELECOMMUNICATIONS PRODUCTS, NAMELY MULTI-CHANNEL DIGITAL SUBSCRIBER LINE (DSL) PRODUCTS, NAMELY, COMPUTER CHIPS (U.S. CLS. 21, 23, 26, 36 AND 38).
FIRST USE 5-0-1998; IN COMMERCE 9-30-1998.

SN 75-547,681. TAIWAN FU HSING INDUSTRY CO., LTD., KAOHSIUNG HSIEN, TAIWAN, FILED 9-3-1998.

LEGACY

FOR ELECTRIC LOCK, ELECTRONIC LOCK, ANTI-THEFT LOCK, MAGNETIC CARD LOCK, ALL ELECTRICAL IN NATURE (U.S. CLS. 21, 23, 26, 36 AND 38).

CLASS 9—(Continued).

SN 75-572,525. KABUSHIKI KAISHA YAMAMOTO KANSAI JIMUSHO, TOKYO 150-0011, JAPAN, FILED 10-19-1998.

人間讃歌

PRIORITY CLAIMED UNDER SEC. 44(D) ON JAPAN APPLICATION NO. 10-76907, FILED 9-10-1998, REG. NO. 4333349, DATED 11-12-1999, EXPIRES 11-12-2009.

THE NON-LATIN CHARACTERS IN THE MARK TRANSLITERATE TO "NINGEN-SANKA" AND THIS MEANS "HUMAN BEING PAEAN".

FOR EYEGLASSES, SUNGLASSES, EYEGLASS CASES, SUNGLASS CASES, EYEGLASS CHAINS, EYEGLASS FRAMES, AND EYEGLASS LENSES (U.S. CLS. 21, 23, 26, 36 AND 38).

SN 75-577,943. SUPERIOR TELECOMMUNICATIONS, INC., ATLANTA, GA. BY MERGER SUPERIOR TELECOMMUNICATIONS, INC., ATLANTA, GA. FILED 10-26-1998.

ASAP

FOR TELECOMMUNICATIONS EQUIPMENT FOR DATA AND TELECOMMUNICATIONS USES, NAMELY, FIBER OPTIC CABLES HAVING POLYMERS INJECTED INTO ESSENTIAL CABLE COMPONENTS SUCH AS TAPES, CENTER MEMBERS AND YARNS, TO PROHIBIT THE FLOW OF WATER (U.S. CLS. 21, 23, 26, 36 AND 38).

SN 75-608,634. MULTIACTIVE TECHNOLOGIES INC., VANCOUVER, BRITISH COLUMBIA, CANADA, FILED 12-18-1998.

ECBUILDER

PRIORITY CLAIMED UNDER SEC. 44(D) ON CANADA APPLICATION NO. 882,996, FILED 6-30-1998, REG. NO. TMA539298, DATED 1-8-2001, EXPIRES 1-8-2016.

FOR COMPUTER SOFTWARE FOR USE IN THE CREATION AND DESIGN OF WEBSITES (U.S. CLS. 21, 23, 26, 36 AND 38).

SN 75-639,260. ENERGY STORAGE SYSTEMS PTY. LTD., NORTH RYDE NSW 2113, AUSTRALIA, FILED 2-8-1999.

CHARGE CARD

FOR ELECTRIC ENERGY STORAGE CAPACITORS IN THE FORM OF A CARD (U.S. CLS. 21, 23, 26, 36 AND 38).

CLASS 9—(Continued).

SN 75-652,826. LILLY SOFTWARE ASSOCIATES, INC., HAMPTON, NH. FILED 2-26-1999.

VISUAL

OWNER OF U.S. REG. NOS. 1,894,849, 2,169,304 AND OTHERS.

SEC. 2(F).
FOR SOFTWARE FOR MANAGING MANUFACTURING AND DISTRIBUTION BUSINESSES (U.S. CLS. 21, 23, 26, 36 AND 38).

FIRST USE 4-15-1992; IN COMMERCE 12-31-1992.

SN 75-692,625. SHARP KABUSHIKI KAISHA, TA SHARP CORPORATION, OSAKA 545-8522, JAPAN, FILED 4-27-1999.



OWNER OF U.S. REG. NO. 1,827,274.

NO CLAIM IS MADE TO THE EXCLUSIVE RIGHT TO USE "INTERNET", APART FROM THE MARK AS SHOWN.

FOR VIDEO CAMERA AND ACCESSORIES, NAMELY, HAND STRAP, BATTERY, SMARTMEDIA MEMORY CARD; SOFT CASE; APPLICATION SOFTWARE ON A CD-ROM FOR TRANSMITTING VIDEO STREAMING, FOR TRANSMITTING STILL OR MOVING VIDEO PICTURES, FOR ATTACHING MOVING VIDEO OR STILL PICTURES TO E-MAIL AND FOR ORGANIZING MOVING VIDEO OR STILL PICTURE DATA, ALL FOR COMPUTER AND INTERNET USE; AC ADAPTER; FLOPPY DISC ADAPTER; PC CARD ADAPTER; SOFTWARE AND COMPUTER HARDWARE FOR TRANSMITTING RECORDED VIDEO DATA VIA COMPUTERS AND A GLOBAL COMPUTER NETWORK (U.S. CLS. 21, 23, 26, 36 AND 38).

SN 75-705,914. DICTAPHONE CORPORATION, STRATFORD, CT. FILED 5-13-1999.

FREEDOM

FOR MODULAR SOUND RECORDING AND REPRODUCING EQUIPMENT, NAMELY, ELECTRONIC LOGGING DEVICES (LOGGERS) FOR RECORDING AND REPRODUCING MULTIPLE TELEPHONE, RADIO AND FACSIMILE COMMUNICATIONS USED FOR QUALITY MONITORING AND LIABILITY RECORDING PURPOSES; AND INSTRUCTION MANUALS AND OTHER DOCUMENTATION FOR USE THEREWITH (U.S. CLS. 21, 23, 26, 36 AND 38).

CLASS 9—(Continued).

SN 75-708,828. PALM, INC., SANTA CLARA, CA. BY MERGER PALM COMPUTING, INC., MOUNTAIN VIEW, CA. FILED 5-17-1999.

PALMGLOVE

OWNER OF U.S. REG. NOS. 1,772,255, 2,348,355 AND OTHERS.

FOR CARRYING CASES FOR USE WITH HANDHELD COMPUTERS AND RELATED COMPUTER PERIPHERALS (U.S. CLS. 21, 23, 26, 36 AND 38).

FIRST USE 8-0-1999; IN COMMERCE 8-0-1999.

SN 75-711,083. HOT DISK AB, SE-753, 14 UPPSALA, SWEDEN, FILED 5-20-1999.

HOT DISK

PRIORITY CLAIMED UNDER SEC. 44(D) ON SWEDEN APPLICATION NO. 001145622, FILED 4-20-1999, REG. NO. 001145622, DATED 4-19-2000, EXPIRES 4-20-2009.

FOR TRANSIENT PLANE SOURCE DEVICE FOR ANALYZING THERMAL CONSTANTS, NAMELY THERMAL CONDUCTIVITY, THERMAL DIFFUSIVITY AND HEAT CAPACITY, ACCORDING TO THE TRANSIENT METHOD OF THERMAL ANALYSIS, FOR USE IN THE FIELDS OF METALLURGY, THERMO-DYNAMICS AND PHYSICS; AND ELECTRONIC ANALYSIS EQUIPMENT FOR THE TRANSIENT METHOD OF THERMAL ANALYSIS, FOR USE IN THE FIELDS OF METALLURGY, THERMO-DYNAMICS AND PHYSICS (U.S. CLS. 21, 23, 26, 36 AND 38).

SN 75-713,247. SPEEDLINE TECHNOLOGIES, INC., HAVERHILL, MA. FILED 5-24-1999.

CAMALOT PULSE-JET

FOR ELECTRONIC LIQUID DISPENSING SYSTEM COMPRISING AUTOMATED DISPENSING MACHINES FOR PRECISE DISPENSING AND PLACEMENT OF INDUSTRIAL MATERIALS, SUCH AS SOLDER PASTES, ADHESIVES, EPOXIES AND OTHER FLUID MATERIALS USED IN ELECTRONICS ASSEMBLY, INDUSTRIAL AND AUTOMOTIVE APPLICATIONS (U.S. CLS. 21, 23, 26, 36 AND 38).

SN 75-733,332. SNIPES, WESLEY, BEVERLY HILLS, CA. FILED 6-21-1999.

LYRICAL PASSION PLAY

FOR SERIES OF SHORT FILMS IN THE FIELDS OF DRAMA, COMEDY, AND ACTION THAT ARE THEMATICALLY MOTIVATED BY THE STORIES THAT INSPIRE POPULAR SONGS (U.S. CLS. 21, 23, 26, 36 AND 38).

CLASS 9—(Continued).

SN 75-737,784. KABUSHIKI KAISHA SONY MUSIC ENTERTAINMENT, TA SONY MUSIC ENTERTAINMENT (JAPAN) INC., TOKYO, JAPAN, FILED 6-28-1999.



FOR PHONOGRAPH RECORDS AND AUDIO TAPES FEATURING MUSIC AND ENTERTAINMENT, NAMELY DRAMA AND COMEDY; SHEETS AND CARDS BEARING STRIPS OF ENCODED MAGNETIC TAPE; EXPOSED CINEMATOGRAPHIC FILMS FEATURING MUSIC AND ENTERTAINMENT, NAMELY, ANIMATED CARTOONS, DRAMA AND COMEDY; PHOTOGRAPHIC SLIDE TRANSPARENCIES; PRERECORDED VIDEO DISCS FEATURING MUSIC AND ENTERTAINMENT, NAMELY, ANIMATED CARTOONS, DRAMA, COMEDY AND VIDEO GAMES; PRERECORDED VIDEO TAPES FEATURING MUSIC AND ENTERTAINMENT, NAMELY, ANIMATED CARTOONS, DRAMA, COMEDY AND VIDEO GAMES; VIDEO GAME MACHINES FOR USE WITH TELEVISIONS; PRERECORDED COMPACT DISCS FEATURING MUSIC AND ENTERTAINMENT, NAMELY, ANIMATED CARTOONS, DRAMA, COMEDY AND VIDEO GAMES; OPTICAL DISCS; DIGITAL VIDEO DISCS FEATURING MUSIC AND ENTERTAINMENT, NAMELY, ANIMATED CARTOONS, DRAMA, COMEDY AND VIDEO GAMES; PRERECORDED LASER DISCS FEATURING MUSIC AND ENTERTAINMENT, NAMELY, ANIMATED CARTOONS, DRAMA, COMEDY AND VIDEO GAMES (U.S. CLS. 21, 23, 26, 36 AND 38).

SN 75-746,898. PHOTONEX CORPORATION, BEDFORD, MA. BY ASSIGNMENT RAUSCHENBACH, KURT, BEDFORD, MA. FILED 7-9-1999.

PHOTON EXCHANGE

NO CLAIM IS MADE TO THE EXCLUSIVE RIGHT TO USE "PHOTON", APART FROM THE MARK AS SHOWN. FOR TELECOMMUNICATIONS HARDWARE, NAMELY, OPTICAL DATA AND VOICE TRANSPORT HARDWARE AND COMPUTER SOFTWARE FOR OPTICAL NETWORK MANAGEMENT, FOR USE IN THE FIELDS OF TELECOMMUNICATIONS AND DATA NETWORKING FOR LONG-HAUL END-TO-END TELECOMMUNICATIONS SYSTEMS, AND EXCLUDING FIBER OPTIC COMMUNICATION APPARATUS IN THE NATURE OF LASER AND OPTICAL TRANSMITTERS AND RECEIVERS (U.S. CLS. 21, 23, 26, 36 AND 38).

SN 75-775,530. RICHARD TELL ASSOCIATES, INC., LAS VEGAS, NV. FILED 9-10-1999.

TOWERCALC

FOR COMPUTER SOFTWARE APPLICATION TOOL PROVIDING GRAPHIC ON-SITE ANALYSIS USED TO EVALUATE AND MANIPULATE COMPLEX ANTENNA SITES TO OBTAIN COMPLIANCE WITH REGULATIONS FOR HUMAN EXPOSURE TO RADIO FREQUENCY FIELDS (U.S. CLS. 21, 23, 26, 36 AND 38). FIRST USE 11-1-1997; IN COMMERCE 1-28-1998.

CLASS 9—(Continued).

SN 75-790,428. PARENTE TECHNOLOGY LLC, WILKES BARRE, PA. BY ASSIGNMENT INTEGRATED SYSTEMS GROUP, INC., INDIANAPOLIS, IN. FILED 9-28-1999.



FOR COMPUTER SOFTWARE FOR WEB ENABLING ORDER PROCESSING AND CUSTOMER SERVICE PROCESSING FOR THE SALE OF PRODUCTS ON THE INTERNET (U.S. CLS. 21, 23, 26, 36 AND 38).

SN 75-798,372. PENTAWAVE, INC., SCOTTSDALE, AZ. FILED 9-13-1999.

IDEALHIRE

FOR COMPUTER SOFTWARE FOR PROVIDING A SEARCHABLE LISTING OF JOB OPPORTUNITIES AND/OR JOB SEEKERS AND INSTRUCTION MANUAL SOLD AS A UNIT (U.S. CLS. 21, 23, 26, 36 AND 38). FIRST USE 3-0-2000; IN COMMERCE 3-0-2000.

SN 75-799,963. FORD MOTOR COMPANY, DEARBORN, MI. FILED 9-15-1999.

BUYERCONNECTION.COM

FOR COMPUTER SOFTWARE IN THE FIELD OF ONLINE SALES OF VEHICLES AND VEHICLE PARTS AND SERVICES, COMPUTER SOFTWARE IN THE FIELD OF ONLINE FINANCING OF VEHICLES; COMPUTER SOFTWARE IN THE FIELD OF ONLINE ORDERING OF VEHICLES TO THE PURCHASER'S SPECIFICATIONS; COMPUTER SOFTWARE IN THE FIELD OF ONLINE DELIVERY OF INFORMATION RELATING TO VEHICLES; COMPUTER SOFTWARE IN THE FIELD OF PURCHASING VEHICLES; COMPUTER SOFTWARE IN THE FIELD OF CUSTOMER SERVICES, AND COMPUTER SOFTWARE IN THE FIELD OF CUSTOMER RELATIONSHIP MANAGEMENT (U.S. CLS. 21, 23, 26, 36 AND 38).

SN 75-809,256. MICROTEK INTERNATIONAL INC., HSINCHU, TAIWAN 300, R.O.C., TAIWAN, FILED 9-27-1999.

TAKE-IT

OWNER OF U.S. REG. NO. 2,277,271. FOR DIGITAL CAMERAS AND IMAGE SCANNERS, AND, COMPUTER HARDWARE AND SOFTWARE FOR USE WITH IMAGE SCANNERS AND DIGITAL PHOTOGRAPHIC CAMERAS (U.S. CLS. 21, 23, 26, 36 AND 38).

CLASS 9—(Continued).

SN 75-813,908. PYXIS CORPORATION, SAN DIEGO, CA.
FILED 10-4-1999.

PYXISCONSULTANT

OWNER OF U.S. REG. NO. 1,813,422.
FOR SOFTWARE THAT INTEGRATES PATIENT,
COST, TREATMENT AND OUTCOME DATA OF
HEALTHCARE INSTITUTIONS (U.S. CLS. 21, 23, 26, 36
AND 38).

SN 75-823,509. SQLIAISON INC., ST-LAURENT, QUEBEC,
CANADA, FILED 10-15-1999.

FELLOW DSS

PRIORITY CLAIMED UNDER SEC. 44(D) ON CANADA
APPLICATION NO. 1012557, FILED 4-16-1999, REG. NO.
TMA544838, DATED 5-10-2001, EXPIRES 5-10-2016.

NO CLAIM IS MADE TO THE EXCLUSIVE RIGHT TO
USE "DSS", APART FROM THE MARK AS SHOWN.

FOR COMPUTER PROGRAM FOR DATA MANAGE-
MENT FOR USE IN THE FIELD OF INSURANCE (U.S.
CLS. 21, 23, 26, 36 AND 38).

SN 75-841,245. CHARLES INDUSTRIES, LTD., ROLLING
MEADOWS, IL. FILED 11-5-1999.



FOR ELECTRICAL, NAUTICAL, TELECOMMUNICA-
TIONS, DATA, VOICE, SIGNALING AND TRANSMIS-
SION APPARATUS AND INSTRUMENTS, NAMELY,
ELECTRIC LOAD COILS, NOISE SUPPRESSION ELEC-
TRIC CONDUCTORS, ELECTRICAL IMPEDANCE COM-
PENSATORS, CAPACITORS, LIGHT EMITTING
DIODES, ELECTRICAL RESISTORS, BUILD OUT LAT-
TICE NETWORKS IN THE NATURE OF RETURN LOSS
CORRECTION DEVICES, ELECTRICAL INDUCTORS,
CUTOVER DEVICES IN THE NATURE OF CABLE
INSTALLATION DEVICES, BRIDGE LIFTERS IN THE
NATURE OF A DEVICE THAT ISOLATES BRIDGED
TELEPHONE COPPER PAIRS, WIRE TERMINALS AND
TERMINAL BLOCKS, RADIO FREQUENCY INTERFER-
ENCE SUPPRESSION NETWORKS, ELECTRICAL GEN-
ERATORS, BATTERIES, BATTERY CHARGERS,
ELECTRICAL ADAPTERS AND ELECTRICAL TRANS-
FORMERS; ELECTRICAL POWER CENTERS COM-
PRISED OF ELECTRICAL POWER, TELEPHONES,
TELEVISION AND CABLE TELEVISION RECEIVERS,
WATER AND ELECTRICAL CONNECTIONS AND
USAGE METERS; ELECTRICAL, TELEPHONE AND
CABLE TELEVISION CABLE, WIRES AND CORDS,
E.G. ELECTRICAL CABLE, WIRES AND CORDS, CABLE
AND WIRE TRACKING TOOLS FOR TELEPHONE
TONE IDENTIFICATION; GENERATORS AND TERMI-
NATION AND SIGNALING AND TRANSMISSION
EQUIPMENT, NAMELY, PRIVATE LINE ANALOGUE

CLASS 9—(Continued).

EQUIPMENT FOR TELECOMMUNICATIONS, POWER
SUPPLIES, TEMPERATURE SENSORS, COMPUTERS,
TELECOMMUNICATIONS SIGNAL CONVERTERS, DI-
GITAL MULTI-LINE PAIR GAIN EQUIPMENT, TELE-
PHONE AND TELEPHONE DATA TRANSMITTERS,
TELECOMMUNICATIONS TRANSMISSION BRIDGE
CIRCUITS, TELEPHONE AND TELEPHONE DATA RE-
CEIVERS, NAMELY, TELECOMMUNICATIONS MOD-
ULES FOR RECEIVING TELECOMMUNICATIONS
DATA, ELECTRICAL GROUNDING SYSTEMS COM-
PRISED OF TWO WIRE PAIR ELECTRICAL TERMINAL
HOUSINGS, CONNECTORS, PRINTED CIRCUIT
BOARDS, DIAGNOSTIC DEVICES FOR TESTING OUT-
SIDE OR INSIDE PLANT WIRING FOR TELECOMMU-
NICATIONS EQUIPMENT, TIMING DEVICES FOR
TELECOMMUNICATIONS SIGNALING AND ALARM
MODULES FOR EQUIPMENT SIGNAL ERROR INDICA-
TIONS; ENCLOSURES, CASES AND HOUSINGS FOR
ALL OF THE AFORESAID GOODS AND PARTS THERE-
FOR FOR ALL OF THE AFORESAID GOODS (U.S. CLS.
21, 23, 26, 36 AND 38).

FIRST USE 1-1-1998; IN COMMERCE 1-1-1998.

SN 75-841,498. PRIMARY CHILDREN'S MEDICAL CENTER
FOUNDATION, SALT LAKE CITY, UT. FILED 11-5-1999.

**THE CHILD FIRST AND
ALWAYS**

FOR PROMOTIONAL AND EDUCATIONAL MATERI-
ALS, NAMELY, VIDEOCASSETTES, AUDIO CASSETTES
AND OPEN REEL TAPES, FEATURING PROGRAMS IN
THE FIELDS OF HEALTH CARE FOR CHILDREN AND
CHILD ADVOCACY FOR PROMOTING PROPER
HEALTH FOR CHILDREN (U.S. CLS. 21, 23, 26, 36
AND 38).

SN 75-863,836. GALAXY SCIENTIFIC CORPORATION,
WARMINSTER, PA. FILED 12-4-1999.



NO CLAIM IS MADE TO THE EXCLUSIVE RIGHT TO
USE "CORPORATION" AND "INNOVATIVE TECHNICAL
SOLUTIONS", APART FROM THE MARK AS SHOWN.

FOR COMPUTER SOFTWARE DEVELOPMENT
TOOLS FOR USE IN THE DEVELOPMENT OF EDUCA-
TIONAL INTELLIGENT TUTORING SYSTEM SOFT-
WARE (U.S. CLS. 21, 23, 26, 36 AND 38).

FIRST USE 6-15-1997; IN COMMERCE 6-15-1997.

CLASS 9—(Continued).

SN 75-866,402. CASINO DATA SYSTEMS, LAS VEGAS, NV. FILED 12-6-1999.

JACKPOT MANOR

NO CLAIM IS MADE TO THE EXCLUSIVE RIGHT TO USE "JACKPOT", APART FROM THE MARK AS SHOWN. FOR GAMING DEVICES, NAMELY, GAMING MACHINES AND COMPUTER GAME SOFTWARE USED THEREWITH (U.S. CLS. 21, 23, 26, 36 AND 38). FIRST USE 9-1-2001; IN COMMERCE 10-1-2001.

SN 75-867,605. KEYCORP LIMITED, CHATSWOOD, NEW SOUTH WALES 2067, AUSTRALIA, FILED 12-9-1999.

TRUST AGENT

PRIORITY CLAIMED UNDER SEC. 44(D) ON AUSTRALIA APPLICATION NO. 798408, FILED 6-25-1999, REG. NO. 798408, DATED 6-25-1999, EXPIRES 6-25-2009.

FOR COMPUTER HARDWARE; COMPUTER ACCESSORIES, NAMELY KEYBOARDS, KEYPADS, MONITORS, BAR-CODE SCANNERS; ENCODED MAGNETIC AND SMART CARD READERS AND WRITERS; ENCODED MAGNETIC CARDS AND SMART CARDS, NAMELY, CREDIT CARDS, DEBIT CARDS AND CARDS ENCODED WITH PERSONAL AND/OR FINANCIAL DATA, INFORMATION AND SECURITY DETAILS; COMPUTER TERMINALS NAMELY POINT OF SALE TERMINALS; COMPUTER PRINTERS NAMELY THERMAL AND LASER PRINTERS AND RECEIPT PRINTERS; COMPUTER SOFTWARE, NAMELY SOFTWARE FOR MANAGEMENT OF POINT OF SALE SYSTEMS; ENCRYPTION AND AUTHORIZATION SOFTWARE, NAMELY, SOFTWARE FOR SECURE TRANSMISSION OF DATA, INFORMATION AND SECURITY DETAILS OVER LOCAL AREA NETWORKS, WIDE AREA NETWORKS AND GLOBAL COMPUTER NETWORKS; FINANCIAL TRANSACTION SOFTWARE, NAMELY, SOFTWARE FOR FACILITATING ELECTRONIC PAYMENTS, FUND TRANSFERS AND ELECTRONIC PROCESSING AND TRANSMISSION OF BILL PAYMENT DATA; AND SMART CARD COMPUTER OPERATING SYSTEMS (U.S. CLS. 21, 23, 26, 36 AND 38).

SN 75-867,969. NEC AMERICA, INC., MELVILLE, NY. FILED 12-9-1999.

OPENWORX

FOR COMPUTER SOFTWARE THAT RUNS ON A COMPUTER SERVER FOR PROVIDING TELEPHONY AND CALL HANDLING FUNCTIONS, NAMELY, CALL ANSWERING, CALL FORWARDING, CALL MESSAGING, DIALING, RECIPIENT LOCATION, TELEPHONE DIRECTORY, AND MULTIPLE USER ACCESS, FOR USE IN CONNECTION WITH A PROPRIETARY TELEPHONE SWITCHING SYSTEM IN A NETWORK ENVIRONMENT; SOFTWARE DEVELOPMENT TOOLS, NAMELY SOFTWARE FOR INTEGRATION WITH OTHER APPLICATIONS (U.S. CLS. 21, 23, 26, 36 AND 38).

CLASS 9—(Continued).

SN 75-872,842. AHEAD SOFTWARE GMBH, D-76307 KARLSBAD-ITTERSBAACH, FED REP GERMANY, FILED 12-15-1999.

INCD

PRIORITY CLAIMED UNDER SEC. 44(D) ON ERPNTY TM OFC APPLICATION NO. 001206747, FILED 6-15-1999, REG. NO. 1206747, DATED 10-18-2000, EXPIRES 10-18-2010.

FOR COMPUTER AND DATA PROCESSING EQUIPMENT, NAMELY PERSONAL COMPUTERS, COMPUTER DISK DRIVES FOR USE WITH FLOPPY DISCS, COMPUTER DISCS, DIGITAL VIDEO DISCS, STORAGE DISKS AND PARTS THEREOF; ELECTRONIC DATA INPUT EQUIPMENT AND OUTPUT EQUIPMENT, NAMELY COMPUTER PRINTERS, GRAPHIC PROJECTION SCREENS, KEYBOARDS, ELECTRONIC DRAWING UNITS, NAMELY COMPUTER MICE, GRAPHIC TABLETS AND OPTICAL SCANNERS; MACHINE READABLE BLANK MAGNETIC DATA CARRIERS AND BLANK MAGNETIC AND OPTICAL DATA CARRIERS USED WITH COMPUTER SOFTWARE AND COMPUTER PROGRAMS TO READ, WRITE, AND ERASE MAGNETIC DATA CARRIERS AND MAGNETIC OPTICAL DATA CARRIERS WITH READ AND OVERWRITE CAPABILITY; COMPUTER OPERATING PROGRAMS FOR MACHINE READABLE MAGNETIC DATA CARRIERS AND MAGNETIC OPTICAL DATA CARRIERS, NAMELY COMPUTER STORAGE DISKS, FLOPPY DISKS, COMPUTER DISKS, CD-ROMS, DIGITAL VIDEO DISKS; BLANK COMPACT DISKS FOR READ AND OVERWRITE OF DATA AND PRE-RECORDED COMPACT DISKS FEATURING AUDIO DATA, IMAGE DATA, VIDEO DATA, TEXT DATA, DOCUMENTS STORED IN ASC II, ANS I OR A MARKUP LANGUAGE, DATABASE DATA AND PROGRAM CODES; COMPUTER PROGRAMS FOR FORMATTING AND PREPARING BLANK MAGNETIC AND BLANK MAGNETIC OPTICAL DATA CARRIERS (U.S. CLS. 21, 23, 26, 36 AND 38).

SN 75-873,669. MICROSOFT CORPORATION, REDMOND, WA. FILED 12-16-1999.

MSN

OWNER OF U.S. REG. NOS. 2,014,296, 2,153,763 AND OTHERS.

FOR COMPUTER PROGRAMS FOR ACCESSING COMPUTER NETWORKS AND GLOBAL COMMUNICATION NETWORKS; COMPUTERS AND COMPUTER PERIPHERALS; HANDHELD AND PORTABLE COMPUTERS; COMPUTERS USED TO ACCESS THE INTERNET; HANDHELD COMMUNICATION DEVICES, NAMELY, CELLULAR PHONES, CORDLESS TELEPHONES, RADIO TELEPHONES, RADIO PAGERS; ELECTRONIC PERSONAL DIGITAL ORGANIZERS; TELEVISIONS; CABLE AND SATELLITE TELEVISION BOXES AND ACCESSORIES THEREFOR FOR PROVIDING AND UTILIZING ON-SCREEN ELECTRONIC SCHEDULES FOR BROADCAST, CABLE AND SATELLITE PROGRAM LISTINGS AND ENTERTAINMENT SERVICES; ELECTRONIC CABLE TELEVISION CONTROLLERS; REMOTE CONTROLS FOR TELEVISIONS; ELECTRONIC EQUIPMENT FOR RECEIVING AND PROCESSING SATELLITE SIGNALS, NAMELY, SATELLITE RECEIVERS, SATELLITE DISH ANTENNAS AND REMOTE CONTROLS FOR SATELLITE, AUDIO AND VIDEO RECEIVERS; RADIOS; TELEPHONES (U.S. CLS. 21, 23, 26, 36 AND 38).

CLASS 9—(Continued).

SN 75-879,983. SYSTEMES ET TECHNOLOGIES IDENTIFICATION STID, 92260 FONTENAY-AUX-ROSES, FRANCE, FILED 12-20-1999.



PRIORITY CLAIMED UNDER SEC. 44(D) ON FRANCE APPLICATION NO. 99798860, FILED 6-22-1999, REG. NO. 99798860, DATED 6-22-1999, EXPIRES 6-22-2009.

THE LININGS IN THE DRAWING REPRESENT THE COLORS RED AND BLUE.

FOR ELECTRONIC IDENTIFICATION SYSTEMS, NAMELY, SHORT, MEDIUM AND LONG RANGE RADIO FREQUENCY PROXIMITY CONTROLLERS, READERS AND WRITERS FOR ELECTRONIC ACCESS, INVENTORY AND QUALITY CONTROL, IDENTIFICATION, TRACKING, AND TIME AND ATTENDANCE KEEPING; AND FOR TRANSPONDERS USED WITH RADIO FREQUENCY PROXIMITY READERS AND WRITERS (U.S. CLS. 21, 23, 26, 36 AND 38).

SN 75-881,939. RIDGE OUTDOORS USA, INC., EUSTIS, FL. FILED 12-28-1999.

ROCKY MOUNTAIN OPTICS

NO CLAIM IS MADE TO THE EXCLUSIVE RIGHT TO USE "OPTICS", APART FROM THE MARK AS SHOWN. FOR RIFLE SCOPES AND BINOCULARS (U.S. CLS. 21, 23, 26, 36 AND 38).

FIRST USE 10-13-1998; IN COMMERCE 10-13-1998.

SN 75-889,449. DEGUSSA-HULS AKTIENGESELLSCHAFT, 60311 FRANKFURT AM MAIN, FED REP GERMANY, FILED 12-23-1999.

PMEMBRAN

OWNER OF FED REP GERMANY REG. NO. 39921773, DATED 7-20-1999, EXPIRES 4-30-2009.

FOR FUEL CELL PARTS, NAMELY, CATALYST COATED MEMBRANES; FUEL CELL PARTS, NAMELY, CATALYST COATED MEMBRANES FOR USE IN FUEL CELL DRIVEN VEHICLES (U.S. CLS. 21, 23, 26, 36 AND 38).

SN 75-894,635. ROPER SCIENTIFIC, INC., TUCSON, AZ. FILED 1-7-2000.

PHOTOMETRICS

SEC. 2(F). FOR SCIENTIFIC INSTRUMENTATION, NAMELY, DIGITAL CAMERAS (U.S. CLS. 21, 23, 26, 36 AND 38). FIRST USE 0-0-1979; IN COMMERCE 0-0-1979.

CLASS 9—(Continued).

SN 75-895,637. DOLPHIN INTERCONNECT SOLUTIONS AS, N-0621 OSLO, NORWAY, FILED 1-12-2000.

WULFKIT

FOR KITS CONTAINING COMPUTER HARDWARE, SOFTWARE AND COMPUTER PERIPHERALS FOR THE PURPOSE OF ENABLING THE CONSTRUCTION OF POWERFUL, SCALABLE, PARALLEL PROCESSOR COMPUTER SYSTEMS (U.S. CLS. 21, 23, 26, 36 AND 38). FIRST USE 7-1-1999; IN COMMERCE 7-1-1999.

SN 75-896,991. DATUM INC., IRVINE, CA. FILED 1-14-2000.

TRUSTED TIME INFRASTRUCTURE

NO CLAIM IS MADE TO THE EXCLUSIVE RIGHT TO USE "TIME INFRASTRUCTURE", APART FROM THE MARK AS SHOWN.

FOR SECURE TIMING SYSTEMS, COMPRISED OF COMPUTERS, COMPUTER HARDWARE MEMORY CARDS, BLANK INTEGRATED CIRCUIT CARDS, ENCODED INTEGRATED CIRCUIT CARDS CONTAINING PROGRAMMING USED TO PROVIDE AN ACCURATE AND SECURE TIME-STAMP, ELECTRONIC TIMERS, MODULES FOR TIME-STAMPING, HARDWIRED ALARM PROCESSING UNITS, WIRELESS ALARM PROCESSING UNITS, SENSORS, CENTRAL MONITORING UNITS, CONTROL SOFTWARE FOR TIMING SYSTEMS, SOFTWARE FOR ENCODING SECURE COMMUNICATIONS, AND SOFTWARE FOR PROVIDING SECURE TIME-STAMPS (U.S. CLS. 21, 23, 26, 36 AND 38).

SN 75-904,745. INFINEON TECHNOLOGIES AG, MUNICH, FED REP GERMANY, FILED 1-28-2000.

**UCP
Universal Cordless Platform**

OWNER OF FED REP GERMANY REG. NO. 39913613, DATED 6-24-1999, EXPIRES 3-31-2009.

NO CLAIM IS MADE TO THE EXCLUSIVE RIGHT TO USE "UNIVERSAL CORDLESS PLATFORM", APART FROM THE MARK AS SHOWN.

FOR ELECTROTECHNICAL AND ELECTRONIC APPARATUS AND ELECTRONIC COMPONENTS, NAMELY, INTEGRATED CIRCUITS TO BE USED IN TELECOMMUNICATION SYSTEMS TO TRANSFER SPEECH AND DATA (U.S. CLS. 21, 23, 26, 36 AND 38).

SN 75-908,795. HOLLAND, GREG, VENICE, CA. FILED 2-2-2000.

MECODE

FOR COMPUTER SOFTWARE FOR STORING AND MANAGING PERSONAL INFORMATION DATABASES AND COMPUTER E-COMMERCE SOFTWARE TO ALLOW USERS TO PERFORM ELECTRONIC BUSINESS TRANSACTIONS VIA A GLOBAL COMPUTER NETWORK (U.S. CLS. 21, 23, 26, 36 AND 38).

CLASS 9—(Continued).

SN 75-915,715. SANDIA CORPORATION, ALBUQUERQUE, NM. FILED 2-9-2000.

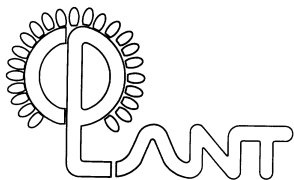

FOR COMPUTER HARDWARE, COMPUTER SOFTWARE, NAMELY OPERATING SYSTEMS, PROGRAMMING UTILITIES, AND SOFTWARE LIBRARIES FOR DISTRIBUTED AND PARALLEL COMPUTERS (U.S. CLS. 21, 23, 26, 36 AND 38).

FIRST USE 1-21-1999; IN COMMERCE 1-21-1999.

SN 75-919,897. TELECOMMUNICATION SYSTEMS, INC., ANNAPOLIS, MD. FILED 2-18-2000.

MO CHAT

NO CLAIM IS MADE TO THE EXCLUSIVE RIGHT TO USE "CHAT", APART FROM THE MARK AS SHOWN.

FOR COMPUTER COMMUNICATIONS SOFTWARE USED TO PROVIDE ACCESS TO THE INTERNET AND TELEPHONE NETWORKS FOR TEXT MESSAGING, PAGING AND TELEPHONE SERVICE (U.S. CLS. 21, 23, 26, 36 AND 38).

FIRST USE 1-4-2000; IN COMMERCE 1-4-2000.

SN 75-930,990. TOOHEY COMPANY, FAIRFIELD, NJ. FILED 2-28-2000.

DIAGNOSTECH

FOR COMPUTER HARDWARE AND SOFTWARE USED FOR REMOTE EQUIPMENT DIAGNOSIS, NAMELY TO EVALUATE WHETHER EQUIPMENT, NAMELY, SCIENTIFIC EQUIPMENT AND INSTRUMENTS AND CONSUMER ELECTRONICS, IS FUNCTIONING PROPERLY (U.S. CLS. 21, 23, 26, 36 AND 38).

SN 75-931,605. TOOHEY COMPANY, FAIRFIELD, NJ. FILED 2-28-2000.

DiagnosTech

FOR COMPUTER HARDWARE AND SOFTWARE USED FOR REMOTE EQUIPMENT DIAGNOSIS, NAMELY TO EVALUATE WHETHER EQUIPMENT, NAMELY, SCIENTIFIC EQUIPMENT AND INSTRUMENTS AND CONSUMER ELECTRONICS, IS FUNCTIONING PROPERLY (U.S. CLS. 21, 23, 26, 36 AND 38).

CLASS 9—(Continued).

SN 75-933,433. EVENTUS LOGISTICS (1998) LTD., RAMATGAN 52521, ISRAEL, FILED 3-1-2000.

DEMANTRA

FOR COMPUTER SOFTWARE FOR USE BY BUSINESS ENTERPRISES FOR FORECASTING AND ANALYZING CUSTOMER DEMAND, AND FOR BUSINESS PLANNING AND PROCUREMENT (U.S. CLS. 21, 23, 26, 36 AND 38).

SN 75-933,845. WHITEHILL TECHNOLOGIES, INC., MONCTON, NEW BRUNSWICK, CANADA, FILED 3-3-2000.

WHITEHILL

FOR HOUSE MARK FOR A FULL LINE OF COMPUTER SOFTWARE FOR DOCUMENTS TRANSFORMATION, DATA EXTRACTION, CONVERSION AND DELIVERY, AND AUTOMATING BUSINESS INVOICES AND BUSINESS REPORTS (U.S. CLS. 21, 23, 26, 36 AND 38).

FIRST USE 1-0-1997; IN COMMERCE 1-0-1997.

SN 75-936,329. BENTLEY SYSTEMS, INCORPORATED, EXTON, PA. FILED 3-4-2000.

**MODELSERVER
INTEGRATOR**

OWNER OF U.S. REG. NOS. 2,174,368, 2,304,653 AND OTHERS.

NO CLAIM IS MADE TO THE EXCLUSIVE RIGHT TO USE "INTEGRATOR", APART FROM THE MARK AS SHOWN.

FOR COMPUTER SOFTWARE THAT PERMITS USERS TO INTERACTIVELY VIEW AND QUERY COMPUTER AIDED DESIGN FILES, DATA FILES, DRAWING FILES AND ENGINEERING FILES ACROSS CORPORATE AND GLOBAL COMPUTER NETWORKS, AND MANUALS SOLD AS A UNIT (U.S. CLS. 21, 23, 26, 36 AND 38).

FIRST USE 12-0-1999; IN COMMERCE 12-0-1999.

SN 75-936,728. WEINBERG, ROBERT, SANTA MONICA, CA. FILED 3-6-2000.

OTHERSOFTWARE

FOR COMPUTER SOFTWARE USED FOR DATABASE MANAGEMENT, SPREADSHEETS, WORD PROCESSING, AND OTHER SOFTWARE APPLICATIONS, NAMELY, SOFTWARE USED TO ACCESS COMPUTER GAMES FROM THE GLOBAL COMPUTER NETWORK (U.S. CLS. 21, 23, 26, 36 AND 38).

FIRST USE 3-2-2000; IN COMMERCE 3-2-2000.

CLASS 9—(Continued).

SN 76-000,029. AURAN HOLDINGS PTY. LTD., TENERIFFE, QUEENSLAND 4005, AUSTRALIA, FILED 3-14-2000.

AURAN JET

PRIORITY CLAIMED UNDER SEC. 44(D) ON AUSTRALIA APPLICATION NO. 807068, FILED 9-14-1999, REG. NO. 807068, DATED 9-14-1999, EXPIRES 9-14-2009.

FOR COMPUTER GAME SOFTWARE AND INTERACTIVE MULTIMEDIA SOFTWARE; COMPUTER SOFTWARE USED TO DESIGN AND DEVELOP GAMING, MULTIMEDIA, VIDEO AND AUDIO PRODUCTS, NAMELY, COMPUTER GAME PROGRAMS AND INTERACTIVE THREE-DIMENSIONAL EDUCATIONAL, TRAINING AND SIMULATION PROGRAMS; COMPUTER PROGRAMMING MODULES, NAMELY, GAME ENGINE AND REPLACEABLE AND/OR EXTENDIBLE MODULAR SOFTWARE COMPONENT SYSTEMS, NAMELY, AN APPLICATION PROGRAM INTERFACE AND OTHER SOFTWARE COMPONENT SYSTEMS USED TO CREATE COMPUTER GAME PROGRAMS AND INTERACTIVE THREE-DIMENSIONAL EDUCATIONAL, TRAINING AND SIMULATION PROGRAMS (U.S. CLS. 21, 23, 26, 36 AND 38).

SN 76-004,872. FSONA COMMUNICATIONS CORPORATION, WHITE ROCK, BRITISH COLUMBIA V4A 7Y1, CANADA, FILED 3-20-2000.

SONABEAM

FOR OPTICAL WIRELESS COMMUNICATION PRODUCTS FOR HIGH SPEED DATA TRANSMISSION, NAMELY, LASER TRANSCIEVERS, LASER RECEIVERS AND ANCILLARY PRODUCTS THERETO, NAMELY, INTERFACE UNITS AND INTERFACE CARDS; OPTICAL WIRELESS COMMUNICATION ACCESSORIES, NAMELY, TILT AND SWIVEL MOUNTS AND FIXED MOUNTS FOR LASER TRANSCIEVERS, RECEIVERS, INTERFACE UNITS AND CARDS; WATERPROOF CASINGS FOR LASER TRANSCIEVERS, RECEIVERS, INTERFACE UNITS AND CARDS; DIAGNOSTIC TOOLS FOR COMMUNICATIONS SYSTEMS FOR THE PURPOSE OF DIAGNOSING LASER TRANSCIEVERS, RECEIVERS, INTERFACE UNITS AND CARDS (U.S. CLS. 21, 23, 26, 36 AND 38).

SN 76-007,168. ADVANCED CORNEAL ENGINEERING, INC., PORTLAND, OR. FILED 3-22-2000.

NIGHTMOVE

FOR CONTACT LENSES (U.S. CLS. 21, 23, 26, 36 AND 38).
FIRST USE 8-30-1998; IN COMMERCE 8-30-1998.

CLASS 9—(Continued).

SN 76-008,995. ORCHID BIOSCIENCES, INC., PRINCETON, NJ. BY CHANGE OF NAME ORCHID BIOCMPUTER, INC., PRINCETON, NJ. FILED 3-24-2000.

ALLELOGRAPH

FOR COMPUTER SOFTWARE AND HARDWARE FOR CHROMOSOME ANALYSIS IN THE FIELD OF GENETIC RESEARCH (U.S. CLS. 21, 23, 26, 36 AND 38).

SN 76-010,497. KALAWAR, JAYANT, WEST WINDSOR, NJ. FILED 3-27-2000.

ECIOSOFT

FOR INTERACTIVE SOFTWARE PROGRAMS FOR USE BY GROUPS WORKING ON BEHALF OF AN ORGANIZATION WHICH FACILITATE THE EXCHANGE OF BUSINESS INFORMATION, NAMELY, SOFTWARE FOR USE IN CREATING AN ONLINE ENVIRONMENT THAT ENABLES USERS TO REVIEW AND ANALYZE BUSINESS INFORMATION IN ORDER TO MAKE STRATEGIC BUSINESS DECISIONS (U.S. CLS. 21, 23, 26, 36 AND 38).

FIRST USE 10-0-1999; IN COMMERCE 12-0-1999.

SN 76-010,935. ROCKWOOD MUSIC GROUP, L.L.C., CHICAGO, IL. FILED 3-23-2000.

CHAMELEON

FOR PRERECORDED PHONOGRAPH RECORDS, AUDIO AND VIDEO CASSETTE TAPES AND DISCS, AND COMPACT DISCS, ALL FEATURING MUSICAL ENTERTAINMENT (U.S. CLS. 21, 23, 26, 36 AND 38).

CLASS 9—(Continued).

SN 76-013,307. J. PAUL GETTY TRUST, THE, LOS ANGELES, CA. FILED 3-30-2000.

THE J. PAUL GETTY MUSEUM

OWNER OF U.S. REG. NOS. 2,091,377, 2,091,399 AND OTHERS.

NO CLAIM IS MADE TO THE EXCLUSIVE RIGHT TO USE "MUSEUM", APART FROM THE MARK AS SHOWN.

THE NAME "J. PAUL GETTY" SHOWN IN THE MARK DOES NOT IDENTIFY A LIVING INDIVIDUAL.

FOR COMPUTER SOFTWARE AND PRE-RECORDED AUDIO AND VIDEO TAPES, COMPACT DISCS, CD-ROMS, PHONOGRAPH RECORDS, OPTICAL DISCS, LASER DISCS, SLIDE TRANSPARENCIES AND DIGITAL TAPES, ALL CONTAINING INFORMATION AND EDUCATIONAL PROGRAMS PERTAINING TO THE ARTS AND HUMANITIES; COMPUTER SOFTWARE USED FOR SEARCHING AND MATCHING PERSONS' NAMES IN THE FIELDS OF THE ARTS AND HUMANITIES; COMPUTER SOFTWARE, PRE-RECORDED AUDIO AND VIDEO TAPES AND COMPACT DISCS, ALL COMPRISING A THESAURUS OF RELATED TERMS AND WORDS FOR USE IN INDEXING AND CATALOGUING ARTWORKS AND CULTURAL PROPERTIES; COMPUTER SOFTWARE, PRE-RECORDED AUDIO AND VIDEO TAPES AND COMPACT DISCS, ALL FEATURING THE NAMES OF INDIVIDUALS, RELATED BIOGRAPHICAL AND GEOGRAPHICAL INFORMATION AND RELATED REFERENCES TO OTHER PUBLICATIONS FOR USE IN INDEXING AND CATALOGUING ARTWORKS AND CULTURAL PROPERTIES; USER MANUALS SOLD AS A UNIT WITH THE FOREGOING (U.S. CLS. 21, 23, 26, 36 AND 38).

SN 76-013,542. LANDMARK TECHNOLOGY HOLDINGS CORPORATION, WILMINGTON, DE. FILED 3-30-2000.

TMON

FOR COMPUTER OPERATING SYSTEMS SOFTWARE (U.S. CLS. 21, 23, 26, 36 AND 38).

SN 76-014,024. BEY, JOHN, OAKLAND, CA. FILED 3-31-2000.

NILESTATION

FOR COMPUTER WORK STATIONS COMPRISING COMPUTERS, MONITORS, KEYBOARDS AND MOUSE (U.S. CLS. 21, 23, 26, 36 AND 38).

CLASS 9—(Continued).

SN 76-014,523. RATEINTEGRATION, INC., MCLEAN, VA. FILED 3-31-2000.



THE MARK CONSISTS OF THE LETTERS RI IN STYLIZED FORM.

FOR COMPUTER SOFTWARE PROGRAMS FOR USE IN SETTING PRICING FOR USE ON GLOBAL COMPUTER NETWORKS, WEB HOSTING, WEB SITE CONTENT, ELECTRONIC COMMERCE, TELEPHONY AND OTHER PER USE DIGITAL SERVICES (U.S. CLS. 21, 23, 26, 36 AND 38).

SN 76-018,751. MILIARAS, BARBARA, WINCHESTER, MA. FILED 10-4-1999.

TRIADHA

THE ENGLISH TRANSLATION OF "TRIADHA" IS "TRINITY".

FOR COMPUTER PROGRAMS, PRE-RECORDED VIDEO CASSETTES, AND MOTION PICTURE FILMS, ALL FOR EDUCATIONAL USE CONTAINING THEMES RELATING TO HISTORY, ART, SCIENCE, GEOGRAPHY, MATH, CULTURE, NATURE, COMPUTERS, BIOGRAPHIES, LITERATURE, DRAMA, CREATIVITY, CRITICAL THINKING, LANGUAGE SKILLS, WRITING, GRAMMAR AND SPELLING (U.S. CLS. 21, 23, 26, 36 AND 38).

SN 76-023,082. NOVA MEASURING INSTRUMENTS LTD., REHOVOTH, 76100, ISRAEL, FILED 4-10-2000.

NOVASCAN

PRIORITY CLAIMED UNDER SEC. 44(D) ON ISRAEL APPLICATION NO. 133704, FILED 12-31-1999.

FOR OPTICAL TEST EQUIPMENT, NAMELY, MONITORING, MEASURING AND INSPECTION INSTRUMENTS AND COMPUTER OPERATING SYSTEMS THEREOF, COMPUTER HARDWARE AND SOFTWARE ALL FOR PRODUCT QUALITY CONTROL IN THE FIELD OF SEMICONDUCTOR MANUFACTURING (U.S. CLS. 21, 23, 26, 36 AND 38).

FIRST USE 0-0-1996; IN COMMERCE 0-0-1996.

CLASS 9—(Continued).

SN 76-023,176. ATI TECHNOLOGIES INC., THORNHILL, ONTARIO, CANADA, FILED 4-11-2000.

RADEON

FOR ELECTRONIC COMPONENTS, NAMELY, MICROPROCESSORS; INTEGRATED CIRCUITS, COMPUTER CHIPSETS; INTEGRATED CIRCUIT COMPONENTS FOR GRAPHICS AND VIDEO SYSTEMS, NAMELY, MULTIMEDIA ACCELERATORS AND PERIPHERAL UNITS, NAMELY, VIDEO COMPRESSION AND DECOMPRESSION INTEGRATED CIRCUITS; COMPUTER MOTHERBOARDS AND DAUGHTER BOARDS, NAMELY COMPUTER GRAPHICS BOARDS, VIDEO AND DVB CIRCUIT BOARDS; VIDEO SYSTEMS PRODUCTS, NAMELY DVD RECORDERS, DVD PLAYERS, DIGITAL AUDIO PLAYERS, DIGITAL AUDIO RECORDERS AND SET-TOP BOXES; ALGORITHMS FOR THE COMPRESSION AND DECOMPRESSION OF DATA; ASSOCIATED COMPUTER SOFTWARE AND COMPUTER PROGRAMS FOR OPERATING THE FOREGOING, NAMELY, COMPUTER PROGRAMS FOR RECORDING, PROCESSING, RECEIVING, REPRODUCING, TRANSMITTING, MODIFYING, COMPRESSING, DECOMPRESSING, BROADCASTING, MERGING AND/OR ENHANCING SOUNDS, VIDEO, IMAGES, GRAPHICS AND DATA; COMPUTER PROGRAMS FOR ACCESSING AND USING THE WORLD WIDE WEB; TELECOMMUNICATIONS SOFTWARE FOR ACCESSING AND TRANSMITTING INFORMATION BY WAY OF CABLE, RADIO, MICROWAVE AND/OR SATELLITE SYSTEMS AND ASSOCIATED DOCUMENTATION SOLD THEREWITH; PSL MODEMS; CABLE MODEMS; PARTS, FITTINGS, AND TESTING APPARATUS FOR ALL THE AFORESAID GOODS (U.S. CLS. 21, 23, 26, 36 AND 38).

SN 76-029,199. TENROX, INC., MONTREAL OUEBEC, CANADA, FILED 4-19-2000.



FOR COMPUTER SOFTWARE, NAMELY, APPLICATION SOFTWARE FOR TIME AND EXPENSE TRACKING IMPLEMENTED AND USED VIA THE GLOBAL COMPUTER NETWORK (U.S. CLS. 21, 23, 26, 36 AND 38).

FIRST USE 2-10-2000; IN COMMERCE 2-10-2000.

SN 76-030,877. MEMQUEST, INC., FREMONT, CA. FILED 4-21-2000.

MEMQUEST

FOR INTEGRATED MEMORY CIRCUITS; INTEGRATED MEMORY CIRCUIT MODULES, CARDS, AND STICKS CONTAINING FLASH AND OTHER NON-VOLATILE MEMORY; MEMORY STORAGE SYSTEMS COMPRISING INTEGRATED MEMORY CIRCUIT MODULES, CARDS, AND STICKS CONTAINING FLASH AND OTHER NON-VOLATILE MEMORY (U.S. CLS. 21, 23, 26, 36 AND 38).

CLASS 9—(Continued).

SN 76-034,400. UNITED STATES POSTAL SERVICE, WASHINGTON, DC. FILED 4-25-2000.

POSTAL EXPLORER

NO CLAIM IS MADE TO THE EXCLUSIVE RIGHT TO USE "POSTAL", APART FROM THE MARK AS SHOWN.

FOR COMMUNICATIONS SOFTWARE FOR CONNECTING COMPUTER NETWORK USERS TO A GLOBAL COMPUTER NETWORK IN THE FIELD OF POSTAL INFORMATION; COMPUTER SOFTWARE FOR USE IN DISPLAYING POSTAL INFORMATION; COMPUTER SOFTWARE FOR USE IN DISPLAYING POSTAL INFORMATION THAT MAY BE DOWNLOADED FROM A GLOBAL COMPUTER NETWORK (U.S. CLS. 21, 23, 26, 36 AND 38).

FIRST USE 10-0-1997; IN COMMERCE 10-0-1997.

SN 76-042,710. IMAGETAG, INC., TEMPE, AZ. FILED 5-8-2000.

KWIKTAG

FOR COMPUTER SOFTWARE FOR STORING, RETRIEVING, AND MANAGING DIGITAL IMAGES, NAMELY, SOFTWARE THAT ALLOWS BUSINESSES TO CONVERT PAPER FILES AND RELATED ITEMS TO DIGITAL IMAGES FOR ELECTRONIC STORAGE (U.S. CLS. 21, 23, 26, 36 AND 38).

SN 76-045,208. ADAPTATIONS INC., BELLEVUE, WA. FILED 5-10-2000.

WHEN YOU GOTTA GO, YOU GOTTA GO!

FOR PRERECORDED COMPACT DISCS AND TAPES FEATURING MUSIC, VIDEOTAPES, AND COMPUTER SOFTWARE, ALL PROVIDING INFORMATION ON THE SPECIAL NEEDS OF PERSONS WITH DISABILITIES AND THE AGING POPULATION AND FUNCTIONAL AND SPACE PLANNING IN THE FIELDS OF ARCHITECTURE, INTERIOR DESIGN, AND CONSTRUCTION OF RESIDENTIAL AND COMMERCIAL STRUCTURES (U.S. CLS. 21, 23, 26, 36 AND 38).

SN 76-045,211. ADAPTATIONS INC., BELLEVUE, WA. FILED 5-10-2000.

ROOM TO ROAM

FOR PRERECORDED COMPACT DISCS AND TAPES FEATURING MUSIC, VIDEOTAPES, AND COMPUTER SOFTWARE, ALL PROVIDING INFORMATION ON THE SPECIAL NEEDS OF PERSONS WITH DISABILITIES AND THE AGING POPULATION AND FUNCTIONAL AND SPACE PLANNING IN THE FIELDS OF ARCHITECTURE, INTERIOR DESIGN, AND CONSTRUCTION OF RESIDENTIAL AND COMMERCIAL STRUCTURES (U.S. CLS. 21, 23, 26, 36 AND 38).

CLASS 9—(Continued).

SN 76-052,404. PREDICTIVE NETWORKS, INC., CAMBRIDGE, MA. FILED 5-19-2000.

THE PREDICTIVE NETWORK

NO CLAIM IS MADE TO THE EXCLUSIVE RIGHT TO USE "NETWORK", APART FROM THE MARK AS SHOWN.

FOR COMPUTER PROGRAMS FOR USE IN PERSONALIZING CONTENT DELIVERY THROUGH GLOBAL COMPUTER INFORMATION NETWORK SERVICE PROVIDER INFRASTRUCTURE; COMPUTER PROGRAMS FOR USE IN ANONYMOUSLY PROFILING GLOBAL COMPUTER INFORMATION NETWORK SERVICE SUBSCRIBERS; COMPUTER PROGRAMS FOR USE IN CREATING, EXECUTING, MODIFYING AND TRACKING ADVERTISING AND WEB CONTENT DELIVERY; COMPUTER PROGRAMS FOR COMPILING, ANALYZING AND MANAGING INFORMATION ABOUT CUSTOMER AND THEIR TRANSACTIONS; COMPUTER PROGRAMS FOR USE IN REPORTING AND BILLING APPLICATIONS; AND COMPUTER PROGRAMS FOR DELIVERING COMPUTER PROGRAMS OF OTHERS THROUGH THE GLOBAL COMPUTER INFORMATION NETWORK (U.S. CLS. 21, 23, 26, 36 AND 38).

SN 76-055,586. UNITED COMMUNICATION TECHNOLOGY, INC., CORONA, CA. FILED 5-24-2000.

DURESS-CALL

FOR ELECTRONIC ALARM ACTIVITY SYSTEM COMPRISED OF INTELLIGENT DATA COLLECTION MODULES, ALSO KNOWN AS COMPUTERS, AND PAGERS, PUSH BUTTONS, LIGHTS, POCKET PAGERS, SPEAKERS, INTERCOMS AND TELEPHONES (U.S. CLS. 21, 23, 26, 36 AND 38).

FIRST USE 5-1-1998; IN COMMERCE 5-1-1998.

SN 76-057,406. SCOTT MACHINE DEVELOPMENT CORPORATION, WALTON, NY. FILED 5-23-2000.

E-BADGE

OWNER OF U.S. REG. NO. 2,314,629.
FOR SOFTWARE FOR PRINTING SIGNS, NAMEPLATES, NAME TAGS, TEMPLATES AND PATTERNS, ON PAPER, CLEAR TRANSPARENCIES, OR PLASTIC (U.S. CLS. 21, 23, 26, 36 AND 38).

FIRST USE 5-18-2000; IN COMMERCE 5-18-2000.

CLASS 9—(Continued).

SN 76-059,196. COMPULORE, INC., LONGWOOD, FL. FILED 5-30-2000.

STORAID

FOR COMPUTERS STORAGE AND RETRIEVAL SYSTEMS, NAMELY DISK ARRAYS, NETWORK ATTACHED STORAGE, STORAGE AREA NETWORKS, AND RELATED IMPLEMENTATION, CONFIGURATION, AND IMPLEMENTATION SOFTWARE; COMPUTER HARDWARE AND SOFTWARE RELATED TO NETWORK ATTACHED STORAGE, STORAGE AREA NETWORKS, OR FILE SYSTEMS, ALL HAVING THE SPECIFIC FUNCTION OF ELECTRONIC STORAGE OF DATA IN ELECTRONIC FORMATS ON ROTATING MAGNETIC MEDIA (U.S. CLS. 21, 23, 26, 36 AND 38).

FIRST USE 5-15-2000; IN COMMERCE 5-15-2000.

SN 76-060,084. CENTREPOINT S/W TECHNOLOGIES INC., OTTAWA, ONTARIO, CANADA, FILED 5-30-2000.

TALKSWITCH

PRIORITY CLAIMED UNDER SEC. 44(D) ON CANADA APPLICATION NO. 1038049, FILED 11-30-1999.

FOR MULTI-LINE, MULTI-EXTENSION, COMPUTER TELEPHONY SYSTEM COMPRISING AN ELECTRONIC SWITCHBOARD WITH MOBILE TELECOMMUNICATIONS, FAX SCANNING, VOICE AND DATA CAPABILITIES (U.S. CLS. 21, 23, 26, 36 AND 38).

FIRST USE 2-0-2001; IN COMMERCE 2-0-2001.

SN 76-060,249. ROHDE & SCHWARZ GMBH & CO. KG, MUNICH 81671, FED REP GERMANY, FILED 6-2-2000.

ESMC

PRIORITY CLAIMED UNDER SEC. 44(D) ON FED REP GERMANY APPLICATION NO. 39976150.0/0, FILED 12-2-1999, REG. NO. 39976150, DATED 2-10-2000, EXPIRES 12-31-2009.

FOR RECEIVERS FOR RADIO MONITORING AND RADIO INTERCEPT (U.S. CLS. 21, 23, 26, 36 AND 38).

SN 76-060,895. COMMERCE INTERNET TRADING INTERNATIONAL LIMITED, TA COMMERCE NTI LIMITED, FARNHAM, SURREY, UNITED KINGDOM, FILED 6-1-2000.



PRIORITY CLAIMED UNDER SEC. 44(D) ON UNITED KINGDOM APPLICATION NO. 2215944, FILED 1-12-1999, REG. NO. 2215944, DATED 1-12-1999, EXPIRES 1-12-2009.

FOR COMPUTER SOFTWARE FOR CREDIT CARD AUTHORIZATION VIA THE INTERNET (U.S. CLS. 21, 23, 26, 36 AND 38).

CLASS 9—(Continued).

SN 76-061,072. THOMSON MULTIMEDIA INC., INDIANAPOLIS, IN. BY CHANGE OF NAME THOMSON CONSUMER ELECTRONICS, INC., INDIANAPOLIS, IN. FILED 6-1-2000.

SCENIUM

FOR TELEVISION SETS; VIDEO CASSETTE RECORDERS; DIGITAL VIDEO DISC PLAYERS; RADIOS; DISPLAY DEVICES, NAMELY, READERS FOR RECEIVING AND DISPLAYS ELECTRONICALLY PUBLISHED WORKS; DIGITAL MUSIC PLAYERS; DIGITAL STILL CAMERAS; CABLE TELEVISION RECEIVERS; DIGITAL AUDIO AND VIDEO RECEIVERS; COMPUTERS; COMPUTER HARDWARE FOR ACCESSING A GLOBAL COMPUTER NETWORK; CABLE MODEMS (U.S. CLS. 21, 23, 26, 36 AND 38).

SN 76-061,234. ONESHIELD, INC., BURLINGTON, MA. BY CHANGE OF NAME MAGNASPACE, INC., BURLINGTON, MA. FILED 6-1-2000.

ONESHIELD

FOR COMPUTER SOFTWARE FOR USE IN THE INSURANCE INDUSTRY FOR INSURANCE AGENCY CARRIER MANAGEMENT AND AUTOMATION, NAMELY, AUTOMATION AND ADMINISTRATION OF POLICY SALES, POLICY UNDERWRITING, CLAIMS ADJUDICATION AND PAYMENT, BILLING AND GENERAL MANAGEMENT OF INSURANCE POLICIES, INSURANCE POLICY RATING AND ISSUANCE, WORKFLOW MANAGEMENT, AND REPORT GENERATION (U.S. CLS. 21, 23, 26, 36 AND 38).

SN 76-061,647. ASAHI KOGAKU KOGYO KABUSHIKI KAISHA, DBA ASAHI OPTICAL CO., LTD., ITABASHIKU, TOKYO 174, JAPAN, FILED 6-2-2000.

PENTAX

OWNER OF U.S. REG. NOS. 715,035, 2,386,767 AND OTHERS.
FOR DIGITAL STILL CAMERAS AND PARTS AND ACCESSORIES THEREFOR (U.S. CLS. 21, 23, 26, 36 AND 38).

SN 76-065,566. MOVACOLOR B.V., 1689 AN ZWAAG, NETHERLANDS, FILED 6-8-2000.

MOVACOLOR

FOR DOSAGE DISPENSERS FOR MOLDING AND EXTRUSION EQUIPMENT FOR PLASTICS (U.S. CLS. 21, 23, 26, 36 AND 38).
FIRST USE 3-3-1989; IN COMMERCE 12-31-1994.

CLASS 9—(Continued).

SN 76-065,836. TICKETMASTER CORPORATION, LOS ANGELES, CA. FILED 6-9-2000.

FANtm

FOR COMPUTER SOFTWARE FOR CONTROLLING VENUE ACCESS AND COLLECTING DATA ON EVENT ATTENDANCE THROUGH SCANNING BARCODED TICKETS (U.S. CLS. 21, 23, 26, 36 AND 38).

SN 76-065,906. COMPAQ INFORMATION TECHNOLOGIES GROUP, L.P., HOUSTON, TX. FILED 6-8-2000.

LEARNINGPAQ

FOR COMPUTER PROGRAMS, NAMELY EDUCATIONAL SOFTWARE COVERING A VARIETY OF ACADEMIC SUBJECTS FOR USE IN GRADES K THROUGH 12 (U.S. CLS. 21, 23, 26, 36 AND 38).
FIRST USE 12-30-1999; IN COMMERCE 12-30-1999.

SN 76-068,587. MERCURYGUIDE, L.C., AMERICAN FORK, UT. FILED 6-12-2000.

MERCURYGUIDE

FOR COMPUTER SOFTWARE FOR USE WITH APPARATUS INTERFACING WITH GLOBAL POSITIONING SATELLITE SYSTEMS (U.S. CLS. 21, 23, 26, 36 AND 38).

SN 76-068,911. KONINKLIJKE PHILIPS ELECTRONICS N.V., EINDHOVEN, NETHERLANDS, FILED 6-12-2000.

PrimaVision

PRIORITY CLAIMED UNDER SEC. 44(D) ON BENELUX APPLICATION NO. 0957773, FILED 2-22-2000, REG. NO. 0666607, DATED 2-22-2000, EXPIRES 2-22-2010.

FOR ELECTRONIC BALLASTS AND TRANSFORMERS FOR ELECTRICAL LIGHTING SYSTEMS (U.S. CLS. 21, 23, 26, 36 AND 38).

CLASS 9—(Continued).

SN 76-072,851. SPECTRA MARKETING SYSTEMS, INC., CHICAGO, IL. FILED 6-7-2000.

ADVENTORY

FOR SOFTWARE FOR A PERSONAL COMPUTER THAT FINDS MATCHES BETWEEN AN INDIVIDUAL PRODUCT ADVERTISEMENT, THE BUDGET ALLOCATED FOR ADVERTISING THE INDIVIDUAL PRODUCT, AND PROBABLE BUYING HABITS OF AN EXPECTED VIEWING AUDIENCE OF TELEVISION PROGRAMMING IN EACH OF A QUANTITY OF TIME SLOTS, THE SOFTWARE THEN SCHEDULING EACH OF A NUMBER OF DIFFERENT INDIVIDUAL PRODUCT ADVERTISEMENTS INTO THE TIME SLOTS (U.S. CLS. 21, 23, 26, 36 AND 38).

FIRST USE 2-14-2000; IN COMMERCE 2-25-2000.

SN 76-074,544. LIFESTREAM TECHNOLOGIES, INC., POST FALLS, ID. FILED 6-21-2000.

PERSONAL FINANCIAL KEY

NO CLAIM IS MADE TO THE EXCLUSIVE RIGHT TO USE "PERSONAL FINANCIAL", APART FROM THE MARK AS SHOWN.

FOR WALLET-SIZED CARDS CONTAINING A COMPUTER-READABLE MEMORY UNIT CONFIGURED FOR EXCHANGING PERSONAL, MEDICAL AND FINANCIAL INFORMATION WITH A COMPUTER SYSTEM (U.S. CLS. 21, 23, 26, 36 AND 38).

SN 76-074,803. XANTHUS LIFE SCIENCES, INC., WOBURN, MA. BY CHANGE OF NAME; BY CHANGE OF NAME MASSTRACE, INC., WOBURN, MA. FILED 6-20-2000.

BIOGENOMICS

FOR COMPUTER SOFTWARE THAT MAKES USE OF ALGORITHMS FOR DESIGNING BIOLOGICAL COMPOUNDS THAT INTERACT WITH METABOLIC PATHWAY ENZYMES (U.S. CLS. 21, 23, 26, 36 AND 38).

SN 76-076,092. WILLIAMSON & ASSOCIATES, INC., SEATTLE, WA. FILED 6-22-2000.

C-BASS

FOR UNDERWATER ALUMINUM SLED PULLED ALONG THE SEAFLOOR CONTAINING MULTIPLEXED CHANNEL, MICROPROCESSORS, ELECTRODE ARRAY, ACOUSTIC PROFILER, AND A MINIATURE CONE PENETROMETER FOR USE IN SURVEYING AND ASSESSING BURIAL SITES OF TRANSOCEANIC SUBMARINE TELECOM CABLES (U.S. CLS. 21, 23, 26, 36 AND 38).

CLASS 9—(Continued).

SN 76-077,901. CONSUMER DIRECT-LINK, INC., IRVINE, CA. FILED 6-27-2000.

M-ADAPTOR

FOR WIRELESS COMMUNICATION DEVICES, NAMELY, COMPUTER HARDWARE AND ELECTRONICS HAVING RADIO TRANSCEIVERS FOR WIRELESS COMMUNICATIONS, AND RELATED COMPONENTS, COMMUNICATIONS SOFTWARE AND ACCESSORIES (U.S. CLS. 21, 23, 26, 36 AND 38).

SN 76-077,906. CONSUMER DIRECT-LINK, INC., IRVINE, CA. FILED 6-27-2000.

M-PORTAL

FOR TELECOMMUNICATION AND COMPUTER SOFTWARE AND HARDWARE COMPONENTS, NAMELY, SOFTWARE USED TO DEVELOP AND HOST WEB PAGES AND WEB SITES, AND SOFTWARE TO DEVELOP, ENABLE AND FACILITATE ELECTRONIC COMMERCIAL TRANSACTIONS VIA LOCAL AND GLOBAL COMPUTER NETWORKS, AND RELATED COMPUTER AND ELECTRONIC HARDWARE COMPONENTS (U.S. CLS. 21, 23, 26, 36 AND 38).

SN 76-077,975. ANSO SYSTEMS LIMITED, CHRISTCHURCH, NEW ZEALAND, FILED 6-26-2000.

AJEXUS

PRIORITY CLAIMED UNDER SEC. 44(D) ON NEW ZEALAND APPLICATION NO. 608293, FILED 2-11-2000, REG. NO. 608293, DATED 2-11-2000, EXPIRES 2-11-2007.

FOR COMPUTER HARDWARE; COMPUTER PERIPHERALS; NETWORK COMPUTERS; COMPUTER SOFTWARE FOR USE IN DATABASE MANAGEMENT AND DATA ANALYSIS, FOR ELECTRONICALLY STORING AND TRACKING DATA, TEXT, DOCUMENTS, SOUNDS, IMAGES AND RECORDS OF ALL MEDIA TYPES, AND TO ENABLE COMMUNICATION AND INTERACTION BETWEEN SEPARATE COMPUTER SYSTEMS; AND INSTRUCTIONAL MANUALS SOLD AS A UNIT THEREWITH (U.S. CLS. 21, 23, 26, 36 AND 38).

SN 76-078,938. CYBIZZ, INC., SANTA ANA, CA. FILED 6-28-2000.

CYBIZZ

FOR COMPUTER SOFTWARE FOR COMPUTERIZED DOCUMENT CONTROL AND STORAGE AND FOR GLOBAL COMMUNICATIONS NETWORK-BASED DOCUMENT CONTROL AND STORAGE (U.S. CLS. 21, 23, 26, 36 AND 38).

CLASS 9—(Continued).

SN 76-079,400. ALCATEL, 75008 PARIS, FRANCE, FILED 6-27-2000.

Alcatel OmniVista

OWNER OF FRANCE REG. NO. 99832193, DATED 12-30-1999, EXPIRES 12-30-2009.

FOR TELECOMMUNICATIONS DEVICES, APPARATUS, EQUIPMENT AND INSTALLATIONS, NAMELY, SWITCHES, PABXS, ROUTERS, SERVERS, INTERACTIVE VOCAL SERVERS, COMPUTER HARDWARE AND PERIPHERALS FOR CALL CENTERS FOR COMPUTER AND TELECOMMUNICATIONS NETWORKS, COMPUTER HARDWARE AND PERIPHERALS FOR CONTACT CENTERS FOR COMPUTER AND TELECOMMUNICATIONS NETWORKS, COMPUTERS AND THEIR PERIPHERALS, COMPUTER DATA TERMINALS, COMPUTER TELECOMMUNICATIONS TERMINALS, ELECTRONIC EXTENSION CARDS FOR DATA TERMINALS, TELEPHONES, TELECOPIERS, ANSWERING MACHINES, MODEMS, DEVICES FOR TRANSMITTING ALARM MESSAGES AND/OR SIGNALS, ELECTRICAL CABLES; COMPUTER CABLES; TELECOMMUNICATIONS SOFTWARE NAMELY INTERFACE SOFTWARE FOR COMPUTER AND/OR TELECOMMUNICATIONS NETWORKS; OPERATING SOFTWARE ASSOCIATED WITH SWITCHES, PABXS, ROUTERS, SERVERS, INTERACTIVE VOCAL SERVERS, CALL CENTERS FOR COMPUTER AND/OR TELECOMMUNICATIONS NETWORKS, CONTACT CENTERS FOR COMPUTER AND/OR TELECOMMUNICATIONS NETWORKS, SOFTWARE FOR CONFIGURATION AND MANAGEMENT OF TELECOMMUNICATION SWITCHES, PABXS, ROUTERS, SERVERS, INTERACTIVE VOCAL SERVERS, CALL CENTERS AND CONTACT CENTERS, SOFTWARE FOR QUALITY CONTROL AND DETECTION OF DEFAULTS AND INCIDENTS IN COMPUTER AND TELECOMMUNICATIONS NETWORKS, SOFTWARE FOR ELECTRONIC MAIL, SOFTWARE FOR VOICE MESSAGING, SOFTWARE FOR MAINTAINING AND CREATING TELEPHONE AND INTERNET USER DIRECTORIES, SOFTWARE FOR CONFIDENTIALITY OF COMMUNICATIONS BY IDENTIFICATION OF THE USERS, BY ACCESS CONTROL BY CRYPTING (U.S. CLS. 21, 23, 26, 36 AND 38).

SN 76-079,418. CONSUMER DIRECT-LINK, INC., IRVINE, CA. FILED 6-27-2000.

M-SYNC

FOR WIRELESS COMMUNICATION DEVICES, NAMELY, COMPUTER HARDWARE AND ELECTRONICS HAVING RADIO TRANSCEIVERS FOR WIRELESS COMMUNICATIONS, AND RELATED COMPONENTS, COMMUNICATIONS SOFTWARE AND ACCESSORIES (U.S. CLS. 21, 23, 26, 36 AND 38).

CLASS 9—(Continued).

SN 76-081,606. DREAM TEAM LTD., HERZLIYA PITUACH, ISRAEL, FILED 6-29-2000.

STEADYVIEW

PRIORITY CLAIMED UNDER SEC. 44(D) ON ISRAEL APPLICATION NO. 138,678, FILED 6-6-2000, REG. NO. 138678, DATED 4-30-2001, EXPIRES 4-30-2008.

FOR COMPUTER SOFTWARE AND HARDWARE FOR EDITING MOVIES (U.S. CLS. 21, 23, 26, 36 AND 38).

SN 76-083,325. CONET CONSULTING AG, D-53773 HENNEF, FED REP GERMANY, FILED 7-5-2000.

YOU@WEB

OWNER OF FED REP GERMANY REG. NO. 39952186, DATED 3-9-2000, EXPIRES 8-31-2009.

FOR COMPUTER SOFTWARE FOR WEBSITE DEVELOPMENT, DATA BASE MANAGEMENT, PAYROLL ACCOUNTING, INVENTORY CONTROL, E-COMMERCE TO ALLOW USERS TO PERFORM ELECTRONIC BUSINESS TRANSACTIONS VIA A GLOBAL COMPUTER NETWORK, THE DESIGN, IMPLEMENTATION AND MAINTENANCE OF AN INTRANET OR INTERNAL WEB BASED NETWORK, DEVELOPMENT, IMPLEMENTATION AND MAINTENANCE OF THE MAIN PAGE OF A WEB SITE OR HOMEPAGE, AUTOMATING DATA WAREHOUSING, MANAGING OPERATIONS OF A COMPUTER BASED NETWORK IN WHICH DATA RESIDES IN A MAIN COMPUTER SERVER AND IS SERVED OUT TO INDIVIDUAL WORKSTATIONS OR CLIENTS, APPLICATION SERVICE PROVIDER OR ASP, NAMELY HOSTING COMPUTER SOFTWARE APPLICATIONS OF OTHERS, SAP, NAMELY ENTERPRISES SOFTWARE WHICH INTEGRATES ORGANIZATIONAL TASKS INCLUDING SALES, CUSTOMER PROCESSES TO PROVIDE REAL TIME ACCESS TO DATA, SUPPLY CHAIN MANAGEMENT FOR DESIGNING, IMPLEMENTING AND MAINTAINING A DYNAMIC SUPPLY SYSTEM FOR ACCESS BY CUSTOMERS, IN REAL TIME, ACROSS THE INTERNET (U.S. CLS. 21, 23, 26, 36 AND 38).

SN 76-086,047. TURBOWAVE, INC., OREM, UT. FILED 7-10-2000.



TURBOWAVE

FOR COMPUTERS; COMPUTER PERIPHERALS; TELECOMMUNICATIONS EQUIPMENT, NAMELY, VOICE AND DATA LINE SWITCHES, CONNECTION BLOCKS, PATCH PANELS, AND HUBS; AND ELECTRONIC CIRCUIT BOARDS AND PCMCIA CARDS USED IN COMPUTERS AND TELECOMMUNICATIONS EQUIPMENT (U.S. CLS. 21, 23, 26, 36 AND 38).

FIRST USE 3-31-1999; IN COMMERCE 3-31-1999.

CLASS 9—(Continued).

SN 76-086,251. UNIVERSAL IMAGING CORPORATION, DOWNINGTOWN, PA. FILED 7-11-2000.

UNIVERSAL-IMAGING.COM

FOR IMAGE PROCESSING AND ANALYSIS COMPUTER SOFTWARE FOR USE BY BIOMEDICAL RESEARCHERS, UNIVERSITY AND INDUSTRIAL RESEARCHERS AND QUALITY CONTROL PERSONNEL FOR PERFORMING APPLICATIONS RELATED TO THREE-DIMENSIONAL RECONSTRUCTION, VIDEO MICROSCOPY, IMAGE ENHANCEMENT, MORPHOMETRIC ANALYSIS, DENSITOMETRY AND ON-LINE IMAGE ANALYSIS OF ANY IMAGES THAT ARE CAPABLE OF BEING DIGITIZED INCLUDING BUT NOT LIMITED TO HUMAN, ANIMAL, OR PLANT CELLS OR TISSUE, INDUSTRIAL TOOLS AND TEMPLATES, MACHINE PARTS AND ANY OTHER PRODUCED PRODUCT THAT MAY BE VISUALLY INSPECTED (U.S. CLS. 21, 23, 26, 36 AND 38).

SN 76-086,252. UNIVERSAL IMAGING CORPORATION, DOWNINGTOWN, PA. FILED 7-11-2000.

UNIVERSAL IMAGING

NO CLAIM IS MADE TO THE EXCLUSIVE RIGHT TO USE "IMAGING", APART FROM THE MARK AS SHOWN.

FOR IMAGE PROCESSING AND ANALYSIS COMPUTER SOFTWARE FOR USE BY BIOMEDICAL RESEARCHERS, UNIVERSITY AND INDUSTRIAL RESEARCHERS AND QUALITY CONTROL PERSONNEL FOR PERFORMING APPLICATIONS RELATED TO THREE-DIMENSIONAL RECONSTRUCTION, VIDEO MICROSCOPY, IMAGE ENHANCEMENT, MORPHOMETRIC ANALYSIS, DENSITOMETRY AND ON-LINE IMAGE ANALYSIS OF ANY IMAGES THAT ARE CAPABLE OF BEING DIGITIZED INCLUDING BUT NOT LIMITED TO HUMAN, ANIMAL, OR PLANT CELLS OR TISSUE, INDUSTRIAL TOOLS AND TEMPLATES, MACHINE PARTS AND ANY OTHER PRODUCED PRODUCT THAT MAY BE VISUALLY INSPECTED (U.S. CLS. 21, 23, 26, 36 AND 38).

SN 76-086,446. SAMSUNG ELECTRONICS CO., LTD., SUWON-CITY, KYUNGKI-DO, REPUBLIC OF KOREA, FILED 7-11-2000.

PREVISION

FOR COMMUNICATION HARDWARE, NAMELY, SERVERS, ROUTERS, SWITCHES, GATEWAYS AND MODEMS; COMPUTER PROGRAM FOR SWITCHING VOICE AND DATA OVER A COMMUNICATION NETWORK (U.S. CLS. 21, 23, 26, 36 AND 38).

CLASS 9—(Continued).

SN 76-086,451. UNIVERSAL IMAGING CORPORATION, DOWNINGTOWN, PA. FILED 7-11-2000.



NO CLAIM IS MADE TO THE EXCLUSIVE RIGHT TO USE "IMAGING CORPORATION", APART FROM THE MARK AS SHOWN.

FOR IMAGE PROCESSING AND ANALYSIS COMPUTER SOFTWARE FOR USE BY BIOMEDICAL RESEARCHERS, UNIVERSITY AND INDUSTRIAL RESEARCHERS AND QUALITY CONTROL PERSONNEL FOR PERFORMING APPLICATIONS RELATED TO THREE-DIMENSIONAL RECONSTRUCTION, VIDEO MICROSCOPY, IMAGE ENHANCEMENT, MORPHOMETRIC ANALYSIS, DENSITOMETRY AND ON-LINE IMAGE ANALYSIS OF ANY IMAGES THAT ARE CAPABLE OF BEING DIGITIZED INCLUDING BUT NOT LIMITED TO HUMAN, ANIMAL, OR PLANT CELLS OR TISSUE, INDUSTRIAL TOOLS AND TEMPLATES, MACHINE PARTS AND ANY OTHER PRODUCED PRODUCT THAT MAY BE VISUALLY INSPECTED (U.S. CLS. 21, 23, 26, 36 AND 38).

FIRST USE 3-0-1988; IN COMMERCE 3-0-1988.

SN 76-088,855. MANAGED OBJECT SOLUTIONS, INC., MCLEAN, VA. FILED 7-14-2000.

E-BUSINESS MANAGEMENT SIMPLIFIED

NO CLAIM IS MADE TO THE EXCLUSIVE RIGHT TO USE "E-BUSINESS MANAGEMENT", APART FROM THE MARK AS SHOWN.

FOR SOFTWARE FOR USE IN MANAGING INFORMATION TECHNOLOGY INFRASTRUCTURE (U.S. CLS. 21, 23, 26, 36 AND 38).

FIRST USE 3-2-2000; IN COMMERCE 3-2-2000.

SN 76-094,586. ABEYTA-DADE L.L.C., BOULDER, CO. FILED 7-13-2000.

DISC-FIT

FOR HOLDERS FOR COMPACT DISCS, DVD'S, CD-ROM'S, AND MINI DISCS (U.S. CLS. 21, 23, 26, 36 AND 38).

SN 76-096,621. GENERAL DYNAMICS OTS (AEROSPACE), INC., REDMOND, WA. BY CHANGE OF NAME PRIMEX AEROSPACE COMPANY, REDMOND, WA. FILED 7-26-2000.

ARCSAFE

FOR ELECTRIC ARC FAULT DETECTORS (U.S. CLS. 21, 23, 26, 36 AND 38).

CLASS 9—(Continued).

SN 76-099,414. CMC MAGNETICS CORPORATION, TAIPEI, TAIWAN, FILED 7-28-2000.

MINI-R

FOR PRERECORDED PHONOGRAPH RECORDS, COMPACT DISKS, AUDIO CASSETTE TAPES, MUSIC TAPES, MINI DISKS, DIGITAL AUDIO TAPES, DIGITAL AUDIO COMPACT CASSETTE TAPES, MAGNETIC TAPES FOR BEARING SOUND RECORDINGS, AND AUDIO RECORDINGS, ALL FEATURING MUSIC, STORIES, SOUND EFFECTS AND SOUNDTRACKS FOR MOTION PICTURES AND ANIMATED RECORDINGS, VIDEO DISKS, VIDEO TAPES, LASER DISKS, MAGNETIC TAPES AND BEARING VIDEO RECORDINGS, ALL FEATURING MUSICAL ENTERTAINMENT, ANIMATED RECORDINGS, THEATRICAL PERFORMANCES, AND MOTION PICTURES; DISTANCE MEASURING APPARATUS, NAMELY, AN ELECTRONIC PEDOMETER; ELECTRONIC HOME ENTERTAINMENT APPARATUSES, NAMELY RADIOS, STEREOs, LOUD-SPEAKERS, AUDIO AND VIDEO DISKS AND CASSETTE RECORDERS AND PLAYERS, COMPACT DISK PLAYERS, TELEVISION RECEIVERS, RADIO RECEIVERS, TUNERS AND AMPLIFIERS; TELEPHONES; TELEPHONE ANSWERING MACHINES; TELEPHONES FEATURING RADIOS AND CLOCKS; TELEPHONE APPARATUS AND APPARATUS FOR USE WITH TELEPHONES NAMELY INTERCOMS; ELECTRICAL OPERATED SPEAKERS, STEREO TUNERS, AMPLIFIERS, ELECTRONIC CALCULATORS; PROJECTORS; VIDEO TAPE RECORDERS; VIDEO GAME TAPE CASSETTES; FLOPPY DISKS FOR COMPUTERS, TRAVEL COMPACT DISK CASES AND CASES FOR LP RECORDS; TAPES CASE; FLOPPIES DISK CASES (U.S. CLS. 21, 23, 26, 36 AND 38).

SN 76-103,458. TAX ANALYSTS, ARLINGTON, VA. FILED 8-4-2000.

**TAX NOTES
INTERNATIONAL**

NO CLAIM IS MADE TO THE EXCLUSIVE RIGHT TO USE "TAX", APART FROM THE MARK AS SHOWN.
FOR EDUCATIONAL COMPUTER SOFTWARE RECORDED ON CD-ROM IN THE FIELD OF TAX (U.S. CLS. 21, 23, 26, 36 AND 38).
FIRST USE 7-1-1989; IN COMMERCE 7-1-1989.

CLASS 9—(Continued).

SN 76-103,868. PROACT TECHNOLOGIES, CORP., DULUTH, GA. BY CHANGE OF NAME CONSUMER FINANCIAL NETWORK, INC., ATLANTA, GA. FILED 8-7-2000.

1:1 HR

NO CLAIM IS MADE TO THE EXCLUSIVE RIGHT TO USE "HR", APART FROM THE MARK AS SHOWN.

FOR ENTERPRISE RESOURCE PLANNING SOFTWARE IN THE FIELD OF HUMAN RESOURCES ADMINISTRATION, NAMELY WEB-BASED SOFTWARE FEATURING USER-DEFINED INFORMATION FOR MANAGING PERSONAL SUCH AS FOR HIRING, EVALUATING, PROMOTING, TERMINATING AND RELOCATING EMPLOYEES, ADMINISTERING EMPLOYEE BENEFITS PROGRAMS, PLANNING EMPLOYEE COMPENSATION AND MAINTAINING A DATABASE OF EMPLOYEE AND COMPANY INFORMATION SUCH AS EMPLOYEE HANDBOOKS, COMPANY RULES, POLICIES AND PROCEDURES AND PERSONNEL RECORDS (U.S. CLS. 21, 23, 26, 36 AND 38).

SN 76-104,896. TAX ANALYSTS, ARLINGTON, VA. FILED 8-7-2000.

TAX NOTES

NO CLAIM IS MADE TO THE EXCLUSIVE RIGHT TO USE "TAX", APART FROM THE MARK AS SHOWN.

FOR EDUCATIONAL COMPUTER SOFTWARE RECORDED ON CD-ROM IN THE FIELD OF TAX (U.S. CLS. 21, 23, 26, 36 AND 38).

FIRST USE 9-18-1972; IN COMMERCE 9-18-1972.

SN 76-109,498. BUILDING MATERIALS INVESTMENT CORPORATION, WAYNE, NJ. FILED 8-14-2000.

**SMART CHOICE
SOLUTIONS**

OWNER OF U.S. REG. NOS. 2,261,463 AND 2,398,208.
NO CLAIM IS MADE TO THE EXCLUSIVE RIGHT TO USE "SOLUTIONS", APART FROM THE MARK AS SHOWN.

FOR COMPUTER SOFTWARE FOR DISPLAYING ROOFING SHINGLES AND ROOFING VENTILATION PRODUCTS (U.S. CLS. 21, 23, 26, 36 AND 38).

SN 76-109,594. FACECAKE.COM, INC., WOODLAND HILLS, CA. FILED 8-15-2000.

FACECAKE

FOR VIRTUAL REALITY SOFTWARE FOR USE IN PROVIDING VIRTUAL MAKEOVERS IN REAL-TIME (U.S. CLS. 21, 23, 26, 36 AND 38).

CLASS 9—(Continued).

SN 76-111,212. B ELLIOTT GROUP LIMITED, LONDON, ENGLAND, FILED 8-17-2000.

MAGNASYN

PRIORITY CLAIMED UNDER SEC. 44(D) ON UNITED KINGDOM APPLICATION NO. 2222664, FILED 2-17-2000, REG. NO. 2222664, DATED 8-4-2000, EXPIRES 2-17-2010.

FOR ELECTRONIC MEASURING DEVICE, PRINCIPALLY COMPRISED OF A MAGNETICALLY ENCODED TAPE, ENCODED WITH UNITS OF MEASUREMENT, AND AN ELECTRONIC TAPE READER WHICH INDICATES POSITION OF THE READER ON THE TAPE, FOR PURPOSES OF LOCATING WORK SURFACE POSITION FOR A MACHINE TOOL (U.S. CLS. 21, 23, 26, 36 AND 38).

SN 76-113,688. AUDIOARTF/X, INC., LARGO, FL. FILED 8-21-2000.

AUDIOARTF/X

FOR AUDIO SPEAKERS AND CABINETS (U.S. CLS. 21, 23, 26, 36 AND 38).

SN 76-114,213. NXP TECHNOLOGIES, INC., HOUSTON, TX. FILED 8-22-2000.

SCHOOLS SAFE

FOR COMPUTER SOFTWARE USED TO MONITOR, REPORT, AND FILTER INTERNET ACTIVITIES IN SCHOOLS (U.S. CLS. 21, 23, 26, 36 AND 38).

SN 76-114,214. NXP TECHNOLOGIES, INC., HOUSTON, TX. FILED 8-22-2000.

LIBRARYSAFE

FOR COMPUTER SOFTWARE USED TO MONITOR, REPORT, AND FILTER INTERNET ACTIVITIES IN LIBRARIES (U.S. CLS. 21, 23, 26, 36 AND 38).

CLASS 9—(Continued).

SN 76-115,346. BINDER GMBH, D-78532 TUTTLINGEN, FED REP GERMANY, FILED 8-23-2000.

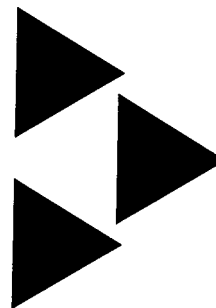

FOR INCUBATORS AND CHAMBERS WITH TEMPERATURE, ATMOSPHERE AND VACUUM CONTROLS FOR USE IN LABORATORY RESEARCH AND QUALITY CONTROL, NAMELY, INCUBATORS, TEMPERATURE CHAMBERS, CLIMATIC CHAMBERS, TEST CHAMBERS, GROWTH CHAMBERS, DRYING OVENS AND HOT-AIR STERILIZERS (U.S. CLS. 21, 23, 26, 36 AND 38). FIRST USE 1-1-2000; IN COMMERCE 1-1-2000.

SN 76-116,489. SIERRA ON-LINE, INC., BELLEVUE, WA. FILED 8-24-2000.

DARK CONSPIRACY

FOR COMPUTER GAME SOFTWARE (U.S. CLS. 21, 23, 26, 36 AND 38).

SN 76-118,159. EXIDE INDUSTRIES LIMITED, CALCUTTA, INDIA, FILED 8-25-2000.

FOR PRIMARY ELECTRIC BATTERIES AND CELLS, ELECTRIC ACCUMULATORS AND PARTS THEREOF; ELECTRIC CELLS AND BATTERIES, AND CASES FOR SUCH CELLS AND BATTERIES, AND SEPARATORS AND ELECTRIC STORAGE BATTERIES, ELECTRIC BATTERY CHARGERS; COMBINED ELECTRIC BATTERIES AND ELECTRIC BATTERY CHARGING APPARATUS BEING AUTOMATICALLY OPERATED FOR SUPPLYING POWER (U.S. CLS. 21, 23, 26, 36 AND 38).

CLASS 9—(Continued).

SN 76-120,660. CASINO DATA SYSTEMS, LAS VEGAS, NV.
FILED 8-31-2000.

BINGOMATIC

FOR GAMING DEVICES, NAMELY, GAMING MACHINES AND COMPUTER GAME SOFTWARE THEREFOR (U.S. CLS. 21, 23, 26, 36 AND 38).

SN 76-121,025. LINEAR CORPORATION, CARLSBAD, CA.
FILED 9-1-2000.

HOUSEWORKS

FOR HOME ELECTRONICS, AUTOMATION AND CONTROL SYSTEMS, NAMELY, MUSIC AND AUDIO DISTRIBUTION SYSTEMS, INFRARED CONTROL SYSTEMS, WHOLE HOUSE MUSIC SYSTEMS, MULTI-ROOM AUDIO DISTRIBUTION SYSTEMS, HOME THEATER CONTROL SYSTEMS, RESIDENTIAL SECURITY SYSTEMS RESIDENTIAL ACCESS CONTROL SYSTEMS, RESIDENTIAL INTERCOM CONTROL SYSTEMS, VIDEO CONTROL AND DISTRIBUTION SYSTEM, CLOSED-CIRCUIT TELEVISION CONTROL AND DISTRIBUTION SYSTEMS, WHOLE HOUSE VIDEO DISTRIBUTION SYSTEMS, WHOLE HOUSE DATA NETWORK SYSTEMS, HOME NETWORK SYSTEMS, TELEPHONE CONTROL AND DISTRIBUTION SYSTEMS, AND RESIDENTIAL TELEPHONY SYSTEMS, SAID SYSTEMS COMPRISING NAMELY, CONTROLLERS, AMPLIFIERS, PRE-AMPLIFIERS, RECEIVERS, REMOTE CONTROL SWITCHES, LOUDSPEAKERS, IN-WALL SPEAKERS, MODULES, CONNECTING BLOCKS, TELEVISION AND VIDEO MONITORS (U.S. CLS. 21, 23, 26, 36 AND 38).

SN 76-121,800. ENTERASYS NETWORKS, INC., ROCHESTER, NH. FILED 9-5-2000.

VERTICAL HORIZON

FOR NETWORKING HARDWARE NAMELY ROUTERS (U.S. CLS. 21, 23, 26, 36 AND 38).

SN 76-125,857. R&B LTD., YOKNEAM, 20692, ISRAEL,
FILED 9-12-2000.

MOLDWORKS

FOR COMPUTER SOFTWARE FEATURING PROGRAMS USED FOR MOLD BASE ASSEMBLY DESIGN BASED ON STANDARD MOLD BASED PLATES AND COMPONENTS THEREOF (U.S. CLS. 21, 23, 26, 36 AND 38).

FIRST USE 10-0-1998; IN COMMERCE 3-0-2000.

CLASS 9—(Continued).

SN 76-126,087. NIIGATA SEIMITSU CO., LTD., JOETSU-SHI, NIIGATA-KEN, JAPAN, FILED 9-7-2000.

NEOSEMI

PRIORITY CLAIMED UNDER SEC. 44(D) ON JAPAN APPLICATION NO. 2000-81048, FILED 7-21-2000, REG. NO. 4492409, DATED 7-19-2001, EXPIRES 7-19-2011.

FOR SEMICONDUCTOR MICROPROCESSORS, APPLIED ELECTRONIC MACHINES AND APPARATUS, NAMELY, SILICON CHIPS, CAPACITORS, CONDENSERS, CONDUCTORS, CONVERTERS, DATA PROCESSORS, SEMICONDUCTOR DEVICES, TRANSISTORS, INTEGRATED CIRCUITS, CIRCUIT BOARDS, COMPUTER HARD DISCS, COMPUTERS, COMPUTER FAX MODEM CARDS, COMPUTER MEMORIES, STEREO AMPLIFIERS, COMPACT DISC PLAYERS, AND PARTS THEREOF (U.S. CLS. 21, 23, 26, 36 AND 38).

SN 76-127,202. LG INFORMATION & COMMUNICATIONS, LTD., YONGDUNGPO-GU, SEOUL, REPUBLIC OF KOREA, FILED 9-12-2000.

QUDAC

FOR INTERFACES AND FUNCTIONAL DATA INTERFACES FOR HIGH SPEED ACCESS AND BROADBAND SUBSCRIBER LINE, NAMELY, ASYMMETRIC DIGITAL SUBSCRIBER LINE ALSO KNOWN AS ADSL, HIGH DATA RATE DIGITAL SUBSCRIBER LINE ALSO KNOWN AS HDSL, SYMMETRIC DIGITAL SUBSCRIBER LINE, ALSO KNOWN AS SDSL, VERY HIGH DATA RATE DIGITAL SUBSCRIBER LINE, ALSO KNOWN AS VDSL; TELECOMMUNICATIONS PRODUCTS, NAMELY, TELEPHONES, TELECOMMUNICATIONS SWITCHES, TELECOMMUNICATIONS COMPUTER PROGRAMS FOR USE IN CONNECTION WITH NETWORK OR MANAGEMENT OF TELECOMMUNICATIONS SWITCHES, COMPUTER SERVER HARDWARE ALL USED FOR THE TRANSMISSION OF VOICE, FACSIMILE, DATA, VIDEO AND INFORMATION (U.S. CLS. 21, 23, 26, 36 AND 38).

SN 76-127,204. LG INFORMATION & COMMUNICATIONS, LTD., YONGDUNGPO-GU, SEOUL, REPUBLIC OF KOREA, FILED 9-12-2000.

ACCESSTAR

FOR INTERFACES AND FUNCTIONAL DATA INTERFACE FOR HIGH SPEED ACCESS AND BROADBAND DIGITAL SUBSCRIBER LINE, NAMELY, ASYMMETRIC DIGITAL SUBSCRIBER LINE, ALSO KNOWN AS ADSL, HIGH DATA RATE DIGITAL SUBSCRIBER LINE, ALSO KNOWN AS HDSL, SYMMETRIC DIGITAL SUBSCRIBER LINE ALSO KNOWN AS SDSL, VERY HIGH DATA RATE DIGITAL SUBSCRIBER LINE, ALSO KNOWN AS VDSL; TELECOMMUNICATIONS PRODUCTS, NAMELY, TELEPHONES, TELECOMMUNICATIONS SWITCHES, TELECOMMUNICATIONS COMPUTER PROGRAMS FOR USE IN CONNECTION WITH NETWORK OF MANAGEMENT OF TELECOMMUNICATIONS SWITCHES, COMPUTER SERVER HARDWARE ALL USED FOR THE TRANSMISSION OF VOICE, FACSIMILE, DATA, AND VIDEO INFORMATION (U.S. CLS. 21, 23, 26, 36 AND 38).

CLASS 9—(Continued).

SN 76-127,288. KESONIC, INC., IRVINE, CA. FILED 9-13-2000.

KIDZ HAND CHAT

NO CLAIM IS MADE TO THE EXCLUSIVE RIGHT TO USE "KIDZ", APART FROM THE MARK AS SHOWN.

FOR HANDHELD COMPUTERS USED FOR COMMUNICATION TO AND FROM THE HANDHELD COMPUTING UNIT WITH OTHER USERS OF SUCH UNITS, ALSO USED FOR PERSONAL INFORMATION MANAGEMENT AND CONTAINING A CALCULATOR, CLOCK AND ALARM (U.S. CLS. 21, 23, 26, 36 AND 38).

FIRST USE 1-15-2000; IN COMMERCE 1-15-2000.

SN 76-127,318. MITEK INDUSTRIES, INC., CHESTERFIELD, MO. FILED 9-11-2000.

MITEK 20/20 "PERFECT VISION"

OWNER OF U.S. REG. NO. 1,739,423.

FOR COMPUTER SOFTWARE FOR USE BY MANUFACTURERS OF PREFABRICATED TRUSSES IN THE DESIGN, CONSTRUCTION AND ARCHITECTURAL LAYOUT OF TRUSSES AND OTHER STRUCTURAL COMPONENTS AND SYSTEMS, AND PRINTED MANUALS DISTRIBUTED THEREWITH; COMPUTER SOFTWARE FOR USE BY MANUFACTURERS OF PREFABRICATED TRUSSES IN TRUSS FABRICATING PLANT MANAGEMENT INCLUDING THE DESIGN, MANUFACTURE, ASSEMBLY, INVENTORY, DISTRIBUTION AND USE OF PREFABRICATED BUILDING COMPONENTS, AND PRINTED MANUALS DISTRIBUTED THEREWITH (U.S. CLS. 21, 23, 26, 36 AND 38).

FIRST USE 11-28-2000; IN COMMERCE 11-28-2000.

SN 76-128,400. ON-LINE TECHNOLOGIES, INC., EAST HART-FORD, CT. FILED 9-15-2000.

METROLOGY 1, 2, 3

NO CLAIM IS MADE TO THE EXCLUSIVE RIGHT TO USE "METROLOGY", APART FROM THE MARK AS SHOWN.

FOR METROLOGY TOOL FOR OPTICALLY MEASURING PROPERTIES OF SEMICONDUCTOR WAFERS AT VARIOUS STAGES DURING FABRICATION OF SEMICONDUCTOR DEVICES, INCLUDING AN OPTICAL SENSOR, A WAFER-SUPPORT STAGE, ELECTRONIC DATA PROCESSING MEANS, AND MECHANICAL AND SOFTWARE INTERFACES FOR INTEGRATION WITH WAFER-LOADING TOOLS AND WAFER-PROCESSING TOOLS (U.S. CLS. 21, 23, 26, 36 AND 38).

SN 76-132,445. AXIS SYSTEMS, INC., SUNNYVALE, CA. FILED 9-20-2000.

XTREME

FOR ELECTRONIC APPARATUS FOR TESTING PROGRAMMABLE LOGIC DEVICES (U.S. CLS. 21, 23, 26, 36 AND 38).

CLASS 9—(Continued).

SN 76-134,596. HIGH OCTANE LTD., LONDON SW3 IDE, UNITED KINGDOM, FILED 9-25-2000.

HERVE' HANDSOME

FOR PRE-RECORDED VIDEO CASSETTES FEATURING ADULT ORIENTED ENTERTAINMENT (U.S. CLS. 21, 23, 26, 36 AND 38).

FIRST USE 4-6-1999; IN COMMERCE 8-5-1999.

SN 76-134,900. APPLIED SYSTEMS INTELLIGENCE, INC., ROSWELL, GA. FILED 9-25-2000.

OBJECTMATCH

FOR COMPUTER SOFTWARE FOR COMMAND AND CONTROL INFORMATION TECHNOLOGY, WHICH DESIGNS, DEVELOPS AND INTEGRATES KNOWLEDGE BASED INTELLIGENT SYSTEMS (U.S. CLS. 21, 23, 26, 36 AND 38).

SN 76-135,833. CURTIS COMPUTER PRODUCTS, INC., PROVO, UT. FILED 9-26-2000.

MEDIAFILER

FOR HANGER ACCESSORY, NAMELY, RACKS FOR USE WITH HANGING FOLDERS FRAMES, FOR THE STORAGE OF COMPUTER DISCS (U.S. CLS. 21, 23, 26, 36 AND 38).

SN 76-136,985. DIGITAL:CONVERGENCE CORPORATION, DALLAS, TX. FILED 9-27-2000.

IT'S YOUR CUE

FOR COMPUTER SOFTWARE WHICH INTERFACES WITH KEYSTROKE AUTOMATION APPARATUS FOR READING CODED IMAGES AND CONVERTING THE IMAGES TO COMPUTER KEYSTROKES; AUDIO OR VIDEO TRANSDUCER FOR RECEIVING CODED AUDIO OR VIDEO THAT IS OPERABLE FOR CONNECTING A USER'S COMPUTER TO A WEB SITE ON THE INTERNET (U.S. CLS. 21, 23, 26, 36 AND 38).

FIRST USE 9-18-2000; IN COMMERCE 9-18-2000.

SN 76-139,373. LOMOGRAPHISCHE AG, A-1150 WIEN, AUSTRIA, FILED 10-2-2000.

ACTIONSAMPLER

PRIORITY CLAIMED UNDER SEC. 44(D) ON ERPN CMNTY TM OFC APPLICATION NO. 00158126, FILED 4-3-2000, REG. NO. 00158126, DATED 7-3-2001, EXPIRES 4-3-2010.

FOR CAMERAS, NAMELY PHOTOGRAPHIC CAMERAS (U.S. CLS. 21, 23, 26, 36 AND 38).

CLASS 9—(Continued).

SN 76-139,634. COMMATCH LTD., LOD, ISRAEL, FILED 10-3-2000.

COMMATCH

PRIORITY CLAIMED UNDER SEC. 44(D) ON ISRAEL APPLICATION NO. 136664, FILED 4-6-2000, REG. NO. 136664, DATED 4-6-2000, EXPIRES 4-6-2007.

FOR INSTRUMENTS FOR USE IN TELEPHONY AND TELECOMMUNICATIONS SYSTEMS, NAMELY, VOICE-OVER-IP CARRIER-GRADE GATEWAYS, IP-TO-PSTN (LEGACY TELEPHONE NETWORK) INTERCONNECTING GATEWAYS, IP-TO-IP NEXT GENERATION SIGNALING GATEWAYS, IP MEDIA SERVERS AND APPLICATION PLATFORMS, AND IP APPLICATION ENABLING PLATFORMS (U.S. CLS. 21, 23, 26, 36 AND 38).

SN 76-140,194. ICP GLOBAL TECHNOLOGIES, MONTREAL, QUEBEC, CANADA, FILED 10-4-2000.



FOR SOLAR PHOTOVOLTAIC PANELS USED TO GENERATE POWER (U.S. CLS. 21, 23, 26, 36 AND 38).
FIRST USE 9-26-2000; IN COMMERCE 9-26-2000.

SN 76-140,410. TRILINEAR CORPORATION, ST. LOUIS, MO. FILED 10-3-2000.

OBI SYSTEM

NO CLAIM IS MADE TO THE EXCLUSIVE RIGHT TO USE "SYSTEM", APART FROM THE MARK AS SHOWN.

FOR COMPUTER HARDWARE FOR USE IN MONITORING OF TRUCKS TRANSPORTING THE ASSETS OF OTHERS FEATURING A SATELLITE-BASED TRACKING SYSTEM; COMPUTER SOFTWARE FOR USE IN MONITORING OF TRUCKS TRANSPORTING THE ASSETS OF OTHERS IN CONJUNCTION WITH A SATELLITE-BASED TRACKING SYSTEM (U.S. CLS. 21, 23, 26, 36 AND 38).

FIRST USE 7-15-1999; IN COMMERCE 8-5-1999.

CLASS 9—(Continued).

SN 76-140,679. JR TECHNOLOGIES, INC., DES PLAINES, IL. FILED 10-4-2000.

DRILLSPOTTER

FOR ELECTRONIC DEVICE WHICH CAN BE USED AS AN EXIT HOLE LOCATOR WHEN DRILLING IN STRUCTURES SUCH AS WALLS, CEILINGS, AND FLOORS MADE OF MATERIALS SUCH AS CONCRETE, BRICK, STONE, WALLBOARD, AND PLASTERBOARD, AND WHICH DEVICE ALSO MEASURES THE THICKNESS OF THE STRUCTURE TO BE DRILLED, AND WHICH DEVICE ALSO IDENTIFIES OBSTACLES, NAMELY METAL REBARS, CONDUITS, PIPES, AND WIRING WITHIN THE STRUCTURE SUCH THAT THE DEVICE CAN BE DIRECTED TO AVOID THE OBSTACLES (U.S. CLS. 21, 23, 26, 36 AND 38).

FIRST USE 11-1-2000; IN COMMERCE 11-1-2000.

SN 76-143,936. LIGHTCROSS, INC., PASADENA, CA. FILED 10-6-2000.



NO CLAIM IS MADE TO THE EXCLUSIVE RIGHT TO USE "TECHNOLOGY FOR OPTICAL NETWORKING", APART FROM THE MARK AS SHOWN.

FOR OPTICAL NETWORKING COMPONENTS AND SUBSYSTEMS, NAMELY, WAVE DIVISION MULTIPLEXING AND OPTICAL SWITCHES, FILTERS, MODULATORS, OPTICAL SIGNAL AMPLIFIERS, EQUALIZERS, DEMULTIPLEXERS, LASERS, AND INTEGRATED CHIPS AND DEVICES, NAMELY, TRANSMITTERS, AMPLIFIERS, ADD/DROPS, CROSS CONNECTS, AND RECEIVERS (U.S. CLS. 21, 23, 26, 36 AND 38).

SN 76-143,937. LIGHTCROSS, INC., PASADENA, CA. FILED 10-6-2000.

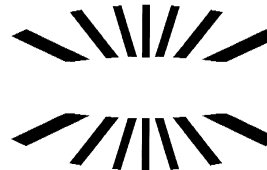

FOR OPTICAL NETWORKING COMPONENTS AND SUBSYSTEMS, NAMELY, WAVE DIVISION MULTIPLEXING AND OPTICAL SWITCHES, FILTERS, MODULATORS, OPTICAL SIGNAL AMPLIFIERS, EQUALIZERS, DEMULTIPLEXERS, LASERS, AND INTEGRATED CHIPS AND DEVICES, NAMELY, TRANSMITTERS, AMPLIFIERS, ADD/DROPS, CROSS CONNECTS, AND RECEIVERS (U.S. CLS. 21, 23, 26, 36 AND 38).

CLASS 9—(Continued).

SN 76-145,058. ESAOTE, S.P.A., 15033 CASALE MONFERRATO, ITALY, FILED 10-6-2000.

C3-MODE

FOR IMAGE ENHANCEMENT SOFTWARE AND FIRMWARE FOR ULTRASOUND DIAGNOSTIC EQUIPMENT (U.S. CLS. 21, 23, 26, 36 AND 38).

SN 76-145,366. 4D CONNECT, INC., SAN DIEGO, CA. FILED 10-12-2000.

4D

FOR INTEGRATED CIRCUITS FOR USE IN COMMUNICATION DEVICES (U.S. CLS. 21, 23, 26, 36 AND 38).

SN 76-145,368. 4D CONNECT, INC., SAN DIEGO, CA. FILED 10-12-2000.

4D CONNECT

FOR INTEGRATED CIRCUITS FOR USE IN COMMUNICATION DEVICES (U.S. CLS. 21, 23, 26, 36 AND 38).

SN 76-145,566. JELMAX COMPANY, LTD., TOKYO, JAPAN, FILED 10-12-2000.

Black Gate

OWNER OF JAPAN REG. NO. 1601800, DATED 7-28-1983, EXPIRES 7-28-2003.

FOR ELECTRICAL CAPACITORS AND TRANSDUCERS (U.S. CLS. 21, 23, 26, 36 AND 38).

FIRST USE 0-0-1980; IN COMMERCE 7-0-2000.

SN 76-145,594. 4D CONNECT, INC., SAN DIEGO, CA. FILED 10-12-2000.

4DCI

FOR INTEGRATED CIRCUITS FOR USE IN COMMUNICATION DEVICES (U.S. CLS. 21, 23, 26, 36 AND 38).

CLASS 9—(Continued).

SN 76-147,238. TRADOS CORPORATION, ALEXANDRIA, VA. FILED 10-16-2000.



OWNER OF U.S. REG. NOS. 1,948,058 AND 2,018,113. NO CLAIM IS MADE TO THE EXCLUSIVE RIGHT TO USE "NET" AND "MULTILINGUAL BUSINESS", APART FROM THE MARK AS SHOWN.

THE STIPPLING IN THE DRAWING REPRESENTS SHADING AND NOT COLOR AND IS NOT A FEATURE OF THE MARK.

FOR SOFTWARE FOR USE IN DATA BASE MANAGEMENT, LANGUAGE TRANSLATION AND DICTIONARY REFERENCE, ALL FOR USE BY TRANSLATORS, AND USER MANUALS SOLD TOGETHER AS A UNIT THEREWITH AND SOFTWARE FOR DESK TOP APPLICATIONS AND SOFTWARE FOR ON-LINE APPLICATION SERVICE PROVIDERS (ASPS) WHICH MANAGES ENTERPRISE DOCUMENTS AND TRANSLATION PROCESSING VIA A WORKFLOW ENGINE (U.S. CLS. 21, 23, 26, 36 AND 38).

SN 76-150,164. NETABACUS CORPORATION, SAN FRANCISCO, CA. FILED 10-18-2000.

RIVIO

FOR COMPUTER SOFTWARE AND DOWNLOADABLE COMPUTER SOFTWARE AND MANUALS SUPPLIED THEREWITH FOR USE IN THE ACQUISITION, TRACKING, AND PAYMENT OF GOODS AND SERVICES; TO ALLOW USERS TO CONDUCT ELECTRONIC BUSINESS TRANSACTIONS VIA COMPUTER NETWORKS, COMMUNICATIONS NETWORKS, AND THE INTERNET; ACCOUNTING; DATA MANAGEMENT AND DATABASE MANAGEMENT; DOCUMENT PROCESSING; ELECTRONIC MAIL; ELECTRONIC TRANSMISSION OF DATA; INVENTORY MANAGEMENT; ORGANIZER, CALENDARING, AND SCHEDULING; PAYROLL; PRESENTATION GRAPHICS SOFTWARE AND UTILITY SOFTWARE FOR USE THEREWITH; PROJECT MANAGEMENT AND PROJECT SCHEDULING; SPREADSHEETS; WORD PROCESSING; WORKGROUP DATA SHARING AND COMMUNICATIONS; COMPUTER HARDWARE, COMPUTER PERIPHERALS, AND MANUALS SUPPLIED THEREWITH (U.S. CLS. 21, 23, 26, 36 AND 38).

SN 76-150,568. ASCOM HASLER MAILING SYSTEMS, INC., SHELTON, CT. FILED 10-19-2000.

POSTLINK

FOR ELECTRONIC EQUIPMENT COMPRISED OF HARDWARE AND OPERATING SOFTWARE FOR DETERMINING AND PRINTING POSTAGE, NAMELY, POSTAGE METERS, POSTAGE SCALES, POSTAGE PRINTERS, POSTAGE EVIDENCE PRINTERS, TAX EVIDENCE PRINTERS AND BAR CODE AND ADDRESS LABEL PRINTERS (U.S. CLS. 21, 23, 26, 36 AND 38).

CLASS 9—(Continued).

SN 76-153,393. RIOPORT.COM, INC., SAN JOSE, CA. FILED 10-24-2000.

RIOSOLO

OWNER OF U.S. REG. NO. 2,311,043.
THE ENGLISH TRANSLATION OF "RIO" IS "RIVER".
FOR CONSUMER ELECTRONIC COMPUTERIZED
DEVICE, NAMELY PORTABLE, DIGITAL AUDIO
PLAYER (U.S. CLS. 21, 23, 26, 36 AND 38).

SN 76-154,707. ERI ECONOMIC RESEARCH INSTITUTE,
REDMOND, WA. FILED 10-25-2000.

RETIREMENT ASSESSOR

OWNER OF U.S. REG. NOS. 1,974,899, 2,011,584 AND
OTHERS.

NO CLAIM IS MADE TO THE EXCLUSIVE RIGHT TO
USE "RETIREMENT", APART FROM THE MARK AS
SHOWN.

FOR COMPUTER SOFTWARE FOR USE IN DATA-
BASE MANAGEMENT CONTAINING DATABASE RE-
LATED TO COMPENSATION, ECONOMIC COST OF
LIVING, BENEFITS, AND HUMAN RESOURCE DEMO-
GRAPHIC INFORMATION THAT CAN COMMUNICATE
AND BE UPDATED WITH SURVEYS AND DATABASE
INFORMATION FROM THE GLOBAL COMPUTER IN-
FORMATION NETWORK (U.S. CLS. 21, 23, 26, 36 AND
38).

FIRST USE 8-0-1996; IN COMMERCE 1-0-1997.

SN 76-156,116. VIANIX, LC, VIRGINIA BEACH, VA. FILED
10-30-2000.

VIANIX

FOR SELF-CONTAINED AND ACCESSORY COMMU-
NICATIONS EQUIPMENT, NAMELY COMPUTER PER-
IPHERALS, HANDHELD COMPUTERS, PERSONAL
DIGITAL ASSISTANTS, ELECTRONIC ORGANIZERS,
ELECTRONIC NOTEPADS, DIGITAL AUDIO RECOR-
DERS, AND DIGITAL AUDIO PLAYBACK DEVICES,
FOR HANDHELD USE AND CONNECTIVITY TO PER-
SONAL COMPUTERS, MINIATURE COMPUTERS, PER-
SONAL DIGITAL ASSISTANTS, AUDIO EQUIPMENT,
NAMELY AUDIO TAPE RECORDERS AND PLAYERS
AND STEREO RECEIVERS, VIDEO EQUIPMENT,
NAMELY VIDEO CASSETTE RECORDERS AND
PLAYERS, PHOTOGRAPHIC EQUIPMENT, NAMELY
DIGITAL CAMERAS AND CAMCORDERS, DICTATION
EQUIPMENT, NAMELY AUDIO TAPE AND DIGITAL
AUDIO RECORDERS AND PLAYERS, PAGES, CELLU-
LAR TELEPHONES AND TELEPHONE LINES FOR THE
PURPOSE OF DATA PROCESSING, NAMELY RECEIV-
ING, MANIPULATING, CONVERTING, RECORDING,
REPRODUCING, STORING, ORGANIZING, EDITING,
COMPRESSING, DECOMPRESSING, ENCODING, DE-
CODING, PLAYING, TRANSMITTING, TRANSFER-
RING, AND TRANSCRIBING ANALOG AND DIGITAL
DATA, TOGETHER WITH RELATED ACCESSORIES,
NAMELY DISPLAY DEVICES, NAMELY COMPUTER
MONITORS AND PERSONAL DIGITAL ASSISTANT
DISPLAYS, RECORDING DEVICES, NAMELY AUDIO
TAPE AND DIGITAL RECORDERS, PLAY-BACK DE-

CLASS 9—(Continued).

VICES, NAMELY AUDIO TAPE AND DIGITAL
PLAYERS, DATA TRANSFER DEVICES, NAMELY
COMPUTERS AND PERSONAL DIGITAL ASSISTANTS,
MEMORY DEVICES, NAMELY COMPUTER MEMORY
CARDS, DATA STORAGE DEVICES, NAMELY BLANK
MAGNETIC DATA CARRIERS AND COMPUTER MEM-
ORY CARDS, ELECTRICAL CONTROLLERS, CRADLES
FOR RECHARGING AND CONNECTING THE SELF-
CONTAINED AND ACCESSORY COMMUNICATIONS
EQUIPMENT TO THE FOREGOING, MODEMS, CASES
FOR HOLDING THE SELF-CONTAINED AND ACCE-
SSORY COMMUNICATIONS EQUIPMENT, ADAPTERS
FOR CONNECTING THE SELF-CONTAINED AND AC-
CESSORY COMMUNICATIONS EQUIPMENT TO THE
FOREGOING, MICROPHONES, HEADPHONES, TRAN-
SCRIPTION EQUIPMENT, NAMELY AUDIO TAPE AND
DIGITAL AUDIO RECORDERS AND PLAYERS, ELEC-
TRONIC FOOT PEDALS FOR CONTROLLING THE
FOREGOING TRANSCRIPTION EQUIPMENT, AND IN-
STRUCTION MANUALS SOLD THEREWITH (U.S. CLS.
21, 23, 26, 36 AND 38).

SN 76-157,037. BULLBRO DUCK CLUB, INC., CARLISLE,
AR. FILED 10-31-2000.

GET'N NASTY

FOR HUNTING VIDEOS, NAMELY, PRERECORDED
VIDEO CASSETTES FEATURING HUNTING ACTIV-
ITIES (U.S. CLS. 21, 23, 26, 36 AND 38).

FIRST USE 6-2-2000; IN COMMERCE 6-2-2000.

SN 76-158,856. DASHBOX.COM, INC., SAN FRANCISCO, CA.
FILED 11-2-2000.

DASHMINDER

FOR COMPUTER TELEPHONE SOFTWARE WHICH
PROVIDES AUTOMATED REMINDER AND NOTIFICA-
TION SERVICES VIA TELEPHONE, FACSIMILE AND
ELECTRONIC MAIL (U.S. CLS. 21, 23, 26, 36 AND 38).

SN 76-158,857. DASHBOX.COM, INC., SAN FRANCISCO, CA.
FILED 11-2-2000.

DASHBOX

FOR COMPUTER SOFTWARE WHICH ALLOWS A
USER TO STORE AND MANAGE IMPORTANT PERSO-
NAL INFORMATION AND DOCUMENTS; COMPUTER
TELEPHONE SOFTWARE WHICH PROVIDES AUTO-
MATED REMINDER AND NOTIFICATION SERVICES
VIA TELEPHONE, FACSIMILE AND ELECTRONIC
MAIL (U.S. CLS. 21, 23, 26, 36 AND 38).

CLASS 9—(Continued).

SN 76-159,584. VIVIDLOGIC, INC., FREMONT, CA. FILED 11-3-2000.

FIREBUS

FOR COMPUTER NETWORKING HARDWARE AND COMPUTER NETWORKING SOFTWARE THAT FACILITATES THE INTEGRATION OF MANUFACTURERS PRODUCTS ACROSS IEEE 1394 AND WIRELESS NETWORKS; COMPUTER HARDWARE AND SOFTWARE THAT FACILITATES THE INTEROPERABILITY OF CONSUMER ELECTRONICS AND HOME NETWORKING APPLICATIONS; SOFTWARE PROGRAMS FOR NETWORK SOFTWARE DEVELOPERS AND NETWORK EQUIPMENT MANUFACTURERS THAT PROVIDES A UNIFORM SOFTWARE INTERFACE ACROSS MULTIPLE OPERATING SYSTEMS AND HARDWARE TYPES (U.S. CLS. 21, 23, 26, 36 AND 38).

FIRST USE 4-3-2000; IN COMMERCE 4-3-2000.

SN 76-160,341. SEMPAC, INC., SUNNYVALE, CA. FILED 11-2-2000.

OPEN-PAK

FOR OPEN CAVITY SEMICONDUCTOR ENCLOSURE USED TO CONNECT A SEMICONDUCTOR CHIP OR DIE TO EXTERNAL DEVICES (U.S. CLS. 21, 23, 26, 36 AND 38).

SN 76-161,105. LIGHTCROSS, INC., PASADENA, CA. FILED 11-6-2000.

SOBI

FOR OPTICAL NETWORKING COMPONENTS AND SUBSYSTEMS, NAMELY, WAVE DIVISION MULTIPLEXING AND OPTICAL SWITCHES, FILTERS, MODULATORS, OPTICAL SIGNAL AMPLIFIERS, EQUALIZERS, DEMULTIPLEXERS, LASERS, AND INTEGRATED CHIPS AND DEVICES, NAMELY, TRANSMITTERS, AMPLIFIERS, ADD/DROPS, CROSS CONNECTS, AND RECEIVERS (U.S. CLS. 21, 23, 26, 36 AND 38).

SN 76-161,937. INNOVATION DATA PROCESSING, INC., LITTLE FALLS, NJ. FILED 11-8-2000.

FDR PLUG AND SWAP

OWNER OF U.S. REG. NOS. 1,360,366, 2,402,651 AND OTHERS.

NO CLAIM IS MADE TO THE EXCLUSIVE RIGHT TO USE "PLUG AND SWAP", APART FROM THE MARK AS SHOWN.

FOR SOFTWARE CONTROLLING THE NON-DISRUPTIVE MOVEMENT OF DISK VOLUMES FROM ONE DISK VOLUME TO ANOTHER ON LARGE SCALE COMPUTER SYSTEMS (U.S. CLS. 21, 23, 26, 36 AND 38).

FIRST USE 11-16-2000; IN COMMERCE 11-16-2000.

CLASS 9—(Continued).

SN 76-164,018. STAR-BAK COMMUNICATIONS, WESTERVILLE, OH. FILED 11-13-2000.

TORRENT

FOR COMPUTER HARDWARE, NAMELY, VIDEO STREAM COMMUNICATION SERVERS (U.S. CLS. 21, 23, 26, 36 AND 38).

FIRST USE 10-18-2000; IN COMMERCE 1-15-2001.

SN 76-164,718. GENOA CORPORATION, FREMONT, CA. BY CHANGE OF NAME GENOA, FREMONT, CA. FILED 11-13-2000.

GENOA

FOR COMMUNICATIONS EQUIPMENT, NAMELY, SEMICONDUCTORS (U.S. CLS. 21, 23, 26, 36 AND 38).

SN 76-164,836. CONNECTCOM MICROSYSTEMS INC., IRVINE, CA. FILED 11-13-2000.

**CONNECTCOM
MICROSYSTEMS**

NO CLAIM IS MADE TO THE EXCLUSIVE RIGHT TO USE "MICROSYSTEMS", APART FROM THE MARK AS SHOWN.

FOR INTEGRATED CIRCUITS (U.S. CLS. 21, 23, 26, 36 AND 38).

FIRST USE 3-0-1999; IN COMMERCE 3-0-1999.

SN 76-166,121. CMC MAGNETICS CORPORATION. LTD., TAIPEI, TAIWAN, FILED 11-15-2000.

NAMECARD

FOR MAGNETIC STORAGE MEDIA, NAMELY BLANK COMPACT DISCS; BLANK MAGNETIC DISCS; BLANK CD-RS (CD-RECORDABLE); BLANK CD-RWS (CD-REWRITABLE); BLANK DVD-RS (DVD-RECORDABLE); BLANK DVD-RWS (DVD-RE-RECORDABLE); BLANK DVD-RAMS (DVD REWRITABLE) (U.S. CLS. 21, 23, 26, 36 AND 38).

CLASS 9—(Continued).

SN 76-166,422. BESSETTE, ROBERT C., TUCSON, AZ. FILED 11-16-2000.

JUNODI

FOR LIGHT STATIONS COMPRISING ONE OR MORE STROBE LIGHTS IN COMBINATION WITH ELECTRICAL CIRCUITRY TO RECEIVE SIGNALS FROM, AND TO PROVIDE SIGNALS TO, AN EXTERNAL CONTROLLER FOR THE PURPOSE OF INDICATING RATES OF SPEED IN SPORTS TRAINING (U.S. CLS. 21, 23, 26, 36 AND 38).

FIRST USE 7-0-1994; IN COMMERCE 7-0-1994.

SN 76-167,168. AYOUB, ABBY, NORTH BERGEN, NJ. FILED 11-17-2000.

CAMOUFLAGE

FOR OPTICAL GOODS, NAMELY, OPHTHALMIC LENS COATINGS SOLD AS A COMPONENT OF OR AS AN ADD-ON TO EYEGLASS, SPECTACLE, SUNGLASS, AND CONTACT LENSES (U.S. CLS. 21, 23, 26, 36 AND 38).

FIRST USE 10-11-1999; IN COMMERCE 10-18-1999.

SN 76-167,250. CELION NETWORKS, INC., RICHARDSON, TX. FILED 11-17-2000.

**OPTICAL NETWORKING
REDEFINED**

NO CLAIM IS MADE TO THE EXCLUSIVE RIGHT TO USE "OPTICAL NETWORKING", APART FROM THE MARK AS SHOWN.

FOR COMPUTER OPERATING SOFTWARE FOR OPERATION OF FIBER OPTIC TELECOMMUNICATIONS EQUIPMENT; TELECOMMUNICATIONS GATEWAY EQUIPMENT NAMELY, OPTO-ELECTRONIC ROUTERS, OPTO-ELECTRONIC SWITCHES, AND OPTO-ELECTRONIC TRANSPORT SYSTEMS, COMPRISING, OPTO-ELECTRONIC FIBER OPTIC TRANSPORT TERMINALS, OPTO-ELECTRONIC SIGNAL REGENERATORS, AND OPTO-ELECTRONIC IN-LINE AMPLIFIERS, FOR TRANSMITTING DATA OVER FIBER OPTIC CABLE NETWORKS (U.S. CLS. 21, 23, 26, 36 AND 38).

CLASS 9—(Continued).

SN 76-167,303. BFR HOLDINGS LIMITED, GRAND CAYMAN, CAYMAN ISLANDS, FILED 11-15-2000.



THE MARK CONSISTS OF AN OVAL WITH A BLACK BACKGROUND AND THE STYLIZED LETTERS "BFR" IN THE CENTER THEREOF. THE TIPS OF THE LETTER "F" PROTRUDE THROUGH THE OVAL AT THE TOP AND BOTTOM. A THIN BLACK RING SURROUNDS THE EXTERIOR OF THE OVAL.

FOR BULLETPROOF VESTS; PROTECTIVE HELMETS; PROTECTIVE FOOTWEAR; PROTECTIVE CLOTHING FOR PROTECTION AGAINST PRIMARY BLAST EFFECTS OF BALLISTIC WEAPONS SUCH AS BULLETS AND LAND MINES; AND PARTS THEREFOR (U.S. CLS. 21, 23, 26, 36 AND 38).

SN 76-168,751. GINN, MICHAEL R., SAN FRANCISCO, CA. FILED 11-20-2000.

QY

FOR COMPUTER PROGRAMS FOR COLLECTING, MANIPULATING AND REDIRECTING REAL-TIME AND STORE-AND-FORWARD MESSAGES CONVEYED VIA TELECOMMUNICATIONS FACILITIES BETWEEN MEMBERS OF A GROUP OF INDIVIDUALS TO FACILITATE THE DRAWING OF CONCLUSIONS AND THE SELECTION OF ACTION BY GROUP MEMBERS (U.S. CLS. 21, 23, 26, 36 AND 38).

FIRST USE 7-1-1999; IN COMMERCE 7-1-1999.

SN 76-169,324. NALGE NUNC INTERNATIONAL CORPORATION, ROCHESTER, NY. FILED 11-20-2000.

PURITI

FOR LABORATORY EQUIPMENT, NAMELY DISPOSABLE DEVICES, NAMELY FILTRATION TUBES AND PLATES, AND MEMBRANES FOR FLUID FILTRATION, PURIFICATION OF BIOLOGICAL AND CHEMICAL SAMPLES, SELECTIVE ABSORBENCY, SOLUTE CONCENTRATION OR SAMPLE PREPARATION FOR USE IN THE RESEARCH, ANALYTICAL AND CLINICAL LABORATORIES, PRIOR TO LIQUID OR GAS CHROMATOGRAPHIC, SPECTROSCOPIC, AND/OR OTHER ANALYTICAL AND PREPARATIVE TECHNIQUES (U.S. CLS. 21, 23, 26, 36 AND 38).

CLASS 9—(Continued).

SN 76-169,556. CALLBUTTON, LLC, RICHARDSON, TX. FILED 11-22-2000.

CALLBUTTON

FOR COMPUTER SOFTWARE FOR COMMUNICATIONS PROCESSING AND COMPUTER TELEPHONY, NAMELY, SOFTWARE FOR USE IN PROVIDING TELEPHONY COMMUNICATIONS VIA THE INTERNET (U.S. CLS. 21, 23, 26, 36 AND 38).

CLASS 9—(Continued).

SN 76-172,473. WORDEN BROTHERS, INC., DURHAM, NC. FILED 11-29-2000.

TIME SEGMENTED VOLUME

SEC. 2(F).
FOR COMPUTER PROGRAMS FOR ELECTRONIC DATA BASE MANAGEMENT IN THE FIELD OF STOCK MARKET ANALYSIS AND STOCK MARKET INDICATORS, RECORDED ON COMPUTER MEDIA (U.S. CLS. 21, 23, 26, 36 AND 38).
FIRST USE 0-0-1994; IN COMMERCE 0-0-1994.

SN 76-169,905. ACCELIGHT NETWORKS, INC., PITTSBURGH, PA. FILED 11-22-2000.

**ACCELIGHT NETWORKS
INC.**

NO CLAIM IS MADE TO THE EXCLUSIVE RIGHT TO USE "NETWORKS INC.", APART FROM THE MARK AS SHOWN.

FOR HIGH-SPEED OPTICAL WORKING SYSTEMS COMPRISING PHOTONIC SERVICE SWITCHES AND NETWORK MANAGERS FOR SWITCHING AND TRANSMISSION OVER GLOBAL COMPUTER NETWORKS (U.S. CLS. 21, 23, 26, 36 AND 38).

SN 76-172,791. INTERWOVEN, INC., SUNNYVALE, CA. FILED 11-27-2000.

INTRAGO

FOR COMPUTER SOFTWARE FOR CREATING AND EDITING CORPORATE INTRANET SITES (U.S. CLS. 21, 23, 26, 36 AND 38).
FIRST USE 9-10-2000; IN COMMERCE 9-13-2000.

SN 76-169,907. ACCELIGHT NETWORKS INC., PITTSBURGH, PA. FILED 11-22-2000.

ACCELIGHT

FOR HIGH SPEED OPTICAL NETWORKING SYSTEMS COMPRISING PHOTONIC SERVICE SWITCHES AND NETWORK MANAGERS FOR SWITCHING AND TRANSMISSION OVER GLOBAL COMPUTER NETWORKS (U.S. CLS. 21, 23, 26, 36 AND 38).

SN 76-173,103. AIWA CO., LTD., TAITO-KU, TOKYO, JAPAN, FILED 11-29-2000.

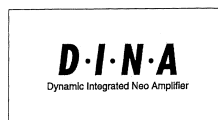

NO CLAIM IS MADE TO THE EXCLUSIVE RIGHT TO USE "AMPLIFIER", APART FROM THE MARK AS SHOWN. THE MARK CONSISTS OF THE WORD "D I N A" IN A STYLIZED FORMAT WITH DOTS BETWEEN EACH LETTER IN THE TERM AND THE WORDS "DYNAMIC INTEGRATED NEO AMPLIFIER".
FOR AMPLIFIERS (U.S. CLS. 21, 23, 26, 36 AND 38).

SN 76-170,065. FIBERSTARS, INC., FREMONT, CA. FILED 11-22-2000.

OPTICORE

FOR FIBERS OPTICS, NAMELY OPTICAL FIBERS FOR USE IN CONJUNCTION WITH ELECTRICAL ILLUMINATORS AND WITH LIGHTING FIXTURES FOR THE TRANSMISSION OF LIGHT (U.S. CLS. 21, 23, 26, 36 AND 38).

SN 76-174,171. CHEMBRIDGE CORPORATION, SAN DIEGO, CA. FILED 12-1-2000.

HIT2LEAD.COM

FOR DATABASE SOFTWARE FOR IDENTIFICATION AND CHARACTERIZATION OF COMPOUNDS WITH DRUG-LIKE PROPERTIES FOR THE PHARMACEUTICAL, LIFE SCIENCES, AGRICULTURAL AND CHEMICAL INDUSTRIES (U.S. CLS. 21, 23, 26, 36 AND 38).
FIRST USE 7-1-2000; IN COMMERCE 7-1-2000.

CLASS 9—(Continued).

SN 76-175,667. DOUBLECLICK INC., NEW YORK, NY. FILED 12-5-2000.

STRATEGYMEDIA

FOR COMPUTER PROGRAMS, NAMELY, COMMUNICATIONS AND DATABASE MANAGEMENT PROGRAMS IN THE FIELDS OF ONLINE ADVERTISING, PROMOTION AND ADVERTISEMENT BANNERS (U.S. CLS. 21, 23, 26, 36 AND 38).

SN 76-176,271. CAREERCENTRIC INC., STAMFORD, CT. FILED 12-6-2000.

CAREER DNA

NO CLAIM IS MADE TO THE EXCLUSIVE RIGHT TO USE "CAREER", APART FROM THE MARK AS SHOWN.
FOR COMPUTER SOFTWARE PROGRAMS FOR MEASURING, VALUING, AND ANALYZING DATA AND GENERATING REPORTS THEREFROM FOR CAREER ASSESSMENT, CAREER SATISFACTION AND LIFE FULFILLMENT, AND PERSONAL PLACEMENT, SELECTION AND RECRUITMENT (U.S. CLS. 21, 23, 26, 36 AND 38).

SN 76-176,552. BAE SYSTEMS PLC, FARNBOROUGH, HAMPSHIRE, GREAT BRITAIN, FILED 12-6-2000.



PRIORITY CLAIMED UNDER SEC. 44(D) ON UNITED KINGDOM APPLICATION NO. 2237928, FILED 6-30-2000, REG. NO. 2237928, DATED 6-30-2000, EXPIRES 6-30-2010.
FOR HEAD-UP DISPLAY USED TO PROJECT FLIGHT INFORMATION INTO AN AIRCRAFT PILOT'S FIELD OF VIEW (U.S. CLS. 21, 23, 26, 36 AND 38).

SN 76-176,617. BAE SYSTEMS PLC, HAMPSHIRE, GREAT BRITAIN, FILED 12-6-2000.

VGS

PRIORITY CLAIMED UNDER SEC. 44(D) ON GREAT BRITAIN APPLICATION NO. 2237922, FILED 6-30-2000, REG. NO. 2237922, DATED 6-30-2000, EXPIRES 6-30-2010.
FOR HEAD-UP DISPLAY USED TO PROJECTOR FLIGHT INFORMATION INTO AN AIRCRAFT PILOT'S FIELD OF VIEW (U.S. CLS. 21, 23, 26, 36 AND 38).

CLASS 9—(Continued).

SN 76-177,767. LEVITON MANUFACTURING CO., INC., LITTLE NECK, NY. FILED 12-8-2000.



NO CLAIM IS MADE TO THE EXCLUSIVE RIGHT TO USE "TECHNOLOGY", APART FROM THE MARK AS SHOWN.

FOR ELECTRICAL WIRING AND CIRCUITRY DEVICES, NAMELY POWERLINE CARRIER FOR HOME AUTOMATION PRODUCTS, NAMELY ELECTRICAL SWITCHES, ELECTRICAL LIGHT DIMMERS, RECEPTACLES, ELECTRICAL SWITCH PLATES AND ESCUTCHEON PLATES (U.S. CLS. 21, 23, 26, 36 AND 38).

SN 76-178,044. DERMICOR, INC., FRANKLIN, TN. FILED 12-8-2000.

DERMICOR

FOR COMPUTER SOFTWARE FOR USE IN THE FIELD OF HEALTH CARE, NAMELY, SOFTWARE DESIGNED TO ASSIST HEALTH CARE PROFESSIONALS PERFORM ENTEROSTOMAL ASSESSMENTS AND MAKE RECOMMENDATIONS FOR PATIENT CARE REGARDING LONG TERM CARE, HOME CARE, PHYSICIAN PRACTICES, AND ALTERNATE SITE SERVICES (U.S. CLS. 21, 23, 26, 36 AND 38).

SN 76-178,338. YIM, CHEUNG PING, NEW TERRITORIES, HONG KONG, AND TSOU, CHEUNG TIN, NEW TERRITORIES, HONG KONG, FILED 12-8-2000.

EMAGE

FOR CAMERAS, NAMELY, DISPOSABLE CAMERAS, PHOTOGRAPHIC FILM CAMERAS, DIGITAL STILL CAMERAS, AND DIGITAL VIDEO CAMERAS; CAMCORDERS; OPTICAL LENSES; BINOCULARS; COMPUTER PERIPHERAL DEVICES; COMPUTER SOFTWARE FOR USE WITH DIGITAL STILL CAMERAS THAT DRIVES THE USER INTERFACE AND ALLOWS THE EDITING OF IMAGES; INTEGRATED CIRCUITS; JUKE BOXES FOR COMPUTERS; SOUND RECORDING, SOUND, AUDIO AND VIDEO APPARATUS, MACHINES, AND INSTRUMENTS, NAMELY, CD RECORDERS AND PLAYERS, DVD RECORDERS AND PLAYERS, DIGITAL AUDIO RECORDERS AND PLAYERS, VCD RECORDERS AND PLAYERS, MP3 RECORDERS AND PLAYERS, AND OPTICAL DISC RECORDERS AND PLAYERS (U.S. CLS. 21, 23, 26, 36 AND 38).

CLASS 9—(Continued).

SN 76-178,538. NETMASK (EL-MAR) INTERNET TECHNOLOGIES LTD., KFAR-SABA 44641, ISRAEL, FILED 12-11-2000.

THE MARK CONSISTS OF THE STYLIZED TERM "NETMASK.IT" AND DESIGN.

FOR PROXY AND/OR A WEB SERVER AND/OR MIDDLEWARE, USED FOR THE TRANSFORMATION AND/OR FILTERING AND/OR REPURPOSING OF INTERNET CONTENT (U.S. CLS. 21, 23, 26, 36 AND 38).

SN 76-179,413. PORTRAIT DISPLAYS, INC., PLEASANTON, CA. FILED 12-13-2000.

PIVOT

OWNER OF U.S. REG. NOS. 1,670,731 AND 2,381,737. SEC. 2(F).
FOR COMPUTER SOFTWARE FOR OPERATING COMPUTER MONITORS (U.S. CLS. 21, 23, 26, 36 AND 38).

FIRST USE 8-30-1995; IN COMMERCE 8-30-1995.

SN 76-179,780. ISERVICEX.COM, INC., ATLANTA, GA. FILED 12-12-2000.

ROSI

FOR COMPUTER SOFTWARE USED FOR THE PROCUREMENT, DELIVERY AND MANAGEMENT OF PROFESSIONAL SERVICES, NAMELY, USED FOR THE GENERATION OF ELECTRONIC REQUESTS FOR PROPOSALS, ELECTRONIC REQUESTS FOR INFORMATION, ONLINE PROPOSAL DEVELOPMENT AND USED FOR AUCTIONING PROFESSIONAL SERVICES (U.S. CLS. 21, 23, 26, 36 AND 38).

CLASS 9—(Continued).

SN 76-180,037. SHINANO KENSHI KABUSHIKI KAISHA, CHIISAGATA-GUN, NAGANO 386-0498, JAPAN, FILED 12-13-2000.

PLEXMASTER

OWNER OF U.S. REG. NO. 2,159,329.
FOR COMPUTER HARDWARE, NAMELY, CENTRAL PROCESSING UNITS; COMPUTER PERIPHERALS; INTEGRATED CIRCUITS; COMPUTER SOFTWARE FOR WORD PROCESSING, TABLE-CALCULATION, DATA COMMUNICATION, DATABASE MANAGEMENT FOR USE AS A SPREADSHEET, ACCOUNTING, SOFTWARE FOR CREATING BUSINESS SPREADSHEETS, VIDEO GAMES, COMPUTER GRAPHICS AND FOREIGN LANGUAGE TRANSLATION; AUDIO REPRODUCTION AND AUDIO RECORDING EQUIPMENT, NAMELY, BLANK MAGNETIC COMPUTER TAPES AND COMPUTER DISCS; ELECTRICAL COMMUNICATION MACHINES AND APPARATUS, NAMELY, RADIOS AND SATELLITE DISHES; AUDIO FREQUENCY APPARATUS, NAMELY, AUDIO TAPE RECORDERS, AUDIO DISK RECORDERS, PHONOGRAPH RECORD PLAYERS, COMPACT DISC PLAYERS, CD-ROM DRIVES, CD-R DRIVES, CD-RW DRIVES; WRITTEN COMPUTER PROGRAM FOR WRITING DATA IN CD-R AND CD-RW; PARTS AND ACCESSORIES FOR ELECTRICAL COMMUNICATION MACHINES AND APPARATUS, NAMELY, MICROPHONES, PRE-RECORDED MAGNETIC DISKS AND TAPES, AND PHONOGRAPH MAGNETIC RECORDS AND COMPACT DISKS, ALL FEATURING MUSIC AND VOICE FOR EDUCATIONAL AND ENTERTAINMENT PURPOSES IN THE FIELD OF MATHEMATICS, PHYSICS, SCIENCE, CHEMISTRY, LANGUAGES, POETRY, COMEDY AND NOVELS (U.S. CLS. 21, 23, 26, 36 AND 38).

SN 76-180,977. ATRONIC INTERNATIONAL GMBH, D-32312 LUBBECKE, FED REP GERMANY, FILED 12-13-2000.

BEETLE MANIA

PRIORITY CLAIMED UNDER SEC. 44(D) ON FED REP GERMANY APPLICATION NO. 300857470/09. FILED 11-22-2000, REG. NO. 30085747, DATED 2-12-2001, EXPIRES 11-30-2010.

FOR GAMING MACHINES; GAMING MACHINES FEATURING SLOT MACHINE TYPE GAMES VIA VIDEO DISPLAY; ELECTRONIC SLOT MACHINES INCORPORATING OPERATING SOFTWARE (U.S. CLS. 21, 23, 26, 36 AND 38).

SN 76-181,184. VIRTUAL PERSONALITIES, INC., LOS ANGELES, CA. FILED 12-14-2000.

STARBOT

FOR COMPUTER SOFTWARE WHICH ALLOWS USERS TO INTERFACE WITH OTHER SOFTWARE PROGRAMS BY PROVIDING ADVICE, RECOMMENDATIONS, INSTRUCTIONS, ANSWERING QUESTIONS AND GATHERING INFORMATION FOR SUCH USER, AND FOR SIMULATING THE LIKENESS, FACIAL EXPRESSION AND SPEECH OF A HUMAN BEING; PRE-RECORDED COMPUTER SOFTWARE PROGRAMS CONTAINING ANIMATED CHARACTERS WHICH SIMULATE HUMAN BEINGS (U.S. CLS. 21, 23, 26, 36 AND 38).

CLASS 9—(Continued).

SN 76-182,016. CALICO EDUCATIONAL SOFTWARE, INC.,
ERIE, CO. FILED 12-18-2000.

FASTTRACKER

FOR COMPUTER SOFTWARE FOR UNIVERSITY AND K-12 TEACHERS AND ADMINISTRATORS THAT HELPS DETERMINE, TRACK, AND MANAGE CLASS AND STUDENT INFORMATION, GRADES, ATTENDANCE, LESSON PLANS AND COURSE WORK, AND ENABLES COMMUNICATION WITH STUDENTS AND PARENTS (U.S. CLS. 21, 23, 26, 36 AND 38).
FIRST USE 9-1-2000; IN COMMERCE 9-1-2000.

SN 76-182,304. IVERSON, RONALD, TIERRA VERDE, FL.
FILED 12-18-2000.

GITS

FOR SECURITY, SITE MANAGEMENT AND SURVEILLANCE EQUIPMENT, COMPRISED OF DIGITAL VIDEO RECORDERS, CAMERAS, SENSORS, DIGITAL IMAGE AND DATA RECORDERS CONNECTED TO CAMERAS, ALARMS AND SENSORS, WHICH VIEW, RECORD AND TRANSFER VIDEO IMAGES AND DATA THROUGH CONNECTIONS BY THE INTERNET, CABLE AND TELEPHONE LINES, WITH REMOTE OFF-SITE VIEWING AND CONTROL CAPABILITIES (U.S. CLS. 21, 23, 26, 36 AND 38).

SN 76-182,862. SIMPATA, INC., FOLSOM, CA. FILED 12-13-2000.

SIMPLY BENEFITS

NO CLAIM IS MADE TO THE EXCLUSIVE RIGHT TO USE "BENEFITS", APART FROM THE MARK AS SHOWN.
FOR COMPUTER SOFTWARE FOR THE CAPTURE, MANAGEMENT AND TRANSMISSION OF DATA IN THE FIELDS OF HUMAN RESOURCES AND BENEFITS ADMINISTRATION (U.S. CLS. 21, 23, 26, 36 AND 38).

SN 76-182,921. SURGE COMPONENTS, INC., DEER PARK,
NY. FILED 12-20-2000.



SEC. 2(F).

FOR ELECTRIC COMPONENT PRODUCTS, NAMELY, CAPACITORS, MAGNETIC TRANSDUCERS, MAGNETIC BUZZERS, PIEZO BUZZERS, EXTERNAL DRIVE PIEZO TRANSDUCERS, SELF DRIVE PIEZO TRANSDUCERS, MECHANICAL BUZZERS, SPEAKERS, CONDENSER MICROPHONES, SMD PIEZOELECTRIC CERAMIC AUDIO MICROPHONES AND SEMICONDUCTORS, NAMELY, RECTIFIERS, DIODES (U.S. CLS. 21, 23, 26, 36 AND 38).
FIRST USE 0-0-1981; IN COMMERCE 0-0-1981.

CLASS 9—(Continued).

SN 76-183,075. HUTH, ALLEN S., II, SLIDELL, LA. FILED 12-18-2000.



FOR AUDIO SPEAKER ENCLOSURES (U.S. CLS. 21, 23, 26, 36 AND 38).
FIRST USE 9-1-1999; IN COMMERCE 9-1-1999.

SN 76-185,144. TRUSTEES OF THE JONAS SALK TRUST, A CALIFORNIA TRUST, THE TRUSTEES COMPRISING DARRELL J. SALK, JONATHAN D. SALK AND PETER L. SALK, ALL U.S. CITIZENS, THE, SEATTLE, WA. FILED 12-21-2000.

JONAS SALK

"JONAS SALK" IS THE NAME OF A DECEASED INDIVIDUAL.

FOR ELECTRONIC PUBLICATIONS, NAMELY EDUCATIONAL ARTICLES, BOOKS, MAGAZINES FEATURING MEDICINE, HISTORY, SCIENCE, PHILOSOPHY, ART, ARCHITECTURE, LITERATURE RECORDED ON MAGNETIC MEDIA, CD-ROM, DVD; DOWNLOADABLE ELECTRONIC PUBLICATIONS IN THE NATURE OF ARTICLES, BOOKS, MAGAZINES IN THE FIELDS OF MEDICINE, HISTORY, SCIENCE, PHILOSOPHY, ART, ARCHITECTURE, LITERATURE; COMPUTER SOFTWARE FOR USE IN EDUCATION IN THE FIELDS OF MEDICINE, HISTORY, SCIENCE, PHILOSOPHY, ART, ARCHITECTURE, LITERATURE; PRERECORDED AUDIO AND VIDEO TAPES, PRERECORDED AUDIO AND VIDEO CASSETTES, PRERECORDED CD-ROMS AND PRERECORDED DVDS, ALL FEATURING EDUCATIONAL MATERIALS IN THE FIELDS OF MEDICINE, HISTORY, SCIENCE, PHILOSOPHY, ART, ARCHITECTURE, LITERATURE (U.S. CLS. 21, 23, 26, 36 AND 38).

SN 76-185,495. TERATECH CORPORATION, BURLINGTON,
MA. FILED 12-21-2000.

TERASON

FOR COMPUTERS, DATA PROCESSORS, TRANSDUCERS, ELECTRONIC DELAY CIRCUITRY, SCAN CONVERSION CIRCUITRY, AND COMPUTER SOFTWARE, NAMELY, SOFTWARE FOR ULTRASOUND SYSTEMS FOR MEASUREMENT, ANALYSIS AND DIAGNOSIS OF PATIENTS, COMPUTER SOFTWARE THAT TRANSFERS, MANIPULATES AND DISPLAYS ULTRASOUND IMAGES FOR MEDICAL USE (U.S. CLS. 21, 23, 26, 36 AND 38).

CLASS 9—(Continued).

SN 76-185,788. MOULINEX S.A., F-14123 CORMELLES LE ROYAL, FRANCE, FILED 12-26-2000.

ORANIUM

PRIORITY CLAIMED UNDER SEC. 44(D) ON FRANCE APPLICATION NO. 003037487, FILED 6-26-2000, REG. NO. 003037487, DATED 6-26-2000, EXPIRES 6-26-2010.

FOR ELECTRIC STEAM IRON (U.S. CLS. 21, 23, 26, 36 AND 38).

SN 76-187,931. FLOW AUTOMATION INC., HOUSTON, TX. FILED 12-29-2000.

AUTOPILOT

FOR FLOW COMPUTERS FOR MEASURING LIQUID AND GAS FLOW THROUGH PIPELINES AND FOR CALCULATING THE ACTUAL VOLUME OF FLUIDS (U.S. CLS. 21, 23, 26, 36 AND 38).

FIRST USE 11-0-1995; IN COMMERCE 11-0-1995.

SN 76-188,794. MONSTER CABLE PRODUCTS, INC., BRISBANE, CA. FILED 12-28-2000.

MONSTER WIRE AMERICA

OWNER OF U.S. REG. NO. 2,234,755.

NO CLAIM IS MADE TO THE EXCLUSIVE RIGHT TO USE "WIRE", APART FROM THE MARK AS SHOWN.

FOR ELECTRICAL SIGNAL TRANSMITTING CABLES AND CONNECTORS (U.S. CLS. 21, 23, 26, 36 AND 38).

FIRST USE 11-17-1999; IN COMMERCE 11-17-1999.

SN 76-191,166. TECAN U.S., INC., RESEARCH TRIANGLE PARK, NC. FILED 1-8-2001.

NEPTUNE

FOR COMPUTER SOFTWARE USED TO SELECT AND CONTROL EXPERIMENTS PERFORMED BY ROBOTIC LIQUID HANDLING INSTRUMENTS FOR LIFE SCIENCE APPLICATIONS (U.S. CLS. 21, 23, 26, 36 AND 38).

SN 76-191,167. TECAN U.S., INC., RESEARCH TRIANGLE PARK, NC. FILED 1-8-2001.

MINERVA

FOR COMPUTER SOFTWARE USED TO SELECT AND CONTROL EXPERIMENTS PERFORMED BY ROBOTIC LIQUID HANDLING INSTRUMENTS FOR LIFE SCIENCE APPLICATIONS (U.S. CLS. 21, 23, 26, 36 AND 38).

CLASS 9—(Continued).

SN 76-191,813. HAIX-SCHUHE PRODUKTIONS UND VERTRIEBS GMBH, FED REP GERMANY, BY ASSIGNMENT HAIMERL, EWALD, 84048 MAINBURG, FED REP GERMANY, FILED 1-9-2001.

FIRE HUNTER

OWNER OF FED REP GERMANY REG. NO. 39922581, DATED 7-6-1999, EXPIRES 4-30-2009.

FOR PROTECTIVE INDUSTRIAL FOOTWEAR, NAMELY, FIRE, IMPACT AND WATER RESISTANT BOOTS FOR USE BY FIREFIGHTERS (U.S. CLS. 21, 23, 26, 36 AND 38).

SN 76-193,928. ASCENT TECHNOLOGY, INC., CAMBRIDGE, MA. FILED 1-12-2001.

**SMARTAIRPORT
PERSONNEL ALLOCATOR**

OWNER OF U.S. REG. NOS. 2,328,868 AND 2,341,748.

NO CLAIM IS MADE TO THE EXCLUSIVE RIGHT TO USE "PERSONNEL ALLOCATOR", APART FROM THE MARK AS SHOWN.

SEC. 2(F).

FOR COMPUTER SOFTWARE IN THE FIELD OF AIRLINE AND AIRPORT RESOURCE MANAGEMENT, FOR USE IN ASSIGNING AIRLINE AND AIRPORT STAFF AND EMPLOYEES TO TASKS AND ACTIVITIES AT AIRPORTS, AND USER MANUALS SOLD AS A UNIT THEREWITH (U.S. CLS. 21, 23, 26, 36 AND 38).

SN 76-193,984. SKYHAWKE TECHNOLOGIES, LLC, RIDGE-LAND, MS. FILED 1-12-2001.



FOR COMPUTER SOFTWARE FOR DETERMINING DISTANCES ON GOLF COURSES AND FOR ACCESSING OF RELEVANT DATA AND STATISTICS PERTINENT THERETO UTILIZING AMONG OTHER THINGS PERSONAL COMPUTER DEVICES (U.S. CLS. 21, 23, 26, 36 AND 38).

CLASS 9—(Continued).

SN 76-193,999. ASCENT TECHNOLOGY, INC., CAMBRIDGE, MA. FILED 1-12-2001.

SMARTAIRPORT SCHEDULE BUILDER

OWNER OF U.S. REG. NOS. 2,328,868 AND 2,341,748.
NO CLAIM IS MADE TO THE EXCLUSIVE RIGHT TO USE "SCHEDULE BUILDER", APART FROM THE MARK AS SHOWN.
SEC. 2(F).

FOR COMPUTER SOFTWARE IN THE FIELD OF AIRPORT RESOURCE MANAGEMENT FOR USE IN CREATING AND MANAGING AIRPORT FLIGHT SCHEDULES, AND USER MANUALS SOLD AS A UNIT THEREWITH (U.S. CLS. 21, 23, 26, 36 AND 38).

SN 76-194,680. SIMPLIFIED DEVELOPMENT CORPORATION, AUSTIN, TX. FILED 1-16-2001.

BROAD REACH

FOR TELEPHONIC SWITCHING SOFTWARE AND SYSTEMS, NAMELY, THOSE USED TO FACILITATE CALL ROUTING AND TELEPHONY AND CABLE BASED SERVICE PROVISIONING (U.S. CLS. 21, 23, 26, 36 AND 38).

SN 76-194,709. TWINMOS INDUSTRIES (USA), INC., GREAT NECK, NY. FILED 1-12-2001.

SYNCMEDIA MEMORY

NO CLAIM IS MADE TO THE EXCLUSIVE RIGHT TO USE "MEMORY", APART FROM THE MARK AS SHOWN.
FOR SEMICONDUCTORS; COMPUTER MEMORY DEVICES; COMPUTER MEMORY MODULES; AND COMPUTER HARDWARE FLASH MEMORY CARDS (U.S. CLS. 21, 23, 26, 36 AND 38).

SN 76-194,888. SONY KABUSHIKI KAISHA, TA SONY CORPORATION, TOKYO, JAPAN, FILED 1-17-2001.



NO CLAIM IS MADE TO THE EXCLUSIVE RIGHT TO USE "E-CONFERENCE", APART FROM THE MARK AS SHOWN.

FOR ELECTRONIC CONFERENCE SYSTEM COMPRISED OF VIDEO CAMERA, COMPUTER SERVER, PERSONAL COMPUTER, PROJECTOR, PROJECTOR SCREEN OR MONITOR, HUB, WIRELESS ACCESS TERMINAL, SCANNER, PRINTERS, WIRELESS LAN CARD, MICROPHONE AND SPEAKER (U.S. CLS. 21, 23, 26, 36 AND 38).

CLASS 9—(Continued).

SN 76-195,632. TH INDUSTRIES, INC., COPIAGUE, NY. FILED 1-17-2001.

M2

FOR SURGE PROTECTOR ASSEMBLY UNITS CONSISTING PRIMARILY OF SURGE PROTECTORS AND GROUND FAULT PROTECTORS, USED TO PROTECT COMMUNICATION EQUIPMENT FROM OVER-VOLTAGE SURGES AND GROUND FAULTS (U.S. CLS. 21, 23, 26, 36 AND 38).

SN 76-198,857. PRINCIPIA PRODUCTS, INC., PAOLI, PA. FILED 1-24-2001.

REMARK QUICK STATS

OWNER OF U.S. REG. NOS. 1,988,416 AND 2,400,725.
NO CLAIM IS MADE TO THE EXCLUSIVE RIGHT TO USE "QUICK STATS", APART FROM THE MARK AS SHOWN.

FOR COMPUTER SOFTWARE FOR USE IN STATISTICAL ANALYSIS OF SURVEY, RESEARCH AND TEST DATA (U.S. CLS. 21, 23, 26, 36 AND 38).

FIRST USE 11-0-2000; IN COMMERCE 11-0-2000.

SN 76-199,738. HITACHI AMERICA, LTD., BRISBANE, CA. FILED 1-24-2001.

AIRSHO

FOR DISPLAY EQUIPMENT, NAMELY A VISUAL PROJECTOR, A TRANSPARENT SCREEN APPLIED TO GLASS AND A DATA STORAGE UNIT IN THE NATURE OF COMPUTER HARDWARE (U.S. CLS. 21, 23, 26, 36 AND 38).

FIRST USE 10-10-2000; IN COMMERCE 10-23-2000.

SN 76-200,100. JIMRAY TECHNOLOGY INC., NEIHU, TAIPEI, TAIWAN, FILED 1-26-2001.

FOR TACHOMETER, SPEEDOMETER, PYROMETER, TEMPERATURE GAUGE, PRESSURE GAUGE, FUEL GAUGE, AMMETER AND VOLTMETER, SENDER, NAMELY A DETECTOR THAT COLLECTS INSTANT INFORMATION AND TRANSMITS SAME TO A GAUGE INDICATOR OR OTHER DEVICE FOR FURTHER PROCESSING, ENGINE REVOLUTION COUNTER HOUR-METER, AIR AND FUEL RATIO GAUGE, VACUUM GAUGE, AND DIRECTIONAL COMPASS (U.S. CLS. 21, 23, 26, 36 AND 38).

CLASS 9—(Continued).

SN 76-200,102. PROGAUGES CO., LTD., LUNGTAN HSIANG, TAOYUAN HSIEN, TAIWAN, FILED 1-26-2001.



FOR TACHOMETER, SPEEDOMETER, PYROMETER, TEMPERATURE GAUGE, PRESSURE GAUGE, FUEL GAUGE, AMMETER AND VOLTMETER, SENDER, NAMELY, A DETECTOR THAT COLLECTS INSTANT INFORMATION AND TRANSMITS SAME TO A GAUGE INDICATOR OR OTHER DEVICE FOR FURTHER PROCESSING, ENGINE REVOLUTION COUNTER HOUR-METER, AIR AND FUEL RATIO GAUGE, VACUUM GAUGE, AND DIRECTIONAL COMPASSES (U.S. CLS. 21, 23, 26, 36 AND 38).

FIRST USE 12-31-1993; IN COMMERCE 12-31-1993.

SN 76-201,068. LODESTAR CORPORATION, PEABODY, MA. FILED 1-29-2001.

RATEEXPERT

FOR COMPUTER SOFTWARE FOR ESTIMATING AND EVALUATING CHANGES IN ENERGY PRICING, AND ANALYZING REVENUE IMPACT OF CHANGES IN ENERGY PRICING FOR USE BY THE UTILITY INDUSTRY (U.S. CLS. 21, 23, 26, 36 AND 38).

FIRST USE 3-0-1992; IN COMMERCE 3-0-1992.

SN 76-201,069. LODESTAR CORPORATION, PEABODY, MA. FILED 1-29-2001.

BILLINGEXPERT

FOR COMPUTER SOFTWARE FOR PROCESSING BILLING CALCULATIONS FOR USE BY THE UTILITY INDUSTRY (U.S. CLS. 21, 23, 26, 36 AND 38).

FIRST USE 5-0-1996; IN COMMERCE 5-0-1996.

SN 76-202,109. STRALFORS INTERNATIONAL INCORPORATED, DOWNERS GROVE, IL. FILED 1-31-2001.

LASERMAX

OWNER OF U.S. REG. NO. 1,875,060.

FOR ELECTRONIC PRINTING EQUIPMENT AND ACCESSORIES, NAMELY, REWINDERS, UNWINDERS, PRINTED FORMS TRANSPORT CARTS, FOLDERS, CUTTERS, BUFFERS, ALIGNER HOLE PUNCHERS, STACK TURNERS, POLYWRAPPER AND HEAT TUNNELS, FOLDER, STACKERS, SEPARATORS (U.S. CLS. 21, 23, 26, 36 AND 38).

FIRST USE 3-15-1985; IN COMMERCE 3-15-1985.

CLASS 9—(Continued).

SN 76-202,383. HUGEWIN ELECTRONICS CO., LTD., CHU-PEI, TAIWAN, FILED 1-29-2001.



FOR TELEPHONE ANSWERING MACHINES, ELECTRIC DOOR BELLS, ELECTRONIC DOOR OPENERS, ELECTRIC LIGHT SWITCHES, TELEPHONE TRANSMITTERS (U.S. CLS. 21, 23, 26, 36 AND 38).

SN 76-203,623. ATRONIC INTERNATIONAL GMBH, LUBBECKE, FED REP GERMANY, FILED 1-26-2001.

CASHANOVA

FOR ELECTRIC AND ELECTRONIC GAMING AND GAMBLING MACHINES; ELECTRIC, ELECTRONIC, ELECTROMECHANICAL AND ELECTROPNEUMATIC SPORTING ACTIVITIES AND GAME PLAYING SIMULATORS; MULTI-USER AND NETWORKED GAMING AND GAMBLING MACHINES, NAMELY, MULTI-STATION SIMULATORS; AFOREMENTIONED APPARATUS, DEVICES, MACHINES AND SIMULATORS ARRANGED FOR OPERATION UPON PAYMENT BY MEANS OF COINS, BANK NOTES, TOKENS, MAGNETIC STRIP CARDS AND SIMILAR MONEY SURROGATE CARRIERS; COMPUTER VIDEO GAME MACHINES, AND VIDEO AND COMPUTER GAME APPARATUS AND INSTRUMENTS, NAMELY, VIDEO GAME MACHINES FOR USE WITH TELEVISIONS AND CATHODE RAY TERMINALS; PRE-RECORDED MAGNETIC DATA CARRIERS FEATURING RECORDED PROGRAMS FOR USE WITH GAMING, AMUSEMENT AND GAMBLING APPARATUS, DEVICES AND MACHINES; MONEY EXCHANGE APPARATUS, NAMELY TOKEN, JETON AND GAME CARD VENDING MACHINES; FIRMWARE AND SOFTWARE FEATURING ACTION FILMS AND SIMULATED GAMES FOR USE IN ELECTRIC AND ELECTRONIC GAME, AMUSEMENT AND GAMBLING APPARATUS, DEVICES AND MACHINES; DATA RECORDING APPARATUS, NAMELY, MAGNETIC DISK DRIVES, MAGNETIC TAPE DRIVES AND SEMICONDUCTOR MEMORY FOR USE WITH ELECTRIC AND ELECTRONIC GAMES, AMUSEMENT AND GAMBLING APPARATUS, DEVICES AND MACHINES; VENDING MACHINES FEATURING CD ROM GAMES, CASSETTE GAMES, CARTRIDGE GAMES, VIDEO GAMES; DATA COLLECTION AND DATA PROCESSING SYSTEMS, NAMELY, DIGITAL TAPE RECORDERS, VIDEO GAME RECORDERS, VIDEO MONITORS, CIRCUIT BOARDS, VIDEO GAME CONTROLLERS, NETWORK SERVER UNITS, DISPLAY TERMINAL, DATA ENTRY CONSOLES FOR USE IN GAMES, AMUSEMENT AND GAMBLING AND APPARATUS, DEVICES AND MACHINES; PARTS AND ACCESSORIES FOR ALL THE AFOREMENTIONED GOODS (U.S. CLS. 21, 23, 26, 36 AND 38).

CLASS 9—(Continued).

SN 76-203,821. INSTRUMEDICS, INC., HACKENSACK, NJ. FILED 2-1-2001.

GENTLE JANE

FOR LABORATORY APPARATUS, NAMELY SNAP-FREEZERS USED TO FREEZE TISSUE SPECIMENS USED FOR HISTOLOGY AND PATHOLOGY STUDIES (U.S. CLS. 21, 23, 26, 36 AND 38).

FIRST USE 8-15-1990; IN COMMERCE 8-15-1990.

SN 76-204,367. WORKERS' COMPENSATION INSURANCE RATING BUREAU OF CALIFORNIA, SAN FRANCISCO, CA. FILED 2-2-2001.

WORKERS' COMPENSATION INSURANCE RATING BUREAU
of California

OWNER OF U.S. REG. NOS. 2,337,171 AND 2,458,915. SEC. 2(F) AS TO "WORKERS' COMPENSATION INSURANCE RATING BUREAU OF CALIFORNIA".

FOR ELECTRONIC DATABASE IN THE FIELD OF WORKERS' COMPENSATION INSURANCE RECORDED ON COMPUTER MEDIA (U.S. CLS. 21, 23, 26, 36 AND 38).

FIRST USE 3-23-1995; IN COMMERCE 3-23-1995.

SN 76-204,753. INFINICON SYSTEMS, INC., KING OF PRUSSIA, PA. FILED 2-5-2001.

INFINIRACK

FOR RACKMOUNT SPECIFIC I/O (INPUT/OUTPUT) HARDWARE, NAMELY, I/O BOARDS, MEMORY BOARDS, IMAGE PROCESSORS AND DATA CONVERTERS (U.S. CLS. 21, 23, 26, 36 AND 38).

SN 76-204,755. INFINICON SYSTEMS, INC., KING OF PRUSSIA, PA. FILED 2-5-2001.

INFINISERV

FOR SERVER SPECIFIC I/O (INPUT/OUTPUT) HARDWARE, NAMELY, I/O BOARDS, MEMORY BOARDS, IMAGE PROCESSORS AND DATA CONVERTERS (U.S. CLS. 21, 23, 26, 36 AND 38).

CLASS 9—(Continued).

SN 76-204,756. INFINICON SYSTEMS, INC., KING OF PRUSSIA, PA. FILED 2-5-2001.

INFINISAN

FOR STORAGE AREA SPECIFIC I/O (INPUT/OUTPUT) HARDWARE, NAMELY, I/O BOARDS, MEMORY BOARDS, IMAGE PROCESSORS AND DATA CONVERTERS WHICH INTERFACE WITH A STORAGE AREA NETWORK (U.S. CLS. 21, 23, 26, 36 AND 38).

SN 76-204,757. INFINICON SYSTEMS, INC., KING OF PRUSSIA, PA. FILED 2-5-2001.

INFINIFABRIC

FOR SWITCH I/O (INPUT/OUTPUT) HARDWARE, NAMELY, I/O BOARDS, MEMORY BOARDS, IMAGE PROCESSORS AND DATA CONVERTERS (U.S. CLS. 21, 23, 26, 36 AND 38).

SN 76-204,759. INFINICON SYSTEMS, INC., KING OF PRUSSIA, PA. FILED 2-5-2001.

INFINIFIBRE

FOR FIBRE CHANNEL I/O (INPUT/OUTPUT) HARDWARE, NAMELY, I/O BOARDS, MEMORY BOARDS, IMAGE PROCESSORS AND DATA CONVERTERS (U.S. CLS. 21, 23, 26, 36 AND 38).

SN 76-204,761. INFINICON SYSTEMS, INC., KING OF PRUSSIA, PA. FILED 2-5-2001.

INFINIMAN

FOR COMPUTER MANAGEMENT INTERFACES TO HARDWARE, FIRMWARE OR SOFTWARE (U.S. CLS. 21, 23, 26, 36 AND 38).

SN 76-204,940. ROBROY INDUSTRIES, INC., VERONA, PA. FILED 2-5-2001.

NIGHTHAWK

FOR ENCLOSURES, NAMELY, FIBERGLASS ENCLOSURES FOR ELECTRONIC COMPONENTS, ELECTRICAL CONTROLS AND ELECTRONIC INSTRUMENTS (U.S. CLS. 21, 23, 26, 36 AND 38).

CLASS 9—(Continued).

SN 76-205,180. TARA LABS, INC., ASHLAND, OR. FILED 2-6-2001.

AERO-PE

FOR DIELECTRIC MATERIAL SOLD AS A COMPONENT OF CABLES THAT CONNECT AUDIO AND VIDEO COMPONENTS AND CONNECT THE COMPONENTS WITH LOUD SPEAKERS (U.S. CLS. 21, 23, 26, 36 AND 38).

FIRST USE 9-0-1992; IN COMMERCE 9-0-1992.

SN 76-207,027. WIDEFORCE SYSTEMS, INC., SUPERIOR, CO. FILED 2-8-2001.

WIDEFORCE

FOR COMPUTER SOFTWARE FOR USE IN COLLECTING, PROCESSING, STORING, AND DISPLAYING DATA REGARDING WORKER RECRUITMENT AND ASSESSMENT, TRAINING CONTENT, WORKER EVALUATION, WORKER ACTIVITY, TASK ASSIGNMENTS, WORK PRODUCT, WORKER STATUS, QUALITY RECORDS, CAPACITY MANAGEMENT, AND OTHER RELEVANT FACTORS RELATED TO WORKERS AND TASKS, IN THE FIELD OF WORK FORCE MANAGEMENT AND WORK FLOW MANAGEMENT (U.S. CLS. 21, 23, 26, 36 AND 38).

SN 76-207,576. RLX TECHNOLOGIES, INC., THE WOODLANDS, TX. BY CHANGE OF NAME ROCKETLOGIX, INC., THE WOODLANDS, TX. FILED 2-9-2001.

RLX BLADEMANAGER

NO CLAIM IS MADE TO THE EXCLUSIVE RIGHT TO USE "BLADE MANAGER", APART FROM THE MARK AS SHOWN.

FOR COMPUTER HARDWARE, NAMELY, COMPUTER SERVERS FOR A GLOBAL COMPUTER NETWORK AND CHASSIS, CABLING AND SUPPORTING SYSTEM BOARDS FOR ATTACHING AND INTEGRATING MULTIPLE COMPUTER SERVERS; COMPUTER SOFTWARE FOR MONITORING, MANAGING, MAINTAINING AND PREVENTING AND REACTING TO FAILURE OF COMPUTER SERVERS; COMPUTER SOFTWARE FOR PROVIDING AND MANAGING ACCESS TO COMPUTER SOFTWARE AND DATABASES ON OTHER SERVERS AMONG MULTIPLE COMPUTER SERVERS (U.S. CLS. 21, 23, 26, 36 AND 38).

CLASS 9—(Continued).

SN 76-207,579. RLX TECHNOLOGIES, INC., THE WOODLANDS, TX. BY CHANGE OF NAME ROCKETLOGIX, INC., THE WOODLANDS, TX. FILED 2-9-2001.

RLX BLADEARRAY

NO CLAIM IS MADE TO THE EXCLUSIVE RIGHT TO USE "BLADE ARRAY", APART FROM THE MARK AS SHOWN.

FOR COMPUTER HARDWARE, NAMELY, COMPUTER SERVERS FOR A GLOBAL COMPUTER NETWORK AND CHASSIS, CABLING AND SUPPORTING SYSTEM BOARDS FOR ATTACHING AND INTEGRATING MULTIPLE COMPUTER SERVERS; COMPUTER SOFTWARE FOR MONITORING, MANAGING, MAINTAINING AND PREVENTING AND REACTING TO FAILURE OF COMPUTER SERVERS; COMPUTER SOFTWARE FOR PROVIDING AND MANAGING ACCESS TO COMPUTER SOFTWARE AND DATABASES ON OTHER SERVERS AMONG MULTIPLE COMPUTER SERVERS (U.S. CLS. 21, 23, 26, 36 AND 38).

SN 76-207,621. RLX TECHNOLOGIES, INC., THE WOODLANDS, TX. BY CHANGE OF NAME ROCKETLOGIX, INC., THE WOODLANDS, TX. FILED 2-9-2001.

RLX NASBLADE

NO CLAIM IS MADE TO THE EXCLUSIVE RIGHT TO USE "NAS BLADE", APART FROM THE MARK AS SHOWN.

FOR COMPUTER HARDWARE, NAMELY, COMPUTER SERVERS FOR A GLOBAL COMPUTER NETWORK AND CHASSIS, CABLING AND SUPPORTING SYSTEM BOARDS FOR ATTACHING AND INTEGRATING MULTIPLE COMPUTER SERVERS; COMPUTER SOFTWARE FOR MONITORING, MANAGING, MAINTAINING AND PREVENTING AND REACTING TO FAILURE OF COMPUTER SERVERS; COMPUTER SOFTWARE FOR PROVIDING AND MANAGING ACCESS TO COMPUTER SOFTWARE AND DATABASES ON OTHER SERVERS AMONG MULTIPLE COMPUTER SERVERS (U.S. CLS. 21, 23, 26, 36 AND 38).

SN 76-209,432. PCS REVENUE CONTROL SYSTEMS, INC., ENGLEWOOD CLIFFS, NJ. FILED 2-13-2001.

SC8 BOARD

NO CLAIM IS MADE TO THE EXCLUSIVE RIGHT TO USE "BOARD", APART FROM THE MARK AS SHOWN.

FOR COMPUTER HARDWARE, NAMELY SERIAL COMMUNICATION BOARDS, AND RELATED SOFTWARE, NAMELY, DRIVERS FOR THE SERIAL COMMUNICATION BOARDS (U.S. CLS. 21, 23, 26, 36 AND 38).

FIRST USE 12-15-2000; IN COMMERCE 12-15-2000.

CLASS 9—(Continued).

SN 76-209,441. PGA TOUR, INC., PONTE VEDRA BEACH, FL. FILED 2-13-2001.

SHOTLINK

FOR COMPUTER HARDWARE AND SOFTWARE FOR COLLECTING, DISTRIBUTING, TRANSMITTING, ARCHIVING AND REPORTING IN REAL TIME INFORMATION ABOUT GOLF SHOTS, GOLF COURSE MAPPING AND SCORING GATHERED DURING PROFESSIONAL GOLF TOURNAMENT COMPETITIONS (U.S. CLS. 21, 23, 26, 36 AND 38).

FIRST USE 2-2-2000; IN COMMERCE 2-2-2000.

SN 76-210,401. GEMEMAX CORPORATION, TAIPEI CITY, TAIWAN, CHINA, FILED 2-15-2001.

GEMEMAX

FOR AUTOMATIC COIN COUNTING AND SCREENING MACHINES FOR SEPARATING GOOD COINS FROM COUNTERFEITS, CURRENCY EXCHANGE MACHINES, AUTOMATIC TELLER MACHINES, MONEY COUNTING MACHINES, AUTOMATIC COIN DISPENSING MACHINES, CURRENCY COUNTING MACHINES, CURRENCY RECEIVING MACHINES, BILL ACCEPTORS, CURRENCY VALIDATORS, COIN ACCEPTORS, COIN CHANGERS, PAPER MONEY VALIDATORS, VENDING MACHINES, AUTOMATIC CARD DISPENSERS FOR DEBIT CARDS AND TELEPHONE CARDS, ELECTRONIC TICKET PRINTERS (U.S. CLS. 21, 23, 26, 36 AND 38).

FIRST USE 8-15-1997; IN COMMERCE 8-15-1997.

SN 76-210,935. NATIVE NETWORKS TECHNOLOGIES LTD, PETAH TIKVA, ISRAEL, FILED 2-15-2001.

NATIVEVIEW

FOR COMPUTER HARDWARE AND EMBEDDED SOFTWARE FOR USE IN REGULATING THE FLOW OF DATA IN COMPUTER NETWORKS AND TELECOMMUNICATIONS NETWORKS (U.S. CLS. 21, 23, 26, 36 AND 38).

SN 76-214,120. BIOPTECHS, INC., BUTLER, PA. FILED 2-20-2001.

FCS2

FOR MICROSCOPE ACCESSORIES, NAMELY LIVE CELL OBSERVATION SYSTEMS WHICH ENABLE MICROSCOPIC EXAMINATION OF LIVE CELLS UNDER SIMULATED HOST CONDITIONS, TOGETHER WITH VARIOUS COMPONENTS WHICH CONTROL ENVIRONMENTAL PARAMETERS WITHIN SUCH LIVE CELL OBSERVATION SYSTEMS (U.S. CLS. 21, 23, 26, 36 AND 38).

FIRST USE 6-1-1992; IN COMMERCE 6-1-1992.

CLASS 9—(Continued).

SN 76-214,121. BIOPTECHS, INC., BUTLER, PA. FILED 2-20-2001.

FCS3

FOR MICROSCOPE ACCESSORIES, NAMELY LIVE CELL OBSERVATION SYSTEMS WHICH ENABLE MICROSCOPIC EXAMINATION OF LIVE CELLS UNDER SIMULATED HOST CONDITIONS, TOGETHER WITH VARIOUS COMPONENTS WHICH CONTROL ENVIRONMENTAL PARAMETERS WITHIN SUCH LIVE CELL OBSERVATION SYSTEMS (U.S. CLS. 21, 23, 26, 36 AND 38).

SN 76-217,055. IN TOUCH MINISTRIES, INC., ATLANTA, GA. FILED 2-28-2001.

PRAYER TOUCH

NO CLAIM IS MADE TO THE EXCLUSIVE RIGHT TO USE "PRAYER", APART FROM THE MARK AS SHOWN.

FOR PRE-RECORDED AUDIO CASSETTES, PRE-RECORDED VIDEO CASSETTES, CDS, CD-ROMS, DVD ROMS AND COMPUTER SOFTWARE, ALL FEATURING PRAYER MINISTRY IN THE FIELDS OF SPIRITUALITY, RELIGION, ETHICS, SOCIAL ISSUES AND LIFESTYLE (U.S. CLS. 21, 23, 26, 36 AND 38).

SN 76-217,242. WIRELESS NETWORKS INC., CALGARY, ALBERTA T2A 6K4, CANADA, FILED 2-28-2001.

BLUEFONE

PRIORITY CLAIMED UNDER SEC. 44(D) ON CANADA APPLICATION NO. 1,084,639, FILED 12-7-2000.

FOR WIRELESS DEVICES, SHORT AND LONG RANGE WIRELESS DEVICES, NAMELY, HANDHELD TELEPHONES INCLUDING KEYPADS, LCD DISPLAYS, SPEAKERS, MICROPHONES, HEADSET ADAPTERS AND BATTERIES (U.S. CLS. 21, 23, 26, 36 AND 38).

SN 76-217,410. AUTODESSYS, INC., COLUMBUS, OH. FILED 2-28-2001.

FORMZ

SEC. 2(F).
FOR COMPUTER PROGRAMS FOR COMPUTER AIDED MODELING, DESIGN, AND RENDERING (U.S. CLS. 21, 23, 26, 36 AND 38).

FIRST USE 7-1-1990; IN COMMERCE 7-1-1990.

CLASS 9—(Continued).

SN 76-218,445. STANER ELETRONICA LTDA., SN-KM 68 PRESIDENTE PRUDENTE - SP, BRAZIL, FILED 3-1-2001.



FOR COMMUNICATION EQUIPMENT AND COMPONENTS, NAMELY, TELEPHONES AND CELLULAR PHONES, COMPUTERS, HUBS, SERVERS AND COMMUNICATIONS SOFTWARE FOR CONNECTING COMPUTER NETWORK USERS AND GLOBAL COMPUTER NETWORKS; AUDIO ENCLOSURES; AUDIO MIXERS; AUDIO EQUALIZERS; POWER AMPLIFIERS; SOUND AND DATA PROCESSING EQUIPMENT, NAMELY, COMPUTERS AND DATA PROCESSORS; AND APPARATUS FOR RECORDING, TRANSMISSION OR REPRODUCTION OF SOUND OR IMAGES, NAMELY, PLAYERS AND RECORDERS FOR MAGNETIC TAPES, CDS, CD-ROMS, CD-RS, CD-RWS, DVDS, DVD-RS, DVD-RAMS, FLOPPY DISCS AND HARD DISCS, VIDEO CAMERAS, TELEVISIONS, AUDIO SPEAKERS, VIDEO MONITORS, FILM PROJECTORS AND SLIDE PROJECTORS (U.S. CLS. 21, 23, 26, 36 AND 38).

SN 76-219,126. SOUNDPIX, INC., INCLINE VILLAGE, NV, FILED 3-2-2001.

SOUNDPIX

FOR COMPUTER SOFTWARE FOR USE IN CONVERTING, EMBEDDING OR ATTACHING ELECTRONIC, MAGNETIC OR OPTICAL TEXT, GRAPHIC, VIDEO OR AUDIO CONTENT INTO ANY OTHER ELECTRONIC, MAGNETIC OR OPTICAL TEXT, GRAPHIC, VIDEO OR AUDIO CONTENT (U.S. CLS. 21, 23, 26, 36 AND 38).
FIRST USE 11-13-2000; IN COMMERCE 11-13-2000.

SN 76-220,069. BLACKBOARD INC., WASHINGTON, DC, FILED 3-5-2001.

BLACKBOARD

OWNER OF U.S. REG. NOS. 1,263,461, 2,315,293 AND 2,469,112.

FOR HARDWARE AND COMPUTER SOFTWARE IN THE FIELD OF ELECTRONIC ACCESS FOR CONTROLLING ADMITTANCE TO FACILITIES AND AUTHORIZING ACCESS TO PRODUCTS AND SERVICES; HARDWARE AND COMPUTER SOFTWARE IN THE FIELD OF DEBIT CARD CONTROL SYSTEMS FOR PROCESSING ELECTRONIC TRANSACTIONS, NAMELY DEBIT CARD AUTHORIZATION AND TRANSACTION SETTLEMENT (U.S. CLS. 21, 23, 26, 36 AND 38).

CLASS 9—(Continued).

SN 76-220,662. STRONGHOLD TECHNOLOGIES, INC., BERNARDSVILLE, NJ, FILED 3-5-2001.

DEALERADVANCE

FOR COMPUTER SOFTWARE FOR AUTOMATING AUTOMOBILE DEALERSHIP SERVICES, NAMELY, FOR AUTOMATION OF SALES, INVENTORY CONTROL, ACCOUNTING, PROVIDING INFORMATION VIA THE INTERNET, AND MAINTENANCE AND REPAIR SERVICES (U.S. CLS. 21, 23, 26, 36 AND 38).

SN 76-221,491. GENICOM, LLC, WAYNESBORO, VA, FILED 3-9-2001.

MICROLASER

FOR LASER PRINTERS, LASER PRINTER ACCESSORIES, AND LASER PRINTER CONSUMABLES, NAMELY, TONER PRODUCTS, FUSERS, MAINTENANCE KITS, IMAGING CARTRIDGES, ORGANIC PHOTOCONDUCTORS, AND DRUMS (U.S. CLS. 21, 23, 26, 36 AND 38).

FIRST USE 6-0-1990; IN COMMERCE 6-0-1990.

SN 76-222,211. PONOI CORP., NEW YORK, NY, FILED 3-9-2001.

PONOI

FOR COMPUTER SOFTWARE FOR PROVIDING COMPUTER-BASED SECURITY SERVICES TO MAINTAIN THE PRIVACY OF ELECTRONIC DATA, TO MAINTAIN THE PRIVACY OF COMPUTER AND COMMUNICATIONS NETWORK ACCESS AND USAGE, AND FOR THE PRIVATE TRANSMISSION, STORAGE AND RETRIEVAL OF COMPUTER FILES AND ELECTRONIC DATA (U.S. CLS. 21, 23, 26, 36 AND 38).

FIRST USE 1-11-2000; IN COMMERCE 11-1-2000.

SN 76-222,834. QUALCOMM INCORPORATED, SAN DIEGO, CA, BY ASSIGNMENT WIRELESS KNOWLEDGE, INC., SAN DIEGO, CA, FILED 3-8-2001.

ECHO

FOR COMPUTER SOFTWARE THAT DETECTS REQUESTS FROM A WIDE VARIETY OF WEB BROWSER CLIENTS AND AUTOMATICALLY MODIFIES WEB SITE CONTENT ACCORDINGLY BY TRANSLATING AND CONVERTING THAT CONTENT INTO THE PROPER MARK-UP LANGUAGE TO ALLOW THE CONTENT TO BE VIEWED BY THE REQUESTING DEVICE, AND INSTRUCTIONS AND MARKUP REFERENCE MANUALS PROVIDED THEREWITH (U.S. CLS. 21, 23, 26, 36 AND 38).

FIRST USE 3-2-2001; IN COMMERCE 3-2-2001.

CLASS 9—(Continued).

SN 76-223,537. AGILEVISION, L.L.C., PRINCETON, NJ. FILED 3-13-2001.

AGILEVISION

FOR COMPUTERS, COMPUTER SOFTWARE, AND COMPUTER DISC DRIVES SOLD AS A UNIT FOR USE IN PRODUCTION, DISTRIBUTION, AND TRANSMISSION OF VIDEO AND AUDIO DATA VIA DIGITAL SUBSCRIBER LINE, CABLE, WIRELESS, AND FIBER OPTIC LINES; COMPUTERS, COMPUTER SOFTWARE, AND COMPUTER DISC DRIVES SOLD AS A UNIT FOR SPLICING AND INSERTING BROADBAND CONTENT, FOR DATA MULTIPLEXING, FOR GENERATING BROADBAND CONTENT, AND FOR ENCODING, DECODING, AND STORING BROADBAND CONTENT (U.S. CLS. 21, 23, 26, 36 AND 38).

SN 76-223,620. GUIDECOMM SYSTEMS, INC., CHANTILLY, VA. FILED 3-13-2001.

GUIDECOMM

FOR COMPUTER SOFTWARE FOR NETWORK SYSTEMS INTEGRATION; COMPUTER SOFTWARE FOR USE WITH OPERATIONAL, BUSINESS, AND E-COMMERCE SUPPORT SYSTEMS, NAMELY SOFTWARE FOR SALES FORCE AUTOMATION, ORDER ENTRY AND ORDER MANAGEMENT, BILLING, PROVISIONING, ENGINEERING, WORKFLOW MANAGEMENT, WORKFORCE MANAGEMENT, CUSTOMER RELATIONSHIP MANAGEMENT, FACILITIES MANAGEMENT, FAULT MANAGEMENT, PERFORMANCE MANAGEMENT, ELEMENT MANAGEMENT, TROUBLE MANAGEMENT, AND GEOGRAPHIC INFORMATION SYSTEMS (U.S. CLS. 21, 23, 26, 36 AND 38).

FIRST USE 1-0-1999; IN COMMERCE 1-0-1999.

SN 76-223,801. PORTAL SOFTWARE, INC., CUPERTINO, CA. FILED 3-12-2001.

PORTAL

OWNER OF U.S. REG. NOS. 1,604,063, 2,478,853 AND 2,495,284. SEC. 2(F).

FOR COMPUTER SOFTWARE FOR THE CREATION AND MANAGEMENT OF CUSTOMER ACCOUNTS, FOR THE DEVELOPMENT, PRICING AND PROVISION OF SERVICE OFFERINGS BY WIRELESS, CABLE, DIGITAL SUBSCRIBER LINE, TELECOMMUNICATIONS, APPLICATIONS HOSTING, AND INTERNET SERVICE PROVIDERS, AND FOR ACTIVITY TRACKING, RATING AND BILLING OF CUSTOMERS OF SUCH PROVIDERS, AND INSTRUCTION AND USER MANUALS SOLD IN CONNECTION THEREWITH (U.S. CLS. 21, 23, 26, 36 AND 38).

FIRST USE 2-23-2001; IN COMMERCE 2-23-2001.

CLASS 9—(Continued).

SN 76-224,149. NHK SPRING CO., LTD., KANAGAWA-KEN, JAPAN, FILED 3-13-2001.

SMART NIPPEREC

NO CLAIM IS MADE TO THE EXCLUSIVE RIGHT TO USE "SMART", APART FROM THE MARK AS SHOWN.

FOR PRERECORDED MAGNETIC CARDS AND MAGNETIC TAPES FOR USE IN SECURITY SYSTEMS AND ANTI-COUNTERFEITING SYSTEMS USING MAGNETIC WIRE, ELECTRONIC TAGS FOR GOODS IDENTIFICATION USING MAGNETIC WIRE; SECURITIES IDENTIFICATION MARKERS USING MAGNETIC WIRE; ARTICLE MONITORING LABELS USING MAGNETIC WIRE FOR PREVENTING BURGLARY; MAGNETIC WIRE WHICH SERVICES AS MAGNETO SENSITIVE ELEMENT (U.S. CLS. 21, 23, 26, 36 AND 38).

SN 76-224,527. ORCHID SYSTEMS, INC., WELLESLEY, MA. FILED 3-12-2001.

TELEMODELING

FOR COMPUTER SOFTWARE, FOR USE BY BUSINESSES, USED FOR MODELING AND DISPLAYING BUSINESS PROCEDURES BY MEANS OF A SERIES OF INTERACTIONS WITH INFORMATION AND/OR DATA LOCATED ON WIRELESS GLOBAL COMPUTER NETWORKS OR GLOBAL COMMUNICATION NETWORKS OR COMPUTER APPLICATIONS, FOR THE PURPOSE OF INTEGRATING AND TRANSFORMING SAID INFORMATION AND/OR DATA FOR USE WITH NEW WIRELESS GLOBAL COMMUNICATIONS NETWORKS OR GLOBAL COMMUNICATION NETWORKS OR COMPUTER APPLICATIONS; AND USERS' MANUALS AND DOCUMENTATION ALL SOLD AS A UNIT THEREWITH (U.S. CLS. 21, 23, 26, 36 AND 38).

FIRST USE 11-21-2000; IN COMMERCE 11-21-2000.

SN 76-225,226. TRUESPECTRA, INC., BURLINGAME, CA. FILED 3-15-2001.

IMAGETONE

FOR DOWNLOADABLE COMPUTER SOFTWARE FOR CREATING, MANIPULATING, AND RENDERING GRAPHIC IMAGES ON A COMPUTER FOR USE WITH INTERNAL AND EXTERNAL WEB SITES; DESKTOP PUBLISHING SOFTWARE (U.S. CLS. 21, 23, 26, 36 AND 38).

SN 76-225,420. HELIUS, INC., LINDON, UT. FILED 3-15-2001.

MEDIAWRITE

FOR COMPUTER SOFTWARE FOR MANAGING, DISTRIBUTING AND DELIVERING BROADCASTS OF LIVE CONTENT AND OTHER ELECTRONIC DATA OVER MULTICAST-ENABLE SATELLITE AND LANDLINE ELECTRONIC COMMUNICATIONS NETWORKS (U.S. CLS. 21, 23, 26, 36 AND 38).

CLASS 9—(Continued).

SN 76-225,502. VISTASCAPE TECHNOLOGY, CORP., ATLANTA, GA. FILED 3-16-2001.

ZOVIAN TECHNOLOGY

NO CLAIM IS MADE TO THE EXCLUSIVE RIGHT TO USE "TECHNOLOGY", APART FROM THE MARK AS SHOWN.

FOR ELECTRO OPTICAL SURVEILLANCE AND SECURITY SYSTEMS COMPRISING SENSORS, NAMELY, VIDEO CAMERAS, DIGITAL CAMERAS, INFRARED (IR) DETECTORS, MOTION DETECTORS, RADAR TRANSDUCERS, SONAR TRANSDUCERS, CHEMICAL SENSING DEVICES, BIOLOGICAL SENSING DEVICES, GLOBAL POSITIONING SYSTEM (GPS) TRANSPONDERS, RADIO FREQUENCY (RF) TRANSMITTERS, RADIO FREQUENCY (RF) RECEIVERS, AND COMPUTER HARDWARE AND COMPUTER SOFTWARE FOR DETECTING CHANGES, TRACKING CHANGES, VISUALIZATION, AND DATABASE MANAGEMENT FOR MILITARY OR INDUSTRIAL USES SUCH AS BORDER PATROL, HARBOR PATROL, WIDE AREA SURVEILLANCE, OR SECURITY CRITICAL INSTALLATIONS SUCH AS PALACES, OIL REFINERIES, FACTORIES, MILITARY INSTALLATIONS, PRISONS AND HIGH VALUE ASSETS (U.S. CLS. 21, 23, 26, 36 AND 38).

SN 76-226,244. FINANCIAL MODELING SPECIALISTS, VIENNA, VA. FILED 3-16-2001.

TOTAL SQL ANALYZER

NO CLAIM IS MADE TO THE EXCLUSIVE RIGHT TO USE "SQL ANALYZER", APART FROM THE MARK AS SHOWN.

FOR COMPUTER SOFTWARE FOR DOCUMENTING OF DATABASE SERVER DESIGN, CONFIGURATION, AND SECURITY SETTINGS (U.S. CLS. 21, 23, 26, 36 AND 38).

SN 76-226,758. PROINDUMAR, S.L., 28037 MADRID, SPAIN, FILED 3-16-2001.



NO CLAIM IS MADE TO THE EXCLUSIVE RIGHT TO USE "CASH", APART FROM THE MARK AS SHOWN.

THE MARK FEATURES DANCERS GARBED IN RED AND GREEN. THE BACKGROUND OF THE DANCERS IS VARIOUS SHADES OF BLUE. BLUE FIGURES ON A BLACK BACKGROUND ARE IN THE BACKGROUND OF THE WORDS "CAN CAN CASH".

FOR COIN- OR COUNTER-FED AMUSEMENT MACHINES, NAMELY SLOT MACHINES (U.S. CLS. 21, 23, 26, 36 AND 38).

FIRST USE 10-0-2000; IN COMMERCE 10-0-2000.

CLASS 9—(Continued).

SN 76-227,568. 3T SYSTEMS CORPORATION, ENGLEWOOD, CO. FILED 3-20-2001.

MORTGAGE CADENCE

NO CLAIM IS MADE TO THE EXCLUSIVE RIGHT TO USE "MORTGAGE", APART FROM THE MARK AS SHOWN.

FOR COMPUTER PROGRAMS THAT PROVIDE AN AUTOMATED MORTGAGE LOAN PROCESSING AND LOAN MANAGEMENT SYSTEM FOR MORTGAGE BANKERS, LENDERS AND BROKERS (U.S. CLS. 21, 23, 26, 36 AND 38).

FIRST USE 10-1-1998; IN COMMERCE 10-1-1998.

SN 76-228,905. R.J. O'BRIEN AND ASSOCIATES INC., CHICAGO, IL. FILED 3-22-2001.

MARKET CENTER DIRECT

NO CLAIM IS MADE TO THE EXCLUSIVE RIGHT TO USE "MARKET CENTER", APART FROM THE MARK AS SHOWN.

FOR COMPUTER SOFTWARE THAT ALLOWS USERS TO EXCHANGE TRADED FUTURES CONTRACTS, ENTER TRADE ORDERS, AND ACCESS NEWS, DELAYED QUOTES, CHARTS AND ACCOUNT INFORMATION VIA A GLOBAL COMPUTER NETWORK (U.S. CLS. 21, 23, 26, 36 AND 38).

FIRST USE 9-0-1999; IN COMMERCE 9-0-1999.

SN 76-229,455. BIOCHEM TECHNOLOGY, INC., KING OF PRUSSIA, PA. FILED 3-23-2001.

FOR WATER AND WASTEWATER TREATMENT SYSTEMS AND WATER AND WASTEWATER ANALYSIS AND CONTROL SYSTEMS COMPRISING COMPUTER INTERFACES, COMPUTER OPERATING PROGRAMS AND ELECTRONIC AND OPTICAL INSTRUMENTS, NAMELY, OPTICAL SCANNERS AND ANALYZERS, FOR DETECTING AND ANALYZING WATER AND WASTEWATER PROCESS PARAMETERS IN MUNICIPAL, INDUSTRIAL, AND LABORATORY USES (U.S. CLS. 21, 23, 26, 36 AND 38).

FIRST USE 8-24-2000; IN COMMERCE 8-24-2000.

CLASS 9—(Continued).

SN 76-229,605. NEXFON CORPORATION, FREMONT, CA. FILED 3-26-2001.

NANO-T

FOR FIBER OPTIC COMMUNICATION COMPONENTS, NAMELY, SPECTRUM SPLITTERS AND INTERLEAVERS, OPTICAL MULTIPLEXERS, ADD/DROP MODULES AND DISPERSION COMPENSATION MODULES, ALL FOR USE IN OPTICAL COMMUNICATIONS SYSTEMS (U.S. CLS. 21, 23, 26, 36 AND 38).

SN 76-229,655. UNITED STATES FILTER CORPORATION, PALM DESERT, CA. FILED 3-23-2001.

BIOFEED

FOR ELECTRICAL CONTROLLERS FOR USE IN WATER TREATMENT SYSTEMS (U.S. CLS. 21, 23, 26, 36 AND 38).

SN 76-229,746. DICKIE WALKER MARINE, INC., LA JOLLA, CA. FILED 3-26-2001.



NO CLAIM IS MADE TO THE EXCLUSIVE RIGHT TO USE "BUILT 1951" AND "AUTHENTIC MARINE", APART FROM THE MARK AS SHOWN.

THE STIPPLING IN THE MARK IS FOR SHADING PURPOSES ONLY.

THE NAME "DICKIE WALKER" IS THE NAME OF A BOAT AND NOT THE NAME OF ANY KNOWN OR PARTICULAR LIVING INDIVIDUAL.

FOR SUNGLASSES; READING GLASSES; EYEGGLASS FRAMES AND CASES; BINOCULARS; TELESCOPES; NAVIGATIONAL BUOYS; RADIOS INCORPORATING CLOCKS; NAVIGATIONAL DEVICES, NAMELY GLOBAL POSITIONING SYSTEMS; SMOKE DETECTORS; FIRE ALARMS; LIFE PRESERVERS AND LIFE VESTS; LIFE-SAVING RAFTS; RADAR; RADIO TELEPHONES; RADIOS; DECORATIVE REFRIGERATOR MAGNETS; SAFETY HARNESSES OTHER THAN FOR VEHICLES OR SPORTS PURPOSES; SEXTANTS; ELECTRONIC SIGNALLING DEVICES; SONAR; SURVIVAL SUITS IN THE NATURE OF SURVIVAL GARMENTS PROVIDING FLOTATION AND HYPOTHERMIA PROTECTION; WIND SOCKS FOR INDICATING WIND DIRECTION AND INTENSITY (U.S. CLS. 21, 23, 26, 36 AND 38).

CLASS 9—(Continued).

SN 76-232,048. PRINTRAK INTERNATIONAL, INC., IRVINE, CA. FILED 3-27-2001.

CADTRAK

FOR COMPUTER HARDWARE AND SOFTWARE FOR USE BY PUBLIC SAFETY AGENCIES IN AUTOMATING THE CALL TAKING AND INCIDENT DISPATCHING PROCESS BY MANAGING SERVICE CALLS AND THE PATROL UNITS THAT ARE ASSIGNED TO EACH SERVICE UNIT (U.S. CLS. 21, 23, 26, 36 AND 38).

SN 76-232,639. MIDWAY AMUSEMENT GAMES, LLC, CHICAGO, IL. FILED 3-29-2001.

SONYA BLADE

OWNER OF U.S. REG. NOS. 2,161,648 AND 2,291,614. THE NAME "SONYA BLADE" DOES NOT IDENTIFY A LIVING INDIVIDUAL.

FOR COMPUTER AND VIDEO GAME PROGRAMS IN THE FORM OF CARTRIDGES, DISCS, CD-ROMS, CASSETTES AND TAPES (U.S. CLS. 21, 23, 26, 36 AND 38).

SN 76-232,827. CLARKE AMERICAN CHECKS, INC., SAN ANTONIO, TX. FILED 3-23-2001.

QUIKCOUNT

FOR CALCULATOR SOLD FOR USE WITH RING BINDERS AND APPOINTMENT BOOKS (U.S. CLS. 21, 23, 26, 36 AND 38).

SN 76-233,052. JRA-MASCHINENTEILE UND -GERATE GMBH, D-78564 REICHENBACH, FED REP GERMANY, FILED 3-29-2001.

JRA

OWNER OF FED REP GERMANY REG. NO. 2058111, DATED 2-25-1994, EXPIRES 8-27-2003.

FOR PRESSURE GAUGES (U.S. CLS. 21, 23, 26, 36 AND 38).

SN 76-233,228. ALARIS, INC., FREMONT, CA. FILED 3-30-2001.

MUZIP

FOR PORTABLE LISTENING DEVICES, NAMELY, MP3 PLAYERS; COMPUTER HARDWARE AND SOFTWARE FOR COMPRESSING, DECOMPRESSING, TRANSMITTING AND DOWNLOADING DIGITAL AUDIO FILES (U.S. CLS. 21, 23, 26, 36 AND 38).

CLASS 9—(Continued).

SN 76-233,364. ORIGINAL SOUND RECORD CO., INC., LOS ANGELES, CA. FILED 4-2-2001.

KILLER OLDIES

NO CLAIM IS MADE TO THE EXCLUSIVE RIGHT TO USE "OLDIES", APART FROM THE MARK AS SHOWN.
FOR PRE-RECORDED CASSETTES AND COMPACT DISCS FEATURING DISK JOCKEY COMPILATIONS OF OLDIES MUSIC (U.S. CLS. 21, 23, 26, 36 AND 38).
FIRST USE 1-1-1991; IN COMMERCE 1-1-1993.

SN 76-233,610. TITUS SOFTWARE CORPORATION, CHATSWORTH, CA. FILED 3-29-2001.

KAO THE KANGAROO

FOR COMPUTER GAME PROGRAMS AND DISKS AND VIDEO GAME CARTRIDGES (U.S. CLS. 21, 23, 26, 36 AND 38).
FIRST USE 11-29-2000; IN COMMERCE 11-29-2000.

SN 76-234,561. ROBOTRONIC OY, FIN-33540 TAMPERE, FINLAND, FILED 4-3-2001.



THE LINING SHOWN IN THE DRAWING IS A FEATURE OF THE MARK AND IS NOT INTENDED TO INDICATE COLOR.

FOR CONTROL DEVICES FOR CUTTING MACHINES AND MACHINE TOOLS, NAMELY CONTROL PANELS, DISPLAY SCREENS, WORKSTATIONS, KEYBOARDS, PROGRAMMABLE DATA PROCESSORS, MICROCOMPUTERS, MEASURING INSTRUMENTS, ELECTRONIC SENSORS, DATA TRANSMISSION LINES; COMPUTER NUMERICAL CONTROL DEVICES (CNC DEVICES), NAMELY CONTROL PANELS, DISPLAY SCREENS, WORKSTATIONS, KEYBOARDS, PROGRAMMABLE DATA PROCESSORS, MICROCOMPUTERS, MEASURING INSTRUMENTS, ELECTRONIC SENSORS, DATA TRANSMISSION LINES; AND RECORDED COMPUTERS PROGRAMS FOR CONTROL OF CUTTING MACHINES AND MACHINE TOOLS AND FOR COMPUTER NUMERICAL CONTROL (CNC) (U.S. CLS. 21, 23, 26, 36 AND 38).

SN 76-235,817. GORDY, EMORY JR., BEVERLY HILLS, CA. FILED 4-5-2001.

JAHAZAH RECORDS

NO CLAIM IS MADE TO THE EXCLUSIVE RIGHT TO USE "RECORDS", APART FROM THE MARK AS SHOWN.
FOR MUSICAL SOUND RECORDINGS (U.S. CLS. 21, 23, 26, 36 AND 38).

CLASS 9—(Continued).

SN 76-236,403. ALARIS, INC., FREMONT, CA. FILED 4-6-2001.

JELLYB

FOR PORTABLE LISTENING DEVICES, NAMELY, MP3 PLAYERS; COMPUTER HARDWARE AND SOFTWARE FOR COMPRESSING, DECOMPRESSING, TRANSMITTING AND DOWNLOADING DIGITAL AUDIO FILES (U.S. CLS. 21, 23, 26, 36 AND 38).

SN 76-236,582. WENIG, PAUL, MILL VALLEY, CA. FILED 4-3-2001.

SECRET SESSION RECORDS

NO CLAIM IS MADE TO THE EXCLUSIVE RIGHT TO USE "RECORDS", APART FROM THE MARK AS SHOWN.
FOR MUSICAL SOUND RECORDINGS, NAMELY, COMPACT DISCS AND TAPE CASSETTES (U.S. CLS. 21, 23, 26, 36 AND 38).

SN 76-237,497. APPLIED TECHNOLOGY LTD., ST. HELIER, JERSEY, CHANNEL ISLANDS, FILED 4-2-2001.

MULTIFIL

FOR BATTERY WATERING APPARATUS, NAMELY, A BATTERY WATERING DEVICE HAVING SEVERAL FLOW OUTLETS TO PERMIT THE REPLENISHMENT OF WATER OF A SECONDARY BATTERY CONTAINING SEVERAL CELLS BY MEANS OF A UNITARY DEVICE (U.S. CLS. 21, 23, 26, 36 AND 38).

SN 76-238,792. QUADRAMED CORPORATION, SAN RAFAEL, CA. FILED 4-10-2001.

SMARTSCAN

FOR SOFTWARE FOR HOSPITAL DATABASE ADMINISTRATION FOR DETERMINATION OF DUPLICATE PATIENT RECORDS (U.S. CLS. 21, 23, 26, 36 AND 38).

FIRST USE 2-1-1999; IN COMMERCE 11-1-1999.

SN 76-239,967. STANDARD PERFORMANCE EVALUATION CORPORATION, WARRENTON, VA. FILED 4-9-2001.

SPECMAIL

OWNER OF U.S. REG. NOS. 1,841,733, 1,855,639 AND OTHERS.

FOR COMPUTER DIAGNOSTIC SOFTWARE PROGRAMS FOR PURPOSES OF MEASURING THE PERFORMANCE OF COMPUTERS AND COMPUTER OPERATING SYSTEMS (U.S. CLS. 21, 23, 26, 36 AND 38).
FIRST USE 1-24-2001; IN COMMERCE 1-24-2001.

CLASS 9—(Continued).

SN 76-240,137. ASSEMBLEON N.V., EINDHOVEN, NETHERLANDS, FILED 4-12-2001.

ASSEMBLEON

PRIORITY CLAIMED UNDER SEC. 44(D) ON BENELUX APPLICATION NO. 0975602, FILED 10-17-2000, REG. NO. 0678844, DATED 10-17-2000, EXPIRES 10-17-2010.

FOR COMPUTER SOFTWARE FOR PREPARING AND MONITORING INDUSTRIAL PROCESSES; CONTROLLERS, AND PARTS THEREFORE, FOR ASSEMBLING PRINTED CIRCUIT BOARDS AND FOR MOUNTING COMPONENTS ON PRINTED CIRCUIT BOARDS (U.S. CLS. 21, 23, 26, 36 AND 38).

SN 76-244,225. ENERNET, INC., DBA ENERPATH, REDLANDS, CA. FILED 4-20-2001.

TLT-PROFESSIONAL

FOR COMPUTER SOFTWARE, THAT MAY BE DOWNLOADED FROM THE INTERNET, FOR ANALYZING, TRACKING AND MEASURING ENERGY USAGE IN BUILDINGS FOR USE IN OPTIMIZATION AND MANAGEMENT OF BUILDING ENERGY USAGE (U.S. CLS. 21, 23, 26, 36 AND 38).

FIRST USE 1-10-2001; IN COMMERCE 1-10-2001.

SN 76-244,477. ALIEN TECHNOLOGY CORPORATION, HAYWARD, CA. FILED 4-23-2001.

A-TAG

FOR ELECTRONIC AND FLAT PANEL DISPLAYS FOR USE IN ELECTRONIC SIGNS, CELLULAR TELEPHONES, PERSONAL DIGITAL ASSISTANTS, PAGERS, CALCULATORS, HANDHELD GAMES, WATCHES, SMART CARDS, AUDIO AND VIDEO EQUIPMENT, AND AUTOMOBILES; MICRO-ELECTRO-MECHANICAL MACHINES, NAMELY, MOTORS, ACCELEROMETERS, ACTUATORS, SENSORS, GEARS AND MECHANICAL SWITCHES; PHOTONIC DEVICES, NAMELY, LASERS FOR NON-MEDICAL USE, LIGHT WAVEGUIDES, LIGHT FILTERS AND MODULATORS; ELECTRO-OPTICAL FILMS AND SUBSTRATES FOR USE IN FORMING LIGHT-HANDLING DEVICES; OPTO-ELECTRONIC INTEGRATED CIRCUITS, PHOTONIC INTEGRATED CIRCUITS, MULTIPLEXERS, LIGHT AMPLIFIERS, OPTICAL AMPLIFIERS, FIBER OPTIC AMPLIFIERS, PARAMETRIC OPTICAL AMPLIFIERS, SPATIAL LIGHT MODULATORS, OPTICAL SENSORS AND MICROWAVE SENSORS; PHOTONIC AND OPTICAL COMPONENTS, NAMELY, LENSES, MIRRORS, ENCODERS, SOLAR CELLS, SCALES, OPTICAL LENSES AND MIRRORS FEATURING THIN-FILM CHEMICAL COATINGS; IDENTIFICATION AND INVENTORY DEVICES WHICH USE RADIO FREQUENCY TO COMMUNICATE INFORMATION TO COMPUTERS; ELECTRONIC AND RADIO FREQUENCY TRANSMITTERS, RECEIVERS AND PROCESSORS (U.S. CLS. 21, 23, 26, 36 AND 38).

CLASS 9—(Continued).

SN 76-248,745. SOYO COMPUTER INC., HSINGCHUANG CITY, TAIPEI HSIEN, TAIWAN, FILED 5-1-2001.

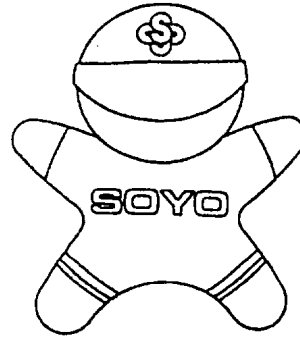

OWNER OF U.S. REG. NO. 2,387,350.
THE MARK CONSISTS IN PART OF ROBOTIZED BABY DESIGN AND THE TERM "SOYO".

FOR COMPUTER COMPONENTS AND PERIPHERALS, NAMELY, COMPUTER MOTHER BOARDS, PERSONAL COMPUTERS, PERSONAL COMPUTER TABLETS, NAMELY, MOBILE COMPUTERS WHICH CAN BE USED WHILE ON THE MOVE, CONSISTING OF CAMERA, SMARTCARD READER, HOT-SWAPPABLE DEVICE BAY, HAND-HELD PERSONAL COMPUTER, PERSONAL DIGITAL ASSISTANT, DATA PROCESSORS, GAME MACHINES FOR USE WITH TELEVISIONS AND COMPUTERS, GAME MACHINES CONTAINING MEMORY DEVICES, NAMELY, COMPUTER DISCS, GAMING EQUIPMENT, NAMELY, SLOT MACHINES WITH OR WITHOUT VIDEO OUTPUT, SET-TOP BOXES, MEMORY CARD READERS AND WRITERS; WIRELESS LOCAL AREA NETWORK, DIGITAL CAMERA, CELLULAR PHONES, SATELLITE RECEIVERS, FINGER PRINT IDENTIFY MODULE, NAMELY, FINGERPRINT VERIFICATION SCANNERS AND SENSORS FOR SECURITY PURPOSES; SATELLITE NAVIGATIONAL SYSTEM, NAMELY A GLOBAL POSITIONING SYSTEM; INTELLIGENT DIGITAL RECORDERS, NAMELY, RECORDERS CONSISTING OF A GUARD SYSTEM TO MONITOR, DETECT AND RECORD EVENTS AND A SEARCH SYSTEM TO READ, INSTANTLY MONITOR, WATCH, SEARCH AND RECORD EVENTS; DIGITAL PICTURE FRAMES FOR VIEWING IMAGES ONE AT A TIME OR AS CONTINUOUS SLIDE SHOW BY INSERTING A MEMORY CARD FROM A DIGITAL CAMERA INTO THE FRAME (U.S. CLS. 21, 23, 26, 36 AND 38).

SN 76-249,530. PIRELLI COMMUNICATIONS CABLES AND SYSTEMS USA, LLC, LEXINGTON, SC. BY CHANGE OF NAME PIRELLI CABLES & SYSTEMS LLC, LEXINGTON, SC. FILED 5-2-2001.

ABILT

FOR OPTICAL FIBER CABLE (U.S. CLS. 21, 23, 26, 36 AND 38).

CLASS 9—(Continued).

SN 76-250,632. KLA-TENCOR CORPORATION, SAN JOSE, CA. FILED 5-3-2001.

PRECICE

FOR COMPUTER HARDWARE, SOFTWARE, AND USER MANUALS SOLD AS A UNIT, ALL FOR INSPECTING AND MEASURING SEMICONDUCTOR DEVICES; AND EQUIPMENT, NAMELY, INSTRUMENTS USED FOR MEASURING PHYSICAL PROPERTIES OF SEMICONDUCTORS (U.S. CLS. 21, 23, 26, 36 AND 38).

SN 76-250,693. IDMICRO, INC., TACOMA, WA. FILED 5-3-2001.

AV

FOR COMPUTER SOFTWARE FOR DEVELOPING AUTOMATED DATA COLLECTION PROGRAMS (U.S. CLS. 21, 23, 26, 36 AND 38).

SN 76-254,735. ALL OPTICAL NETWORKS, INC., SAN DIEGO, CA. FILED 5-3-2001.

METROCARRIER

FOR TELECOMMUNICATIONS EQUIPMENT, NAMELY, OPTICAL TRANSMISSION, RECEIVING AND NETWORKING EQUIPMENT, NAMELY, SWITCHES, TRANSMITTERS, RECEIVERS, MULTIPLEXERS AND DEMULTIPLEXERS, ADD/DROP MULTIPLEXERS, BRAGG GRATINGS USED TO SPLIT AND RECOMBINE LIGHT IN DENSE WAVELENGTH DIVISION MULTIPLEXING SYSTEMS, ROUTERS, CROSS-CONNECTS FOR SELECTIVELY PASSING OPTICAL SIGNALS BETWEEN MULTIPLE OPTICAL FIBERS, AMPLIFIERS, AND REGENERATORS, AND OPTICAL NETWORK AND ELEMENT MANAGEMENT, PLANNING, AND INTERFACE SOFTWARE DESIGNED TO MONITOR AND DIRECT THE TRANSMISSION OF OPTICAL SIGNALS WITHIN A FIBER OPTIC NETWORK, AND COMPUTER SYSTEMS COMPRISED OF MULTIPLE SERVERS AND WORKSTATIONS ATTACHED VIA A COMPUTER NETWORK, AND OPTICAL SYSTEMS AND NETWORKS EMPLOYING SUCH NAMED OPTICAL EQUIPMENT, NAMELY, SWITCHES, TRANSMITTERS, RECEIVERS, MULTIPLEXERS AND DEMULTIPLEXERS, ADD/DROP MULTIPLEXERS, BRAGG GRATINGS, ROUTERS, CROSS-CONNECTS, AMPLIFIERS, AND REGENERATORS (U.S. CLS. 21, 23, 26, 36 AND 38).

SN 76-255,047. ISEG TECHNOLOGIES, INC., MCLEAN, VA. FILED 5-11-2001.

ISEG

FOR COMPUTER SOFTWARE FOR USE IN COLLECTING, MONITORING, ANALYZING AND MANAGING INFORMATION RELATED TO CUSTOMERS, SALES AND MARKETING (U.S. CLS. 21, 23, 26, 36 AND 38).

CLASS 9—(Continued).

SN 76-256,710. NORMAN, RICHARD GRANT, DBA RGN TRACK SUPPLIES, ROCHESTER, MN. FILED 5-14-2001.

LASAM

FOR DEVICE FOR MEASURING DISTANCES USING A LASER IN THE FIELD OF CONSTRUCTION AND IN THE SPORT OF TRACK AND FIELD (U.S. CLS. 21, 23, 26, 36 AND 38).

SN 76-256,846. 2C COMPUTING, INC., HUNTSVILLE, AL. FILED 5-14-2001.

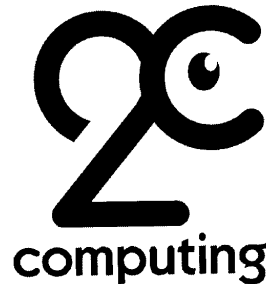

NO CLAIM IS MADE TO THE EXCLUSIVE RIGHT TO USE "COMPUTING", APART FROM THE MARK AS SHOWN.

FOR COMPUTER EQUIPMENT, NAMELY, CABLES, CONNECTORS, AND MICRO PROCESSING EQUIPMENT IN THE NATURE OF BUS EXTENSION UNITS FOR OPERATIVELY CONNECTING MONITORS, KEYBOARDS, AND OTHER DESK-AREA RESIDENT COMPUTER INPUT AND OUTPUT DEVICES TO A COMPUTER UNIT RESIDENT IN A SEPARATE COMPUTER OPERATIONAL AND STORAGE AREA (U.S. CLS. 21, 23, 26, 36 AND 38).

SN 76-260,170. CYBERSPACE TO PARADISE INC., DELAND, FL. FILED 5-22-2001.

NET DETECTIVE

NO CLAIM IS MADE TO THE EXCLUSIVE RIGHT TO USE "NET", APART FROM THE MARK AS SHOWN.

FOR COMPUTER SEARCH ENGINE SOFTWARE; DOWNLOADABLE COMPUTER SEARCH ENGINE SOFTWARE; PRIVATE INVESTIGATIVE COMPUTER SOFTWARE USED TO SEARCH AND RETRIEVE INFORMATIONAL FACTS ABOUT FAMILY MEMBERS, ESTRANGED SPOUSES, FRIENDS, NEIGHBORS, MISSING PERSON, AND OTHER INDIVIDUALS (U.S. CLS. 21, 23, 26, 36 AND 38).

FIRST USE 1-1-1996; IN COMMERCE 1-1-1996.

CLASS 9—(Continued).

SN 76-260,937. INTERACT ACCESSORIES, INC., HUNT VALLEY, MD. FILED 5-23-2001.

CLASS 9—(Continued).

SN 76-261,812. APOGEE SOFTWARE, LTD., GARLAND, TX. FILED 5-22-2001.

BULLET TIME**WANNA BEAT THE GAME?**

FOR VIDEO GAME ACCESSORIES, NAMELY, GAME PADS, CONTROLLERS, JOYSTICKS, STEERING WHEELS AND MEMORY CARDS; ATTACHMENTS TO ELECTRONIC CONTROLLERS AND JOYSTICKS FOR ELECTRONIC VIDEO GAME MACHINES, NAMELY, LIGHTS, CABLES, BATTERIES AND VIBRATION FEEDBACK UNITS AND PARTS THEREFOR; ELECTRONIC MEMORY EXPANSION DEVICES FOR ELECTRONIC GAME EQUIPMENT FOR PLAYING VIDEO GAMES; PLAYER-OPERATED ELECTRONIC CONTROLLER FOR ELECTRONIC VIDEO GAME MACHINES; POWER TRANSFORMERS TO CONNECT AC ELECTRIC CURRENT TO DC ELECTRIC CURRENT FOR ELECTRONIC VIDEO GAME MACHINES; CARRY CASES FOR CARRYING ELECTRONIC GAME EQUIPMENT FOR PLAYING VIDEO GAME GAMES, NAMELY, CARRYING CASES FOR VIDEO GAME CONTROLLERS AND MEMORY CARDS, COMPUTER PROGRAMS USED IN VIDEO GAME ENHANCERS FOR CHANGING GAME PLAY FEATURES ON VIDEO AND COMPUTER GAMES; STORAGE UNITS FOR STORING ELECTRONIC GAME EQUIPMENT, NAMELY, STORAGE CASES FOR VIDEO GAMES, VIDEO GAME CONTROLLERS AND MEMORY CARDS (U.S. CLS. 21, 23, 26, 36 AND 38).
FIRST USE 4-0-1999; IN COMMERCE 11-0-1999.

SN 76-261,373. TETT AG, BERGISCH GLADBACH, FED REP GERMANY, FILED 5-18-2001.

M-EASY

PRIORITY CLAIMED UNDER SEC. 44(D) ON FED REP GERMANY APPLICATION NO. 30085508709, FILED 11-21-2000, REG. NO. 30085508, DATED 2-12-2001, EXPIRES 11-30-2010.

FOR DATA INPUT DEVICES, NAMELY, COMPUTER MICE (U.S. CLS. 21, 23, 26, 36 AND 38).

FOR COMPUTER AND VIDEO PRODUCTS, NAMELY, VIDEO GAME MACHINES FOR USE WITH TELEVISIONS; VIDEO GAME CARTRIDGES; VIDEO GAME TAPE CASSETTES; PRE-RECORDED VIDEO TAPES FEATURING COMPUTER GAMES AND COMPUTER GAME CHARACTERS; MOTION PICTURE FILMS FEATURING VIDEO GAMES AND VIDEO GAME CHARACTERS; TELEVISION GAME PROGRAMS FEATURING COMPUTER GAMES AND COMPUTER GAME CHARACTERS; TELEVISION GAME MONITOR CONSOLES; COMPUTER GAME ANALOG CONTROLLERS IN THE NATURE OF A HAND HELD DEVICE FOR ACCESSING COMPUTER GAMES; COMPUTER GAME JOYSTICKS; MEMORY CARDS, COMPUTER GAME SOFTWARE; COMPUTER GAME DISCS; COMPUTER GAME PROGRAMS; COMPUTER GAME CASSETTES, COMPUTER GAME TAPES, COMPUTER GAME CARTRIDGES, COMPUTER SOFTWARE FEATURING COMPUTER GAMES THAT CAN BE DOWNLOADED THROUGH A GLOBAL COMPUTER NETWORK; MULTIMEDIA SOFTWARE RECORDED ON A CD-ROM FEATURING COMPUTER GAMES; COMPUTERS; COMPUTER HARDWARE AND COMPUTER FIRMWARE FOR USE IN OPERATING COMPUTER GAMES; COMPUTER MOUSE PADS (U.S. CLS. 21, 23, 26, 36 AND 38).

SN 76-262,580. PHYSICIAN MICRO SYSTEMS INC., SEATTLE, WA. FILED 5-25-2001.

PHYSICIAN MICRO SYSTEMS

SEC. 2(F).

FOR COMPUTER PROGRAMS FOR USE BY HEALTH CARE PROVIDERS, NAMELY, PROGRAMS FOR HEALTH CARE DATA MANAGEMENT FUNCTIONS FEATURING ELECTRONIC RECORDS, SCHEDULING, AND BILLING (U.S. CLS. 21, 23, 26, 36 AND 38).

FIRST USE 11-1-1985; IN COMMERCE 11-1-1985.

SN 76-263,039. NEXTSET SOFTWARE, INC., PALO ALTO, CA. AND FNX, LTD., WAYNE, PA. BY ASSIGNMENT NEXTSET SOFTWARE, INC., PALO ALTO, CA. FILED 5-23-2001.

FIRSTORDER

FOR COMPUTER SOFTWARE, NAMELY, SOFTWARE USED FOR AUTOMATING AND SECURING TRADING ACTIVITIES AND BUSINESS EXCHANGE TRANSACTIONS IN THE FIELDS OF SECURITIES TRADING AND ELECTRONIC COMMERCE TRANSACTIONS (U.S. CLS. 21, 23, 26, 36 AND 38).

CLASS 9—(Continued).

SN 76-264,287. STARWOOD HOTELS & RESORTS WORLD-WIDE, INC., WHITE PLAINS, NY. FILED 5-30-2001.

HOSPITALITY AXIS

FOR COMPUTER SOFTWARE FOR ACCOUNTING AND INVENTORY MANAGEMENT OF HOTELS (U.S. CLS. 21, 23, 26, 36 AND 38).

SN 76-264,498. WORLD CYBERLINKS CORP., RONKONKO-MA, NY. FILED 5-30-2001.

CONXEM

FOR COMPUTER HARDWARE, NAMELY, DOCKING STATIONS; COMPUTER COMMUNICATIONS CONNECTIVITY SOFTWARE USED TO ESTABLISH AND MANAGE CONNECTIONS BETWEEN A MOBILE COMPUTING DEVICE AND A CPU OR SERVER (U.S. CLS. 21, 23, 26, 36 AND 38).

SN 76-265,030. SYNAPSE, INC., HUNTSVILLE, AL. FILED 5-31-2001.

SYNAPSE INFRARED

NO CLAIM IS MADE TO THE EXCLUSIVE RIGHT TO USE "INFRARED", APART FROM THE MARK AS SHOWN. FOR COMPUTER HARDWARE AND SOFTWARE FOR USE IN TRANSMITTING AND RECEIVING INFRARED SIGNALS FOR THE CONTROL OF SMART DEVICES, NAMELY APPLIANCES, FLOW CONTROL DEVICES, AUTOMATIC DISPENSING APPARATUS, AND MACHINERY AND OTHER DEVICES USED IN RESIDENTIAL AND INDUSTRIAL ENVIRONMENTS (U.S. CLS. 21, 23, 26, 36 AND 38).

SN 76-265,435. CONCENTRIC SYSTEMS, INC., ALPHARETTA, GA. FILED 6-1-2001.

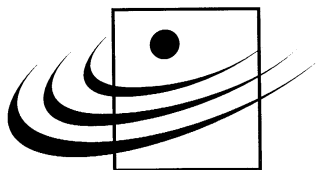
**CSI**

OWNER OF U.S. REG. NO. 2,284,586.
FOR COMPUTERS, NAMELY, COMPUTER HARDWARE, TERMINALS AND MONITORS (U.S. CLS. 21, 23, 26, 36 AND 38).

CLASS 9—(Continued).

SN 76-265,923. FUZZ TECHNOLOGIES, INC., BOZEMAN, MT. FILED 6-4-2001.

FUZZADMIN

FOR COMPUTER APPLICATION ADMINISTRATION SOFTWARE FOR CUSTOMER SUPPORT AGENTS TO RESPOND TO CUSTOMER QUESTIONS (U.S. CLS. 21, 23, 26, 36 AND 38).
FIRST USE 5-29-2001; IN COMMERCE 5-29-2001.

SN 76-266,065. COGNEX CORPORATION, NATICK, MA. FILED 6-4-2001.

**SMART
VIEW**

OWNER OF U.S. REG. NO. 2,456,643.
FOR WEB AND SURFACE INSPECTION SYSTEM, COMPOSED OF CCD CAMERAS, COMPUTER SOFTWARE, IMAGE PROCESSING ELECTRONICS AND COMPUTERS AND CAMERA MOUNTING FRAME AND LIGHTING COMPONENTS, ALL FOR USE BY PRODUCT MANUFACTURERS FOR DETECTING, MEASURING, IDENTIFYING AND REPORTING DEFECTS ON MATERIALS MANUFACTURED OR PROCESSED AS WEBS OR SHEETS, INCLUDING BUT NOT LIMITED TO PLASTICS, NONWOVENS, PAPER AND METALS (U.S. CLS. 21, 23, 26, 36 AND 38).
FIRST USE 6-15-1998; IN COMMERCE 6-15-1998.

SN 76-267,955. SOUL ENTERPRISES, LLC, LOS ANGELES, CA. FILED 6-5-2001.

MINDFIELD

FOR DOWNLOADABLE MUSICAL SOUND AND VIDEO RECORDINGS FEATURING MUSIC, LIVE MUSICAL PERFORMANCES BY VARIOUS ARTISTS, COMEDY, FEATURE MOTION PICTURE FILMS; AND COMPUTER SOFTWARE FOR TRANSMITTING, MODIFYING, AND UTILIZING DATA, GRAPHICS, VIDEO AND SOUND VIA GLOBAL COMPUTER NETWORKS (U.S. CLS. 21, 23, 26, 36 AND 38).

CLASS 9—(Continued).

SN 76-268,142. TEE PEE RECORDS, INC., BROOKLYN, NY. FILED 6-8-2001.

TEE PEE RECORDS

NO CLAIM IS MADE TO THE EXCLUSIVE RIGHT TO USE "RECORDS", APART FROM THE MARK AS SHOWN.

FOR SOUND RECORDINGS FEATURING MUSIC, NAMELY, PRE-RECORDED PHONOGRAPH RECORDS, PRE-RECORDED AUDIO TAPES, ENHANCED COMPACT DISCS, PRE-RECORDED COMPACT DISCS, PRE-RECORDED VIDEOTAPES, PRE-RECORDED VIDEO-CASSETTES, PRE-RECORDED DIGITAL AUDIO TAPES, DVD'S, AND LASER DISCS FEATURING MUSIC (U.S. CLS. 21, 23, 26, 36 AND 38).

FIRST USE 5-1-1994; IN COMMERCE 7-1-1994.

SN 76-269,890. JESTERTEK, INC., WOODBURY, NY. FILED 6-11-2001.

JESTNET

FOR COMPUTER APPLICATION SOFTWARE FEATURING GESTURE RECOGNITION TECHNOLOGY FOR USE IN SENDING VIDEO IMAGES AND CONTROL SIGNALS BETWEEN COMPUTERS TO CREATE SHARED VIDEO ENVIRONMENTS AND TO CONNECT LIVE VIDEO (U.S. CLS. 21, 23, 26, 36 AND 38).

SN 76-269,979. MARQ ANDREW SPECK, CANTON, MI. FILED 6-13-2001.

**REACHING THE
WORLD...ONE SONG AT A
TIME**

FOR MUSICAL SOUND RECORDINGS (U.S. CLS. 21, 23, 26, 36 AND 38).

SN 76-272,133. CYGNAL INTEGRATED PRODUCTS, INC., AUSTIN, TX. FILED 5-21-2001.

Capture → Compute → Communicate

FOR INTEGRATED CIRCUITS (U.S. CLS. 21, 23, 26, 36 AND 38).

CLASS 9—(Continued).

SN 76-272,428. AXIOM SYSTEMS LIMITED, READING BERKSHIRE RG6 IAZ, ENGLAND, FILED 6-15-2001.

O2S

FOR COMPUTER SOFTWARE FOR OPERATING SYSTEMS SUPPORT; SOFTWARE FOR EXECUTING, TRACKING AND AUTOMATING ORDERS; SOFTWARE FOR MANAGING INVENTORIES (U.S. CLS. 21, 23, 26, 36 AND 38).

SN 76-272,488. GOETECH LLC, HYGIENE, CO. FILED 6-15-2001.

MED KEEPER

NO CLAIM IS MADE TO THE EXCLUSIVE RIGHT TO USE "MED", APART FROM THE MARK AS SHOWN.

FOR SYSTEM COMPRISING COMPUTER HARDWARE, SOFTWARE, AND A HAND HELD ELECTRONIC UNIT USED FOR KEEPING TRACK OF PATIENT MEDICATION SCHEDULE, MEDICATION CONSUMPTION, MEDICATION CONTRAINDICATIONS, AND/OR MEDICAL HISTORY DATA (U.S. CLS. 21, 23, 26, 36 AND 38).

SN 76-272,952. IMAGING RESEARCH INC., ST. CATHARINES, ONTARIO, CANADA, FILED 6-18-2001.



OWNER OF U.S. REG. NO. 2,397,068.
FOR COMPUTER SOFTWARE FOR THE ANALYSIS OF DATA FROM SPECIMENS ARRANGED AS ARRAYS IN THE FIELD OF GENOMICS; COMPUTER SOFTWARE FOR THE ANALYSIS OF DATA FROM BIO-CHEMICAL AND CHEMICAL ARRAYS (U.S. CLS. 21, 23, 26, 36 AND 38).

FIRST USE 4-17-2001; IN COMMERCE 4-17-2001.

SN 76-273,260. EPOCRATES, INC., SAN CARLOS, CA. FILED 6-18-2001.

EPOCRATES RX

NO CLAIM IS MADE TO THE EXCLUSIVE RIGHT TO USE "RX", APART FROM THE MARK AS SHOWN.

FOR COMPUTER SOFTWARE FOR USE BY HEALTH CARE PROFESSIONALS TO PROVIDE INFORMATION ABOUT DRUGS AND THE MEDICAL FIELD (U.S. CLS. 21, 23, 26, 36 AND 38).

CLASS 9—(Continued).

SN 76-273,872. EPOCRATES, INC., SAN CARLOS, CA. FILED 6-20-2001.

EPOCRATES ID

NO CLAIM IS MADE TO THE EXCLUSIVE RIGHT TO USE "ID", APART FROM THE MARK AS SHOWN.

FOR COMPUTER SOFTWARE FOR USE BY HEALTH CARE PROFESSIONALS FOR THE DIAGNOSIS OF AND TREATMENT RECOMMENDATIONS FOR INFECTIOUS DISEASES (U.S. CLS. 21, 23, 26, 36 AND 38).

SN 76-274,459. STARWOOD HOTELS & RESORTS WORLDWIDE, INC., WHITE PLAINS, NY. FILED 6-20-2001.

HOSPITALITY
AXIS

FOR COMPUTER SOFTWARE FOR ACCOUNTING AND INVENTORY MANAGEMENT OF HOTELS (U.S. CLS. 21, 23, 26, 36 AND 38).

SN 76-277,015. CELION NETWORKS, INC., RICHARDSON, TX. FILED 6-27-2001.

XLH

FOR COMPUTER OPERATING SOFTWARE FOR OPERATION OF FIBER OPTIC TELECOMMUNICATIONS EQUIPMENT; TELECOMMUNICATIONS GATEWAY EQUIPMENT NAMELY, OPTO-ELECTRONIC ROUTERS, OPTO-ELECTRONIC SWITCHES AND OPTO-ELECTRONIC TRANSPORT SYSTEMS, COMPRISING, OPTO-ELECTRONIC FIBER OPTIC TRANSPORT TERMINALS, OPTO-ELECTRONIC SIGNAL REGENERATORS, AND OPTO-ELECTRONIC IN-LINE AMPLIFIERS, FOR TRANSMITTING DATA OVER FIBER OPTIC CABLE NETWORKS (U.S. CLS. 21, 23, 26, 36 AND 38).

SN 76-277,672. IGT, RENO, NV. FILED 6-27-2001.

ANT FARM

FOR GAMING MACHINES; NAMELY, SLOT MACHINES WITH OR WITHOUT A VIDEO OUTPUT (U.S. CLS. 21, 23, 26, 36 AND 38).

CLASS 9—(Continued).

SN 76-278,756. CAPCOM CO., LTD., CHUO-KU. OSAKA, JAPAN, FILED 6-29-2001.

RESIDENT EVIL SURVIVOR

OWNER OF U.S. REG. NOS. 2,105,804, 2,322,359 AND OTHERS.

FOR COMPUTER GAME SOFTWARE; VIDEO GAME CARTRIDGES (U.S. CLS. 21, 23, 26, 36 AND 38).
FIRST USE 8-0-2000; IN COMMERCE 8-0-2000.

SN 76-279,446. FIRE PROGRAM SOLUTIONS, LLC, ESTACADA, OR. AND CALVIN, MICHAEL, DBA ACACIA SERVICES, HOUT BAY, SOUTH AFRICA, FILED 7-2-2001.

FMA

FOR COMPUTER SOFTWARE USED IN FOREST FIRE MANAGEMENT, NAMELY, A SUITE OF COMPUTER PROGRAMS WHICH ASSIST WILDLAND FIRE MANAGEMENT PERSONNEL IN MAKING FIRE MANAGEMENT ASSESSMENTS BY UTILIZING VARIOUS METHODS OF IDENTIFYING AND CALCULATING WOODY FUEL LOADINGS (U.S. CLS. 21, 23, 26, 36 AND 38).

FIRST USE 11-11-1999; IN COMMERCE 11-11-1999.

SN 76-283,489. DALEEN TECHNOLOGIES, INC., BOCA RATON, FL. FILED 7-10-2001.

DALEEN

FOR COMPUTER SOFTWARE, NAMELY, SOFTWARE FOR USE IN CUSTOMER CARE SERVICES AND BILLING SYSTEMS (U.S. CLS. 21, 23, 26, 36 AND 38).
FIRST USE 0-0-1997; IN COMMERCE 0-0-1997.

SN 76-283,490. DALEEN TECHNOLOGIES, INC., BOCA RATON, FL. FILED 7-10-2001.

**DALEEN**

FOR COMPUTER SOFTWARE, NAMELY, SOFTWARE FOR USE IN CUSTOMER CARE SERVICES AND BILLING SYSTEMS (U.S. CLS. 21, 23, 26, 36 AND 38).
FIRST USE 2-0-2001; IN COMMERCE 2-0-2001.

CLASS 9—(Continued).

SN 76-283,578. HUNTER, FRANCINE, DBA SURVIVOR-SOFT, AUSTIN, TX. FILED 7-11-2001.

BIOBOTS

FOR COMPUTER GAME SOFTWARE ON COMPACT DISK, DVD AND DOWNLOADED FROM THE INTERNET (U.S. CLS. 21, 23, 26, 36 AND 38).

SN 76-285,296. FARQUHAR, JOSEPH A., SHREVEPORT, LA. FILED 7-16-2001.

DEATH REPELLENT

NO CLAIM IS MADE TO THE EXCLUSIVE RIGHT TO USE "REPELLENT", APART FROM THE MARK AS SHOWN.

FOR WILDERNESS SURVIVAL KIT, COMPRISING A WATER FILTER, A SIGNAL MIRROR, A SPACE BLANKET, FIRE STARTER, A KNIFE, A WIRE SAW, A CUP, A FOIL WATER FUNNEL, A COMPASS, INSECT REPELLENT AND QUICK-ENERGY FOOD ALL SOLD AS A UNIT (U.S. CLS. 21, 23, 26, 36 AND 38).

SN 76-286,787. DELTANET, INC., SAN FRANCISCO, CA. FILED 7-17-2001.

OPTARE

FOR COMPUTER PROGRAMS AND USER MANUALS SOLD AS A UNIT FOR USE IN DENTAL CLAIMS ADMINISTRATION (U.S. CLS. 21, 23, 26, 36 AND 38). FIRST USE 4-9-1992; IN COMMERCE 4-9-1992.

SN 76-288,797. E-SPAN, INC., RICHARDSON, TX. FILED 7-24-2001.

E-SPAN OFFICE

NO CLAIM IS MADE TO THE EXCLUSIVE RIGHT TO USE "OFFICE", APART FROM THE MARK AS SHOWN.

FOR BUSINESS MANAGEMENT CONSULTING SERVICES AND REFERRALS IN THE FIELD OF BUSINESS CONSULTANTS AND BUSINESS COMPUTER SOFTWARE PROVIDERS FOR SMALL AND MEDIUM SIZE BUSINESS (U.S. CLS. 21, 23, 26, 36 AND 38).

SN 76-288,871. GUARALDI, DAVID, SAN RAFAEL, CA. AND GUARALDI, DIA, SAN RAFAEL, CA. FILED 7-24-2001.

VINCE GUARALDI

THE NAME "VINCE GUARALDI" IDENTIFIES A LIVING INDIVIDUAL WHOSE CONSENT IS OF RECORD.

FOR MUSICAL SOUND RECORDINGS (U.S. CLS. 21, 23, 26, 36 AND 38).

FIRST USE 1-1-1955; IN COMMERCE 1-1-1955.

CLASS 9—(Continued).

SN 76-289,460. POINTDX, INC., WINSTON-SALEM, NC. FILED 7-23-2001.

POINTDX

FOR COMPUTER SOFTWARE, NAMELY SOFTWARE FOR AUTOMATING THE GENERATION AND DISTRIBUTION OF MULTIMEDIA RADIOLOGY REPORTS AND IMAGES FOR USE IN THE FIELDS OF MEDICAL IMAGING AND RADIOLOGY, AND INSTRUCTIONAL MANUALS SOLD AS A UNIT THEREWITH (U.S. CLS. 21, 23, 26, 36 AND 38).

SN 76-289,824. SAMSUNG ELECTRONICS CO., LTD., SUWON-CITY, KYUNGKI-DO, REPUBLIC OF KOREA, FILED 7-23-2001.

VOICERANGER

FOR CABLE MODEMS, CELLULAR PHONES, COMPACT DISC PLAYERS, COMPUTERS, PDA (PERSONAL DIGITAL ASSISTANTS), MONITORS FOR COMPUTER, SEMICONDUCTORS, CAMCORDERS (U.S. CLS. 21, 23, 26, 36 AND 38).

SN 76-290,242. TEACHING IS EASY, LLC, LAS VEGAS, NV. FILED 7-25-2001.



THE MARK CONSISTS OF THE WORDING "TEACHING IS EASY.COM" IN STYLIZED FORM AND THE STYLIZED REPRESENTATION OF AN APPLE.

FOR EDUCATIONAL SOFTWARE AND COMPUTER PROGRAMS FOR CREATING EDUCATIONAL GAMES, ACTIVITIES, AND MATERIALS (U.S. CLS. 21, 23, 26, 36 AND 38).

FIRST USE 2-16-2001; IN COMMERCE 3-7-2001.

SN 76-293,040. ALCATEL, PARIS, FRANCE, FILED 7-31-2001.

ASAM

FOR TELECOMMUNICATIONS EQUIPMENT, NAMELY, DIGITAL SUBSCRIBER LINE ACCESS NODES, DIGITAL SUBSCRIBER LINE ACCESS MULTIPLEXERS, AND LINE CARDS FOR TELECOMMUNICATIONS NETWORKS (U.S. CLS. 21, 23, 26, 36 AND 38).

FIRST USE 6-0-1996; IN COMMERCE 6-0-1996.

CLASS 9—(Continued).

SN 76-294,326. CLAIRVOYANTE LABORATORIES, INC., SEBASTOPOL, CA. FILED 8-1-2001.

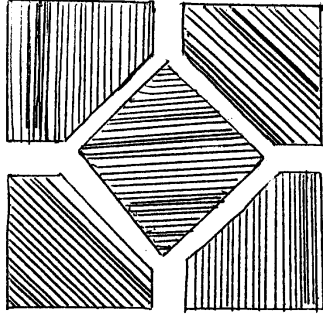

THE DRAWING IS LINED FOR THE COLOR(S) RED, GREEN AND BLUE.

FOR LCD SCREENS, SEMICONDUCTOR CONTROL CHIP FOR CONTROLLING LCD SCREENS, SOFTWARE FOR ENABLING LCD SCREENS DISPLAY, SOFTWARE ENABLING PERSONS TO CREATE IMAGES FOR DISPLAY ON LCD SCREEN, DATA COMPRESSION SOFTWARE, AND HARDWARE AND SOFTWARE ELECTRONIC IMAGING, NAMELY GENERATING, STORING, TRANSMITTING, OR MANIPULATION OF GRAPHIC IMAGES, BOTH NATURAL, NAMELY PHOTOGRAPHIC STILLS AND MOTION PICTURES, AND COMPUTER GENERATED, NAMELY TEXT, ICONS, ANIMATION, AND THE LIKE, FOR COMPUTER DISPLAY SCREENS, PROJECTORS, TELEVISIONS, CAMERAS, CELL PHONES, AND OTHER PORTABLE ELECTRONIC EQUIPMENT (U.S. CLS. 21, 23, 26, 36 AND 38).

SN 76-295,062. CORRIGENT SYSTEMS, INC., ROSEVILLE, CA. FILED 8-6-2001.

CM-VIEW

FOR COMPUTER SOFTWARE FOR USE BY TELECOMMUNICATIONS CARRIERS THAT FORMATS AND ORGANIZES DATA ELEMENTS FOR TRANSMISSION OVER FIBER OPTIC AND ETHERNET LINES (U.S. CLS. 21, 23, 26, 36 AND 38).

SN 76-296,070. RADIO IP SOFTWARE INC., MONTREAL, QUEBEC, CANADA, FILED 8-6-2001.

RADIOROAM

FOR SOFTWARE FOR MANAGING, ANALYZING, AND TRANSMITTING WIRELESS COMMUNICATIONS (U.S. CLS. 21, 23, 26, 36 AND 38).

CLASS 9—(Continued).

SN 76-296,341. BROOKTROUT, INC., NEEDHAM, MA. FILED 8-7-2001.

REALBLOCS

FOR MODULAR COMPUTER HARDWARE SYSTEMS COMPRISED OF COMPUTER HARDWARE AND SOFTWARE FOR BUILDING COMPUTER TELEPHONY APPLICATIONS (U.S. CLS. 21, 23, 26, 36 AND 38).

SN 76-296,393. PRGRS, INC., WILMINGTON, DE. FILED 8-8-2001.

INDEX

FOR COMPUTER SOFTWARE FOR USE IN DOCUMENT MANAGEMENT AND IMAGING (U.S. CLS. 21, 23, 26, 36 AND 38).

SN 76-300,264. MIRADOR SYSTEMS INC., DURHAM, NC. FILED 8-16-2001.

**MIRADOR CONCEPT
MANAGER**

NO CLAIM IS MADE TO THE EXCLUSIVE RIGHT TO USE "CONCEPT MANAGER", APART FROM THE MARK AS SHOWN.

FOR COMPUTER SOFTWARE FOR EXTRACTING CONCEPTS FROM DOCUMENTS, NAMELY PROGRAMS FOR SEARCHING KEY TERMS OF DOCUMENTS AND FOR SUMMARIZING AND ORGANIZING THE CONTENT OF SUCH DOCUMENTS (U.S. CLS. 21, 23, 26, 36 AND 38).

SN 76-301,394. DANA INNOVATIONS, SAN CLEMENTE, CA. FILED 8-16-2001.

H I F I W O R K S

NO CLAIM IS MADE TO THE EXCLUSIVE RIGHT TO USE "HIFI", APART FROM THE MARK AS SHOWN.

FOR WALL AUDIO SPEAKERS AND ELECTRICAL CONTROLLERS FOR USE THEREWITH (U.S. CLS. 21, 23, 26, 36 AND 38).

FIRST USE 5-1-2000; IN COMMERCE 5-1-2000.

CLASS 9—(Continued).

SN 76-303,605. GEOMETRIX, INC., SAN JOSE, CA. FILED 8-23-2001.

FACEVISION

FOR HIGH-SPEED SYSTEM COMPRISED OF DIGITAL CAMERAS AND SOFTWARE USED TO CREATE THREE-DIMENSIONAL MEDIA CONTENT FROM TWO-DIMENSIONAL IMAGES (U.S. CLS. 21, 23, 26, 36 AND 38).

FIRST USE 8-3-2001; IN COMMERCE 8-3-2001.

SN 76-305,581. PRODISC TECHNOLOGY INC., SHINCHUAN TAIPEI COUNTY, TAIWAN, FILED 8-28-2001.

DUPX

FOR BLANK OPTICAL STORAGE MEDIA, NAMELY BLANK COMPACT DISCS; CD-ROM DRIVES; COMPUTER DVD DRIVES; COMPUTER RAM DRIVES; MPEG PLAYERS; DVD PLAYERS; VIDEO DISC RECORDERS; COMPACT DISC RECORDABLE AND REWRITABLE UNITS THAT RECORD AND REWRITE COMPACT DISCS; DVD RECORDABLE AND REWRITABLE UNITS THAT RECORD AND REWRITE VIDEO DISCS (U.S. CLS. 21, 23, 26, 36 AND 38).

SN 76-307,515. CANBERRA INDUSTRIES, INC., MERIDEN, CT. FILED 9-4-2001.

PIPS

SEC. 2(F).
FOR SCIENTIFIC APPARATUS; NAMELY, RADIATION DETECTORS (U.S. CLS. 21, 23, 26, 36 AND 38).
FIRST USE 0-0-1985; IN COMMERCE 0-0-1985.

SN 76-307,618. INCELLICO, INC., DURHAM, NC. FILED 8-31-2001.

CODED ELECTRONIC LIFE LIBRARY

NO CLAIM IS MADE TO THE EXCLUSIVE RIGHT TO USE "ELECTRONIC" OR "LIBRARY", APART FROM THE MARK AS SHOWN.

FOR COMPUTER HARDWARE AND SOFTWARE FOR USE IN GENOMIC AND BIOINFORMATIC ANALYSIS (U.S. CLS. 21, 23, 26, 36 AND 38).

CLASS 9—(Continued).

SN 76-308,617. TRUMP, IVANA, NEW YORK, NY. FILED 9-6-2001.

IVANA

FOR EYEGLASSES AND SUNGLASSES, EYEGLASS AND SUNGLASS FRAMES, EYEGLASS AND SUNGLASS CHAINS, EYEGLASS AND SUNGLASS CORDS, EYEGLASS AND SUNGLASS CASES (U.S. CLS. 21, 23, 26, 36 AND 38).

FIRST USE 1-10-1999; IN COMMERCE 1-10-1999.

SN 76-308,685. SEATTLE BIKE SUPPLY, INC., KENT, WA. FILED 9-5-2001.

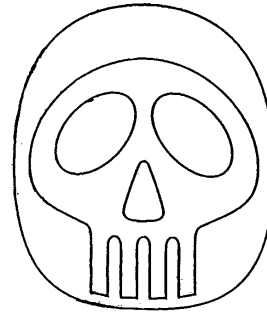

FOR SPORTS HELMETS (U.S. CLS. 21, 23, 26, 36 AND 38).

FIRST USE 4-9-1998; IN COMMERCE 4-9-1998.

SN 76-309,552. LEWIS, TOMMY J., OKLAHOMA CITY, OK. FILED 6-30-2000.

THE EYE BEYOND SECURITY SYSTEM

NO CLAIM IS MADE TO THE EXCLUSIVE RIGHT TO USE "SECURITY SYSTEM", APART FROM THE MARK AS SHOWN.

FOR WIRELESS RADAR OPERATED SECURITY SYSTEM COMPRISED OF AN ALARM, REMOTE CONTROL SENSORS, AND AN ELECTRONIC CONTROL MODULE (U.S. CLS. 21, 23, 26, 36 AND 38).

SN 76-310,600. STANDARD PERFORMANCE EVALUATION CORPORATION, WARRENTON, VA. FILED 9-6-2001.

SPEC OMP

OWNER OF U.S. REG. NOS. 1,841,733, 3,309,070 AND OTHERS.

FOR COMPUTER PROGRAMS FOR MEASURING THE PERFORMANCE OF COMPUTERS AND COMPUTER OPERATING SYSTEMS (U.S. CLS. 21, 23, 26, 36 AND 38).

FIRST USE 6-24-2001; IN COMMERCE 6-24-2001.

CLASS 9—(Continued).

SN 76-311,292. DYNAMOTIVE LLC, MANITOU SPRINGS, CO. FILED 9-7-2001.

DYNAMOTIVE

FOR ELECTRICAL AND SCIENTIFIC APPARATUS, NAMELY DYNAMOMETERS AND COOLING SYSTEMS FOR DYNAMOMETERS (U.S. CLS. 21, 23, 26, 36 AND 38). FIRST USE 6-26-2000; IN COMMERCE 7-7-2000.

SN 76-311,817. STATUS CRAVAT, INC., PENNINGTON, NJ. FILED 9-17-2001.

STATUS

FOR SUNGLASSES (U.S. CLS. 21, 23, 26, 36 AND 38).

SN 76-311,924. GEOBOT, INC., MEMPHIS, TN. FILED 9-13-2001.



THE MARK CONSISTS IN PART OF THE STYLIZED LETTER "G".

FOR DYNAMICALLY CONFIGURABLE MESSAGING COMPUTER SOFTWARE, FOR GENERAL USE, THAT PROVIDES THE CAPABILITY FOR INTEGRATING, DEVELOPING, AND/OR EXTENDING THE FUNCTIONALITY OF MULTIPLE DISPARATE SOFTWARE SYSTEMS, APPLICATIONS AND DEVICES (U.S. CLS. 21, 23, 26, 36 AND 38).

SN 76-312,135. EBENX, INC., MINNEAPOLIS, MN. FILED 9-12-2001.

BENU

FOR COMPUTER SOFTWARE IN THE FIELD OF PROCURING AND ADMINISTERING EMPLOYEE BENEFITS FOR ENTRY, UPDATING, TRANSMISSION AND STORAGE OF DATA TO SUPPORT COMMUNICATIONS, TRANSACTIONS AND INFORMATION MANAGEMENT BETWEEN EMPLOYERS, BENEFIT ADVISORS, HEALTH PLANS AND OTHER BENEFIT SERVICES AND PRODUCT SUPPLIERS (U.S. CLS. 21, 23, 26, 36 AND 38).

CLASS 9—(Continued).

SN 76-313,024. CHARLES BESELER COMPANY, LINDEN, NJ. FILED 9-17-2001.

PROLINE

FOR BAGS FOR CARRYING CAMERAS AND CAMERA EQUIPMENT (U.S. CLS. 21, 23, 26, 36 AND 38).

SN 76-313,564. SALTON, INC., LAKE FOREST, IL. FILED 9-18-2001.

CARE 4 HAIR

FOR HAIR EQUIPMENT, NAMELY, ELECTRIC HAIR CURLING IRONS; ELECTRIC HAIR CRIMPING IRONS; ELECTRIC HAIR WAVING IRONS; ELECTRIC FLAT IRONS; ELECTRIC HAIR BLOW-CURLERS; ELECTRIC HAIR STYLING BRUSHES; ELECTRIC APPLIANCES, NAMELY, HEATING RODS FOR HAIR CURLERS AND HEAT-RETAINING ROLLERS FOR USE THEREWITH; STRUCTURAL PARTS AND REPLACEMENT PARTS THEREFOR FOR ALL THE AFOREMENTIONED GOODS (U.S. CLS. 21, 23, 26, 36 AND 38).

SN 76-313,567. SALTON, INC., LAKE FOREST, IL. FILED 9-18-2001.

CARE FOR HAIR

FOR HAIR EQUIPMENT, NAMELY, ELECTRIC HAIR CURLING IRONS; ELECTRIC HAIR CRIMPING IRONS; ELECTRIC HAIR WAVING IRONS; ELECTRIC FLAT IRONS; ELECTRIC HAIR BLOW-CURLERS; ELECTRIC HAIR STYLING BRUSHES; ELECTRIC APPLIANCES, NAMELY, HEATING RODS FOR HAIR CURLERS AND HEAT-RETAINING ROLLERS FOR USE THEREWITH; STRUCTURAL PARTS AND REPLACEMENT PARTS THEREFOR FOR ALL THE AFOREMENTIONED GOODS (U.S. CLS. 21, 23, 26, 36 AND 38).

SN 76-314,058. TELCONTAR, SAN JOSE, CA. FILED 9-17-2001.

TELCONTAR

FOR NAVIGATIONAL SOFTWARE THAT CONVERTS MAP DATA TO PROVIDE MAPS AND ROUTES TO A CONSUMER (U.S. CLS. 21, 23, 26, 36 AND 38).

CLASS 9—(Continued).

SN 76-314,848. SEIKO INSTRUMENTS U.S.A., INC., TORRANCE, CA. FILED 9-19-2001.

WRITE LINK

NO CLAIM IS MADE TO THE EXCLUSIVE RIGHT TO USE "WRITE", APART FROM THE MARK AS SHOWN.

FOR ELECTRONIC DEVICE CONSISTING OF AN ELECTRONIC PEN AND A RECEIVING UNIT THAT CAPTURES HANDWRITTEN TEXT AND DRAWINGS MADE WITH THE PEN VIA AN INFRARED SIGNAL, DIGITIZES THE CAPTURED DATA AND STORES IT IN A PERSONAL COMPUTER OR NOTEBOOK OR HANDHELD PERSONAL DIGITAL ASSISTANT (U.S. CLS. 21, 23, 26, 36 AND 38).

SN 76-315,854. CORAID, INC., ATHENS, GA. FILED 9-21-2001.

ETHERDRIVE

FOR COMPUTER HARDWARE; COMPUTER NETWORK HARDWARE, NAMELY INTERFACES, HUBS, SWITCHES AND ROUTERS; COMPUTER DATA STORAGE DEVICES, NAMELY MAGNETIC AND OPTICAL DISC DRIVES AND RANDOM ACCESS MEMORY CHIPS; SOFTWARE FOR CONTROLLING, MONITORING AND ACCESSING LOCAL AND REMOTE DATA STORAGE DEVICES IN THE FIELD OF DATA STORAGE MANAGEMENT, AND MANUALS SOLD THEREWITH; SOFTWARE FOR CONTROLLING, MONITORING AND ROUTING OF DATA WITHIN A LOCAL AREA NETWORK AND FOR RECEIVING, DIRECTING AND MONITORING OF DATA RECEIVED FROM OUTSIDE THE NETWORK, ALL IN THE FIELD OF NETWORK MANAGEMENT, AND MANUALS SOLD THEREWITH; AND COMPUTER SEARCH ENGINE SOFTWARE (U.S. CLS. 21, 23, 26, 36 AND 38).

SN 76-317,980. QUICK GEAR, LLC, TIJERAS, NM. FILED 9-28-2001.

QUICK-GEAR

FOR PROTECTIVE HOODS AND GLOVES FOR RAPID PROTECTION AGAINST CHEMICAL, BIOLOGICAL, AND NUCLEAR WARFARE SUBSTANCES; PROTECTIVE HOODS AND GLOVES FOR RAPID PROTECTION AGAINST FIRE, SMOKE, AND GASES; PROTECTIVE PRACTICE HOODS FOR TRAINING IN HOW TO USE THE PROTECTIVE HOODS; CARRYING CASES FOR ALL OF THE AFORESAID PROTECTIVE HOODS AND PROTECTIVE GLOVES; PRERECORDED VIDEO TAPES FEATURING TRAINING IN HOW TO USE THE PROTECTIVE HOODS AND PROTECTIVE GLOVES (U.S. CLS. 21, 23, 26, 36 AND 38).

FIRST USE 3-1-2001; IN COMMERCE 6-4-2001.

CLASS 9—(Continued).

SN 76-318,733. SPIRENT SYSTEMS WICHITA, INC., WICHITA, KS. FILED 9-28-2001.

AVVANCE

FOR ELECTRONIC, AIRCRAFT COCKPIT ACTIVE MATRIX LIQUID CRYSTAL DISPLAY FOR PRESENTATION OF AIRCRAFT ENGINE INFORMATION (U.S. CLS. 21, 23, 26, 36 AND 38).

SN 76-318,984. TIERNEY RIDES, LLC, HOFFMAN ESTATES, IL. FILED 9-28-2001.

RIDE ME. RIDE ME, NOW.

FOR VIDEOS IN CASSETTE, CD AND DVD FORMAT IN THE AREA OF IN-LINE BOARDING AND PRE-RECORDED MUSIC IN CD FORMAT; COMPUTER SOFTWARE FOR USE AS SCREEN SAVERS; MAGNETS AND SUNGLASSES (U.S. CLS. 21, 23, 26, 36 AND 38).

SN 76-319,340. HUNTER FAN COMPANY, MEMPHIS, TN. FILED 9-28-2001.

ADVAN-TOUCH

OWNER OF U.S. REG. NOS. 2,041,072 AND 2,493,363. FOR REMOTE CONTROLS FOR USE WITH CEILING FANS (U.S. CLS. 21, 23, 26, 36 AND 38).

SN 76-319,720. KONAMI GAMING, INC., LAS VEGAS, NV. FILED 9-28-2001.

TIME PIRATE

FOR GAMING EQUIPMENT, NAMELY, GAMING MACHINES AND GAME SOFTWARE USED THEREWITH (U.S. CLS. 21, 23, 26, 36 AND 38).

SN 76-319,721. KONAMI GAMING, INC., LAS VEGAS, NV. FILED 9-28-2001.

TREASURES OF TULUM

FOR GAMING EQUIPMENT, NAMELY, GAMING MACHINES AND GAME SOFTWARE USED THEREWITH (U.S. CLS. 21, 23, 26, 36 AND 38).

CLASS 9—(Continued).

SN 76-320,858. INTERSIL AMERICAS INC., IRVINE, CA. FILED 10-3-2001.

TECHNOLOGY AT THE SPEED OF LIFE

FOR PROVIDING TECHNICAL AND NON-TECHNICAL INFORMATION IN THE SEMICONDUCTOR AND INTEGRATED CIRCUIT DEVICE FIELDS; COMPUTER HARDWARE AND SOFTWARE CONSULTATION; DESIGNING AND TESTING SEMICONDUCTORS FOR OTHERS; MAINTENANCE OF COMPUTER SOFTWARE; TECHNICAL SUPPORT SERVICES, NAMELY, TROUBLESHOOTING OF COMPUTER HARDWARE AND SOFTWARE PROBLEMS VIA TELEPHONE, EMAIL, AND IN PERSON; SOFTWARE INSTALLATION (U.S. CLS. 21, 23, 26, 36 AND 38).

SN 76-320,860. MEDIA CYBERNETICS, INC., SILVER SPRING, MD. FILED 10-3-2001.

SHARPSTACK

FOR COMPUTER SOFTWARE AND MANUALS SOLD AS A UNIT USED TO PROCESS AND DISPLAY SETS OF THREE-DIMENSIONAL IMAGES FOR USE IN MICROSCOPY (U.S. CLS. 21, 23, 26, 36 AND 38).

SN 76-321,413. VANTAGEMED CORPORATION, RANCHO CORDOVA, CA. FILED 10-4-2001.

THERAPIST HELPER

NO CLAIM IS MADE TO THE EXCLUSIVE RIGHT TO USE "THERAPIST", APART FROM THE MARK AS SHOWN. FOR COMPUTER SOFTWARE FOR PRACTICE MANAGEMENT, NAMELY, FOR MAINTAINING PATIENT FILES AND MEDICAL RECORDS, PATIENT BILLING STATEMENTS AND INSURANCE CLAIM PROCESSING INFORMATION AND RECORDS, AUTOMATED APPOINTMENT SCHEDULING, ACCOUNTING, WORD PROCESSING, SPREADSHEET AND RELATIONAL DATABASE APPLICATIONS, AND ASSIGNING CODES TO MEDICAL PROCEDURES AND DIAGNOSES, ALL RELATING TO THE SUBJECT OF BEHAVIORAL HEALTH IN THE FIELD OF HEALTHCARE (U.S. CLS. 21, 23, 26, 36 AND 38).
FIRST USE 1-0-1990; IN COMMERCE 1-0-1990.

SN 76-322,660. GROOVE PLANET PRODUCTIONS, NASHVILLE, TN. FILED 10-9-2001.

BYTE

FOR MUSICAL SOUND RECORDINGS (U.S. CLS. 21, 23, 26, 36 AND 38).

CLASS 9—(Continued).

SN 76-323,124. SWENCO PRODUCTS, INC., POPLAR BLUFF, MO. FILED 10-10-2001.

POSI-TWIST

FOR ELECTRICAL CONNECTORS (U.S. CLS. 21, 23, 26, 36 AND 38).
FIRST USE 11-13-2000; IN COMMERCE 11-13-2000.

SN 76-323,473. SCRATCHCAT, LLC, ALPHARETTA, GA. FILED 10-10-2001.

FRESH SCIENCE

NO CLAIM IS MADE TO THE EXCLUSIVE RIGHT TO USE "SCIENCE", APART FROM THE MARK AS SHOWN. FOR PRE-RECORDED VIDEO AND AUDIO TAPES AND DISCS FEATURING EDUCATIONAL MATERIAL ON EARTH SCIENCE, LIFE SCIENCE AND PHYSICAL SCIENCE FOR STUDENTS IN K-9 GRADE LEVELS, AND ACCOMPANYING INSTRUCTION MANUALS SOLD THEREWITH (U.S. CLS. 21, 23, 26, 36 AND 38).

SN 76-323,624. NATIONAL BASEBALL HALL OF FAME AND MUSEUM, INC., COOPERSTOWN, NY. FILED 10-10-2001.

BASEBALL AS AMERICA

OWNER OF U.S. REG. NO. 2,191,138.
FOR MAGNETS (U.S. CLS. 21, 23, 26, 36 AND 38).

SN 76-323,800. NATIONAL BASEBALL HALL OF FAME AND MUSEUM, INC., COOPERSTOWN, NY. FILED 10-10-2001.

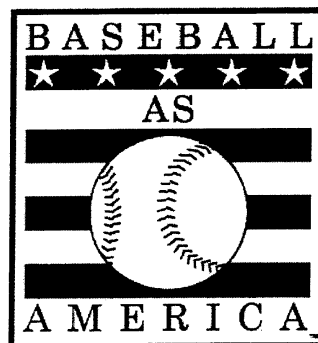

OWNER OF U.S. REG. NO. 2,191,138.
FOR MAGNETS (U.S. CLS. 21, 23, 26, 36 AND 38).

CLASS 9—(Continued).

SN 76-324,729. HILCO WHOLESALE TRADING CO., INC., NORTHBROOK, IL. FILED 10-12-2001.

PATRIOT BRAND

NO CLAIM IS MADE TO THE EXCLUSIVE RIGHT TO USE "BRAND", APART FROM THE MARK AS SHOWN. FOR PROTECTIVE GLOVES FOR INDUSTRIAL USE (U.S. CLS. 21, 23, 26, 36 AND 38).

SN 76-324,846. THERAPIES, INC., SUPERIOR, WI. FILED 10-9-2001.

CLINICAL BOX

NO CLAIM IS MADE TO THE EXCLUSIVE RIGHT TO USE "CLINICAL", APART FROM THE MARK AS SHOWN. FOR MULTIMEDIA SOFTWARE RECORDED ON CD-ROM FEATURING INSTRUCTION IN THE FIELDS OF PHYSICAL THERAPY AND EXERCISE PHYSIOLOGY (U.S. CLS. 21, 23, 26, 36 AND 38).

SN 76-324,847. THERAPIES, INC., SUPERIOR, WI. FILED 10-9-2001.

RX BOX

NO CLAIM IS MADE TO THE EXCLUSIVE RIGHT TO USE "RX", APART FROM THE MARK AS SHOWN. FOR MULTIMEDIA SOFTWARE RECORDED ON CD-ROM FEATURING INSTRUCTION IN THE FIELDS OF PHYSICAL THERAPY AND EXERCISE PHYSIOLOGY (U.S. CLS. 21, 23, 26, 36 AND 38).

SN 76-324,848. THERAPIES, INC., SUPERIOR, WI. FILED 10-9-2001.

BOXWARE

FOR MULTIMEDIA SOFTWARE RECORDED ON CD-ROM FEATURING INSTRUCTION IN THE FIELDS OF PHYSICAL THERAPY AND EXERCISE PHYSIOLOGY (U.S. CLS. 21, 23, 26, 36 AND 38).

SN 76-325,499. D2 RECORDS, LLC, ST. LOUIS, MO. FILED 10-15-2001.

D2 RECORDS

NO CLAIM IS MADE TO THE EXCLUSIVE RIGHT TO USE "RECORDS", APART FROM THE MARK AS SHOWN. FOR COMPACT DISCS, TAPE CASSETTES, RECORDS, CD-ROMS, VIDEO TAPES, DVDS, AND LASER DISCS ALL FEATURING MUSICAL SOUND RECORDINGS AND MUSIC VIDEOS (U.S. CLS. 21, 23, 26, 36 AND 38). FIRST USE 9-1-1993; IN COMMERCE 9-1-1993.

CLASS 9—(Continued).

SN 76-325,778. Q.E.P. CO., INC., BOCA RATON, FL. FILED 10-12-2001.

ELITE

FOR PROTECTIVE CLOTHING, NAMELY, KNEE PADS FOR WORKERS FOR USE IN CONNECTION WITH, AMONG OTHERS, CONSTRUCTION, FLOORING AND GARDENING (U.S. CLS. 21, 23, 26, 36 AND 38). FIRST USE 9-15-2001; IN COMMERCE 9-15-2001.

SN 76-325,883. ADOBE SYSTEMS INCORPORATED, SAN JOSE, CA. FILED 10-15-2001.

KOZUKA GOTHIC

OWNER OF U.S. REG. NO. 2,263,701. NO CLAIM IS MADE TO THE EXCLUSIVE RIGHT TO USE "GOTHIC", APART FROM THE MARK AS SHOWN. THE NAME SHOWN IN THE MARK IDENTIFIES "MA-SHIKO KOZUKA", WHOSE CONSENT IS OF RECORD. FOR COMPUTER SOFTWARE FOR CREATING FONTS; TYPEFACE COMPUTER SOFTWARE; AND USER MANUALS AND INSTRUCTIONAL BOOKS SOLD AS A UNIT THEREWITH (U.S. CLS. 21, 23, 26, 36 AND 38). FIRST USE 8-28-2001; IN COMMERCE 8-28-2001.

SN 76-326,077. POWERWARE CORPORATION, RALEIGH, NC. FILED 10-16-2001.

POWERHANDLER

FOR ELECTRONIC SWITCHBOARD (U.S. CLS. 21, 23, 26, 36 AND 38).

SN 76-326,186. TESSCO COMMUNICATIONS INCORPORATED, HUNT VALLEY, MD. FILED 10-17-2001.

BETTERTALK

FOR WIRELESS COMMUNICATIONS ACCESSORIES, NAMELY, POWER ADAPTORS, HEADSETS AND CASES FOR WIRELESS PHONES (U.S. CLS. 21, 23, 26, 36 AND 38). FIRST USE 12-8-2000; IN COMMERCE 12-8-2000.

CLASS 9—(Continued).

SN 76-326,677. VERITE MULTIMEDIA, INC., DRAPER, UT. FILED 10-17-2001.



FOR COMPUTER SOFTWARE FOR REGISTERING AND ENROLLING PARTICIPANTS VIA THE INTERNET FOR SEMINARS, BUSINESS EVENTS, PRODUCT REGISTRATION LISTS, CONTESTS AND SURVEYS, COLLECTING REGISTRANT INFORMATION, DEMOGRAPHIC INFORMATION AND GENERATING REGISTRATION STATISTICS (U.S. CLS. 21, 23, 26, 36 AND 38).

FIRST USE 5-0-2000; IN COMMERCE 5-0-2000.

SN 76-327,538. SPRING HOUSE, INC., ALEXANDRIA, IN. FILED 10-19-2001.

SPRING HOUSE PRODUCTIONS

OWNER OF U.S. REG. NO. 2,104,125.

NO CLAIM IS MADE TO THE EXCLUSIVE RIGHT TO USE "PRODUCTIONS", APART FROM THE MARK AS SHOWN.

FOR PRE-RECORDED AUDIO TAPES AND DISCS FEATURING MUSIC, PRE-RECORDED VIDEO TAPES AND DISCS FEATURING MUSIC, DOWNLOADABLE MUSICAL SOUND RECORDINGS, DOWNLOADABLE MUSICAL VIDEO RECORDINGS (U.S. CLS. 21, 23, 26, 36 AND 38).

SN 76-328,497. REIKER ENTERPRISES OF NORTHWEST FLORIDA, INC., SHALIMAR, FL. FILED 10-23-2001.

PROBLEM SOLVER

FOR ELECTRICAL WIRING DEVICE, NAMELY, JOIST ELECTRICAL MOUNTING BRACKET FOR CEILING LIGHTING FIXTURES, FANS AND THE LIKE FOR INDUSTRIAL, COMMERCIAL AND RESIDENTIAL APPLICATIONS (U.S. CLS. 21, 23, 26, 36 AND 38).

FIRST USE 3-0-1994; IN COMMERCE 3-0-1994.

CLASS 9—(Continued).

SN 76-328,681. CABOT SAFETY INTERMEDIATE CORPORATION, NEWARK, DE. FILED 10-19-2001.

X.SPORT

FOR PROTECTIVE EYEWEAR (U.S. CLS. 21, 23, 26, 36 AND 38).

SN 76-328,911. SYMBOL TECHNOLOGIES, INC., HOLTSVILLE, NY. FILED 10-23-2001.

CAPTRA

FOR COMPUTER SOFTWARE FOR MOBILE COMPUTERS FOR ENTERING DATA FOR ACCOUNTING APPLICATIONS (U.S. CLS. 21, 23, 26, 36 AND 38).

SN 76-329,260. ESI ACQUISITION, INC., AUGUSTA, GA. FILED 10-23-2001.

WEBEOC

FOR COMPUTER SOFTWARE IN THE FIELD OF EMERGENCY MANAGEMENT AND PUBLIC SAFETY WHICH PERMITS THE RECEIPT, USE AND SHARING OF A WIDE VARIETY OF EMERGENCY MANAGEMENT AND PUBLIC SAFETY INFORMATION OVER A GLOBAL COMPUTER NETWORK (U.S. CLS. 21, 23, 26, 36 AND 38).

FIRST USE 9-1-1997; IN COMMERCE 9-1-1997.

CLASS 9—(Continued).

SN 76-329,640. TII INDUSTRIES, INC., COPIAGUE, NY.
FILED 10-25-2001.

TII

OWNER OF U.S. REG. NOS. 912,671, 1,155,357 AND OTHERS.

FOR OVER-VOLTAGE AND OVER-CURRENT POWER LINE PROTECTORS, PROTECTORS ASSEMBLIES, AND STRUCTURAL PARTS THEREOF; WIRELESS AND WIRELINE CO-AXIAL OVER-VOLTAGE PROTECTORS, PROTECTOR ASSEMBLIES, AND STRUCTURAL PARTS THEREOF; DATA LINE OVER-VOLTAGE PROTECTORS, PROTECTOR ASSEMBLIES AND STRUCTURAL PARTS THEREOF; TELEPHONE LINE OVER-VOLTAGE PROTECTORS, PROTECTOR ASSEMBLIES, AND STRUCTURAL PARTS THEREOF; OVER-VOLTAGE GAS TUBE PROTECTORS AND RELATED APPARATUS, NAMELY, SURGE ARRESTER TUBES, STATION PROTECTORS, PROTECTOR ASSEMBLIES, SURGE PROTECTORS, AND GAS TUBE ARRESTERS; ELECTRONIC COMMUNICATIONS TESTING UNITS TO TEST TELEPHONE LOOPS, TELEPHONE TRUNKS, PAIR GAIN SYSTEMS, PAIR GAIN LOOPS, DATA CIRCUITS, CELLULAR RADIO CIRCUITS, SATELLITE CIRCUITS, AND ANALOG AND DIGITAL TRANSMISSION FACILITIES; MODULAR COMPONENTS FOR TELECOMMUNICATIONS SYSTEMS, NAMELY, SPLICE TRAYS, SPLICE SHELVES, PATCH PANELS AND SPLICE CLOSURES FOR MOUNTING, ROUTING AND STORING FIBER OPTICS CABLES; TIME RELEASE REMOTE LOOP DISCONNECT FOR USE IN REMOTELY DISCONNECTING COMMUNICATION AND ELECTRONIC INSTRUMENTS; LATCHING REMOTE LOOP DISCONNECT WITH AUTOMATIC RESET FOR USE IN REMOTELY DISCONNECTING COMMUNICATION AND ELECTRONIC INSTRUMENTS; UNIT FOR PROVIDING CONTINUOUS BALANCED OR MOMENTARY GROUND RESISTANCE AND ISOLATING RINGERS FROM GROUND DURING ACTIVE MODE OF COMMUNICATION; INTEGRATED PANELS INCORPORATING SURGE PROTECTORS AND RESIDENTIAL GATEWAYS FOR NETWORK INTERFACE AND MANAGEMENT, FOR USE IN HOMES AND SMALL BUSINESSES; NETWORK INTERFACE DEVICES, NAMELY UNITS INCORPORATING SURGE PROTECTORS AND CONNECTORS FOR COMMUNICATIONS LINES; WHOLE HOME SURGE PROTECTORS (U.S. CLS. 21, 23, 26, 36 AND 38).

SN 76-331,117. BRIGHAM YOUNG UNIVERSITY, PROVO, UT. FILED 10-29-2001.



TANTARA
RECORDS

NO CLAIM IS MADE TO THE EXCLUSIVE RIGHT TO USE "RECORDS", APART FROM THE MARK AS SHOWN. FOR PRODUCTION OF MUSIC CD'S, VIDEOS, AND CASSETTES (U.S. CLS. 21, 23, 26, 36 AND 38).
FIRST USE 11-20-1991; IN COMMERCE 11-20-1991.

CLASS 9—(Continued).

SN 76-331,378. POLARIS POOL SYSTEMS, INC., VISTA, CA.
FILED 10-30-2001.

WATERMATIC

FOR AUTOMATIC CONTROLLERS AND CHEMICAL FEEDERS FOR POOLS AND SPAS (U.S. CLS. 21, 23, 26, 36 AND 38).
FIRST USE 9-0-1997; IN COMMERCE 9-0-1997.

SN 76-331,421. CITO PRODUCTS, INC., WATERTOWN, WI.
FILED 10-30-2001.

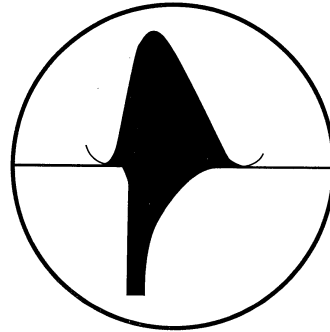

FOR CONTROLLERS FOR USE WITH PLASTIC INJECTION MOLDING MACHINES (U.S. CLS. 21, 23, 26, 36 AND 38).
FIRST USE 9-20-2001; IN COMMERCE 9-20-2001.

SN 76-331,589. SCARFF, PHILIP L., III, WINCHESTER, MA.
FILED 10-31-2001.

GALLOPING GOAT

FOR MUSICAL SOUND RECORDINGS (U.S. CLS. 21, 23, 26, 36 AND 38).
FIRST USE 10-12-1990; IN COMMERCE 10-12-1990.

SN 76-332,129. IONA TECHNOLOGIES PLC, DUBLIN 4, IRELAND, FILED 10-30-2001.

IONA END TO ANYWHERE

OWNER OF U.S. REG. NO. 2,197,133.
FOR COMPUTER PROGRAMS FOR DEVELOPING OTHER COMPUTER PROGRAMS; COMPUTER SOFTWARE DEVELOPMENT TOOLS FOR USE IN DEVELOPING AND DEPLOYING DISTRIBUTED APPLICATIONS; COMPUTER PROGRAMS FOR THE INTEGRATION OF SOFTWARE APPLICATIONS AND SYSTEM COMPONENTS ACROSS DIFFERENT LANGUAGES, PLATFORMS AND NETWORKS, INCLUDING ACROSS GLOBAL COMPUTER NETWORKS (U.S. CLS. 21, 23, 26, 36 AND 38).

CLASS 9—(Continued).

SN 76-332,130. IONA TECHNOLOGIES PLC, DUBLIN 4, IRELAND, FILED 10-30-2001.

IONA END 2 ANYWHERE

OWNER OF U.S. REG. NO. 2,197,133.
FOR COMPUTER PROGRAMS FOR DEVELOPING OTHER COMPUTER PROGRAMS; COMPUTER SOFTWARE DEVELOPMENT TOOLS FOR USE IN DEVELOPING AND DEPLOYING DISTRIBUTED APPLICATIONS; COMPUTER PROGRAMS FOR THE INTEGRATION OF SOFTWARE APPLICATIONS AND SYSTEM COMPONENTS ACROSS DIFFERENT LANGUAGES, PLATFORMS AND NETWORKS, INCLUDING ACROSS GLOBAL COMPUTER NETWORKS (U.S. CLS. 21, 23, 26, 36 AND 38).

SN 76-332,138. IONA TECHNOLOGIES PLC, DUBLIN 4, IRELAND, FILED 10-30-2001.

IONA E2A

OWNER OF U.S. REG. NO. 2,197,133.
FOR COMPUTER PROGRAMS FOR DEVELOPING OTHER COMPUTER PROGRAMS; COMPUTER SOFTWARE DEVELOPMENT TOOLS FOR USE IN DEVELOPING AND DEPLOYING DISTRIBUTED APPLICATIONS; COMPUTER PROGRAMS FOR THE INTEGRATION OF SOFTWARE APPLICATIONS AND SYSTEM COMPONENTS ACROSS DIFFERENT LANGUAGES, PLATFORMS AND NETWORKS, INCLUDING ACROSS GLOBAL COMPUTER NETWORKS (U.S. CLS. 21, 23, 26, 36 AND 38).

SN 76-332,193. COLUMBIA ULTIMATE BUSINESS SYSTEMS, INC., VANCOUVER, WA. FILED 10-30-2001.

AJILITY

FOR COMPUTER SOFTWARE, NAMELY N-TIERED, MIDDLEWARE COMPUTER SOFTWARE FOR MANAGING COLLECTIONS IN THE FIELD OF DEBT COLLECTION AND REVENUE RECOVERY (U.S. CLS. 21, 23, 26, 36 AND 38).

SN 76-333,006. COMPANYWAY.COM, INC., DENVER, CO. FILED 11-2-2001.

WORK FOR HIGHER

FOR COMPUTER SOFTWARE, NAMELY, SOFTWARE THAT ALLOWS ORGANIZATIONS TO ESTABLISH AND ADMINISTER PROGRAMS WHEREIN INDIVIDUALS INSIDE AND OUTSIDE THE ORGANIZATIONS WHO ARE INTERESTED IN A COMMON GOAL FORM GROUPS TO EVALUATE AND ACHIEVE THAT GOAL, WITH MECHANISMS FOR INCENTIVES, PAYMENT, AND TRACKING OF ACCOMPLISHMENTS FOR THE INDIVIDUALS WITHIN THE PROGRAMS (U.S. CLS. 21, 23, 26, 36 AND 38).
FIRST USE 10-0-2000; IN COMMERCE 10-0-2000.

CLASS 9—(Continued).

SN 76-333,130. VBS, INC., SIOUX CENTER, IA. FILED 11-1-2001.

DYNA TABLE

NO CLAIM IS MADE TO THE EXCLUSIVE RIGHT TO USE "TABLE", APART FROM THE MARK AS SHOWN.
FOR COMPUTER CONTROLLED PLASMA TORCH CUTTING TABLES (U.S. CLS. 21, 23, 26, 36 AND 38).

SN 76-333,701. APPLIEDTHEORY CORPORATION, SYACUSE, NY. FILED 11-2-2001.

THOMAS SYSTEM

NO CLAIM IS MADE TO THE EXCLUSIVE RIGHT TO USE "SYSTEM", APART FROM THE MARK AS SHOWN.
FOR COMPUTER SOFTWARE FOR USE IN MONITORING WEB SITE PERFORMANCE AND AVAILABILITY (U.S. CLS. 21, 23, 26, 36 AND 38).

SN 76-334,578. FUJI PHOTO FILM CO., LTD., ASHIGARASHI, KANAGAWA, JAPAN, FILED 11-5-2001.

INTUITIVE COLOR

NO CLAIM IS MADE TO THE EXCLUSIVE RIGHT TO USE "COLOR", APART FROM THE MARK AS SHOWN.
FOR COMPUTER SOFTWARE FOR PRINTER DRIVERS, COMPUTER SOFTWARE FOR CONTROLLING COLOR MANAGEMENT (U.S. CLS. 21, 23, 26, 36 AND 38).

SN 76-334,579. FUJI PHOTO FILM CO., LTD., ASHIGARASHI KANAGAWA, JAPAN, FILED 11-5-2001.

CO-RES SCREENING

NO CLAIM IS MADE TO THE EXCLUSIVE RIGHT TO USE "SCREENING", APART FROM THE MARK AS SHOWN.
FOR COMPUTER SOFTWARE FOR PRODUCING SCREENING DATA TO BE USED FOR PRINTING (U.S. CLS. 21, 23, 26, 36 AND 38).

SN 76-334,841. CLARION CO., LTD, TOKYO, JAPAN, FILED 11-6-2001.

DUAL ACTION

FOR AUTOMOTIVE RADIOS, STEREOS, TRANSCEIVERS, RADIO TUNERS AND RECEIVERS, AUDIO CASSETTE PLAYERS, AUDIO MINI-DISC PLAYERS, COMPACT DISC PLAYERS, COMPACT DISC CHANGERS, DVD PLAYERS, DVD CHANGERS AND MP3 PLAYERS (U.S. CLS. 21, 23, 26, 36 AND 38).

CLASS 9—(Continued).

SN 76-335,802. FURNITURE MARKETING GROUP, INC., DALLAS, TX. FILED 11-7-2001.

WAVE

FOR COMPUTER SOFTWARE FOR PROVIDING STRATEGIC FACILITY ASSET AND MANAGEMENT SERVICES, NAMELY, TRACKING, REPORTING, ANALYZING, MANAGING AND DELIVERING FURNITURE ORDER, INVENTORY, CONFIGURATION, MAINTENANCE, REFURBISHMENT, REMOVAL, AND COST INFORMATION (U.S. CLS. 21, 23, 26, 36 AND 38).

SN 76-336,377. CABLE DESIGN TECHNOLOGIES, INC., DBA MOHAWK/CDT, LEOMINISTER, MA. FILED 11-12-2001.

PLENGUARD

OWNER OF U.S. REG. NO. 1,890,430.
FOR ELECTRICAL CABLE (U.S. CLS. 21, 23, 26, 36 AND 38).
FIRST USE 7-1-1994; IN COMMERCE 9-29-1994.

SN 76-336,382. AERIAL VIEW SYSTEMS, INC., NEWPORT BEACH, CA. FILED 11-12-2001.

AERIALTRAC

FOR VIDEO CAMERAS AND VIDEO MONITORS FOR USE ON AIRCRAFT (U.S. CLS. 21, 23, 26, 36 AND 38).

SN 76-336,383. AERIAL VIEW SYSTEMS, INC., NEWPORT BEACH, CA. FILED 11-12-2001.

MAPTRAC

FOR VIDEO CAMERAS AND VIDEO MONITORS FOR USE ON AIRCRAFT (U.S. CLS. 21, 23, 26, 36 AND 38).

SN 76-337,437. LIFEVINE, INC., POWAY, CA. FILED 11-13-2001.

ACTIVE 16

FOR INTERACTIVE MEDICAL ALERT APPARATUS FOR REMINDING WEARER OF MEDICAL INFORMATION, NAMELY MEDICINAL DOSAGE, ALLERGIC SENSITIVITY, PRESCRIPTION REFILLS (U.S. CLS. 21, 23, 26, 36 AND 38).

CLASS 9—(Continued).

SN 76-337,480. RIPTECH, INC., ALEXANDRIA, VA. FILED 11-13-2001.

CALTARIAN

FOR COMPUTER SOFTWARE FOR COLLECTING, NORMALIZING, CORRELATING, PRIORITIZING AND PROCESSING NETWORK ACTIVITY DATA TO DETECT SUSPICIOUS, MALICIOUS OR ABUSIVE ACTIVITY AND TO PROTECT AGAINST SUCH ACTIVITY (U.S. CLS. 21, 23, 26, 36 AND 38).

SN 76-337,522. OMNI DEVELOPMENT, INC., SEATTLE, WA. FILED 11-13-2001.

OMNIWEB

FOR COMPUTER SOFTWARE FOR BROWSING THE INTERNET (U.S. CLS. 21, 23, 26, 36 AND 38).
FIRST USE 3-18-1994; IN COMMERCE 3-18-1994.

SN 76-338,098. STYLE EYES, INC., IRVINE, CA. FILED 11-16-2001.

BOARDER
Girls

FOR SUNGLASSES AND SPORT SUNGLASSES (U.S. CLS. 21, 23, 26, 36 AND 38).
FIRST USE 7-16-2001; IN COMMERCE 7-16-2001.

SN 76-338,289. H5 TECHNOLOGIES, INC., SAN FRANCISCO, CA. FILED 11-15-2001.

H5 ATLAS

FOR SOFTWARE THAT ENABLES AUTOMATED INDEXING, COMPARISON, RETRIEVAL, FILTERING, CLUSTERING AND TARGETING OF TEXT AND ADVERTISING; COMPUTER SEARCH ENGINE SOFTWARE (U.S. CLS. 21, 23, 26, 36 AND 38).

SN 76-338,658. WOLVERINE TUBE, INC., HUNTSVILLE, AL. FILED 11-15-2001.

MICROHEAT

FOR COMPUTER PROGRAMS DIRECTED TO DETERMINING PARAMETERS AND EQUIPMENT REQUIREMENTS FOR HEATING AND COOLING APPLICATIONS (U.S. CLS. 21, 23, 26, 36 AND 38).
FIRST USE 10-4-2001; IN COMMERCE 10-4-2001.

CLASS 9—(Continued).

SN 76-338,679. PACIFIC BROADBAND COMMUNICATIONS, INC., SAN JOSE, CA. FILED 11-16-2001.

SERVICEGUARD

FOR BROADBAND TELECOMMUNICATIONS HARDWARE, NAMELY MULTISERVICE CABLE MODEM TERMINATION SYSTEMS CONTAINING CHASSIS, CHASSIS CONTROL MODULES, INPUT AND OUTPUT CARDS, LINE CARDS, NETWORK INTERFACE CARDS, MIDPLANES, UPCONVERTERS, AND SOFTWARE TO DELIVER VOICE, VIDEO, AND DATA OVER WIRE AND WIRELESS COMMUNICATIONS NETWORKS (U.S. CLS. 21, 23, 26, 36 AND 38).

SN 76-338,873. HARRIS CORPORATION, MELBOURNE, FL. FILED 11-14-2001.

NEUTRALIZER

FOR COMPUTER SOFTWARE FOR PREVENTING UNAUTHORIZED ACCESS OR USE OF COMPUTER SYSTEMS AND MANUALS AND DOCUMENTATION DISTRIBUTED AS A UNIT THEREWITH (U.S. CLS. 21, 23, 26, 36 AND 38).

SN 76-338,918. NORTHERN SAFETY CO., INC., FRANKFORT, NY. FILED 11-16-2001.

AVENGER

FOR EYEWEAR, NAMELY, SAFETY GLASSES (U.S. CLS. 21, 23, 26, 36 AND 38).

SN 76-339,097. STRATA DECISION TECHNOLOGY, LLC, CHAMPAIGN, IL. FILED 11-16-2001.

STRATACAP

FOR COMPUTER SOFTWARE FOR CAPITAL BUDGETING AND RESOURCE ALLOCATION USING MULTI-OBJECTIVE DECISION ANALYSIS, FINANCIAL ANALYSIS, AND MATHEMATICAL OPTIMIZATION METHODS; COMPUTER SOFTWARE USED BY OTHERS TO ACCESS COMPUTERIZED DATABASES OF INFORMATION COMPILED BY SUPPLIERS OF CAPITAL EQUIPMENT AND PRODUCTS IN THE MEDICAL AND HEALTH-CARE RELATED INDUSTRIES (U.S. CLS. 21, 23, 26, 36 AND 38).

FIRST USE 2-1-1999; IN COMMERCE 2-1-1999.

SN 76-340,646. SAN DIEGO STATE UNIVERSITY FOUNDATION, SAN DIEGO, CA. FILED 11-23-2001.

TEXTWEAVER

FOR COMPUTER SOFTWARE TO ENABLE ACTIVE ONLINE DIALOGUE (U.S. CLS. 21, 23, 26, 36 AND 38).

CLASS 9—(Continued).

SN 76-340,902. SYNACOR, INC., BUFFALO, NY. FILED 11-23-2001.

SYNACOR

FOR COMPUTER SOFTWARE FOR USE IN EMAIL HOSTING, COLLABORATION AND PORTAL SERVER SOLUTIONS AND WEBSITE DEVELOPMENT (U.S. CLS. 21, 23, 26, 36 AND 38).

SN 76-340,913. SWITRONIX, INC., VALLEY STREAM, NY. FILED 11-23-2001.

SWIT

FOR BATTERIES AND BATTERY CHARGERS (U.S. CLS. 21, 23, 26, 36 AND 38).

SN 76-341,159. AMPLIFY.NET, INC., FREMONT, CA. FILED 11-20-2001.

ISURFBOSS

FOR COMPUTER HARDWARE AND COMPUTER SOFTWARE FOR AMPLIFYING THE VALUE OF BANDWIDTH, AND MANAGING AND PRIORITIZING BANDWIDTH, AND USER MANUALS SOLD THEREWITH AS A UNIT (U.S. CLS. 21, 23, 26, 36 AND 38).

FIRST USE 6-16-1999; IN COMMERCE 6-16-1999.

SN 76-341,696. SERTI INFORMATIQUE INC., PROVINCE OF QUEBEC, CANADA, FILED 11-26-2001.

GRIZZLY.CAT

FOR COMPUTER SOFTWARE FOR USE AS DATABASE TO MANAGE ELECTRONIC CATALOGS AND ORDER FORMS FOR DOING BUSINESS-TO-BUSINESS (B2B) AND BUSINESS-TO-CONSUMER (B2C) ELECTRONIC COMMERCE ON THE INTERNET (U.S. CLS. 21, 23, 26, 36 AND 38).

SN 76-342,121. MEDIAMAP, INC., WATERTOWN, MA. FILED 11-27-2001.

MEDIAMAPPERFORMA

FOR COMPUTER SOFTWARE FOR COMMUNICATIONS MANAGEMENT, NAMELY, SOFTWARE FOR MANAGING THE RELATIONSHIP, DISTRIBUTION, AND PERFORMANCE OF COMMUNICATIONS IN THE PROFESSIONAL COMMUNICATIONS INDUSTRY (U.S. CLS. 21, 23, 26, 36 AND 38).

CLASS 9—(Continued).

SN 76-342,333. MEDIAMAP, INC., WATERTOWN, MA.
FILED 11-27-2001.

PERFORMA

FOR COMPUTER SOFTWARE FOR COMMUNICATIONS MANAGEMENT, NAMELY, SOFTWARE FOR MANAGING THE RELATIONSHIP, DISTRIBUTION, AND PERFORMANCE OF COMMUNICATIONS IN THE PROFESSIONAL COMMUNICATIONS INDUSTRY (U.S. CLS. 21, 23, 26, 36 AND 38).

SN 76-342,415. KOPIN CORPORATION, TAUNTON, MA.
FILED 11-28-2001.

CYBERLITE

FOR SEMICONDUCTOR-BASED LIGHT EMITTERS (U.S. CLS. 21, 23, 26, 36 AND 38).

SN 76-342,416. TWOROGER ASSOCIATES LTD., NEW YORK, NY. FILED 11-28-2001.

M+

FOR EYEGLASSES, SUNGLASSES, EYEGLASS FRAMES, AND EYEGLASS CASES (U.S. CLS. 21, 23, 26, 36 AND 38).

SN 76-342,540. SPORTING LIVES, INC., FRUITLAND, ID.
FILED 11-27-2001.

SOSPENDERS

FOR LIFE PRESERVERS (U.S. CLS. 21, 23, 26, 36 AND 38).
FIRST USE 0-0-1976; IN COMMERCE 0-0-1976.

SN 76-342,917. TAYLOR PUBLISHING COMPANY, DALLAS, TX. FILED 11-28-2001.

YB!PRO

FOR COMPUTER PROGRAMS FOR USE IN PREPARATION OF YEARBOOKS (U.S. CLS. 21, 23, 26, 36 AND 38).

CLASS 9—(Continued).

SN 76-343,368. APPLIED SCIENCE FICTION, INC., AUSTIN, TX. FILED 11-29-2001.

DIGITAL SHO

OWNER OF U.S. REG. NOS. 2,438,842, 2,500,967 AND OTHERS.

NO CLAIM IS MADE TO THE EXCLUSIVE RIGHT TO USE "DIGITAL", APART FROM THE MARK AS SHOWN.

FOR COMPUTER SOFTWARE AND HARDWARE FOR PROCESSING IMAGES (U.S. CLS. 21, 23, 26, 36 AND 38).

SN 76-343,500. EMEMORY TECHNOLOGY INC., HSINCHU, TAIWAN, FILED 11-30-2001.

BIFLASH

FOR SEMICONDUCTOR MEMORY; INTEGRATED CIRCUITS; DIGITAL MEMORY CARDS; MEMORY CONTROLLERS NAMELY, INTEGRATED CIRCUITS FOR CONTROLLING THE OPERATION OF SEMICONDUCTOR MEMORY (U.S. CLS. 21, 23, 26, 36 AND 38).

SN 76-343,591. WAVE7 OPTICS, INC., ALPHARETTA, GA.
FILED 11-30-2001.

LMS

FOR TELECOMMUNICATIONS AND DATA NETWORKING EQUIPMENT, NAMELY, OPTICAL NETWORK HARDWARE AND SOFTWARE USED FOR FIBER OPTIC TRANSMISSION TO RESIDENCES OR BUSINESSES (U.S. CLS. 21, 23, 26, 36 AND 38).

SN 76-343,623. DIALOGIC COMMUNICATIONS CORPORATION, FRANKLIN, TN. FILED 11-30-2001.

FRONTWAVE

FOR COMPUTER HARDWARE AND SOFTWARE FOR CALL CENTER MANAGEMENT, FEATURING INTERACTIVE VOICE RESPONSE, COMPUTER TELEPHONY INTEGRATION, WEB RESPONSE, CRITICAL MESSAGING, AND SPEECH RECOGNITION CAPABILITIES (U.S. CLS. 21, 23, 26, 36 AND 38).

SN 76-343,749. PALADIN-SELECT, INC., DALLAS, TX.
FILED 11-30-2001.

AUTO-CONFLICTS

FOR COMPUTER SOFTWARE FOR ASSISTING IN THE DETERMINATION OF WHETHER A CONFLICT OF INTEREST EXISTS BETWEEN A PROFESSIONAL SERVICE PROVIDER AND A POTENTIAL CLIENT (U.S. CLS. 21, 23, 26, 36 AND 38).

CLASS 9—(Continued).

SN 76-343,875. GARDNER DENVER, INC., QUINCY, IL. FILED 11-30-2001.

SMARTMETER

OWNER OF U.S. REG. NO. 1,822,417. SEC. 2(F).
FOR MICROPROCESSOR CONTROLLED DIGITAL MONITOR SPECIFICALLY DESIGNED TO MONITOR BLOWERS AND EXHAUSTERS (U.S. CLS. 21, 23, 26, 36 AND 38).
FIRST USE 0-0-1991; IN COMMERCE 0-0-1991.

SN 76-344,009. WATERS INDUSTRIES, INC., WEST DUNDEE, IL. FILED 11-30-2001.

RADIANT READERS

FOR SUNGLASSES (U.S. CLS. 21, 23, 26, 36 AND 38).
FIRST USE 4-0-2001; IN COMMERCE 5-0-2001.

SN 76-345,224. COLE VISION CORPORATION, TWINSBURG, OH. FILED 12-5-2001.

PERSPECTA

FOR CONTACT LENSES (U.S. CLS. 21, 23, 26, 36 AND 38).
FIRST USE 2-1-2000; IN COMMERCE 2-1-2000.

SN 76-345,284. CIENA CORPORATION, LINTHICUM, MD. FILED 12-6-2001.

METRODIRECTOR

FOR COMMUNICATIONS AND NETWORKING EQUIPMENT AND SOFTWARE, NAMELY, TRANSMISSION AND SWITCHING EQUIPMENT AND NETWORKS AND RELATED SOFTWARE FOR USE IN THE FIELD OF TELECOMMUNICATIONS FOR TRANSMITTING, MANAGING AND OPTIMIZING VOICE, DATA, IMAGES AND INFORMATION OVER FIBER OPTIC CABLES, AND FIBER OPTIC TELECOMMUNICATION NETWORK MANAGEMENT HARDWARE AND DEVICES, AND USER MANUALS ASSOCIATED THEREWITH (U.S. CLS. 21, 23, 26, 36 AND 38).

SN 76-345,410. BACHANN, MINTU, PONTE VEDRA, FL. FILED 12-5-2001.

RADAS

FOR COMPUTER SOFTWARE FOR ANALYSIS OF CREDIT RISK AND UNDERWRITING DECISIONS (U.S. CLS. 21, 23, 26, 36 AND 38).

CLASS 9—(Continued).

SN 76-345,724. TOONTZ TOYZ, INC., HIGHLANDS, NJ. FILED 12-7-2001.

BRAINBOTS

FOR COMPUTER SOFTWARE GAMES AND ANIMATED MOTION PICTURE FILMS FOR CHILDREN (U.S. CLS. 21, 23, 26, 36 AND 38).

SN 76-346,168. NBG SOLUTIONS, INC., TUALATIN, OR. FILED 12-7-2001.

KIGUARD

FOR SOFTWARE APPLICATION FOR USE IN MERCHANDISING AND INFORMATION DISPLAY KIOSKS, NAMELY SOFTWARE THAT MANAGES AND MAINTAINS OTHER SOFTWARE PROGRAMS USED IN THE KIOSK (U.S. CLS. 21, 23, 26, 36 AND 38).

SN 76-346,278. TIGI CORPORATION, BETHESDA, MD. FILED 12-10-2001.

TURBORAIID

FOR DATA MOVEMENT STORAGE SYSTEM COMPRISED OF COMPUTER HARDWARE AND SOFTWARE FOR CONTROLLING AND MANAGING THE MOVEMENT OF INFORMATION BETWEEN DATA STORAGE SYSTEMS (U.S. CLS. 21, 23, 26, 36 AND 38).

SN 76-346,291. MILESTONE SOFTWARE & SYSTEMS, TOTOWA, NJ. FILED 12-10-2001.

REGENATIVE

FOR COMPUTER SOFTWARE FOR USE IN NETWORK MANAGEMENT (U.S. CLS. 21, 23, 26, 36 AND 38).

SN 76-346,293. MILESTONE SOFTWARE & SYSTEMS, TOTOWA, NJ. FILED 12-10-2001.

TRANSLAYER

FOR COMPUTER SOFTWARE FOR USE IN NETWORK MANAGEMENT (U.S. CLS. 21, 23, 26, 36 AND 38).

CLASS 9—(Continued).

SN 76-346,294. MILESTONE SOFTWARE & SYSTEMS, TOWA, NJ. FILED 12-10-2001.

TRANSGAZE

FOR COMPUTER SOFTWARE FOR USE IN NETWORK MANAGEMENT (U.S. CLS. 21, 23, 26, 36 AND 38).

SN 76-346,295. MILESTONE SOFTWARE & SYSTEMS, TOWA, NJ. FILED 12-10-2001.

TRANSBIONIC

FOR COMPUTER SOFTWARE FOR USE IN NETWORK MANAGEMENT (U.S. CLS. 21, 23, 26, 36 AND 38).

SN 76-346,559. TERRA-CARE, INC., TAYLORS, SC. FILED 12-7-2001.

TERRAVENT

FOR SOIL AERATION AND DE-COMPACTION EQUIPMENT (U.S. CLS. 21, 23, 26, 36 AND 38).
FIRST USE 11-0-2000; IN COMMERCE 11-0-2000.

SN 76-346,838. BAO SHEN USA, INC., SAN DIMAS, CA. FILED 12-10-2001.



THE MARK CONSISTS OF THE STYLIZED WORDING "GI-GI" AND A MONKEY FIGURE.

FOR HOLDERS AND CARTOON DESIGNED HOLDERS, NAMELY, COMPACT DISCS HOLDERS, DIGITAL VIDEO DISCS HOLDERS, VIDEO COMPACT DISCS HOLDERS, AND VIDEO GAME COMPACT DISCS HOLDERS (U.S. CLS. 21, 23, 26, 36 AND 38).

FIRST USE 1-0-1998; IN COMMERCE 1-0-1998.

CLASS 9—(Continued).

SN 76-346,902. LEAPFROG ENTERPRISES, INC., EMERYVILLE, CA. FILED 12-7-2001.

LEAPTRACK

FOR EDUCATIONAL SKILLS DEVELOPMENT AND ASSESSMENT SOFTWARE FOR EDUCATORS AND PARENTS DESIGNED FOR USE IN CONJUNCTION WITH LEARNING DEVICES FOR CHILDREN, NAMELY SOFTWARE, AVAILABLE ON CD-ROM AND DOWNLOADABLE FROM A REMOTE COMPUTER LOCATION, THAT DEVELOPS, ASSESSES, AND PRESCRIBES ACADEMIC SKILL LEVELS IN THE FIELDS OF MATH, SCIENCE, LANGUAGE ARTS, AND THE SOCIAL SCIENCES (U.S. CLS. 21, 23, 26, 36 AND 38).

SN 76-347,182. CYBIZ, INC., RESTON, VA. FILED 12-11-2001.

CYBIZ

OWNER OF U.S. REG. NO. 2,469,280.
FOR COMPUTER SOFTWARE FOR USE IN PROCUREMENT SYSTEMS, NAMELY, COMPUTER SOFTWARE FOR ELECTRONIC CATALOG MANAGEMENT AND FOR MANAGEMENT OF PURCHASES FROM SUCH CATALOGS (U.S. CLS. 21, 23, 26, 36 AND 38).
FIRST USE 8-1-1999; IN COMMERCE 8-1-1999.

SN 76-350,846. BUSTRONIC CORPORATION, FREMONT, CA. FILED 12-13-2001.



FOR COMPUTER HARDWARE ACCESSORIES, NAMELY, FORM FACTOR EXTENDERS, TEST EXTENDERS, OVERLAYS, LOAD BOARDS, SYSTEM MONITORS, AND VOLTAGE MONITORS (U.S. CLS. 21, 23, 26, 36 AND 38).

FIRST USE 5-2-1991; IN COMMERCE 5-25-1991.

CLASS 9—(Continued).

SN 78-016,609. THOMSON-CSF, SOCIETE ANONYME, PARIS, FRANCE, AND MOULAGE PLASTIQUE DE L'OUEST, SOCIETE ANONYME, AVERTON, FRANCE, FILED 7-13-2000.

TAGES

PRIORITY CLAIMED UNDER SEC. 44(D) ON FRANCE APPLICATION NO. 003005603, FILED 2-4-2000, REG. NO. 003005603, DATED 2-4-2000, EXPIRES 2-4-2010.

PRIORITY CLAIMED UNDER SEC. 44(D) ON FRANCE APPLICATION NO. 003005603, FILED 2-4-2000, REG. NO. 003005603, DATED 2-4-2000, EXPIRES 2-4-2010.

THE WORDING TAGES IS THE NAME OF A GREEK GOD.

FOR EQUIPMENT FOR THE RECORDING AND REPRODUCTION OF SOUND AND IMAGES, NAMELY, VIDEO CASSETTE RECORDER AND DIGITAL VIDEO DISC RECORDER AND PLAYER; MAGNETIC RECORDING MEDIA, NAMELY, BLANK AUDIOTAPES AND BLANK RECORDABLE AND MAGNETIC DISC WITH PREFORMATTED TRACKS; BLANK ACOUSTIC DISKS, NAMELY, CD AND DVD RECORDABLE WITH PREFORMATTED TRACKS; EQUIPMENT FOR INFORMATION PROCESSING, NAMELY, MASTERING SYSTEM FOR DISC MANUFACTURING; COMPUTERS, COMPUTER HARDWARE AND SOFTWARE DESIGNED TO ENSURE PROTECTION FROM FRAUDULENT COPYING OF DATA MEDIA CONTENT; MEMORY OR MICROPROCESSOR CARDS; MAGNETIC CARDS ENCODED WITH COMPUTER PROGRAMS; VIDEO GAME CARTRIDGES; VIDEOCASSETTES, VIDEO COMPACT DISCS, OPTICAL COMPACT DISCS, AUDIO VIDEO COMPACT DISCS, MAGNETIC DISKS, OPTICAL DISKS, AND FLOPPY DISKETTES FOR COMPUTER, ALL PRE-RECORDED WITH AT LEAST A PREFORMATTED TRACK FOR COPY PROTECTION USE, COMPUTER CD PLAYERS WITH ANTI-COPY PROTECTION, COMPACT DISC DEVICES AND OPTICAL DEVICES FOR GAMING CONSOLE WITH ANTI-COPY PROTECTION, COMPUTER MEMORY CHIPS AND RECORDED COMPUTER OPERATING PROGRAMS IN THE FIELD OF COPY PROTECTED SOFTWARE (U.S. CLS. 21, 23, 26, 36 AND 38).

SN 78-017,276. INLET IP HOLDINGS LLC, WHITEFISH BAY, WI. BY ASSIGNMENT FRIEND, JEFF, WHITEFISH BAY, WI. FILED 7-18-2000.

CONFIDANT

FOR TELECOMMUNICATIONS EQUIPMENT, AND EQUIPMENT, COMPONENTS, SUPPLIES AND SYSTEMS TO TRANSMIT, RECEIVE OR OTHERWISE ACCESS COMMUNICATIONS NETWORKS, NAMELY; PAGERS, TELEPHONES, TELEPHONE SWITCHES, COMPUTER PERIPHERAL EQUIPMENT FOR USE IN LOCAL AREA NETWORKS AND WIDE AREA NETWORKS, COAXIAL AND FIBER OPTIC CABLES AND ADAPTERS; COMPUTER SOFTWARE FOR ACCESSING A GLOBAL TELECOMMUNICATIONS NETWORK OR INTERACTIVE COMPUTER COMMUNICATIONS NETWORK, INSTANT MESSAGING, VOICE OVER INTERNET PROTOCOL (VOIP), TRANSMITTING, SECURING, AND SEARCHING ELECTRONIC DATA, INITIATING THE DISTRIBUTION OF CONSUMER QUESTIONNAIRES IN RESPONSE TO ELECTRONIC PAYMENT TRANSACTIONS AS WELL PACKAGE DELIVERIES AND RETURNS AND PROCESSING THAT INFORMATION;

CLASS 9—(Continued).

COMPUTERS AND COMPUTER-RELATED EQUIPMENT, COMPONENTS, SUPPLIES AND SYSTEMS, NAMELY; PERSONAL COMPUTERS, MICROCOMPUTERS, MONITORS, COMPUTER DISPLAY UNITS, SPEAKERS, MICROPHONES, COMPUTER STORAGE MEDIA, NAMELY BLANK TAPES FOR STORAGE OF COMPUTER DATA; COMPUTER MEMORY, COMPUTER PERIPHERALS AND MODEMS; TELEVISION EQUIPMENT, NAMELY; TELEVISIONS AND TELEVISION PERIPHERAL EQUIPMENT, NAMELY, CAMERAS, SET BOXES, REMOTE CONTROL UNITS FOR INTERACTIVE AND NON-INTERACTIVE USE; MACHINE-READABLE, ENCODED CARDS, NAMELY; TELEPHONE CALLING CARDS, SMART CARDS CONTAINING INTEGRATED CIRCUITS, MAGNETICALLY ENCODED DEBIT, CREDIT AND CASH CARDS; AUDIO AND VIDEO RECORDINGS IN THE FIELD OF TELECOMMUNICATIONS, INFORMATION TECHNOLOGY, SAFETY, NEWS, SPORTS, ENTERTAINMENT, CULTURE, BUSINESS AND FINANCE, WEATHER AND TRAVEL (U.S. CLS. 21, 23, 26, 36 AND 38).

SN 78-029,519. FRAMEWORK TECHNOLOGIES CORPORATION, BURLINGTON, MA. FILED 10-6-2000.

BLUE RUNNER

FOR COMPUTER SOFTWARE FOR CREATING, MANAGING, AND ADMINISTERING PROJECT WEB SITES THAT ALLOW USERS TO COLLABORATE ON PRODUCT DEVELOPMENT PROJECTS OVER THE INTERNET, LOCAL AREA, AND WIDE AREA NETWORKS TO ASSEMBLE AND INTEGRATE PROJECT DATA INFORMATION ACROSS MULTIPLE COMPUTING PLATFORMS, LOCATE INFORMATION, CREATE CUSTOM REPORTS, PROVIDE ARCHIVE AND VERSION CONTROL, SECURE COMMUNICATIONS AND ACCESS CONTROL, TRANSMIT AUTOMATIC CHANGE NOTIFICATIONS, CONDUCT REAL-TIME ONLINE PROJECT REVIEWS, AUTOMATE BUSINESS PROCESSES AND MODELS, AND CUSTOMIZE AND TRACK COLLABORATIVE COMMUNICATIONS, PROJECT CALENDAR AND SCHEDULING, AND PROJECT STATISTICS (U.S. CLS. 21, 23, 26, 36 AND 38).

SN 78-036,156. VEGA GRIESHABER KG, WOLFACH, FED REP GERMANY, FILED 11-21-2000.

SAPPHIRE-CERAMICS

PRIORITY CLAIMED UNDER SEC. 44(D) ON FED REP GERMANY APPLICATION NO. 30054616.5/0, FILED 7-21-2000, REG. NO. 30054616, DATED 7-27-2001, EXPIRES 7-31-2010.

FOR ELECTRIC, ELECTRONIC AND ELECTRO-MECHANICAL MEASURING, SIGNALING AND REGULATION APPARATUS AS WELL AS PARTS OF SUCH APPARATUS, IN PARTICULAR CAPACITIVE CERAMIC PRESSURE MEASURING CELLS, ALL GOODS, AS FAR AS CONTAINED; ELECTRIC, ELECTRONIC AND ELECTRO-MECHANICAL MEASURING, SIGNALING AND REGULATION APPARATUS AS WELL AS PARTS OF SUCH APPARATUS, IN PARTICULAR CAPACITIVE CERAMIC PRESSURE MEASURING CELLS, ALL GOODS, AS FAR AS CONTAINED (U.S. CLS. 21, 23, 26, 36 AND 38).

CLASS 9—(Continued).

SN 78-040,757. REOTEMP INSTRUMENT CORP., SAN DIEGO, CA. FILED 12-27-2000.

REOTEMP

FOR TEMPERATURE AND PRESSURE INSTRUMENTATION, NAMELY PRESSURE GAUGES AND TEMPERATURE GAUGES (U.S. CLS. 21, 23, 26, 36 AND 38).
FIRST USE 11-1-1967; IN COMMERCE 0-0-1967.

SN 78-040,864. CD GARDEN INC., STEVENSON, WA. FILED 12-28-2000.

CD GARDEN

NO CLAIM IS MADE TO THE EXCLUSIVE RIGHT TO USE "CD", APART FROM THE MARK AS SHOWN.
FOR CHILDREN'S EDUCATIONAL SOFTWARE (U.S. CLS. 21, 23, 26, 36 AND 38).

SN 78-042,873. LOADES PLC, EXHALL, COVENTRY, UNITED KINGDOM, FILED 1-12-2001.



FOR ELECTRONIC CONTROL APPARATUS, NAMELY, PROGRAMMABLE CONTROLLERS FOR USE IN THE AUTOMATIC CONTROL OF MECHANICAL AND INDUSTRIAL PROCESSES IN FACTORIES; COMPUTER OPERATING SOFTWARE FOR USE IN PROGRAMMABLE CONTROLLERS (U.S. CLS. 21, 23, 26, 36 AND 38).

SN 78-042,992. VERBALTEK, INC., SANTA CLARA, CA. FILED 1-12-2001.

VIDO

FOR COMPUTER SOFTWARE USED FOR VOICE RECOGNITION AND SPEECH SIGNAL PROCESSING (U.S. CLS. 21, 23, 26, 36 AND 38).

CLASS 9—(Continued).

SN 78-050,561. HART INTERCIVIC, INC., AUSTIN, TX. FILED 2-28-2001.

ROTARY SELECT

NO CLAIM IS MADE TO THE EXCLUSIVE RIGHT TO USE "ROTARY", APART FROM THE MARK AS SHOWN.
FOR ELECTRONIC VOTING MACHINES (U.S. CLS. 21, 23, 26, 36 AND 38).

SN 78-050,654. ABACORE SOFTWARE SOLUTIONS, INC., BOCA RATON, FL. FILED 2-28-2001.

ABACORE

FOR COMPUTER SOFTWARE FOR ENABLING FRONT OFFICE BANKING OPERATIONS, NAMELY, SOFTWARE FOR PROCESSING CHECK PAYMENTS, TRANSFERS, DEPOSITS, SALES AND LOAN CANCELLATION, AND COMPUTER SOFTWARE FOR ENABLING BACK OFFICE OPERATIONS, NAMELY, SOFTWARE FOR BALANCING AND CHECKING FRONT OFFICE OPERATIONS, CLEARING CHECKS, MANAGING NEW AND EXISTING ACCOUNT INFORMATION, PROCESSING CREDIT (U.S. CLS. 21, 23, 26, 36 AND 38).
FIRST USE 5-31-1998; IN COMMERCE 5-31-1998.

SN 78-054,768. BERIK DESIGN USA, INC., WOODSTOCK, GA. FILED 3-23-2001.



OWNER OF U.S. REG. NO. 2,182,409.
FOR MOTORCYCLE, BICYCLE, SPORTS AND SAFETY HELMETS (U.S. CLS. 21, 23, 26, 36 AND 38).
FIRST USE 1-1-1995; IN COMMERCE 1-1-1995.

CLASS 9—(Continued).

SN 78-057,266. MARBLE SPORTSWEAR, INC., BEVERLY HILLS, CA. FILED 4-6-2001.

FABUSA

FOR PRE-RECORDED AUDIO TAPES, CD ROM, DISCS AND VIDEO TAPES FEATURING INFORMATION IN THE FIELDS OF HOBBIES, COLLECTING AND AUCTIONS; COMPUTERS; COMPUTER PERIPHERALS; INTERACTIVE ENTERTAINMENT SOFTWARE, NAMELY, INTERACTIVE VIDEO GAME PROGRAMS, INTERACTIVE MULTIMEDIA COMPUTER GAME PROGRAMS, INTERACTIVE VIDEO GAMES OF VIRTUAL REALITY COMPRISED OF COMPUTER HARDWARE AND SOFTWARE; COMPUTER GAME SOFTWARE; COMPUTER AND VIDEO GAME APPARATUS, NAMELY, VIDEO GAME MACHINES FOR USE WITH TELEVISIONS; TELEPHONES; RADIO TELEPHONES; RADIOS; PRE-RECORDED AUDIO AND VIDEO TAPES FEATURING SCIENCE FICTION FILMS, AND MUSIC; LASER DISCS; DVD DISCS; VIDEO DISCS, PHONOGRAPH RECORDS; COMPACT DISCS; AND CD-ROM'S ALL FEATURING SCIENCE FICTION GAMES, MOTION PICTURE FILMS AND MUSIC; ELECTRONIC CALCULATORS; BATTERIES; SUNGLASSES; CARRYING CASES FOR COMPUTERS, LASER DISCS, DVD DISCS, VIDEO DISCS, PHONOGRAPH RECORDS, COMPACT DISCS AND CD-ROM'S; HEAD PHONES; AUDIO CASSETTE PLAYERS AND RECORDERS; CD-PLAYERS; DVD PLAYERS; MAGNETS; MODEMS; MOUSE PADS; REMOTE CONTROLS FOR RADIOS, TELEVISIONS, AND STEREOS; BLANK VIDEO TAPES; PHOTOGRAPHIC SLIDE TRANSPARENCIES; MAGNETICALLY ENCODED TELEPHONE CALLING CARDS AND TRANSPORTATION FARE CARDS; COMPUTER SOFTWARE FOR USE IN THE SEARCH AND RETRIEVAL OF COMPUTERIZED INFORMATION ON HOBBIES, COLLECTIBLES, AUCTIONS, AND A WIDE VARIETY OF PRODUCTS ACCESSED FROM GLOBAL INFORMATION NETWORKS AND OTHER NETWORK SYSTEMS (U.S. CLS. 21, 23, 26, 36 AND 38).

SN 78-059,251. METACONTROLS, INC., MORRISVILLE, NC. FILED 4-19-2001.

BLOX

FOR COMPUTER SOFTWARE FOR INDUSTRIAL PROCESS CONTROL AND AUTOMATION OF INDUSTRIAL PROCESS CONTROL (U.S. CLS. 21, 23, 26, 36 AND 38).

SN 78-060,798. RESEARCH INSTITUTE, SAN DIEGO, CA. FILED 4-27-2001.

ESANDA
SOFTWARE

NO CLAIM IS MADE TO THE EXCLUSIVE RIGHT TO USE "SOFTWARE", APART FROM THE MARK AS SHOWN. FOR COMPUTER SOFTWARE FOR ACCOUNTING PURPOSES (U.S. CLS. 21, 23, 26, 36 AND 38).
FIRST USE 1-1-2000; IN COMMERCE 7-1-2000.

CLASS 9—(Continued).

SN 78-066,928. VALETTE, BRETT, E., SUPERIOR, CO. AND VANWAGENEN, LITA, K., SUPERIOR, CO. FILED 6-1-2001.

**ACHEBREAK BECAUSE
USING YOUR COMPUTER
SHOULDN'T HURT**

FOR COMPUTER SOFTWARE WHICH FUNCTIONS AS A CUSTOMIZABLE COMBINATION OF A BREAK REMINDER, SCREEN SAVER, AND AN INTERACTIVE EXERCISE PROGRAM, WHICH PROMPTS THE COMPUTER USER AT PREDETERMINED INTERVALS OR AS THE USER SPECIFICS TO PERFORM VARIOUS EXERCISES TO PREVENT REPETITIVE STRESS INJURY (RSI) CAUSED BY COMPUTER USAGE (U.S. CLS. 21, 23, 26, 36 AND 38).

SN 78-068,298. BENNETT, GILLIG ROBERT, SOMERVILLE, MA. FILED 6-9-2001.

LIQUIDSPECS

FOR COMPUTER SOFTWARE USED FOR THE AUTOMATED GENERATION OF TEXTUAL SPECIFICATIONS DOCUMENTS FROM COMPUTER-AIDED DESIGN DRAWING FILES IN THE FIELDS OF ARCHITECTURE AND ENGINEERING (U.S. CLS. 21, 23, 26, 36 AND 38).

SN 78-076,563. IMAGINE THIS, INC., WESTLAND, MI. FILED 7-31-2001.

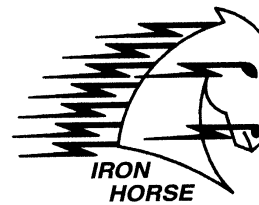

FOR MUSICAL INSTRUMENT AMPLIFIERS, HIGH FIDELITY AUDIO AMPLIFIERS USING VACUUM TUBES AND HEAVY IRON TRANSFORMERS, HIGH FIDELITY PRE-AMPLIFIERS AND HI-FI SPEAKERS (U.S. CLS. 21, 23, 26, 36 AND 38).

SN 78-087,995. MICROSOFT CORPORATION, REDMOND, WA. FILED 10-11-2001.

KAKUTO CHOJIN

THE FOREIGN WORDING IN THE MARK TRANSLATES INTO ENGLISH AS "EXTRAORDINARY FIGHTER".
FOR COMPUTER PROGRAMS, NAMELY, GAME SOFTWARE FOR USE ON COMPUTERS AND VIDEO GAME PLAYERS (U.S. CLS. 21, 23, 26, 36 AND 38).

CLASS 9—(Continued).

SN 78-088,895. NCR CORPORATION, DAYTON, OH. FILED 10-17-2001.

fluidity

FOR ELECTRONIC PROTECTION CARTRIDGE THAT EMITS INDELIBLE INK THAT IS USED FOR PROTECTING MONETARY INSTRUMENTS (U.S. CLS. 21, 23, 26, 36 AND 38).

SN 78-092,492. RYGER TECHNOLOGIES INCORPORATED, PORTSMOUTH, NH. FILED 11-9-2001.



The logo for LincPad features the word "LincPad" in a bold, sans-serif font. To the left of the "L" is a stylized icon consisting of three concentric, semi-circular lines, resembling a signal or a padlock mechanism.

FOR COMPUTER SOFTWARE, INCLUDING CD-ROMS AND DOWNLOADED VERSIONS, WHICH ALLOWS THE ENTRY OF LINE IMAGES, TEXT, SHAPE IMAGES, HANDWRITTEN TEXT, HANDWRITTEN INK, AND PHOTOGRAPH IMAGES ON A WIRELESS COMMUNICATIONS DEVICE TOUCH SCREEN TO BE STORED WITHIN THE COMMUNICATION DEVICE'S MEMORY TO FACILITATE IMAGE VIEWING, PHOTOGRAPH RETOUCHING AND BITMAP CREATION WHICH CAN BE TRANSMITTED BY A DIRECT CONNECTION OR WIRELESS COMMUNICATION TO A DESIGNATED RECEIVING DEVICE THAT IS SELECTED BY THE COMMUNICATION DEVICE USER, AND INSTRUCTION MANUALS SOLD AS A UNIT THEREWITH. (U.S. CLS. 21, 23, 26, 36 AND 38).

SN 78-092,757. LOCKHEED MARTIN CORPORATION, BETHESDA, MD. FILED 11-12-2001.

F-35

FOR RADAR, MISSILE FIRE CONTROL RADAR, AND ELECTRONIC APPARATUS FOR USE IN AIRBORNE RADAR FOR CONTROL OF GUIDED MISSILES AND GUIDED MISSILE LAUNCHERS, NAMELY SENSORS, DETECTORS, PROCESSORS, TRANSMITTERS, ANTENNAS AND DISPLAY SCREENS FOR MISSILE FIRE CONTROL, LAUNCH CONTROL, TARGET ACQUISITION, CLASSIFICATION AND PRIORITIZATION, GUIDANCE AND FLIGHT CONTROL, DETONATION AND IMPACT CONTROL, AND COMPUTER HARDWARE AND COMPUTER SOFTWARE FOR USE IN THE FIELD OF GUIDED MISSILES AND MISSILE LAUNCHERS, AND AVIONIC EQUIPMENT, NAMELY, ALTIMETERS, NAVIGATIONAL HARDWARE, RADIOS AND COMMUNICATION HARDWARE, TRANSPONDERS, DISPLAY SCREENS FOR AIRCRAFT COMMAND AND CONTROL, AND AVIONIC SOFTWARE, AND MULTIMEDIA SOFTWARE RECORDED ON CD-ROM IN THE FIELD OF FIGHTER AIRCRAFT, COMPUTER CARRYING CASES, COMPUTER GAME PROGRAMS, COMPUTER SOFTWARE PROGRAMS FOR FLIGHT SIMULATION, COMPUTER MOUSE PADS, INTERACTIVE VIDEO GAMES OF VIRTUAL REALITY COMPRISED OF COMPUTER HARDWARE AND SOFTWARE (U.S. CLS. 21, 23, 26, 36 AND 38).

CLASS 9—(Continued).

SN 78-093,171. RHINO FITNESS, LLC, SAG HARBOR, NY. FILED 11-14-2001.

THE BIG BLUE BALL THAT DOES IT ALL

FOR PRE-RECORDED AUDIO CASSETTES, VIDEO CASSETTES, VIDEO TAPES AND VIDEO DISCS, AND MULTIMEDIA SOFTWARE RECORDED ON CD-ROMS AND DVDS, ALL FEATURING INFORMATION ON EXERCISES USING A FITNESS BALL (U.S. CLS. 21, 23, 26, 36 AND 38).

SN 78-093,545. NET DIRECT SYSTEMS, LLC, APEX, NC. FILED 11-15-2001.

UNISSENT

FOR COMPUTER SOFTWARE THAT PROVIDES WEB ENABLED ENTERPRISE MANAGEMENT THROUGH A COMBINED SUITE OF MONITORING, MANAGEMENT AND AUTOMATED RESPONSE APPLICATIONS (U.S. CLS. 21, 23, 26, 36 AND 38).

SN 78-093,581. HONEYWELL INTERNATIONAL INC., MORRISTOWN, NJ. FILED 11-15-2001.

REFLECTECH

FOR OPTICAL MIRRORS (U.S. CLS. 21, 23, 26, 36 AND 38).

SN 78-093,832. CH2M HILL, INC., DENVER, CO. FILED 11-16-2001.

GREENPRO

FOR COMPUTER SOFTWARE FOR USE IN MANAGING CONSTRUCTION PROJECTS (U.S. CLS. 21, 23, 26, 36 AND 38).

SN 78-094,602. TENNESSEE SCIENTIFIC, INC., GREENVILLE, SC. FILED 11-21-2001.

AQUATELL

FOR SCIENTIFIC TESTING INSTRUMENTS, NAMELY, INSTRUMENTS FOR TESTING THE COMPOSITION, QUALITY OR CHARACTERISTICS OF WATER; AND INSTRUMENTS FOR TESTING THE COMPOSITION, QUALITY OR CHARACTERISTICS OF FLUIDS, USED IN MEDICAL AND INDUSTRIAL PROCESSES (U.S. CLS. 21, 23, 26, 36 AND 38).

CLASS 9—(Continued).

SN 78-096,350. WIRCA, INC., OVERLAND PARK, KS. FILED 12-3-2001.

POCKETCHANGE

FOR DOWNLOADABLE SOFTWARE FOR USE IN MAKING FINANCIAL TRANSACTIONS WITH A PERSONAL DIGITAL ASSISTANT (U.S. CLS. 21, 23, 26, 36 AND 38).

SN 78-096,439. YEOMANS, CHARLES, LEXINGTON, KY. FILED 12-4-2001.

PAST EFFORTS

FOR COMPUTER SOFTWARE FOR ORGANIZING, FORMATTING, AND STORING IMPORTANT INFORMATION REGARDING LEGAL CITATIONS (U.S. CLS. 21, 23, 26, 36 AND 38).
FIRST USE 9-21-2001; IN COMMERCE 11-30-2001.

SN 78-096,467. R.A. MILLER INDUSTRIES, INC., GRAND HAVEN, MI. FILED 12-4-2001.



OWNER OF U.S. REG. NO. 2,002,849.
FOR ANTENNAS (U.S. CLS. 21, 23, 26, 36 AND 38).
FIRST USE 9-10-1992; IN COMMERCE 9-10-1992.

SN 78-096,842. RANGER ELECTRONIC COMMUNICATIONS, INC., SHULIN, TAIWAN, FILED 12-5-2001.

RATTLER

FOR AMATEUR RADIOS, CITIZEN BAND RADIOS, FREQUENCY COUNTERS, MICROPHONES, ECHO BOARDS (U.S. CLS. 21, 23, 26, 36 AND 38).

CLASS 9—(Continued).

SN 78-096,844. WALLS, DAVID, MATTHEW, BEVERLY, MA. FILED 12-5-2001.

DICEY

FOR INTERACTIVE MULTIMEDIA ENTERTAINMENT GAME SOFTWARE FOR COMPUTERS AND OTHER INTERACTIVE DEVICES (U.S. CLS. 21, 23, 26, 36 AND 38).

SN 78-096,845. RANGER ELECTRONIC COMMUNICATIONS, INC., SHULIN, TAIWAN, FILED 12-5-2001.

COTTONMOUTH

FOR AMATEUR RADIOS, CITIZEN BAND RADIOS, MICROPHONES, FREQUENCY COUNTERS, ECHO BOARDS (U.S. CLS. 21, 23, 26, 36 AND 38).

SN 78-096,847. GROUP 8760 LLC, BIRMINGHAM, AL. FILED 12-5-2001.

NAESBAGENT

FOR COMPUTER SOFTWARE FOR ELECTRONIC DATA TRANSMISSION USING AN INTERNET BROWSER AS USER INTERFACE (U.S. CLS. 21, 23, 26, 36 AND 38).

CLASS 10—MEDICAL APPARATUS

SN 75-726,010. UNITED STATES SURGICAL CORPORATION, NORWALK, CT. FILED 6-10-1999.

TOPGUN

FOR SURGICAL DEVICES, NAMELY COLLIMATORS, PROBES AND HANDPIECES FOR USE IN SURGICAL LOCALIZATION OF RADIO LABELED TISSUE AND PARTS AND ATTACHMENTS THEREFOR (U.S. CLS. 26, 39 AND 44).
FIRST USE 8-5-1999; IN COMMERCE 8-5-1999.

SN 75-815,867. NONIN MEDICAL, INC., PLYMOUTH, MN. FILED 10-5-1999.

PURE LIGHT

NO CLAIM IS MADE TO THE EXCLUSIVE RIGHT TO USE "LIGHT", APART FROM THE MARK AS SHOWN.
FOR PULSE OXIMETERS (U.S. CLS. 26, 39 AND 44).

CLASS 10—(Continued).

SN 75-834,321. BECKMAN COULTER, INC., FULLERTON, CA. FILED 10-29-1999.



FOR MEDICAL DIAGNOSTIC DEVICES, INSTRUMENTS AND APPARATUS USED IN CONNECTION WITH PATIENTS FOR SEPARATING, DETECTING, ANALYZING, TRANSPORTING, MONITORING, AND MEASURING MATERIALS IN FLUID AND SOLID PATIENT MATERIALS AND PARTS THEREFOR; AND DATA COLLECTING, ANALYZING, COMPUTING AND CALCULATING APPARATUS AND PARTS THEREFOR FOR USE IN SUCH MEDICAL DIAGNOSTIC DEVICES (U.S. CLS. 26, 39 AND 44).

SN 75-897,790. COOK INCORPORATED, BLOOMINGTON, IN. FILED 1-18-2000.

LOGIC

FOR MEDICAL DEVICE, NAMELY, A CORONARY STENT (U.S. CLS. 26, 39 AND 44).

SN 76-061,899. NEW OPTIONS SPORTS INC., DALLAS, TX. FILED 6-2-2000.

KID STUFF

NO CLAIM IS MADE TO THE EXCLUSIVE RIGHT TO USE "KID", APART FROM THE MARK AS SHOWN.

FOR ORTHOPEDIC, PROSTHETIC, ATHLETIC AND SURGICAL APPLIANCES, NAMELY, KNEE BRACES, KNEE SUPPORTS, ANKLE BRACES, ANKLE SUPPORTS, ELBOW SUPPORTS, BACK SUPPORTS, WRIST SUPPORTS, AND ORTHODIC AND PROSTHETIC SUSPENSION SLEEVES (U.S. CLS. 26, 39 AND 44).

CLASS 10—(Continued).

SN 76-062,182. GMP COMPANIES, INC., FORT LAUDERDALE, FL. FILED 6-2-2000.



FOR MEDICAL AND SURGICAL APPARATUS, DEVICES, INSTRUMENTS AND ARTICLES, NAMELY - SURGICAL FLUID WARMERS; SURGICAL HAND TOOLS, NAMELY LIGHTS FOR FORCEPS; FRAMES FOR JOINING AND COORDINATING ENDOSCOPES AND LAPAROSCOPIC SURGICAL INSTRUMENTS; MEDICAL STENTS; WIRELESS SENSORS FOR DETECTING VITAL SIGNS; CARDIOVASCULAR DIAGNOSTIC APPARATUS; HEMOSTAIS VALVES; VASCULAR MANIFOLDS; GLAUCOMA SURGICAL IMPLANTS (U.S. CLS. 26, 39 AND 44).

SN 76-063,896. IMPELLA CARDIOTECHNIK AG, 52074 AACHEN, FED REP GERMANY, FILED 6-6-2000.

icc
Intra corporeal circulation

PRIORITY CLAIMED UNDER SEC. 44(D) ON FED REP GERMANY APPLICATION NO. 39981646.1/1. FILED 12-23-1999, REG. NO. 39981646, DATED 12-23-1999, EXPIRES 12-31-2009.

NO CLAIM IS MADE TO THE EXCLUSIVE RIGHT TO USE "INTRA CORPOREAL CIRCULATION", APART FROM THE MARK AS SHOWN.

FOR CARDIAC SUPPORT PUMPS, BLOOD PUMPS (U.S. CLS. 26, 39 AND 44).

SN 76-085,035. ISOTRON, INC., ALPHARETTA, GA. FILED 7-7-2000.

ISOTRON

FOR MEDICAL DEVICE AND APPARATUS, NAMELY, BRACHYTHERAPY RADIATION SYSTEM FOR CANCER TREATMENT COMPRISED OF A RADIATION SOURCE, REMOTE AFTERLOADER, CATHETER AND COMPUTER SOFTWARE USED TO DIAGNOSE AND TREAT CANCER (U.S. CLS. 26, 39 AND 44).

CLASS 10—(Continued).

SN 76-097,363. WILLIAM COOK EUROPE A/S, DK-4632 BJAEVERSKOV, DENMARK, FILED 7-26-2000.

SAGITTA

PRIORITY CLAIMED UNDER SEC. 44(D) ON DENMARK APPLICATION NO. VA20000613, FILED 2-10-2000, REG. NO. VR200001879, DATED 4-13-2000, EXPIRES 4-13-2010.

FOR SURGICAL, MEDICAL, DENTAL AND VETERINARY APPARATUS AND INSTRUMENTS, NAMELY DIAGNOSTIC AND THERAPEUTIC APPARATUS AND INSTRUMENTS FOR SURGICAL AND RADIOLOGICAL USE, NAMELY MEDICAL GUIDEWIRES (U.S. CLS. 26, 39 AND 44).

SN 76-102,754. MICRONET MEDICAL, INC., WHITE BEAR LAKE, MN. FILED 8-3-2000.

AXXESS

FOR PERCUTANEOUS SPINAL CORD STIMULATION LEAD FOR PAIN MANAGEMENT (U.S. CLS. 26, 39 AND 44).

SN 76-110,531. JOSTRA AG, D-72145 HIRRLINGEN, FED REP GERMANY, FILED 8-16-2000.

QUART

PRIORITY CLAIMED UNDER SEC. 44(D) ON ERPN CMNTY TM OFC APPLICATION NO. 001721398, FILED 6-23-2000, REG. NO. 001721398, DATED 6-20-2001, EXPIRES 6-20-2011.

FOR BLOOD FILTER (U.S. CLS. 26, 39 AND 44).

SN 76-127,623. CBYON, INC., PALO ALTO, CA. FILED 9-12-2000.

VIRTUSCOPE

FOR MEDICAL DISPLAY DEVICE AND CONTROLS THEREFOR USED FOR VISUALIZATION OF A PATIENT'S ANATOMY; AND MEDICAL AND SURGICAL APPARATUS, NAMELY AN AUGMENTED DISPLAY TOOL TO OVERLAY PATIENT INFORMATION AS OBTAINED FROM PATIENT'S IMAGING DATA ON TOP OF PATIENT'S PHYSICAL ANATOMY (U.S. CLS. 26, 39 AND 44).

CLASS 10—(Continued).

SN 76-135,623. WRIGHT MEDICAL TECHNOLOGY, INC., ARLINGTON, TN. FILED 9-27-2000.

LINEAGE

FOR MEDICAL APPARATUS, NAMELY, ORTHOPEDIC IMPLANT AND RELATED SURGICAL INSTRUMENTATION FOR USE IN ORTHOPEDIC SURGERY (U.S. CLS. 26, 39 AND 44).

FIRST USE 12-27-2000; IN COMMERCE 12-27-2000.

SN 76-138,113. LIFE INSTRUMENT CORPORATION, BRAINTREE, MA. FILED 9-29-2000.

ZELPI

FOR TOOLS, NAMELY SURGICAL PLIERS (U.S. CLS. 26, 39 AND 44).

FIRST USE 1-0-1996; IN COMMERCE 1-0-1996.

SN 76-141,969. HEAT SHIELD, INC., NEW ROCHELLE, NY. FILED 10-5-2000.

CHILLIT

FOR DENTAL REFRIGERANT DELIVERY SYSTEMS CONSISTING PRIMARILY OF COTTON SWAB DISPENSERS AND TETRA FLOUROETHANE SPRAYS (U.S. CLS. 26, 39 AND 44).

SN 76-141,970. HEAT SHIELD, INC., NEW ROCHELLE, NY. FILED 10-5-2000.

COOLIT

FOR DENTAL REFRIGERANT DELIVERY SYSTEMS CONSISTING PRIMARILY OF COTTON SWAB DISPENSERS AND TETRA FLOUROETHANE SPRAYS (U.S. CLS. 26, 39 AND 44).

SN 76-143,435. DANIELS CORPORATION, THE, DANDE-NONG, SOUTH VIC, AUSTRALIA, FILED 10-5-2000.

**BRILLIANT TECHNOLOGY,
EXCEPTIONAL VALUE**

FOR MEDICAL APPARATUS, NAMELY, SHARPS CONTAINERS, FOR DISPOSAL OF MEDICAL WASTE (U.S. CLS. 26, 39 AND 44).

CLASS 10—(Continued).

SN 76-147,210. KRUPS GMBH, SOLINGEN, FED REP GERMANY, FILED 10-16-2000.

KRUPS

OWNER OF FED REP GERMANY REG. NO. 30033380.3, DATED 8-31-2000, EXPIRES 5-31-2010.

FOR AEROSOL SPRAY DEVICES SOLD EMPTY FOR MEDICAL APPLICATIONS; HOT-AIR VIBRATION APPLIANCES FOR MEDICAL APPLICATIONS; BABY BOTTLES; ELECTRICAL DENTAL DEVICES, NAMELY, POLISHERS; PROBES FOR MEDICAL PURPOSES; BLOOD-PRESSURE MEASURING DEVICES; THERMOMETERS FOR MEDICAL USE; VIBRATING MASSAGE DEVICES; COSMETIC MASSAGE DEVICES; INHALERS SOLD EMPTY; LASERS FOR MEDICAL APPLICATIONS AND MASSAGE DEVICES (U.S. CLS. 26, 39 AND 44).

SN 76-148,037. VESTIBULAR TECHNOLOGIES INC., SCOTTSDALE, AZ. FILED 10-17-2000.

BALANCETRAK

OWNER OF U.S. REG. NO. 2,336,742.
FOR DIAGNOSTIC EQUIPMENT, NAMELY, COMPUTER HARDWARE, MONITOR AND SOFTWARE AND A SENSING PLATFORM, CABLING AND EQUILIBRIUM DISTURBING FOAM, AND PATIENT SUPPORT STRUCTURE, HARNESS AND SHOULDER STRAPS, FOR MEASURING SWAY, RANGE OF MOTION, AND LIMITS OF STABILITY OF PERSONS SUFFERING FROM DIZZINESS AND BALANCE DISORDERS (U.S. CLS. 26, 39 AND 44).

SN 76-162,147. GETINGE/CASTLE, INC., ROCHESTER, NY. FILED 11-9-2000.

EZ-VU

FOR MEDICAL DEVICE IN THE NATURE OF BIOLOGICAL INDICATORS FOR USE IN MONITORING STEAM AND ETHYLENE OXIDE STERILIZATION CYCLES FOR CLINICAL MEDICAL USE (U.S. CLS. 26, 39 AND 44).

SN 76-164,416. COOLTOUCH CORPORATION, ROSEVILLE, CA. FILED 11-7-2000.

PEARL

FOR MEDICAL LASERS, AND DERMATOLOGICAL DEVICES AND ASSOCIATED SYSTEMS, NAMELY, LASER ENERGY DELIVERY HANDPIECES AND LASER ENERGY DELIVERY HANDPIECES WITH CRYOGENIC COOLING CAPABILITY (U.S. CLS. 26, 39 AND 44).

CLASS 10—(Continued).

SN 76-166,694. AIR FORCE INC, HOLLAND, MI. FILED 11-10-2000.

DENTAL AIR FORCE

NO CLAIM IS MADE TO THE EXCLUSIVE RIGHT TO USE "DENTAL", APART FROM THE MARK AS SHOWN.

FOR HOME DENTAL CLEANING SYSTEM FOR CLEANING ORAL CAVITIES CONSISTING PRIMARILY OF HAND-HELD DENTAL INSTRUMENTS THAT UTILIZE AIR TECHNOLOGY (U.S. CLS. 26, 39 AND 44).
FIRST USE 9-1-1999; IN COMMERCE 9-1-1999.

SN 76-172,975. HILL-ROM SERVICES, INC., BATESVILLE, IN. FILED 11-30-2000.

ONESTEP

FOR FOOT SUPPORT SOLD AS A COMPONENT OF A BIRTHING BED AND USER MANUALS PROVIDED IN CONNECTION THEREWITH (U.S. CLS. 26, 39 AND 44).
FIRST USE 8-1-2000; IN COMMERCE 8-1-2000.

SN 76-173,875. J.C.E.C. COMPANY, INC., KENDALL PARK, NJ. FILED 12-1-2000.

**DILAPAN-S**

THE MARK COMPRISES A HYPHENATED PRINTED WORD ACCOMPANIED BY A TULIP-SHAPED DESIGN ENCASED IN A CIRCLE.
FOR CERVICAL DILATORS (U.S. CLS. 26, 39 AND 44).

SN 76-179,352. KING, JOHN, MIDLOTHIAN, VA. FILED 12-12-2000.

DISTRAX

FOR DENTAL DEVICES, NAMELY DISTRACTORS (U.S. CLS. 26, 39 AND 44).
FIRST USE 8-0-1999; IN COMMERCE 8-0-1999.

CLASS 10—(Continued).

SN 76-180,119. LASERSURGE, INC., DBA LSI SOLUTIONS, ROCHESTER, NY. FILED 12-13-2000.

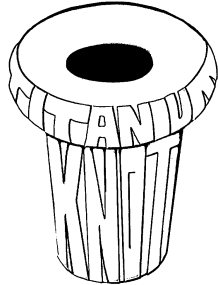

NO CLAIM IS MADE TO THE EXCLUSIVE RIGHT TO USE "TITANIUM", APART FROM THE MARK AS SHOWN. FOR TITANIUM FERRULES FOR SURGICAL SUTURING APPLICATIONS (U.S. CLS. 26, 39 AND 44).

SN 76-186,735. CARDIAC PACEMAKERS, INC., ST. PAUL, MN. FILED 12-27-2000.

RHYTHM ID

NO CLAIM IS MADE TO THE EXCLUSIVE RIGHT TO USE "RHYTHM", APART FROM THE MARK AS SHOWN. FOR MEDICAL EQUIPMENT IN THE NATURE OF PROGRAMMERS FOR IMPLANTABLE CARDIAC RHYTHM DEVICES, NAMELY, PACEMAKERS, DEFIBRILLATORS AND CARDIOVERTERS (U.S. CLS. 26, 39 AND 44).

SN 76-190,632. RICHARDSON ELECTRONICS, LTD., LA-FOX, IL. FILED 1-8-2001.

X-ELITEC

FOR MEDICAL EQUIPMENT, NAMELY, DIAGNOSTIC X-RAY APPARATUS (U.S. CLS. 26, 39 AND 44).

SN 76-197,000. BIOPATE, INC., LOS ANGELES, CA. FILED 1-22-2001.

MAXFAX

FOR CRANIOMAXILLOFACIAL BONE FIXATION SYSTEMS AND DEVICES NAMELY CLIPS, PLATES AND SCREWS IMPLANTABLE IN THE SKULL (U.S. CLS. 26, 39 AND 44). FIRST USE 12-20-2000; IN COMMERCE 12-20-2000.

CLASS 10—(Continued).

SN 76-203,140. WIDEX APS, 35 VAERLOSE, DENMARK, FILED 2-1-2001.

SENSODIVA

PRIORITY CLAIMED UNDER SEC. 44(D) ON DENMARK APPLICATION NO. 200003324. FILED 8-7-2000. REG. NO. VR200004565, DATED 1-29-2001, EXPIRES 1-29-2010. FOR HEARING AIDS FOR THE DEAF AS WELL AS PARTS AND FITTINGS THEREFOR (U.S. CLS. 26, 39 AND 44).

SN 76-212,320. HOU-SE MEDICAL INC., TAIPEI, TAIWAN, FILED 2-20-2001.



THE DESIGN IN THE MARK CONSISTS OF THE REPRESENTATION OF A SYRINGE WITHIN A CIRCLE. FOR BLOOD DRAWING APPARATUS; BLOOD FILTERS; CANNULAE; CATHETERS; HYPODERMIC AND MEDICAL NEEDLES AND SYRINGES; INFUSION AND TRANSFUSION SETS; INTRAVENOUS FEEDING TUBES; MEDICAL STENTS; MEDICAL TREATMENT APPAREL; MEDICAL TUBING FOR USE IN ADMINISTERING DRUGS, DRAINAGE AND TRANSFUSION; RADIOLOGICAL APPARATUS FOR MEDICAL PURPOSES; VASCULAR ACCESS PORTS FOR MEDICAL USE (U.S. CLS. 26, 39 AND 44).

SN 76-215,670. SENSORMEDICS CORPORATION, YORBA LINDA, CA. FILED 2-23-2001.



FOR MEDICAL DEVICE, NAMELY, TONGUE POSITIONING MOUTHPIECE (U.S. CLS. 26, 39 AND 44).

SN 76-216,947. LES PRODUITS ASSOCIES LPA-BROXO S.A., GENEVE, SWITZERLAND, FILED 2-27-2001.

ORGASMALE

FOR HAND-HELD VIBRATOR FOR THERAPEUTIC USE IN BODY MASSAGE AND STIMULATION AND ATTACHMENTS THEREFOR (U.S. CLS. 26, 39 AND 44).

CLASS 10—(Continued).

SN 76-219,945. TAGA MEDICAL TECHNOLOGIES, INC., MENTOR, OH. FILED 3-6-2001.

VELOCITY

FOR HUMIDIFIERS (U.S. CLS. 26, 39 AND 44).

SN 76-229,224. RUCH ORTHOTIC LAB, INC., PEKIN, IL. FILED 3-26-2001.

BLUE GOO

FOR PRESCRIPTION ORTHOTIC FOOTWEAR INSERTS DESIGNED FOR TREATMENT OF PLANTAR KERATOSES AND PLANTAR ULCERATION IN PATIENTS WITH DIABETES OR RHEUMATOID ARTHRITIS (U.S. CLS. 26, 39 AND 44).
FIRST USE 11-28-1995; IN COMMERCE 1-3-1996.

SN 76-233,163. TUTTNAUER USA CO. LTD., HAUPPAUGE, NY. FILED 4-2-2001.

VALUE KLAVE

FOR STEAM AUTOCLAVES FOR STERILIZING SURGICAL INSTRUMENTS (U.S. CLS. 26, 39 AND 44).

SN 76-260,863. VASCULAR CONTROL SYSTEMS, INC., SAN JUAN CAPISTRANO, CA. BY CHANGE OF NAME HYSTERX, INC., SAN JUAN CAPISTRANO, CA. FILED 5-23-2001.

INTELLI-CLIP

FOR MEDICAL PRODUCTS, NAMELY, VASCULAR OCCLUSION CLIPS (U.S. CLS. 26, 39 AND 44).

SN 76-275,710. HEARX, LTD., WEST PALM BEACH, FL. FILED 6-21-2001.

InTouch

OWNER OF U.S. REG. NO. 1,704,188.
FOR HEARING AIDS (U.S. CLS. 26, 39 AND 44).
FIRST USE 12-0-2000; IN COMMERCE 12-0-2000.

CLASS 10—(Continued).

SN 76-313,105. KINAMED, INC., CAMARILLO, CA. FILED 9-10-2001.

IMAGE FREE

NO CLAIM IS MADE TO THE EXCLUSIVE RIGHT TO USE "IMAGE", APART FROM THE MARK AS SHOWN.
FOR SURGICAL NAVIGATION SYSTEMS THAT PRECISELY LOCATE AND ORIENT SURGICAL INSTRUMENTS, IMPLANTS AND PATIENT ANATOMY, RELATIVE TO ONE ANOTHER, UTILIZING POSITIONAL MARKERS AND MODELING SOFTWARE (U.S. CLS. 26, 39 AND 44).

SN 76-333,744. HOMEDICS, INC., COMMERCE TOWNSHIP, MI. FILED 11-2-2001.

TRUE HEAT

NO CLAIM IS MADE TO THE EXCLUSIVE RIGHT TO USE "HEAT", APART FROM THE MARK AS SHOWN.
FOR MASSAGING FOOT BATH APPARATUS (U.S. CLS. 26, 39 AND 44).

SN 76-340,819. HORIZON MEDICAL PRODUCTS, INC., ATLANTA, GA. FILED 11-21-2001.

LIFEVALVE

FOR CATHETERS (U.S. CLS. 26, 39 AND 44).

SN 76-346,650. CONMED CORPORATION, UTICA, NY. FILED 12-10-2001.

ABCSNARE

OWNER OF U.S. REG. NOS. 1,565,724 AND 2,529,158.
FOR ENDOSCOPIC SURGICAL PRODUCTS, NAMELY, MULTIFUNCTIONAL POLYPECTOMY SNARES FOR GASTROENTEROLOGY AND GASTROINTESTINAL SURGERY (U.S. CLS. 26, 39 AND 44).

CLASS 10—(Continued).

SN 78-033,290. SOPHYSA, ORSAY, FRANCE, FILED 11-1-2000.

PRESSIO

PRIORITY CLAIMED UNDER SEC. 44(D) ON FRANCE APPLICATION NO. 003026259, FILED 5-5-2000, REG. NO. 003026259, DATED 5-5-2000, EXPIRES 5-5-2010.

FOR SURGICAL AND MEDICAL INSTRUMENTS, NAMELY, AN EXTERNAL CONTROL AND MONITORING DEVICE IN THE NATURE OF A MICROCOMPUTER AND A DIGITAL DISPLAY, AN IMPLANTABLE VENTRICULAR CATHETER INCLUDING A PRESSURE DETECTOR, AND CABLES CONNECTING THE CATHETER TO THE MONITORING DEVICE FOR MEASURING INTRACRANIAL PRESSURE SOLD AS A UNIT (U.S. CLS. 26, 39 AND 44).

SN 78-043,550. MEDTRONIC SURGICAL NAVIGATION TECHNOLOGIES, INC., MEMPHIS, TN. FILED 1-17-2001.

FAZER

FOR NEUROLOGICAL CONTOUR LASER THAT COLLECTS DATA ABOUT A PATIENT'S ANATOMY (U.S. CLS. 26, 39 AND 44).

SN 78-046,476. INNOTECH MEDICAL SOLUTIONS INC., VANCOUVER, BC, CANADA, FILED 2-4-2001.

TUBESAFE

FOR MEDICAL DEVICE, NAMELY, AN ENTERAL TUBE RETAINER (U.S. CLS. 26, 39 AND 44).
FIRST USE 1-15-2001; IN COMMERCE 1-29-2001.

SN 78-081,861. DOCTORS RESEARCH GROUP, INC., PLYMOUTH, CT. FILED 8-30-2001.

LOCKTOOTH

FOR MEDICAL DEVICE FOR THE STABILIZATION OF THE JAW, NAMELY AN ALVEOLAR SPLINT (U.S. CLS. 26, 39 AND 44).

CLASS 10—(Continued).

SN 78-087,527. GUINOT, PARIS, FRANCE, FILED 10-9-2001.

HYDRADERM

FOR FACIAL AND BODY TONING, FIRING, HYDRATING, SMOOTHING, REGENERATING, AND OXYGENATING MACHINES FOR COSMETIC PURPOSES, FOR USE ALONE OR WITH TOPICALLY APPLIED COSMETICS; ELECTRICAL MASSAGE APPARATUS, NAMELY SKIN AND FACE MASSAGERS; ELECTRONIC STIMULATORS FOR THE FACE AND SKIN; FACIAL TONING MACHINES FOR COSMETIC USE, NAMELY, ELECTRICAL MACHINES USED TO TREAT ACNE AND SKIN BLEMISHES (U.S. CLS. 26, 39 AND 44).

FIRST USE 0-0-1977; IN COMMERCE 0-0-1977.

SN 78-093,689. W. L. GORE & ASSOCIATES, INC., NEWARK, DE. FILED 11-16-2001.

VIABIL

FOR ENDOLUMINAL PROSTHESES (U.S. CLS. 26, 39 AND 44).

SN 78-094,594. BIOCURE, INC., NORCROSS, GA. FILED 11-21-2001.

CHEMOSPHERES

FOR EMBOLIC DEVICES FOR OCCLUDING BLOOD VESSELS AND FOR TREATING VASCULATURE MALFORMATIONS SUCH AS ARTERIOVENOUS MALFORMATIONS, ANEURYSMS, AND FISTULAS (U.S. CLS. 26, 39 AND 44).

SN 78-094,596. BIOCURE, INC., NORCROSS, GA. FILED 11-21-2001.

CHEMOGEL

FOR EMBOLIC DEVICES FOR OCCLUDING BLOOD VESSELS AND FOR TREATING VASCULATURE MALFORMATIONS SUCH AS ARTERIOVENOUS MALFORMATIONS, ANEURYSMS, AND FISTULAS (U.S. CLS. 26, 39 AND 44).

CLASS 11—ENVIRONMENTAL CONTROL APPARATUS

CLASS 11—(Continued).

SN 74-216,032. ZELCO INDUSTRIES, INC., MOUNT VERNON, NY. FILED 10-28-1991.

SUPERMATCH

FOR LIGHTERS FOR BARBECUES, FIREPLACES, GAS OVENS, WOOD STOVES AND OTHER PRODUCTS WHICH REQUIRE A LONG-REACHING FLAME SOURCE (U.S. CL. 8).

FIRST USE 1-1-1980; IN COMMERCE 1-1-1980.

SN 75-852,667. ELNARI INTERNATIONAL, INC., TORRANCE, CA. FILED 11-18-1999.



OWNER OF U.S. REG. NO. 1,831,252. FOR HALOGEN LIGHT BULBS (U.S. CLS. 13, 21, 23, 31 AND 34).

FIRST USE 7-0-1997; IN COMMERCE 7-0-1997.

SN 75-869,468. SEMCO INCORPORATED, COLUMBIA, MO. FILED 12-11-1999.

INTELLIGENT ENGINEERING

FOR VENTILATION SYSTEMS, NAMELY HVAC UNITS (U.S. CLS. 13, 21, 23, 31 AND 34).

SN 75-871,360. TELEDYNE LIGHTING AND DISPLAY PRODUCTS, INC., HAWTHORNE, CA. FILED 12-14-1999.

BANDLIGHT

FOR BACKLIGHT ILLUMINATORS, DECORATIVE LIGHTING, LINEAR LIGHTING AND COMMERCIAL, INDUSTRIAL AND RESIDENTIAL ELECTRICAL LIGHTING FIXTURES FOR GENERAL ILLUMINATION (U.S. CLS. 13, 21, 23, 31 AND 34).

CLASS 11—(Continued).

SN 75-871,474. KAYAK POOL CORPORATION, WEST SENECA, NY. BY CHANGE OF NAME NEW KAYAK POOL CORPORATION, THE, WEST SENECA, NY. FILED 12-14-1999.



OWNER OF U.S. REG. NO. 1,833,560. NO CLAIM IS MADE TO THE EXCLUSIVE RIGHT TO USE "POOLS", APART FROM THE MARK AS SHOWN.

FOR FILTRATION SYSTEMS, NAMELY, DRAINS, WALL SKIMMERS, FILTERS, AND PUMPS SOLD IN COMBINATION AND REPLACEMENT PARTS, FOR USE IN RECTANGULAR ABOVE-GROUND METAL SWIMMING POOLS (U.S. CLS. 13, 21, 23, 31 AND 34).

FIRST USE 12-21-1994; IN COMMERCE 12-21-1994.

SN 75-889,440. KOMEX H2O SCIENCE INC, HUNTINGTON BEACH, CA. FILED 1-5-2000.

SOLARREM

FOR SOLAR POWERED WASTE WATER PURIFICATION UNITS (U.S. CLS. 13, 21, 23, 31 AND 34).

FIRST USE 11-16-1999; IN COMMERCE 11-16-1999.

SN 75-892,558. DEC-E-TECH, INC., TYNGSBOROUGH, MA. FILED 1-7-2000.

TURBOSOLVE

FOR INDUSTRIAL DRYERS USED FOR PRINTING, COATING, LAMINATING, PAINTING AND PAPER MAKING (U.S. CLS. 13, 21, 23, 31 AND 34).

FIRST USE 0-0-1993; IN COMMERCE 0-0-1993.

SN 75-902,745. SOLAR AIR, INC., KANSAS CITY, MO. FILED 1-26-2000.

SOLAR AIR

NO CLAIM IS MADE TO THE EXCLUSIVE RIGHT TO USE "SOLAR", APART FROM THE MARK AS SHOWN.

FOR ULTRAVIOLET GERMICIDAL LIGHT FIXTURES (U.S. CLS. 13, 21, 23, 31 AND 34).

FIRST USE 8-1-1999; IN COMMERCE 9-1-1999.

CLASS 11—(Continued).

SN 76-009,893. SCHAEFER VENTILATION EQUIPMENT, LLC, WAITE PARK, MN. FILED 3-24-2000.



FOR ELECTRIC COOLING FANS AND ELECTRIC MISTING VAPORIZERS THEREFOR (U.S. CLS. 13, 21, 23, 31 AND 34).
FIRST USE 5-19-2000; IN COMMERCE 5-19-2000.

SN 76-050,328. CFM MAJESTIC INC., MISSISSAUGA, ONTARIO L5T 2N1, CANADA, FILED 5-15-2000.



OWNER OF CANADA REG. NO. 411140, DATED 4-16-1993, EXPIRES 4-16-2008.

OWNER OF U.S. REG. NO. 1,953,570.
FOR FIREPLACE DECORATIVE TRIM FOR FIREPLACES AND FIREPLACE INSERTS; ARTIFICIAL GAS FIREPLACE LOGS AND ARTIFICIAL GAS FIREPLACE LOG SETS CONSISTING OF CERAMIC LOGS AND A GAS BURNER; FIREPLACE COMPONENTS, NAMELY VENTS, PIPES AND CERAMIC REFRACTORY LINERS (U.S. CLS. 13, 21, 23, 31 AND 34).
FIRST USE 2-22-1993; IN COMMERCE 0-0-1997.

SN 76-066,581. FRIEDRICH GROHE AG & CO.KG, D-58653 HEMER, FED REP GERMANY, FILED 5-30-2000.

BROWSER

FOR ELECTRIC LIGHTING FIXTURES; PLUMBING FITTINGS, NAMELY, WATER VALVES AND WATER MIXING VALVES, AND PARTS THEREFOR; WATER FAUCETS, WATER MIXERS, AND WATER MIXING FAUCETS, AND PARTS THEREFOR; SHOWERS, HAND SHOWERS, HAND SPRAYS, SIDE SHOWERS, HEAD SHOWERS, SHOWER HEADS, AND PARTS THEREFOR; SHOWER RAILS, SHOWER BARS, BATHTUB GRIPS; SHOWER HOSES; HAND SHOWER AND HAND SPRAY HOLDERS; SHOWER SETS SOLD AS A UNIT WHICH INCLUDE A SHOWER RAIL, SHOWER HOSE, AND HAND SHOWER, AND PARTS THEREFOR (U.S. CLS. 13, 21, 23, 31 AND 34).

CLASS 11—(Continued).

SN 76-168,333. W.C. BRADLEY COMPANY, COLUMBUS, GA. FILED 11-20-2000.

OKLAHOMA JOE'S

FOR BARBECUE GRILLS AND SMOKER GRILLS (U.S. CLS. 13, 21, 23, 31 AND 34).
FIRST USE 7-0-1993; IN COMMERCE 7-0-1993.

SN 76-186,258. VECTOR PRODUCTS, INC., FT. LAUDERDALE, FL. FILED 12-27-2000.

FISH-EYE

FOR FLASHLIGHTS AND PEN LIGHTS (U.S. CLS. 13, 21, 23, 31 AND 34).
FIRST USE 10-23-2000; IN COMMERCE 10-23-2000.

SN 76-192,548. APM, INC., ST. LOUIS, MO. FILED 1-11-2001.

LAIRD TECHNOLOGIES

NO CLAIM IS MADE TO THE EXCLUSIVE RIGHT TO USE "TECHNOLOGIES", APART FROM THE MARK AS SHOWN.

FOR ELECTROLUMINESCENT LAMPS (U.S. CLS. 13, 21, 23, 31 AND 34).

SN 76-193,540. HUNTER FAN COMPANY, MEMPHIS, TN. FILED 1-15-2001.

THE CASCADE

OWNER OF U.S. REG. NO. 1,541,443.
FOR OUTDOOR PATIO FAN MOUNTS FOR CEILING FANS (U.S. CLS. 13, 21, 23, 31 AND 34).

SN 76-193,730. RIVAL COMPANY, THE, KANSAS CITY, MO. FILED 1-16-2001.

BREEZEBALL

FOR ELECTRIC FANS (U.S. CLS. 13, 21, 23, 31 AND 34).

SN 76-201,483. ALFA LAVAL INC., KENOSHA, WI. FILED 1-29-2001.

COMPACOIL

FOR HEAT EXCHANGERS (U.S. CLS. 13, 21, 23, 31 AND 34).

CLASS 11—(Continued).

SN 76-206,322. ZHONGDA GROUP (U.S.A.), INC., CITY OF INDUSTRY, CA. FILED 2-8-2001.



THE MARK CONSISTS TWO PARTS: WORD OF "ZON-DA" AND DESIGN OF "Z".
FOR DRYING APPARATUS, NAMELY PAINT DRY-ING MACHINES (U.S. CLS. 13, 21, 23, 31 AND 34).
FIRST USE 7-0-1986; IN COMMERCE 7-0-1986.

SN 76-237,746. INSULATION SOURCES, INC., PALO ALTO, CA. FILED 4-10-2001.

MINI HEAT GUN II

NO CLAIM IS MADE TO THE EXCLUSIVE RIGHT TO USE "MINI HEAT GUN", APART FROM THE MARK AS SHOWN.
FOR HOT AIR BLOWER (U.S. CLS. 13, 21, 23, 31 AND 34).
FIRST USE 11-1-1999; IN COMMERCE 11-1-1999.

SN 76-239,451. HENNY PENNY CORPORATION, EATON, OH. FILED 4-11-2001.

SMARTHOLD

FOR ELECTRIC CABINETS USED TO CONTROL TEMPERATURE AND HUMIDITY FOR HEATING AND PROOFING FOOD GOODS (U.S. CLS. 13, 21, 23, 31 AND 34).

SN 76-240,829. T.F.H. PUBLICATIONS, INC., NEPTUNE CITY, NJ. FILED 4-13-2001.

ECO-BALANCE AQUARIUM FILTER

NO CLAIM IS MADE TO THE EXCLUSIVE RIGHT TO USE "AQUARIUM FILTER", APART FROM THE MARK AS SHOWN.
FOR AQUARIUM FILTERS (U.S. CLS. 13, 21, 23, 31 AND 34).

CLASS 11—(Continued).

SN 76-247,514. COOKTEK, LLC, CHICAGO, IL. FILED 4-30-2001.



OWNER OF U.S. REG. NOS. 2,072,566 AND 2,121,602.
FOR PIZZA THERMAL DELIVERY SYSTEM COM-PRISING A THERMAL INSULATED CARRIER FOR PIZZA WITH AN INDUCTION HEATING ELEMENT COMPONENT FOR USE WITH AND INDUCTION COOKTOP (U.S. CLS. 13, 21, 23, 31 AND 34).
FIRST USE 7-0-1999; IN COMMERCE 7-0-1999.

SN 76-261,635. GOLIGHT, INC., CULBERTSON, NE. FILED 5-23-2001.

CR5PENTABEAM

FOR ELECTRIC LIGHT BULBS AND LIGHT REFLEC-TORS; ELECTRIC LIGHT BULBS, LIGHT REFLECTORS AND SEARCH LIGHTS, SOLD AS A UNIT (U.S. CLS. 13, 21, 23, 31 AND 34).

SN 76-265,140. BRIDWELL, NORMAN, EDGARTOWN, MA. FILED 4-18-2001.

CLIFFORD THE BIG RED DOG

FOR LAMPS, ELECTRIC NIGHT LIGHTS, TAP LIGHTS, FLASHLIGHTS (U.S. CLS. 13, 21, 23, 31 AND 34).

SN 76-281,780. SIGNATURE MARKETING GROUP, LTD., FAIRFIELD, NJ. FILED 7-9-2001.

PRESTIGE

FOR STAINLESS-STEEL RANGE HOODS AND RANGE HOOD INSERTS COMPRISED OF FILTERS, LIGHTS, SWITCHES, AND ELECTRICAL CONNec-TIONS AND SOLD AS A UNIT, WITH AND WITHOUT FANS, FOR VENTING RESIDENTIAL KITCHENS; IN-DOOR AND OUTDOOR BARBECUES (U.S. CLS. 13, 21, 23, 31 AND 34).
FIRST USE 1-15-1994; IN COMMERCE 1-15-1994.

CLASS 11—(Continued).

SN 76-283,554. BATTELLE MEMORIAL INSTITUTE, COLUMBUS, OH. FILED 7-11-2001.

INSTREEM

FOR TREATMENT AND FLOW CONTROL UNIT FOR BODIES OF WATER, NAMELY, AN AERATOR THAT USES ROTATING DISCS TO MOVE WATER (U.S. CLS. 13, 21, 23, 31 AND 34).
FIRST USE 4-26-2001; IN COMMERCE 4-26-2001.

SN 76-285,797. SOLAR SERVICES, INC., VIRGINIA BEACH, VA. FILED 7-16-2001.

 **SOLAR SERVICES, INC.**

NO CLAIM IS MADE TO THE EXCLUSIVE RIGHT TO USE "SOLAR SERVICES, INC.", APART FROM THE MARK AS SHOWN.

FOR SOLAR HEATED HOT WATER AND SWIMMING POOL HEATING SYSTEMS COMPRISING COLLECTORS, STORAGE TANKS, PUMPS, VALVES, TEMPERATURE CONTROLLERS, TEMPERATURE SENSORS AND TEMPERATURE INDICATORS; SOLAR AND RADIANT HEATING SYSTEMS, COMPRISING COLLECTORS, HEAT EXCHANGERS, FRAMING AND GLAZING UNITS, PANELS, MULLIONS, PUMPS, HEADERS, HOSES AND HARDWARE THERE FOR; SOLAR POWERED GENERATORS AND WIND POWERED GENERATORS (U.S. CLS. 13, 21, 23, 31 AND 34).
FIRST USE 0-0-1986; IN COMMERCE 0-0-1986.

SN 76-311,753. TUNSTALL ASSOCIATES, INC., CHICOPEE, MA. FILED 9-13-2001.

TUNSTALL

OWNER OF U.S. REG. NO. 2,011,689. SEC. 2(F).
FOR STEAM TRAPS, STEAM TRAP CAPSULES, CONTROL VALVES FOR REGULATING STEAM HEATERS AND HOT WATER HEATERS (U.S. CLS. 13, 21, 23, 31 AND 34).
FIRST USE 2-16-1988; IN COMMERCE 2-16-1988.

SN 76-319,252. HUNTER FAN COMPANY, MEMPHIS, TN. FILED 9-28-2001.

LA BRISA

OWNER OF U.S. REG. NOS. 1,756,672, 1,944,824 AND OTHERS.
THE ENGLISH TRANSLATION OF THE WORD "LA BRISA" IN THE MARK IS "THE BREEZE".
FOR CEILING FANS (U.S. CLS. 13, 21, 23, 31 AND 34).

CLASS 11—(Continued).

SN 76-319,342. HUNTER FAN COMPANY, MEMPHIS, TN. FILED 9-28-2001.

SOUTH SEAS COLLECTION

NO CLAIM IS MADE TO THE EXCLUSIVE RIGHT TO USE "COLLECTION", APART FROM THE MARK AS SHOWN.

FOR STRUCTURAL PARTS OF CEILING FANS, NAMELY, CEILING FAN BLADES (U.S. CLS. 13, 21, 23, 31 AND 34).

SN 76-325,932. CERAMIC AND MATERIALS PROCESSING, INC., CLARENCE, NY. FILED 10-15-2001.

HOT-KIZZ

FOR CHEMICAL DRILL, NAMELY, A CUTTING/DRILLING/PIERCING TOOL WHICH BROADLY INCLUDES AN ELONGATED TUBE FORMED OF A FUEL-SUPPLYING MATERIAL, SUCH AS IRON, AND A MATERIAL WHICH SERVES AS A FOCUSING ELEMENT DURING THE IRON BURNING IN OXYGEN, FOR CONVERTING THE REACTION PRODUCTS RESULTING FROM THE CUTTING, DRILLING OR PIERCING OPERATION TO GASEOUS OR VERY VOLATILE PRODUCTS (U.S. CLS. 13, 21, 23, 31 AND 34).

SN 76-326,164. HUNTER FAN COMPANY, MEMPHIS, TN. FILED 10-16-2001.

EMBASSY COLLECTION

OWNER OF U.S. REG. NO. 1,925,331.
NO CLAIM IS MADE TO THE EXCLUSIVE RIGHT TO USE "COLLECTION", APART FROM THE MARK AS SHOWN.
FOR CEILING FANS (U.S. CLS. 13, 21, 23, 31 AND 34).

SN 76-327,954. REVENOOR CO., INC., THE, TOLEDO, WA. FILED 10-22-2001.

THE REVENOOR

FOR WATER DISTILLATION UNITS FOR DOMESTIC, COMMERCIAL AND INDUSTRIAL USES (U.S. CLS. 13, 21, 23, 31 AND 34).
FIRST USE 9-21-1979; IN COMMERCE 9-21-1979.

SN 76-339,182. COOKTEK, LLC, CHICAGO, IL. FILED 11-19-2001.

FAHEATER

FOR INDUCTION COOKTOPS MADE OF GLASS-CERAMIC MATERIAL (U.S. CLS. 13, 21, 23, 31 AND 34).

CLASS 11—(Continued).

SN 76-339,885. RAITH, EDWARD, PARLIN, NJ. FILED 11-19-2001.

COZZY SLEEP

FOR BED WARMER APPARATUS CONSISTING PRINCIPALLY OF BOX-LIKE ELEMENT FOR CAPTURING WARM AIR AT A FLOOR OR WALL VENT AND A HOSE FOR CARRYING THE WARM AIR TO A BED WHERE IT IS DISCHARGED THROUGH A NOZZLE PLACED BETWEEN A BLANKET AND THE BED (U.S. CLS. 13, 21, 23, 31 AND 34).

SN 76-344,501. BRADLEY FIXTURES CORPORATION, MENOMONEE FALLS, WI. FILED 12-3-2001.

TOUCH TIME

FOR PLUMBING FIXTURES, NAMELY, VALVES (U.S. CLS. 13, 21, 23, 31 AND 34).
FIRST USE 7-15-1996; IN COMMERCE 7-15-1996.

SN 76-348,053. RLA, L.L.C., LARCHMONT, NY. FILED 12-12-2001.

EQUILIBRIUM

FOR LAMPS (U.S. CLS. 13, 21, 23, 31 AND 34).

SN 78-093,953. BROWN, TONYA YVETTE, FREMONT, CA. FILED 11-17-2001.

PORTABATH

FOR PORTABLE BATHTUB FOR BABIES (U.S. CLS. 13, 21, 23, 31 AND 34).

SN 78-097,275. CCA GLOBAL PARTNERS, INC., EARTH CITY, MO. FILED 12-7-2001.

DESIGNER'S TOUCH

FOR ELECTRIC LIGHTING FIXTURES; LAMPS (U.S. CLS. 13, 21, 23, 31 AND 34).

CLASS 12—VEHICLES

CLASS 12—(Continued).

SN 75-597,250. ACECAST INDUSTRY CO. LTD., TAIPING CITY, TAICHUNG HSIEN, TAIWAN, FILED 11-25-1998.



PRIORITY CLAIMED UNDER SEC. 44(D) ON TAIWAN APPLICATION NO. 87702974, FILED 11-11-1998, REG. NO. 878433, DATED 1-1-2000, EXPIRES 4-15-2004.

THE STIPPLING IS A FEATURE OF THE MARK AND IS NOT INTENDED TO INDICATE COLOR.

FOR BICYCLES AND MOTORCYCLES AND PARTS AND FITTINGS THEREFOR; STRUCTURAL PARTS OF BICYCLES AND MOTORCYCLES, NAMELY SHOCK ABSORBERS, SHOCK SEATPOSTS, SUSPENSION FORKS, BUFFERS, HANDLES, OIL CARTRIDGES, CLUTCH (U.S. CLS. 19, 21, 23, 31, 35 AND 44).
FIRST USE 9-1-1989; IN COMMERCE 9-15-1998.

SN 75-846,662. PLATINUM CREATIVE PRODUCTS, INC., WYLIE, TX. FILED 11-12-1999.



THE MARK CONSISTS OF THE PREFIX "DING" WITH A STYLIZED "G" REPRESENTING AN OBJECT MAKING A DENT IN AN AUTOMOBILE DOOR, REPRESENTED BY THE LETTER "B" IN "BAT". PIECES OF THE "B" ARE SHOWN FLYING AWAY FROM THE SIMULATED DOOR.

FOR AUTOMOBILE DENT PROTECTORS CONSISTING OF NON-METAL STRIPS THAT ARE ATTACHED TO THE SIDES OF AUTOMOBILES (U.S. CLS. 19, 21, 23, 31, 35 AND 44).

SN 75-846,663. PLATINUM CREATIVE PRODUCTS, INC., WYLIE, TX. FILED 11-12-1999.

DINGBAT

FOR AUTOMOBILE DENT PROTECTORS CONSISTING OF NON-METAL STRIPS THAT ARE ATTACHED TO THE SIDES OF AUTOMOBILES (U.S. CLS. 19, 21, 23, 31, 35 AND 44).

CLASS 12—(Continued).

SN 75-867,013. DAIMLERCHRYSLER CORPORATION, AUBURN HILLS, MI. FILED 12-8-1999.

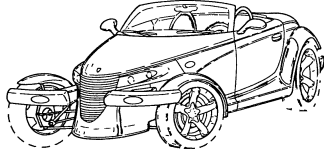

THE MARK CONSISTS OF THE CONFIGURATION OF A CAR. THE SUBJECT MATTER SHOWN IN DOTTED LINES SERVES TO SHOW THE POSITION OF THE MARK BUT IS NOT CLAIMED AS A FEATURE OF THE MARK.

SEC. 2(F).
FOR AUTOMOBILES AND THEIR STRUCTURAL PARTS (U.S. CLS. 19, 21, 23, 31, 35 AND 44).
FIRST USE 1-3-1995; IN COMMERCE 5-19-1997.

CLASS 12—(Continued).

SN 76-025,717. SPEEDWAY MOTORS, INC., LINCOLN, NE. FILED 4-14-2000.



NO CLAIM IS MADE TO THE EXCLUSIVE RIGHT TO USE "ROADSTER", APART FROM THE MARK AS SHOWN. FOR AUTOMOBILE PARTS AND ACCESSORIES, NAMELY, BRAKE AND SUSPENSION PARTS, COIL AND LEAF SPRINGS, SPRING MOUNTS, ATTACHING HARDWARE, BRACKETS, AXLES, SHOCK ABSORBERS, CLAMPS, PERCHES, LINKS, ASSEMBLIES, TIE BARS, SPINDLES; WHEEL ATTACHING HARDWARE; FRAMES; DIFFERENTIAL COVERS, YOKES; WINDSHIELD AND WINDOW FRAMES, CHANNELS, POSTS, ATTACHING HARDWARE, SEALS; COOLING FANS, CAPS; LIGHT HOUSINGS, LENSES, ATTACHING HARDWARE, CONDUITS, COVERS; INTERIOR AND EXTERIOR MIRRORS; HINGES AND LATCHING MECHANISMS; EXHAUST PIPES AND EXTENSIONS; ENGINE ACCESSORY MOUNTING BRACKETS, BREATHERS, AIR CLEANERS, SCOOPS, PEDALS, LINKAGE (U.S. CLS. 19, 21, 23, 31, 35 AND 44).
FIRST USE 5-0-1975; IN COMMERCE 5-0-1975.

SN 75-899,690. ECLIPSE AVIATION CORPORATION, ALBUQUERQUE, NM. BY CHANGE OF NAME PRONTO AIRCRAFT CORPORATION, WALLED LAKE, MO. FILED 1-20-2000.

ECLIPSE AIRCRAFT

NO CLAIM IS MADE TO THE EXCLUSIVE RIGHT TO USE "AIRCRAFT", APART FROM THE MARK AS SHOWN. FOR AIRPLANES AND STRUCTURAL PARTS THEREOF (U.S. CLS. 19, 21, 23, 31, 35 AND 44).

SN 76-026,241. AIRBOSS OF AMERICA CORP., TORONTO, ONTARIO, M5H 3P5, CANADA, FILED 4-14-2000.

SOLIDBOSS

SN 76-018,226. BAYERISCHE MOTOREN WERKE AKTIENGESELLSCHAFT, D-80788 MUENCHEN, FED REP GERMANY, FILED 4-6-2000.

PRIORITY CLAIMED UNDER SEC. 44(D) ON CANADA APPLICATION NO. 1048512, FILED 2-25-2000.
OWNER OF U.S. REG. NOS. 1,852,342 AND 2,443,599.
FOR SOLID TIRES FOR LAND VEHICLES, NAMELY A UNITARY STRUCTURE OF A METAL WHEEL WITH SOLID MASS OF RUBBER BONDED TO THE PERIPHERY (U.S. CLS. 19, 21, 23, 31, 35 AND 44).
FIRST USE 2-15-2000; IN COMMERCE 2-15-2000.

FOR AUTOMOBILES AND STRUCTURAL PARTS THEREFOR (U.S. CLS. 19, 21, 23, 31, 35 AND 44).
FIRST USE 10-0-1992; IN COMMERCE 10-0-1992.

CLASS 12—(Continued).

SN 76-087,377. WP SUSPENSION B.V., MALDEN, NETHERLANDS, FILED 7-12-2000.



PRIORITY CLAIMED UNDER SEC. 44(D) ON BENELUX APPLICATION NO. 962073, FILED 4-10-2000, REG. NO. 0663448, DATED 4-10-2000, EXPIRES 4-10-2010.

OWNER OF U.S. REG. NOS. 2,110,491 AND 2,119,073.

NO CLAIM IS MADE TO THE EXCLUSIVE RIGHT TO USE "SUSPENSION", APART FROM THE MARK AS SHOWN.

THE MARK IS FILED CLAIMING THE COLORS RED, WHITE AND BLACK. THE WORD "SUSPENSION" APPEARS IN BLACK. THE INITIALS, "W" AND "P," ARE WHITE. EACH INITIAL IS FRAMED IN BLACK WITH A RED BORDER INSIDE THE BLACK FRAME. THE INITIAL "P" HAS A BLACK CUTOUT FRAMED IN RED.

FOR SHOCK ABSORBERS, SHOCKS, SPRINGS, FORKS, STEERING-SILENCERS FOR VEHICLES; PARTS AND FITTINGS FOR THE AFORESAID GOODS NOT INCLUDED IN OTHER CLASSES (U.S. CLS. 19, 21, 23, 31, 35 AND 44).

SN 76-137,855. TRINITY TRAILER MFG., INC., BOISE, ID. FILED 9-29-2000.

EAGLE BRIDGE

FOR CARGO TRAILERS (U.S. CLS. 19, 21, 23, 31, 35 AND 44).

FIRST USE 0-0-1974; IN COMMERCE 0-0-1974.

SN 76-147,660. CAMPAGNOLO SRL, 36100 VICENZA, ITALY, FILED 10-13-2000.

ULTRA DRIVE

PRIORITY CLAIMED UNDER SEC. 44(D) ON ITALY APPLICATION NO. 001306, FILED 4-26-2000, REG. NO. 00826338, DATED 10-16-2000, EXPIRES 4-26-2010.

OWNER OF U.S. REG. NO. 2,113,465.

NO CLAIM IS MADE TO THE EXCLUSIVE RIGHT TO USE "DRIVE", APART FROM THE MARK AS SHOWN.

FOR BICYCLE; BICYCLE PARTS, COMPONENTS AND ACCESSORIES, NAMELY, BICYCLE FRAMES, TUBES AND CONNECTORS FOR BICYCLE FRAMES, BICYCLE WHEELS, RIMS AND SPOKES FOR BICYCLE WHEELS, PEDALS, HUBS, WHEEL HUBS FEATURING QUICK-RELEASE SKEWERS CONTROLLED BY CAM LEVERS FOR FAST LOCKING SAME, CHANGE-SPEED GEARS AND FRONT CHANGERS, CRANKS, SIMPLE AND MULTIPLE GEAR WHEELS, CRANKS WITH GEAR WHEELS, GEARS, FREE WHEELS, DRIVE CHAINS, BRAKES, CABLE GUIDES, KNOBS, CONTROLS AND LEVERS, PILLARS AND SADDLES, PUMPS AND PUMP BEARINGS, PINS AND BEARINGS FOR CRANKS AND PEDALS, STEERING KNUCKLES AND BEARINGS AND BUSHES THEREOF, FRONT AND BACK FORKS, CABLES AND SHEATHES, FASTENING CLIPS, HANDLE-BARS AND HANDLE-BAR CONNECTIONS, TIRES AND TUBULAR TIRES, ALL THE AFORESAID GOODS FOR BICYCLES (U.S. CLS. 19, 21, 23, 31, 35 AND 44).

CLASS 12—(Continued).

SN 76-167,702. GUYNN, FREDDIE, LARAMIE, WY. AND GUYNN, LORETTA, LARAMIE, WY. FILED 11-17-2000.

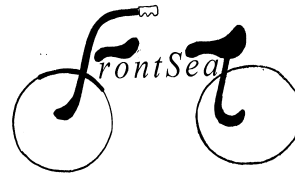

FOR FRONT-MOUNTED BICYCLE PASSENGER SEAT SYSTEM FOR CHILDREN, NAMELY BICYCLE SEATS (U.S. CLS. 19, 21, 23, 31, 35 AND 44).

SN 76-172,114. SPEEDWAY MOTORSPORTS, INC., CONCORD, NC. FILED 11-28-2000.

LEGENDS CARS

NO CLAIM IS MADE TO THE EXCLUSIVE RIGHT TO USE "CARS", APART FROM THE MARK AS SHOWN.

FOR REDUCED-SIZE AUTOMOBILES FOR RACING IN OVAL TRACK AND ROAD COURSE COMPETITIONS (U.S. CLS. 19, 21, 23, 31, 35 AND 44).

FIRST USE 5-19-1991; IN COMMERCE 7-13-1991.

SN 76-197,249. GEHL COMPANY, INC., WEST BEND, WI. FILED 1-22-2001.

AGRI-LOADER

FOR TELESCOPIC HANDLERS FOR USE IN THE CONSTRUCTION, FORESTRY, MINING AND AGRICULTURAL INDUSTRIES, NAMELY, A LAND VEHICLE IN THE NATURE OF A FORKLIFT WITH A TELESCOPIC BOOM (U.S. CLS. 19, 21, 23, 31, 35 AND 44).

FIRST USE 8-9-2000; IN COMMERCE 8-9-2000.

SN 76-205,685. SAND TIRES UNLIMITED, TEMECULA, CA. FILED 2-6-2001.

DUNESPORT

FOR TIRES FOR VEHICLES (U.S. CLS. 19, 21, 23, 31, 35 AND 44).

CLASS 12—(Continued).

SN 76-223,603. TA CHEN INT'L (CA) CORP., LONG BEACH, CA. FILED 3-13-2001.

NASTA

FOR ACCESSORIES FOR TRUCKS AND SPORTS UTILITY VEHICLES, NAMELY, TIE DOWN RAILS FOR TRUCK BED SIDEWALLS, STEP RAILS FOR MOUNTING BELOW TRUCK DOOR, SIDE RAILS, DECORATIVE METAL BARS FOR TRUCK BEDS, RUNNING BOARDS AND STEPS, BED RAILS, STEP RAILS AND MUFFLER TIPS (U.S. CLS. 19, 21, 23, 31, 35 AND 44).

FIRST USE 10-1-1999; IN COMMERCE 10-1-1999.

SN 76-235,952. HYUNDAI MOTOR AMERICA, FOUNTAIN VALLEY, CA. FILED 4-6-2001.

NOBEL

FOR AUTOMOBILES AND STRUCTURAL PARTS THEREFOR (U.S. CLS. 19, 21, 23, 31, 35 AND 44).

SN 76-267,381. ELEGANT USA, LLC, TOTOWA, NJ. FILED 6-5-2001.



OWNER OF U.S. REG. NOS. 2,212,229, 2,238,832 AND 2,343,714.

NO CLAIM IS MADE TO THE EXCLUSIVE RIGHT TO USE "BENCH", APART FROM THE MARK AS SHOWN. THE STIPPLING IS FOR SHADING PURPOSES ONLY AND DOES NOT INDICATE COLOR.

FOR AUTOMOBILE SEAT COVERS (U.S. CLS. 19, 21, 23, 31, 35 AND 44).

SN 76-270,131. COVERS UNLIMITED, INC., LOUISVILLE, KY. FILED 6-12-2001.

COVERS UNLIMITED

NO CLAIM IS MADE TO THE EXCLUSIVE RIGHT TO USE "COVERS", APART FROM THE MARK AS SHOWN.

FOR FITTED AND SEMI-FITTED BOAT COVERS (U.S. CLS. 19, 21, 23, 31, 35 AND 44).

FIRST USE 0-0-1991; IN COMMERCE 0-0-1991.

CLASS 12—(Continued).

SN 76-295,138. AEROFLEX INTERNATIONAL CO. LTD., CHANGWAD RAYONG, THAILAND, FILED 8-6-2001.

AERO A-KLASSE

FOR FITTED LINERS FOR THE CARGO AREA OF PICK-UP TRUCKS (U.S. CLS. 19, 21, 23, 31, 35 AND 44).

SN 76-297,541. BAYERISCHE MOTOREN WERKE AKTIENGESELLSCHAFT, 80788 MUENCHEN, FED REP GERMANY, FILED 8-10-2001.

Z4

PRIORITY CLAIMED UNDER SEC. 44(D) ON FED REP GERMANY APPLICATION NO. 394036387/12, FILED 1-1-1995, REG. NO. 39403638, DATED 8-16-1995, EXPIRES 1-31-2005.

FOR AUTOMOBILES AND STRUCTURAL PARTS THEREFOR, EXCLUDING TIRES (U.S. CLS. 19, 21, 23, 31, 35 AND 44).

SN 76-308,490. MIDWEST MOTORCYCLE SUPPLY DISTRIBUTORS CORP., ARNOLD, MO. FILED 9-4-2001.

WOLF DADDY

FOR MOTORCYCLES AND STRUCTURAL PARTS THEREFOR (U.S. CLS. 19, 21, 23, 31, 35 AND 44).

SN 76-308,491. MIDWEST MOTORCYCLE SUPPLY DISTRIBUTORS CORP., ARNOLD, MO. FILED 9-4-2001.

THUNDER HORSE

FOR MOTORCYCLES AND STRUCTURAL PARTS THEREFOR (U.S. CLS. 19, 21, 23, 31, 35 AND 44).

SN 76-321,574. MONACO COACH CORPORATION, COBURG, OR. FILED 10-5-2001.

LAKOTA

FOR RECREATIONAL VEHICLES, NAMELY, TRAVEL TRAILERS (U.S. CLS. 19, 21, 23, 31, 35 AND 44).

FIRST USE 6-25-1999; IN COMMERCE 6-25-1999.

CLASS 12—(Continued).

SN 76-325,019. BRIDGESTONE CORPORATION, TOKYO, JAPAN, FILED 10-12-2001.



OWNER OF U.S. REG. NOS. 711,233, 952,683 AND OTHERS.

FOR TIRES AND INNER TUBES THEREFOR (U.S. CLS. 19, 21, 23, 31, 35 AND 44).

FIRST USE 10-5-1983; IN COMMERCE 11-10-1983.

SN 76-331,199. STANRAIL CORPORATION, GARY, IN. FILED 10-29-2001.

STANLITE

FOR RAILROAD CAR ROOF PANELS (U.S. CLS. 19, 21, 23, 31, 35 AND 44).

FIRST USE 8-31-2001; IN COMMERCE 8-31-2001.

SN 76-336,125. AUTO CARE PRODUCTS, INC., SAN DIEGO, CA. FILED 11-13-2001.

TURN SMART

FOR VEHICLE SIGNAL INDICATORS (U.S. CLS. 19, 21, 23, 31, 35 AND 44).

SN 76-336,661. MICCOSUKEE BOATS, INC., ORLANDO, FL. FILED 11-14-2001.



NO CLAIM IS MADE TO THE EXCLUSIVE RIGHT TO USE "DUCK BOAT", APART FROM THE MARK AS SHOWN.

FOR BOATS AND STRUCTURAL PARTS THEREFOR (U.S. CLS. 19, 21, 23, 31, 35 AND 44).

FIRST USE 6-1-1982; IN COMMERCE 6-1-1982.

CLASS 12—(Continued).

SN 76-339,068. HEADLAND MACHINERY & ELECTRIC INDUSTRIAL CO., LTD., TSAOTUEN JEN, NANTOU, TAIWAN, FILED 11-19-2001.



FOR BICYCLES, ELECTROMOTIVE BICYCLES, MOTORIZED SCOOTERS, MOTORCYCLES, ELECTROMOTIVE MOTORCYCLES (U.S. CLS. 19, 21, 23, 31, 35 AND 44).

SN 76-344,647. CLASSIC MOTORCYCLES AND SIDECARS, INC., PRESTON, WA. FILED 12-4-2001.

FLYING TIGER

FOR MOTOCYCLES AND STRUCTURAL PARTS THEREFOR (U.S. CLS. 19, 21, 23, 31, 35 AND 44).

FIRST USE 11-0-1997; IN COMMERCE 2-0-2001.

SN 76-346,091. AM-SAFE, INCORPORATED, PHOENIX, AZ. FILED 12-6-2001.

AMSAFE

OWNER OF U.S. REG. NO. 1,544,326.
FOR VEHICLE OCCUPANT RESTRAINT SYSTEMS, COMPRISING FIVE POINT ROTARY BUCKLES, PASSENGER LAP BELTS, EXTENSION BELTS, RETRACTORS, INERTIA REELS, BUCKLES, CONNECTORS, END FITTINGS, AND WEBBINGS (U.S. CLS. 19, 21, 23, 31, 35 AND 44).

SN 76-347,235. BRUNSWICK CORPORATION, LAKE FOREST, IL. FILED 12-10-2001.

ALPHA 4

FOR MARINE PROPELLERS (U.S. CLS. 19, 21, 23, 31, 35 AND 44).

FIRST USE 4-9-1996; IN COMMERCE 5-2-1996.

CLASS 12—(Continued).

SN 78-048,872. MEYER DISTRIBUTING LLC, TEMPE, AZ. FILED 2-16-2001.

MEYER DISTRIBUTING

NO CLAIM IS MADE TO THE EXCLUSIVE RIGHT TO USE "DISTRIBUTING", APART FROM THE MARK AS SHOWN.

FOR MOTORIZED SCOOTERS AND STRUCTURAL PARTS THEREOF (U.S. CLS. 19, 21, 23, 31, 35 AND 44). FIRST USE 11-22-1996; IN COMMERCE 11-22-1996.

SN 78-049,416. BISCH, JEFFREY R., SANTA BARBARA, CA. FILED 2-21-2001.



THE MARK CONSISTS OF THE WORD "COZYWING" AND A STYLIZED REPRESENTATION OF A WING.

FOR PORTABLE HEADRESTS USED PRINCIPALLY ON VEHICLE SEATS; WITH FOLDING, CUSHIONED SIDE SUPPORT PANELS THAT ATTACHES TO THE HEADREST OF A SEAT IN AN AUTOMOBILE, PLANE, BUS, TRAIN OR OTHER TRANSPORTATION (U.S. CLS. 19, 21, 23, 31, 35 AND 44).

SN 78-063,011. EBNER, JAMES L., ROSEBURG, OR. AND EBNER, CYNTHIA C., ROSEBURG, OR. FILED 5-10-2001.

CANINE CUSTOM CRUISERS

NO CLAIM IS MADE TO THE EXCLUSIVE RIGHT TO USE "CANINE CUSTOM", APART FROM THE MARK AS SHOWN.

FOR DISABLE PET CARTS AND DISABLED PET CART ACCESSORIES, NAMELY HARNESES, SLINGS, LEASHES AND FOOT GUARDS (U.S. CLS. 19, 21, 23, 31, 35 AND 44).

FIRST USE 2-1-2001; IN COMMERCE 5-10-2001.

SN 78-076,721. B E AEROSPACE, INC., WELLINGTON, FL. FILED 7-31-2001.

SPECTRUM

FOR AIRCRAFT PASSENGER SEATS (U.S. CLS. 19, 21, 23, 31, 35 AND 44).

CLASS 12—(Continued).

SN 78-089,604. FARROW, ROBERT, DBA PROMAR LTD., HOUSTON, TX. FILED 10-22-2001.



FOR ANTI-THEFT LOCKS FOR MOTOR VEHICLES (U.S. CLS. 19, 21, 23, 31, 35 AND 44). FIRST USE 12-19-1988; IN COMMERCE 12-19-1988.

SN 78-089,929. GENERAL MOTORS CORPORATION, DETROIT, MI. FILED 10-24-2001.

CADILLAC

FOR BOATS, NAMELY, YACHTS (U.S. CLS. 19, 21, 23, 31, 35 AND 44).

SN 78-097,065. DAIMLERCHRYSLER CORPORATION, AUBURN HILLS, MI. FILED 12-6-2001.

NATRIUM

FOR MOTOR VEHICLES, NAMELY, SPORT UTILITY VEHICLES, AND STRUCTURAL PARTS AND ENGINES THEREFOR (U.S. CLS. 19, 21, 23, 31, 35 AND 44).

CLASS 13—FIREARMS

SN 76-233,117. AUTO-NUMATIC CORP., FORT WORTH, TX. FILED 4-2-2001.



NO CLAIM IS MADE TO THE EXCLUSIVE RIGHT TO USE "AIR GUNS", APART FROM THE MARK AS SHOWN. FOR AIR RIFLES AND AIR PISTOLS (U.S. CLS. 2 AND 9). FIRST USE 12-16-1998; IN COMMERCE 1-5-2000.

CLASS 13—(Continued).

SN 76-340,088. ANGELOTTI INC., SCARBOROUGH, ONTARIO, CANADA, FILED 11-21-2001.

CITIZEN

FOR FIREARMS, DIE-MARKING PISTOLS, AND REPLACEMENT AND STRUCTURAL PARTS THEREFORE; AMMUNITION (U.S. CLS. 2 AND 9).

SN 76-344,591. GREAT GRIZZLY, INC., MUNCIE, IN. FILED 12-3-2001.

GANGSTER

FOR CONSUMER FIREWORKS (U.S. CLS. 2 AND 9).

SN 76-344,592. GREAT GRIZZLY, INC., MUNCIE, IN. FILED 12-3-2001.

MUMMY

FOR CONSUMER FIREWORKS (U.S. CLS. 2 AND 9).

SN 76-344,597. GREAT GRIZZLY, INC., MUNCIE, IN. FILED 12-3-2001.

HIT MAN

FOR CONSUMER FIREWORKS (U.S. CLS. 2 AND 9). FIRST USE 5-0-1995; IN COMMERCE 5-0-1995.

SN 76-344,599. GREAT GRIZZLY, INC., MUNCIE, IN. FILED 12-3-2001.

MAD BOMBER

FOR CONSUMER FIREWORKS (U.S. CLS. 2 AND 9). FIRST USE 5-0-1998; IN COMMERCE 5-0-1998.

CLASS 14—JEWELRY**CLASS 14—(Continued).**

SN 75-578,945. AMERICAN AIRLINES, DFW AIRPORT, TX. FILED 10-28-1998.



OWNER OF U.S. REG. NOS. 1,710,459 AND 1,832,926. NO CLAIM IS MADE TO THE EXCLUSIVE RIGHT TO USE "AMERICAN", APART FROM THE MARK AS SHOWN. FOR WATCHES (U.S. CLS. 2, 27, 28 AND 50). FIRST USE 2-0-1998; IN COMMERCE 2-0-1998.

SN 75-708,333. MABINA S.R.L., 20122 MILANO, ITALY, FILED 5-17-1999.

Mabina

PRIORITY CLAIMED UNDER SEC. 44(D) ON ITALY APPLICATION NO. MI99C004366, FILED 4-29-1999, REG. NO. 00825294, DATED 10-4-2000, EXPIRES 4-29-2009.

FOR PRECIOUS GEM STONES; ARTICLES MADE FROM GOLD AND PRECIOUS GEM STONES, NAMELY, RINGS BEING JEWELRY, BRACELETS, NECKLACES, PENDANTS, WATCHES AND WRIST BANDS FOR WATCHES (U.S. CLS. 2, 27, 28 AND 50).

SN 75-824,066. FMTM DISTRIBUTION LTD., ROAD TOWN, TORTOLA, BR. VIRGIN ISLANDS, BY ASSIGNMENT FRANCK MULLER WATCHLAND SA, 1294 GENTHOD, SWITZERLAND, FILED 10-15-1999.

**FRANCK MULLER GENEVE
SUNSET**

PRIORITY CLAIMED UNDER SEC. 44(D) ON SWITZERLAND APPLICATION NO. 03305/1999, FILED 4-15-1999.

NO CLAIM IS MADE TO THE EXCLUSIVE RIGHT TO USE "GENEVE", APART FROM THE MARK AS SHOWN.

THE NAME "FRANK MULLER" IDENTIFIES A LIVING INDIVIDUAL WHOSE CONSENT IS OF RECORD.

THE MARK IS "GENEVE" WHICH IS EQUIVALENT OF "GENEVA".

FOR PRECIOUS METALS AND THEIR ALLOYS SOLD IN BULK; JEWELRY, JEWELS, NAMELY, BRACELETS, WRISTLETS, PENDANTS, RINGS, NECKLACES, EARRINGS, BROOCHES, SLEEVE OR CUFF RINGS, CHAINS, NECK CHAINS AND CHATELAINES; PRECIOUS GEMSTONES; HOROLOGICAL PRODUCTS AND CHRONOMETRIC INSTRUMENTS, NAMELY, CLOCKS, WATCHES, TABLE CLOCKS AND CHRONOMETERS (U.S. CLS. 2, 27, 28 AND 50).

CLASS 14—(Continued).

SN 75-828,012. M.A.B. SUPERFIT INC., HAVERTOWN, PA. FILED 10-22-1999.



FOR JEWELRY, NAMELY RINGS (U.S. CLS. 2, 27, 28 AND 50).
FIRST USE 6-14-2001; IN COMMERCE 6-14-2001.

SN 75-845,344. KAMAHI, ALBERT NICHOLAS, MARINA DEL REY, CA. AND KAMAHI, CHRISTOPHER MARK, EL CAJON, CA. FILED 12-1-1999.



FOR HOROLOGICAL AND CHRONOMETRIC INSTRUMENTS, NAMELY, WATCHES, POCKET WATCHES AND CLOCKS (U.S. CLS. 2, 27, 28 AND 50).

SN 75-845,349. KAMAHI, ALBERT NICHOLAS, MARINA DEL REY, CA. AND KAMAHI, CHRISTOPHER MARK, EL CAJON, CA. FILED 12-1-1999.



FOR HOROLOGICAL AND CHRONOMETRIC INSTRUMENTS, NAMELY, WATCHES, POCKET WATCHES AND CLOCKS (U.S. CLS. 2, 27, 28 AND 50).

CLASS 14—(Continued).

SN 76-015,188. PHILOSOPHY, INC., PHOENIX, AZ. FILED 3-30-2000.

SOUL MATES

FOR JEWELRY, NAMELY BRACELETS, BROOCHES, CHAINS, CHARMS, COSTUME JEWELRY, EARRINGS, NECKLACES, PENDANTS, LAPEL PINS, RINGS, AND WRISTWATCHES (U.S. CLS. 2, 27, 28 AND 50).

SN 76-066,486. GOOD COMPANY LTD., TOKYO, JAPAN, FILED 6-9-2000.

NINE STAR

PRIORITY CLAIMED UNDER SEC. 44(D) ON JAPAN APPLICATION NO. 23678/2000, FILED 3-10-2000, REG. NO. 446553, DATED 4-6-2001, EXPIRES 4-6-2011.

FOR DIAMONDS; JEWELRY FOR WHICH DIAMONDS ARE USED, NAMELY EARRINGS FOR WHICH DIAMONDS ARE USED, TIE CLIPS, TIE FASTENERS AND TIE TACKS FOR WHICH DIAMONDS ARE USED, NECKTIE PINS FOR WHICH DIAMONDS ARE USED, NECKLACES FOR WHICH DIAMONDS ARE USED, BRACELETS FOR WHICH DIAMONDS ARE USED, PENDANTS FOR WHICH DIAMONDS ARE USED, BROOCHES FOR WHICH DIAMONDS ARE USED, RINGS FOR WHICH DIAMONDS ARE USED, LOCKETS FOR WHICH DIAMONDS ARE USED, CUFF LINKS FOR WHICH DIAMONDS ARE USED (U.S. CLS. 2, 27, 28 AND 50).

SN 76-095,427. MARTIN, WILLIAM BRIAN, ALLOWAY, AYR, KA7 4QB, UNITED KINGDOM, AND MARTIN, MOIRA ANNE, ALLOWAY, AYR, KA7 4QB, UNITED KINGDOM, FILED 7-25-2000.

AILS CRAIG

OWNER OF UNITED KINGDOM REG. NO. 2199975, DATED 6-12-1999, EXPIRES 6-12-2009.

THE NAME "AILS CRAIG" DOES NOT IDENTIFY A LIVING INDIVIDUAL.

FOR JEWELRY; BROOCHES, CUFFLINKS, EARRINGS, PENDANTS, TIE CLIPS, TIE PINS; PARTS AND FITTINGS FOR ALL OF THE AFORESAID GOODS (U.S. CLS. 2, 27, 28 AND 50).

FIRST USE 4-4-2000; IN COMMERCE 4-4-2000.

SN 76-111,085. DESCO VON SCHULTHESS AG, ZURICH, SWITZERLAND, FILED 8-9-2000.

TARINO

OWNER OF SWITZERLAND REG. NO. 475088, DATED 2-23-2000, EXPIRES 2-23-2010.

FOR PRECIOUS METALS AND THEIR ALLOYS; JEWELRY, JEWELS, PRECIOUS GEMSTONES; HOROLOGICAL PRODUCTS AND CHRONOMETRIC INSTRUMENTS, NAMELY, CLOCKS, WATCHES, TABLE CLOCKS AND CHRONOMETERS (U.S. CLS. 2, 27, 28 AND 50).

CLASS 14—(Continued).

SN 76-111,091. DESCO VON SCHULTHESS AG, ZURICH, SWITZERLAND, FILED 8-9-2000.

SIRAS

OWNER OF SWITZERLAND REG. NO. 475089, DATED 2-23-2000, EXPIRES 2-23-2010.

FOR PRECIOUS METALS AND THEIR ALLOYS; JEWELRY, JEWELS, PRECIOUS GEMSTONES; HOROLOGICAL PRODUCTS AND CHRONOMETRIC INSTRUMENTS, NAMELY, CLOCKS WATCHES, TABLE CLOCKS, AND CHRONOMETERS (U.S. CLS. 2, 27, 28 AND 50).

SN 76-137,529. HONORA LTD., NEW YORK, NY. FILED 9-29-2000.

HONORA FRESH

OWNER OF U.S. REG. NO. 1,439,121.
NO CLAIM IS MADE TO THE EXCLUSIVE RIGHT TO USE "FRESH", APART FROM THE MARK AS SHOWN.
FOR CULTURED PEARL JEWELRY (U.S. CLS. 2, 27, 28 AND 50).

FIRST USE 9-0-2000; IN COMMERCE 9-0-2000.

SN 76-137,659. JANANA'S APPAREL, INC., LOS ANGELES, CA. FILED 9-28-2000.

ANDY BLANCO

"ANDY BLANCO" DOES NOT IDENTIFY A PARTICULAR LIVING INDIVIDUAL.

FOR JEWELRY, NAMELY, WATCHES, EARRINGS, RINGS, NECKLACES, PENDANTS, AND ORNAMENTAL PINS (U.S. CLS. 2, 27, 28 AND 50).

SN 76-147,284. ALLISON REED GROUP, INC., EAST PROVIDENCE, RI. FILED 10-16-2000.

WEH

OWNER OF U.S. REG. NO. 694,556.
FOR JEWELRY (U.S. CLS. 2, 27, 28 AND 50).
FIRST USE 1-0-1957; IN COMMERCE 1-0-1957.

SN 76-171,524. HOROSWISS S.A., 2300 LA CHAUX-DE-FONDS, SWITZERLAND, FILED 11-28-2000.

HOROSWISS HRS

OWNER OF SWITZERLAND REG. NO. 470,282, DATED 3-9-2000, EXPIRES 2-10-2010.
FOR WATCHES (U.S. CLS. 2, 27, 28 AND 50).
FIRST USE 3-9-2000; IN COMMERCE 9-28-2000.

CLASS 14—(Continued).

SN 76-176,614. PEAKS CORPORATION, SHIBUYA-KU TOKYO 150-0012, JAPAN, FILED 12-6-2000.

ZENO-ARMY

FOR WATCHES AND CLOCKS (U.S. CLS. 2, 27, 28 AND 50).

SN 76-185,565. GOTHE, AXEL, NEW YORK, NY. FILED 12-22-2000.

BLU  UMAGIC

FOR JEWELRY, NAMELY, EARRINGS, BRACELETS, NECKLACES, PENDANTS, WATCHES (U.S. CLS. 2, 27, 28 AND 50).

SN 76-194,486. TOO, INC., COLUMBUS, OH. FILED 1-16-2001.

TOO BANDS

NO CLAIM IS MADE TO THE EXCLUSIVE RIGHT TO USE "BANDS", APART FROM THE MARK AS SHOWN.
FOR JEWELRY (U.S. CLS. 2, 27, 28 AND 50).

SN 76-194,822. ODI, INC., LONG ISLAND CITY, NY. FILED 1-16-2001.



FOR FINE GOLD, PLATINUM AND DIAMOND JEWELRY, NAMELY EARRINGS, RINGS, BRACELETS, NECKLACES AND PENDANTS (U.S. CLS. 2, 27, 28 AND 50).

CLASS 14—(Continued).

SN 76-197,386. #!, BOISE, ID. FILED 1-23-2001.

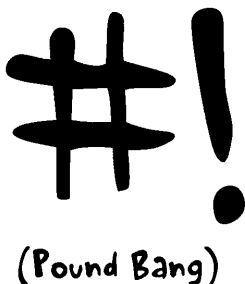

FOR JEWELRY (U.S. CLS. 2, 27, 28 AND 50).

SN 76-210,221. MPD DESIGN GROUP, CORP., NEW YORK, NY. FILED 2-14-2001.

PAOLA DE LUCA

THE NAME SHOWN IN THE MARK IDENTIFIES A LIVING INDIVIDUAL WHOSE CONSENT IS OF RECORD. FOR FINE JEWELRY (U.S. CLS. 2, 27, 28 AND 50). FIRST USE 6-1-1998; IN COMMERCE 1-1-1999.

SN 76-213,980. BARBERO & RICCI SNC DI RICCI CARLO E C, 15048 VALENZA (AL.), ITALY, FILED 2-21-2001.

1031 AL

NO CLAIM IS MADE TO THE EXCLUSIVE RIGHT TO USE "AL", APART FROM THE MARK AS SHOWN.

THE LETTERS "AL" ARE AN ABBREVIATION FOR THE PROVINCE OF ALESSANDRIA AND THE NUMBER "1031" MEANS THE 1,031ST PRECIOUS METAL MANUFACTURER LOCATED IN THE PROVINCE.

FOR GOLD AND SILVER JEWELRY (U.S. CLS. 2, 27, 28 AND 50).

FIRST USE 1-1-1970; IN COMMERCE 3-25-1983.

CLASS 14—(Continued).

SN 76-234,343. METRO-GOLDWYN-MAYER LION CORP., SANTA MONICA, CA. FILED 4-2-2001.



OWNER OF U.S. REG. NOS. 1,060,488, 2,515,287 AND OTHERS.

FOR JEWELRY, WATCHES AND CLOCKS (U.S. CLS. 2, 27, 28 AND 50).

FIRST USE 1-1-2000; IN COMMERCE 1-1-2000.

SN 76-239,856. CLEMENT, SANDRA, HULL, MA. FILED 4-12-2001.

BRAVEAUX

FOR IMITATION JEWELRY AND JEWELRY OF PRECIOUS METAL AND STONES (U.S. CLS. 2, 27, 28 AND 50).

FIRST USE 12-9-2000; IN COMMERCE 12-9-2000.

SN 76-244,793. GONZALEZ, SANDRA, MIAMI, FL. FILED 4-23-2001.

WEAR WHAT COUNTS

FOR JEWELRY AND WATCHES (U.S. CLS. 2, 27, 28 AND 50).

FIRST USE 5-30-2000; IN COMMERCE 5-30-2000.

SN 76-247,378. PARAMOUNT PARKS INC., CHARLOTTE, NC. FILED 4-26-2001.

TERRORFEST

FOR LAPEL PINS (U.S. CLS. 2, 27, 28 AND 50).

SN 76-285,071. MOVADO LLC, WILMINGTON, DE. FILED 7-12-2001.

CUSCINO

THE TRANSLATION OF "CUSCINO" MEANS "PILLOW" IN ITALIAN.

FOR JEWELRY (U.S. CLS. 2, 27, 28 AND 50).

FIRST USE 11-5-2001; IN COMMERCE 11-5-2001.

CLASS 14—(Continued).

SN 76-318,946. NEOPETS.COM, INC., GLENDALE, CA. FILED 9-28-2001.

NEOPETS

FOR JEWELRY, NAMELY, RINGS, BRACELETS, NECKLACES, PENDANTS, EARRINGS, STICKPINS, WRIST WATCHES, CLOCKS, KEYCHAINS, HAIR PINS, BARRETTES, HAIR CLIPS, CUFFLINKS, BROOCHES, MONEY CLIPS (U.S. CLS. 2, 27, 28 AND 50).

SN 76-320,905. FRANCO TRADING S.P.A., CHIERI, TORINO, ITALY, FILED 10-3-2001.



NO CLAIM IS MADE TO THE EXCLUSIVE RIGHT TO USE "GIOIELLI", APART FROM THE MARK AS SHOWN. THE ENGLISH TRANSLATION OF "FRANCO GIOIELLI" IS "FRANCO JEWELRY".

FOR JEWELRY, IMITATION JEWELRY, CLOCKS, WATCHES AND THEIR PARTS (U.S. CLS. 2, 27, 28 AND 50).

SN 76-325,824. KEY IS CHRIST, INC., THE, OVERLAND PARK, KS. FILED 10-16-2001.

THE KEY IS CHRIST

FOR JEWELRY, MEDALS, AND PENDANTS (U.S. CLS. 2, 27, 28 AND 50).

SN 76-329,491. AURAFIN-OROAMERICA LLC, TAMARAC, FL. FILED 10-25-2001.

KINDERGOLD

FOR JEWELRY MADE IN WHOLE OR SUBSTANTIAL PART OF GOLD (U.S. CLS. 2, 27, 28 AND 50).

SN 76-330,149. SAMUEL AARON INTERNATIONAL, LONG ISLAND CITY, NY. FILED 10-26-2001.

CELEBRATION OF COLOR

FOR DIAMONDS AND DIAMOND JEWELRY (U.S. CLS. 2, 27, 28 AND 50).

CLASS 14—(Continued).

SN 76-331,454. SANDBERG & SIKORSKI DIAMOND CORPORATION, NEW YORK, NY. FILED 10-30-2001.

A FLAWLESS DIAMOND FOR A PERFECT DAD

FOR JEWELRY, NAMELY EARRINGS, RINGS, BRACELETS, PENDANTS AND NECKLACES (U.S. CLS. 2, 27, 28 AND 50).

SN 76-331,456. SANDBERG & SIKORSKI DIAMOND CORPORATION, NEW YORK, NY. FILED 10-30-2001.

A FLAWLESS DIAMOND FOR A PERFECT MOM

FOR JEWELRY, NAMELY EARRINGS, RINGS, BRACELETS, PENDANTS AND NECKLACES (U.S. CLS. 2, 27, 28 AND 50).

SN 76-333,699. MISS BROOKE'S COMPANY LLC, BRYANT, AR. FILED 11-5-2001.

MEDI CHARMS

NO CLAIM IS MADE TO THE EXCLUSIVE RIGHT TO USE "CHARMS", APART FROM THE MARK AS SHOWN. FOR JEWELRY, NAMELY PENDANTS FOR BRACELETS AND NECKLACES (U.S. CLS. 2, 27, 28 AND 50). FIRST USE 8-1-2000; IN COMMERCE 8-1-2000.

SN 76-339,036. LAURENTIA GIOIELLI S.R.L., VICENZA, ITALY, FILED 11-16-2001.

LAURENTIA

FOR JEWELRY, NAMELY, RINGS, EARRINGS, NECKLACES AND BRACELETS (U.S. CLS. 2, 27, 28 AND 50).

SN 76-344,411. HORD CRYSTAL CORPORATION, PAWTUCKET, RI. FILED 12-3-2001.

FABRIC FRIENDLY

FOR JEWELRY AND JEWELRY FINDINGS (U.S. CLS. 2, 27, 28 AND 50).

CLASS 14—(Continued).

SN 78-040,226. CECILIA GUERRERO DE ZAVALA, MEXICO CITY, DISTRITO FEDERAL, MEXICO, FILED 12-21-2000.



FOR BREADBASKETS OF PRECIOUS METALS; TOAST RACKS OF PRECIOUS METALS; SWEET MEAT BOXES OF PRECIOUS METALS; CRUETS AND CRUET STANDS OF PRECIOUS METALS; COFFEE POTS OF PRECIOUS METALS; TEA POTS OF PRECIOUS METALS; NUTCRACKERS OF PRECIOUS METALS; NAPKIN RINGS OF PRECIOUS METALS; CANDLESTICKS OF PRECIOUS METALS; NON ELECTRIC CANDELABRAS OF PRECIOUS METALS; ASHTRAYS OF PRECIOUS METALS; CIGARETTE CASES OF PRECIOUS METALS (U.S. CLS. 2, 27, 28 AND 50).

SN 78-044,886. KABUSHIKI KAISHA SUN FLAME, TOKYO, JAPAN, FILED 1-25-2001.

J-AXIS

FOR WATCHES AND CLOCKS (U.S. CLS. 2, 27, 28 AND 50).

SN 78-076,842. SWISS WATCH INTERNATIONAL, HOLLYWOOD, FL. FILED 8-1-2001.

SWI

FOR WATCHES AND JEWELRY (U.S. CLS. 2, 27, 28 AND 50).

CLASS 15—MUSICAL INSTRUMENTS**CLASS 15—(Continued).**

SN 75-917,473. KUN SHOULDER REST INC., OTTAWA, ONTARIO K2P 0L6, CANADA, FILED 2-15-2000.



PRIORITY CLAIMED UNDER SEC. 44(D) ON CANADA APPLICATION NO. 1025914, FILED 8-17-1999.

THE MARK CONSISTS OF THE CONFIGURATION OF A VIOLIN AND A VIOLA SHOULDER REST.

SEC. 2(F).
FOR VIOLIN AND VIOLA SHOULDER RESTS (U.S. CLS. 2, 21 AND 36).

FIRST USE 4-0-1972; IN COMMERCE 0-0-1972.

SN 76-212,608. RELIANCE INTERNATIONAL CORP., TAIPEI, TAIWAN, FILED 2-20-2001.

Compañía

THE ENGLISH TRANSLATION OF THE WORD "COMPAÑIA" IS "COMPANY" OR "FRIEND".

FOR MUSICAL INSTRUMENTS IN GENERAL, KEYBOARD INSTRUMENTS IN GENERAL, CARRYING BAGS FOR MUSICAL INSTRUMENTS, CARRYING CASES FOR MUSICAL INSTRUMENTS, MUSICAL KEYBOARD CARRYING CASES, MUSICAL INSTRUMENTS STANDS, TUNERS FOR MUSICAL INSTRUMENTS (U.S. CLS. 2, 21 AND 36).

SN 76-286,361. EMERSON MUSICAL INSTRUMENTS, INC., ELKHART, IN. FILED 7-17-2001.

EMERSON

OWNER OF U.S. REG. NOS. 1,164,599, 1,179,046 AND 2,417,853.

SEC. 2(F).
FOR WOODWIND MUSICAL INSTRUMENTS, NAMELY - FLUTES AND PICCOLOS; CASES AND CASE COVERS (U.S. CLS. 2, 21 AND 36).

FIRST USE 3-1-1979; IN COMMERCE 3-1-1979.

SN 76-346,679. TAYLOR-LISTUG, INC., EL CAJON, CA. FILED 12-7-2001.

BIG BABY

FOR MUSICAL INSTRUMENTS, NAMELY GUITARS (U.S. CLS. 2, 21 AND 36).

FIRST USE 1-15-2000; IN COMMERCE 1-28-2000.

CLASS 15—(Continued).

SN 78-037,657. CRAIG ALFORD AND DON GENNOVARIO PARTNERSHIP, THE, VALLEY GLEN, CA. FILED 12-4-2000.

ALTERED SOUL

FOR ENTERTAINMENT IN THE NATURE OF A LIVE MUSICAL AND VOCAL GROUP (U.S. CLS. 2, 21 AND 36).

SN 78-096,375. FERNANDES GUITARS INTERNATIONAL, INC., NORTH HOLLYWOOD, CA. FILED 12-3-2001.

RAVELLE

FOR GUITAR, ELECTRIC (U.S. CLS. 2, 21 AND 36). FIRST USE 1-15-2001; IN COMMERCE 1-15-2001.

CLASS 16—PAPER GOODS AND PRINTED MATTER

SN 75-111,126. HABASIT AG, 4153 REINACH, SWITZERLAND, FILED 7-29-1999.

HABASIT FLEXFOLD

PRIORITY CLAIMED UNDER SEC. 44(D) ON SWITZERLAND APPLICATION NO. 13331/1995, FILED 12-6-1995, REG. NO. 426941, DATED 6-5-1996, EXPIRES 6-5-2006. OWNER OF U.S. REG. NO. 898,748.

FOR PLASTIC WRAPPING FILMS AND FOILS FOR COMMERCIAL USE (U.S. CLS. 2, 5, 22, 23, 29, 37, 38 AND 50).

SN 75-659,535. MAVETY MEDIA GROUP LTD., NEW YORK, NY. FILED 3-12-1999.

LEG SHOW LETTERS

OWNER OF U.S. REG. NO. 1,227,478. NO CLAIM IS MADE TO THE EXCLUSIVE RIGHT TO USE "LETTERS", APART FROM THE MARK AS SHOWN. FOR ADULT ENTERTAINMENT MAGAZINES (U.S. CLS. 2, 5, 22, 23, 29, 37, 38 AND 50).

SN 75-756,592. JOHN BROWN PUBLISHING LIMITED, LONDON W10 6SR, UNITED KINGDOM, FILED 7-21-1999.

SPACE

FOR PRINTED PUBLICATIONS, NAMELY, MAGAZINES, NEW SHEETS, BROCHURES, CATALOGS AND LEAFLETS CONTAINING INFORMATION ON INTERIOR DESIGN, FURNITURE AND HOUSEHOLD PARTS AND FITTINGS (U.S. CLS. 2, 5, 22, 23, 29, 37, 38 AND 50). FIRST USE 10-7-1999; IN COMMERCE 10-7-1999.

CLASS 16—(Continued).

SN 75-851,772. MODO PAPER AB, S-111 34 STOCKHOLM, SWEDEN, FILED 11-17-1999.

SILVER DEAL



THE STIPPLING IN THE DRAWING IS A FEATURE OF THE MARK.

FOR SAFETY PAPER, LOOSE LEAF, PRINTING AND WRITING PAPER, COATED PAPER FOR BROCHURES, CD-COVERS, TICKETS, VOUCHERS, GUARANTEE DOCUMENTS, SHIPPING LABELS AND ADDRESS LABELS (U.S. CLS. 2, 5, 22, 23, 29, 37, 38 AND 50).

SN 75-888,800. LAW, BONNIE E., BETHEL, CT. FILED 1-6-2000.

FREUDIAN FLICKS

SEC. 2(F). FOR PAPER PUBLICATIONS, NAMELY NEWSPAPER COLUMN FILM REVIEWS CONTAINING COMMENTARY ON MOTION PICTURES FROM AN ANALYTICAL PERSPECTIVE (U.S. CLS. 2, 5, 22, 23, 29, 37, 38 AND 50).

FIRST USE 10-0-1995; IN COMMERCE 10-31-1995.

SN 75-925,196. OLIVIERI, GUY T., EDISON, NJ. FILED 2-8-2000.

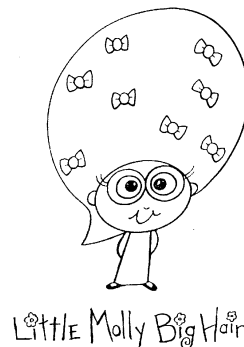

FOR CHILDREN'S BOOKS AND ART PRINTS (U.S. CLS. 2, 5, 22, 23, 29, 37, 38 AND 50).

CLASS 16—(Continued).

SN 75-934,515. FINE PRINT PUBLISHING COMPANY, LONGWOOD, FL. FILED 3-2-2000.



FOR CHILDREN'S ACTIVITY BOOKS; CHILDREN'S BOOKS CONTAINING COMPILATIONS OF STICKERS; BOOK COVERS; ADDRESS BOOKS; STATIONERY; GREETING CARDS; PRINTED INVITATIONS; MEMO PADS; PENS AND PENCILS; PENCIL BOXES AND CASES; PLAYING CARDS; WRITING TABLETS; BOOK MARKS; ERASERS; CALENDARS; POSTERS; PHOTO ALBUMS (U.S. CLS. 2, 5, 22, 23, 29, 37, 38 AND 50).
FIRST USE 9-8-1994; IN COMMERCE 9-8-1994.

SN 76-001,792. RODALE INSTITUTE, THE, EMMAUS, PA. FILED 3-17-2000.

THE NEW FARM

NO CLAIM IS MADE TO THE EXCLUSIVE RIGHT TO USE "FARM", APART FROM THE MARK AS SHOWN.

FOR PUBLICATIONS, NAMELY, MAGAZINES IN THE FIELDS OF AGRICULTURE AND FARMING (U.S. CLS. 2, 5, 22, 23, 29, 37, 38 AND 50).

FIRST USE 7-11-1978; IN COMMERCE 7-11-1978.

SN 76-002,956. LTD COMMODITIES, INC., DBA THE LAKE-SIDE COLLECTION, INC., BANNOCKBURN, IL. FILED 3-17-2000.

THE LAKESIDE COLLECTION, INC.

NO CLAIM IS MADE TO THE EXCLUSIVE RIGHT TO USE "COLLECTION, INC.", APART FROM THE MARK AS SHOWN.

FOR MAIL ORDER CATALOG DISTRIBUTORSHIP SERVICES FEATURING WEARING APPAREL (U.S. CLS. 2, 5, 22, 23, 29, 37, 38 AND 50).

FIRST USE 12-16-1995; IN COMMERCE 12-16-1995.

SN 76-015,367. JIM COTNER STUDIOS, INC., IRVINE, CA. FILED 4-3-2000.



FOR STATIONERY, PERSONAL JOURNALS, STUDENT DAILY PLANNERS, PHOTO ALBUM BOOKS, ADDRESS BOOKS AND PERSONAL ORGANIZERS (U.S. CLS. 2, 5, 22, 23, 29, 37, 38 AND 50).

CLASS 16—(Continued).

SN 76-016,886. JIM COTNER STUDIOS, INC., IRVINE, CA. FILED 3-31-2000.



FOR STATIONERY, PERSONAL JOURNALS, STUDENT DAILY PLANNERS, PHOTO ALBUM BOOKS, ADDRESS BOOKS AND PERSONAL ORGANIZERS (U.S. CLS. 2, 5, 22, 23, 29, 37, 38 AND 50).

FIRST USE 3-1-2000; IN COMMERCE 3-1-2000.

SN 76-016,887. JIM COTNER STUDIOS, INC., IRVINE, CA. FILED 3-31-2000.



FOR STATIONERY, PERSONAL JOURNALS, STUDENT DAILY PLANNERS, PHOTO ALBUM BOOKS, ADDRESS BOOKS AND PERSONAL ORGANIZERS (U.S. CLS. 2, 5, 22, 23, 29, 37, 38 AND 50).

FIRST USE 3-1-2000; IN COMMERCE 3-1-2000.

SN 76-030,330. ORLANDO SENTINEL COMMUNICATIONS COMPANY, ORLANDO, FL. FILED 4-19-2000.

JOB XTRA

NO CLAIM IS MADE TO THE EXCLUSIVE RIGHT TO USE "JOB", APART FROM THE MARK AS SHOWN.

FOR PRINTED MATERIALS, NAMELY, NEWSPAPERS, MAGAZINES AND NEWSLETTERS FEATURING EMPLOYMENT RECRUITMENT INFORMATION (U.S. CLS. 2, 5, 22, 23, 29, 37, 38 AND 50).

CLASS 16—(Continued).

SN 76-041,004. MEDIA CARD I STOCKHOLM AB, S-104 65 STOCKHOLM, SWEDEN, FILED 5-4-2000.

XpandoMedia

PRIORITY CLAIMED UNDER SEC. 44(D) ON ERP CMNTY TM OFC APPLICATION NO. 001600220, FILED 4-10-2000, REG. NO. 1600220, DATED 6-5-2001, EXPIRES 4-10-2011.

FOR FILE FOLDERS, STATIONERY FOLDERS, DESK-TOP ORGANIZERS, EXPANDING FILES, LOCKABLE FILE FOLDERS AND STATIONERY FOLDERS, FOLDABLE FILE FOLDERS AND STATIONERY FOLDERS, FILE POCKETS, LAMINATED FOLDERS, BINDERS, STATIONERY (U.S. CLS. 2, 5, 22, 23, 29, 37, 38 AND 50).

SN 76-067,874. AMERICAN COLLEGE OF VETERINARY MICROBIOLOGISTS, INC., KNOXVILLE, TN. FILED 6-9-2000.

**AMERICAN COLLEGE OF
VETERINARY
MICROBIOLOGISTS**

NO CLAIM IS MADE TO THE EXCLUSIVE RIGHT TO USE "VETERINARY MICROBIOLOGISTS", APART FROM THE MARK AS SHOWN.

SEC. 2(F).
FOR PRINTED PUBLICATIONS; NAMELY, CATALOGS, BOOKS, BROCHURES PAMPHLETS AND JOURNALS RELATING TO VETERINARY MEDICINE (U.S. CLS. 2, 5, 22, 23, 29, 37, 38 AND 50).

FIRST USE 7-12-1966; IN COMMERCE 6-5-1967.

SN 76-071,720. J. PAUL GETTY TRUST, THE, LOS ANGELES, CA. FILED 6-16-2000.

**THE J. PAUL GETTY
MUSEUM**

OWNER OF U.S. REG. NOS. 2,091,377, 2,091,399 AND OTHERS.

NO CLAIM IS MADE TO THE EXCLUSIVE RIGHT TO USE "MUSEUM", APART FROM THE MARK AS SHOWN.

THE NAME SHOWN IN THE MARK DOES NOT IDENTIFY A LIVING INDIVIDUAL.

FOR ADDRESS, APPOINTMENT, ANNIVERSARY, AND AUTOGRAPH BOOKS; ADHESIVE TAPES FOR STATIONERY OR HOUSEHOLD PURPOSES; PHOTOGRAPH AND SCRAPBOOK ALBUMS; ANNOUNCEMENT CARDS; APPLIQUES IN THE FORM OF DECALS; ARCHITECTURAL MODELS; ART ETCHINGS; ART AND PHOTOGRAPH MOUNTS; ART PAPER; ART PICTURES; ART PRINTS; GRAPHIC AND PRINTED ART REPRODUCTIONS; ARTISTS' BRUSHES; ARTS AND CRAFTS PAINT KITS; PAPER, PAPER GIFT, MERCHANDISE AND GENERAL PURPOSE BAGS; PAPER BANNERS; BASKETS FOR DESK ACCESSORIES; PACKAGING, NAMELY BLISTER CARDS; ART SKETCHING BOARDS; CLIP BOARDS; DRAWING BOARDS; PICTURE FRAMING MAT BOARDS; LAP BOARDS FOR READING AND WRITING; BOOK HOLDERS; BOOK PLATES; BOOKENDS; BOOKMARKS; CHILDREN'S BOOKS AND CHILDREN'S ACTIVITY

CLASS 16—(Continued).

BOOKS; COLORING BOOKS; COMPOSITION BOOKS; DATE AND ENGAGEMENT BOOKS; NOTE BOOKS; PICTURE BOOKS; SKETCH BOOKS; TRAVEL BOOKS; CARDBOARD AND PAPER BOXES; PENCIL BOXES; STATIONERY BOXES; BUMPER STICKERS; DESK, POCKET, AND WALL CALENDARS; CANVAS FOR PAINTING; PLAYING CARD CASES; CARDS, NAMELY, CHRISTMAS CARDS, GREETING CARDS, GIFT CARDS, OCCASION CARDS, FLASH CARDS, NOTE CARDS, PLAYING CARDS, TRADING CARDS, AND TRIVIA CARDS; CARTOON PRINTS; PEN AND PENCIL CASES; CHALK; DRY TRANSFER CHARACTERS; PENCILS; CHECKBOOK COVERS AND HOLDERS; MODELING CLAY; COASTERS MADE OF PAPER; COIN HOLDERS; COLLAGES; CONSTRUCTION PAPER; CRAFT PAPER; CRAYONS; DAILY PLANNERS; DECALS; DESK SETS; DESK TOP ORGANIZERS; DRAWING INSTRUMENTS; EASELS; ENGRAVINGS; ERASERS; PAPER FASTENERS; PAPER MACHE FIGURINES; FINGERPRINT KITS; GIFT WRAPPING PAPER; MUSEUM, TRAVEL AND ART GUIDE BOOKS; ILLUSTRATIONS; WRITING INK; DRAWING INK; PRINTED INVITATIONS; LETTER OPENERS; LETTERING GUIDES; LITHOGRAPHS; MAPS; NOTE PADS; NOTE PAPER; SCRATCH PADS; PALETTES FOR PAINTING; PAPER CONTAINERS; PAPER GIFT WRAPPING RIBBONS; PAPERWEIGHTS; ARTISTS' PASTELS; PEN AND PENCIL TRAYS; PENCIL SHARPENERS; COLOR, PHOTOGRAPHIC AND PICTORIAL PRINTS; SEALING WAX; STAMP PADS; RUBBER STAMPS; STATIONERY; STATIONERY FOLDERS; STATIONERY WRITING PAPER AND ENVELOPES; STICKERS; PRINTED TEACHING MATERIALS IN THE FIELDS OF THE ARTS AND HUMANITIES; AND THUMB TACKS (U.S. CLS. 2, 5, 22, 23, 29, 37, 38 AND 50).

SN 76-081,998. ROSEMARY LAKE PTY LTD, PRAHRAN VIC 3181, AUSTRALIA, FILED 6-30-2000.



PRIORITY CLAIMED UNDER SEC. 44(D) ON AUSTRALIA APPLICATION NO. 830542, FILED 4-5-2000, REG. NO. 830542, DATED 4-5-2000, EXPIRES 4-5-2010.

NO CLAIM IS MADE TO THE EXCLUSIVE RIGHT TO USE "ARTIST", APART FROM THE MARK AS SHOWN.

FOR PRINTED INSTRUCTIONAL AND TEACHING MATERIALS FOR USE IN TEACHING ART APPRECIATION TO STUDENTS (U.S. CLS. 2, 5, 22, 23, 29, 37, 38 AND 50).

SN 76-090,574. WINDOWS WITH A VIEW, LLC, DALLAS, TX. FILED 7-18-2000.

WINDOWS WITH A VIEW

FOR PRINTED PATTERNS FOR STAINED GLASS WINDOWS IN A SERIES OF BOOKS AND SINGLE, FULL SIZE PRINTS TO BE USED BY STAINED GLASS WINDOWS ARTISANS (U.S. CLS. 2, 5, 22, 23, 29, 37, 38 AND 50).

FIRST USE 4-0-1997; IN COMMERCE 7-1-2000.

CLASS 16—(Continued).

SN 76-104,750. SMITHKLINE BEECHAM CORPORATION, PHILADELPHIA, PA. FILED 8-7-2000.



OWNER OF U.S. REG. NOS. 1,821,952, 2,144,154 AND OTHERS.

NO CLAIM IS MADE TO THE EXCLUSIVE RIGHT TO USE "AGENT", APART FROM THE MARK AS SHOWN.

THE STIPPLING IS FOR SHADING PURPOSES ONLY AND DOES NOT INDICATE COLOR.

THE MARK CONSISTS OF THE COLORS PURPLE, RED, YELLOW AND WHITE. THE WORD "POSITIVE" IS IN WHITE AND THE SQUARE BACKGROUND AROUND THE WORD "POSITIVE" IS PURPLE. THE LETTERS "I" AND "M" AND THE ARROW THROUGH THE "X" OF "PAX" ARE RED. THE "P" AND THE "A" AND THE LINE WHICH FORMS THE "X" THROUGH THE RED ARROW ARE YELLOW. THE "P" IN "PREFERRED", THE "A" AND "AGENT" AND THE "X" IN "EXCELLENCE" ARE YELLOW AND THE REST OF THE LETTERS IN "PREFERRED AGENT EXCELLENCE" ARE PURPLE.

FOR PRINTED EDUCATIONAL MATERIALS FOR MANAGED CARE ORGANIZATIONS CONCERNING DEPRESSION AND OTHER DISEASES AND DISORDERS OF THE CENTRAL NERVOUS SYSTEM AND TREATMENTS THEREFOR (U.S. CLS. 2, 5, 22, 23, 29, 37, 38 AND 50).

SN 76-113,190. PAPER MAGIC GROUP, INC., THE, WILMINGTON, DE. FILED 8-18-2000.

HOLIDAY SPICE

NO CLAIM IS MADE TO THE EXCLUSIVE RIGHT TO USE "HOLIDAY", APART FROM THE MARK AS SHOWN. FOR GREETING CARDS (U.S. CLS. 2, 5, 22, 23, 29, 37, 38 AND 50).

CLASS 16—(Continued).

SN 76-114,945. XScape PROPERTIES, LIMITED, LONDON, SW-1W 0EN, UNITED KINGDOM, FILED 8-22-2000.



FOR SERIES OF NON-FICTION BOOKS ABOUT SPORTS, LIFESTYLE, ENTERTAINMENT AND LEISURE, EXCLUDING TRAVEL; MAGAZINES ABOUT SPORTS, LIFESTYLES, LEISURE AND ENTERTAINMENT, EXCLUDING TRAVEL; PRINTED MATTER, NAMELY GUIDES FOR SPORTS, LIFESTYLES, ENTERTAINMENT AND LEISURE, EXCLUDING TRAVEL; POSTERS; MOUNTED PHOTOGRAPHS; PICTURES; STATIONERY; WRITING IMPLEMENTS, NAMELY PENCILS, BALLPOINT PENS AND CRAYONS; NOTE-PADS; DRAWING RULERS; CALENDAR DESK PADS; LETTER OPENERS; PENCIL HOLDERS; PENCIL TRAYS; MECHANICAL PENCIL SHARPENERS; PRINTED TEACHING MATERIALS RELATING TO SPORTS, LIFESTYLES, ENTERTAINMENT AND LEISURE, EXCLUDING TRAVEL (U.S. CLS. 2, 5, 22, 23, 29, 37, 38 AND 50).

SN 76-125,812. ADAMS/HUNTER PUBLISHING, INC., CA-THELDRA CITY, CA. FILED 9-8-2000.

THE LUXURY OF TIME

FOR ANNUAL PUBLICATION, NAMELY A MAGAZINE FEATURING TOPICS, PRODUCTS AND INFORMATION OF INTEREST TO PROFESSIONAL JEWELERS, DESIGNERS AND WATCH MAKERS (U.S. CLS. 2, 5, 22, 23, 29, 37, 38 AND 50).

FIRST USE 10-0-1994; IN COMMERCE 10-0-1994.

SN 76-126,172. VAL-PAK DIRECT MARKETING SYSTEMS, INC., LARGO, FL. FILED 9-12-2000.

EXPERTS WHO CAN MAKE YOUR HOME A HAVEN

FOR ENVELOPES, PUBLICATIONS, PAMPHLETS AND COUPON BOOKS WHICH PROMOTE THE GOODS AND SERVICES OF OTHERS (U.S. CLS. 2, 5, 22, 23, 29, 37, 38 AND 50).

SN 76-132,755. BEAR STEARNS COMPANIES INC., THE, NEW YORK, NY. FILED 9-21-2000.

INDUSTRY ADVANTAGE

FOR EQUITY RESEARCH REPORT ON THE ADVERTISING INDUSTRY (U.S. CLS. 2, 5, 22, 23, 29, 37, 38 AND 50).

FIRST USE 3-18-1999; IN COMMERCE 3-18-1999.

CLASS 16—(Continued).

SN 76-135,655. FRANKLIN INTERNATIONAL, INC., COLUMBUS, OH. FILED 9-22-2000.

QUICK & THICK CRAFT AND HOBBY GLUE

NO CLAIM IS MADE TO THE EXCLUSIVE RIGHT TO USE "CRAFT AND HOBBY GLUE", APART FROM THE MARK AS SHOWN.

FOR GLUES FOR CRAFT AND HOBBY PURPOSES (U.S. CLS. 2, 5, 22, 23, 29, 37, 38 AND 50).

SN 76-145,339. GETPRESS.COM, INC., NORWELL, MA. FILED 10-12-2000.

GETPRESS.COM

FOR PUBLIC RELATIONS PRINTED MATERIALS, NAMELY, INFORMATIONAL LETTERS CONCERN PUBLIC RELATIONS, NEWS BULLETINS, NEWS RELEASES FEATURING PUBLIC RELATIONS, NEWSLETTERS ON THE SUBJECT OF PUBLIC RELATIONS, BROCHURES ABOUT PUBLIC RELATIONS AND ANNOUNCEMENT CARDS (U.S. CLS. 2, 5, 22, 23, 29, 37, 38 AND 50).

FIRST USE 9-29-1999; IN COMMERCE 9-29-1999.

SN 76-164,960. ENTOUCH, LLC, SANDY, UT. FILED 11-14-2000.

MTCARDS

FOR PRINTED PAPER PRODUCTS, NAMELY, GREETING AND ANNOUNCEMENT OR INTRODUCTION CARDS, ENVELOPES, STATIONERY, AND PERSONALIZED CARDS, STATIONERY AND/OR ENVELOPES (U.S. CLS. 2, 5, 22, 23, 29, 37, 38 AND 50).

SN 76-165,099. ENTOUCH, LLC, SANDY, UT. FILED 11-14-2000.

MVBABIES

FOR PRINTED PAPER PRODUCTS, NAMELY, GREETING AND ANNOUNCEMENT CARDS, ENVELOPES, STATIONERY, AND PERSONALIZED CARDS, STATIONERY AND/OR ENVELOPES (U.S. CLS. 2, 5, 22, 23, 29, 37, 38 AND 50).

SN 76-175,128. CHANDARIA, SACHEN, NAIROBI, KENYA, FILED 12-4-2000.

SIXTY TWO HUNDRED

FOR ADHESIVE TAPE FOR STATIONERY PURPOSES FOR SCHOOL, HOME AND OFFICE USE (U.S. CLS. 2, 5, 22, 23, 29, 37, 38 AND 50).

CLASS 16—(Continued).

SN 76-181,964. SMITHKLINE BEECHAM CORPORATION, PHILADELPHIA, PA. FILED 12-15-2000.

MY WELLNESS MATTERS

OWNER OF U.S. REG. NOS. 1,928,735, 2,030,617 AND 2,050,611.

NO CLAIM IS MADE TO THE EXCLUSIVE RIGHT TO USE "WELLNESS", APART FROM THE MARK AS SHOWN.

FOR PUBLICATIONS, NAMELY, MAGAZINES IN THE FIELD OF HEALTH (U.S. CLS. 2, 5, 22, 23, 29, 37, 38 AND 50).

SN 76-186,918. ARIZONA PUBLIC SERVICE COMPANY, PHOENIX, AZ. FILED 12-27-2000.

APS PERFORMANCE BUILT HOMES

OWNER OF U.S. REG. NOS. 2,202,754, 2,436,215 AND OTHERS.

NO CLAIM IS MADE TO THE EXCLUSIVE RIGHT TO USE "HOMES", APART FROM THE MARK AS SHOWN.

FOR PRINTED MATERIALS, NAMELY, GUIDE BOOKS AND PAMPHLETS IN THE FIELD OF IMPROVING ENERGY EFFICIENCY AND PERFORMANCE (U.S. CLS. 2, 5, 22, 23, 29, 37, 38 AND 50).

FIRST USE 7-17-2000; IN COMMERCE 7-17-2000.

SN 76-192,003. COGNITIVE SCIENCE SOCIETY, INC., THE, ANN ARBOR, MI. FILED 1-10-2001.

COGNITIVE SCIENCE

SEC. 2(F).

FOR PRINTED MATTER AND PUBLICATIONS, NAMELY, A MULTI-DISCIPLINARY JOURNAL PUBLISHED PERIODICALLY IN FIELDS SUCH AS EDUCATION, LINGUISTICS, NEUROSCIENCE, PHILOSOPHY, PSYCHOLOGY, ANTHROPOLOGY, AND ARTIFICIAL INTELLIGENCE (U.S. CLS. 2, 5, 22, 23, 29, 37, 38 AND 50).

FIRST USE 1-1-1977; IN COMMERCE 1-1-1977.

SN 76-192,007. S. C. JOHNSON HOME STORAGE, INC., RACINE, WI. FILED 1-8-2001.

ULTRAGRIP

FOR PLASTIC FILM FOR HOUSEHOLD USE IN PACKAGING FOOD; AND PLASTIC WRAP (U.S. CLS. 2, 5, 22, 23, 29, 37, 38 AND 50).

CLASS 16—(Continued).

SN 76-208,135. FEDERATION FOR AMERICAN IMMIGRATION REFORM, WASHINGTON, DC. FILED 2-12-2001.



NO CLAIM IS MADE TO THE EXCLUSIVE RIGHT TO USE "PRESS", APART FROM THE MARK AS SHOWN.

FOR BOOKS AND OTHER PUBLICATIONS, NAMELY, BROCHURES AND CIRCULARS, IN THE FIELD OF IMMIGRATION POLICY REFORM (U.S. CLS. 2, 5, 22, 23, 29, 37, 38 AND 50).

SN 76-211,781. WEISS & WINTER GMBH, D-19336 BAD WILSNACK, FED REP GERMANY, FILED 2-16-2001.

GESNER

PRIORITY CLAIMED UNDER SEC. 44(D) ON FED REP GERMANY APPLICATION NO. 30061235.4/1, FILED 8-16-2000.

FOR WRITING INSTRUMENTS, NAMELY, PEN HOLDERS, BALL-POINT PENS, FELT-TIP PENS, THIN PENS, MARKERS, COLORED PENCILS, WAX CRAYONS, POSTER PENS, SLATE PENCILS, PENCILS, CRAYONS, INDELIBLE PENCILS, AND PARTS THEREOF; PAPER AND PAPER PRODUCTS, NAMELY, ART AND DRAWING PAPER, PRINTING PAPER AND PRINTING BLOCKS; BOOKBINDING TAPE, GLUE FOR PAPER AND WRITING MATERIALS, PAINT BRUSHES, OFFICE ARTICLES, NAMELY, DESK PADS; DRAWING RULERS, STENCILS, WRITING INK, INK CONTAINERS FOR WRITING INK, DRAWING INSTRUMENTS, AND PAINTING SETS (U.S. CLS. 2, 5, 22, 23, 29, 37, 38 AND 50).

SN 76-217,053. IN TOUCH MINISTRIES, INC., ATLANTA, GA. FILED 2-28-2001.

PRAYER TOUCH

NO CLAIM IS MADE TO THE EXCLUSIVE RIGHT TO USE "PRAYER", APART FROM THE MARK AS SHOWN.

FOR NEWSLETTERS IN THE FIELDS OF RELIGION, SPIRITUALITY, ETHICS, SOCIAL ISSUES AND LIFESTYLE (U.S. CLS. 2, 5, 22, 23, 29, 37, 38 AND 50).
FIRST USE 2-1-2000; IN COMMERCE 2-1-2000.

CLASS 16—(Continued).

SN 76-217,667. MATHER IV, WALTER F., JACKSON, WY. FILED 3-1-2001.

TRULY WILD

NO CLAIM IS MADE TO THE EXCLUSIVE RIGHT TO USE "WILD", APART FROM THE MARK AS SHOWN.

FOR WILDLIFE AND LANDSCAPE PHOTOGRAPHY MOUNTED AND UNMOUNTED PHOTOGRAPHERS, ART PRINTS, GREETING CARDS, AND CALENDARS (U.S. CLS. 2, 5, 22, 23, 29, 37, 38 AND 50).

SN 76-221,652. FRANKLIN COVEY CO., SALT LAKE CITY, UT. FILED 3-8-2001.

EXECUTION INTELLIGENCE

FOR PUBLICATIONS; NAMELY, BOOKS, MANUALS, GUIDES, PERIODICALS AND PAMPHLETS ALL IN THE FIELD OF CORPORATE LEADERSHIP, EDUCATION, SALES, MANAGEMENT, COMMUNICATIONS, AND PERSONAL ASSESSMENT, MEASUREMENT, DEVELOPMENT (U.S. CLS. 2, 5, 22, 23, 29, 37, 38 AND 50).

SN 76-224,946. SUNSHINE MEDIA, INC., PHOENIX, AZ. FILED 3-12-2001.

RESTAURATEUR

SEC. 2(F).

FOR PUBLICATIONS NAMELY MAGAZINES AND JOURNALS IN THE FIELD OF RESTAURANT MANAGEMENT (U.S. CLS. 2, 5, 22, 23, 29, 37, 38 AND 50).

FIRST USE 2-28-1992; IN COMMERCE 2-28-1992.

SN 76-224,947. SUNSHINE MEDIA, INC., PHOENIX, AZ. FILED 3-12-2001.

BUILDER/ARCHITECT

SEC. 2(F).

FOR PUBLICATIONS, NAMELY, MAGAZINES AND JOURNALS IN THE FIELD OF ARCHITECTURE (U.S. CLS. 2, 5, 22, 23, 29, 37, 38 AND 50).

FIRST USE 12-31-1937; IN COMMERCE 12-31-1937.

SN 76-224,948. SUNSHINE MEDIA, INC., PHOENIX, AZ. FILED 3-12-2001.

RESTAURANT FORUM

SEC. 2(F).

FOR PUBLICATIONS, NAMELY, MAGAZINES AND JOURNALS IN THE FIELD OF RESTAURANT MANAGEMENT (U.S. CLS. 2, 5, 22, 23, 29, 37, 38 AND 50).

FIRST USE 2-28-1992; IN COMMERCE 2-28-1992.

CLASS 16—(Continued).

SN 76-224,949. SUNSHINE MEDIA, INC., PHOENIX, AZ. FILED 3-12-2001.

CLASS 16—(Continued).

SN 76-229,361. LUCASFILM LTD, NICASIO, CA. FILED 3-22-2001.

M.D. NEWS

NO CLAIM IS MADE TO THE EXCLUSIVE RIGHT TO USE "NEWS", APART FROM THE MARK AS SHOWN. SEC. 2(F).
FOR PUBLICATIONS NAMELY MAGAZINES AND JOURNALS IN THE FIELD OF MEDICINE (U.S. CLS. 2, 5, 22, 23, 29, 37, 38 AND 50).
FIRST USE 9-30-1993; IN COMMERCE 9-30-1993.

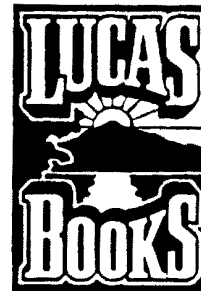

NO CLAIM IS MADE TO THE EXCLUSIVE RIGHT TO USE "BOOKS", APART FROM THE MARK AS SHOWN.
FOR PAPER GOODS AND PRINTED MATTER, NAMELY, CHILDREN'S ACTIVITY BOOKS; COMIC BOOKS; COLORING BOOKS; PICTURE BOOKS; CHILDREN'S BOOKS; BOOKS ON MOVIE-MAKING; BOOKS CONTAINING PUZZLES AND GAMES; GRAPHIC NOVELS; BOOKS CONTAINING SCREENPLAYS; SCRIPT BOOKS; NOVELIZATIONS OF MOTION PICTURES; MAGAZINES IN THE FIELD OF SCIENCE FICTION; SCRAPBOOK ALBUMS; COLLECTOR ALBUMS; ORIGINAL ARTWORK PRINTS; POSTERS; STICKER BOOKS; SHEET MUSIC; READ-ALONG BOOKS AND PRE-RECORDED AUDIO CASSETTE TAPES SOLD AS A UNIT; BOOKS FEATURING PHOTOGRAPHIC PRINTS (U.S. CLS. 2, 5, 22, 23, 29, 37, 38 AND 50).
FIRST USE 5-3-1999; IN COMMERCE 5-3-1999.

SN 76-226,024. ZEPHYR PRESS, INC., TUCSON, AZ. FILED 3-16-2001.



SN 76-229,686. SOTRAFA, S.A., 04007 EL EJIDO (ALMERIA), SPAIN, FILED 3-23-2001.

GREENBAG SOTRAFA

NO CLAIM IS MADE TO THE EXCLUSIVE RIGHT TO USE "PRESS", APART FROM THE MARK AS SHOWN.
THE MARK CONSISTS OF THE WORDING "ZEPHYR PRESS" AND THE LETTER "Z" FORMED WITH WAVY LINES.
FOR BOOKS, POSTERS, WORKBOOKS, ACTIVITY BOOKS, AND TEACHER TRAINING MANUALS, ALL ON A WIDE RANGE OF EDUCATIONAL TOPICS FOR EDUCATORS AND STUDENTS AND PRE-SCHOOL THROUGH COLLEGE LEVELS (U.S. CLS. 2, 5, 22, 23, 29, 37, 38 AND 50).
FIRST USE 2-24-2001; IN COMMERCE 2-24-2001.

NO CLAIM IS MADE TO THE EXCLUSIVE RIGHT TO USE "GREENBAG", APART FROM THE MARK AS SHOWN.
FOR PLASTIC MATTERS FOR PACKAGING, NAMELY, PLASTIC BAGS FOR GENERAL UTILITY, AND PLASTIC SHEETS AND FILM FOR WRAPPING AND PACKAGING (U.S. CLS. 2, 5, 22, 23, 29, 37, 38 AND 50).

CLASS 16—(Continued).

SN 76-229,747. DICKIE WALKER MARINE, INC., LA JOLLA, CA. FILED 3-26-2001.



NO CLAIM IS MADE TO THE EXCLUSIVE RIGHT TO USE "BUILT 1951" AND "AUTHENTIC MARINE", APART FROM THE MARK AS SHOWN.

THE STIPPLING IN THE MARK IS FOR SHADING PURPOSES ONLY.

THE NAME "DICKIE WALKER" IS THE NAME OF A BOAT AND NOT THE NAME OF ANY KNOWN OR PARTICULAR LIVING INDIVIDUAL.

FOR PRINTED MATTER, NAMELY, PICTURE BOOKS, APPOINTMENT BOOKS, PHOTO ALBUMS, LOG BOOKS, NOTE BOOKS, MEMO PADS, DIARIES, ART AND GREETING CARDS, FINE ART PRINTS, MAPS, CALENDARS, TIDE CHARTS, POSTERS, PLAYING CARDS, STATIONARY, PENS AND PENCILS AND CASES THEREFOR, CARTOGRAPHIC AND DRAFTING INSTRUMENTS, DRAFTING RULERS, DESK SETS, WRITING PAPER, POST CARDS, GIFT WRAP AND PAPER WEIGHTS (U.S. CLS. 2, 5, 22, 23, 29, 37, 38 AND 50).

SN 76-231,828. CELEBRITY WORLDWIDE INC., VALLEY STREAM, NY. FILED 3-29-2001.

HOLLYWOOD WORLDWIDE BLACK HAIRSTYLES & TRENDS

NO CLAIM IS MADE TO THE EXCLUSIVE RIGHT TO USE "BLACK HAIRSTYLES & TRENDS", APART FROM THE MARK AS SHOWN.

FOR NATIONALLY CIRCULATED NEWSSTAND AND SUBSCRIPTION MAGAZINE FOR WOMEN FEATURING HAIRSTYLES, FASHION, AND LIFESTYLE TRENDS (U.S. CLS. 2, 5, 22, 23, 29, 37, 38 AND 50).

FIRST USE 3-16-2001; IN COMMERCE 3-16-2001.

SN 76-233,687. HALLMARK LICENSING, INC., KANSAS CITY, MO. FILED 3-30-2001.

GOD ALWAYS HAS A PLAN B

FOR SERIES OF FICTION AND NON-FICTION BOOKS IN THE FIELD OF INSPIRATION AND SELF-ESTEEM (U.S. CLS. 2, 5, 22, 23, 29, 37, 38 AND 50).

CLASS 16—(Continued).

SN 76-234,170. S.E. INC., KANAGAWA, JAPAN, FILED 4-2-2001.

DELETER

FOR COMIC SKETCH PAPER, COMIC BOOK PAPER, COMIC MANUSCRIPT PAPER, COMIC SECTION PAPER, COMIC SKETCH BOOKS, DRAWING SHIELDS, DRAWING BOARDS, COPY DUPLICATING INK, PENS, PEN HOLDERS, WHITE INK, COMIC BEGINNER'S SETS COMPRISED OF AN INSTRUCTIONAL MAGAZINE, COMIC BOOK PAPER, A BRUSH, PEN TIPS AND INK, DRAWING PENS, WRITING INK, MARKERS AND PEN TIPS (U.S. CLS. 2, 5, 22, 23, 29, 37, 38 AND 50).

FIRST USE 5-1-1987; IN COMMERCE 8-19-2000.

SN 76-249,078. NXLEVEL EDUCATION FOUNDATION, CHEYENNE, WY. FILED 4-16-2001.

NXLEVEL TRAINING NETWORK

NO CLAIM IS MADE TO THE EXCLUSIVE RIGHT TO USE "TRAINING NETWORK", APART FROM THE MARK AS SHOWN.

FOR BOOKS IN THE FIELD OF BUSINESS AND PRINTED EDUCATIONAL MATERIALS IN THE FIELD OF BUSINESS (U.S. CLS. 2, 5, 22, 23, 29, 37, 38 AND 50).

FIRST USE 1-1-1996; IN COMMERCE 1-1-1996.

SN 76-249,498. BROWN, ALLISON, STATE COLLEGE, PA. FILED 4-30-2001.

CHASE THE WIND

FOR BOOKS IN THE FIELD OF TRAVEL AND FOOD (U.S. CLS. 2, 5, 22, 23, 29, 37, 38 AND 50).

SN 76-255,477. TIME4 MEDIA, INC., NEW YORK, NY. FILED 5-14-2001.

TRANSWORLD BMX

OWNER OF U.S. REG. NOS. 2,307,131, 2,382,801 AND OTHERS.

NO CLAIM IS MADE TO THE EXCLUSIVE RIGHT TO USE "BMX", APART FROM THE MARK AS SHOWN.

FOR MAGAZINE IN THE FIELD OF SPORTS (U.S. CLS. 2, 5, 22, 23, 29, 37, 38 AND 50).

FIRST USE 4-2-2001; IN COMMERCE 4-2-2001.

CLASS 16—(Continued).

SN 76-262,905. GROUNDSSWELL, L.L.C., BINGHAM FARMS, MI. FILED 5-29-2001.

CAFFEINATED GREETING CARDS

NO CLAIM IS MADE TO THE EXCLUSIVE RIGHT TO USE "GREETING CARDS", APART FROM THE MARK AS SHOWN.

FOR ALBUMS, NAMELY, PHOTOGRAPH ALBUMS, SCRAPBOOK ALBUMS; PAPER PARTY BAGS, PLASTIC BAGS, ENVELOPES, AND POUCHES FOR MERCHANDISE PACKAGING, PAPER BAGS, ENVELOPES, AND POUCHES FOR MERCHANDISING PACKAGING; BOOKS, NAMELY ADDRESS BOOKS, APPOINTMENT BOOKS, CHILDREN'S ACTIVITY BOOKS, COLORING BOOKS, DATE BOOKS, MEMORANDUM BOOKS, NOTEBOOKS, PICTURE BOOKS, TELEPHONE NUMBER BOOKS, SCRAPBOOKS, BOOK COVERS, BOOK MARKS; BOXES, NAMELY PAPER BOXES, PENCIL BOXES; CALENDARS, NAMELY, DESK CALENDARS, POCKET CALENDARS, WALL CALENDARS, CALENDAR DESK PADS; CARDS, NAMELY, BLANK CARDS, ANNOUNCEMENT CARDS, CHRISTMAS CARDS, GREETING CARDS, PLAYING CARDS; CASES, NAMELY, PEN CASES, PENCIL CASES, PLAYING CARD CASES; GIFT WRAPPING PAPER, METALLIC GIFT WRAP, PAPER RIBBONS FOR GIFT WRAPPING; LOOSE LEAF BINDERS, LOOSE LEAF PAPER, WRITING PADS, SCRATCH PADS; STATIONARY-TYPE PORTFOLIOS; PENS, NAMELY, BALL-POINT PENS, FOUNTAIN PENS, INK PENS, PENCILS, PEN AND PENCIL TRAYS, PEN HOLDERS, PENCIL HOLDERS (U.S. CLS. 2, 5, 22, 23, 29, 37, 38 AND 50).

SN 76-263,641. 'NOTHER COMPANY, LLC, NEW YORK, NY. FILED 5-25-2001.

100 THINGS TO DO BEFORE YOU DIE

FOR PRINTED MATTER, NAMELY, A SERIES OF BOUND BOOKS FEATURING TRAVEL RELATED CONTENT OF AND CONCERNING ALTERNATIVE VACATION DESTINATIONS (U.S. CLS. 2, 5, 22, 23, 29, 37, 38 AND 50).

FIRST USE 11-1-1999; IN COMMERCE 11-1-1999.

SN 76-265,300. PLAID ENTERPRISES, INC., NORCROSS, GA. FILED 5-30-2001.

MAGIC CANVAS

FOR PATTERNS FOR TRACING DESIGNS, PLASTIC TRACING SHEETS FOR TRANSPOSING ARTWORK AND DESIGNS, PAINT BRUSHES AND PRINTED INSTRUCTION SHEETS (U.S. CLS. 2, 5, 22, 23, 29, 37, 38 AND 50).

CLASS 16—(Continued).

SN 76-265,580. RIEAD, JAMES W., EGG HARBOR, WI. FILED 6-2-2001.

THE WORLD'S VOICE

FOR MAGAZINES CONTAINING INFORMATION ON TRAVEL TO FOREIGN COUNTRIES AND ON INTERPRETATION OF FOREIGN LANGUAGES SPOKEN IN FOREIGN COUNTRIES (U.S. CLS. 2, 5, 22, 23, 29, 37, 38 AND 50).

SN 76-266,664. IBU, INC., HARTFORD, CT. FILED 6-4-2001.

IBU

FOR QUESTIONNAIRES ON INDIVIDUAL LIFE AND HEALTH INSURANCE RISK EVALUATIONS (U.S. CLS. 2, 5, 22, 23, 29, 37, 38 AND 50).

FIRST USE 6-28-2000; IN COMMERCE 6-28-2000.

SN 76-273,226. VOICE OF GOD RECORDINGS, INC., JEFFERSONVILLE, IN. FILED 6-20-2001.

VOGR

OWNER OF U.S. REG. NO. 2,341,000.
FOR BOOKS - NAMELY-RELIGIOUS BOOKS FEATURING RELIGIOUS SERMONS (U.S. CLS. 2, 5, 22, 23, 29, 37, 38 AND 50).

SN 76-276,683. STECK-VAUGHN COMPANY, AUSTIN, TX. FILED 6-26-2001.



OWNER OF U.S. REG. NO. 2,299,950.
NO CLAIM IS MADE TO THE EXCLUSIVE RIGHT TO USE "PHONICS" OR "BOOKS", APART FROM THE MARK AS SHOWN.

FOR SERIES OF BOOKS, TEACHER'S GUIDES AND POSTERS FOR TEACHING READING (U.S. CLS. 2, 5, 22, 23, 29, 37, 38 AND 50).

FIRST USE 7-18-2001; IN COMMERCE 7-18-2001.

CLASS 16—(Continued).

SN 76-289,516. TECHNOLOGY MARKETING CORPORATION, NORWALK, CT. FILED 7-24-2001.

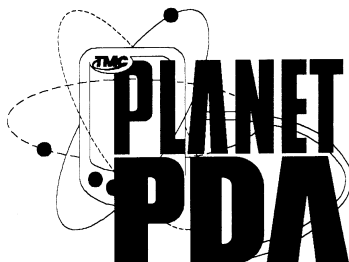

NO CLAIM IS MADE TO THE EXCLUSIVE RIGHT TO USE "PDA", APART FROM THE MARK AS SHOWN.

FOR MAGAZINES IN THE FIELD OF BUSINESS COMMUNICATIONS PRODUCTS, SERVICES AND TECHNOLOGIES (U.S. CLS. 2, 5, 22, 23, 29, 37, 38 AND 50).

SN 76-291,334. PEDAGO ENTERPRISES INC., CALGARY, ALBERTA T3G 4G8, CANADA, FILED 7-26-2001.



PRIORITY CLAIMED UNDER SEC. 44(D) ON CANADA APPLICATION NO. 1090723, FILED 1-29-2001.

FOR CHILDREN'S BOOKS AND PICTURE BOOKS; POSTERS; PAPER BOOKMARKS; STENCILS; STATIONERY; STICKERS; EDUCATIONAL AND ART KITS FOR THE PURPOSE OF CONSTRUCTING PAPER PICTURE BOOKS; POSTCARDS; AND GREETING CARDS (U.S. CLS. 2, 5, 22, 23, 29, 37, 38 AND 50).

SN 76-292,609. PANLINE, USA, NORTHVALE, NJ. FILED 7-31-2001.

ART BOOK TO GO

FOR ARTS AND CRAFTS ACTIVITY KIT FOR CHILDREN WHICH CONTAINS A ZIPPERED CASE WITH A STORAGE POUCH CONTAINING WIPE OFF MARKERS, ERASER, AND ACTIVITY BOOK AND A KEY CHAIN (U.S. CLS. 2, 5, 22, 23, 29, 37, 38 AND 50).

FIRST USE 2-14-2000; IN COMMERCE 2-14-2000.

CLASS 16—(Continued).

SN 76-293,587. METUCHEN SCIENTIFIC, DBA SPEX CERTIPREP, METUCHEN, NJ. FILED 8-1-2001.

SPEXERTIFICATE

FOR SERIES OF PRINTED INFORMATION FORMS THAT ARE AN ESSENTIAL COMPONENT OF CHEMICAL REFERENCE STANDARDS FOR LABORATORY AND OTHER USE, NAMELY, FORMS ATTESTING TO THE COMPOSITION AND PURITY OF SAID CHEMICAL REFERENCE STANDARDS (U.S. CLS. 2, 5, 22, 23, 29, 37, 38 AND 50).

SN 76-296,485. OSHKOSH B'GOSH, INC., OSHKOSH, WI. FILED 8-8-2001.

OSHKOSH

OWNER OF U.S. REG. NOS. 511,479, 2,504,676 AND OTHERS.
SEC. 2(F).

FOR DISPOSABLE BABY DIAPERS (U.S. CLS. 2, 5, 22, 23, 29, 37, 38 AND 50).

SN 76-297,855. SCHOLASTIC INC., NEW YORK, NY. FILED 8-10-2001.

DINOSITOS

FOR SERIES OF SPANISH-LANGUAGE BOOKS FOR CHILDREN (U.S. CLS. 2, 5, 22, 23, 29, 37, 38 AND 50).

SN 76-303,539. J.H. MCNAIRN LIMITED, WHITBY, ONTARIO, CANADA, FILED 8-23-2001.

E-BAKE

FOR BAKING PAN LINERS MADE OF PAPER (U.S. CLS. 2, 5, 22, 23, 29, 37, 38 AND 50).
FIRST USE 4-0-2001; IN COMMERCE 4-0-2001.

SN 76-305,314. F.R.E. PRODUCTIONS, LLC, NEWARK, NJ. FILED 8-27-2001.

F.R.E. PRODUCTIONS

NO CLAIM IS MADE TO THE EXCLUSIVE RIGHT TO USE "PRODUCTIONS", APART FROM THE MARK AS SHOWN.

FOR PRINTED MATTER RELATING TO MUSIC, NAMELY, MUSIC BOOKS, SHEET MUSIC, COMPACT DISK COVER INSERT PAMPHLETS (U.S. CLS. 2, 5, 22, 23, 29, 37, 38 AND 50).

CLASS 16—(Continued).

SN 76-316,283. KIMBERLY-CLARK CORPORATION, NEENAH, WI. FILED 9-24-2001.

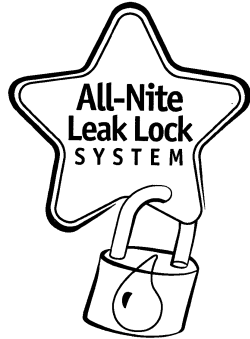

OWNER OF U.S. REG. NO. 2,450,246.
NO CLAIM IS MADE TO THE EXCLUSIVE RIGHT TO USE "SYSTEM", APART FROM THE MARK AS SHOWN.
FOR DISPOSABLE DIAPERS AND COMPONENTS THEREOF (U.S. CLS. 2, 5, 22, 23, 29, 37, 38 AND 50).
FIRST USE 9-19-2001; IN COMMERCE 9-19-2001.

SN 76-319,929. HANDBOOKS IN HEALTH CARE CO., A DIVISION OF ASSOCIATES IN MEDICAL MARKETING CO., INC., NEWTOWN, PA. FILED 10-1-2001.

CONTEMPORARY DIAGNOSIS AND MANAGEMENT OF UROLOGIC EMERGENCIES

OWNER OF U.S. REG. NOS. 1,856,730, 2,156,592 AND OTHERS.
NO CLAIM IS MADE TO THE EXCLUSIVE RIGHT TO USE "DIAGNOSIS AND MANAGEMENT OF UROLOGIC EMERGENCIES", APART FROM THE MARK AS SHOWN.
FOR SERIES OF PERIODICALLY REVISED MEDICAL REFERENCE BOOKS (U.S. CLS. 2, 5, 22, 23, 29, 37, 38 AND 50).
FIRST USE 7-0-2001; IN COMMERCE 7-0-2001.

SN 76-321,060. MOOSE MEDIA, INC., MINNEAPOLIS, MN. FILED 10-3-2001.

UBOOK

FOR MEMORY BOOKS, WHICH CAN BE CUSTOMIZED THROUGH THE USE OF PERSONAL PHOTOGRAPHS AND OTHER ORIGINAL ARTWORK (U.S. CLS. 2, 5, 22, 23, 29, 37, 38 AND 50).

CLASS 16—(Continued).

SN 76-322,531. NLP IP COMPANY, WILMINGTON, DE. FILED 10-9-2001.

THE MOBILE LAWYER

NO CLAIM IS MADE TO THE EXCLUSIVE RIGHT TO USE "LAWYER", APART FROM THE MARK AS SHOWN.
FOR LEGAL PUBLICATIONS, NAMELY, A MAGAZINE PERTAINING TO THE LEGAL FIELD (U.S. CLS. 2, 5, 22, 23, 29, 37, 38 AND 50).
FIRST USE 7-0-2000; IN COMMERCE 9-0-2000.

SN 76-325,595. DEAN, ELIZABETH CUMMINS, FLINT, MI. FILED 10-15-2001.

TIDY FIDO

FOR PLASTIC BAGS WITH ATTACHED PAPER TOWELS FOR DISPOSING OF PET WASTE (U.S. CLS. 2, 5, 22, 23, 29, 37, 38 AND 50).

SN 76-325,919. NELSON ADVANTAGE, INC., THE, TUCKER, GA. FILED 10-16-2001.

TODAY'S HOSPITALITY

NO CLAIM IS MADE TO THE EXCLUSIVE RIGHT TO USE "HOSPITALITY", APART FROM THE MARK AS SHOWN.

FOR PRINTED MATTER, NAMELY, MAGAZINES PROVIDING INFORMATION FOR AND ABOUT THE HOTEL AND MOTEL INDUSTRIES (U.S. CLS. 2, 5, 22, 23, 29, 37, 38 AND 50).

SN 76-327,581. MAGAZINE LIMITED PARTNERS, L.P., DALLAS, TX. FILED 10-19-2001.

SUMMIT THE MAGAZINE OF THOUGHT LEADERSHIP

FOR PERIODICALLY PRINTED MAGAZINES FEATURING BUSINESS, TECHNOLOGY, AND GOVERNMENTAL ISSUES (U.S. CLS. 2, 5, 22, 23, 29, 37, 38 AND 50).

CLASS 16—(Continued).

SN 76-329,636. MISSION CITY PRESS, INC., SAN ANTONIO, TX. FILED 10-24-2001.

VIOLET TRAVILLA

FOR PRINTED MATTER, NAMELY, A CHRISTIAN FICTION BOOK SERIES; CHRISTIAN STUDY GUIDES; CHILDREN'S ACTIVITY BOOKS ABOUT TEA PARTIES; BOOKS RELATING TO PERSONAL ISSUES AND ADVICE ABOUT TEMPTATION, FEAR, AND REJECTION, AND SPIRITUAL ISSUES AND ADVICE; JOURNALS, AGENDA, AND DIARIES WHICH CONTAIN CHRISTIAN AND SPIRITUAL MESSAGES OR THEMES (U.S. CLS. 2, 5, 22, 23, 29, 37, 38 AND 50).

SN 76-329,781. HASBRO, INC., PAWTUCKET, RI. FILED 10-25-2001.

CANDYLAND

OWNER OF U.S. REG. NO. 544,328.
FOR PLAYING CARDS (U.S. CLS. 2, 5, 22, 23, 29, 37, 38 AND 50).

SN 76-330,330. O'MEARA, JENNIFER, EVERGREEN, CO. FILED 10-25-2001.

WINDOW GARDENS

FOR ART PRINTS, DIGITAL ART PRINTS, FRAMED ART PRINTS AND FRAMED DIGITAL ART PRINTS (U.S. CLS. 2, 5, 22, 23, 29, 37, 38 AND 50).

SN 76-331,920. VAN RODEN, INC., DBA WELLSRING, YORK, PA. FILED 10-31-2001.

MEMO MATE

OWNER OF U.S. REG. NO. 1,984,720.
FOR NOTE PADS (U.S. CLS. 2, 5, 22, 23, 29, 37, 38 AND 50).
FIRST USE 1-10-1995; IN COMMERCE 2-17-1995.

SN 76-332,333. EVEREADY BATTERY COMPANY, INC., ST. LOUIS, MO. FILED 10-30-2001.

ENERGIZER

OWNER OF U.S. REG. NOS. 1,177,083, 2,044,427 AND OTHERS.
FOR PEN AND PENCIL TOPPERS (U.S. CLS. 2, 5, 22, 23, 29, 37, 38 AND 50).
FIRST USE 7-20-2000; IN COMMERCE 7-20-2000.

CLASS 16—(Continued).

SN 76-333,836. MEAD CORPORATION, THE, DAYTON, OH. FILED 11-5-2001.

STREET SENSE

OWNER OF U.S. REG. NO. 2,457,969.
FOR NOTEBOOKS AND PADS, STATIONERY-TYPE PORTFOLIOS, BINDERS, DATE PLANNERS, ASSIGNMENT BOOKS AND PENCIL POUCHES (U.S. CLS. 2, 5, 22, 23, 29, 37, 38 AND 50).

SN 76-334,910. TODD HARRISON & ASSOCIATES, INC., NEW YORK, NY. FILED 11-6-2001.

HOOFY AND BOO

FOR COMIC STRIPS AND FINANCIAL CARTOONS IN THE FIELDS OF STOCK MARKET, STOCK MARKET MOVEMENT AND INVESTMENT ADVICE (U.S. CLS. 2, 5, 22, 23, 29, 37, 38 AND 50).

SN 76-334,911. TODD HARRISON & ASSOCIATES, INC., NEW YORK, NY. FILED 11-6-2001.

HOOFY

FOR COMIC STRIPS AND FINANCIAL CARTOONS IN THE FIELDS OF STOCK MARKET, STOCK MARKET MOVEMENT AND INVESTMENT ADVICE (U.S. CLS. 2, 5, 22, 23, 29, 37, 38 AND 50).

SN 76-335,479. RADER, FISHMAN & GRAUER PLLC, BLOOMFIELD HILLS, MI. FILED 11-7-2001.

INTELLECTUAL PROPERTY MATTERS

NO CLAIM IS MADE TO THE EXCLUSIVE RIGHT TO USE "INTELLECTUAL PROPERTY", APART FROM THE MARK AS SHOWN.
FOR PERIODIC PUBLICATIONS, NAMELY, NEWSLETTERS IN THE LEGAL FIELD (U.S. CLS. 2, 5, 22, 23, 29, 37, 38 AND 50).
FIRST USE 11-1-2001; IN COMMERCE 11-1-2001.

SN 76-335,750. UNITED STATES PLAYING CARD COMPANY, THE, CINCINNATI, OH. FILED 11-8-2001.

BICYCLE RUMMY

NO CLAIM IS MADE TO THE EXCLUSIVE RIGHT TO USE "RUMMY", APART FROM THE MARK AS SHOWN.
FOR PLAYING CARDS (U.S. CLS. 2, 5, 22, 23, 29, 37, 38 AND 50).
FIRST USE 10-22-1990; IN COMMERCE 10-22-1990.

CLASS 16—(Continued).

SN 76-337,069. NELSON, MICHAEL T., SACRAMENTO, CA.
FILED 11-8-2001.

TERRORIST TRACKING TRADING CARDS

NO CLAIM IS MADE TO THE EXCLUSIVE RIGHT TO USE "TERRORIST" AND "TRADING CARDS", APART FROM THE MARK AS SHOWN.

FOR TRADING CARDS (U.S. CLS. 2, 5, 22, 23, 29, 37, 38 AND 50).

SN 76-338,334. NEPTUNE, CINDY L., SOLANA BEACH, CA.
FILED 11-13-2001.

A UNIQUE CHILDHOOD TIME CAPSULE

FOR DECORATIVE PAPER PRODUCTS, NAMELY, KEEPSAKE STATIONERY BOXES WITH STATIONERY INSIDE; PRE-PACKAGED STATIONERY, WRITING PAPER AND ENVELOPES; NOTE PAPER, BOXED NOTE CARDS (U.S. CLS. 2, 5, 22, 23, 29, 37, 38 AND 50).

FIRST USE 2-17-2001; IN COMMERCE 2-17-2001.

SN 76-338,645. PREDICT SUCCESS, LLC, LOS ANGELES, CA.
FILED 11-15-2001.

PREDICT SUCCESS

FOR SERIES OF BOOKS RELATING TO COMPETENCY-BASED ASSESSMENT PROCEDURES IN THE EMPLOYEE HIRING AND RECRUITMENT FIELD (U.S. CLS. 2, 5, 22, 23, 29, 37, 38 AND 50).

FIRST USE 11-0-1999; IN COMMERCE 11-0-1999.

SN 76-338,781. PAPERLOOP.COM, INC., SAN FRANCISCO, CA. FILED 11-16-2001.

PULP & PAPER PROJECT REPORT

OWNER OF U.S. REG. NO. 1,234,104.
NO CLAIM IS MADE TO THE EXCLUSIVE RIGHT TO USE "REPORT", APART FROM THE MARK AS SHOWN.
SEC. 2(F).

FOR MONTHLY NEWSLETTER CONCERNING CAPITAL EXPENDITURES IN THE PAPER INDUSTRY (U.S. CLS. 2, 5, 22, 23, 29, 37, 38 AND 50).

FIRST USE 11-0-1981; IN COMMERCE 11-0-1981.

CLASS 16—(Continued).

SN 76-338,782. PAPERLOOP.COM, INC., SAN FRANCISCO, CA. FILED 11-16-2001.

PULP & PAPER WEEK

OWNER OF U.S. REG. NO. 1,175,577.

NO CLAIM IS MADE TO THE EXCLUSIVE RIGHT TO USE "WEEK", APART FROM THE MARK AS SHOWN.

SEC. 2(F).

FOR WEEKLY NEWSLETTER FOR THE PULP AND PAPER INDUSTRY (U.S. CLS. 2, 5, 22, 23, 29, 37, 38 AND 50).

FIRST USE 3-0-1979; IN COMMERCE 3-0-1979.

SN 76-339,122. STECK-VAUGHN COMPANY, AUSTIN, TX.
FILED 11-16-2001.

POWER UP! BUILDING READING STRENGTH

FOR PRINTED MATERIALS, NAMELY, A SERIES OF BOOKS FOR TEACHING READING (U.S. CLS. 2, 5, 22, 23, 29, 37, 38 AND 50).

SN 78-002,547. STAMATS COMMUNICATIONS, INC., CEDAR RAPIDS, IA. FILED 4-4-2000.

MEETINGS WEST

OWNER OF U.S. REG. NOS. 1,808,657, 2,170,515 AND 2,244,025.

NO CLAIM IS MADE TO THE EXCLUSIVE RIGHT TO USE "MEETINGS", APART FROM THE MARK AS SHOWN.

FOR MAGAZINES IN THE FIELD OF ORGANIZING, PLANNING AND CONDUCTING MEETINGS, SEMINARS AND CONVENTIONS (U.S. CLS. 2, 5, 22, 23, 29, 37, 38 AND 50).

SN 78-031,100. FRANTZEN, ROALD, C., HUNTERSVILLE, NC. FILED 10-18-2000.

DIGITCOLOR

FOR HIGH GLOSS AND MATTE INK JET AND LASER PRINTABLE PAPER FOR DIGITAL REPRODUCTION (U.S. CLS. 2, 5, 22, 23, 29, 37, 38 AND 50).

FIRST USE 9-15-1998; IN COMMERCE 9-15-1998.

CLASS 16—(Continued).

SN 78-035,344. NBA PROPERTIES, INC., NEW YORK, NY.
FILED 11-15-2000.



FOR PUBLICATIONS AND PRINTED MATTER, NAMELY BASKETBALL TRADING CARDS, DANCE TEAM TRADING CARDS, MASCOT TRADING CARDS, ENTERTAINMENT TRADING CARDS, STICKERS, DECALS, COMMEMORATIVE BASKETBALL STAMPS, COLLECTIBLE CARDBOARD TRADING DISCS, MEMO BOARDS, CLIPBOARDS, PAPER COASTERS, POST CARDS, PLACE MATS OF PAPER AND PLASTIC, NOTE CARDS, MEMO PADS, BALL POINT PENS, PENCILS, PEN AND PAPER HOLDERS, DESK TOP DOCUMENT STANDS, SCRAP BOOKS, RUBBER STAMPS, PAPER BANNERS AND FLAGS, BOOKMARKS, 3-RING BINDERS, STATIONERY FOLDERS, WIREBOUND NOTEBOOKS, PORTFOLIO NOTEBOOKS, UNMOUNTED AND MOUNTED PHOTOGRAPHS, POSTERS, CALENDARS, BUMPER STICKERS, BOOK COVERS, WRAPPING PAPER, CHILDREN'S ACTIVITY BOOKS, STATISTICAL BOOKS, GUIDE BOOKS AND REFERENCE BOOKS FOR BASKETBALL, MAGAZINES IN THE FIELD OF BASKETBALL, COMMEMORATIVE BASKETBALL GAME PROGRAMS, PAPER PENNANTS, STATIONERY, STATIONERY-TYPE PORTFOLIOS, AND STATISTICAL SHEETS FOR BASKETBALL TOPICS, NEWSLETTERS AND PAMPHLETS IN THE FIELD OF BASKETBALL, BANK CHECKS, CREDIT CARDS AND TELEPHONE CALLING CARDS NOT MAGNETICALLY ENCODED, ALBUMS, NAMELY, PHOTOGRAPH ALBUMS, SCRAPBOOKS ALBUMS, TRADING CARD ALBUMS (U.S. CLS. 2, 5, 22, 23, 29, 37, 38 AND 50).

SN 78-043,165. BALMER, ALDEN J., ROUND ROCK, TX.
FILED 1-15-2001.

DOC FIZZIX

NO CLAIM IS MADE TO THE EXCLUSIVE RIGHT TO USE "PHYSICS", APART FROM THE MARK AS SHOWN.

FOR SERIES OF NON-FICTION BOOKS RELATED TO MOUSETRAP POWERED VEHICLES FOR SCIENCE PROJECTS ALL SOLD TO HOBBY STORES, STUDENTS, AND TEACHERS (U.S. CLS. 2, 5, 22, 23, 29, 37, 38 AND 50).

FIRST USE 1-3-1997; IN COMMERCE 2-10-1997.

CLASS 16—(Continued).

SN 78-045,097. JANKOWSKI, KELLEY A., HAMPSTEAD, MD. FILED 1-26-2001.

"POTTED PENS"

NO CLAIM IS MADE TO THE EXCLUSIVE RIGHT TO USE "PENS", APART FROM THE MARK AS SHOWN.

FOR PENS, NAMELY, PENS WITH SILK FLOWERS ATTACHED TO THE END OF EACH PEN AND SOLD IN A POT TO CREATE THE APPEARANCE OF A FLOWER ARRANGEMENT (U.S. CLS. 2, 5, 22, 23, 29, 37, 38 AND 50).

SN 78-051,959. SANTA BARBARA CONTEMPORARY ART FORM, SANTA BARBARA, CA. FILED 3-8-2001.

**YES, AS A MATTER OF FACT,
WE DO CALL IT ART.**

FOR PAPER GOODS, NAMELY BUMPER STICKERS (U.S. CLS. 2, 5, 22, 23, 29, 37, 38 AND 50).

FIRST USE 11-0-1999; IN COMMERCE 12-0-1999.

SN 78-053,525. AKRON REGIONAL DEVELOPMENT BOARD EDUCATIONAL FUND, AKRON, OH. FILED 3-16-2001.



NO CLAIM IS MADE TO THE EXCLUSIVE RIGHT TO USE "BUSINESS & EDUCATION NETWORK", APART FROM THE MARK AS SHOWN.

FOR EDUCATIONAL AND INSTRUCTIONAL MATERIALS, NAMELY, BOOKS, MANUALS AND BROCHURES FEATURING INFORMATION ABOUT CONNECTING STUDENTS TO THE WORKFORCE, EDUCATING STUDENTS ABOUT WORK AND TEACHING WORK ETHICS TO STUDENTS (U.S. CLS. 2, 5, 22, 23, 29, 37, 38 AND 50).

FIRST USE 10-17-2000; IN COMMERCE 10-17-2000.

CLASS 16—(Continued).

SN 78-069,090. SAPPI NETHERLANDS B.V., 6211 AA MAAS-TRICHT, NETHERLANDS, FILED 6-14-2001.

ROYAL XPRESS

PRIORITY CLAIMED UNDER SEC. 44(D) ON BENELUX APPLICATION NO. 0982585, FILED 1-30-2001, REG. NO. 0682487, DATED 1-30-2001, EXPIRES 1-30-2011.

OWNER OF U.S. REG. NOS. 1,764,406 AND 2,438,072.
FOR UNPRINTED PRINTING PAPER (U.S. CLS. 2, 5, 22, 23, 29, 37, 38 AND 50).

SN 78-085,481. PNS & WSS, INC., THOROFARE, NJ. FILED 9-25-2001.

TODAY IN CARDIOLOGY

NO CLAIM IS MADE TO THE EXCLUSIVE RIGHT TO USE "CARDIOLOGY", APART FROM THE MARK AS SHOWN.

FOR MEDICAL NEWSPAPER (U.S. CLS. 2, 5, 22, 23, 29, 37, 38 AND 50).

SN 78-091,903. CLARKE AMERICAN CHECKS, INC., SAN ANTONIO, TX. FILED 11-6-2001.

LET FREEDOM RING

FOR BANK CHECKS (U.S. CLS. 2, 5, 22, 23, 29, 37, 38 AND 50).

SN 78-092,804. INLAND PAPERBOARD & PACKAGING, INC., INDIANAPOLIS, IN. FILED 11-12-2001.

POST GUARD

FOR ENVELOPES (U.S. CLS. 2, 5, 22, 23, 29, 37, 38 AND 50).

CLASS 17—RUBBER GOODS

SN 76-018,777. STEMCO INC., LONGVIEW, TX. FILED 4-6-2000.

STEMCO ESP

OWNER OF U.S. REG. NOS. 1,016,820, 1,418,935 AND OTHERS.

FOR PRIMARILY NON-METALLIC PROTECTIVE PLUG FOR WHEEL-ENDS AND HUB CAPS, TO PREVENT CONTAMINATION OF WHEEL LUBRICANT FROM GRIME AND WATER, AND TO VENT PRESSURE, FOR USE IN HEAVY-DUTY TRUCKS AND AUTOMOBILES (U.S. CLS. 1, 5, 12, 13, 35 AND 50).
FIRST USE 9-1-1997; IN COMMERCE 9-1-1997.

CLASS 17—(Continued).

SN 76-041,917. BONTEX, INC., BUENA VISTA, VA. FILED 5-5-2000.

RIPPLE-FLEX

FOR MICRO-POROUS CELLULOSE MATERIAL SOLD IN SHEET AND ROLL FORM USED FOR SHOE INSOLES (U.S. CLS. 1, 5, 12, 13, 35 AND 50).

FIRST USE 10-0-1999; IN COMMERCE 10-0-1999.

SN 76-190,272. SEAL KING NORTH AMERICA, INC., CHAPIN, SC. FILED 1-5-2001.

SEAL KING

NO CLAIM IS MADE TO THE EXCLUSIVE RIGHT TO USE "SEAL", APART FROM THE MARK AS SHOWN.

FOR INDUSTRIAL ADHESIVE TAPES (U.S. CLS. 1, 5, 12, 13, 35 AND 50).

FIRST USE 6-0-1998; IN COMMERCE 6-0-1998.

SN 76-230,615. JACKSON PRODUCTS, INC., CHESTERFIELD, MO. FILED 3-23-2001.



NO CLAIM IS MADE TO THE EXCLUSIVE RIGHT TO USE "INC", APART FROM THE MARK AS SHOWN.

THE LINING IN THE MARK IS NOT AN INDICATION OF COLOR.

THE MARK CONSISTS IN PART OF A STYLIZED DRAWING OF "JP".

FOR PAVEMENT MARKING TAPE (U.S. CLS. 1, 5, 12, 13, 35 AND 50).

SN 76-235,381. NANTEX INDUSTRY CO., LTD., LIN YUAN, KAOHSIUNG, TAIWAN, FILED 4-3-2001.

Dynaprene

FOR THERMOPLASTIC ELASTOMER RESINS IN PELLET FORM FOR USE IN FURTHER MANUFACTURE (U.S. CLS. 1, 5, 12, 13, 35 AND 50).

CLASS 17—(Continued).

SN 76-267,883. PRINSCO, INC., PRINSBURG, MN. FILED 6-7-2001.

ECO-PIPE SUPREME

NO CLAIM IS MADE TO THE EXCLUSIVE RIGHT TO USE "SUPREME", APART FROM THE MARK AS SHOWN. FOR WATER DRAINAGE TUBING CONSTRUCTED OF RECYCLED HIGH DENSITY POLYETHYLENE (HDPE) FOR COMMERCIAL NON-BUILDING DRAINAGE PURPOSES (U.S. CLS. 1, 5, 12, 13, 35 AND 50).

SN 76-310,414. CPFILMS INC., MARTINSVILLE, VA. FILED 9-7-2001.

CLEARLES

FOR PLASTIC FILM AND SHEETS USED AS RELEASE LINERS; PLASTIC FILMS AND SHEETS COATED IN A RELEASE AGENT (U.S. CLS. 1, 5, 12, 13, 35 AND 50).

SN 78-063,002. AIRTECH INTERNATIONAL, INC., HUNTINGTON BEACH, CA. FILED 5-10-2001.

SECURLON

FOR POLYMERIC VACUUM BAGGING FILM FOR USE IN PROVIDING PRESSURE TO A PART LAMINATE DURING CURE IN THE AEROSPACE, AUTOMOTIVE, AND MARINE COMPONENT MANUFACTURING INDUSTRIES, AND FOR GENERAL INDUSTRIAL MOLDING APPLICATIONS (U.S. CLS. 1, 5, 12, 13, 35 AND 50). FIRST USE 2-0-2001; IN COMMERCE 2-0-2001.

SN 78-068,705. SOUTHERN BRACING, INC., ROME, GA. FILED 6-12-2001.

TY²

FOR PACKING AND SHIPPING MATERIALS, NAMELY, FIBER-REINFORCED POLYMER BANDS FOR USE IN TYING DOWN AND SECURING LOADS (U.S. CLS. 1, 5, 12, 13, 35 AND 50).

CLASS 18—LEATHER GOODS**CLASS 18—(Continued).**

SN 75-171,532. TWENTIETH CENTURY FOX FILM CORPORATION, LOS ANGELES, CA. FILED 9-16-1996.

ANASTASIA

FOR KNAPSACKS AND BACKPACKS; PURSES; UMBRELLAS; TOTE BAGS, BOOK BAGS, BEACH BAGS; FANNY PACKS (U.S. CLS. 1, 2, 3, 22 AND 41).

SN 75-362,707. TWENTIETH CENTURY FOX FILM CORPORATION, LOS ANGELES, CA. FILED 9-24-1997.



OWNER OF U.S. REG. NOS. 1,237,164, 1,854,239 AND OTHERS.

FOR KNAPSACKS AND BACKPACKS; PURSES; WALLETS; UMBRELLAS; TOTE BAGS, BOOK BAGS, BEACH BAGS; FANNY PACKS (U.S. CLS. 1, 2, 3, 22 AND 41).

SN 75-550,658. RONCATO SRL, 35011 CAMPODARSEGO, ITALY, FILED 9-10-1998.

ROYAL CIAK

PRIORITY CLAIMED UNDER SEC. 44(D) ON ERPNTY TM OFC APPLICATION NO. 829796, FILED 5-20-1998, REG. NO. 829,796, DATED 5-23-1999, EXPIRES 9-24-2008.

FOR PURSES, TRUNKS, TRAVELLING BAGS, SUITCASES, DIPLOMATIC BAGS NAMELY, SMALL CASES FOR CONTAINING PAPERS, ALUMINUM SUITCASES, HANDBAGS (U.S. CLS. 1, 2, 3, 22 AND 41).

SN 75-862,354. TRAVELPRO INTERNATIONAL, INC., BOCA RATON, FL. FILED 12-2-1999.

AIRLINE

SEC. 2(F).
FOR LUGGAGE (U.S. CLS. 1, 2, 3, 22 AND 41).
FIRST USE 11-0-1989; IN COMMERCE 11-0-1989.

CLASS 18—(Continued).

SN 75-919,882. ROSE AMERICA CORPORATION, WICHITA, KS. FILED 2-15-2000.

MADE IN THE HEART OF AMERICA

FOR SADDLERY AND OTHER GOODS USED IN THE CONTROL, CARE, RESTRAINT AND HANDLING OF HORSES AND DOGS, NAMELY, BOOTS, LEG AND/OR HOOF PROTECTIVE COVERINGS, HALTERS, BRIDLES, REINS, LEADS, HOBBLERS, CINCHES, BELTS, COLLARS, MARTINGALES, BLANKETS, SHEETS, COOLERS, HOODS, SWEATS, WRAPS, WARMERS, SADDLE PADS, HEADSTALLS, MUZZLES, CAVESONS, MUZZLE AREA RESTRICTORS, TIES, LEADERS, BREAKAWAYS, CURBS, BILLETS, HARNESS, SADDLES, AND LEASHES (U.S. CLS. 1, 2, 3, 22 AND 41).

FIRST USE 6-1-1989; IN COMMERCE 6-1-1989.

SN 76-059,505. PEABODY MANAGEMENT, INC., MEMPHIS, TN. FILED 5-31-2000.

The Peabody

OWNER OF U.S. REG. NOS. 1,535,837, 2,163,146 AND OTHERS.

SEC. 2(F).

FOR LEATHER LUGGAGE TAGS; TOTE BAGS; DUFFEL BAGS MADE OF CANVAS; AND GENERAL MERCHANDISE AND TRAVEL BAGS MADE OF LEATHER AND CANVAS; PURSES; UMBRELLAS (U.S. CLS. 1, 2, 3, 22 AND 41).

FIRST USE 0-0-1985; IN COMMERCE 0-0-1985.

SN 76-165,887. AIR EXPRESS, INC., CHICOPEE, MA. FILED 11-14-2000.

AIR WARES

FOR TRAVEL BAGS AND TOTE BAGS (U.S. CLS. 1, 2, 3, 22 AND 41).

FIRST USE 11-20-1998; IN COMMERCE 11-20-1998.

CLASS 18—(Continued).

SN 76-179,535. C-CORP (HONG KONG) CO, LTD., MON-GKOK, KOWLOON, HONG KONG, FILED 12-13-2000.



NO CLAIM IS MADE TO THE EXCLUSIVE RIGHT TO USE "LEATHER", APART FROM THE MARK AS SHOWN.

FOR ATTACHE CASES; BACKPACKS; BRIEFCASES; DUFFEL BAGS; HANDBAGS; HIP BAGS; KEY CASES; PURSES; RUCKSACKS; SCHOOL BAGS; SUITCASES; TRAVELING BAGS; TRAVELING TRUNKS; WALLETS; VALISES; VANITY CASES SOLD EMPTY; WAIST POUCHES; AND WAIST PACKS (U.S. CLS. 1, 2, 3, 22 AND 41).

FIRST USE 12-31-1998; IN COMMERCE 1-1-2000.

SN 76-194,504. PODELL, LLC, NEW YORK, NY. FILED 1-16-2001.

NEW YORK  dog

NO CLAIM IS MADE TO THE EXCLUSIVE RIGHT TO USE "NEW YORK DOG", APART FROM THE MARK AS SHOWN.

FOR DOG CLOTHING, NAMELY, JACKETS, SWEATERS, COATS, T-SHIRTS AND HATS; CARRY BAGS FOR DOGS, DOG HARNESSSES, DOG LEASHES, DOG COLLARS, AND TOTE BAGS (U.S. CLS. 1, 2, 3, 22 AND 41).

FIRST USE 5-0-2000; IN COMMERCE 5-0-2000.

SN 76-194,505. PODELL, LLC, NEW YORK, NY. FILED 1-16-2001.

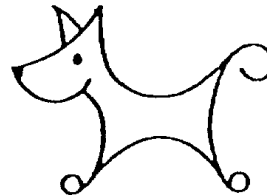

THE MARK CONSISTS OF A STYLIZED DESIGN OF A DOG.

FOR DOG CLOTHING, NAMELY, JACKETS, SWEATERS, COATS, T-SHIRTS AND HATS; CARRY BAGS FOR DOGS, DOG HARNESSSES, DOG LEASHES, DOG COLLARS, AND TOTE BAGS (U.S. CLS. 1, 2, 3, 22 AND 41).

CLASS 18—(Continued).

SN 76-265,003. SWOBODA INTERNATIONAL, LLC, NEW YORK, NY. FILED 5-25-2001.

Jolie

FOR HANDBAGS, TOTES, BACKPACKS, WALLETS (U.S. CLS. 1, 2, 3, 22 AND 41).

SN 76-279,805. TMW MARKETING COMPANY, INC., FREMONT, CA. FILED 6-27-2001.

PRONTO-UOMO

OWNER OF U.S. REG. NOS. 1,646,078 AND 1,681,269. THE ENGLISH TRANSLATION OF THE WORD "PRONTO-UOMO" IN THE MARK IS "READY-MAN". FOR WALLETS (U.S. CLS. 1, 2, 3, 22 AND 41).

SN 76-286,733. A & L SEAMON, INC., NEW YORK, NY. FILED 7-19-2001.

BILLPAK

FOR SMALL LEATHER ARTICLES, NAMELY, BILLFOLDS, CLUTCH PURSES, FRENCH PURSES, KEY CASES AND POCKET SECRETARIES (U.S. CLS. 1, 2, 3, 22 AND 41).
FIRST USE 0-0-1935; IN COMMERCE 0-0-1935.

SN 76-298,754. MULTNOMAH PUBLISHERS, INC., SISTERS, OR. FILED 8-10-2001.

THE PRAYER OF JABEZ

FOR BACKPACKS; HANDBAGS; LUGGAGE ITEMS (U.S. CLS. 1, 2, 3, 22 AND 41).

SN 76-329,351. TARVER, STEVEN K., LAKE RIDGE, VA. FILED 10-25-2001.

OOOEE0

OWNER OF U.S. REG. NO. 2,490,737. FOR BACKPACKS, HANDBAGS (U.S. CLS. 1, 2, 3, 22 AND 41).
FIRST USE 4-16-2001; IN COMMERCE 4-16-2001.

CLASS 18—(Continued).

SN 76-333,127. D. T. SYSTEMS, INC., DALLAS, TX. FILED 11-1-2001.

SUPER PRO

FOR DOG COLLARS (U.S. CLS. 1, 2, 3, 22 AND 41).

SN 76-333,837. MEAD CORPORATION, THE, DAYTON, OH. FILED 11-5-2001.

STREET SENSE

OWNER OF U.S. REG. NO. 2,457,969. FOR BACKPACKS AND BOOK BAGS (U.S. CLS. 1, 2, 3, 22 AND 41).

SN 76-344,532. ASPEN LICENSING INTERNATIONAL/INC., WEST PALM BEACH, FL. FILED 12-3-2001.



FOR BACKPACKS, HANDBAGS AND LUGGAGE (U.S. CLS. 1, 2, 3, 22 AND 41).
FIRST USE 10-0-2001; IN COMMERCE 10-0-2001.

SN 76-347,257. NATIONAL FOOTBALL LEAGUE, NEW YORK, NY. FILED 12-10-2001.

NFL SPIRIT

FOR ATHLETIC BAGS, BOOK BAGS, CARRY-ON BAGS, LUGGAGE, CLUTCH BAGS, DIAPER BAGS, HANDBAGS, SHOULDER BAGS, PURSES, TOTE BAGS, BEACH BAGS, BEACH UMBRELLAS, BILLFOLDS, BRIEFCASES, BUSINESS CARD CASES, CREDIT CARD CASES, KEY CASES, PASSPORT CASES, VANITY CASES SOLD EMPTY, TOILETRY CASES SOLD EMPTY, CHANGE PURSES, COSMETIC CASES SOLD EMPTY, DRAWSTRING POUCHES, FANNY PACKS, GARMENT BAGS FOR TRAVEL, UMBRELLAS, UMBRELLA CASES, LUGGAGE TAGS, KNAPSACKS (U.S. CLS. 1, 2, 3, 22 AND 41).

CLASS 18—(Continued).

SN 78-069,590. L. L. BEAN, INC., FREEPORT, ME. FILED 6-18-2001.

SHOCKWAVE PACK

NO CLAIM IS MADE TO THE EXCLUSIVE RIGHT TO USE "PACK", APART FROM THE MARK AS SHOWN.

FOR BACKPACKS DESIGNED TO CARRY BOOKS, CLOTHES AND SCHOOL ACCESSORIES (U.S. CLS. 1, 2, 3, 22 AND 41).

FIRST USE 7-18-2000; IN COMMERCE 7-18-2000.

SN 78-087,497. SAMSONITE CORPORATION, DENVER, CO. FILED 10-9-2001.

HYDRAPORT

FOR DUFFEL BAGS (U.S. CLS. 1, 2, 3, 22 AND 41).

SN 78-096,425. L. L. BEAN, INC., FREEPORT, ME. FILED 12-4-2001.

BOAT AND TOTE

OWNER OF U.S. REG. NO. 1,411,405.
FOR ALL PURPOSE CARRYING BAG (U.S. CLS. 1, 2, 3, 22 AND 41).

FIRST USE 2-15-1979; IN COMMERCE 2-15-1979.

CLASS 19—NON-METALLIC BUILDING MATERIALS

SN 75-856,263. MILWAUKEE DIRECT MARKETING, INC., BROOKFIELD, WI. FILED 11-23-1999.

GROUNDGRAPHICS

FOR SIGNS, MADE OF VINYL/RUBBER, INTENDED TO LIE FREELY OR BE MOUNTED ON THE GROUND FOR INDOOR/OUTDOOR WALK-ON USE (U.S. CLS. 1, 12, 33 AND 50).

FIRST USE 6-16-1999; IN COMMERCE 6-16-1999.

SN 75-866,533. INFILTRATOR SYSTEMS, INC., OLD SAYBROOK, CT. FILED 12-8-1999.

POSILOCK

FOR NON-METALLIC ENDPLATES USED IN NON-METAL DRAINAGE CHAMBERS FOR DISPERSING OR COLLECTING LIQUIDS WITHIN SOIL OR GRANULAR MATERIALS, NAMELY ON-SITE SEPTIC AND STORM WATER MANAGEMENT CHAMBERS (U.S. CLS. 1, 12, 33 AND 50).

CLASS 19—(Continued).

SN 75-932,212. GREAT LAKES WINDOW, INC., TOLEDO, OH. FILED 3-1-2000.



FOR NON-METAL WINDOWS AND PATIO DOORS (U.S. CLS. 1, 12, 33 AND 50).

FIRST USE 12-1-1999; IN COMMERCE 12-1-1999.

SN 76-073,900. LVTM, INC., ENCINO, CA. FILED 6-20-2000.

NATIONAL READY-MIX

NO CLAIM IS MADE TO THE EXCLUSIVE RIGHT TO USE "READY-MIX", APART FROM THE MARK AS SHOWN.

SEC. 2(F).

FOR CONCRETE (U.S. CLS. 1, 12, 33 AND 50).

FIRST USE 6-0-1968; IN COMMERCE 6-0-1968.

SN 76-094,147. AINSWORTH LUMBER CO., LTD., VANCOUVER, BRITISH COLUMBIA, CANADA, FILED 7-20-2000.

AINSWORTH ENGINEERED

NO CLAIM IS MADE TO THE EXCLUSIVE RIGHT TO USE "ENGINEERED", APART FROM THE MARK AS SHOWN.

FOR STRUCTURAL WOOD PRODUCTS, NAMELY, LUMBER, ORIENTED STRAND BOARD, PARTICLE BOARD, PLYWOOD, FIBERBOARD, LAMINATED WOOD-BASED PRODUCTS, NAMELY, RAILINGS, FINGER-JOINED LUMBER, WOOD VENEER, WOOD VENEER-BASED PANELS, ORIENTED STRAND LUMBER, BEAMS, HEADERS AND COLUMNS (U.S. CLS. 1, 12, 33 AND 50).

SN 76-113,983. NASCOR INCORPORATED, CALGARY, ALBERTA, CANADA, FILED 8-21-2000.

THE ULTIMATE FLOOR

NO CLAIM IS MADE TO THE EXCLUSIVE RIGHT TO USE "FLOOR", APART FROM THE MARK AS SHOWN.

SEC. 2(F).

FOR WOOD FLOOR JOISTS, WOOD FLOOR BEAMS AND WOOD FLOOR SYSTEMS COMPRISED OF ORIENTED STRAND BOARD WEBS AND LUMBER FLANGES (U.S. CLS. 1, 12, 33 AND 50).

FIRST USE 6-0-1995; IN COMMERCE 6-0-1995.

CLASS 19—(Continued).

SN 76-153,968. U.S. SILICA COMPANY, BERKELEY SPRINGS, WV. FILED 10-25-2000.

KOSSE WHITE

NO CLAIM IS MADE TO THE EXCLUSIVE RIGHT TO USE "WHITE", APART FROM THE MARK AS SHOWN. SEC. 2(F).
FOR SAND (U.S. CLS. 1, 12, 33 AND 50).
FIRST USE 0-0-1990; IN COMMERCE 0-0-1990.

SN 76-156,441. HENDERSON FLOORS, INC., VENTURA, CA. FILED 10-31-2000.

PATINA OLD WORLD FLOORING

NO CLAIM IS MADE TO THE EXCLUSIVE RIGHT TO USE "FLOORING", APART FROM THE MARK AS SHOWN. FOR PARQUET WOOD FLOORING (U.S. CLS. 1, 12, 33 AND 50).
FIRST USE 2-1-1996; IN COMMERCE 2-1-1996.

SN 76-159,184. SIERRAPINE, ROSEVILLE, CA. FILED 11-3-2000.

SierraPine[™]
COMPOSITE SOLUTIONS

OWNER OF U.S. REG. NO. 2,380,427.
NO CLAIM IS MADE TO THE EXCLUSIVE RIGHT TO USE "COMPOSITE SOLUTIONS" AND "LTD", APART FROM THE MARK AS SHOWN.
FOR WOOD PRODUCTS, NAMELY, COMPOSITE PANELS, PARTICLEBOARD AND FIBERBOARD FOR USE IN FURTHER MANUFACTURING (U.S. CLS. 1, 12, 33 AND 50).

SN 76-169,953. WULFRATH REFRACTORIES GMBH, 40724 HILDEN, FED REP GERMANY, FILED 11-22-2000.

AMC

PRIORITY CLAIMED UNDER SEC. 44(D) ON ERP N CMNTY TM OFC APPLICATION NO. 001672963, FILED 5-24-2000, REG. NO. 001672963, DATED 7-18-2001, EXPIRES 7-18-2011.

FOR REFRACTORY MATERIALS, NAMELY, REFRACTORY COMPOUNDS OR SHAPED REFRACTORY PRODUCTS MADE THEREFROM FOR LINING METALLURGICAL CONTAINERS, REFRACTORY BLOCKS, REFRACTORY BRICKS, REFRACTORY FURNACE LININGS, CERAMIC SHAPES FOR USE IN REFRACTORY FURNACES, REFRACTORY MORTARS, AND REFRACTORY SHAPES (U.S. CLS. 1, 12, 33 AND 50).

CLASS 19—(Continued).

SN 76-221,567. QUALITY SYSTEMS, INC., NASHVILLE, TN. FILED 3-7-2001.

TROPIC•GRIT

FOR CEMENTIOUS PRODUCTS - NAMELY, MIXES - FOR RESURFACING CONCRETE, MASONRY, AGGREGATE, STUCCO, WOOD STEEL AND OTHER SUCH SURFACES (U.S. CLS. 1, 12, 33 AND 50).
FIRST USE 5-22-1996; IN COMMERCE 5-22-1996.

SN 76-231,136. POLY-FOAM INTERNATIONAL INCORPORATED, FREMONT, OH. FILED 3-27-2001.

PROPRIDE

FOR NON-METAL BUILDING PRODUCTS, NAMELY, VINYL SIDING, VINYL SOFFITS, VINYL SKIRTING, VINYL J CHANNEL, VINYL TRIM, VINYL CORNER POSTS, VINYL STARTER STRIPS, VINYL CASINGS AND STEPS (U.S. CLS. 1, 12, 33 AND 50).
FIRST USE 1-0-2000; IN COMMERCE 1-0-2000.

SN 76-234,160. IMPERIAL POOLS, INC., LATHAM, NY. FILED 4-2-2001.



NO CLAIM IS MADE TO THE EXCLUSIVE RIGHT TO USE "POOLS", APART FROM THE MARK AS SHOWN.
THE "ROYAL POOLS" AND DESIGN MARK CONSISTS, IN PART, OF A STYLIZED SWIMMING POOL SURROUNDING THE WORDS "ROYAL POOLS" AND A STYLIZED CROWN ABOVE THE LETTER "O" IN THE WORD "ROYAL".

FOR SWIMMING POOLS PRIMARILY MADE OF STEEL (U.S. CLS. 1, 12, 33 AND 50).

CLASS 19—(Continued).

SN 76-253,700. REGEV, NURIT, CANOGA PARK, CA. FILED 5-9-2001.

TEXSTON

FOR BUILDING MATERIALS, NAMELY, NATURAL AND ARTIFICIAL STONE, CEMENT, LIME, MORTAR, PLASTER, AND GRAVEL; PIPES OF EARTHENWARE OR CEMENT; ROAD-MAKING MATERIALS, NAMELY, ASPHALT, PITCH, AND BITUMEN ASPHALT; NON-METAL PORTABLE BUILDINGS; STONE MONUMENTS; CHIMNEY POTS (U.S. CLS. 1, 12, 33 AND 50).
FIRST USE 5-2-1998; IN COMMERCE 5-2-1998.

SN 76-264,106. TRUE GRID HOLDINGS PTY LTD, PORT MELBOURNE VIC 3207, AUSTRALIA, FILED 5-29-2001.

TRUE LOC

PRIORITY CLAIMED UNDER SEC. 44(D) ON AUSTRALIA APPLICATION NO. 860504, FILED 12-13-2000, REG. NO. 860504, DATED 10-10-2001, EXPIRES 12-13-2010.
FOR TIMBER FLOORING, NAMELY, LAMINATED TIMBER PLANKS (U.S. CLS. 1, 12, 33 AND 50).

SN 76-289,307. PILKINGTON PLC, MERSEYSIDE WA10 3TT, UNITED KINGDOM, FILED 7-24-2001.

PILKINGTON TEXTURE

OWNER OF UNITED KINGDOM REG. NO. 1518379, DATED 9-9-1994, EXPIRES 11-11-2009.
OWNER OF U.S. REG. NOS. 2,260,425 AND 2,294,969.
NO CLAIM IS MADE TO THE EXCLUSIVE RIGHT TO USE "TEXTURE", APART FROM THE MARK AS SHOWN.
FOR ARTICLES MADE WHOLLY OF GLASS, NAMELY, WINDOW GLASS, GLASS DOORS, AND GLASS PARTITIONS; PATTERN GLASS SHEETS AND PANELS FOR BUILDINGS AND CONSTRUCTION (U.S. CLS. 1, 12, 33 AND 50).

SN 76-292,058. SAROYAN LUMBER COMPANY, HUNTINGTON PARK, CA. FILED 7-30-2001.

ALLURO

FOR WOODEN FLOORING (U.S. CLS. 1, 12, 33 AND 50).
FIRST USE 3-5-2001; IN COMMERCE 3-5-2001.

SN 76-292,063. SAROYAN LUMBER COMPANY, HUNTINGTON PARK, CA. FILED 7-30-2001.

CASTANEGRA

FOR WOODEN FLOORING (U.S. CLS. 1, 12, 33 AND 50).
FIRST USE 3-5-2001; IN COMMERCE 3-5-2001.

CLASS 19—(Continued).

SN 76-316,977. MASSARELLI'S LAWN ORNAMENTS, INC., HAMMONTON, NJ. FILED 9-24-2001.

SILENT HEROES

FOR CONCRETE STATUES (U.S. CLS. 1, 12, 33 AND 50).

SN 76-316,978. MASSARELLI'S LAWN ORNAMENTS, INC., HAMMONTON, NJ. FILED 9-24-2001.

SILENT HERO

FOR CONCRETE STATUES (U.S. CLS. 1, 12, 33 AND 50).

SN 76-317,191. VEKA, INC., FOMBELL, PA. FILED 9-25-2001.

SWINGVIEW

FOR DOORS, NAMELY, AN ALL VINYL PIVOTING DOOR (U.S. CLS. 1, 12, 33 AND 50).

SN 76-329,614. POTLATCH CORPORATION, SPOKANE, WA. FILED 10-23-2001.



THE LINING IS A FEATURE OF THE MARK AND DOES NOT INDICATE COLOR.
THE MARK CONSISTS, IN PART, OF THE STYLIZED DEPICTION OF AN OX SUPERPOSED ON A ROACH.
FOR BUILDING PANELS MADE FROM RECONSTRUCTED WOOD ELEMENTS (U.S. CLS. 1, 12, 33 AND 50).

SN 76-336,281. EAGLE FLOORING BROKERS, INC., FORT WAYNE, IN. FILED 11-9-2001.

SATIN-FLEX

FOR MORTAR (U.S. CLS. 1, 12, 33 AND 50).
FIRST USE 8-19-1998; IN COMMERCE 8-19-1998.

CLASS 19—(Continued).

SN 78-019,945. ALCOA INC., PITTSBURGH, PA. FILED 8-7-2000.

CLASSIC LIVING

NO CLAIM IS MADE TO THE EXCLUSIVE RIGHT TO USE "CLASSIC", APART FROM THE MARK AS SHOWN.
FOR VINYL SIDING FOR SALE THROUGH BUILDING PRODUCT DISTRIBUTORS AND LUMBER YARDS (U.S. CLS. 1, 12, 33 AND 50).

SN 78-038,742. CUNNINGHAM, MICHAEL E., HUNTSVILLE, TX. FILED 12-11-2000.

E*Z MOUNT

NO CLAIM IS MADE TO THE EXCLUSIVE RIGHT TO USE "MOUNT", APART FROM THE MARK AS SHOWN.
FOR CONSTRUCTION ELEMENTS NOT MADE OF METAL, NAMELY, BRACES DESIGNED TO MOUNT, SUPPORT, AND SECURE MULTIPLE PIPES AND CONDUIT ATOP OR UPON BUILDING STRUCTURES, AND TO ENABLE AIR TO PASS BETWEEN THE BRACE AND THE BUILDING STRUCTURES (U.S. CLS. 1, 12, 33 AND 50).

SN 78-044,228. OWENS-CORNING FIBERGLAS TECHNOLOGY INC., SUMMIT, IL. FILED 1-22-2001.

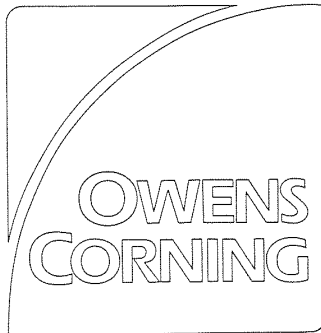

OWNER OF U.S. REG. NOS. 1,817,935 AND 1,833,831.
FOR SHINGLE REPAIR KITS CONSISTING OF COLORED NON-METAL SHINGLE GRANULES, GRANULE ADHESIVE, ROOF PATCHING CEMENT, REPAIR TAPE, PAIL, CUP FOR COLLECTING, BLENDING AND SPREADING GRANULES, PUTTY KNIFE AND BRUSH (U.S. CLS. 1, 12, 33 AND 50).

SN 78-093,352. PRODUCTS & VENTURES INTERNATIONAL, INC., SUMMERLAND, CA. FILED 11-14-2001.

FOREST PRO

FOR WOODEN SLATS USED FOR THE MANUFACTURE OF PENCILS (U.S. CLS. 1, 12, 33 AND 50).

CLASS 20—FURNITURE AND ARTICLES NOT OTHERWISE CLASSIFIED

SN 76-013,265. JAY'S FURNITURE PRODUCTS, INC., BUFFALO, NY. FILED 3-31-2000.

JAY'S FURNITURE PRODUCTS

NO CLAIM IS MADE TO THE EXCLUSIVE RIGHT TO USE "FURNITURE PRODUCTS", APART FROM THE MARK AS SHOWN.

FOR RESTAURANT FURNITURE, NAMELY, SERVING COUNTERS, TABLES, CHAIRS AND BOOTHS (U.S. CLS. 2, 13, 22, 25, 32 AND 50).
FIRST USE 1-4-2000; IN COMMERCE 1-4-2000.

SN 76-013,266. JAY'S FURNITURE PRODUCTS, INC., BUFFALO, NY. FILED 3-31-2000.



NO CLAIM IS MADE TO THE EXCLUSIVE RIGHT TO USE "FURNITURE PRODUCTS, INC.", APART FROM THE MARK AS SHOWN.

FOR RESTAURANT FURNITURE, NAMELY, SERVING COUNTERS, TABLES, CHAIRS AND BOOTHS (U.S. CLS. 2, 13, 22, 25, 32 AND 50).
FIRST USE 1-4-2000; IN COMMERCE 1-4-2000.

SN 76-061,566. PIAGGIO & C. S.P.A., 56025 PONTEDERA, ITALY, FILED 6-2-2000.



OWNER OF U.S. REG. NOS. 1,929,118, 2,156,150 AND OTHERS.
THE ENGLISH TRANSLATION OF "VESPA" IS "WASP".
FOR FURNITURE (U.S. CLS. 2, 13, 22, 25, 32 AND 50).

CLASS 20—(Continued).

SN 76-109,607. MESSER INDUSTRIES, INC., GREER, SC. FILED 8-15-2000.

HOME IMAGES

NO CLAIM IS MADE TO THE EXCLUSIVE RIGHT TO USE "HOME", APART FROM THE MARK AS SHOWN.

FOR FRAMED MIRRORS AND FRAMELESS MIRRORING GLASS USED AS FURNITURE AND FOR HOME AND OFFICE FURNISHINGS, IMPROVEMENTS AND NEW CONSTRUCTION (U.S. CLS. 2, 13, 22, 25, 32 AND 50).

SN 76-127,213. FOREST GROUP NEDERLAND B. V., 7418 EK DEVENTER, NETHERLANDS, FILED 9-12-2000.



PRIORITY CLAIMED UNDER SEC. 44(D) ON BENELUX APPLICATION NO. 0959871, FILED 3-16-2000, REG. NO. 0668618, DATED 3-16-2000, EXPIRES 3-16-2010.

OWNER OF U.S. REG. NO. 2,384,968.

FOR CURTAIN RAILS, CURTAIN RODS, FASTENING MATERIALS FOR CURTAIN RAILS AND CURTAIN RODS, NAMELY, WALL SUPPORTS, SIDE WALL SUPPORTS, CEILING BRACKETS, EXTENSION BRACKETS, BRACKETS AND SUPPORTS WITH SNAP-IN FASTENINGS, CONNECTING BRIDGES; NON-METAL CURTAIN HOOKS, CURTAIN RINGS, CURTAIN ROLLERS AND CURTAIN GLIDERS; END STOPS FOR CURTAIN RAILS AND CURTAIN RODS; CORDS AND CHAINS FOR OPENING AND CLOSING CURTAINS; WINDOW BLINDS (U.S. CLS. 2, 13, 22, 25, 32 AND 50).

SN 76-134,142. KLEAR-VU CORPORATION, NEW YORK, NY. FILED 9-25-2000.

THE GRIPPER

OWNER OF U.S. REG. NO. 2,211,992. SEC. 2(F).

FOR CHAIR CUSHIONS AND STOOL CUSHIONS (U.S. CLS. 2, 13, 22, 25, 32 AND 50).

FIRST USE 10-22-1997; IN COMMERCE 10-27-1997.

SN 76-134,810. DINGMAN, SHARON K, OGDEN, UT. FILED 9-22-2000.

THE CARING MODEL

FOR LANYARDS FOR USE IN HOLDING EYEGLASSES, IDENTIFICATION BADGES AND KEYS (U.S. CLS. 2, 13, 22, 25, 32 AND 50).

CLASS 20—(Continued).

SN 76-162,313. LITTLE TIKES COMPANY, THE, HUDSON, OH. FILED 11-9-2000.

LITTLE TIKES

OWNER OF U.S. REG. NOS. 1,055,661, 2,483,798 AND OTHERS.

FOR INFANT AND JUVENILE FURNITURE, NAMELY, CONVERTIBLE FURNITURE, BED RAILS NOT FOR MEDICAL OR ORTHOPEDIC PURPOSES, HIGH CHAIRS, BOOSTER SEATS, STEP STOOLS, PLAY-PENS, BUREAUS, TABLES, CHAIRS; BABY WALKERS (U.S. CLS. 2, 13, 22, 25, 32 AND 50).

SN 76-162,314. LITTLE TIKES COMPANY, THE, HUDSON, OH. FILED 11-9-2000.

LITTLE TIKES BABIES

FOR INFANT AND JUVENILE FURNITURE, NAMELY, CONVERTIBLE FURNITURE, BED RAILS NOT FOR MEDICAL OR ORTHOPEDIC PURPOSES, HIGH CHAIRS, BOOSTER SEATS, STEP STOOLS, PLAY-PENS, BUREAUS, TABLE, CHAIRS; BABY WALKERS (U.S. CLS. 2, 13, 22, 25, 32 AND 50).

SN 76-163,234. SWISS MAGIC, INC., LITTLE FERRY, NJ. BY ASSIGNMENT KANG, TED S., RUTHERFORD, NJ. FILED 11-10-2000.



FOR PICTURE FRAMES DEVICE FOR HOLDING NUMEROUS PHOTOGRAPHS AND DISPLAYING ONE AT A TIME (U.S. CLS. 2, 13, 22, 25, 32 AND 50).

SN 76-166,043. MARS, INCORPORATED, MCLEAN, VA. FILED 11-14-2000.

SEASON'S EATINGS

FOR NON-METAL KEY CHAINS (U.S. CLS. 2, 13, 22, 25, 32 AND 50).

CLASS 20—(Continued).

SN 76-182,853. TEA & COMPANY WORLD TEA HOUSE, SAUSALITO, CA. FILED 12-13-2000.

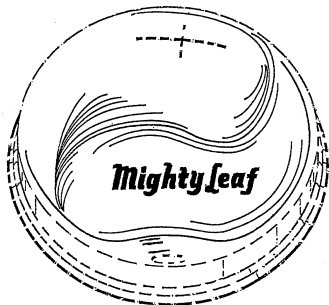

OWNER OF U.S. REG. NO. 2,423,886.
THE MARK CONSISTS OF THE WORDS "MIGHTY LEAF" EMBOSSED ON A DISPOSABLE PLASTIC CONTAINER LID, AND SET AGAINST A GENERALLY "YIN AND YANG" SHAPED SURFACE FEATURE MOLDED INTO THE LID.
FOR DISPOSABLE DRINK PLASTIC CONTAINER LIDS (U.S. CLS. 2, 13, 22, 25, 32 AND 50).

SN 76-190,336. SERTA, INC., ITASCA, IL. FILED 1-4-2001.

LIFE'S BEST RETREAT

FOR MATTRESSES AND MATTRESS FOUNDATIONS (U.S. CLS. 2, 13, 22, 25, 32 AND 50).
FIRST USE 7-0-2000; IN COMMERCE 7-0-2000.

SN 76-191,868. ONTEL CORP., FAIRFIELD, NJ. FILED 1-9-2001.

PHOTOMAGIC

FOR DEVICE, NAMELY A PICTURE FRAME, FOR ORDERING AND SEQUENTIALLY DISPLAYING INDIVIDUAL SNAPSHOT PHOTOGRAPHS (U.S. CLS. 2, 13, 22, 25, 32 AND 50).

SN 76-193,878. KIMBALL INTERNATIONAL, INC., JASPER, IN. FILED 1-16-2001.

BENEFIT

FOR FURNITURE AND FREE STANDING OFFICE PARTITIONS (U.S. CLS. 2, 13, 22, 25, 32 AND 50).

CLASS 20—(Continued).

SN 76-195,243. PARTY CLOTHS, INC., SILVER SPRING, MD. FILED 1-17-2001.

KORCOVER

FOR FITTED FABRIC CHAIR COVERS (U.S. CLS. 2, 13, 22, 25, 32 AND 50).

SN 76-195,706. BRADFORD EXCHANGE, LTD., THE, NILES, IL. FILED 1-19-2001.

LIVING SCULPTURE

NO CLAIM IS MADE TO THE EXCLUSIVE RIGHT TO USE "SCULPTURE", APART FROM THE MARK AS SHOWN.
FOR COLLECTIBLE STATUETTES MADE PRIMARILY OF RESIN (U.S. CLS. 2, 13, 22, 25, 32 AND 50).

SN 76-202,698. MAR PRODUCTS, INC., CHESTERFIELD, MI. FILED 1-31-2001.

MAIL CALL

NO CLAIM IS MADE TO THE EXCLUSIVE RIGHT TO USE "MAIL", APART FROM THE MARK AS SHOWN.
FOR PLASTIC SIGNAL FLAGS FOR USE ON MAILBOXES (U.S. CLS. 2, 13, 22, 25, 32 AND 50).
FIRST USE 10-31-1996; IN COMMERCE 10-31-1996.

SN 76-207,684. RUSS BASSETT COMPANY, WHITTIER, CA. FILED 2-12-2001.

SLIDETRAC

FOR SHELVING WITH SLIDING WALL PORTIONS (U.S. CLS. 2, 13, 22, 25, 32 AND 50).
FIRST USE 3-1-2000; IN COMMERCE 3-1-2000.

SN 76-219,667. PERFECT FIT INDUSTRIES, INC., CHARLOTTE, NC. FILED 3-5-2001.

SLUMBER SOFT

NO CLAIM IS MADE TO THE EXCLUSIVE RIGHT TO USE "SOFT", APART FROM THE MARK AS SHOWN.
FOR PILLOWS (U.S. CLS. 2, 13, 22, 25, 32 AND 50).

CLASS 20—(Continued).

SN 76-220,096. BURDA, DON, SHADY COVE, OR. FILED 3-6-2001.



NO CLAIM IS MADE TO THE EXCLUSIVE RIGHT TO USE "ARTS", APART FROM THE MARK AS SHOWN.

THE DESIGN PORTION OF THE MARK SUBMITTED FOR REGISTRATION CONSISTS OF THE WORD "HIGH COUNTRY ARTS" ENCLOSED BY STYLIZED ANTLERS.

FOR HANDCRAFTED ARTICLES, CREATED MAINLY FROM ANTLERS (U.S. CLS. 2, 13, 22, 25, 32 AND 50).

FIRST USE 4-1-1984; IN COMMERCE 4-1-1984.

SN 76-220,314. NORTH URN LTD., LINDSAY, ONTARIO, CANADA, FILED 3-7-2001.

FUNERAL ARK

PRIORITY CLAIMED UNDER SEC. 44(D) ON CANADA APPLICATION NO. 1093154, FILED 2-16-2001.

NO CLAIM IS MADE TO THE EXCLUSIVE RIGHT TO USE "FUNERAL", APART FROM THE MARK AS SHOWN.

FOR CARRIERS FOR COFFINS AND FUNERAL URNS, THE CARRIER IS COMPRISED OF A PLATFORM TO RECEIVE A COFFIN OR A FUNERAL URN AND HANDLES BY WHICH THE CARRIER MAY BE MANUALLY CARRIED (U.S. CLS. 2, 13, 22, 25, 32 AND 50).

FIRST USE 10-1-2000; IN COMMERCE 10-1-2000.

SN 76-223,037. JAMI, INC., OVERLAND PARK, KS. FILED 3-12-2001.

APPLAUSE

FOR FURNITURE, NAMELY, SEATS FOR COMMERCIAL USE (U.S. CLS. 2, 13, 22, 25, 32 AND 50).

FIRST USE 6-0-2001; IN COMMERCE 6-0-2001.

SN 76-227,295. HIGSON, DONNIE WAYNE, DBA DOPPLER WEATHER ROCK, GREENVILLE, NC. FILED 3-19-2000.

DOPPLER WEATHER ROCK

FOR NOVELTY DEVICE, NAMELY, A NOVELTY WEATHER STATION (U.S. CLS. 2, 13, 22, 25, 32 AND 50).

CLASS 20—(Continued).

SN 76-229,749. DICKIE WALKER MARINE, INC., LA JOLLA, CA. FILED 3-26-2001.



NO CLAIM IS MADE TO THE EXCLUSIVE RIGHT TO USE "BUILT 1951" AND "AUTHENTIC MARINE", APART FROM THE MARK AS SHOWN.

THE STIPPLING IN THE MARK IS FOR SHADING PURPOSES ONLY.

THE NAME "DICKIE WALKER" IS THE NAME OF A BOAT AND NOT THE NAME OF ANY KNOWN OR PARTICULAR LIVING INDIVIDUAL.

FOR FURNITURE FOR BOATS, NAMELY, DECK CHAIRS, LOUNGE CHAIRS, BEDS, STOOLS, WOOD BOXES, CABINETS OF WOOD, CASES OF WOOD USED FOR STORAGE, CHAIRS, CHESTS, TABLES, CURTAIN RODS, WOOD DOOR KNOBS AND PULLS, HAMPERS, NON-METAL HOOKS, PICTURE FRAMES, MIRRORS, MOLDINGS, PILLOWS AND CUSHIONS, STORAGE RACKS, WARDROBES (U.S. CLS. 2, 13, 22, 25, 32 AND 50).

SN 76-235,048. PAULA JEAN BROWN, LOS ANGELES, CA. FILED 4-3-2001.

Paula's Pillows

NO CLAIM IS MADE TO THE EXCLUSIVE RIGHT TO USE "PILLOWS", APART FROM THE MARK AS SHOWN.

FOR HAND AND MACHINE STITCHED DECORATIVE FABRIC PILLOWS OF VARIOUS SIZES (U.S. CLS. 2, 13, 22, 25, 32 AND 50).

FIRST USE 3-28-2001; IN COMMERCE 3-28-2001.

CLASS 20—(Continued).

SN 76-275,345. NATIVE ART ALASKA, INC., ANCHORAGE, AK. FILED 6-25-2001.



THE MARK CONSISTS OF A STYLIZED BIRD DESIGN. FOR FURNITURE (U.S. CLS. 2, 13, 22, 25, 32 AND 50).

SN 76-280,801. SPRINGWALL, INC., ARCHDALE, NC. FILED 7-5-2001.

LUMBAR BRIDGE

NO CLAIM IS MADE TO THE EXCLUSIVE RIGHT TO USE "LUMBAR", APART FROM THE MARK AS SHOWN. FOR MATTRESSES, BOX SPRINGS AND SLEEP SETS, NAMELY, MATTRESSES AND BOX SPRINGS SOLD AS A UNIT (U.S. CLS. 2, 13, 22, 25, 32 AND 50).

SN 76-281,159. INDUSTRIAS QUETZAL, S.A. DE C.V., 50450 ESTADO DE MEXICO, MEXICO, FILED 7-6-2001.

QUETZAL

FOR KITCHEN AND BATH CABINETS (U.S. CLS. 2, 13, 22, 25, 32 AND 50).

SN 76-317,067. TREAT ENTERTAINMENT, INC., ATLANTA, GA. FILED 9-24-2001.

TENDER TIMES TIME CAPSULE

NO CLAIM IS MADE TO THE EXCLUSIVE RIGHT TO USE "TIME CAPSULE", APART FROM THE MARK AS SHOWN.

FOR NON-METAL TIME CAPSULES (U.S. CLS. 2, 13, 22, 25, 32 AND 50).

CLASS 20—(Continued).

SN 76-325,030. TRES AMIGOS DE MEXICO, TUCSON, AZ. FILED 10-12-2001.

TRES AMIGOS

THE ENGLISH TRANSLATION OF "TRES AMIGOS" IS "THREE FRIENDS".

FOR FURNITURE (U.S. CLS. 2, 13, 22, 25, 32 AND 50). FIRST USE 5-1-1999; IN COMMERCE 5-1-1999.

SN 76-330,790. PATRIOT SIGNAGE INCORPORATED, DAYTON, KY. FILED 10-29-2001.

PATRIOT SIGNAGE

NO CLAIM IS MADE TO THE EXCLUSIVE RIGHT TO USE "SIGNAGE", APART FROM THE MARK AS SHOWN.

FOR BANNERS AND YARD SIGNS MADE PRIMARILY OF WOOD, PLASTIC OR VINYL (U.S. CLS. 2, 13, 22, 25, 32 AND 50).

FIRST USE 9-30-1991; IN COMMERCE 9-30-1991.

SN 76-343,882. HON TECHNOLOGY INC., MUSCATINE, IA. FILED 11-30-2001.

I AM PART HUMAN

FOR FURNITURE (U.S. CLS. 2, 13, 22, 25, 32 AND 50).

SN 76-344,262. HON TECHNOLOGY INC., MUSCATINE, IA. FILED 11-30-2001.

AVATAR

FOR FURNITURE (U.S. CLS. 2, 13, 22, 25, 32 AND 50).

SN 76-344,337. MAINE COTTAGE FURNITURE, INC., YARMOUTH, ME. FILED 12-3-2001.

FINN & HATTIE

FOR FURNITURE (U.S. CLS. 2, 13, 22, 25, 32 AND 50).

CLASS 20—(Continued).

SN 76-344,338. MAINE COTTAGE FURNITURE, INC., YARMOUTH, ME. FILED 12-3-2001.

[finn + hattie]

FOR FURNITURE (U.S. CLS. 2, 13, 22, 25, 32 AND 50).

SN 76-344,425. AIR CONTROL, INC., HENDERSON, NC. FILED 12-3-2001.

POLYPROLABS

FOR CORROSION-RESISTANT FURNITURE (U.S. CLS. 2, 13, 22, 25, 32 AND 50).

SN 76-345,573. DISPLAY INDUSTRIES, LLC., SYMRNA, GA. FILED 12-6-2001.

ACCU-TRACK

FOR DISPLAY TRACKS AND SHELVES; NAMELY, SINGLE AND MULTIPLE TRACK MEMBER INSERTS FOR DISPLAY RACKS AND SHELVES (U.S. CLS. 2, 13, 22, 25, 32 AND 50).
FIRST USE 11-27-2001; IN COMMERCE 11-27-2001.

SN 76-346,432. BOHNSACK, JENNIFER, PLANO, TX. FILED 12-6-2001.

COZY DOZE

FOR PILLOWS WITH A POCKET CONTAINING A MATCHING BLANKET AND SOLD AS A SET (U.S. CLS. 2, 13, 22, 25, 32 AND 50).

SN 76-346,497. JSJ FURNITURE CORPORATION, GRAND HAVEN, MI. FILED 12-10-2001.

IZZYSEATING

FOR FURNITURE (U.S. CLS. 2, 13, 22, 25, 32 AND 50).

CLASS 20—(Continued).

SN 76-346,499. JSJ FURNITURE CORPORATION, GRAND HAVEN, MI. FILED 12-10-2001.

IZZYDESIGN

FOR FURNITURE (U.S. CLS. 2, 13, 22, 25, 32 AND 50).

SN 78-040,754. VIACOM INTERNATIONAL INC., NEW YORK, NY. FILED 12-27-2000.

LULU GREEN

THE NAME "LULU GREEN" DOES NOT IDENTIFY A LIVING INDIVIDUAL.
FOR PICTURE FRAMES (U.S. CLS. 2, 13, 22, 25, 32 AND 50).

SN 78-045,979. DIRECT SUPPLY, INC., MILWAUKEE, WI. FILED 2-1-2001.

PANACEA

FOR MATTRESSES (U.S. CLS. 2, 13, 22, 25, 32 AND 50).
FIRST USE 12-31-2000; IN COMMERCE 12-31-2000.

SN 78-066,235. ART VANDELAY INTERNATIONAL, LLC, ARCADIA, CA. FILED 5-29-2001.

SCREENS AND THINGS

NO CLAIM IS MADE TO THE EXCLUSIVE RIGHT TO USE "SCREENS", APART FROM THE MARK AS SHOWN.
FOR FURNITURE ITEMS MADE OF WOOD OR METAL OR STONE, OR ANY COMBINATION OF WOOD, METAL, AND STONE; NAMELY, TABLES, CHAIRS, BENCHES, CHESTS, MIRRORS, HEADBOARDS, STORAGE TRUNKS, WRITING DESKS, BAR CABINETS, STOOLS, AND BAKERS RACKS; HOME FURNISHING ACCESSORY ITEMS, NAMELY, SCREENS, FIREPLACE SCREENS, WOODEN JEWELRY BOXES, MAGAZINE RACKS, UMBRELLA STANDS, AND HAMPER CHESTS (U.S. CLS. 2, 13, 22, 25, 32 AND 50).
FIRST USE 1-0-1999; IN COMMERCE 1-0-1999.

SN 78-071,779. PASTA PILLOWS LLC, DARIEN, CT. FILED 6-29-2001.

PASTA PILLOWS

NO CLAIM IS MADE TO THE EXCLUSIVE RIGHT TO USE "PILLOWS", APART FROM THE MARK AS SHOWN.
FOR DECORATIVE PILLOWS (U.S. CLS. 2, 13, 22, 25, 32 AND 50).

CLASS 20—(Continued).

SN 78-098,187. ALISON SPEAR ARCHITECT, PA, MIAMI, FL. FILED 12-13-2001.

SPEARLINES

FOR FURNITURE (U.S. CLS. 2, 13, 22, 25, 32 AND 50).

CLASS 21—HOUSEWARES AND GLASS

SN 75-724,200. T.M.E. TECNOLOGIA MECANICA E ELETRICA INDUSTRIA E COMERCIO S/A, SAO BERNARDO DO CAMPO - S.P., BRAZIL, FILED 6-8-1999.

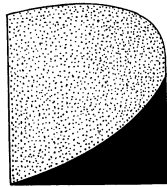

DESCO
DESIGN COMPANY

NO CLAIM IS MADE TO THE EXCLUSIVE RIGHT TO USE "DESIGN COMPANY", APART FROM THE MARK AS SHOWN.

THE STIPPLING IN THE DRAWING IS FOR SHADING PURPOSES ONLY.

FOR BATHROOM ACCESSORIES, NAMELY, SOAP BOXES, TOOTH BRUSH HOLDERS, INSULATING JARS TO HOLD COTTON BALLS AND COTTON SWABS; FOOD-CONTAINER SETS; SALT SHAKERS; PEPPER SHAKERS; NAPKIN-HOLDERS; SALAD BOWLS; ALL PURPOSE PORTABLE HOUSEHOLD CONTAINERS FOR SPICES AND SALAD DRESSING; SUGAR BOWLS; SPOONS FOR SERVING RICE; SALAD TONGS; INSULATING JARS TO HOLD JUICE; WINE AND WATER GLASSES; GRATED CHEESE CONTAINERS; DISHES AND BOWLS; BOTTLE CRADLES FOR WINE; PAPER TOWEL HOLDERS; CONTAINERS FOR FOODS, NAMELY, CANDY, AND DESSERTS; MEAL TRAYS; MEAL TRAYS WITH DIVISIONS; SERVING TRAYS WITH DIVISIONS; DISH DRAINERS; CUTLERY HOLDERS; CHEESE PLATES; PIE DISHES; CUPS AND SAUCERS; SALAD DISHES WITH DIVISIONS; CORK-SCREWS; CUTLERY DRAINERS; PASTA COLANDERS FOR HOUSEHOLD USE; ORANGE SQUEEZERS; CUTLERY HOLDERS FOR DRAWERS; FUNNELS; BUTTER DISHES; AND MILK JUGS, ALL OF WHICH ARE MADE OF PLASTIC (U.S. CLS. 2, 13, 23, 29, 30, 33, 40 AND 50).

CLASS 21—(Continued).

SN 75-886,427. ANCHOR HOCKING INC., FREEPORT, IL. BY ASSIGNMENT NEWELL OPERATING COMPANY, FREEPORT, IL. FILED 1-4-2000.



NO CLAIM IS MADE TO THE EXCLUSIVE RIGHT TO USE "COMPANY", APART FROM THE MARK AS SHOWN. FOR GLASSWARE, NAMELY, BEVERAGE GLASSES, DRINKING MUGS, EGG PLATES, SALAD PLATES AND BOWLS, SERVING PLATTERS, CAKE DOMES, AND PITCHERS; BAKEWARE; GLASS OVENWARE, NAMELY BAKING DISHES, CASSEROLE DISHES, PIE PLATES, CAKE DISHES, AND LOAF DISHES; DINNERWARE; BEVERAGEWARE; SERVING SPOONS AND SERVING DISHES; GLASS STORAGEWARE, NAMELY, JARS, VOTIVES, CANDLEHOLDERS, AND FISHBOWLS (U.S. CLS. 2, 13, 23, 29, 30, 33, 40 AND 50).

SN 76-032,791. PROFIT-PAK, LLC, BOISE, ID. FILED 4-18-2000.

MARATHON

FOR PLASTIC BEVERAGEWARE AND LIDS THEREFOR (U.S. CLS. 2, 13, 23, 29, 30, 33, 40 AND 50).

SN 76-107,502. J.F.OAKES SALES & MARKETING, LLC, YAZOO CITY, MS. FILED 8-11-2000.

**ADVANTAGE FLYING
INSECT TRAP**

NO CLAIM IS MADE TO THE EXCLUSIVE RIGHT TO USE "FLYING INSECT TRAP", APART FROM THE MARK AS SHOWN.

FOR INSECT TRAP (U.S. CLS. 2, 13, 23, 29, 30, 33, 40 AND 50).

FIRST USE 7-27-1999; IN COMMERCE 3-7-2000.

SN 76-118,691. SHEH JONE ENTERPRISE CO., LTD., TAILIAO HSIANG, KAOHSIUNG, TAIWAN, FILED 8-29-2000.

SUPERBOND

FOR STIR FRYING PANS, FRYING PANS, METAL COOKING PANS, GRILL PANS, COOKING POTS, OVAL STEWPOTS, NON-ELECTRIC DEEP FRYERS, CAULDRONS, SAUCEPANS, STEW-PANS, POTS, WOKS, STIR WOKS, DUTCH OVENS (U.S. CLS. 2, 13, 23, 29, 30, 33, 40 AND 50).

CLASS 21—(Continued).

SN 76-180,383. 3600815 CANADA, INC., MONTREAL, CANADA, FILED 12-14-2000.



FOR FIGURINES AND DISPLAY STANDS THEREFORE, MADE OF CHINA, CRYSTAL, EARTHENWARE, GLASS, PORCELAIN, AND TERRACOTTA (U.S. CLS. 2, 13, 23, 29, 30, 33, 40 AND 50).

SN 76-185,652. PARAMOUNT PICTURES CORPORATION, LOS ANGELES, CA. FILED 12-21-2000.

WHITE CHRISTMAS

FOR PORCELAIN FIGURINES, PLATES, MUGS; AND CONTAINERS AND CANISTERS FOR HOUSEHOLD USE (U.S. CLS. 2, 13, 23, 29, 30, 33, 40 AND 50).

SN 76-205,139. THAT WINE IS MINE, INC., ENGLEWOOD, CO. FILED 2-2-2001.

MARKET FRESH

FOR BEVERAGE GLASS IDENTIFICATION RINGS NOT OF PRECIOUS METAL (U.S. CLS. 2, 13, 23, 29, 30, 33, 40 AND 50).
FIRST USE 1-1-2001; IN COMMERCE 1-1-2001.

SN 76-236,955. LAGANO, LANCE R., LAGUNA NIGUEL, CA. FILED 4-6-2001.

ZIGFLOSS

FOR TOOTH CLEANING IMPLEMENTS, NAMELY, TOOTHPLICKS, TOOTHBRUSHES, DENTAL FLOSS AND DENTAL FLOSS HOLDING TOOTH CLEANING IMPLEMENTS (U.S. CLS. 2, 13, 23, 29, 30, 33, 40 AND 50).

CLASS 21—(Continued).

SN 76-280,373. LAPELLA GROUP PTY LTD, THE, BALMAIN, NEW SOUTH WALES, AUSTRALIA, FILED 7-5-2001.



OWNER OF U.S. REG. NO. 2,464,286.

NO CLAIM IS MADE TO THE EXCLUSIVE RIGHT TO USE "ARTIFICIAL", "DECORATIVE PRESERVES" AND "DESIGNED BY", APART FROM THE MARK AS SHOWN.

"CUCINA" IS AN ITALIAN AND SPANISH WORD WHICH, WHEN TRANSLATED INTO ENGLISH, MEANS "KITCHEN".

FOR DECORATIVE HOUSEHOLD GOODS, NAMELY GLASSWARE CONTAINING ARRANGEMENTS OF ARTIFICIAL FOODSTUFFS, ARTIFICIAL FRUITS AND VEGETABLES (U.S. CLS. 2, 13, 23, 29, 30, 33, 40 AND 50).

SN 76-280,795. W.C. BRADLEY COMPANY, COLUMBUS, GA. FILED 7-5-2001.

GRILLIN' STICK

NO CLAIM IS MADE TO THE EXCLUSIVE RIGHT TO USE "GRILLING", APART FROM THE MARK AS SHOWN.

FOR MULTI-PURPOSE GRILLING TOOLS HAVING FOLDABLE SPATULA, TONGS, FORK, KNIVES, AND BRUSHES (U.S. CLS. 2, 13, 23, 29, 30, 33, 40 AND 50).

SN 76-305,723. RESPONSIBLE ME., INC., ORLANDO, FL. FILED 8-28-2001.

CLIP-AWAY FEEDING TRAY

NO CLAIM IS MADE TO THE EXCLUSIVE RIGHT TO USE "FEEDING TRAY", APART FROM THE MARK AS SHOWN.

FOR MEAL, FOOD AND BEVERAGE TRAYS FOR JUVENILE SEATS (U.S. CLS. 2, 13, 23, 29, 30, 33, 40 AND 50).

FIRST USE 7-1-2000; IN COMMERCE 7-1-2000.

SN 76-306,981. SAINT-GOBAIN CALMAR INC., CITY OF INDUSTRY, CA. FILED 8-30-2001.

SD

FOR MANUALLY ACTUATED PUMP DISPENSERS FOR ATTACHMENT TO CONTAINERS FOR USE IN DISPENSING LIQUIDS (U.S. CLS. 2, 13, 23, 29, 30, 33, 40 AND 50).

CLASS 21—(Continued).

SN 76-313,967. SAINT-GOBAIN CALMAR INC., CITY OF INDUSTRY, CA. FILED 9-18-2001.

SD200

FOR MANUALLY ACTUATED PUMP DISPENSERS FOR ATTACHMENT TO CONTAINERS FOR USE IN DISPENSING LIQUIDS (U.S. CLS. 2, 13, 23, 29, 30, 33, 40 AND 50).

FIRST USE 6-22-1983; IN COMMERCE 6-22-1983.

SN 76-315,585. KABAM PRODUCTS LLC, CLEVELAND, OH. FILED 9-21-2001.

POWER PRO

NO CLAIM IS MADE TO THE EXCLUSIVE RIGHT TO USE "POWER", APART FROM THE MARK AS SHOWN.

FOR ELECTRIC TOOTHBRUSHES, NAMELY, RECHARGEABLE ELECTRIC TOOTHBRUSHES AND BATTERY-OPERATED ELECTRIC TOOTHBRUSHES, RECHARGING UNITS AND BASES THEREFOR AND PARTS THEREOF, NAMELY, REPLACEMENT BRUSH HEADS (U.S. CLS. 2, 13, 23, 29, 30, 33, 40 AND 50).

SN 76-326,428. BELL LABORATORIES, INC., MADISON, WI. FILED 10-15-2001.

SIDEWINDER

FOR BAIT STATIONS FOR MICE AND RATS (U.S. CLS. 2, 13, 23, 29, 30, 33, 40 AND 50).

FIRST USE 8-30-2001; IN COMMERCE 8-30-2001.

SN 76-341,610. BIO-ELITE INCORPORATED, LONG BEACH, CA. FILED 11-26-2001.

BIO-ELITE

FOR PLASTIC WASTE CAN LINERS FOR DISPOSAL OF HAZARDOUS MEDICAL WASTE PRODUCTS (U.S. CLS. 2, 13, 23, 29, 30, 33, 40 AND 50).

FIRST USE 5-14-2001; IN COMMERCE 5-14-2001.

SN 78-040,761. VIACOM INTERNATIONAL INC., NEW YORK, NY. FILED 12-27-2000.

LULU GREEN

THE NAME "LULU GREEN" DOES NOT IDENTIFY A LIVING INDIVIDUAL.

FOR MUGS (U.S. CLS. 2, 13, 23, 29, 30, 33, 40 AND 50).

CLASS 21—(Continued).

SN 78-093,356. BUTCHER COMPANY, THE, MARLBOROUGH, MA. FILED 11-14-2001.

RTD

FOR DISPENSERS FOR CLEANING AND DISINFECTANT PREPARATIONS (U.S. CLS. 2, 13, 23, 29, 30, 33, 40 AND 50).

CLASS 22—CORDAGE AND FIBERS

SN 76-168,754. TURNILS AB, S-441 39 ALINGSAS, SWEDEN, FILED 11-20-2000.

SOLEX

FOR EXTERIOR RETRACTABLE AWNINGS OF TEXTILE AND PARTS AND FITTINGS THEREFOR (U.S. CLS. 1, 2, 7, 19, 22, 42 AND 50).

FIRST USE 4-20-2001; IN COMMERCE 4-20-2001.

SN 76-231,329. SOLUTIA INC., ST. LOUIS, MO. FILED 3-27-2001.



OWNER OF U.S. REG. NO. 1,174,279.
NO CLAIM IS MADE TO THE EXCLUSIVE RIGHT TO USE "FIBERS", APART FROM THE MARK AS SHOWN.

FOR SYNTHETIC FIBERS AND FILAMENTS FOR USE IN THE MANUFACTURE OF YARN AND TEXTILES (U.S. CLS. 1, 2, 7, 19, 22, 42 AND 50).

SN 78-085,421. CANVAS SPECIALTY, INC., LOS ANGELES, CA. FILED 9-25-2001.

FABRICTECHNOLOGYSOLUTIONS

FOR FABRIC PRODUCTS USED TO PROVIDE COVERAGE, NAMELY, AWNINGS, TENTS, AND CANOPIES (U.S. CLS. 1, 2, 7, 19, 22, 42 AND 50).

CLASS 22—(Continued).

SN 78-096,846. YALE CORDAGE INC., BIDDEFORD, ME. FILED 12-5-2001.

LOUP

FOR CORDAGE (U.S. CLS. 1, 2, 7, 19, 22, 42 AND 50).

SN 78-096,848. YALE CORDAGE INC., BIDDEFORD, ME. FILED 12-5-2001.

LOUPS

FOR CORDAGE (U.S. CLS. 1, 2, 7, 19, 22, 42 AND 50).

CLASS 24—FABRICS

SN 75-824,961. WARWICK MILLS, INC., NEW IPSWICH, NH. FILED 10-18-1999.

TURTLESKIN

OWNER OF U.S. REG. NO. 2,099,420. SEC. 2(F).

FOR CUT/ABRASION/PENETRATION RESISTANT PROTECTIVE FABRIC FOR THE MANUFACTURE OF APPAREL; FOOTWEAR; GLOVES; PROTECTIVE EQUIPMENT, NAMELY, PROTECTIVE TRANSPORT CONTAINERS OR COMPONENTS THEREOF AND PROTECTIVE MATERIAL LINING THE CONTAINERS OR COMPONENTS THEREOF; BLANKETS; SPORTING GOODS; PROTECTIVE SAFETY EQUIPMENT; INFLATABLE OBJECTS; BACKPACKS; LUGGAGE; BAGS AND CARRYING CASES; SEAT COVERS; TIRE LINERS FOR BICYCLES AND IMPACT CRASH BAGS (U.S. CLS. 42 AND 50).
FIRST USE 1-0-1995; IN COMMERCE 1-0-1995.

SN 75-942,618. RITZ HOTEL, LIMITED, THE, LONDON, ENGLAND, FILED 3-13-2000.



OWNER OF U.S. REG. NO. 198,522. SEC. 2(F).
FOR FABRICS FOR THE MANUFACTURE OF CUSTOM WINDOW TREATMENTS; FABRICS FOR THE MANUFACTURE OF CUSTOM CURTAINS AND CUSTOM DRAPERIES; UPHOLSTERY FABRICS; FABRICS FOR THE MANUFACTURE OF CUSTOM BED COVERS, BEDSKIRTS, SHAMS AND PILLOW COVERS; FABRICS FOR THE MANUFACTURE OF CUSTOM WALL HANGINGS; AND TRIMMINGS FOR ALL OF THE FOREGOING (U.S. CLS. 42 AND 50).

CLASS 24—(Continued).

SN 75-981,735. DOLLY, INC., TIPP CITY, OH. FILED 5-7-2001.

MAKE'N WAVES

FOR WASHCLOTHS AND TOWELS (U.S. CLS. 42 AND 50).

SN 76-068,747. 748963 ONTARIO, INC., DBA JAYLAN SPECIALTY PRODUCTS, TORONTO, ONTARIO, CANADA, FILED 6-12-2000.

ALLERGEN

PRIORITY CLAIMED UNDER SEC. 44(D) ON CANADA APPLICATION NO. 1039656, FILED 12-15-1999.
FOR FABRIC, NAMELY, COVERINGS AND ENCASINGS FOR PILLOWS, DUVETS, MATTRESSES AND BOX SPRINGS THAT ACT AS AN ALLERGEN BARRIER (U.S. CLS. 42 AND 50).

SN 76-082,829. PACIFIC TEXTILES LIMITED, KWAI CHUNG, N.T., HONG KONG, FILED 7-5-2000.



FOR FABRIC, NAMELY, ESPARTO FABRIC, FABRIC FOR BOOTS AND SHOES, FABRIC OF IMITATION ANIMAL SKINS, FABRIC FOR TEXTILE USE, FACE TOWELS OF TEXTILE, RAYON FABRIC, SILK CLOTH, SILK FABRICS FOR PRINTING PATTERNS, TABLE CLOTHS NOT OF PAPER, WOOLEN CLOTH AND WOOLEN FABRIC (U.S. CLS. 42 AND 50).
FIRST USE 3-23-2000; IN COMMERCE 3-23-2000.

CLASS 24—(Continued).

SN 76-114,399. ALEXANDER JULIAN, INC., RIDGEFIELD, CT. FILED 8-22-2000.



THE MARK IS LINED FOR THE COLORS GREEN, BLUE AND RED.

FOR BED SHEETS, PILLOW CASES, MATTRESS COVERS, COMFORTERS, SHAMS, THROWS, AFGHANS, DRAPERY; BATH, BEACH AND KITCHEN TOWELS; DECORATIVE FABRICS FOR USE IN THE MANUFACTURER OF HOME FURNISHING; SHOWER CURTAINS; KITCHEN ACCESSORIES, NAMELY, CHEESE CLOTHS, OVEN MITTS AND POTHOLDERS; WINDOW TREATMENTS, NAMELY, DRAPES, WINDOW CURTAINS; TABLE CLOTHS, LINENS, NAPKINS AND PLACEMATS MADE OF FABRIC (U.S. CLS. 42 AND 50).

SN 76-138,775. FORD MOTOR COMPANY, DEARBORN, MI. FILED 10-2-2000.

THINK

FOR FABRICS, NAMELY, TOWELS, BED BLANKETS, STADIUM BLANKETS, CLOTH FLAGS, PENNANTS NOT OF PAPER, POT HOLDERS, TEXTILE NAPKINS, TEXTILE PLACE MATS, WASHING MITTS (U.S. CLS. 42 AND 50).

SN 76-138,784. FORD MOTOR COMPANY, DEARBORN, MI. FILED 10-2-2000.

TH!NK

FOR FABRICS, NAMELY, TOWELS, BED BLANKETS, STADIUM BLANKETS, CLOTH FLAGS, PENNANTS NOT OF PAPER, POT HOLDERS, TEXTILE NAPKINS, TEXTILE PLACE MATS, WASHING MITTS (U.S. CLS. 42 AND 50).

SN 76-229,269. PILLOWTEX CORPORATION, DALLAS, TX. FILED 3-26-2001.

BOLDER BLENDS

NO CLAIM IS MADE TO THE EXCLUSIVE RIGHT TO USE "BLENDS", APART FROM THE MARK AS SHOWN.

FOR DOWN COMFORTERS AND FEATHER BEDS (U.S. CLS. 42 AND 50).

CLASS 24—(Continued).

SN 76-229,809. DICKIE WALKER MARINE, INC., LA JOLLA, CA. FILED 3-26-2001.



NO CLAIM IS MADE TO THE EXCLUSIVE RIGHT TO USE "BUILT 1951" AND "AUTHENTIC MARINE", APART FROM THE MARK AS SHOWN.

THE STIPPLING IN THE MARK IS FOR SHADING PURPOSES ONLY.

THE NAME "DICKIE WALKER" IS THE NAME OF A BOAT AND NOT THE NAME OF ANY KNOWN OR PARTICULAR LIVING INDIVIDUAL.

FOR TEXTILES AND TEXTILE FURNISHINGS FOR SHIPS, NAMELY, FLAGS, PENNANTS, WINDOW CURTAINS, SHOWER CURTAINS, PLACEMATS, NAPKINS, TABLE CLOTHS, BLANKET THROWS, TABLE RUNNERS, UNFITTED FABRIC FURNITURE COVERS, WALL HANGINGS, BEACH AND BATHROOM TOWELS, BATH MATS, KITCHEN TOWELS, POT HOLDERS, OVEN MITTS, HAND TOWELS, DISH TOWELS, WASH CLOTHS; BEDDING, NAMELY, LINENS, BLANKETS, SHEETS, PILLOW CASES, COMFORTERS, QUILTS AND BED SPREADS (U.S. CLS. 42 AND 50).

SN 76-264,513. RICHARDS, ASHLEY T., TUCSON, AZ. FILED 5-31-2001.

TOOTH FAIRY POUCH

NO CLAIM IS MADE TO THE EXCLUSIVE RIGHT TO USE "POUCH", APART FROM THE MARK AS SHOWN.

FOR SMALL "PURSE-LIKE" POUCHES MADE OF FABRIC DECORATED WITH FAIRIES, ANIMALS, STARS, AND OTHER FIGURES, THAT ARE USED TO HOLD A CHILD'S TOOTH AND COINS, CURRENCY, AND SMALL GIFTS (U.S. CLS. 42 AND 50).

FIRST USE 1-1-2001; IN COMMERCE 1-31-2001.

SN 76-276,790. SPRADLING HOLDINGS, INC., PELHAM, AL. FILED 6-26-2001.

FR BLOK

NO CLAIM IS MADE TO THE EXCLUSIVE RIGHT TO USE "FR", APART FROM THE MARK AS SHOWN.

FOR VINYL-COATED FABRIC, NAMELY, FLAME-RETARDANT FABRIC FOR USE IN VEHICLES AND MODES OF TRANSPORTATION (U.S. CLS. 42 AND 50).

CLASS 24—(Continued).

SN 76-310,942. SHAVEL ASSOCIATES, INC., PRINCETON, NJ. FILED 9-10-2001.

RACHEL PARKER

THE NAME IN THE MARK DOES NOT IDENTIFY A LIVING INDIVIDUAL.

FOR HOME TEXTILES, NAMELY, SHEETS, PILLOW-CASES, TOWELS, BED COVERS, COMFORTERS, BED SPREADS, DRAPERIES, CURTAINS, TABLECLOTHS, NAPKINS, BATHMATS (U.S. CLS. 42 AND 50).

SN 76-326,624. BI PROPERTIES I INC., GREENSBORO, NC. FILED 10-17-2001.

WOVEN AIR

NO CLAIM IS MADE TO THE EXCLUSIVE RIGHT TO USE "WOVEN", APART FROM THE MARK AS SHOWN.

FOR TEXTILE FABRICS FOR USE IN THE MANUFACTURE OF CLOTHING (U.S. CLS. 42 AND 50).
FIRST USE 1-31-2000; IN COMMERCE 1-31-2000.

SN 76-341,642. AKROTEKS DIS TICARET VE PAZARLAMA ANONIM SIRKETI, BURSA, TURKEY, FILED 11-27-2001.

PERGA

FOR TEXTILES AND TEXTILE PRODUCTS, NAMELY, CURTAINS, DRAPERIES, BANNERS, FLAGS, AND WALL HANGINGS; BEDDING, NAMELY, SPREADS, QUILTS, COMFORTERS, PILLOW CASES, BED SHEETS, DUST RUFFLES, DUVET COVERS, MATTRESS COVERS, AND MATTRESS PADS; TABLE COVERS NOT MADE OF PAPER; HAND TOWELS, KITCHEN TOWELS, WASHCLOTHS, AND BATH TOWELS; HANDKERCHIEFS (U.S. CLS. 42 AND 50).
FIRST USE 5-22-1998; IN COMMERCE 6-15-2000.

SN 78-047,651. KEMPE-WEST ENTERPRISES LTD., COQUITLAM, BRITISH COLUMBIA, FILED 2-9-2001.

EQUUSBLOC

OWNER OF CANADA REG. NO. TMA357475, DATED 6-23-1989, EXPIRES 6-23-2004.

FOR TEXTILE FOR THERAPEUTIC TREATMENT OF ANIMALS, NAMELY, HORSE COVERS, HORSE BLANKETS, LEG WRAPS AND DOG BLANKETS (U.S. CLS. 42 AND 50).

CLASS 24—(Continued).

SN 78-059,300. OLD NAVY (APPAREL) INC., SAN BRUNO, CA. FILED 4-19-2001.

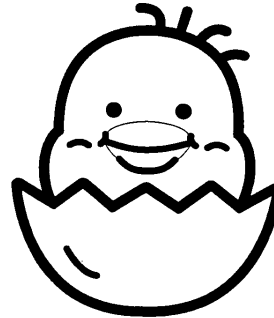

FOR BLANKETS (U.S. CLS. 42 AND 50).
FIRST USE 10-1-1999; IN COMMERCE 10-1-1999.

SN 78-091,935. WHIRLPOOL PROPERTIES, INC., ST. JOSEPH, MI. FILED 11-6-2001.

LIQUAZORB

FOR KITCHEN TOWELS (U.S. CLS. 42 AND 50).

CLASS 25—CLOTHING

SN 74-721,899. GOODY'S FAMILY CLOTHING, INC., KNOXVILLE, TN. FILED 8-28-1995.

MONTANA BLUES
• J E A N C O M P A N Y •

NO CLAIM IS MADE TO THE EXCLUSIVE RIGHT TO USE "BLUES" AND "JEAN COMPANY", APART FROM THE MARK AS SHOWN.

FOR MEN'S, WOMEN'S AND CHILDREN'S CLOTHING, NAMELY - SHIRTS, PANTS, JACKETS, SKIRTS, DRESSES, BELTS AND SHOES (U.S. CLS. 22 AND 39).

CLASS 25—(Continued).

SN 75-187,703. UNICORN ORGANISATION LIMITED, DUBLIN 2 - EIRE, IRELAND, FILED 10-25-1996.

CULTURA

THE WORD "CULTURA" MEANS "CULTURE" IN ITALIAN.

FOR WOMEN'S, MEN'S BOYS AND GIRLS WEARING APPAREL, NAMELY SHIRTS, BLOUSES, JACKETS, BATHING SUITS, BEACH AND SWIMMING COVER-UPS, PANTS, DRESSES, SHORTS, SKIRTS, JEANS, GLOVES, SUITS, SPORTS JACKETS, BELTS, SOCKS, UNDERWEAR, STOCKINGS, TIGHTS, HATS, SWEATERS, COATS, VESTS, T-SHIRTS, RAINWEAR, RAINCOATS, TANK TOPS, SHOES, BOOTS, SLIPPERS, BLAZERS, BRAS, NIGHTGOWNS, ROBES, SCARVES AND SHAWLS (U.S. CLS. 22 AND 39).

SN 75-330,403. LICHER, ERWIN-OTTO, MUNICH, D-80799, FED REP GERMANY, FILED 7-25-1997.



"FREEMAN T. PORTER" IDENTIFIES A LIVING INDIVIDUAL WHOSE CONSENT IS OF RECORD.

FOR MEN'S AND WOMEN'S CLOTHING, NAMELY, PANTS, SHORTS, SKIRTS, SHIRTS, DRESSES, BLOUSES, JACKETS, COATS, HATS, CAPS, BELTS, SHOES, UNDERWEAR, NECKTIES, AND BATHING SUITS (U.S. CLS. 22 AND 39).

FIRST USE 10-1-2001; IN COMMERCE 10-1-2001.

SN 75-460,954. ARCHER, MARK, JACKSONVILLE, FL. FILED 4-2-1998.

DYME

FOR PANTS T-SHIRTS SHIRTS HATS SWEATERS SWEATSHIRTS (U.S. CLS. 22 AND 39).

SN 75-580,228. SARAMAR, L.L.C., CHICAGO, IL. FILED 10-30-1998.

ENCHANTRESS

FOR BRASSIERES (U.S. CLS. 22 AND 39).

CLASS 25—(Continued).

SN 75-625,889. BNL ENTERTAINMENT INC., TORONTO, ONTARIO M4K 3L1, CANADA, FILED 1-25-1999.

BARENAKED

FOR SHIRTS, T-SHIRTS, SWEATSHIRTS, BASEBALL SHIRTS, JACKETS, BOXER SHORTS, HATS AND CAPS (U.S. CLS. 22 AND 39).

FIRST USE 12-31-1990; IN COMMERCE 8-0-1992.

SN 75-655,660. JACADI, 92000 NANTERRE, FRANCE, FILED 3-8-1999.

DIPAKI

OWNER OF FRANCE REG. NO. 1643938, DATED 2-12-1991, RENEWED AS REG. NO. 2191811, DATED 2-12-2001, EXPIRES 2-12-2011.

FOR CLOTHING, NAMELY, BATHING SUITS, BATH ROBES, SWIMWEAR, BERMUDA SHORTS, SHIRTS, SWEATERS, SHORTS, TRACK SUITS, PANTS, SKIRTS, BLOOMERS, UNDERSHIRTS, CARDIGANS, PULL-OVERS, PARKAS, OVERALLS, DRESSES, SUITS, JACKETS, RAINWEAR, OVERCOATS, COATS, CAPES, WIND-RESISTANT JACKETS, MUFFS, TIES, BELTS, SUSPENDERS, STOLE, FOUNDATION GARMENT GIRDLES, FOULARDS, SCARVES, GLOVES, MITTENS, SOCKS, STOCKINGS, TIGHTS, HEADBANDS, CLOTH BIBS, CLOTH DIAPERS, UNDERWEAR, PAJAMAS, FOOTWEAR EXCEPT ORTHOPEDICS, AND HEADWEAR (U.S. CLS. 22 AND 39).

SN 75-660,805. TWO TSUNAMI PRODUCTIONS, INC., BROOKLYN, NY. FILED 3-15-1999.

CRYPTO

FOR CLOTHING, NAMELY SHIRTS, SHORTS, PANTS, AND SKIRTS (U.S. CLS. 22 AND 39).

FIRST USE 9-28-1997; IN COMMERCE 9-28-1997.

SN 75-743,240. PINHAS, NAHOUM, BROOKLYN, NY. FILED 7-6-1999.

ROGARD

FOR CLOTHING, NAMELY, SHIRTS, SHORTS, SKIRTS, SWEATERS, BLOUSES, JACKETS, SOCKS, HATS, GLOVES, SHOES AND UNDERGARMENTS (U.S. CLS. 22 AND 39).

FIRST USE 12-10-1999; IN COMMERCE 12-10-1999.

CLASS 25—(Continued).

SN 75-858,832. TIME WARNER ENTERTAINMENT COMPANY, L.P., NEW YORK, NY. FILED 11-24-1999.

NIMBUS TWO THOUSAND

FOR CLOTHING FOR MEN, WOMEN AND CHILDREN, NAMELY, SHIRTS, T-SHIRTS, SWEATSHIRTS, JOGGING SUITS, TROUSERS, PANTS, SHORTS, TANK TOPS, RAINWEAR, CLOTH BIBS, SKIRTS, BLOUSES, DRESSES, SUSPENDERS, SWEATERS, JACKETS, COATS, RAINCOATS, SNOW SUITS, TIES, ROBES, HATS, CAPS, SUN VISORS, BELTS, SCARVES, SLEEPWEAR, PAJAMAS, LINGERIE, UNDERWEAR, BOOTS, SHOES, SNEAKERS, SANDALS, BOOTIES, SLIPPER SOCKS, SWIMWEAR AND MASQUERADE AND HALLOWEEN COSTUMES AND MASKS SOLD IN CONNECTION THEREWITH (U.S. CLS. 22 AND 39).

FIRST USE 10-5-2000; IN COMMERCE 10-5-2000.

SN 75-871,991. CHESTER GREGG, L.L.C., BRISTOL, TN. FILED 12-14-1999.

CHESTER
GREGG

THE NAMES IN THE MARK DO NOT IDENTIFIES ANY LIVING INDIVIDUAL.

FOR CLOTHING, NAMELY SHIRTS OF VARIOUS DESIGNS AND FULL OR REDUCED LENGTH TROUSERS OF VARIOUS DESIGNS (U.S. CLS. 22 AND 39).

FIRST USE 8-25-1999; IN COMMERCE 8-25-1999.

CLASS 25—(Continued).

SN 75-872,285. ELEFANTEN KG, D-47533 KLEVE, FED REP GERMANY, FILED 12-14-1999.

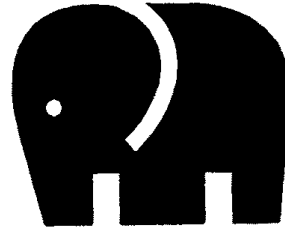

OWNER OF U.S. REG. NOS. 1,301,783, 1,303,802 AND 1,805,347.

FOR FOOTWEAR AND COMPONENT PARTS OF FOOTWEAR; NAMELY, BOOTS, SHOES, SLIPPERS, HEELS, SOLES, INNER SOLES, TOE STIFFENERS, HEEL PIECES, LINERS, HEEL INSERTS, INSOLES, METAL IMPACT PROTECTORS AND REINFORCEMENTS FOR BOOTS AND SHOES, BOOT AND SHOE UPPERS, SOCKS WITH SOLES FUSED THERETO MADE OF PVC PLASTIC OR TEXTILE MATERIAL (U.S. CLS. 22 AND 39).

SN 75-877,332. SARA LEE CORPORATION, WINSTON-SALEM, NC. FILED 12-21-1999.

BROWN SUGAR

FOR HOSIERY AND PANTYHOSE (U.S. CLS. 22 AND 39).

FIRST USE 3-18-1975; IN COMMERCE 3-18-1975.

SN 75-885,683. STEVIES, INC., LONG ISLAND CITY, NY. BY ASSIGNMENT STEVEN MADDEN, LTD., LONG ISLAND CITY, NY. FILED 1-4-2000.



FOR CLOTHING; NAMELY, PANTS, JACKETS, TEE SHIRTS, DRESSES, JEANS, SWEATERS, SOCKS AND FOOTWEAR (U.S. CLS. 22 AND 39).

CLASS 25—(Continued).

SN 75-942,287. DAN & DENNIS LLC, NEW ROCHELLE, NY.
FILED 3-13-2000.

PENNACCHIO

THE ENGLISH TRANSLATION OF "PENNACCHIO" IS
"CLOUD OF SMOKE".

FOR WOMEN'S CLOTHING, NAMELY, HOSIERY,
PANTYHOSE, AND SPORTSWEAR, NAMELY DRESSES,
SUITS, TOPS, PANTS, SWEATERS, AND VESTS (U.S.
CLS. 22 AND 39).

FIRST USE 2-0-1999; IN COMMERCE 1-0-2000.

SN 76-013,539. WINBIGTODAY.COM, NEW YORK, NY.
FILED 3-30-2000.

**WORKING IN
NEIGHBORHOODS
NURTURING EDUCATION
RECREATION SPORTS
W.I.N.N.E.R.S.**

FOR T-SHIRTS, SWEATSHIRTS, SWEAT PANTS,
PANTS, SKIRTS, DRESSES, SHORTS, TANK TOPS,
SHIRTS, VESTS, BLOUSES, NIGHTSHIRTS, PAJAMAS,
BOXER SHORTS, UNDERGARMENTS, BATHING
SUITS, RAIN COATS AND RAIN WEAR, BATHROBES,
APRONS, JACKETS, SCARVES, SWEATERS, WRIST
BANDS, HEAD BANDS, NECK TIES, BELTS, SNEA-
KERS, SHOES, SOCKS, HATS AND CAPS (U.S. CLS. 22
AND 39).

SN 76-020,738. DREW PEARSON MARKETING/FRESH
CAPS, ADDISON, TX. FILED 4-7-2000.

FILLABONG

FOR CLOTHING, NAMELY STANDARD AND COLD
WEATHER HEADWEAR, KNIT HATS, SCARVES,
GLOVES, MITTENS AND T-SHIRTS (U.S. CLS. 22 AND
39).

FIRST USE 11-0-1999; IN COMMERCE 11-0-1999.

SN 76-021,059. LONGSHORE, MICHAEL R., DUARTE, CA.
FILED 4-10-2000.

UNIVERSAL PEACEWEAR

FOR CLOTHING, NAMELY, UNDERWEAR, BRIEFS,
BOXERS AND GLOVES, SHIRTS, PANTS, SWEATSUITS,
CAPS, BEANNIES, T-SHIRTS, ROBES, SOCKS, SHOES,
TENNIS SHOES, TIES, DRESSES AND PAJAMAS (U.S.
CLS. 22 AND 39).

FIRST USE 12-0-2001; IN COMMERCE 12-0-2001.

CLASS 25—(Continued).

SN 76-044,380. TANNK, LLC, RACINE, WI. FILED 5-9-2000.

TANNK

FOR CLOTHING FOR HUNTERS, FISHERMEN AND
SPORTSMEN, NAMELY, JACKETS, SHIRTS AND HATS
(U.S. CLS. 22 AND 39).

SN 76-044,824. HEWITT, GREGORY, GREENSBORO, NC.
FILED 5-9-2000.

CRU THIK

FOR SHIRTS, PANTS, SHORTS, HATS, JACKETS,
JERSEYS, COATS, SOCKS SHOES (U.S. CLS. 22 AND 39).

SN 76-071,209. GLOBAL STYLE IMAGES, INC., SAN DIEGO,
CA. FILED 6-16-2000.

BOARD BUDDIEZ

FOR CLOTHING, NAMELY, JACKETS, RAINCOATS,
PANTS, SHORTS, SWEATERS, SWEATPANTS, SWEAT-
SHIRTS, T-SHIRTS, SHIRTS, SOCKS, UNDERWEAR,
OVERALLS, DRESSES, SKIRTS, TANK TOPS, POLO
SHIRTS, VESTS, PAJAMAS, JUMPSUITS, GLOVES,
NECK TIES, BANDANNAS, BELTS AND SUSPENDERS;
HEADGEAR, NAMELY, HATS, CAPS, AND SUN VI-
SORS; FOOTWEAR, NAMELY SHOES, SLIPPERS, AND
SANDALS (U.S. CLS. 22 AND 39).

FIRST USE 11-0-2000; IN COMMERCE 11-0-2000.

SN 76-081,520. WEBB, FELICIA D., DBA ROYAL IMAGE,
SUISUN CITY, CA. FILED 6-29-2000.



FOR CLOTHING NAMELY, T-SHIRTS, SWEAT-
SHIRTS, AND CAPS BEARING CREATIVE EXPRES-
SIONS SUCH AS POETRY AND INSPIRATIONAL
VERSES (U.S. CLS. 22 AND 39).

FIRST USE 10-22-1999; IN COMMERCE 10-22-1999.

CLASS 25—(Continued).

SN 76-088,928. VALMOS S.R.L., FLORENCE, ITALY, FILED 7-14-2000.

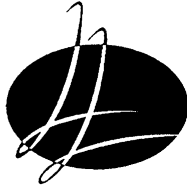

PRIORITY CLAIMED UNDER SEC. 44(D) ON ITALY APPLICATION NO. FI2000C/877, FILED 6-23-2000, REG. NO. 828824, DATED 6-23-2000, EXPIRES 6-23-2010.

THE MARK CONSISTS OF THE LETTERS LL IN A FANCIFUL DESIGN CLAIMING THE 3 SHADES OF BLUE. THE OVAL BACKGROUND IS COBALT BLUE, THE UPPER "L" A LIGHT BLUE AND THE BOTTOM "L" AN AQUA BLUE.

FOR CLOTHING, NAMELY, SHIRTS, JERSEYS, T-SHIRTS, DRESSES, GOWNS, SWIMWEAR, SOCKS, STOCKINGS, TIGHTS, PAJAMAS, NIGHTGOWNS, NEG-LIGEEES, BODY SUITS, BABY DOLLS, CORSETS, GIRDLES, BRAS, SLIPS, VESTS, CORSELETS, CAMISOLES, TEDDY, SHORTS, SUSPENDERS, SUSPENDER BELTS, LOINCLOTHS (U.S. CLS. 22 AND 39).

SN 76-093,345. ALTERA CORPORATION, SAN JOSE, CA. FILED 7-20-2000.

ALTERA

FOR CLOTHING, NAMELY, DENIM SHIRTS, POLO SHIRTS, GOLF SHIRTS, T-SHIRTS, SWEATSHIRTS, SWEATPANTS, PULLOVER SHIRTS/JACKETS, JACKETS, VISORS AND CAPS (U.S. CLS. 22 AND 39).
FIRST USE 0-0-1989; IN COMMERCE 0-0-1989.

SN 76-109,173. APOLLO USA TRADING INC., EAST BOSTON, MA. FILED 8-15-2000.

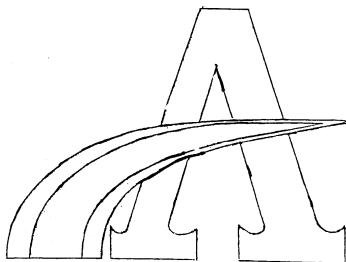

A LETTER "A" WITH A HALF ARCH THROUGH IT RIGHT TO LEFT.

FOR CLOTHING, NAMELY, SHOES, JERSEYS, JACKETS, HATS, SKI WEAR, SWIM WEAR AND SPORTS WEAR, NAMELY, SHORTS, SHIRTS, JOGGING SUITS AND GYM SUITS (U.S. CLS. 22 AND 39).

CLASS 25—(Continued).

SN 76-113,866. SUSIE MOON NEW YORK INC., NEW YORK, NY. FILED 8-23-2000.

susie moon
everyware

THE NAME "SUSIE MOON" DOES NOT IDENTIFY A LIVING INDIVIDUAL.
FOR SHOES, SLIPPERS AND FOOTWEAR (U.S. CLS. 22 AND 39).

FIRST USE 4-1-2000; IN COMMERCE 4-1-2000.

SN 76-115,363. R.I.CO. RICAMI E CONFEZIONI S.R.L., BERGAMO, ITALY, FILED 8-22-2000.

LORETTA

PRIORITY CLAIMED UNDER SEC. 44(D) ON ITALY APPLICATION NO. BG96C000139, FILED 9-2-1986, REG. NO. 477,632, DATED 8-30-1996, EXPIRES 9-30-2006.
FOR WEDDING DRESSES (U.S. CLS. 22 AND 39).
FIRST USE 0-0-1984; IN COMMERCE 0-0-1990.

SN 76-116,980. SMALLWOOD, BRUCE D., BALTIMORE, MD. FILED 8-28-2000.

GO
GOSPEL GEAR

NO CLAIM IS MADE TO THE EXCLUSIVE RIGHT TO USE "GEAR", APART FROM THE MARK AS SHOWN.

FOR CHRISTIAN CLOTHING, APPAREL AND ACCESSORIES, NAMELY, T-SHIRTS, SWEATSHIRTS, GOLF SHIRTS, TANK TOPS, VESTS, SWEATERS, JACKETS, SWEAT PANTS, SHORTS, KNIT HATS, CAPS, APRONS, BABY CLOTHES, SOCKS AND FOOTWEAR (U.S. CLS. 22 AND 39).

CLASS 25—(Continued).

SN 76-119,294. FIRST TOUCH, INC., NEW YORK, NY. FILED 8-31-2000.

FIRST TOUCH

FOR LADIES' AND GIRLS' LINGERIE (U.S. CLS. 22 AND 39).

SN 76-119,928. S&P SPORTSWEAR MFG INC., BROOKLYN, NY. FILED 8-29-2000.

EXIT 17

FOR CLOTHING AND DESIGN WEAR, NAMELY, BLOUSES, COATS, DRESSES, JACKETS, JEANS, PANTS, SPORT SHIRTS, SHORTS, SKIRTS, SLACKS, SPORT COATS, SUITS, AND CLOTHING TOPS (U.S. CLS. 22 AND 39).

FIRST USE 7-20-2000; IN COMMERCE 7-20-2000.

SN 76-121,701. W&M HEADWEAR, INC., BROOKLYN, NY. FILED 8-31-2000.

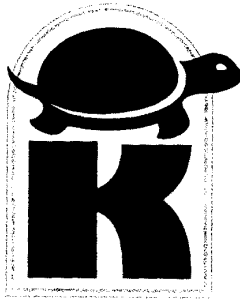

FOR HATS (U.S. CLS. 22 AND 39).
FIRST USE 7-1-2000; IN COMMERCE 7-1-2000.

SN 76-122,959. PEEBLES INC., SOUTH HILL, VA. FILED 9-6-2000.

CASUAL OPTIONS

NO CLAIM IS MADE TO THE EXCLUSIVE RIGHT TO USE "CASUAL", APART FROM THE MARK AS SHOWN.
FOR WOMEN'S CLOTHING, NAMELY KNIT TOPS, SWEATERS, WOVEN SHIRTS, PANTS, SHORTS, SKIRTS, JACKETS, SKORTS SWEATSHIRTS, SWEATPANTS, JOG SETS AND NYLON SEPARATES (U.S. CLS. 22 AND 39).

CLASS 25—(Continued).

SN 76-123,328. MADISON AVENUE MATERNITY & BABY BOUTIQUE, NEW YORK, NY. FILED 9-6-2000.



NO CLAIM IS MADE TO THE EXCLUSIVE RIGHT TO USE THE REPRESENTATION OF THE EIFFEL TOWER, APART FROM THE MARK AS SHOWN.

THE MARK CONSISTS OF A PREGNANT WOMAN WALKING A DOG WITH A DRAWING OF THE EIFFEL TOWER.

FOR MATERNITY CLOTHING, NAMELY, BLOUSES, SHIRTS, JACKETS, LEGGINGS, PANTS, DRESSES, SKIRTS, SUITS, PAJAMAS; EVENING WEAR, NAMELY, FORMAL DRESSES, GOWNS, BLOUSES, SKIRTS, SHAWLS; SHORTS, SWEATERS; AND OUTERWEAR, NAMELY, COATS, RAINCOATS (U.S. CLS. 22 AND 39).

SN 76-131,959. SECOND GENERATION GARMENT MFG., INC., LOS ANGELES, CA. FILED 9-20-2000.

MICHAEL G.

THE NAME "MICHAEL G" DOES NOT IDENTIFY A LIVING INDIVIDUAL.

FOR WOMEN'S AND CHILDREN'S CLOTHING, NAMELY, JEANS, SHORTS, CAPRIS, SKIRTS, AND KNIT TOPS (U.S. CLS. 22 AND 39).

FIRST USE 0-0-1977; IN COMMERCE 0-0-1977.

SN 76-134,373. KONCEPTUAL KARACTERS, INC., HOME-STEAD, FL. FILED 9-25-2000.

SEVEN SEAS

FOR CLOTHING, NAMELY, T-SHIRTS, SWEAT SHIRTS, DRESSES, SKIRTS, SHORTS, PANTS, JACKETS, SWIM SUITS AND HATS (U.S. CLS. 22 AND 39).

CLASS 25—(Continued).

SN 76-135,059. ROBINSON, FRANZ, BRONX, NY. AND ROBINSON, DAVENE, BRONX, NY. FILED 9-25-2000.

CHEDDAWEAR

FOR CLOTHING, NAMELY, T-SHIRTS, SWEAT-SHIRTS, DRESS SHIRTS, HENLEYS, AND POLO SHIRTS, SUITS, JOGGING SUITS, LEISURE SUITS, SWEAT SUITS AND LINEN SUITS, DRESSES, FOOTWEAR, SWEAT SOCKS, DRESS SOCKS AND COTTON SOCKS, HEADWEAR, NAMELY, BASEBALL CAPS AND KNIT WINTER HATS, DENIM CLOTHES, NAMELY, DENIM PANTS, JACKETS, HATS, SHIRTS, SHORTS, DRESSES AND JUMPERS (U.S. CLS. 22 AND 39).

SN 76-142,020. EBERLE, JIM, LEAGUE CITY, TX. BY ASSIGNMENT TEAM AUTO DETAILING, INC., HOUSTON, TX. FILED 10-5-2000.

LIVE THE OBSESSION

FOR SPORTS AND LEISURE CLOTHING, NAMELY T-SHIRTS, JACKETS AND CAPS (U.S. CLS. 22 AND 39).

SN 76-144,183. CORPORATION OF COURAGEOUS CHICS, HOUSTON, TX. FILED 10-11-2000.

COURAGEOUS CHIC

NO CLAIM IS MADE TO THE EXCLUSIVE RIGHT TO USE "CHIC", APART FROM THE MARK AS SHOWN.
FOR CLOTHING, NAMELY, CAPS AND SHIRTS (U.S. CLS. 22 AND 39).
FIRST USE 10-0-1999; IN COMMERCE 8-7-2000.

SN 76-147,016. AMERICAN UTEX INTERNATIONAL LTD., NEW YORK, NY. FILED 10-16-2000.

**MASSIMO MODA
COLLEZIONE**

NO CLAIM IS MADE TO THE EXCLUSIVE RIGHT TO USE "MODA COLLEZIONE", APART FROM THE MARK AS SHOWN.

THE ENGLISH TRANSLATION OF "MASSIMO MODA COLLEZIONE" IS "HEAVYWEIGHT FASHION COLLEZIONE".

FOR MEN'S CLOTHING, NAMELY - SUITS, COATS, OUTERWEAR, JACKETS, PANTS AND SHIRTS (U.S. CLS. 22 AND 39).

FIRST USE 5-15-1995; IN COMMERCE 8-10-1995.

CLASS 25—(Continued).

SN 76-147,022. WILK SHIRT CORPORATION, NEW YORK, NY. FILED 10-13-2000.

CFO

FOR CLOTHING, NAMELY MEN'S WOVEN DRESS SHIRTS AND SPORTS SHIRTS AND MENS LOUNGEWEAR (U.S. CLS. 22 AND 39).

SN 76-147,371. DAME DE MEXICO, S.A. DE C.V., HGO, MEXICO, FILED 10-16-2000.

FLEXNIT

OWNER OF MEXICO REG. NO. 410051, DATED 11-13-1991, EXPIRES 11-13-2011.

FOR PANTIES, BRASSIERES AND ALL KINDS OF UNDERWEAR, PANTS, SWEAT SHIRTS, SHORTS, T-SHIRTS, BEACH WEAR AND TOPS (U.S. CLS. 22 AND 39).

SN 76-148,408. SHAY, LORETTA S., VERNON, CA. FILED 10-16-2000.

XTREME SPORTS POWER

NO CLAIM IS MADE TO THE EXCLUSIVE RIGHT TO USE "EXTREME SPORTS", APART FROM THE MARK AS SHOWN.

FOR FOOTWEAR, NAMELY, SHOES, SANDALS, SLIPPERS, BOOTS (U.S. CLS. 22 AND 39).

FIRST USE 5-28-1999; IN COMMERCE 5-28-1999.

CLASS 25—(Continued).

SN 76-150,413. TWENTIETH CENTURY FOX FILM CORPORATION, LOS ANGELES, CA. FILED 10-19-2000.

FOX KIDS

OWNER OF U.S. REG. NO. 2,324,808.

NO CLAIM IS MADE TO THE EXCLUSIVE RIGHT TO USE "KIDS", APART FROM THE MARK AS SHOWN.

FOR CLOTHING AND EXERCISE WEAR, NAMELY, WARM-UP SUITS, JOGGING SUITS, SWEAT SUITS, SWEAT PANTS AND SWEATSHIRTS, BODY SUITS, LEOTARDS, TIGHTS, LEG WARMERS, LEGGINGS, ROMPERS, SINGLETS, WET SUITS, SKI SUITS, SKI PANTS, SKI BIBS, SKI JACKETS, SWIMWEAR, BATHING SUITS, BEACH AND BATHING COVERUPS, SUITS, TUXEDOS, SLACKS, TROUSERS, PANTS, JEANS, SHORTS, SWEAT SHORTS, GYM SHORTS, TOPS, COATS, SPORT COATS, SHIRTS, SPORT SHIRTS, T-SHIRTS, KNIT SHIRTS, POLO SHIRTS, PULLOVERS, SWEATERS, VESTS, TANK TOPS, BLAZERS, JUMPSUITS, PLAYSUITS, JACKETS, OVERCOATS, PARKAS, WIND RESISTANT JACKETS, LEATHER JACKETS, SKIRTS, DRESSES, FOOTWEAR, SHOES, BOOTS, ATHLETIC FOOTWEAR, BASKETBALL SHOES, CASUAL FOOTWEAR, SANDALS AND SLIPPERS, HEADWEAR, HATS, HOODS, BERETS, HEAD BANDS, CAPS, VISORS, NECKERCHIEFS, SCARVES, BANDANNAS, SLEEPWEAR, ROBES, PAJAMAS, NIGHTSHIRTS, RAINCOATS, GLOVES, MITTENS, GALOSHES AND RAIN BOOTS, LOUNGEWEAR, UNDERWEAR, BRIEFS, UNDERPANTS, BOXER SHORTS, CLOTH DIAPERS, UNDERSHIRTS, SUSPENDERS, HOSIERY, SOCKS, BELTS, HALLOWEEN AND MASQUERADE COSTUMES AND MASKS SOLD IN CONNECTION THEREWITH, APRONS (U.S. CLS. 22 AND 39).

SN 76-154,017. MID CITY BOWLING LANES & SPORTS PALACE INC., NEW ORLEANS, LA. FILED 10-26-2000.

ROCK 'N' BOWL

OWNER OF U.S. REG. NOS. 1,850,925 AND 2,438,181.
FOR CLOTHING, NAMELY, T-SHIRTS, BASEBALL CAPS AND APRONS (U.S. CLS. 22 AND 39).
FIRST USE 1-28-1983; IN COMMERCE 1-28-1983.

SN 76-155,156. DOUGLAS CREEK, LLC, LOS ANGELES, CA. FILED 10-27-2000.

BORDEAUX FASCINATION WITH COLORS

NO CLAIM IS MADE TO THE EXCLUSIVE RIGHT TO USE "COLORS", APART FROM THE MARK AS SHOWN.

FOR WOMEN'S CLOTHING, NAMELY KNITTED TOPS, SWEATERS, PANTS, JACKETS, SKIRTS, AND BLOUSES (U.S. CLS. 22 AND 39).

CLASS 25—(Continued).

SN 76-155,734. DREW PEARSON MARKETING/FRESH CAPS, ADDISON, TX. FILED 10-27-2000.

FILLABONG

FOR APPAREL, NAMELY SHIRTS, SHORTS, PANTS, PAJAMAS, SOCKS, SHOES, SWIMWEAR, SLEEPWEAR, LOUNGEWARE, UNDERGARMENTS (U.S. CLS. 22 AND 39).

SN 76-156,932. M. HADDAD SPORTSWEAR INC., MONTREAL, QUEBEC H2N 2E7, CANADA, FILED 10-31-2000.

COVER ME

FOR LADIES SHIRTS, PANTS, BLOUSES, SWEATERS, NIGHTGOWNS, PYJAMAS AND COATS (U.S. CLS. 22 AND 39).

FIRST USE 5-1-1999; IN COMMERCE 5-1-1999.

SN 76-157,310. SCIALDONE, MARK, SAN DIEGO, CA. FILED 11-1-2000.

BONG

FOR CLOTHING, NAMELY, T-SHIRTS, HATS, SHOES, SOCKS, BEANIES, JACKETS, SHORTS (U.S. CLS. 22 AND 39).

SN 76-158,822. D & E PRODUCTIONS, VIRGINIA BEACH, VA. FILED 11-3-2000.



FOR HOSIERY, PERSONALIZED HOSIERY, AND CUSTOM DESIGNED HOSIERY; CLOTHING; NAMELY, SHIRTS, T-SHIRTS, POLO SHIRTS, SPORT SHIRTS, SWEAT SHIRTS, SWEAT PANTS, WARM UP SUITS, DRESSES, SKIRTS, BLOUSES, SWEATERS, PANTS, SHORTS, COATS, JACKETS, SKIRTS, RAINCOATS, HATS, VISORS, BELTS, SHOES, TIES, SCARVES, GLOVES, STOCKINGS, SOCKS, UNDERWEAR, BRAS, BOXER SHORTS, BRIEFS, PANTIES, SLEEPWEAR, AND SWIMWEAR (U.S. CLS. 22 AND 39).

FIRST USE 4-1-2000; IN COMMERCE 4-1-2000.

CLASS 25—(Continued).

SN 76-169,172. DOUGLAS CREEK, LLC, LOS ANGELES, CA.
FILED 11-21-2000.

KNIT TOPIC

NO CLAIM IS MADE TO THE EXCLUSIVE RIGHT TO USE "KNIT", APART FROM THE MARK AS SHOWN.

FOR WOMEN'S CLOTHING, NAMELY, BLOUSES, SWEATER, AND T-SHIRTS (U.S. CLS. 22 AND 39).

SN 76-169,593. TMW MARKETING COMPANY, INC., FREMONT, CA. FILED 11-21-2000.



OWNER OF U.S. REG. NO. 2,036,058.
NO CLAIM IS MADE TO THE EXCLUSIVE RIGHT TO USE "LINEA UOMO", APART FROM THE MARK AS SHOWN.

THE ENGLISH TRANSLATION OF THE WORD "LINEA UOMO" IN THE MARK IS "MEN'S LINE".

FOR MEN'S AND WOMEN'S CLOTHING, NAMELY, ANKLET SOCKS, PARKAS, BELTS, BLAZERS, BOXER SHORTS, CARDIGANS, COATS, LEATHER COATS, OVERCOATS, RAIN COATS, SPORTS COATS, SUIT COATS, TOP COATS, CUMMERBUNDS, FOOTWEAR, GOLF SHIRTS, HOSIERY, LEATHER JACKETS, WIND RESISTANT JACKETS, JEANS, KNIT SHIRTS, MUFFLERS, NECKTIES, NECKWEAR, POLO SHIRTS, RAIN COATS, RAIN WEAR, SHIRTS, GOLF SHIRTS, KNIT SHIRTS, SPORT SHIRTS, SHOES, SHORTS, SLACKS, SOCKS, SUIT COATS, SUITS, VESTED SUITS, SUSPENDERS, TURTLENECK SWEATERS, V-NECK SWEATERS, BOW TIES, CLOTHING TIES (U.S. CLS. 22 AND 39).

SN 76-172,481. BONE DADDY'S, INC., DALLAS, TX. FILED 11-28-2000.

BONE DADDY'S HOUSE OF SMOKE

FOR CLOTHING, NAMELY, T-SHIRTS, HATS AND APPARELS ADVERTISING APPLICANT'S RESTAURANT AND CATERING FOOD SERVICES (U.S. CLS. 22 AND 39).

FIRST USE 1-1-2000; IN COMMERCE 1-1-2000.

CLASS 25—(Continued).

SN 76-173,654. LA SENZA INC., MISSISSAUGA, ONTARIO, CANADA, FILED 11-30-2000.

LA SENZA BODYWEAR

OWNER OF CANADA REG. NO. 482,165, DATED 9-8-1997, EXPIRES 9-8-2012.

OWNER OF U.S. REG. NOS. 1,800,379 AND 1,994,349.
NO CLAIM IS MADE TO THE EXCLUSIVE RIGHT TO USE "BODYWEAR", APART FROM THE MARK AS SHOWN.

THE WORD "LA" MAY BE TRANSLATED FROM FRENCH OR ITALIAN TO MEAN "THE", AND THE ITALIAN WORD "SENZA" MAY BE TRANSLATED INTO ENGLISH TO MEAN "WITHOUT".

FOR LADIES' WEARING APPAREL, NAMELY CROP TOPS, CAMISOLES, T-SHIRTS, BOXER SHORTS, BIKER SHORTS, LEGGINGS, PANTIES, BRASSIERES, SLEEP SHIRTS AND LOUNGE WEAR CONSISTING OF TOPS AND PANTS (U.S. CLS. 22 AND 39).

SN 76-182,122. S.P. DIFFUSION, F-75008 PARIS, FRANCE, FILED 12-15-2000.



NO CLAIM IS MADE TO THE EXCLUSIVE RIGHT TO USE "PARIS", APART FROM THE MARK AS SHOWN.

FOR CLOTHING, NAMELY, JACKETS, SUITS, TROUSERS, SPORTSWEAR, TROUSERS, SHIRTS, PULL-OVERS, COATS, RAINCOATS, PARKAS, TIES, BELTS, FOOTWEAR AND HEADWEAR (U.S. CLS. 22 AND 39).
FIRST USE 2-1-2000; IN COMMERCE 2-1-2000.

SN 76-184,540. ATLAS TRADING ASSOCIATES, INC., CEDAR GROVE, NJ. FILED 12-20-2000.

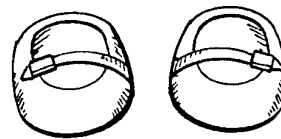

OWNER OF U.S. REG. NO. 2,138,228.
FOR SHOES AND SLIPPERS (U.S. CLS. 22 AND 39).
FIRST USE 6-1-2000; IN COMMERCE 6-1-2000.

CLASS 25—(Continued).

SN 76-188,581. MORTGAGERAMP.COM INC., HORSHAM, PA. FILED 1-2-2001.



FOR CLOTHING, NAMELY, SHIRTS (U.S. CLS. 22 AND 39).

SN 76-191,534. MONROY, ALFREDO, POMONA, CA. FILED 1-9-2001.

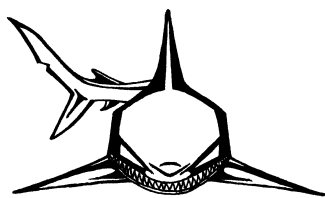

SHARK GEAR

NO CLAIM IS MADE TO THE EXCLUSIVE RIGHT TO USE "GEAR", APART FROM THE MARK AS SHOWN.

THE MARK CONSISTS OF A STYLIZED DEPICTION OF A SHARK FACING IN A FORWARD MOTION, IT HAS AN AERO DYNAMIC LOOK WITH SHARP FINS AND SMALL SHARP TEETH, WITH A POINTED NOSE AND MEAN LOOKING EYES; INCLUDED ARE THE WORDS "SHARK GEAR".

FOR SPORTS GEAR AND APPAREL, NAMELY, SHIRTS, HATS, PANTS, JACKETS, SWEAT PANTS, SHORTS, SOCKS, SHOES, JERSEYS, HEAD BANDS AND WRIST BANDS (U.S. CLS. 22 AND 39).

SN 76-199,444. WEST MARINE IHC I, INC., WATSONVILLE, CA. FILED 1-25-2001.

ORCAS ISLAND

FOR CLOTHING, NAMELY, FLEECE JACKETS AND VESTS (U.S. CLS. 22 AND 39).
FIRST USE 2-0-1991; IN COMMERCE 2-0-1991.

SN 76-203,161. HITCOCK, NANETTE B., DBA MOMS AT PLAY, PANAMA CITY, FL. FILED 2-1-2001.



FOR CLOTHING NAMELY, HATS AND SHIRTS (U.S. CLS. 22 AND 39).
FIRST USE 4-1-1999; IN COMMERCE 4-1-1999.

CLASS 25—(Continued).

SN 76-203,898. NATIONAL PARK FOUNDATION, WASHINGTON, DC. FILED 2-2-2001.

EXPERIENCE YOUR AMERICA

NO CLAIM IS MADE TO THE EXCLUSIVE RIGHT TO USE "AMERICA", APART FROM THE MARK AS SHOWN.
FOR CLOTHING, NAMELY, HATS, CAPS, T-SHIRTS, SWEATSHIRTS AND SHORTS (U.S. CLS. 22 AND 39).

SN 76-205,160. MARS, INCORPORATED, MCLEAN, VA. FILED 2-5-2001.

YOU DON'T EAT YOUR OWN KIND, IT'S UNNATURAL

FOR CLOTHING, NAMELY, T-SHIRTS AND TANK TOPS (U.S. CLS. 22 AND 39).

SN 76-206,351. ZILBERBERG, SIMON, NEW YORK, NY. FILED 2-7-2001.

KNIT MAVEN

NO CLAIM IS MADE TO THE EXCLUSIVE RIGHT TO USE "KNIT", APART FROM THE MARK AS SHOWN.
FOR SWEATERS, SWEATER DRESSES AND SWEATER COATS (U.S. CLS. 22 AND 39).
FIRST USE 7-1-1980; IN COMMERCE 7-1-1980.

SN 76-216,886. MANUFACTURAS SAN ISIDRO S.A., LIMA 01, PERU, FILED 2-21-2001.

GZUCK

OWNER OF PERU REG. NO. 036264, DATED 5-6-1997, EXPIRES 5-6-2007.
FOR DRESSES, SHOES AND HATS (U.S. CLS. 22 AND 39).

CLASS 25—(Continued).

SN 76-217,539. VAHIDI, HOUMAN, LOS ANGELES, CA.
FILED 3-1-2001.

DUNHURST

FOR CLOTHING FOR MEN, WOMEN, AND CHILDREN; NAMELY, COATS, RAINCOATS, JEANS, BELTS, WAISTCOATS, BLOUSES, PULLOVERS, JACKETS, SHORTS, PANTS, TROUSERS, SKIRTS, DRESSES, GOWNS, SUITS, SHIRTS AND CHEMISES, VESTS, KNIT PANTS AND KNIT SHIRTS, SKI PANTS, T-SHIRTS, TANK TOPS, SWEATERS, UNDERWEAR, GARTERS, SOCKS AND STOCKINGS, HOSIERY, BATHING SUITS, GLOVES, TIES, SCARVES, HATS AND CAPS, BOOTS, SHOES, SANDALS, SLIPPERS, AND BATH ROBES (U.S. CLS. 22 AND 39).

SN 76-223,600. PAPETTI, JOHN F. JR., ELIZABETH, NJ.
FILED 3-13-2001.



NO CLAIM IS MADE TO THE EXCLUSIVE RIGHT TO USE "BEACH PRINTS", APART FROM THE MARK AS SHOWN.

FOR BEACH DESIGN SANDALS (U.S. CLS. 22 AND 39).

SN 76-226,533. LAUDED INDUSTRIES, INC., HUNTINGTON BEACH, CA. FILED 3-19-2001.

FUNCTIONAL WEARABLE SOLUTIONS

NO CLAIM IS MADE TO THE EXCLUSIVE RIGHT TO USE "FUNCTIONAL WEARABLE", APART FROM THE MARK AS SHOWN.

FOR CLOTHING, NAMELY, SHIRTS, SHORTS, PANTS, JACKETS, SWEATERS, SWEATSHIRTS, AND HATS (U.S. CLS. 22 AND 39).

CLASS 25—(Continued).

SN 76-226,849. PERRY, DAVID A., SHARON HILL, PA.
FILED 3-19-2001.



CREWLOVE

FOR SHIRTS, PANTS, SOCKS, SHOES AND HATS (U.S. CLS. 22 AND 39).

SN 76-228,419. AMERICAN ZHAOLIN INTERNATIONAL GROUP, ARCADIA, CA. FILED 3-22-2001.

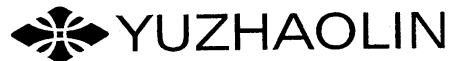

FOR CLOTHING, NAMELY, GIRDLES, NIGHT GOWNS, ALOHA SHIRTS, NEGLIGEEES, DRESSING GOWNS, BATH ROBES, BODICES, BODY SHIRTS, BLOUSES, UNDERWEAR, UNDERSHIRTS, UNDERPANTS, SWIM SUITS, SWEATERS, SWEAT SHIRTS, SWEAT PANTS, SPORT SHIRTS, SLIPS, DRESS SHIRTS, ATHLETIC UNIFORMS, TANK-TOPS, PAJAMAS, POLO SHIRTS, PULLOVERS, T-SHIRTS, WATERPROOF CLOTHES, NAMELY DIVING SUITS AND FISHING WADERS; SCHOOL UNIFORMS, RAIN COATS, LONG COATS, HALF COATS, SKIRTS, SLACKS, GENTLEMEN'S SUITS, TROUSERS, DRESS COATS, OVERALLS, OVERCOATS, ONE-PIECE DRESSES, INFANT WEAR, NAMELY CLOTH DIAPERS, PAJAMAS, SHIRTS, PANTS, SHOES, HATS; EVENING DRESSES, JACKETS, JUMPERS, JEANS, CAPES, TOP COATS, TUXEDOS, FENCING UNIFORMS, WET SUITS FOR WATER-SKIING, SPORTING ANORAKS, FOOTWEAR, NAMELY, LEATHER SHOES, RUBBER SHOES, GOLF SHOES, INNER SOLES, BASKETBALL SHOES, LOW SHOES, HEELS, HIKING SHOES, RUGBY SHOES, LACE BOOTS, VINYL SHOES, BEACH SHOES, SANDALS, SKI BOOTS, SLIPPERS, INNER SOLES FOR FOOTWEAR, SOLES FOR FOOTWEAR, FOOTWEAR UPPERS, HEEL INSERTS FOR SHOES AND BOOTS, NON-SLIPPING DEVICES FOR SHOES AND BOOTS, TIPS FOR FOOTWEAR, BASEBALL SHOES, ESPARTO SHOES AND SANDALS, OVERSHOES, RAIN SHOES, TRACK-RACING SHOES, WORK SHOES, BOOTS, STRAW SHOES, GYMNASIIC SHOES, FOOTBALL BOOTS, LACED BOOTS, HOCKEY SHOES, HAND BALL SHOES; HEADWEAR, NAMELY NIGHTCAPS, HATS AND CAPS, BERETS, HOODS, TOP HATS; NECKTIES, SWEAT ABSORBING STOCKINGS, LEGWARMERS, LEGGINGS, MUFFS, MUFFLERS, BANDANAS, EAR MUFFS, GLOVES, MITTENS, VEILS, SHAWLS, SHOULDER WRAPS, SCARVES, STOCKINGS, SOCKS, APRONS, STOCKINGS FOR SPORTS, AND TIGHTS (U.S. CLS. 22 AND 39).

FIRST USE 3-3-2001; IN COMMERCE 3-3-2001.

CLASS 25—(Continued).

SN 76-229,670. WASHINGTON SHOE COMPANY, RENTON, WA. FILED 3-23-2001.

STAHEEKUM

FOR BOOTS, SHOES, MOCCASINS AND SLIPPERS (U.S. CLS. 22 AND 39).

SN 76-229,855. DICKIE WALKER MARINE, INC., LA JOLLA, CA. FILED 3-26-2001.



NO CLAIM IS MADE TO THE EXCLUSIVE RIGHT TO USE "BUILT 1951" AND "AUTHENTIC MARINE", APART FROM THE MARK AS SHOWN.

THE STIPLING IN THE MARK IS FOR SHADING PURPOSES ONLY.

THE NAME "DICKIE WALKER" IS THE NAME OF A BOAT AND NOT THE NAME OF ANY KNOWN OR PARTICULAR LIVING INDIVIDUAL.

FOR CLOTHING FOR MEN, WOMEN AND CHILDREN, NAMELY, WARM-UP SUITS, SWEATSUITS, SWEATPANTS AND SWEATSHIRTS, SWIM SUITS, WET SUITS, FOUL WEATHER GEAR, SLACKS, TROUSERS, PANTS, JEANS, SHORTS, JACKETS, COATS, SPORT COATS, SHIRTS, SPORT SHIRTS, T-SHIRTS, KNIT SHIRTS, POLO SHIRTS, PULLOVERS, SWEATERS, VESTS, TANK TOPS, BLAZERS, COVER-ALLS, OVERALLS, ANORAKS, OVERCOATS, PARKAS, WIND-RESISTANT JACKETS, LEATHER JACKETS, DRESSES, SKIRTS, BLOUSES, HATS, CAPS, VISORS, HOODS, HEADBANDS, SCARVES, BANDANNAS; ROBES, PAJAMAS, NIGHTSHIRTS, NIGHTGOWNS, RAIN COATS, PONCHOS, UNDERWEAR, LINGERIE, BRIEFS, BOXER SHORTS, UNDERSHIRTS, GLOVES, BELTS, SOCKS, SHOES, DECK SHOES, WET-SHOES AND BOOTS (U.S. CLS. 22 AND 39).

SN 76-237,892. EARBAGS AB, BJORKLINGE, SWEDEN, FILED 4-9-2001.

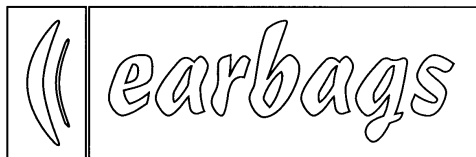

THE WORD "EARBAGS" AND THE LARGER ELLIPSE ARE YELLOW, AND THE BACKGROUND IS BLUE. FOR EAR HELD EARMUFFS (U.S. CLS. 22 AND 39).

CLASS 25—(Continued).

SN 76-247,381. PARAMOUNT PARKS INC., CHARLOTTE, NC. FILED 4-26-2001.

TERRORFEST

FOR T-SHIRTS, SWEATSHIRTS, HATS, JACKETS, PAJAMAS, MASQUERADE COSTUMES, TANK TOPS, FOOTWEAR, SWEATPANTS, SHORTS (U.S. CLS. 22 AND 39).

SN 76-257,204. AUCTIV, REDONDO BEACH, CA. FILED 5-14-2001.

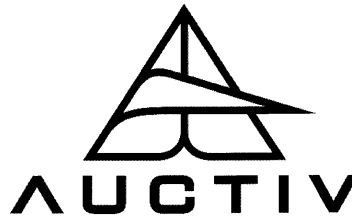

FOR CLOTHING, NAMELY T-SHIRTS, SHIRTS, SWEAT SHIRTS, SHORTS, PANTS, DRESSES, SKIRTS, BELTS, SOCKS, JACKETS, SWEATERS, HATS AND VISORS (U.S. CLS. 22 AND 39).

SN 76-265,619. IN THE WIND, INC., HENDERSON, NV. FILED 5-30-2001.

STAZ'S AMERICAN MOTORCYCLES

NO CLAIM IS MADE TO THE EXCLUSIVE RIGHT TO USE "AMERICAN", APART FROM THE MARK AS SHOWN.

FOR WEARING APPAREL, NAMELY T-SHIRTS, GOLF SHIRTS, TANK TOPS, JACKETS, SWEATERS, SEAT PANTS, SWEAT SHIRTS, JOGGING SUITS, PANTS, SHIRTS, VESTS, SKIRTS, SWIM WEAR, SOCKS, DRESSES, LOUNGE WEAR, BLOUSES, JEANS AND LEATHER GOODS, NAMELY, BELTS AND BUCKLES SOLD AS A UNIT, JACKET, BLAZERS, BOOTS, SHOES, GLOVES, COATS, PANTS AND VESTS (U.S. CLS. 22 AND 39).

CLASS 25—(Continued).

SN 76-269,989. ALL SURFACE ENTERTAINMENT, INC., NEW YORK, NY. FILED 6-12-2001.



NO CLAIM IS MADE TO THE EXCLUSIVE RIGHT TO USE "NYC", APART FROM THE MARK AS SHOWN. FOR MEN'S AND WOMEN'S CLOTHING NAMELY, T-SHIRTS, SWEATSHIRTS, HATS, HEADWEAR, JACKETS, JEANS AND PANTS (U.S. CLS. 22 AND 39). FIRST USE 5-11-1998; IN COMMERCE 4-5-1999.

SN 76-270,564. CANDIE'S INC., VALHALLA, NY. FILED 6-13-2001.

CANDIE'SCURVES

OWNER OF U.S. REG. NOS. 1,154,885, 1,206,758 AND OTHERS. FOR CLOTHING, NAMELY, LINGERIE, UNDERWEAR, SLEEPWEAR, AND ROBES (U.S. CLS. 22 AND 39).

SN 76-270,565. CANDIE'S INC., VALHALLA, NY. FILED 6-13-2001.

CANDIE'SDREAMS

OWNER OF U.S. REG. NOS. 1,154,885, 1,206,758 AND OTHERS. FOR CLOTHING, NAMELY, LINGERIE, UNDERWEAR, SLEEPWEAR, AND ROBES (U.S. CLS. 22 AND 39).

CLASS 25—(Continued).

SN 76-275,728. JANAS, EVA, DELRAY BEACH, FL. AND KUCZYNSKA, IWONA, DELRAY BEACH, FL. FILED 6-25-2001.

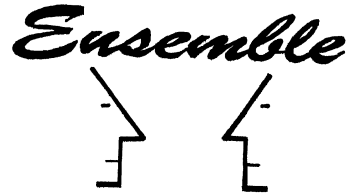

NO CLAIM IS MADE TO THE EXCLUSIVE RIGHT TO USE "ENSEMBLE", APART FROM THE MARK AS SHOWN. FOR CLOTHING, NAMELY, T-SHIRTS, POLO SHIRTS, BUTTON-DOWN SHIRTS, BLOUSES, HATS, SHORTS, PANTS AND SOCKS (U.S. CLS. 22 AND 39).

SN 76-275,846. FITNESS DE FABRI, INC., LAS VEGAS, NV. FILED 6-25-2001.

FDF

FOR EXERCISE, FITNESS, AND PHYSICAL TRAINING APPAREL, NAMELY, SHORTS, TOPS, SHIRTS, VESTS, JACKETS, PANTS, WARM-UP SUITS, AND SWEATSUITS (U.S. CLS. 22 AND 39).

SN 76-276,943. J. C. PENNEY PRIVATE BRANDS, INC., PIANO, TX. FILED 6-25-2001.



FOR MEN'S, WOMEN'S, AND CHILDREN'S APPAREL, NAMELY, SHIRTS, PANTS, SWEATERS, SUITS, SPORT JACKETS, SUSPENDERS, TIES, SKIRTS, AND SKORTS (U.S. CLS. 22 AND 39).

SN 76-279,622. FASHION CORPORATION OF AMERICA, WINSTON-SALEM, NC. FILED 7-3-2001.

BUFFLES FOR BABIES

NO CLAIM IS MADE TO THE EXCLUSIVE RIGHT TO USE "FOR BABIES", APART FROM THE MARK AS SHOWN.

FOR CLOTHING FOR INFANTS, TODDLERS, AND CHILDREN, NAMELY, BABY BUNTINGS, CLOTH BIBS, BONNETS, TOPS, BOTTOMS, JUMPERS, ROMPERS, PLAY SUITS, SLEEPERS, AND SOCKS (U.S. CLS. 22 AND 39).

CLASS 25—(Continued).

SN 76-280,968. CHN, LLC, LOS ANGELES, CA. FILED 7-5-2001.

B.S.L INDUSTRY

NO CLAIM IS MADE TO THE EXCLUSIVE RIGHT TO USE "INDUSTRY", APART FROM THE MARK AS SHOWN. FOR CLOTHING, NAMELY PANTS, JACKETS, SKIRTS AND DRESSES AND SHIRTS (U.S. CLS. 22 AND 39).

FIRST USE 6-28-2001; IN COMMERCE 6-28-2001.

CLASS 25—(Continued).

SN 76-287,137. CLUBCORP, INC., DALLAS, TX. FILED 7-19-2001.

CLUBCORP

FOR MEN'S, WOMEN'S AND CHILDREN'S CLOTHING, NAMELY, SKIRTS, SLACKS, SHORTS, SHIRTS, SWEATERS, JACKETS, HATS, VISORS, SOCKS AND NECKTIES (U.S. CLS. 22 AND 39).

FIRST USE 1-30-1997; IN COMMERCE 1-30-1997.

SN 76-283,331. NEW ORLEANS JAZZ & HERITAGE FOUNDATION, INC., NEW ORLEANS, LA. FILED 7-11-2001.



OWNER OF U.S. REG. NO. 2,424,393. FOR CLOTHING, NAMELY T-SHIRTS, SHIRTS, SHORTS, PANTS, HATS AND CAPS (U.S. CLS. 22 AND 39).

FIRST USE 1-1-1970; IN COMMERCE 1-17-1978.

SN 76-297,437. FORTE CASHMERE COMPANY, INC., WOONSOCKET, RI. FILED 8-9-2001.

FORTE

SEC. 2(F). FOR PANTS, HEADWEAR, SWEATERS, SHIRTS, TOPS, SLACKS, AND NONLEATHER ACCESSORIES, NAMELY, HATS (U.S. CLS. 22 AND 39).

FIRST USE 7-30-1995; IN COMMERCE 7-30-1995.

SN 76-306,007. WANLIMA INTERNATIONAL CORP., SUNNYVALE, CA. FILED 8-27-2001.

**WANLIMA**

SN 76-285,407. BECAUSE JAIL SUCKS, INC., KETCHUM, ID. FILED 7-16-2001.

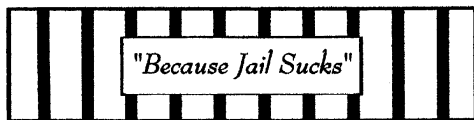

FOR CLOTHING, NAMELY, T-SHIRTS, SHIRTS, JACKETS, SWEATSHIRTS, PANTS, UNDERWEAR, SOCKS, BELTS AND HATS (U.S. CLS. 22 AND 39).

FIRST USE 6-1-1998; IN COMMERCE 6-1-1998.

FOR CLOTHING, NAMELY, SHOES, BELT, HAT, CAP, SOCKS, GLOVES, TIE, LEATHER CLOTHING, NAMELY, PANTS; SHIRT, PANTS, TROUSERS, SINGLET, UNDERWEAR, BRA, SPORTSWEAR, NAMELY, ATHLETIC PANTS; BABY CLOTHING NAMELY, PANTS; SWIMMING SUIT, JEANS, RAINCOAT, FOOTBALL SHOES, SANDALS AND SPORTS SHOES (U.S. CLS. 22 AND 39).

CLASS 25—(Continued).

SN 76-306,068. HONG, YONG HWA, FULLERTON, CA. FILED 8-27-2001.

MASTAZ

FOR CLOTHING, NAMELY, MEN'S; WOMEN'S AND CHILDREN'S; PANTS, SHIRTS, SHORTS, CAPS, VISORS, SKIRTS, JACKETS, T-SHIRTS, BELTS, HATS, JERSEYS, TOPS, SOCKS, ANKLETS, BANDANNAS, GLOVES, GOWNS, HALTER TOPS, HEAD BANDS, WRIST BANDS, SWIMWEAR, BATHING CAPS, BATHING TRUNKS, BATHROBES, BEACH COVER-UPS, BEACHWEAR, BLOUSES, BODY SUITS, TANK TOPS, TIES, BRAS, UNDERWEAR, COVERALLS, COVER-UPS, DRESSES, VESTS, INFANTWEAR, JEANS, JUMPERS, KILTS, KERCHIEFS, COATS, SWEATERS, LEGGINGS, LEOTARDS, LINGERIE, MINISKIRTS, MITTENS, PAJAMAS, PANTIES, PANTYHOSE, PONCHOS, PULLOVERS, RAINWEAR, ROBES, SHOES, BOOTS, SANDALS, AND ROMPERS (U.S. CLS. 22 AND 39).

SN 76-306,189. BRIMSTONE VENTURES, LLC, SOUTH-BURY, CT. FILED 8-28-2001.

PAUL LEBEAR

THE NAME "PAUL LEBEAR" DOES NOT IDENTIFY A LIVING INDIVIDUAL.
FOR T-SHIRTS (U.S. CLS. 22 AND 39).
FIRST USE 4-9-2001; IN COMMERCE 4-9-2001.

SN 76-306,191. BRIMSTONE VENTURES, LLC, SOUTH-BURY, CT. FILED 8-28-2001.

FAL-KAHN

THE NAME "FAL-KAHN" DOES NOT IDENTIFY A LIVING INDIVIDUAL.
FOR T-SHIRTS (U.S. CLS. 22 AND 39).
FIRST USE 4-24-2001; IN COMMERCE 4-24-2001.

SN 76-306,192. BRIMSTONE VENTURES, LLC, SOUTH-BURY, CT. FILED 8-28-2001.

BILL LUGA

THE NAME "BILL LUGA" DOES NOT IDENTIFY A LIVING INDIVIDUAL.
FOR T-SHIRTS (U.S. CLS. 22 AND 39).
FIRST USE 4-28-2001; IN COMMERCE 4-28-2001.

CLASS 25—(Continued).

SN 76-306,193. BRIMSTONE VENTURES, LLC, SOUTH-BURY, CT. FILED 8-28-2001.

KARA BOO

THE NAME "KARA BOO" IDENTIFIES A LIVING INDIVIDUAL WHOSE CONSENT IS OF RECORD.
FOR T-SHIRTS (U.S. CLS. 22 AND 39).
FIRST USE 5-7-2001; IN COMMERCE 5-7-2001.

SN 76-306,704. ADLER, SCOTT, ROCKAWAY, NJ. FILED 8-29-2001.



FOR SHIRTS, HATS, SHORTS, PANTS, SWEATERS, HEADBANDS (U.S. CLS. 22 AND 39).

SN 76-309,130. BALLIN INC., MONTREAL, QUEBEC, CANADA, FILED 9-5-2001.

MR. LEGGS

OWNER OF CANADA REG. NO. TMA338531, DATED 3-25-1988, EXPIRES 3-25-2003.
FOR MEN'S AND BOY'S TROUSERS, SLACKS AND SHORTS (U.S. CLS. 22 AND 39).

SN 76-317,849. FRYE, NANCY C., GARLAND, TX. FILED 9-20-2001.

CODA

FOR SHOES AND SHOE SOLES (U.S. CLS. 22 AND 39).

SN 76-319,971. GRUNER + JAHR PRINTING & PUBLISHING CO., NEW YORK, NY. FILED 10-1-2001.

YM

OWNER OF U.S. REG. NOS. 2,343,150, 2,471,446 AND OTHERS.
FOR KERCHIEFS (U.S. CLS. 22 AND 39).
FIRST USE 1-0-2001; IN COMMERCE 1-0-2001.

CLASS 25—(Continued).

SN 76-320,873. 1452845 ONTARIO INC., COOKSTOWN ONTARIO, CANADA, FILED 10-3-2001.

THERMAL CORE DESIGN

NO CLAIM IS MADE TO THE EXCLUSIVE RIGHT TO USE "DESIGN", APART FROM THE MARK AS SHOWN.
FOR CLOTHING AND SPORTS CLOTHING, NAMELY T-SHIRTS, HATS, SWEATSHIRTS, JACKETS, COATS, PANTS, SNOWSUITS, SNOWMOBILE SUITS, SKISUITS, SOCKS, GLOVES, MITTENS, MOTORCYCLE JACKETS AND SUITS, ATV JACKETS, ATV SUITS AND BOOTS (U.S. CLS. 22 AND 39).

SN 76-322,601. PHAT FASHIONS LLC, NEW YORK, NY. FILED 10-4-2001.



OWNER OF U.S. REG. NOS. 2,485,552 AND 2,487,976.
FOR CLOTHING, NAMELY, JERSEYS, UNIFORMS, ATHLETIC UNIFORMS, PANTS, CYCLE PANTS, TROUSERS, SLACKS, JEANS, DENIM JEANS, OVERALLS, COVERALLS, JUMPERS, JUMP SUITS, SHORTS, BOXER SHORTS, SHIRTS, T-SHIRTS, UNDER SHIRTS, NIGHT SHIRTS, RUGBY SHIRTS, POLO SHIRTS, TOPS, CROP TOPS, TANK TOPS, HALTER TOPS, SWEAT SHIRTS, SWEAT SHORTS, SWEAT PANTS, WARM-UP SUITS, JOGGING SUITS, BLOUSES, SKIRTS, DRESSES, SWEATERS, VESTS, FLEECE VESTS, PULLOVERS, FLEECE PULLOVERS, SNOW SUITS, PARKAS, ANORAKS, PONCHOS, JACKETS, DINNER JACKETS, SPORTS JACKETS, GOLF AND SKI JACKETS, REVERSIBLE JACKETS, COATS, BLAZERS, SUITS, TURTLENECKS, SWIMWEAR, BEACHWEAR, CAPS, BERETS, HATS, HEADBANDS, WRIST BANDS, HEADWEAR, EAR MUFFS, APRONS, SCARVES, BANDANAS, BELTS, SUSPENDERS, NECKWEAR, NECKTIES, TIES, BOW TIES, CLOTH BIBS, CLOTH DIAPERS, BOOTIES, INFANTWEAR, UNDERWEAR, BRIEFS, TRUNKS, BRAS, SPORTS BRAS, SINGLET, SOCKS, LOUNGEWEAR, ROBES, BATHROBES, PAJAMAS, SLEEPWEAR, NIGHT GOWNS, LINGERIE, CAMISOLES, SLIPS, STOCKINGS, BODY STOCKINGS, PANTYHOSE, HOSIERY, KNIT HOSIERY, LEG WARMERS, BODYSUITS, LEGGINGS, TIGHTS, LEOTARDS, UNITARDS, GLOVES, MITTENS, FOOTWEAR, SHOES, SNEAKERS, BOOTS, GALOSHES, SANDALS, ZORI, SLIPPERS AND RAINWEAR (U.S. CLS. 22 AND 39).

CLASS 25—(Continued).

SN 76-322,788. WELLS LAMONT CORPORATION, NILES, IL. FILED 10-9-2001.



OWNER OF U.S. REG. NOS. 539,574, 556,154 AND OTHERS.

NO CLAIM IS MADE TO THE EXCLUSIVE RIGHT TO USE "LEATHER PALM GLOVES", APART FROM THE MARK AS SHOWN.
THE LINING IN THE DRAWING IS FOR SHADING PURPOSES ONLY AND DOES NOT INDICATE COLOR.
FOR GLOVES (U.S. CLS. 22 AND 39).

SN 76-325,328. LUCKY BRAND DUNGAREES, INC., VERNON, CA. FILED 10-15-2001.

LUCKY KING

FOR CLOTHING, NAMELY, SKIRTS, SHIRTS, BLOUSES, PANTS, JACKETS, VESTS, SWEATERS, DRESSES, JUMPSUITS, SHORTS, JEANS, JERSEYS, CULOTTES, SCARVES, TUNICS, BLAZERS, NECKWEAR, BELTS, COATS, HATS, CAPS, HOODS, GLOVES; PANTYHOSE, DRESS HOSIERY, SPORT HOSIERY, SOCKS; UNDERWEAR; INTIMATE APPAREL, NAMELY, BRASSIERES, PANTIES, CAMISOLES, TEDDIES AND SLIPS; BODYWEAR, NAMELY, LEOTARDS AND TIGHTS; NECKWEAR, NAMELY, MUFFLERS, BOW TIES, COLLARS AND DICKIES; SHOES, SANDALS, SLIPPERS, BOOTS AND SNEAKERS; RAINWEAR; SWIMSUITS AND COVERUPS, BIKINI TOPS AND BOTTOMS; SLEEPWEAR, NAMELY, NIGHTGOWNS, PAJAMAS, SLEEPSHIRTS, ROBES AND BEDJACKETS (U.S. CLS. 22 AND 39).

SN 76-326,053. BALLIN, INC., VILLE SAINT-LAURENT, H4S 1R8, QUEBEC, CANADA, FILED 10-15-2001.

NORTHERN COMFORT

NO CLAIM IS MADE TO THE EXCLUSIVE RIGHT TO USE "COMFORT", APART FROM THE MARK AS SHOWN.
FOR PANTS AND SHORTS (U.S. CLS. 22 AND 39).
FIRST USE 3-31-1998; IN COMMERCE 3-31-1998.

CLASS 25—(Continued).

SN 76-327,374. BOOT ROYALTY COMPANY, L.P., FORT WORTH, TX. FILED 10-19-2001.

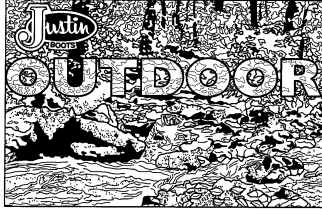

OWNER OF U.S. REG. NOS. 1,101,091, 2,352,600 AND OTHERS.

NO CLAIM IS MADE TO THE EXCLUSIVE RIGHT TO USE "BOOTS" AND "OUTDOOR", APART FROM THE MARK AS SHOWN.

THE STIPPLING SHOWN IN THE DRAWING IS A FEATURE OF THE MARK INDICATING SHADING AND NOT COLOR.

FOR FOOTWEAR, NAMELY, BOOTS (U.S. CLS. 22 AND 39).

SN 76-327,675. HELMAN GROUP, LTD., OXNARD, CA. FILED 10-18-2001.

POGOMON

FOR T-SHIRTS, SWEATSHIRTS, HATS, CAPS (U.S. CLS. 22 AND 39).

SN 76-328,033. NBDL ENTERPRISES, LLC, SECAUCUS, NJ. FILED 10-22-2001.



NO CLAIM IS MADE TO THE EXCLUSIVE RIGHT TO USE "GREENVILLE", APART FROM THE MARK AS SHOWN.

FOR CLOTHING, NAMELY HOSIERY, FOOTWEAR, BASKETBALL SHOES, BASKETBALL SNEAKERS, T-SHIRTS, SHIRTS, SWEATSHIRTS, SWEATPANTS, PANTS, TANK TOPS, JERSEYS, SHORTS, PAJAMAS, SPORT SHIRTS, RUGBY SHIRTS, SWEATERS, BELTS, TIES, NIGHTSHIRTS, HATS, WARM-UP SUITS, WARM-UP PANTS, WARM-UP TOPS, JACKETS, PARKAS, COATS, CLOTH BIBS, HEAD BANDS, WRIST BANDS, APRONS, BOXER SHORTS, SLACKS, CAPS, EAR MUFFS, GLOVES, MITTENS, WOVEN AND KNIT SHIRTS (U.S. CLS. 22 AND 39).

CLASS 25—(Continued).

SN 76-329,318. WILLIAMS, ANTHONY ANDREW, PHOENIX, AZ. FILED 10-25-2001.

HARDCORE STREET WEAR

NO CLAIM IS MADE TO THE EXCLUSIVE RIGHT TO USE "STREET WEAR", APART FROM THE MARK AS SHOWN.

FOR SHIRTS, SHOES, PANTS, HATS, SHORTS AND SOCKS (U.S. CLS. 22 AND 39).

SN 76-329,528. PRECISION TRADING CORPORATION, MIAMI, FL. FILED 10-22-2001.



FOR FOOTWEAR (U.S. CLS. 22 AND 39).

SN 76-330,169. ROBIN ROAD PRODUCTIONS, LLC, SHERMAN OAKS, CA. FILED 10-26-2001.



FOR CLOTHING, FOOTWEAR AND HEADWEAR, NAMELY, T-SHIRTS, SWEAT SHIRTS, JERSEYS, SHORTS, SWEAT PANTS, JACKETS, HATS, CAPS, SCARVES, GLOVES, HOSIERY, NECKTIES, PAJAMAS, ROBES, NIGHT SHIRTS, NIGHT GOWNS, UNDERWEAR, HEAD BANDS, WRIST BANDS, SWIM SUITS, SKIRTS, SHIRTS, TANK TOPS, PANTS, COATS, SWEATERS, LEOTARDS, LEG WARMERS, STOCKINGS, SOCKS, PANTY HOSE, TIGHTS, BELTS, SHOES, ATHLETIC SHOES, SLIPPERS, BOOTS, SANDALS AND RAINWEAR (U.S. CLS. 22 AND 39).

CLASS 25—(Continued).

SN 76-330,785. RUSSELL ASSET MANAGEMENT, INC., WILMINGTON, DE. FILED 10-29-2001.

DRI POWER

FOR CLOTHING, FOR MEN, WOMEN AND CHILDREN, NAMELY, WIND RESISTANT SUITS, TUNICS, PANTS, TOPS, T-SHIRTS, TANK TOPS, SHIRTS, SHORTS, ATHLETIC UNIFORMS, POLO SHIRTS, SPORTS BRAS, ATHLETIC JERSEYS, SWEATPANTS, SWEATSHIRTS, WRIST BANDS, JACKETS, PARKAS AND SOCKS (U.S. CLS. 22 AND 39).

SN 76-330,788. RUSSELL ASSET MANAGEMENT, INC., WILMINGTON, DE. FILED 10-29-2001.

THERMA POWER

FOR CLOTHING, FOR MEN, WOMEN AND CHILDREN, NAMELY, WIND RESISTANT SUITS, TUNICS, PANTS, TOPS, T-SHIRTS, TANK TOPS, SHIRTS, SHORTS, ATHLETIC UNIFORMS, POLO SHIRTS, SPORTS BRAS, ATHLETIC JERSEYS, SWEATPANTS, SWEATSHIRTS, WRIST BANDS, JACKETS, PARKAS AND SOCKS (U.S. CLS. 22 AND 39).

SN 76-331,123. LIFE IS GOOD, INC., DERRY, NH. FILED 10-29-2001.

HOMEMADE JAM

FOR ATHLETIC FOOTWEAR, NAMELY BASKETBALL SHOES, TENNIS SHOES, GOLF SHOES, RUNNING SHOES, CROSS-TRAINING SHOES, FOOTBALL SHOES AND BASEBALL SHOES (U.S. CLS. 22 AND 39).

SN 76-331,132. CHICAGO BEARS FOOTBALL CLUB, INC., LAKE FOREST, IL. FILED 10-29-2001.

DA BEARS

OWNER OF U.S. REG. NOS. 952,441, 1,189,590 AND OTHERS.

FOR MEN'S, WOMEN'S AND CHILDREN'S CLOTHING, NAMELY, FLEECE TOPS AND BOTTOMS, CAPS, HEADWEAR, T-SHIRTS, SWEATSHIRTS, SHORTS, TANK TOPS, JEANS, SWEATERS, PANTS, JACKETS, TURTLENECKS, JUMPSUITS, GOLF SHIRTS, WOVEN SHIRTS, KNIT SHIRTS, JERSEYS, WRISTBANDS, WARM UP SUITS, SWIMWEAR, WIND RESISTANT JACKETS, RAINCOATS, PARKAS, PONCHOS, GLOVES, TIES, SUSPENDERS, CLOTH BIBS, SLEEPWEAR, NAMELY, ROBES, NIGHT SHIRTS AND PAJAMAS, MITTENS, KNIT HATS AND CAPS, SCARVES, APRONS, HEADBANDS, EAR MUFFS, UNDERWEAR, SNEAKERS AND SLIPPERS (U.S. CLS. 22 AND 39).

CLASS 25—(Continued).

SN 76-331,357. WHITTINGHAM-BARNES, DONNA, NEW YORK, NY. FILED 10-31-2001.

CELEBRATE THE ANGEL IN YOU

FOR CLOTHING, NAMELY, SHIRTS, T-SHIRTS, POLO SHIRTS, KNIT SHIRTS, JACKETS, SWEATSHIRTS, SWEAT BANDS, HEADBANDS, VISORS, SOCKS, WIND RESISTANT JACKETS, CAPS (U.S. CLS. 22 AND 39).

SN 76-331,399. MAY DEPARTMENT STORES INTERNATIONAL, INC., ST. LOUIS, MO. FILED 10-30-2001.

I. E. SPORTSWEAR

NO CLAIM IS MADE TO THE EXCLUSIVE RIGHT TO USE "SPORTSWEAR", APART FROM THE MARK AS SHOWN.

FOR WOMEN'S SPORTSWEAR APPAREL, NAMELY, SKIRTS, SHORTS, TOPS, DRESSES, JACKETS, COATS AND SHOES (U.S. CLS. 22 AND 39).

SN 76-332,295. E.S. ORIGINALS, INC., NEW YORK, NY. FILED 10-31-2001.

OUTPLAY

FOR FOOTWEAR (U.S. CLS. 22 AND 39).

SN 76-332,331. EVEREADY BATTERY COMPANY, INC., ST. LOUIS, MO. FILED 10-30-2001.

ENERGIZER

OWNER OF U.S. REG. NOS. 1,177,083, 2,044,427 AND OTHERS.

FOR CLOTHING; NAMELY, CAPS, T-SHIRTS, SWEATSHIRTS, JACKETS AND BOXER SHORTS (U.S. CLS. 22 AND 39).

FIRST USE 11-15-1999; IN COMMERCE 11-15-1999.

CLASS 25—(Continued).

SN 76-332,682. ROBINSON, TAMIL, SOUTH ORANGE, NJ. FILED 11-1-2001.

AMIAT

FOR EVENING WEAR, COCKTAIL WEAR AND FORMALWEAR, NAMELY, EVENING GOWNS, TUXEDOS, CUMMERBUNDS, AND COCKTAIL DRESSES; BRIDAL WEAR, NAMELY, BRIDAL GOWNS, BRIDESMAIDS GOWNS, AND DRESSES, SKIRTS AND TOPS FOR THE BRIDAL PARTY; DRESSES, SKIRTS, SLACKS, SWEATSHIRTS, T-SHIRTS, SHIRTS, BLOUSES, JEANS, PANTS, JUMPSUITS, SWEATPANTS, LINGERIE, SWEATERS, JACKETS, COATS, UNDERWEAR, CAPS, HATS, SHORTS, TIES, SCARVES, SHAWLS, GLOVES, BELTS AND SHOES (U.S. CLS. 22 AND 39).

SN 76-332,770. KIDQUEST, INC., DBA WONDERWINGS-COM ENTERTAINMENT, DALLAS, TX. FILED 11-2-2001.



OWNER OF U.S. REG. NOS. 1,927,865 AND 2,308,293.
FOR ACTIVEWEAR, NAMELY, SHORTS, PANTS, JUMPSUITS, JEANS, T-SHIRTS, TURTLENECKS, SWEATERS, DRESSES, SKIRTS, OVERALLS, JUMPERS, SWEAT SUITS, BATH ROBES, BATHING SUITS/SWIM SUITS, BEACH COVER-UPS, BELTS, CAPS/HATS, EAR MUFFS/HEADBANDS; FOOTWEAR, NAMELY, SLIPPERS, ATHLETIC SHOES, DRESS SHOES, BEACH SHOES, PLASTIC SANDALS, SANDALS, HIKING BOOTS, BOOTS, SLIPPER SOCKS, SOCKS; OUTERWEAR, NAMELY, JACKETS, SNOW SUITS, SKI SETS, FLEECE PULL-OVERS, RAINWEAR/RAIN COATS, PAJAMAS, NAMELY, FOOTED SLEEPERS, BLANKET SLEEPERS, ROMPERS, DORM SHIRTS, NIGHTGOWNS, MITTENS; GLOVES; SCARVES; SUSPENDERS; UNDERWEAR, NAMELY, UNDERSHIRTS, UNDERPANTS, BOXERS, TRAINING PANTS, LONG UNDERWEAR, THERMAL UNDERWEAR; INFANT WEAR AND LAYETTE, NAMELY, CLOTH DIAPER SETS COMPRISED OF UNDERSHIRT AND CLOTH DIAPER COVER, CREEPERS, STRETCHIES, SLEEPERS, CAPS, BOOTIES, CLOTH BIBS; HALLOWEEN COSTUMES (U.S. CLS. 22 AND 39).

SN 76-333,261. J.T. DESIGN STUDIO, INC., LOS ANGELES, CA. FILED 11-1-2001.

SHAME ON YOU

FOR CLOTHING, HEADWEAR AND FOOTWEAR, NAMELY, TOPS, SHIRTS, DRESSES, SKIRTS, PANTS, SWEATERS, T-SHIRTS, KNIT SHIRTS, CAPS, JACKETS, HEADWEAR AND FOOTWEAR (U.S. CLS. 22 AND 39).
FIRST USE 10-0-2001; IN COMMERCE 10-0-2001.

CLASS 25—(Continued).

SN 76-334,012. LOCAL BOYS, LLC, LOS ANGELES, CA. FILED 11-6-2001.



THE MARK CONSISTS OF A STYLIZED OCEAN WAVE. FOR CLOTHING APPAREL, NAMELY MENS' AND WOMENS' T-SHIRTS, SWEATSHIRTS, WARM-UP SUITS, PANTS, SHORTS, SHIRTS, HATS AND SWIMWEAR (U.S. CLS. 22 AND 39).

SN 76-334,351. AIR 7 SPORTS, LLC, VERNON, CA. FILED 11-6-2001.

AIR 7 SPORTS

NO CLAIM IS MADE TO THE EXCLUSIVE RIGHT TO USE "SPORTS", APART FROM THE MARK AS SHOWN.

FOR MEN'S, WOMEN'S, AND CHILDREN'S CLOTHING, NAMELY, SHIRTS, T-SHIRTS, BLOUSES, DRESSES, VESTS, JERSEYS, SWEATSHIRTS, SWEATERS, COATS, RAINCOATS, JACKETS, OUTERWEAR, JEANS, PANTS, SWEAT PANTS, SHORTS, JOGGING SUITS, PULLOVERS, SOCKS, GLOVES, SWIMWEAR, PAJAMAS, UNDERWEAR, ROBES, SPORTSWEAR, BELTS; FOOTWEAR, NAMELY, SHOES, BOOTS, AND SANDALS; AND HEAD GEAR, NAMELY, SCARVES, HATS, AND CAPS (U.S. CLS. 22 AND 39).

SN 76-335,778. NORTHPORT APPAREL, INC., NEW YORK, NY. FILED 11-8-2001.

231

FOR CLOTHING, NAMELY, JEANS, DENIM JEANS, OVERALLS, COVERALLS, JUMPERS, JUMP SUITS, TROUSERS, SLACKS, PANTS, CYCLE PANTS, SHORTS, BOXER SHORTS, SHIRTS, T-SHIRTS, UNDER SHIRTS, NIGHT SHIRTS, RUGBY SHIRTS, JERSEYS, UNIFORMS, ATHLETIC UNIFORMS, POLO SHIRTS, TOPS, CROP TOPS, TANK TOPS, HALTER TOPS, SWEAT SHIRTS, SWEAT SHORTS, SWEAT PANTS, WARM-UP SUITS, JOGGING SUITS, BLOUSES, SKIRTS, DRESSES, SWEATERS, VESTS, FLEECE VESTS, PULLOVERS, FLEECE PULLOVERS, SNOW SUITS, PARKAS, ANORAKS, PONCHOS, JACKETS, DINNER JACKETS, SPORTS JACKETS, GOLF AND SKI JACKETS, REVERSIBLE JACKETS, COATS, BLAZERS, SUITS, TURTLENECKS, SWIMWEAR, BEACHWEAR, CAPS, BERETS, HATS, HEADBANDS, WRIST BANDS, HEADWEAR, EAR MUFFS, APRONS, SCARVES, BANDANAS, BELTS, SUSPENDERS, NECKWEAR, NECKTIES, TIES, BOW TIES, CLOTH BIBS, CLOTH DIAPERS, BOOTIES, INFANTWEAR, UNDERWEAR, BRIEFS, TRUNKS, SINGLETS, SOCKS, LOUNGE WEAR, ROBES, BATHROBES, PAJAMAS, SLEEPWEAR, NIGHT GOWNS, LINGERIE, CAMISOLES, SLIPS, STOCKINGS, BODY STOCKINGS, PANTYHOSE, HOSIERY, KNIT HOSIERY, LEG WARMERS, BODYSUITS, LEGGINGS, TIGHTS, LEOTARDS, UNITARDS, GLOVES, MITTENS, WRIST BANDS, FOOTWEAR, SHOES, SNEAKERS, BOOTS, GALOSHES, SANDALS, ZORI, SLIPPERS AND RAINWEAR (U.S. CLS. 22 AND 39).

CLASS 25—(Continued).

SN 76-336,366. MULHOLLAND HEADWEAR, LTD., FORT WORTH, TX. FILED 11-13-2001.



FOR HEADWEAR (U.S. CLS. 22 AND 39).
FIRST USE 2-1-1994; IN COMMERCE 2-1-1994.

SN 76-336,367. MULHOLLAND HEADWEAR, LTD., FORT WORTH, TX. FILED 11-13-2001.

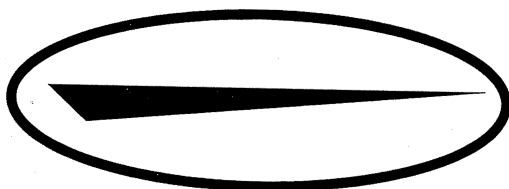

FOR HEADWEAR (U.S. CLS. 22 AND 39).
FIRST USE 2-1-1994; IN COMMERCE 2-1-1994.

SN 76-337,408. ILKOVICS, VICTOR MIKLOS, AUSTIN, TX. FILED 11-13-2001.

MARSOL

FOR SWIMSUITS FOR CHILDREN, MEN AND WOMEN; SWIMSUIT COVER-UPS AND BATHROBES (U.S. CLS. 22 AND 39).

SN 76-337,645. LUCASFILM LTD., NICASIO, CA. FILED 11-14-2001.



FOR MEN'S, WOMEN'S AND CHILDREN'S CLOTHING, NAMELY, JACKETS, SWEATSHIRTS, HATS, AND T-SHIRTS (U.S. CLS. 22 AND 39).
FIRST USE 4-30-2001; IN COMMERCE 4-30-2001.

CLASS 25—(Continued).

SN 76-337,813. STABLE MATES INC., LOS ANGELES, CA. FILED 11-13-2001.

INSTILL

FOR CLOTHING AND APPAREL, NAMELY, SHIRTS, SKIRTS, T-SHIRTS, SWEATSHIRTS, SWEATERS, JACKETS, COATS, HATS, CAPS, JEANS, PANTS, SWEATPANTS AND SOCKS (U.S. CLS. 22 AND 39).

SN 76-340,643. HASBRO, INC., PAWTUCKET, RI. FILED 11-23-2001.

MRS. POTATO HEAD

OWNER OF U.S. REG. NOS. 2,101,551 AND 2,133,140.
FOR FOOTWEAR, NAMELY SLIPPERS (U.S. CLS. 22 AND 39).
FIRST USE 9-1-2001; IN COMMERCE 9-1-2001.

SN 76-342,087. COLLIER, LANCE, CLEVELAND, OH. FILED 11-27-2001.

DOWNTHESUN

FOR ARTICLES OF CLOTHING, FOR MEN, WOMEN AND CHILDREN, NAMELY, T-SHIRTS, SWEATSHIRTS, TANK TOPS, JACKETS, KNITTED HEADWEAR, HATS, CAPS AND VISORS, PAJAMAS, NIGHTSHIRTS, ROBES, JOGGING SUITS, SWEATSUITS, JERSEYS, COLLAR SHIRTS, BLOUSES, SHORTS, PANTS, JUMPERS, OVERALLS, ROMPERS, LEOTARDS, DRESSES, SKIRTS, SHORT SETS COMPRISED OF SHORTS AND TOPS, SWEATERS, COATS, RAINCOATS, SCARVES, BANDANNAS, UNDERWEAR, VESTS, TIES, BELTS AND SUSPENDERS, SOCKS, TIGHTS, LEGGINGS, HOSIERY, GLOVES, MITTENS, APRONS, SWIMSUITS, FOOTWEAR AND MASQUERADE COSTUMES (U.S. CLS. 22 AND 39).

SN 76-342,925. HASBRO, INC., PAWTUCKET, RI. FILED 11-29-2001.

MR. POTATO HEAD

OWNER OF U.S. REG. NOS. 606,072 AND 2,133,139.
FOR FOOTWEAR, NAMELY SLIPPERS (U.S. CLS. 22 AND 39).
FIRST USE 9-1-2001; IN COMMERCE 9-1-2001.

SN 76-343,029. MEW MEW INK LLC, OMAHA, NE. FILED 11-30-2001.

MEW MEW INK

FOR CLOTHING, NAMELY SHIRTS, DRESSES, SHORTS, PANTS, JACKETS, COATS, HATS, SOX AND SHOES (U.S. CLS. 22 AND 39).
FIRST USE 3-0-2001; IN COMMERCE 3-0-2001.

CLASS 25—(Continued).

SN 76-343,231. MAUI MUSCLE FITNESS, INC., LAHAINA, HI. FILED 12-3-2001.

MAUI MUSCLE

FOR CLOTHING, NAMELY, SHIRTS, HATS, TANK TOPS, ONE-PIECE COVERALLS FOR INFANTS, BOXER SHORTS, ROMPERS, SHORTS, PANTS, SWEAT PANTS AND SWEATSHIRTS (U.S. CLS. 22 AND 39).
FIRST USE 1-0-1994; IN COMMERCE 1-0-1994.

SN 76-343,336. SYMONS, SHARON, SEATTLE, WA. FILED 12-3-2001.

NINE MONTHS TO A NEW BEGINNING

FOR MATERNITY AND NURSING MOTHER OUTER WEAR, NAMELY, PANTS, SHORTS, SKIRTS, TOPS, SHIRTS, VESTS, CARDIGANS, DRESSES AND JUMPERS (U.S. CLS. 22 AND 39).
FIRST USE 2-0-1999; IN COMMERCE 2-0-1999.

SN 76-345,397. VARSITY SPIRIT FASHIONS AND SUPPLIES, INC., MEMPHIS, TN. FILED 11-27-2001.

MOTIONFLEX

FOR CLOTHING, NAMELY, TOPS, SKIRTS, PANTS, MIDRIFTS, BODYSUITS, LEOTARDS, UNITARDS AND BRIEFS (U.S. CLS. 22 AND 39).

SN 76-345,458. CARTOON NETWORK LP, LLLP, THE, ATLANTA, GA. FILED 12-4-2001.

SAMURAI JACK

FOR CLOTHING FOR MEN, WOMEN AND CHILDREN - NAMELY, SHIRTS, T-SHIRTS, SWEATSHIRTS, JOGGING SUITS, TROUSERS, PANTS, SHORTS, TANK TOPS, RAINWEAR, CLOTH BIBS, SKIRTS, BLOUSES, DRESSES, SUSPENDERS, SWEATERS, JACKETS, COATS, RAINCOATS, SNOW SUITS, TIES, ROBES, HATS, CAPS, SUNVISORS, BELTS, SCARVES, SLEEPWEAR, PAJAMAS, LINGERIE, UNDERWEAR, BOOTS, SHOES, SNEAKERS, SANDALS, BOOTIES, SLIPPER SOCKS, SWIMWEAR AND MASQUERADE AND HALLOWEEN COSTUMES AND MASKS SOLD IN CONNECTION THEREWITH (U.S. CLS. 22 AND 39).
FIRST USE 8-13-2001; IN COMMERCE 8-13-2001.

CLASS 25—(Continued).

SN 76-346,909. LESLIE FAY LICENSING ENTERPRISES CORP., NEW YORK, NY. FILED 12-7-2001.

DW123

FOR WOMEN'S DRESSES, SUITS, SKIRTS, BLOUSES, SHIRTS AND JACKETS (U.S. CLS. 22 AND 39).

SN 76-350,805. BAYLESS, STRETCH, JARALES, NJ. FILED 12-13-2001.

DON'T WEAK'N

FOR CLOTHING, NAMELY SHIRTS, T-SHIRTS, KNIT SHIRTS, SPORT SHIRTS, SWEAT SHIRTS; AND CAPS AND HATS (U.S. CLS. 22 AND 39).

SN 78-034,431. GANG, WANG, BEIJING, CHINA, FILED 11-9-2000.

***DSIDAILED***

THE NAMES "JUPITER", "CAESARS THE EMPEROR" AND "DADAILD" DO NOT IDENTIFY WITH ANY LIVING INDIVIDUAL.

HERALDRY WITH AN ARMOUR KNIGHT IN A CHARIOT. THE MARK CONSISTS OF IN PART OF STYLIZED WORD "JUPITER" AND THE CHINESE WORD IN MARK TRANSLITERATES TO "KAI SAN DA TI" WHICH IN ENGLISH TRANSLATES TO "CAESARS THE EMPEROR".

THE CHINESE WORD IN MARK TRANSLITERATES TO "KAI SAN DA TI" WHICH IN ENGLISH TRANSLATES TO, "CAESARS THE EMPEROR".

FOR CLOTHING, NAMELY SHOES, PANTS, SOCKS, SHIRTS, FOOTWEAR (U.S. CLS. 22 AND 39).

CLASS 25—(Continued).

SN 78-047,769. STEWART, MICHAEL NNAMDI, DBA JAM-DON GLOBAL CONNECTIONS, RALEIGH, NC. FILED 2-11-2001.

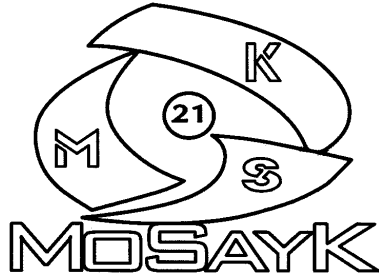

FOR SHIRTS, PANTS, HATS, SWEATERS, SKIRTS, AND SHOES (U.S. CLS. 22 AND 39).
FIRST USE 6-13-1998; IN COMMERCE 6-19-1999.

SN 78-047,977. DROBE, INC., ALTADENA, CA. FILED 2-12-2001.



THE MARK CONSISTS OF THE LETTERS "DROBE" WITH A RED BAR OVER THE LETTER "O".
FOR BUSINESS CASUAL SHIRTS, PANTS, TSHIRTS, SOCKS, UNDERGARMENTS (U.S. CLS. 22 AND 39).

SN 78-050,429. HAUPTMAN, WILLIAM D., LAKEWOOD, CO. FILED 2-27-2001.



FOR CLOTHING, NAMELY, T-SHIRTS, SWEATSHIRTS, DRESS SHIRTS, JACKETS, PULLOVER JACKETS, HATS AND SOCKS (U.S. CLS. 22 AND 39).
FIRST USE 12-31-1985; IN COMMERCE 12-31-1985.

CLASS 25—(Continued).

SN 78-051,565. WEAR ME APPAREL, NEW YORK, NY. FILED 3-6-2001.

PHQ

FOR CLOTHING, NAMELY, PANTS, DENIM JEANS, OVERALLS, SHORTS, SHIRTS, SWEATERS, JACKETS, VESTS, T-SHIRTS, SWEATSHIRTS, SWEATPANTS, SUSPENDERS, HATS, CAPS, HEADBANDS, UNDERWEAR, SLEEPWEAR, SCARVES, WORKOUT GEAR, NAMELY, SWEAT SUITS, SWEAT PANTS, SWEAT SHIRTS, GYM SHORTS, SNEAKERS, LEG-WARMERS, TIGHTS, TRACKSUITS, WRISTBANDS, BELT; OUTERWEAR, NAMELY, SKI PANTS, GLOVES, COATS, EARFLAPS, JACKETS, SKI MASKS, VESTS, RAINWEAR, CHILDREN'S CLOTHING, NAMELY JUMPERS, TIGHTS, DRESSES, SOCKS, BABY BOOTIES, COVERALLS, SWEATERS, SHORT SETS, CREEPER SETS, JUMPSUITS, ROMPERS, JACKET SETS AND COORDINATED TWO AND THREE PIECE PLAYSUITS (U.S. CLS. 22 AND 39).

SN 78-051,579. WEAR ME APPAREL, NEW YORK, NY. FILED 3-6-2001.

MHQ

OWNER OF U.S. REG. NO. 2,011,509.
FOR CLOTHING, NAMELY, PANTS, DENIM JEANS, OVERALLS, SHORTS, SHIRTS, SWEATERS, JACKETS, VESTS, T-SHIRTS, SWEATSHIRTS, SWEATPANTS, SUSPENDERS, HATS, CAPS, HEADBANDS, UNDERWEAR, SLEEPWEAR, SCARVES, WORKOUT GEAR, NAMELY, SWEAT SUITS, SWEAT PANTS, SWEAT SHIRTS, GYM SHORTS, SNEAKERS, LEG-WARMERS, TIGHTS, TRACKSUITS, WRISTBANDS, BELTS; OUTERWEAR, NAMELY, SKI PANTS, GLOVES, COATS, EARFLAPS, JACKETS, SKI MASKS, VESTS, RAINWEAR, CHILDREN'S CLOTHING, NAMELY JUMPERS, TIGHTS, DRESSES, SOCKS, BABY BOOTIES, COVERALLS, SWEATERS, SHORT SETS, CREEPER SETS, JUMPSUITS, ROMPERS, JACKET SETS AND COORDINATED TWO AND THREE PIECE PLAYSUITS (U.S. CLS. 22 AND 39).

SN 78-064,861. FUSION FASHION, INC., COLLEYVILLE, TX. FILED 5-21-2001.

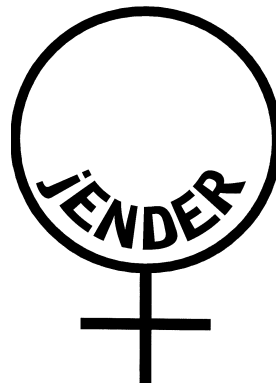

FOR CLOTHING; NAMELY, SHIRTS, JEANS, PANTS, AND JACKETS (U.S. CLS. 22 AND 39).
FIRST USE 9-25-2001; IN COMMERCE 9-25-2001.

CLASS 25—(Continued).

SN 78-064,988. COOK, ANNE F., TAKOMA PARK, MD.
FILED 5-22-2001.

IF ANIMALS COULD TALK— WILDLIFE PERSONALS

FOR T-SHIRTS AND SWEATSHIRTS FEATURING HUMOROUS TEXT USING FACTUAL INFORMATION ABOUT A VARIETY OF ANIMALS (U.S. CLS. 22 AND 39).

SN 78-068,576. EVELYN CHOI, BURBANK, CA. FILED 6-11-2001.

skinny  minnie

FOR SHIRTS, DRESSES, T-SHIRTS, PANTS, JEANS, HATS, SHOES (U.S. CLS. 22 AND 39).
FIRST USE 9-17-2000; IN COMMERCE 9-17-2000.

SN 78-074,137. T-SHIRT INTERNATIONAL, CULLODEN, WV. FILED 7-16-2001.

HOME OF THE BRAVE

FOR UNISEX CASUAL CLOTHING, NAMELY, HEADWEAR, T-SHIRTS, LAYERED T-SHIRTS, NIGHT SHIRTS, FLEECE SHIRTS, FLEECE PANTS, SHORTS, JACKETS, WOVEN SHIRTS, DENIM SHIRTS, TURTLE-NECK SHIRTS, PLACKET-FRONT SHIRTS, WIND-SHIRTS, WIND-SHORTS, POLO SHIRTS, MESH TANK TOPS, MESH SHORTS, DAZZLE TANK TOPS, DAZZLE SHORTS, FOOTBALL SHIRTS, HOCKEY SHIRTS, BASEBALL SHIRTS, SOCCER SHIRTS, JOGGING SUITS, MESH CROP TOPS, HATS, AND CAPS (U.S. CLS. 22 AND 39).

CLASS 25—(Continued).

SN 78-082,994. DONALDSON, LAMAR, DETROIT, MI.
FILED 9-6-2001.



THE MARK CONSISTS OF THE LETTERS "S" AND "W" WITHIN A SINGLE LINE CIRCLE DESIGN.

FOR FOOTWEAR, NAMELY, BASKETBALL SHOES, BASEBALL SHOES, JOGGING SHOES, AND CROSS-TRAINING SHOES, AND CLOTHING APPAREL, NAMELY, T-SHIRTS, LONG SLEEVED T-SHIRTS, HOODED SWEAT-SHIRTS, DENIM JACKETS, DENIM PANTS, FOOTBALL JERSEYS, BASKETBALL JERSEYS, BASEBALL JERSEYS, HOCKEY JERSEYS, KNITTED CAPS, BASEBALL CAPS, BRAS, THONG UNDERWEAR, G-STRING UNDERWEAR, SKIRTS, VESTS, TANK TOPS, AND ALL SEASON JACKETS (U.S. CLS. 22 AND 39).

SN 78-083,619. PERRY ELLIS INTERNATIONAL, INC., MIAMI, FL. FILED 9-12-2001.

MUNSINGWEAR ACTION- GUSSET

OWNER OF U.S. REG. NOS. 510,271, 2,366,230 AND OTHERS.

NO CLAIM IS MADE TO THE EXCLUSIVE RIGHT TO USE "ACTION-GUSSET", APART FROM THE MARK AS SHOWN.

FOR CLOTHING, NAMELY KNIT AND WOVEN SHIRTS (U.S. CLS. 22 AND 39).

SN 78-091,908. BURRAGE, MICHAEL, CHICAGO, IL. AND BURRAGE, HOWARD, JR., CHICAGO, IL. FILED 11-6-2001.

SHUT UP DEVIL

FOR CLOTHING, NAMELY, SHIRTS, PANTS, SKIRTS, T-SHIRTS, SWEATSHIRTS, DRESSES, SKORTS, SUITS, SCARVES, UNDERWEAR BRIEFS, BRAS, PAJAMAS, SWIMSUITS, SHORTS; FOOTWEAR; HEADWEAR, NAMELY, CAPS, HATS, BANDANAS (U.S. CLS. 22 AND 39).

CLASS 25—(Continued).

SN 78-092,489. KITCHEN, SCOTT A, GILBERT, AZ. AND WILD, MARK R, MESA, AZ. FILED 11-9-2001.

GOT SCUBA

FOR T-SHIRTS,SWEATSHIRTS,HATS (U.S. CLS. 22 AND 39).

SN 78-093,665. PETERSON, ERIC R, LIBERTYVILLE, IL. FILED 11-15-2001.

IM EARTH

FOR SHIRTS (U.S. CLS. 22 AND 39).

SN 78-093,666. PETERSON, ERIC R, LIBERTYVILLE, IL. FILED 11-15-2001.

INTERNATIONAL MEMBERS OF MOTHER EARTH

FOR SHIRTS (U.S. CLS. 22 AND 39).

SN 78-094,610. RED WING SHOE COMPANY, INC., RED WING, MN. FILED 11-21-2001.

DeerTracker

FOR HUNTING BOOTS (U.S. CLS. 22 AND 39).

CLASS 26—FANCY GOODS

SN 75-752,196. ZIPPERSOURCE, INC., CHICAGO, IL. BY ASSIGNMENT LICHTENSTEIN, PAUL E., CHICAGO, IL. FILED 7-15-1999.



NO CLAIM IS MADE TO THE EXCLUSIVE RIGHT TO USE "ZIPPER", APART FROM THE MARK AS SHOWN. FOR CUSTOM MADE ZIPPERS (U.S. CLS. 37, 39, 40, 42 AND 50). FIRST USE 3-9-2000; IN COMMERCE 3-9-2000.

CLASS 26—(Continued).

SN 76-129,527. ALLFORHAIR HAARKOSMETIK GMBH, A - 1010 VIENNA, AUSTRIA, FILED 9-15-2000.

ARISTO

PRIORITY CLAIMED UNDER SEC. 44(D) ON AUSTRIA APPLICATION NO. AM3835/2000, FILED 5-23-2000, REG. NO. 192930, DATED 12-27-2000, EXPIRES 12-27-2010.

FOR NON-ELECTRIC HAIR CURLERS (U.S. CLS. 37, 39, 40, 42 AND 50).

SN 76-219,530. DIANE GRAY AND SHEILA DOYLE PARTNERSHIP, THE, VERONA, PA. FILED 3-5-2001.

MIWAVES

FOR HAIR ROLLERS (U.S. CLS. 37, 39, 40, 42 AND 50).

SN 76-242,141. BEAUTY AID GLOBAL, INC., CHICAGO, IL. FILED 4-11-2001.

HAIR HAVEN

NO CLAIM IS MADE TO THE EXCLUSIVE RIGHT TO USE "HAIR", APART FROM THE MARK AS SHOWN.

FOR HAIR ACCESSORIES, NAMELY, NON-ELECTRIC HAIR ROLLERS, HAIR CLIPS, HAIR BANDS, HAIR PINS, BARRETTES, HAIR BOWS, HAIR BUCKLES, HAIR ORNAMENTS, HAIR SLIDES, HAIR NETS AND HAIR CAPS (U.S. CLS. 37, 39, 40, 42 AND 50).

SN 76-327,729. CREATIVE IMAGE SYSTEMS, INC., ANAHEIM, CA. FILED 10-19-2001.

SONIX

FOR NON-ELECTRIC THERMAL CURLING IRONS, NON-ELECTRIC THERMAL CRIMPING IRONS, NON-ELECTRIC THERMAL FLAT IRONS, NON-ELECTRIC THERMAL PRESSING COMBS, NON-ELECTRIC BRAID SEALERS AND CUTTERS (U.S. CLS. 37, 39, 40, 42 AND 50).

CLASS 27—FLOOR COVERINGS

SN 76-002,991. HONEYWELL INTERNATIONAL INC., MORRISTOWN, NJ. FILED 3-17-2000.

ANSO CRUSHRESISTER III ACT

OWNER OF U.S. REG. NOS. 883,576, 1,701,850 AND 2,149,565.

FOR NYLON FIBER SOLD AS AN INTEGRAL COMPONENT OF CARPETS (U.S. CLS. 19, 20, 37, 42 AND 50).

CLASS 27—(Continued).

SN 76-002,992. HONEYWELL INTERNATIONAL INC., MORRISTOWN, NJ. FILED 3-17-2000.

CLASS 28—TOYS AND SPORTING GOODS

SN 75-413,561. DISCOVERY COMMUNICATIONS, INC., BETHESDA, MD. FILED 1-6-1998.

**ANSO CRUSHRESISTER III
TLC**

OWNER OF U.S. REG. NOS. 883,576, 1,701,850 AND 2,149,565.
FOR NYLON FIBER SOLD AS AN INTEGRAL COMPONENT OF CARPETS (U.S. CLS. 19, 20, 37, 42 AND 50).

SN 76-135,767. RJF INTERNATIONAL CORPORATION, FAIRLAWN, OH. FILED 9-26-2000.

TAC-WALL

FOR WALLCOVERINGS, COMPRISED PRIMARILY OF ELASTOMERIC MATERIAL (U.S. CLS. 19, 20, 37, 42 AND 50).
FIRST USE 11-0-1999; IN COMMERCE 11-0-1999.

SN 76-346,129. MANHATTAN GROUP, LLC, MINNEAPOLIS, MN. FILED 12-6-2001.

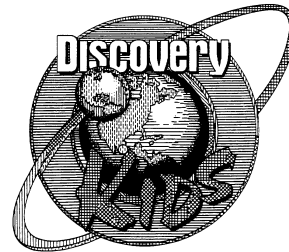

OWNER OF U.S. REG. NO. 2,344,957.
FOR WALLPAPER AND BORDERS; RUGS, DOORMATS, AND BATHMATS (U.S. CLS. 19, 20, 37, 42 AND 50).

OWNER OF U.S. REG. NOS. 883,953, 2,092,711 AND OTHERS.

NO CLAIM IS MADE TO THE EXCLUSIVE RIGHT TO USE "KIDS", APART FROM THE MARK AS SHOWN.

THE DRAWING IS LINED FOR THE COLORS BLUE, RED, YELLOW, ORANGE AND PURPLE, BUT COLOR IS NOT CLAIMED AS A FEATURE OF THE MARK.

FOR GAMES, NAMELY, BOARD GAMES, CARD GAMES, PARLOR GAMES, ACTION SKILL GAMES, HAND HELD UNITS FOR PLAYING ELECTRONIC AND VIDEO GAMES; OUTDOOR ACTIVITY GAMES IN THE NATURE OF SWIMMING GAMES, CLIMBING GAMES, AND WATER RELATED GAMES; MANIPULATIVE GAMES; ROLE PLAYING GAMES; PLUSH TOYS; SOFT SCULPTURE TOYS; PUZZLES, NAMELY, JIGSAW PUZZLES, MANIPULATIVE PUZZLES, THREE-DIMENSIONAL PUZZLES; TOY ACTION FIGURES, AND ACCESSORIES THEREFOR; PLAY FIGURES; WATER SQUIRTING TOYS; BATHTUB TOYS; AND DOLLS, ALL OF WHICH ARE SOLD IN CONNECTION WITH APPLICANT'S TELEVISION SERIES AND NETWORKS, AND WHICH ARE OFFERED EXCLUSIVELY IN APPLICANT'S RETAIL OUTLETS, THROUGH APPLICANT'S SUBSCRIPTION CATALOG, OR VIA ITS ONLINE SERVICES (U.S. CLS. 22, 23, 38 AND 50).

CLASS 28—(Continued).

SN 75-473,150. UNIVERSAL CITY STUDIOS, INC., UNIVERSAL CITY, CA. FILED 4-23-1998.

UNIVERSAL STUDIOS ESCAPE

OWNER OF U.S. REG. NO. 1,531,018.

FOR TOYS AND GAMES, NAMELY, ACTION FIGURES AND ACCESSORIES THEREFOR; BALLOONS; BATHTUB TOYS; TOY BUILDING BLOCKS; DOLLS AND ACCESSORIES THEREFOR; DOLL CLOTHING; BOARD GAMES, CARD GAMES; PLAY COSMETICS FOR CHILDREN; COSTUME MASKS; MINIATURE DIE CAST TOY VEHICLES; TOY AIRPLANES AND HELICOPTERS; BATTERY OPERATED REMOTE CONTROLLED TOY VEHICLES; FLYING DISCS; INFLATABLE TOY VINYL FIGURES; JIGSAW PUZZLES; KITES; MARBLES; INDOOR SLUMBER AND PLAY TENTS; PLUSH TOYS; HAND HELD PUPPETS; SIT-IN AND RIDE-ON TOY VEHICLES; TOY TRAIN SETS AND MODEL TRAIN SET; PLAY SHAVING KITS COMPRISING PLAY SHAVING CREAM, PLAY RAZORS AND ACCESSORIES THEREFORE; SKATEBOARDS; ROLLER SKATES; TOY BANKS; WATER SQUIRTING TOYS; TOY PISTOLS; TARGET SETS COMPRISING TOY GUNS, SUCTION DARTS AND TARGET; CHRISTMAS TREE ORNAMENTS EXCEPT CONFECTIONERY OR ILLUMINATION ARTICLES; PINBALL AND ARCADE GAME MACHINES AND HAND HELD UNIT FOR PLAYING ELECTRONIC GAMES SOLD IN ASSOCIATION WITH AND ONLY AT REGISTRANT'S MOTION PICTURE STUDIOS, AMUSEMENT PARKS, THEMED ENTERTAINMENT VENUES AND ON-LINE WEB SITE (U.S. CLS. 22, 23, 38 AND 50).

CLASS 28—(Continued).

SN 75-549,480. UNIVERSAL CITY STUDIOS, INC., UNIVERSAL CITY, CA. FILED 9-8-1998.



THE MARK CONSISTS, IN PART, OF A REPRESENTATION OF AN ARCH, A TORCH AND A GLOBE.

FOR TOYS AND GAMES, NAMELY, ACTION FIGURES AND ACCESSORIES THEREFOR; BALLOONS; BATHTUB TOYS; TOY BUILDING BLOCKS; DOLLS AND ACCESSORIES THEREFOR; DOLL CLOTHING; BOARD GAMES, CARD GAMES; PLAY COSMETICS FOR CHILDREN; COSTUME MASKS; MINIATURE DIE CAST TOY VEHICLES; TOY AIRPLANES AND HELICOPTERS; BATTERY OPERATED REMOTE CONTROLLED TOY VEHICLES; FLYING DISCS; INFLATABLE TOY VINYL FIGURES; JIGSAW PUZZLES; KITES; MARBLES; INDOOR SLUMBER AND PLAY TENTS; PLUSH TOYS; HAND HELD PUPPETS; SIT-IN AND RIDE-ON TOY VEHICLES; TOY TRAIN SETS AND MODEL TRAIN SET; PLAY SHAVING KITS COMPRISING PLAY SHAVING CREAM, PLAY RAZORS AND ACCESSORIES THEREFORE; SKATEBOARDS; ROLLER SKATES; TOY BANKS; WATER SQUIRTING TOYS; TOY PISTOLS; TARGET SETS COMPRISING TOY GUNS, SUCTION DARTS AND TARGET; CHRISTMAS TREE ORNAMENTS EXCEPT CONFECTIONERY OR ILLUMINATION ARTICLES; PINBALL AND ARCADE GAME MACHINES AND HAND HELD UNIT FOR PLAYING ELECTRONIC GAMES (U.S. CLS. 22, 23, 38 AND 50).

SN 75-643,199. EUROCOPTER, 13725 MARGNANE CEDEX, FRANCE, FILED 2-17-1999.

NH90

PRIORITY CLAIMED UNDER SEC. 44(D) ON FRANCE APPLICATION NO. 96607910, FILED 1-29-1996, REG. NO. 96607910, DATED 1-29-1996, EXPIRES 1-29-2006.

FOR TOYS AND SCALE MODELS OF HELICOPTERS (U.S. CLS. 22, 23, 38 AND 50).

SN 75-781,714. RACING CHAMPIONS, INC., GLEN ELLYN, IL. FILED 8-20-1999.

EXTREME DREAM MACHINES

FOR COLLECTIBLE MINIATURE TOY VEHICLES (U.S. CLS. 22, 23, 38 AND 50).

CLASS 28—(Continued).

SN 75-809,780. MACK, JOHN, HOLLAND, PA. FILED 9-28-1999.

NEXT LEVEL

OWNER OF U.S. REG. NO. 1,744,608.
FOR SOCCER BALLS, BASEBALL GLOVES, BALLS AND BATS, SKATEBOARDS, TENNIS RACQUETS AND BALLS, FOOTBALLS AND FOOTBALL TEES, SNOWBOARDS, SKIS, POLES AND SKI GOGGLES, AND BASKETBALLS, EXCLUDING CLOTHING AND SPORTS APPAREL (U.S. CLS. 22, 23, 38 AND 50).

SN 75-831,000. SOMJA' LAR AB, 171 22 SOLNA, SWEDEN, FILED 10-25-1999.



PRIORITY CLAIMED UNDER SEC. 44(D) ON SWEDEN APPLICATION NO. 9903444, FILED 5-4-1999, REG. NO. 341261, DATED 10-13-2000, EXPIRES 10-13-2010.

THE STIPPLING IN THE DRAWING IS A FEATURE OF THE MARK AND IS NOT INTENDED TO INDICATE COLOR.

FOR PARLOUR-GAMES (U.S. CLS. 22, 23, 38 AND 50).

SN 75-875,750. ORIGINAL SAN FRANCISCO TOYMAKERS, INC., THE, SOUTH SAN FRANCISCO, CA. FILED 12-20-1999.

JAM BALLS

NO CLAIM IS MADE TO THE EXCLUSIVE RIGHT TO USE "BALLS", APART FROM THE MARK AS SHOWN.

FOR TOYS, NAMELY MUSICAL AND OSCILLATING PLAY BALLS (U.S. CLS. 22, 23, 38 AND 50).

SN 75-906,312. THINKING TECHNOLOGY INC., NASSAU, BAHAMAS, FILED 1-31-2000.

SMART GAL

FOR DOLLS AND DOLL ACCESSORIES (U.S. CLS. 22, 23, 38 AND 50).

SN 75-981,736. DOLLY, INC., TIPP CITY, OH. FILED 5-7-2001.

MAKE'N WAVES

FOR BATH TOYS (U.S. CLS. 22, 23, 38 AND 50).

CLASS 28—(Continued).

SN 76-013,570. MARS, INCORPORATED, MCLEAN, VA. FILED 3-30-2000.

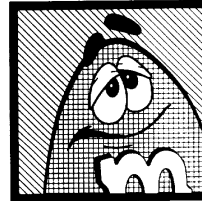

OWNER OF U.S. REG. NOS. 981,235, 983,429 AND OTHERS.

THE MARK IS LINED FOR THE COLORS YELLOW AND GREEN.

FOR GOLF BALLS (U.S. CLS. 22, 23, 38 AND 50).
FIRST USE 10-15-1998; IN COMMERCE 10-15-1998.

SN 76-049,644. TURCOTTE, MICHAEL, DBA PROBACK ENTERPRISES, WEST CHESTER, OH. FILED 5-15-2000.

PROBACK

FOR BASEBALL AND SOFTBALL EQUIPMENT, NAMELY, REBOUNDING DEVICES THAT ARE USED TO REBOUND A THROWN BALL BACK TOWARDS THE THROWER (U.S. CLS. 22, 23, 38 AND 50).
FIRST USE 6-14-1999; IN COMMERCE 6-14-1999.

SN 76-084,812. WILD PLANET TOYS, INC., SAN FRANCISCO, CA. FILED 7-7-2000.

SPY DETECTORS

NO CLAIM IS MADE TO THE EXCLUSIVE RIGHT TO USE "SPY", APART FROM THE MARK AS SHOWN.

FOR BOARD GAMES; HAND HELD UNIT FOR PLAYING ELECTRONIC GAMES; ROLE PLAYING TOYS, NAMELY, TOY MOTION ALARMS AND LIGHT SENSOR ALARMS FOR PRETEND/ROLE PLAY SPY AND DETECTIVE GAMES; TOY SPY KIT, NAMELY, WALKIE TALKIES, SPY SCOPES AND MAGNIFYING GLASSES; TOY FINGERPRINTING KITS, COMPRISED OF TOY INK PAD, TOY FINGERPRINTING PAD, TOY FINGERPRINTING CARDS, AND TOY MAGNIFYING GLASS; TOY BLACKLIGHT FLASHLIGHTS; TOY ONE-WAY AND TWO-WAY RADIOS; TOY LISTENING DEVICES, NAMELY, A TOY AMPLIFIER AND HEADPHONES USED FOR LISTENING THROUGH WALLS; TOY CARRYING CASES; TOY BOXES WITH HIDDEN COMPARTMENTS (U.S. CLS. 22, 23, 38 AND 50).
FIRST USE 10-0-1999; IN COMMERCE 11-0-1999.

CLASS 28—(Continued).

SN 76-094,330. PROPAGANDA FILMS, INC., LOS ANGELES, CA. FILED 7-24-2000.

PROPAGANDA

OWNER OF U.S. REG. NO. 1,552,297.
FOR ACTION, BOARD AND CARD GAMES, MECHANICAL, BATH, CONSTRUCTION, CRIB, INFANT, INFLATABLE, MUSICAL AND PLUSH TOYS (U.S. CLS. 22, 23, 38 AND 50).

SN 76-099,728. SEATTLE SUBMERSIBLES, INC., POTOMAC, MD. FILED 8-1-2000.

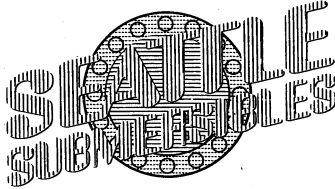

NO CLAIM IS MADE TO THE EXCLUSIVE RIGHT TO USE "SUBMERSIBLES", APART FROM THE MARK AS SHOWN.

THE DRAWING IS LINED FOR THE COLOR(S) RED, BLUE, GREY AND SILVER.

FOR TOY SUBMERSIBLES FOR CHILDREN AND ADULTS PACKAGING FOR SAME INCLUDING ADVERTISEMENTS OF THOSE TOYS (U.S. CLS. 22, 23, 38 AND 50).

SN 76-100,889. RITVIK HOLDINGS INC., ST. LAURENT (QC), CANADA, FILED 8-1-2000.



FOR CONSTRUCTION TOYS (U.S. CLS. 22, 23, 38 AND 50).

SN 76-101,709. TIM JEWETT ENTERPRISES, INC., SEATTLE, WA. FILED 7-31-2000.

FITNESS BASICS

NO CLAIM IS MADE TO THE EXCLUSIVE RIGHT TO USE "FITNESS", APART FROM THE MARK AS SHOWN.

FOR HOME EXERCISE AND FITNESS EQUIPMENT, NAMELY, STAIR-STEPPING MACHINES, ELLIPTICAL MACHINES, EXERCISE BIKES, ROWING MACHINES, WEIGHT BENCHES, TREADMILLS, PULLEYS, WEIGHT LIFTING MACHINES AND ACCESSORIES THEREFORE, SOLD TOGETHER AS A UNIT (U.S. CLS. 22, 23, 38 AND 50).

CLASS 28—(Continued).

SN 76-113,360. PROGRESSIVE DYNAMICS, INC., BOULDER, CO. FILED 8-21-2000.

THE POWER CIRCLE

NO CLAIM IS MADE TO THE EXCLUSIVE RIGHT TO USE "CIRCLE", APART FROM THE MARK AS SHOWN.

FOR EXERCISE DEVICE IN THE NATURE OF A CIRCULAR SPRING TENSION BAND WITH UPHOLSTERED HANDLES DESIGNED NAMELY FOR ISOMETRIC EXERCISES, GENERAL BODY CONDITIONING AND FLEXIBILITY TRAINING; AND MANUALLY OPERATED EXERCISE EQUIPMENT IN THE NATURE OF A CIRCULAR SPRING TENSION BAND WITH UPHOLSTERED HANDLES DESIGNED, NAMELY, FOR ISOMETRIC EXERCISES, GENERAL BODY CONDITIONING AND FLEXIBILITY TRAINING (U.S. CLS. 22, 23, 38 AND 50).

FIRST USE 6-0-1994; IN COMMERCE 6-0-1994.

SN 76-114,991. NATURE FRIEND, INC., CITY OF INDUSTRY, CA. FILED 8-23-2000.



NO CLAIM IS MADE TO THE EXCLUSIVE RIGHT TO USE "FROG", APART FROM THE MARK AS SHOWN.

THE LETTERS "S" AND "O" ARE LINED FOR THE COLOR RED.

FOR FISHING EQUIPMENT AND ACCESSORIES, NAMELY, SINKERS, FROG LURES, SPINNER BAITS LURES, FISHING RODS, FISHING BAGS, TACKLE BOXES, ARTIFICIAL FISHING BAITS, FISHING HOOKS, FISHING LURE BOXES, FISHING LURE PARTS, FISHING LURES, FISHING REELS, FISHING SINKERS, FISHING SPINNERS, FISHING TACKLE BOXES, ARTIFICIAL FISHING WORMS (U.S. CLS. 22, 23, 38 AND 50).

FIRST USE 6-12-2000; IN COMMERCE 6-12-2000.

SN 76-114,992. NATURE FRIEND, INC., CITY OF INDUSTRY, CA. FILED 8-23-2000.



THE MARK CONSISTS OF THE TERM "BOZE" IN STYLIZED FORM.

FOR FISHING EQUIPMENT AND ACCESSORIES, NAMELY, SINKERS, FROG LURES, SPINNER BAITS LURES, FISHING RODS, FISHING BAGS, TACKLE BOXES, ARTIFICIAL FISHING BAITS, FISHING HOOKS, FISHING LURE BOXES, FISHING LURE PARTS, FISHING LURES, FISHING REELS, FISHING SINKERS, FISHING SPINNERS, FISHING TACKLE BOXES, ARTIFICIAL FISHING WORMS (U.S. CLS. 22, 23, 38 AND 50).

FIRST USE 6-12-2000; IN COMMERCE 6-12-2000.

CLASS 28—(Continued).

SN 76-116,652. CLOROX COMPANY, THE, OAKLAND, CA. FILED 8-28-2000.

FRESH STEP

OWNER OF U.S. REG. NOS. 1,190,892, 2,292,930 AND OTHERS.
FOR TOY BEAN BAG CATS (U.S. CLS. 22, 23, 38 AND 50).
FIRST USE 2-13-2001; IN COMMERCE 2-13-2001.

SN 76-122,385. WINN, INC., HUNTINGTON BEACH, CA. FILED 9-5-2000.

MASTER WRAP

NO CLAIM IS MADE TO THE EXCLUSIVE RIGHT TO USE "WRAP", APART FROM THE MARK AS SHOWN.
FOR GOLF CLUB GRIPS (U.S. CLS. 22, 23, 38 AND 50).
FIRST USE 9-11-1995; IN COMMERCE 9-11-1995.

SN 76-131,753. JACOBS TRADING COMPANY, MINNEAPOLIS, MN. FILED 9-20-2000.

JTC

FOR COLLECTIBLE SCALE MODEL VEHICLES AND RELATED ACCESSORIES SOLD AS A UNIT (U.S. CLS. 22, 23, 38 AND 50).

SN 76-144,483. PURSUIT MARKETING, INC., SCHILLER PARK, IL. FILED 10-10-2000.



FOR PAINTBALL EQUIPMENT, NAMELY, COMPRESSED AIR TANKS, CONTAINERS, ADAPTERS AND REGULATORS (U.S. CLS. 22, 23, 38 AND 50).
FIRST USE 6-0-2000; IN COMMERCE 6-0-2000.

SN 76-170,042. CHEETAH, LLC, NEW YORK, NY. FILED 11-22-2000.

WORLDWIDE WINES

NO CLAIM IS MADE TO THE EXCLUSIVE RIGHT TO USE "WINES", APART FROM THE MARK AS SHOWN.
FOR BOARD GAMES (U.S. CLS. 22, 23, 38 AND 50).
FIRST USE 4-11-2001; IN COMMERCE 4-16-2001.

CLASS 28—(Continued).

SN 76-172,993. PLAN CREATIONS CO. LTD., SILOM, BAN-GRAK BANGKOK 10500, THAILAND, FILED 11-29-2000.

PLAN CITY

OWNER OF UNITED KINGDOM REG. NO. 2252495, DATED 11-13-2000, EXPIRES 11-13-2010.
FOR TOYS, NAMELY, TOY GARAGES, TOY VEHICLES, TOY HELICOPTERS, TOY GAS STATIONS, TOY CAR SERVICE DEPOTS, TOY TRAFFIC SIGNS, TOY BRIDGES, TOY PLAY MATS, TOY BOATS; GAMES, NAMELY, MEMORY GAMES, LOTTO GAMES, DOMINO GAMES AND PLAYTHINGS, NAMELY, IMPULSE TOYS, DOLL HOUSES, DOLL FAMILIES, WOODEN DOLL FURNITURE, WOODEN TOYS, FABRIC TOYS, CONSTRUCTIONS BLOCK TOYS, WOODEN EDUCATIONAL TOYS AND WOODEN TREE HOUSES (U.S. CLS. 22, 23, 38 AND 50).

SN 76-175,459. WIZARDS OF THE COAST, INC., RENTON, WA. FILED 11-28-2000.

**DUNGEONS & DRAGONS
WARLORDS**

OWNER OF U.S. REG. NOS. 1,092,786, 1,092,828 AND OTHERS.
FOR FANTASY ROLEPLAYING GAMES AND BOARD GAMES, AND ACCESSORIES THEREFORE, NAMELY, COMMON METAL FIGURINES AND BOOKLETS CONTAINING ROLEPLAYING SCENARIOS, SOLD AS A UNIT (U.S. CLS. 22, 23, 38 AND 50).

SN 76-175,706. INGE-GLAS GMBH & CO. KG, 96465 NEUS-TADT B. COBURG, FED REP GERMANY, FILED 12-6-2000.

INGE-GLAS

OWNER OF U.S. REG. NO. 1,297,601.
FOR CHRISTMAS TREE DECORATIONS AND ORNAMENTS, EXCLUDING CONFECTIONERY OR ILLUMINATION ARTICLES (U.S. CLS. 22, 23, 38 AND 50).

SN 76-178,545. SOMMERS, JAMES, BEVERLY HILLS, CA. FILED 12-11-2000.

RAP-A-BABY

FOR INFANT TOYS, DOLLS, DOLL HOUSES, TOY AND DOLL HOUSES, BABY RATTLES; BOARD GAMES; BALLS, NAMELY, BASEBALLS, PLAYGROUND BALLS, SOCCER BALLS, BASKETBALLS, FOOTBALLS; BATS, NAMELY, BASEBALL BATS, SOFTBALL BATS, PLASTIC BASEBALL BATS; BALL GLOVES, NAMELY, BASEBALL GLOVES, HANDBALL GLOVES, RACQUETBALL GLOVES; MUSICAL TOYS, MUSIC BOX TOYS, TOY CARS (U.S. CLS. 22, 23, 38 AND 50).

CLASS 28—(Continued).

SN 76-178,630. PTT, LLC, WHITE PLAINS, NY. FILED 12-11-2000.

PICK FIVE

FOR GAMES, NAMELY, BOARD GAMES, CARD GAMES AND PARLOR GAMES, AND CASINO GAMES, NAMELY, CASINO CARD GAMES (U.S. CLS. 22, 23, 38 AND 50).

FIRST USE 8-8-1997; IN COMMERCE 8-8-1997.

SN 76-185,513. SIERRA ON-LINE, INC., BELLEVUE, WA. FILED 12-21-2000.

SWAT

PRIORITY CLAIMED UNDER SEC. 44(D) ON ERP N CMNTY TM OFC APPLICATION NO. 1738657, FILED 7-4-2000.

FOR TOY ACTION FIGURES AND ACTION FIGURE ACCESSORIES (U.S. CLS. 22, 23, 38 AND 50).

SN 76-188,061. TOBIAS, ANDREW J., RANCHO MIRAGE, CA. FILED 1-2-2001.

MOVIE MOGUL

FOR BOARD GAMES (U.S. CLS. 22, 23, 38 AND 50).

SN 76-189,041. GO GOLF, INC., SARASOTA, FL. FILED 1-3-2001.



NO CLAIM IS MADE TO THE EXCLUSIVE RIGHT TO USE THE REPRESENTATIONS OF A GOLF BALL AND A TEE, APART FROM THE MARK AS SHOWN.

THE SHADING IN THE DRAWING IS A FEATURE OF THE MARK AND DOES NOT INDICATE COLOR.

THE MARK COMPRISES THE WORDS "BE-THE-BALL" WITH THE SEGMENT "THE" AND PART OF THE SEGMENT "BALL" OVER A REPRESENTATION OF A GOLF BALL AND WITH A REPRESENTATION OF A GOLF TEE BEFORE THE SEGMENT "-BALL".

FOR GOLF TRAINING DEVICE, NAMELY A MECHANICAL DEVICE FOR PLACING THE BALL ON THE TEE FOR PRACTICING ONE'S GOLF SWING (U.S. CLS. 22, 23, 38 AND 50).

FIRST USE 1-26-2001; IN COMMERCE 4-25-2001.

CLASS 28—(Continued).

SN 76-189,433. GOLDEN KEY FUTURA, INC., MONTROSE, CO. FILED 1-3-2001.

TM HUNTER

NO CLAIM IS MADE TO THE EXCLUSIVE RIGHT TO USE "HUNTER", APART FROM THE MARK AS SHOWN. FOR ARCHERY ARROW RESTS (U.S. CLS. 22, 23, 38 AND 50).

FIRST USE 12-31-1983; IN COMMERCE 12-31-1983.

SN 76-191,139. COBBLESTONE BRIDGE, LLC, CANNON FALLS, MN. FILED 1-8-2001.

COBBLESTONE BRIDGE

FOR CHRISTMAS TREE ORNAMENTS AND DECORATIONS; CHRISTMAS ORNAMENTS FOR DECORATING TOP OF CHRISTMAS TREES; CHRISTMAS GARLANDS; CHRISTMAS TREE SKIRTS; CHRISTMAS DECORATIVE FIREPLACE OR WALL STOCKING; ARTIFICIAL CHRISTMAS WREATHS; DECORATIVE CHRISTMAS WINDSOCKS; AND CHRISTMAS TABLETOP AND DISPLAY ACCESSORIES, NAMELY, GARLAND (U.S. CLS. 22, 23, 38 AND 50).

FIRST USE 10-1-2000; IN COMMERCE 10-1-2000.

SN 76-199,606. BAKER, JON E., FORT JONES, CA. FILED 1-22-2001.

TARGOMATIC

FOR FIREARM TARGET, NAMELY, TARGET MACHINE FEATURING A CONTINUOUS ROLL OF PAPER TO CREATE CONTINUOUS TARGETS (U.S. CLS. 22, 23, 38 AND 50).

SN 76-206,208. GOLDMAN, MITCHELL W, POTOMAC, MD. FILED 2-7-2001.

GAMMA GOBLINS

FOR TOYS, NAMELY, DOLLS, DOLLHOUSES, DOLL CASES, DOLL FURNITURE, ACTION FIGURES AND CASES AND ACCESSORIES THEREFOR, PLUSH TOYS, BATH TOYS, PUPPETS, CHILDREN MULTIPLE ACTIVITY TOYS, RIDE-ON TOYS, MUSICAL TOYS, TOY BUILDING AND CONSTRUCTION BLOCKS, CHILDREN'S WIRE AND CONSTRUCTION AND ART ACTIVITY SETS, CONSTRUCTION TOYS, GAME TABLES, CHILDREN'S ACTIVITY TABLES CONTAINING MANIPULATIVE TOYS WHICH CONVERT TO EASELS, CUBE-TYPE, JIGSAW, AND MANIPULATIVE PUZZLES, DOLL COSTUMES, COSTUME MASKS, BATTERY-POWERED COMPUTER GAME WITH LCD SCREEN WHICH FEATURES ANIMATION AND SOUND EFFECTS, BOARD GAMES, ELECTRONIC EDUCATIONAL GAME MACHINES FOR CHILDREN, AND MANIPULATIVE GAMES (U.S. CLS. 22, 23, 38 AND 50).

CLASS 28—(Continued).

SN 76-211,460. FOSTER, ANTHONY, BROOKHAVEN, MS.
FILED 2-16-2001.



NO CLAIM IS MADE TO THE EXCLUSIVE RIGHT TO USE "GAME CALL CO.", APART FROM THE MARK AS SHOWN.

FOR GAME CALLS, NAMELY, DUCK CALLS, TURKEY CALLS, DEER CALLS, OWL CALLS, CROW CALLS, ELK CALLS, AND GOOSE CALLS (U.S. CLS. 22, 23, 38 AND 50).

FIRST USE 12-1-1995; IN COMMERCE 12-1-1995.

SN 76-216,445. YOTTOY PRODUCTIONS, INC., NEW YORK, NY. FILED 2-26-2001.

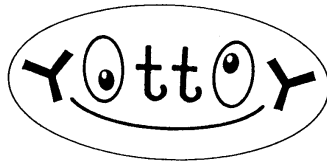

OWNER OF U.S. REG. NO. 2,283,845.
FOR PLUSH TOYS (U.S. CLS. 22, 23, 38 AND 50).
FIRST USE 1-30-2001; IN COMMERCE 1-30-2001.

SN 76-220,466. TRENDMASTERS, INC., ST. LOUIS, MO.
FILED 3-7-2001.

TRI-RAPA-CERATOPS

FOR REMOTE-CONTROLLED ROBOTIC TOY ANIMALS (U.S. CLS. 22, 23, 38 AND 50).
FIRST USE 11-9-2000; IN COMMERCE 4-26-2001.

SN 76-220,468. TRENDMASTERS, INC., ST. LOUIS, MO.
FILED 3-7-2001.

G-LOOP

FOR TOY VEHICLES, RACE TRACK SYSTEMS, NAMELY, TOY VEHICLE LAUNCHING RAMP, TOY VEHICLE LAUNCHING JUMPS, ACTION FIGURES, AND CARRYING CASES THEREFOR (U.S. CLS. 22, 23, 38 AND 50).

CLASS 28—(Continued).

SN 76-225,057. SOMMARS, ROBERT, ANAHEIM, CA. AND O'REILLY, HEATHER, ANAHEIM, CA. AND APELIAN, ERIC, ANAHEIM, CA. AND APELIAN, TANYA, ANAHEIM, CA. FILED 3-16-2001.

SICK STYLE

FOR SNOWBOARDS, SURFBOARDS, BODY BOARDS, WAKEBOARDS, SKIM BOARDS, SKATEBOARDS, SKIS, AND ATHLETIC PROTECTIVE PADS FOR SNOWBOARDING, SURFBOARDING, BODY BOARDING, WAKEBOARDING, SKIM BOARDING, SKATEBOARDING AND SKIING (U.S. CLS. 22, 23, 38 AND 50).
FIRST USE 12-14-1999; IN COMMERCE 12-14-1999.

SN 76-229,001. TILBOR MARKETING AND DEVELOPMENT, INC., NEW SMYRNA BEACH, FL. FILED 3-22-2001.



NO CLAIM IS MADE TO THE EXCLUSIVE RIGHT TO USE "FREESTYLE BMX", APART FROM THE MARK AS SHOWN.

FOR RADIO CONTROLLED TOY VEHICLES EXCLUDING CONSTRUCTION VEHICLES (U.S. CLS. 22, 23, 38 AND 50).

FIRST USE 1-1-2001; IN COMMERCE 1-1-2001.

SN 76-229,810. DICKIE WALKER MARINE, INC., LA JOLLA, CA. FILED 3-26-2001.



NO CLAIM IS MADE TO THE EXCLUSIVE RIGHT TO USE "BUILT 1951" AND "AUTHENTIC MARINE", APART FROM THE MARK AS SHOWN.

THE STIPPLING IN THE MARK IS FOR SHADING PURPOSES ONLY.

THE NAME "DICKIE WALKER" IS THE NAME OF A BOAT AND NOT THE NAME OF ANY KNOWN OR PARTICULAR LIVING INDIVIDUAL.

FOR TOYS AND SPORTING GOODS, NAMELY, MODEL BOATS AND VEHICLES, REPLICA BOATS AND VEHICLES, PLUSH TOYS, DOLLS, BOARD GAMES, CARD GAMES, KITES, SQUIRT GUNS, INFLATABLE TOYS, FISHING GEAR, NAMELY, RODS, REELS, LURES AND TACKLE (U.S. CLS. 22, 23, 38 AND 50).

CLASS 28—(Continued).

SN 76-231,998. ACCESS KIDDIE RIDES, INC., FARGO, ND. FILED 3-27-2001.



NO CLAIM IS MADE TO THE EXCLUSIVE RIGHT TO USE THE DESIGN OF THE HANDICAP SYMBOL, AND "RIDES", APART FROM THE MARK AS SHOWN.

FOR AMUSEMENT RIDES (U.S. CLS. 22, 23, 38 AND 50).

FIRST USE 3-19-2001; IN COMMERCE 3-19-2001.

SN 76-237,056. DISNEY ENTERPRISES, INC., BURBANK, CA. FILED 4-6-2001.

KIM POSSIBLE

FOR RUBBER BALLS; ACTION FIGURES AND ACCESSORIES; ACTION SKILL GAMES; BEAN BAG DOLLS; PLUSH TOYS; BALLOONS; GOLF BALLS; TENNIS BALLS; BATH TOYS; CHRISTMAS TREE ORNAMENTS; BOARD GAMES; EQUIPMENT SOLD AS A UNIT FOR PLAYING CARD GAMES; DOLLS AND DOLL CLOTHING; DOLL PLAYSETS; CHILDREN'S PLAY COSMETICS; CRIB TOYS; ELECTRIC ACTION TOYS; MANIPULATIVE GAMES; GOLF GLOVES; GOLF BALL MARKERS; JIGSAW PUZZLES; KITES; MOBILES; MUSIC BOX TOYS; PARTY FAVORS IN THE NATURE OF SMALL TOYS; INFLATABLE POOL TOYS; MULTIPLE ACTIVITY TOYS; WIND-UP TOYS; TARGET GAMES; DISC-TYPE TOSS TOYS; TOY BOWS AND ARROWS; TOY VEHICLES; TOY CARS; TOY TRUCKS; TOY BUCKET AND SHOVEL SETS; ROLLER SKATES; TOY MODEL HOBBYCRAFT KITS; TOY ROCKETTS; TOY GUNS; TOY HOLSTERS; MUSICAL TOYS; TOY BADMINTON SETS; BUBBLE MAKING WANDS AND SOLUTION SETS; TOY FIGURINES; TOY BANKS; PUPPETS; YO-YOS; SKATEBOARDS; TOY SCOOTERS; FACE MASKS; HAND-HELD ELECTRONIC GAMES; INFANT RATTLES; TOY BUILDING BLOCKS; CRIB MOBILES (U.S. CLS. 22, 23, 38 AND 50).

SN 76-256,346. SIMPLE WISHES, INC., STUDIO CITY, CA. FILED 5-14-2001.

HAPPY HAIR

FOR TOYS AND PLAYTHINGS, NAMELY, PLUSH TOYS, PLAY DOLLS, AND MINIATURE DOLLS (U.S. CLS. 22, 23, 38 AND 50).

CLASS 28—(Continued).

SN 76-273,518. YATES, JOYCE ANN, FAIRFAX, VA. FILED 6-19-2001.

BEARLY VICTORIAN

FOR COLLECTIBLE PLUSH TOY BEAR FIGURES AND OTHER PLUSH TOY ANIMAL FIGURES (U.S. CLS. 22, 23, 38 AND 50).

FIRST USE 5-0-1989; IN COMMERCE 4-0-1991.

SN 76-279,043. RAPID DISPLAYS, INC., CHICAGO, IL. FILED 7-2-2001.

IXL REVOLUTION

FOR CHILDREN'S BALL TOYS, NAMELY, TOY BALLS MADE OF FOAM AND PLASTIC WHICH CONTAIN A BALL BEARING TO MAKE A RATTLE SOUND WHEN TOUCHED OR MOVED (U.S. CLS. 22, 23, 38 AND 50).

SN 76-288,648. M.C.G. TEXTILES, INC., CHINO, CA. FILED 7-23-2001.

HERITAGE RUG HOOKING

NO CLAIM IS MADE TO THE EXCLUSIVE RIGHT TO USE "RUG HOOKING", APART FROM THE MARK AS SHOWN.

FOR HOBBY CRAFT KIT COMPRISING YARN, BURLAP AND INSTRUCTIONS ON THE ART OF RUG HOOKING (U.S. CLS. 22, 23, 38 AND 50).

FIRST USE 2-0-2001; IN COMMERCE 2-0-2001.

SN 76-294,066. SOMA, LLC, HONOLULU, HI. FILED 8-6-2001.

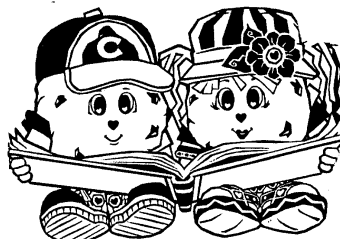

THE MARK CONSISTS OF TWO ANTHROPOMORPHIC CHOCOLATE CHIP COOKIES WEARING HATS AND SHOES AND HOLDING A BOOK.

FOR TOYS, NAMELY, STUFFED DOLLS, ACTION FIGURES, BOARD GAMES, PLAY HOUSES, PLAY SETS, MANIPULATIVE PUZZLES AND JIGSAW PUZZLES AND TOY OVENS (U.S. CLS. 22, 23, 38 AND 50).

CLASS 28—(Continued).

SN 76-297,794. WALTON, ROBERT, CINCINNATI, OH.
FILED 8-13-2001.

WRAPID

FOR FISHING TACKLE INCORPORATING A STRUCTURE FOR ATTACHING A LINE TO THE TACKLE WITHOUT HAVING TO TIE A KNOT (U.S. CLS. 22, 23, 38 AND 50).

SN 76-305,001. PLAYTIME VENTURES INC., LAKEVILLE, MA. FILED 8-27-2001.

MIRACLE GARDEN

FOR HOBBY CRAFT KITS CONTAINING CHEMICAL IMPREGNATED CUT-OUTS USED TO GROW CRYSTALLINE TREES, FLOWERS, PLANTS AND THE LIKE (U.S. CLS. 22, 23, 38 AND 50).

SN 76-305,002. PLAYTIME VENTURES INC., LAKEVILLE, MA. FILED 8-27-2001.

MIRACLE TREES

FOR HOBBY CRAFT KITS CONTAINING CHEMICAL IMPREGNATED CUT-OUTS USED TO GROW CRYSTALLINE TREES, FLOWERS, PLANTS AND THE LIKE (U.S. CLS. 22, 23, 38 AND 50).

SN 76-317,734. MAJOR LEAGUE BASEBALL PROPERTIES, INC., NEW YORK, NY. FILED 9-26-2001.

CHASING THE MARK

FOR TOYS AND SPORTING GOODS, NAMELY, STUFFED TOYS, PLUSH TOYS, BEAN BAG TOYS, BEAN BAGS, PUPPETS, BALLOONS, MARBLES, CHECKER SETS, CHESS SETS, BOARD GAMES, DART BOARDS AND DART BOARD ACCESSORIES, TOY CARS AND TRUCKS, TOY MOBILES, JIGSAW AND MANIPULATIVE PUZZLES, YO-YO'S, TOY BANKS, TOY FIGURES, DOLLS AND DOLL ACCESSORIES, INFLATABLE BASEBALL BATS, DECORATIVE WIND SOCKS, FLYING DISCS, MINIATURE BASEBALL BATS, TOY NECKLACES, MINIATURE TOY BASEBALLS, COIN-OPERATED PINBALL MACHINES, BASEBALLS, HOLDERS FOR BASEBALLS, AUTOGRAPHED BASEBALLS, BASKETBALLS, FOOTBALLS, PLAYGROUND BALLS, RUBBER ACTION BALLS, GOLF BALLS, GOLF CLUB COVERS, GOLF CLUB BAGS, GOLF PUTTERS, BOWLING BALLS, BOWLING BAGS, BASEBALL BASES, PITCHER'S PLATES, BASEBALL BATS, CATCHER'S MASKS, GRIP TAPE FOR BASEBALL BATS, BASEBALL BATTING TEES, PINE TAR BAGS FOR BASEBALL, ROSIN BAGS FOR BASEBALL, BASEBALL GLOVE OIL, BATTING GLOVES, BASEBALL GLOVES, MITTS, UMPIRE'S PROTECTIVE EQUIPMENT, CHEST PROTECTORS FOR SPORTS, ATHLETIC SUPPORTERS, BASEBALL PITCHING MACHINES, FISHING TACKLE, SWIM FLOATS FOR RECREATIONAL USE, PARTY FAVORS IN THE NATURE OF NOISE MAKERS, AND CHRISTMAS TREE ORNAMENTS (U.S. CLS. 22, 23, 38 AND 50).

CLASS 28—(Continued).

SN 76-320,256. WHAM-O, INC., SAN FRANCISCO, CA.
FILED 10-1-2001.

TROPICAL LIMBO

FOR WATERSLIDES (U.S. CLS. 22, 23, 38 AND 50).

SN 76-320,395. WAGENBUCHLER, OSCAR, BELLMORE, NY. FILED 10-3-2001.

BODEGA

FOR SPORTING GOODS, NAMELY, SKATEBOARDS AND SKATEBOARD WHEELS (U.S. CLS. 22, 23, 38 AND 50).

FIRST USE 10-1-1996; IN COMMERCE 1-0-1997.

SN 76-320,890. SHELCORE, INC., SOMERSET, NJ. FILED 10-3-2001.

JUMP ALONG

FOR BATTERY-OPERATED ACTION TOYS (U.S. CLS. 22, 23, 38 AND 50).

SN 76-325,545. REGARDING PLAY INC., PROVIDENCE, RI.
FILED 10-16-2001.

Z-KEEZ

FOR SPINNING ACTION TOYS (U.S. CLS. 22, 23, 38 AND 50).

SN 76-330,751. MISSION CITY PRESS, INC., SAN ANTONIO, TX. FILED 10-29-2001.

VIOLET TRAVILLA

THE NAME "VIOLET TRAVILLA" DOES NOT IDENTIFY A LIVING INDIVIDUAL.
FOR DOLL, DOLL CLOTHING AND DOLL ACCESSORIES (U.S. CLS. 22, 23, 38 AND 50).

CLASS 28—(Continued).

SN 76-331,787. X CONCEPTS, LLC, ESCONDIDO, CA. FILED 10-29-2001.

DIRT PILOT

FOR TOYS, NAMELY, ACTION FIGURES, MINIATURE TOY FIGURES, MINIATURE TOY STATUETTES, AND PLAY SETS FOR USE WITH SUCH FIGURES AND STATUETTES, NAMELY, MINIATURE TOY CLOTHING, MINIATURE TOY BUILDINGS AND MINIATURE TOY STRUCTURES, MINIATURE TOY VEHICLES, NAMELY, MINIATURE SKATEBOARDS, MINIATURE SNOWBOARDS, MINIATURE SURFBOARDS, MINIATURE SNOW SKIS, MINIATURE WAKE BOARDS, MINIATURE SKIM BOARDS, MINIATURE BODY BOARDS, MINIATURE JET SKIS, MINIATURE RECREATIONAL WATERCRAFT, MINIATURE CARS, MINIATURE TRUCKS, MINIATURE MOTORCYCLES, MINIATURE BICYCLES, MINIATURE OFF-ROAD VEHICLES, AND ACCESSORIES FOR MINIATURE TOY VEHICLES, NAMELY, PLAY SETS FOR USE WITH MINIATURE BUILDINGS, MINIATURE STRUCTURES, MINIATURE TOOLS AND MINIATURE HARDWARE FOR USE WITH THE MINIATURE TOY VEHICLES, AND CARRYING CASES FOR TOY STRUCTURES AND TOY VEHICLES; SPORTING GOODS, NAMELY, SKATEBOARDS, SNOWBOARDS, SNOW SKIS, WAKE BOARDS, SKIM BOARDS, BODY BOARDS AND ACCESSORIES THEREFOR, NAMELY, SKATEBOARD WHEELS, SKATEBOARD TRUCKS, SKATEBOARD BOARDS; SKATEBOARDING PROTECTIVE GEAR, NAMELY, SKATEBOARDING WRIST GUARDS, SKATEBOARDING ELBOW PADS, SKATEBOARDING KNEE PADS, AND SKATEBOARDING SHIN GUARDS; SNOWBOARDING BINDINGS; SNOWBOARDING PROTECTIVE GEAR, NAMELY, SNOWBOARDING WRIST GUARDS, SNOWBOARDING ELBOW PADS, SNOWBOARDING GOGGLES, SNOWBOARDING KNEE PADS, AND SNOWBOARDING SHIN PADS; SNOW SKI BINDINGS (U.S. CLS. 22, 23, 38 AND 50).

SN 76-333,088. MACGREGOR GOLF COMPANY, ALBANY, GA. FILED 11-2-2001.

LFF

FOR GOLF CLUBS (U.S. CLS. 22, 23, 38 AND 50).

SN 76-333,698. SONA, SUSAN, FREEHOLD, NJ. FILED 11-5-2001.

CHEESE BALL

FOR TOY IN THE FORM OF A PLUSH, STUFFED FANCIFUL ANIMAL (U.S. CLS. 22, 23, 38 AND 50).
FIRST USE 8-15-2001; IN COMMERCE 8-15-2001.

SN 76-334,458. ORR, ROBERT, SANTA FE SPRINGS, CA. FILED 11-7-2001.

WORRPAINT

FOR PAINTBALLS (U.S. CLS. 22, 23, 38 AND 50).
FIRST USE 10-25-2000; IN COMMERCE 10-25-2000.

CLASS 28—(Continued).

SN 76-334,535. HYPERWARE, INC., SAN JOSE, CA. FILED 11-5-2001.

ULTRACADE

FOR INTERACTIVE STAND-ALONE ARCADE ENTERTAINMENT SYSTEM CONSISTING OF A COMPUTER-OPERATED CONSOLE WITH USER-INPUT DEVICES, DESIGNED FOR EXECUTING MULTIPLE INTERACTIVE ENTERTAINMENT SOFTWARE PROGRAMS AND ALLOWING FOR USER SELECTION OF PROGRAMS AND FURTHER ALLOWING UNLIMITED FUTURE ADDITION OF NEW PROGRAMS (U.S. CLS. 22, 23, 38 AND 50).

FIRST USE 1-12-2001; IN COMMERCE 1-12-2001.

SN 76-334,788. M & C TOY CENTRE LIMITED, TSIMSHAT-SUI EAST, KOWLOON, HONG KONG, FILED 11-5-2001.

SWAMP PYTHON

FOR TOYS FIGURES, DOLLS, TOY GUNS, TOY ARMOUR, TOY WEAPONS, TOY SUBMARINE, TOY VEHICLES, DOLL COSTUMES, INFLATABLE TOY RAFTS, TOY WALKIE TALKIES, TOY SWORDS, TOY BINOCULARS, TOY DAGGER; THREE-DIMENSIONAL PLAYSETS DEPICTING SCENES AND SCENERY; PLAYSETS COMPRISING ONE OR MORE OF THE FOREGOING ITEMS (U.S. CLS. 22, 23, 38 AND 50).

SN 76-334,789. M & C TOY CENTRE LIMITED, TSIMSHAT-SUI EAST, KOWLOON, HONG KONG, FILED 11-5-2001.

NIGHT OWL

FOR TOYS FIGURES, DOLLS, TOY GUNS, TOY ARMOUR, TOY WEAPONS, TOY SUBMARINE, TOY VEHICLES, DOLL COSTUMES, INFLATABLE TOY RAFTS, TOY WALKIE TALKIES, TOY SWORDS, TOY BINOCULARS, TOY DAGGER; THREE-DIMENSIONAL PLAYSETS DEPICTING SCENES AND SCENERY; PLAYSETS COMPRISING ONE OR MORE OF THE FOREGOING ITEMS (U.S. CLS. 22, 23, 38 AND 50).

SN 76-335,494. TOBIAS, STEWART W., PALMETTO, FL. FILED 11-8-2001.

BODYSIZER

FOR MANUALLY OPERATED EXERCISE EQUIPMENT FOR USE BY AN INDIVIDUAL DURING SIT-UPS (U.S. CLS. 22, 23, 38 AND 50).
FIRST USE 9-5-2000; IN COMMERCE 9-5-2000.

CLASS 28—(Continued).

SN 76-335,745. ROYAL PRECISION, INC., TORRINGTON, CT. FILED 11-9-2001.

PROJECT X

FOR GOLF CLUB SHAFTS (U.S. CLS. 22, 23, 38 AND 50).

SN 76-337,226. VIERA, ANTHONY A., DARTMOUTH, MA. FILED 11-15-2001.

MOBY DICK

FOR GOLF CLUBS (U.S. CLS. 22, 23, 38 AND 50).

SN 76-337,713. MONTGOMERY ZUCKERMAN DAVIS, INC., INDIANAPOLIS, IN. FILED 11-13-2001.

ATMBINGO

FOR BINGO GAME (U.S. CLS. 22, 23, 38 AND 50).

SN 76-338,028. MOOSE MOUNTAIN TOYMAKERS LTD., KOWLOON, HONG KONG, FILED 11-14-2001.

DISCO MAGIC

FOR TOYS, NAMELY TOY JEWELRY BOXES (U.S. CLS. 22, 23, 38 AND 50).

SN 76-338,030. MOOSE MOUNTAIN TOYMAKERS LTD., KOWLOON, HONG KONG, FILED 11-14-2001.

CRYSTAL MAGIC

FOR TOYS, NAMELY TOY JEWELRY BOXES (U.S. CLS. 22, 23, 38 AND 50).

SN 76-338,602. METALCRAFT ENTERPRISES, INC., NEW HAVEN, MO. FILED 11-16-2001.

CADDY STICK

FOR PORTABLE SUPPORT STANDS FOR GOLF CLUBS (U.S. CLS. 22, 23, 38 AND 50).

CLASS 28—(Continued).

SN 76-338,749. RACING CHAMPIONS ERTL, INC., DYERSVILLE, ID. FILED 11-19-2001.

JOYRIDE STUDIOS

NO CLAIM IS MADE TO THE EXCLUSIVE RIGHT TO USE "STUDIOS", APART FROM THE MARK AS SHOWN. FOR PLASTIC AND DIE CAST TOYS AND COLLECTIBLES, NAMELY VEHICLES AND FIGURES IN INTERNATIONAL (U.S. CLS. 22, 23, 38 AND 50).

SN 76-340,322. MAURICE SPORTING GOODS, INC., NORTHBROOK, IL. FILED 11-21-2001.



FOR FISHING EQUIPMENT, NAMELY, RODS, REELS, AND TACKLE (U.S. CLS. 22, 23, 38 AND 50).

SN 76-341,607. KUNCZ, FERENC, MIAMI, FL. FILED 11-23-2001.

POWER-ACTIVE-AREA

FOR RACKETS, NAMELY, TENNIS, RACQUETBALL AND SQUASH (U.S. CLS. 22, 23, 38 AND 50).

SN 76-342,257. ACTION CENTERED TRAINING, INC., EAGLEVILLE, PA. FILED 11-27-2001.

GIVE & TAKE

FOR BOARD GAMES (U.S. CLS. 22, 23, 38 AND 50).

SN 76-342,758. JAKKS PACIFIC, INC., MALIBU, CA. FILED 11-29-2001.

ROOKSIE ROAR

FOR TOYS, NAMELY STUFFED TOYS AND PLUSH TOYS (U.S. CLS. 22, 23, 38 AND 50).

CLASS 28—(Continued).

SN 76-342,760. JAKKS PACIFIC, INC., MALIBU, CA. FILED 11-29-2001.

STACERS G. BAAH

FOR TOYS, NAMELY STUFFED TOYS AND PLUSH TOYS (U.S. CLS. 22, 23, 38 AND 50).

SN 76-342,761. JAKKS PACIFIC, INC., MALIBU, CA. FILED 11-29-2001.

STAACKS LAMBY

FOR TOYS, NAMELY STUFFED TOYS AND PLUSH TOYS (U.S. CLS. 22, 23, 38 AND 50).

SN 78-051,404. ESCAPEZE FASHIONS, INC., SUN CITY WEST, AZ. FILED 3-5-2001.

TESTTEES

FOR NOVELTY ITEM IN THE NATURE OF PACKAGED GOLF TEES TO BE SOLD IN NOVELTY, GIFT, AND GOLF SHOPS (U.S. CLS. 22, 23, 38 AND 50).

SN 78-065,361. WORLD WRESTLING FEDERATION ENTERTAINMENT, INC., STAMFORD, CT. FILED 5-23-2001.

CHYNA

FOR TOY ACTION FIGURES, BENDABLE TOYS, BEAN BAG BEARS, BOWLING BALLS, POOL CUES (U.S. CLS. 22, 23, 38 AND 50).
FIRST USE 2-1-1998; IN COMMERCE 2-1-1998.

SN 78-071,330. DEBRA D. GOLDSTEIN AND YANULA BLACY PARTNERSHIP, THE, ASPEN, CO. FILED 6-27-2001.

BOOBIE BOOSTER

NO CLAIM IS MADE TO THE EXCLUSIVE RIGHT TO USE "BOOBIE", APART FROM THE MARK AS SHOWN.
FOR EXERCISE EQUIPMENT, NAMELY, A HAND HELD MANUAL EXERCISE DEVICE FOR USE IN BUST DEVELOPMENT (U.S. CLS. 22, 23, 38 AND 50).

CLASS 28—(Continued).

SN 78-081,400. ART ASYLUM, INC, THE, BROOKLYN, NY. FILED 8-28-2001.

MINIMATES

FOR COLLECTIBLE TOY FIGURES, DOLLS, DOLL ACCESSORIES, STUFFED TOYS AND PLUSH TOYS (U.S. CLS. 22, 23, 38 AND 50).

SN 78-086,830. KORN, CHRISTOPHER J., DBA PORTER-LINE, SAN DIEGO, CA. FILED 10-4-2001.

SKYPORTER

FOR GOLF BAG (U.S. CLS. 22, 23, 38 AND 50).
FIRST USE 10-3-2001; IN COMMERCE 10-3-2001.

SN 78-098,184. WRISTRIPPER, INC., RENO, NV. FILED 12-13-2001.

WRISTRIPPER

FOR EXERCISE WRIST WEIGHTS (U.S. CLS. 22, 23, 38 AND 50).

CLASS 29—MEATS AND PROCESSED FOODS

SN 73-473,197. FOUQUET, 75009 PARIS, FRANCE, FILED 4-2-1984.

FOUQUET

OWNER OF FRANCE REG. NO. 000001244928, DATED 9-13-1983, RENEWED AS REG. NO. 1244928, DATED 9-8-1993, EXPIRES 9-8-2003.

FOR PRESERVED VEGETABLES AND FRUIT, EDIBLE OILS, JELLIES, AND JAMS, SAUCES, AND FRUIT AND VEGETABLE PUREE SOLD ONLY THROUGH APPLICANT'S OWN RETAIL SHOPS, OR SHOPS OWNED, OPERATED, MANAGED OR CONTROLLED BY COMPANIES OR PRESENT OR FUTURE LICENSEES OF THE APPLICANT, OR TO WHICH APPLICANT OR ITS RELATED COMPANIES, INCLUDING FOUQUET DIFFUSION SARL, HAVE GRANTED A TRADEMARK LICENSE, AS WELL AS THROUGH SALES OUTLETS OF CHOCOLATE, CONFECTIONERY AND PASTRY SCHOOLS, WHOLESALE AND RETAIL FOOD OUTLETS, GIFT SHOPS, AND/OR DEPARTMENT STORES WHICH SELL SPECIALTY FOODS (U.S. CL. 46).

CLASS 29—(Continued).

SN 74-673,246. ICY WATERS INTERNATIONAL INC., YUKON, CANADA, FILED 5-10-1995.

NORTHERN SPIRIT

PRIORITY CLAIMED UNDER SEC. 44(D) ON CANADA APPLICATION NO. 778729, FILED 3-27-1995, REG. NO. TMA492920, DATED 4-15-1998, EXPIRES 4-15-2013.
FOR FISH AND SEAFOOD (U.S. CL. 46).

SN 75-538,770. MERALIM II, 44300 NANTES, FRANCE, FILED 8-18-1998.

OCILIA

PRIORITY CLAIMED UNDER SEC. 44(D) ON FRANCE APPLICATION NO. 97/708945, FILED 5-7-1998, REG. NO. 97/708945, DATED 5-7-1998, EXPIRES 5-7-2008.

FOR SEA OR RIVER SEAFOOD, NAMELY FISH, NON-LIVING SHELLFISH; AND PREPARED FRESH, PREPARED SEMI-FRESH, FROZEN, AND CANNED MEALS CONSISTING PRIMARILY OF FISH, CANNED TUNA FISH (U.S. CL. 46).

SN 75-631,693. OLIVIERS & CO, 04300 MANE, FRANCE, FILED S.R. 1-27-1999; AM. P.R. 9-17-2001.

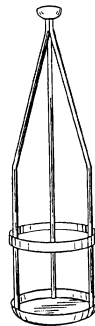

PRIORITY CLAIMED UNDER SEC. 44(D) ON FRANCE APPLICATION NO. 98/743338, FILED 7-27-1998, REG. NO. 98/743338, DATED 7-27-1998, EXPIRES 7-27-2008.

THE MARK CONSISTS OF A CONFIGURATION IN THE SHAPE OF A BOTTLE WITH THREE POSTS WHICH RUN ALONG THE OUTSIDE OF THE CONFIGURATION. THE THREE POSTS RISE STRAIGHT UP FROM THE BOTTOM SIDES OF THE CONFIGURATION ABOUT EQUIDISTANT APART. THE THREE POSTS BEGIN TO BEND INWARD ABOUT HALF WAY UP THE CONFIGURATION AND COME TOGETHER AT THE TOP OF FIGURE. THERE IS A LITTLE NUB ON TOP WHERE THE THREE POSTS CONVERGE. THE THREE POSTS ARE LINKED BY A CIRCULAR BAND ON THE LOWER PORTION OF THE CONFIGURATION.

SEC. 2(F).

FOR OLIVE OIL (U.S. CL. 46).

CLASS 29—(Continued).

SN 75-844,630. KONSORTIUM FUR DIE FORDERUNG DES SUDTIROLER MARKENSPECKS, 39100 BOLZANO, ITALY, FILED 11-8-1999.



OWNER OF ERPN CMNTY TM OFC REG. NO. 000765305, DATED 7-21-1999, EXPIRES 3-6-2008.

THE MARK CONSISTS OF THE REPRESENTATION OF A BOW-TYPE BAND WITH EMBROIDERED ZIG-ZAG EDGES, WHEREIN THE BAND HAS A CIRCULAR AREA IN THE CENTER, WHEREIN THE CENTER REGION OF THE BAND IS ENLARGED LENS-SHAPED, AND WHEREIN IN EACH CASE TWO STYLIZED ACORNS ARE REPRESENTED ALONG THE HORIZONTAL CENTER LINE ON THE RIGHT SIDE AND ON THE RIGHT SIDE AND ON THE LEFT SIDE OF THE CIRCULAR CENTER AREA.

FOR MEAT, NAMELY, SMOKED MEAT, BACON, PORK AND CHARCUTERIE (U.S. CL. 46).

SN 75-864,107. GEORGES BRUCK, STRASBOURG, FRANCE, FILED 12-3-1999.

GEORGES BRUCK

OWNER OF FRANCE REG. NO. 1405786, DATED 8-21-2000, EXPIRES 8-21-2010.

THE NAME SHOWN IN THE MARK DOES NOT IDENTIFY A PARTICULAR LIVING INDIVIDUAL.

FOR GOOSE OR DUCK WHOLE LIVERS, LOBES OF LIVER, AGGLOMERATED PIECES OF LOBES OF LIVER, BLOCKS OF LIVER, PARFAIT OF LIVER, MEDALLIONS AND PATES OF GOOSE AND DUCK LIVER; MOUSSE OR PUREE OF GOOSE OR DUCK LIVER, TERRINES OF LIVER, TERRINE PATES, GAME AND FOWL PATES AS WELL AS ALL CANNED PATES, PROCESSED GOOSE LIVER OR DUCK LIVER, CANNED GOOSE AND DUCK LIVER, MEAT, FISH, FOWL AND GAME, MEAT EXTRACTS; PRESERVED, MUSHROOMS; PRESERVED TRUFFLES (U.S. CL. 46).

FIRST USE 0-0-1924; IN COMMERCE 0-0-1924.

SN 76-020,824. WINNEMUCCA FARMS, INC., WINNEMUCCA, NV. FILED 3-3-2000.

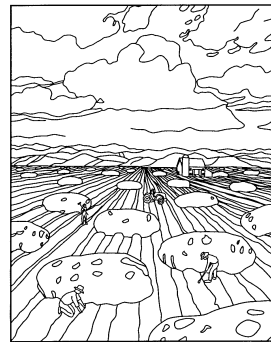

FOR PROCESSED POTATOES (U.S. CL. 46).
FIRST USE 0-0-1994; IN COMMERCE 0-0-1994.

CLASS 29—(Continued).

SN 76-098,839. PACIFIC SALMON INDUSTRIES INC., BRITISH COLUMBIA V3W 4G1, CANADA, FILED 7-27-2000.



PRIORITY CLAIMED UNDER SEC. 44(D) ON CANADA APPLICATION NO. 1045439, FILED 2-4-2000.

NO CLAIM IS MADE TO THE EXCLUSIVE RIGHT TO USE "GOURMET", APART FROM THE MARK AS SHOWN.

THE LINING SHOWN IN THE DRAWING IS A FEATURE OF THE MARK AND IS NOT INTENDED TO INDICATE COLOR.

FOR FRESH, FROZEN, SMOKED, DRIED AND COOKED FISH AND SEAFOOD; FROZEN PREPARED MEALS CONSISTING PRIMARILY OF MEATS, FISH, SEAFOOD, POULTRY, AND VEGETABLES (U.S. CL. 46).

FIRST USE 5-0-1999; IN COMMERCE 5-0-1999.

SN 76-098,840. PACIFIC SALMON INDUSTRIES INC., BRITISH COLUMBIA V3W 4G1, CANADA, FILED 7-27-2000.



PRIORITY CLAIMED UNDER SEC. 44(D) ON CANADA APPLICATION NO. 1045438, FILED 2-4-2000.

NO CLAIM IS MADE TO THE EXCLUSIVE RIGHT TO USE "GOURMET", APART FROM THE MARK AS SHOWN.

THE LINING SHOWN IN THE DRAWING IS A FEATURE OF THE MARK AND IS NOT INTENDED TO INDICATE COLOR.

FOR FRESH, FROZEN, SMOKED, DRIED AND COOKED FISH AND SEAFOOD; FROZEN PREPARED MEALS CONSISTING PRIMARILY OF MEATS, FISH, SEAFOOD, POULTRY, AND VEGETABLES (U.S. CL. 46).

FIRST USE 9-0-1999; IN COMMERCE 9-0-1999.

SN 76-124,917. NEW ENGLAND CRAB COMPANY, INC., BOSTON, MA. FILED 9-7-2000.

STONIES

FOR FROZEN COOKED CRABMEAT, NAMELY CRAB CLAWS AND CRAB ARMS (U.S. CL. 46).

CLASS 29—(Continued).

SN 76-136,154. TNUVA CENTRAL COOPERATIVE FOR THE MARKETING OF AGRICULTURAL PRODUCE IN ISRAEL LTD., RAMAT HASHARON 47100, ISRAEL, FILED 9-27-2000.

GILBOA

PRIORITY CLAIMED UNDER SEC. 44(D) ON ISRAEL APPLICATION NO. 139121, FILED 6-25-2000, REG. NO. 139121, DATED 9-4-2001, EXPIRES 6-25-2007.

FOR MILK, HARD CHEESE, SEMI HARD CHEESE, PROCESSED CHEESE, SOFT CHEESE, AND SOFT RIPENED CHEESE MADE OF COW'S MILK, GOAT'S MILK AND SHEEP'S MILK (U.S. CL. 46).

SN 76-138,224. EAGLE FAMILY FOODS, INC., TARRYTOWN, NY. FILED 9-29-2000.

CREMORA ROYALE

OWNER OF U.S. REG. NO. 1,410,798. THE ENGLISH TRANSLATION OF "ROYALE" IS "ROYAL".

FOR NON-DAIRY CREAMER (U.S. CL. 46). FIRST USE 8-0-1998; IN COMMERCE 8-0-1998.

SN 76-158,973. YOFARM COMPANY, THE, NAUGATUCK, CT. FILED 11-3-2000.



OWNER OF U.S. REG. NO. 1,501,492. THE STIPPLING SHOWN IN THE DRAWING IS A FEATURE OF THE MARK AND IS NOT INTENDED TO INDICATE COLOR.

FOR YOGURT (U.S. CL. 46). FIRST USE 7-0-1997; IN COMMERCE 7-0-1997.

SN 76-188,115. YERGAT PACKING CO., INC., FRESNO, CA. FILED 1-2-2001.

YERGAT

SEC. 2(F). FOR PROCESSED GRAPE LEAVES (U.S. CL. 46). FIRST USE 0-0-1945; IN COMMERCE 0-0-1945.

CLASS 29—(Continued).

SN 76-196,404. GROVE, INC., THE, NEW ORLEANS, LA.
FILED 1-19-2001.



NO CLAIM IS MADE TO THE EXCLUSIVE RIGHT TO USE "NATURAL SNACKS", APART FROM THE MARK AS SHOWN.

FOR CANDIED FRUITS (U.S. CL. 46).
FIRST USE 1-3-1980; IN COMMERCE 11-30-1982.

SN 76-196,688. GROVE, INC., THE, NEW ORLEANS, LA.
FILED 1-19-2001.



NO CLAIM IS MADE TO THE EXCLUSIVE RIGHT TO USE "NATURAL SNACKS", APART FROM THE MARK AS SHOWN.

FOR DRIED FRUITS AND PROCESSED NUTS (U.S. CL. 46).
FIRST USE 1-3-1980; IN COMMERCE 11-30-1982.

SN 76-205,835. HOTTIE CORPORATION, SALT LAKE CITY,
UT. FILED 1-23-2001.

HOTTIE

FOR FRUITS, NAMELY, APPLESAUCE, BANANA CHIPS, CANDIED FRUIT, CANDIED FRUIT SNACKS, CANNED, DRIED AND FROZEN FRUITS, FRUIT CHIPS, FRUIT LEATHERS, FRUIT PRESERVES, FRUIT SALADS, FRUIT SAUCES, FRUIT TOPPING, FRUIT-BASED FILLING FOR CAKES AND PIES, FRUIT-BASED SNACK FOOD, JAMS, JELLIES, MARASCHINO CHERRIES, MARMALADE, PROCESSED FRUITS IN GENERAL, RAISINS, SLICED FRUITS THAT ARE BOTTLED, CANNED AND FRESH; BERRIES, NAMELY, CRANBERRY SAUCE, PROCESSED BERRIES IN GENERAL; NUTS, NAMELY, CANDIED NUTS, NUT BUTTERS IN GENERAL, NUT TOPPING, ROASTED, SHELLED AND OTHERWISE PROCESSED NUTS; SEEDS, NAMELY, PROCESSED EDIBLE SEEDS; VEGETABLES, NAMELY, BAKED BEANS, BEAN DIP, COLESLAW, DRIED VEGETABLES, FRENCH FRIED POTATOES, GARDEN SALADS, GUACAMOLE, INSTANT POTATOES, ONION RINGS, PEANUT BUTTER, PICKLES, POTATO CHIPS, POTATO-BASED SNACK FOODS, PRECUT VEGETABLE SALADS, PROCESSED VEGETABLES IN GENERAL,

CLASS 29—(Continued).

REFRIED BEANS, SALADS EXCEPT MACARONI, PASTA AND RICE SALAD, SLICED VEGETABLES THAT ARE BOTTLED, CANNED AND FRESH, VEGETABLE SALADS, VEGETABLE-BASED FOOD BEVERAGES; DAIRY GOODS, NAMELY, BUTTER, BUTTER SUBSTITUTES, CHEESE AND CRACKER COMBINATIONS, CHEESE IN GENERAL, CHEESE SPREADS, CHEESE SUBSTITUTES, COTTAGE CHEESE, CREAM CHEESE, DAIRY AND NON-DAIRY BASED WHIPPED TOPPING, DAIRY PRODUCTS EXCLUDING FROZEN YOGURT, ICE CREAM AND ICE MILK, DAIRY-BASED BEVERAGES, DAIRY-BASED DIPS, EGGNOG, EGGNOG MIXES, HALF AND HALF MILK AND CREAM MIXTURE, MARGARINE, MARGARINE SUBSTITUTES, MILK, MILK-BASED BEVERAGE CONTAINING COFFEE, NON-DAIRY CREAMER, SOUR CREAM, SOUR CREAM SUBSTITUTES, SOY-BASED BEVERAGE USED AS A MILK SUBSTITUTE, WHIPPING CREAM, YOGURT, YOGURT-BASED BEVERAGES; EGGS, NAMELY, EGG SUBSTITUTE, EGGS, POWDERED EGGS; MEATS, NAMELY, FISH IN GENERAL, JERKY, MEAT, MEAT SUBSTITUTES, PORK RINDS, POULTRY IN GENERAL, SEAFOOD IN GENERAL, SHELLFISH IN GENERAL, VEGETABLE PROTEIN BITS HAVING A BACON FLAVOR; MISCELLANEOUS PROCESSED FOODS, NAMELY, CANNED PORK AND BEANS, CHILI WITH AND WITHOUT BEANS, CHOP SUEY, CHOW MEIN BEING FISH, MEAT AND VEGETABLE BASED, CHOWDER, ENTREES CONSISTING PRIMARILY OF FISH, MEAT, POULTRY OR VEGETABLES BEING FROZEN, PACKAGED OR PREPARED, FLAKED COCONUT, FOOD PACKAGE COMBINATIONS CONSISTING PRIMARILY OF CHEESE, MEAT AND/OR PROCESSED FRUIT, PRESERVED TRUFFLES, PROCESSED COCONUT, SNACK DIPS EXCLUDING SALSA AND OTHER SAUCES USED AS DIPS, SNACK MIX CONSISTING PRIMARILY OF PROCESSED FRUITS, PROCESSED NUTS AND/OR RAISINS, SOUP MIXES, SOUPS, STEWS, TOFU; OIL AND SHORTENING, NAMELY, COOKING OIL, EDIBLE OIL, SALAD OIL, SHORTENING, VEGETABLE OIL (U.S. CL. 46).

FIRST USE 3-0-1994; IN COMMERCE 3-0-1994.

SN 76-210,789. DARDEN CORPORATION, ORLANDO, FL.
FILED 2-15-2001.

LOBSTERCHOPS

FOR COOKED ENTREE DISH CONSISTING PRIMARILY OF SEAFOOD FOR CONSUMPTION ON OR OFF THE PREMISES (U.S. CL. 46).

FIRST USE 2-26-2001; IN COMMERCE 2-26-2001.

CLASS 29—(Continued).

SN 76-223,395. AGUADO-SANCHEZ, JACINTO, TOLEDO, SPAIN, FILED 3-12-2001.



THE WORD "AGUADO" IS THE FAMILY NAME, AND IT CAN BE TRANSLATED AS "WATERY".
FOR OLIVE OILS, VEGETABLE OILS, COOKING OILS AND EDIBLE FATS (U.S. CL. 46).
FIRST USE 3-10-2001; IN COMMERCE 3-10-2001.

SN 76-223,643. PIG'S LEAP FARMS OF IOWA, DES MOINES, IA. FILED 3-6-2001.



NO CLAIM IS MADE TO THE EXCLUSIVE RIGHT TO USE "FARMS OF IOWA" AND "ARTISAN CURED MEAT", APART FROM THE MARK AS SHOWN.

FOR CURED MEATS; DRY-CURED HAM; PROSCIUTTO; CULATELLO; PANCETTA; BACON; COPPA; SPALLA; SALAMI (U.S. CL. 46).

SN 76-225,531. LIDL STIFTUNG & CO. KG, 74172 NECK-ARSULM, FED REP GERMANY, FILED 3-16-2001.

PIC-FRISCH

OWNER OF FED REP GERMANY REG. NO. 39640568, DATED 10-23-1996, EXPIRES 9-30-2006.

FOR DAIRY PRODUCTS, NAMELY, CHEESE, CURD, CREAM, BUTTER YOGURT, MILK (U.S. CL. 46).

CLASS 29—(Continued).

SN 76-237,504. LIDL STIFTUNG & CO. KG, 74172 NECK-ARSULM, FED REP GERMANY, FILED 4-9-2001.

REALVALLE

OWNER OF FED REP GERMANY REG. NO. 39733753, DATED 9-17-1997, EXPIRES 7-31-2007.

FOR MILK AND DAIRY PRODUCTS EXCLUDING ICE CREAM, ICE MILK AND FROZEN YOGURT (U.S. CL. 46).

SN 76-286,810. TOWEY, STEVEN G., MISSION VIEJO, CA. FILED 7-18-2001.

LEGENDBERRY

FOR CANDIED FRUIT (U.S. CL. 46).
FIRST USE 4-24-1999; IN COMMERCE 4-24-1999.

SN 76-294,937. HANS ROTHENBUHLER & SON, INC., MIDDLEFIELD, OH. FILED 8-3-2001.

JUNGFRAU

THE ENGLISH TRANSLATION OF "JUNGFRAU" IS "VIRGIN" OR "YOUNG LADY".
FOR CHEESE (U.S. CL. 46).

SN 76-298,698. WILBUR CHOCOLATE CO., INC., LITITZ, PA. FILED 8-10-2001.

NUT-NOTS

FOR SYNTHETIC NUT MEATS (U.S. CL. 46).
FIRST USE 8-6-2001; IN COMMERCE 8-6-2001.

SN 76-310,754. R & M REFRIGERATED, INC., MIAMI, FL. FILED 9-8-2001.



FOR CANNED FRUITS AND VEGETABLES (U.S. CL. 46).

CLASS 29—(Continued).

SN 76-345,867. CASTELLI DEL GREVEPESA CANTINA SOCIALE SOC.COOP.A.R.L., FIRENZE, ITALY, FILED 12-6-2001.

AURENTO

FOR OLIVE OIL, EXTRA VIRGIN OLIVE OIL (U.S. CL. 46).

SN 78-049,136. SUIZA DAIRY GROUP, L.P., DALLAS, TX. FILED 2-19-2001.

CHEESE 'N STUFF

NO CLAIM IS MADE TO THE EXCLUSIVE RIGHT TO USE "CHEESE", APART FROM THE MARK AS SHOWN.
FOR COTTAGE CHEESE FLAVORED WITH FRUIT AND/OR VEGETABLES (U.S. CL. 46).
FIRST USE 1-1-2001; IN COMMERCE 1-1-2001.

SN 78-096,715. SWISS AMERICAN IMPORTERS COMPANY, ST. LOUIS, MO. FILED 12-5-2001.

JACKBY

FOR CHEESE (U.S. CL. 46).
FIRST USE 12-12-1988; IN COMMERCE 12-12-1988.

CLASS 30—STAPLE FOODS

SN 75-726,472. RENE REY SWISS CHOCOLATES LTD., NORTH VANCOUVER, BC V7P 1J9, CANADA, FILED 6-10-1999.



PRIORITY CLAIMED UNDER SEC. 44(D) ON CANADA APPLICATION NO. 1,000,309, FILED 1-6-1999, REG. NO. TMA525599, DATED 3-23-2000, EXPIRES 3-23-2015.

THE STIPPLING IS A FEATURE OF THE MARK. THE LINING IS A FEATURE OF THE MARK.

THE MARK CONSISTS OF A SUN, STARS, A MOON, A LANDSCAPE WITH ONE LARGE TREE AND A PERSON.

FOR CONFECTIONERY PRODUCTS, NAMELY CHOCOLATES (U.S. CL. 46).

FIRST USE 10-25-1999; IN COMMERCE 10-25-1999.

CLASS 30—(Continued).

SN 75-813,309. MANOUCHER FINE FOODS INC., TORONTO, ONTARIO, CANADA, FILED 10-1-1999.

SUMMER DREAMS

PRIORITY CLAIMED UNDER SEC. 44(D) ON CANADA APPLICATION NO. 1025976, FILED 8-13-1999.
FOR BREAD (U.S. CL. 46).
FIRST USE 12-0-1998; IN COMMERCE 12-0-1998.

SN 75-901,488. SOFIAFOODS, A DIVISION OF WHITE HOUSE RESTAURANT & BAR, INC., DECATUR, IL. FILED 1-24-2000.



NO CLAIM IS MADE TO THE EXCLUSIVE RIGHT TO USE "FOODS", APART FROM THE MARK AS SHOWN.
THE LINING SHOWN IN THE DRAWING IS A FEATURE OF THE MARK AND IS NOT INTENDED TO INDICATE COLOR.

FOR SALAD DRESSINGS (U.S. CL. 46).
FIRST USE 1-10-2000; IN COMMERCE 1-10-2000.

SN 76-039,444. FLOWERS BAKERIES BRANDS, INC., THOMASVILLE, GA. FILED 5-2-2000.



OWNER OF U.S. REG. NOS. 1,326,230, 1,991,258 AND OTHERS.

NO CLAIM IS MADE TO THE EXCLUSIVE RIGHT TO USE "QUALITY BREADS, A FAMILY OF BAKERS SINCE 1919, SAN FRANCISCO SOURDOUGH" AND "RECIPE", APART FROM THE MARK AS SHOWN.

THE LINING IS A FEATURE OF THE MARK AND DOES NOT INDICATE COLOR.

FOR BAKERY PRODUCTS (U.S. CL. 46).

CLASS 30—(Continued).

SN 76-080,452. SOUTHERN DREAM FOODS, INC., LOUISVILLE, KY. FILED 6-29-2000.

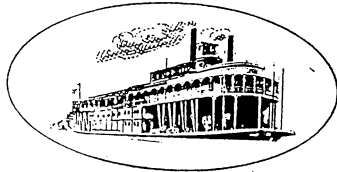

THE STIPPLING IS FOR SHADING PURPOSES. FOR BARBECUE SAUCES, COFFEE, CANDY, FLAVORED CANDY, SALSA, CHOCOLATE, ICE CREAM, ICE CREAM TOPPING SYRUP, AND TEA (U.S. CL. 46).

SN 76-101,892. RIVIANA FOODS INC., HOUSTON, TX. FILED 8-2-2000.



FOR RICE, AND RICE PRODUCTS, NAMELY, WILD RICE, JASMINE RICE, BASMATI RICE, AND ARBORIO RICE, AND RICE MIXES (U.S. CL. 46).

SN 76-113,214. WISCON CORP., LAKE FOREST, IL. FILED 8-21-2000.

TWICE THE SPICE FOR HALF THE PRICE

FOR SPICES (U.S. CL. 46).
FIRST USE 0-0-1992; IN COMMERCE 0-0-1992.

SN 76-117,144. NOVIN SAFFRON, INC., LAGUNA BEACH, CA. FILED 8-28-2000.

DELICATE MAIDEN

FOR SAFFRON (U.S. CL. 46).
FIRST USE 1-6-2000; IN COMMERCE 8-1-2000.

CLASS 30—(Continued).

SN 76-132,642. ONDA SPECIALTY FOODS, INC, SANTA BARBARA, CA. FILED 9-22-2000.



THE ENGLISH TRANSLATION OF "ONDA" IS "WAVE" OR "VIBE".

FOR EXOTIC TEAS SOLD THROUGH HEALTH FOOD STORES AND SPECIALTY FOOD STORES ONLY (U.S. CL. 46).

SN 76-138,062. KINDER, SCOTT A., SAN JOSE, IL. AND KINDER, LARISSA, SAN JOSE, IL. FILED 9-28-2000.



NO CLAIM IS MADE TO THE EXCLUSIVE RIGHT TO USE "FIVE STAR COUNTRY SEASONING", APART FROM THE MARK AS SHOWN.

FOR SPECIAL BLEND OF SPICES FOR SEASONING CHICKEN, BEEF, MEATS (U.S. CL. 46).

SN 76-154,821. BUENO ALIMENTOS, S.A. DE C.V., SANTA CATARINA, NUEVO LEON C.P. 66350, MEXICO, FILED 10-27-2000.

TELOLOAPAN

FOR MOLE PASTE, PIPIAN PASTE, ADOBO PASTE, MEXICAN SAUCES, CANDIES, COOKIES, BISCUITS, HONEY, FLOUR TORTILLAS, CORN TORTILLAS, AND CHOCOLATE (U.S. CL. 46).

CLASS 30—(Continued).

SN 76-182,880. ARABAN COFFEE CO. INC., HINGHAM, MA. FILED 12-19-2000.

BEACON HILL COFFEE

NO CLAIM IS MADE TO THE EXCLUSIVE RIGHT TO USE "COFFEE", APART FROM THE MARK AS SHOWN. FOR COFFEE (U.S. CL. 46).

SN 76-197,008. IMPULSE FOODS LLC, COLUMBUS, OH. FILED 1-25-2001.

DIPSY DONUTS

NO CLAIM IS MADE TO THE EXCLUSIVE RIGHT TO USE "DONUTS", APART FROM THE MARK AS SHOWN. FOR BAKERY PRODUCTS, NAMELY, FRESHLY BAKED, BITE-SIZE DONUTS OF VARYING FLAVORS (U.S. CL. 46).

SN 76-200,696. KABUSHIKI KAISHA L'ESPOIR, CHUO-KU, KOBE, JAPAN, FILED 1-26-2001.

L'ESPOIR

THE ENGLISH TRANSLATION OF "L'ESPOIR" IS "HOPE" OR "THE HOPE". FOR CONFECTIONERY, NAMELY WAFERS, CANDIES, COOKIES, BISCUITS, CAKES, AND CHOCOLATES (U.S. CL. 46).

SN 76-207,318. ETHEL M CHOCOLATES, INC., HENDERSON, NV. FILED 2-9-2001.

**ETHEL M CHOCOLATES
SPECIAL OCCASIONS**

OWNER OF U.S. REG. NOS. 2,199,809, 2,201,478 AND OTHERS. NO CLAIM IS MADE TO THE EXCLUSIVE RIGHT TO USE "CHOCOLATES", APART FROM THE MARK AS SHOWN.

FOR CONFECTIONERY, NAMELY, CANDY (U.S. CL. 46). FIRST USE 7-21-2000; IN COMMERCE 7-21-2000.

CLASS 30—(Continued).

SN 76-210,906. CONAGRA GROCERY PRODUCTS COMPANY, IRVINE, CA. FILED 2-16-2001.

ANGELA MIA

OWNER OF U.S. REG. NO. 2,404,084. THE ENGLISH TRANSLATION OF "ANGELA MIA" IS "MY ANGEL".

FOR PREPARED ENTREES CONSISTING PRIMARILY OF PASTA AND SAUCE AND ALSO CONTAINING BEEF, POULTRY, SEAFOOD, VEGETABLES AND/OR CHEESE AS ADDITIONAL INGREDIENTS (U.S. CL. 46).

SN 76-213,260. CONAGRA GROCERY PRODUCTS COMPANY, IRVINE, CA. FILED 2-22-2001.



OWNER OF U.S. REG. NO. 2,404,084. THE ENGLISH TRANSLATION OF "ANGELA MIA" IS "MY ANGEL".

FOR PREPARED ENTREES CONSISTING PRIMARILY OF PASTA AND SAUCE AND ALSO CONTAINING BEEF, POULTRY, SEAFOOD, VEGETABLES AND/OR CHEESE AS ADDITIONAL INGREDIENTS (U.S. CL. 46).

SN 76-218,679. GREEN FOODS INTERNATIONAL, INC., AUSTIN, TX. FILED 3-5-2001.

WALTERS BAY

FOR TEAS (U.S. CL. 46). FIRST USE 12-1-2000; IN COMMERCE 12-1-2000.

SN 76-222,620. SAROLO BAGEL RESTAURANT CORPORATION, SCOTTSDALE, AZ. FILED 3-8-2001.



THE MARK CONSISTS OF THE LETTERS "CHOMPIE'S" IN CAPITAL, STYLIZED LETTERS WITH THE LETTER "O" REPRESENTED BY A BAGEL WITH A BITE REMOVED FROM THE LOWER RIGHT QUADRANT OF THE TORUS SHAPE.

FOR BAGELS, SPECIALTY BREADS AND BIALY-STOCK ROLLS (U.S. CL. 46). FIRST USE 1-1-1979; IN COMMERCE 1-1-1979.

CLASS 30—(Continued).

SN 76-238,622. CHUA, GERIE T., BINONDO, MANILA, PHILIPPINES, FILED 4-10-2001.

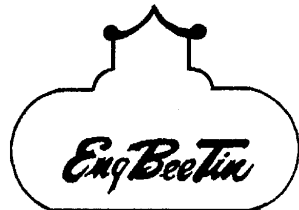

THE ENGLISH TRANSLATION OF "ENG BEE TIN" IS "EVER BEAUTY, PRECIOUS".

FOR CAKES, PASTRIES, AND CONFECTIONERY, NAMELY, CANDY, GUM, LICORICE AND CHOCOLATE (U.S. CL. 46).

SN 76-260,682. 7-ELEVEN, INC., DALLAS, TX. FILED 5-22-2001.

GUMMI GULP

OWNER OF U.S. REG. NOS. 1,110,172, 2,130,647 AND OTHERS.

NO CLAIM IS MADE TO THE EXCLUSIVE RIGHT TO USE "GUMMI", APART FROM THE MARK AS SHOWN.

FOR CONFECTIONERY PRODUCTS, NAMELY CANDY FOR CONSUMPTION ON OR OFF THE PREMISES (U.S. CL. 46).

FIRST USE 5-14-2001; IN COMMERCE 5-14-2001.

SN 76-263,659. FILTERFRESH ALASKA, ANCHORAGE, AK. FILED 5-29-2001.

LEONARDO'S GREAT ITALIAN

NO CLAIM IS MADE TO THE EXCLUSIVE RIGHT TO USE "ITALIAN", APART FROM THE MARK AS SHOWN.

FOR CAPPUCCINO POWDERED MIXES (U.S. CL. 46).

SN 76-286,809. TOWEY, STEVEN G., MISSION VIEJO, CA. FILED 7-18-2001.

DINGLEBERRY

FOR CHOCOLATE COATED FRUIT (U.S. CL. 46). FIRST USE 6-25-1999; IN COMMERCE 6-25-1999.

CLASS 30—(Continued).

SN 76-288,985. LITE 'N TASTI, L.L.C., NEW YORK, NY. FILED 7-24-2001.

CREMA LITA

NO CLAIM IS MADE TO THE EXCLUSIVE RIGHT TO USE "CREMA", APART FROM THE MARK AS SHOWN.

THE ENGLISH TRANSLATION OF "CREMA" IS "CREAM".

FOR ICE CREAM AND SORBET (U.S. CL. 46).

SN 76-290,467. CANDELARIO, ERIBERTO, JALISCO, MEXICO, FILED 7-26-2001.

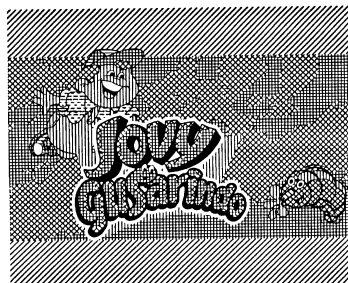

THE DRAWING IS LINED FOR THE COLOR(S) RED, PINK, BLUE, ORANGE, GREEN AND YELLOW.

FOR CANDY, NAMELY, LIQUID TAMARIND AND CHILI FLAVORED CANDY (U.S. CL. 46).

SN 76-309,379. INTERNATIONAL FLAVORS & FRAGRANCES INC., NEW YORK, NY. FILED 9-6-2001.

HEALING-FLAVOR

FOR FLAVOR SUBSTANCES FOR USE IN THE MANUFACTURE OF THE FOLLOWING FLAVORED FOODSTUFFS AND BEVERAGES - COFFEE, TEA, COCOA, SUGAR, RICE, TAPIOCA, SAGO, ARTIFICIAL COFFEE; FLOUR AND PREPARATIONS MADE FROM CEREALS, BREAD, PASTRY AND CONFECTIONERY, HONEY, TREACLE; YEAST, BAKING-POWDER; SALT, MUSTARD, VINEGAR, SAUCES BEING CONDIMENTS; SPICES AND ICE (U.S. CL. 46).

SN 76-315,072. ULKER GIDA SANAYI VE TICARET A.S., 34015 TOPKAPI ISTANBUL, TURKEY, FILED 9-20-2001.

METOO

FOR CHOCOLATES, CHOCOLATE-BASED CANDIES, BISCUITS, WAFERS, AND CAKES (U.S. CL. 46).

CLASS 30—(Continued).

SN 76-315,717. S&D COFFEE, INC., CONCORD, NC. FILED 9-21-2001.

NAN & JAMES FINE COFFEES

NO CLAIM IS MADE TO THE EXCLUSIVE RIGHT TO USE "FINE COFFEES", APART FROM THE MARK AS SHOWN.
FOR COFFEE AND COFFEE BEANS (U.S. CL. 46).

SN 76-317,311. MENNEL MILLING COMPANY, THE, FOSTORIA, OH. FILED 9-26-2001.

MENCONE

FOR FLOUR (U.S. CL. 46).
FIRST USE 0-0-1960; IN COMMERCE 0-0-1960.

SN 76-326,415. THOMAS O. MILLER & CO., INC., MARLBORO, NY. FILED 10-18-2001.



NO CLAIM IS MADE TO THE EXCLUSIVE RIGHT TO USE "PREMIUM COFFEE" AND THE REPRESENTATION OF THREE COFFEE BEANS, APART FROM THE MARK AS SHOWN.
THE NAME IN THE MARK DOES NOT IDENTIFY A LIVING INDIVIDUAL.
FOR COFFEE (U.S. CL. 46).
FIRST USE 10-15-1999; IN COMMERCE 10-15-1999.

CLASS 30—(Continued).

SN 76-345,658. PAPA MURPHY'S INTERNATIONAL, INC., VANCOUVER, WA. FILED 12-6-2001.



FOR UNBAKED PIZZA PREPARED FOR OFF-PREMISES BAKING AND CONSUMPTION (U.S. CL. 46).
FIRST USE 11-1-1995; IN COMMERCE 11-1-1995.

SN 76-345,686. ADRIA IMPORTS INC., MASPETH, NY. FILED 12-5-2001.

CHOCO-WAY

FOR CHOCOLATE BREAD SPREAD (U.S. CL. 46).
FIRST USE 1-15-1997; IN COMMERCE 1-15-1997.

SN 76-349,552. WALKER FOODS, INC., LOS ANGELES, CA. FILED 12-17-2001.

GOLDEN STATE

FOR CANNED FOODS, NAMELY, VINEGAR, PREPARED MUSTARD, AND HOT CHILE PEPPERS (U.S. CL. 46).
FIRST USE 6-1-1914; IN COMMERCE 6-1-1914.

SN 78-061,382. U.S. NUTRACEUTICALS, L.L.C., LEESBURG, FL. FILED 5-1-2001.

GOURMET DIRECT

NO CLAIM IS MADE TO THE EXCLUSIVE RIGHT TO USE "GOURMET", APART FROM THE MARK AS SHOWN.
FOR FOOD FLAVORINGS (U.S. CL. 46).

CLASS 30—(Continued).

SN 78-062,238. NORA MILL GRANARY, INC., HELEN, GA.
FILED 5-6-2001.

NORA MILL

NO CLAIM IS MADE TO THE EXCLUSIVE RIGHT TO USE "MILL", APART FROM THE MARK AS SHOWN.
THE NAME "NORA MILL" DOES NOT IDENTIFY A LIVING INDIVIDUAL.

FOR STONE GROUND GRAIN PRODUCTS, NAMELY, CORN MEAL, FLOUR, GRITS, PORRIDGE-MIXES, AND BREAD MIXES (U.S. CL. 46).

FIRST USE 6-1-1981; IN COMMERCE 6-1-1981.

SN 78-066,126. SCOTTIE MACBEAN, INC., WORTHINGTON, OH. FILED 5-29-2001.

LIVE COFFEE

NO CLAIM IS MADE TO THE EXCLUSIVE RIGHT TO USE "COFFEE", APART FROM THE MARK AS SHOWN.
FOR COFFEES (U.S. CL. 46).

FIRST USE 3-0-2001; IN COMMERCE 3-0-2001.

SN 78-078,432. OCHO RIOS MIAMI, INC., MIAMI, FL. FILED 8-9-2001.



NO CLAIM IS MADE TO THE EXCLUSIVE RIGHT TO USE "JERK" AND "CURRY", APART FROM THE MARK AS SHOWN.

FOR SPICES IN THE FORM OF POWDER AND PASTE (U.S. CL. 46).

FIRST USE 7-26-2001; IN COMMERCE 7-26-2001.

SN 78-081,052. COLORADO COUNTY RICE MILL, INC., EAGLE LAKE, TX. FILED 8-24-2001.

EXCELLENCE

FOR LONG GRAIN MILLED RICE FOR HUMAN CONSUMPTION (U.S. CL. 46).

CLASS 30—(Continued).

SN 78-081,066. LOUJEN CORPORATION, MIRAMAR, FL.
FILED 8-24-2001.



FOR CAKES, SPONGE RUSK, CUP CAKES, MINI CAKES, PASTRIES, AND CRACKERS (U.S. CL. 46).

FIRST USE 3-30-1994, THE MARK WAS FIRST USED ANYWHERE IN A DIFFERENT FORM OTHER THAN THAT SOUGHT TO BE REGISTERED ON 12/30/1966; IN COMMERCE 3-30-1994, THE MARK WAS FIRST USED IN COMMERCE IN A DIFFERENT FORM OTHER THAN THAT SOUGHT TO BE REGISTERED ON 12/30/1966.

SN 78-088,322. ABREO, CHRIS L., FLOWER MOUND, TX.
FILED 10-15-2001.

A SPICE HARVEST

NO CLAIM IS MADE TO THE EXCLUSIVE RIGHT TO USE "SPICE", APART FROM THE MARK AS SHOWN.

FOR PROCESSED HERBS, SPICES, SPICE BLENDS, SEASONINGS, SEASONING BLENDS; SALT, SEASONED SALT, SALT SUBSTITUTES; PEPPER; FOOD FLAVORING AND MIXES, BEING NOT ESSENTIAL OILS; SPICY SAUCE MIXES FOR MEATS, EGGS, BEANS, FISH, SALADS, AND SOUPS, NAMELY HOT SAUCE, PICANTE, SALSA, AND DIPS; GLAZES FOR MEAT AND POULTRY; CHILI KITS, CONSISTING PRIMARILY OF SEASONINGS; MEAT TENDERIZER; MARINADES AND MARINADE MIXES; SEASONED COATINGS FOR MEAT, FISH, POULTRY, FRUITS AND VEGETABLES; BARBECUE SAUCE, STEAK SAUCE, SEAFOOD COCKTAIL SAUCE, AND KETCHUP; STIR FRY MIXES; AND TORTILLA CHIPS (U.S. CL. 46).

SN 78-089,933. INDOPCO, INC., DBA NATIONAL STARCH & CHEMICAL COMPANY, BRIDGEWATER, NJ. FILED 10-24-2001.

N-SURANCE

FOR FOOD STARCH FOR THE FOOD INDUSTRY (U.S. CL. 46).

SN 78-096,348. CONOPCO, INC., DBA GOOD HUMOR-BREYERS ICE CREAM, GREEN BAY, WI. FILED 12-3-2001.

CORNETTO

FOR ICE CREAM (U.S. CL. 46).

CLASS 30—(Continued).

SN 78-096,484. PILLSBURY COMPANY, THE, MINNEAPOLIS, MN. FILED 12-4-2001.

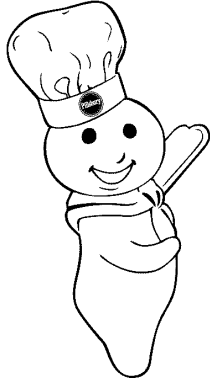

OWNER OF U.S. REG. NOS. 1,669,633, 2,404,844 AND OTHERS.
FOR FROZEN DOUGH AND FROSTING (U.S. CL. 46).
FIRST USE 6-16-1999; IN COMMERCE 6-16-1999.

CLASS 31—NATURAL AGRICULTURAL PRODUCTS

SN 75-852,295. MFA INCORPORATED, COLUMBIA, MO. FILED 11-17-1999.

RUMENSYNC

FOR ANIMAL FEED CONTAINING INGREDIENTS SPECIALLY FORMULATED WITH HIGH QUALITY, MULTIPLE CARBOHYDRATE SOURCES (U.S. CLS. 1 AND 46).
FIRST USE 6-0-1999; IN COMMERCE 6-0-1999.

SN 75-925,601. ALTMAN SPECIALTY PLANTS, INC., VISTA, CA. FILED 2-17-2000.

FLORAGEM

FOR HORTICULTURAL AND FLORICULTURAL PRODUCTS, NAMELY, POTTED ANNUALS AND PERENNIALS, BEDDING AND FOLIAGE (U.S. CLS. 1 AND 46).

SN 76-035,129. FRESHMAX LIMITED, CHRISTCHURCH, NEW ZEALAND, FILED 4-26-2000.

KIDDIPICK

OWNER OF NEW ZEALAND REG. NO. 189712, DATED 12-15-1988, EXPIRES 12-15-2009.
FOR FRESH FRUITS AND VEGETABLES (U.S. CLS. 1 AND 46).

CLASS 31—(Continued).

SN 76-044,652. KAYTEE PRODUCTS INCORPORATED, CHILTON, WI. FILED 5-10-2000.

COCKATIEL BISCUIT-O'S

NO CLAIM IS MADE TO THE EXCLUSIVE RIGHT TO USE "COCKATIEL", APART FROM THE MARK AS SHOWN.

FOR FEED FOR SMALL ANIMALS AND BIRDS (U.S. CLS. 1 AND 46).
FIRST USE 1-1-2000; IN COMMERCE 1-1-2000.

SN 76-095,369. FORT BOISE PRODUCE CO., NYSSA, OR. FILED 7-20-2000.

GIANT SWEET

OWNER OF U.S. REG. NOS. 1,761,596, 1,966,133 AND OTHERS.
SEC. 2(F).
FOR FRESH PACKED ONIONS (U.S. CLS. 1 AND 46).
FIRST USE 2-1-1993; IN COMMERCE 2-1-1993.

SN 76-154,528. LG CHEMICAL LTD., YONGDUNGPO-KU SEOUL, REPUBLIC OF KOREA, FILED 10-26-2000.

SUGARING

FOR NON-MEDICAL ARTIFICIAL SWEETENER FOR USE AS A FEED ADDITIVE (U.S. CLS. 1 AND 46).

SN 76-169,564. GARGIULO INC., NAPLES, FL. FILED 11-22-2000.

BHN

FOR SEEDS FOR USE IN GROWING FRESH FRUITS AND VEGETABLES (U.S. CLS. 1 AND 46).
FIRST USE 1-0-1985; IN COMMERCE 1-0-1985.

SN 76-242,069. GLOBAL FRESH IMPORT AND EXPORT, INC., SPRINGFIELD, IL. FILED 4-18-2001.

BIG FIVE

FOR FRESH FRUITS AND VEGETABLES (U.S. CLS. 1 AND 46).

CLASS 31—(Continued).

SN 76-250,577. CENTINELA FEED, INC., LOS ANGELES, CA. FILED 5-3-2001.

LOTUS

FOR PET FOOD (U.S. CLS. 1 AND 46).

SN 76-268,687. SLA LLC, BEXLEY, OH. FILED 6-9-2001.



THE ENGLISH TRANSLATION OF "AVANT" IS "BEFORE".
FOR CUT FLOWERS (U.S. CLS. 1 AND 46).
FIRST USE 5-1-1997; IN COMMERCE 11-22-1997.

SN 76-271,555. WILLOWBROOK NURSERIES INC., FENWICK, ONTARIO, CANADA, FILED 6-13-2001.

MEDALLION PERENNIALS

PRIORITY CLAIMED UNDER SEC. 44(D) ON CANADA APPLICATION NO. 1087553, FILED 12-22-2000.

NO CLAIM IS MADE TO THE EXCLUSIVE RIGHT TO USE "PERENNIALS", APART FROM THE MARK AS SHOWN.

FOR HORTICULTURAL PRODUCTS, NAMELY LIVE ANNUAL AND PERENNIAL PLANTS, ORNAMENTAL GRASSES, FERNS, GROUNDCOVERS, VINES, FLOWERING SHRUBS, EVERGREENS, BROADLEAF EVERGREENS, CLEMATIS, JUNIPERS, SPRUCE, PINE, YEW, HEMLOCK, CONTAINER GROWN TREES, AND TREE STANDARDS (U.S. CLS. 1 AND 46).

FIRST USE 3-19-1998; IN COMMERCE 3-13-2001.

SN 76-336,544. KELLY FOODS CORPORATION, BERLIN, MD. FILED 11-9-2001.

IF YOU'RE GOING TO TREAT 'EM, TREAT 'EM RIGHT

FOR PET FOOD, NAMELY, DOG AND CAT TREATS (U.S. CLS. 1 AND 46).

CLASS 31—(Continued).

SN 76-345,712. BEACH STREET FARMS, LLC, WATSONVILLE, CA. FILED 12-5-2001.

FOR FRESH FRUITS AND VEGETABLES (U.S. CLS. 1 AND 46).
FIRST USE 3-27-2001; IN COMMERCE 4-16-2001.

SN 76-349,494. M. I. INDUSTRIES, INCORPORATED, LINCOLN, NE. FILED 12-17-2001.

**NATURE'S VARIETY
LINKING NATURE'S
ABUNDANCE FOR THE
HEALTH OF YOUR PET**

FOR EDIBLE FOODSTUFFS FOR ANIMALS, NAMELY, TREATS AND DIETARY FEED FOR DOGS, CATS, AND HORSES (U.S. CLS. 1 AND 46).
FIRST USE 12-4-2001; IN COMMERCE 12-4-2001.

SN 76-352,887. SPECTRUM INVESTMENT COMPANY, LLC, MIAMI, FL. FILED 12-27-2001.

SPECTRUM

FOR FRESH CUT FLOWERS (U.S. CLS. 1 AND 46).
FIRST USE 8-1-2000; IN COMMERCE 8-1-2000.

SN 78-086,978. FIORELLA, MICHAEL J., ELIZABETH, CO. FILED 10-4-2001.

COLORAMI

FOR CATTLE, HORSES, DOGS (U.S. CLS. 1 AND 46).

CLASS 32—LIGHT BEVERAGES

CLASS 32—(Continued).

SN 75-514,842. PERKINS, DWIGHT, LOS GATOS, CA. FILED 7-7-1998.

DR. SWAMI AND BONE DADDY'S

FOR NON-ALCOHOLIC COCKTAIL MIXES (U.S. CLS. 45, 46 AND 48).
FIRST USE 9-0-1995; IN COMMERCE 9-0-1995.

SN 75-580,324. MOLSON CANADA, TORONTO, CANADA, BY CHANGE OF NAME MOLSON BREWERIES, TORONTO, ONTARIO, CANADA, FILED 10-28-1998.

PLEASURE PACK

PRIORITY CLAIMED UNDER SEC. 44(D) ON CANADA APPLICATION NO. 879,024, FILED 5-21-1998, REG. NO. 531610, DATED 8-22-2000, EXPIRES 8-22-2015.

NO CLAIM IS MADE TO THE EXCLUSIVE RIGHT TO USE "PACK", APART FROM THE MARK AS SHOWN.
FOR BREWED ALCOHOLIC BEVERAGES, NAMELY BEER (U.S. CLS. 45, 46 AND 48).

SN 75-778,932. CALCIUM SPRINGS WATER COMPANY, LLC, PARK CITY, UT. FILED 8-19-1999.



NO CLAIM IS MADE TO THE EXCLUSIVE RIGHT TO USE "CALCIUM SPRINGS MINERAL SPRING WATER", APART FROM THE MARK AS SHOWN.

THE LINING AND STIPPLING SHOWN IN THE DRAWING OF THE MARK DO NOT INDICATE COLOR.

THE MARK CONSISTS OF THE WORDING "CALCIUM SPRINGS MINERAL SPRING WATER" AND DESIGN CONSISTING OF RUSHING STREAM WATER FLOWING OVER ROCKS, DISPLAYED WITHIN AN OVAL CIRCLE.

FOR BOTTLED DRINKING WATER (U.S. CLS. 45, 46 AND 48).

FIRST USE 6-12-1998; IN COMMERCE 6-12-1998.

SN 75-789,567. TRIUMPH DESIGNS LIMITED, DERBYSHIRE DE12 7JP, ENGLAND, FILED 9-1-1999.

TRIUMPH

OWNER OF UNITED KINGDOM REG. NO. 2155830, DATED 1-17-1998, EXPIRES 1-17-2008.

FOR BEER, ALE AND LAGER (U.S. CLS. 45, 46 AND 48).

CLASS 32—(Continued).

SN 76-098,795. PUBLIC WORKS COMMISSION OF THE CITY OF FAYETTEVILLE, NORTH CAROLINA, FAYETTEVILLE, NC. FILED 7-28-2000.

CAROLINA BLUE

NO CLAIM IS MADE TO THE EXCLUSIVE RIGHT TO USE "CAROLINA", APART FROM THE MARK AS SHOWN.
FOR BOTTLED DRINKING WATER (U.S. CLS. 45, 46 AND 48).

SN 76-106,450. MARKSTEIN ENTERPRISES, WALNUT CREEK, CA. FILED 8-10-2000.

GOLDEN WEST

NO CLAIM IS MADE TO THE EXCLUSIVE RIGHT TO USE "GOLDEN", APART FROM THE MARK AS SHOWN.
FOR BEER AND ALE (U.S. CLS. 45, 46 AND 48).

SN 76-176,430. CARGILL, INCORPORATED, WAYZATA, MN. FILED 12-6-2000.

NOURISHING POTENTIAL

NO CLAIM IS MADE TO THE EXCLUSIVE RIGHT TO USE "NOURISHING", APART FROM THE MARK AS SHOWN.

FOR FRUIT JUICE CONCENTRATE; CITRUS AND FRUIT JUICES (U.S. CLS. 45, 46 AND 48).

SN 76-185,637. DIAMANT QUELLE KLEE & JUNGBLUT GMBH & CO. KG, D-55767 SCHWOLLEN, FED REP GERMANY, FILED 12-22-2000.

WATER★SAM

OWNER OF FED REP GERMANY REG. NO. 39908884, DATED 3-12-1999, EXPIRES 2-28-2009.

NO CLAIM IS MADE TO THE EXCLUSIVE RIGHT TO USE "WATER", APART FROM THE MARK AS SHOWN.

FOR MINERAL WATERS, AERATED WATERS, SOFT DRINKS, FRUIT DRINKS, FRUIT JUICE AND FRUIT JUICE DRINKS (U.S. CLS. 45, 46 AND 48).

SN 76-186,491. OCEAN-LYTE ENTERPRISES, L.L.C., GRAND RAPIDS, MI. FILED 12-26-2000.

FLYTE-LYTE

FOR DRINKING WATER CONTAINING ELECTROLYTES (U.S. CLS. 45, 46 AND 48).

CLASS 32—(Continued).

SN 76-226,015. LIDL STIFTUNG & CO. KG, 74172 NECK-ARSULM, FED REP GERMANY, FILED 3-16-2001.

PLEIN SUD

OWNER OF FED REP GERMANY REG. NO. 39901241, DATED 3-4-1999, EXPIRES 1-31-2009.

THE ENGLISH TRANSLATION OF "PLEIN SUD" IS "DUE SOUTH".

FOR NON-ALCOHOLIC DRINKS, NAMELY, SYRUPS FOR MAKING SOFT DRINKS AND ANISE FLAVORED NON-ALCOHOLIC BEVERAGES (U.S. CLS. 45, 46 AND 48).

SN 76-255,650. LABATT BREWING COMPANY LIMITED, TORONTO, ONTARIO M5J 2T3, CANADA, FILED 5-11-2001.

THREE STAR LAGER

PRIORITY CLAIMED UNDER SEC. 44(D) ON CANADA APPLICATION NO. 1,084,149, FILED 11-20-2000.

NO CLAIM IS MADE TO THE EXCLUSIVE RIGHT TO USE "LAGER", APART FROM THE MARK AS SHOWN.

FOR ALCOHOLIC BREWERY BEVERAGES, NAMELY, BEER (U.S. CLS. 45, 46 AND 48).

SN 76-270,992. MERIDIAN BEVERAGE COMPANY, INC., NORCROSS, GA. FILED 6-13-2001.

AQUA CAL

NO CLAIM IS MADE TO THE EXCLUSIVE RIGHT TO USE "AQUA", APART FROM THE MARK AS SHOWN.

FOR BOTTLED SPRING WATER (U.S. CLS. 45, 46 AND 48).

SN 76-288,397. CALIFORNIA BEACH NATURALS BEVERAGE CORPORATION, SAN BERNARDINO, CA. FILED 7-23-2001.



FOR NON-ALCOHOLIC BEVERAGES, NAMELY FRUIT DRINKS AND FRUIT JUICES (U.S. CLS. 45, 46 AND 48).

CLASS 32—(Continued).

SN 76-314,978. SUNKIST GROWERS, INC., SHERMAN OAKS, CA. FILED 9-19-2001.

SUNKIST PURE

OWNER OF U.S. REG. NOS. 72,087, 204,603 AND OTHERS. NO CLAIM IS MADE TO THE EXCLUSIVE RIGHT TO USE "PURE", APART FROM THE MARK AS SHOWN.

FOR FRUIT JUICE (U.S. CLS. 45, 46 AND 48).

SN 76-315,691. HERDEZ S.A. DE C.V., DELEGACION MIGUEL HIDALGO C.P., 11000, MEXICO, FILED 9-21-2001.

HERDEZ

FOR VEGETABLE JUICES (U.S. CLS. 45, 46 AND 48). FIRST USE 4-11-2001; IN COMMERCE 4-11-2001.

SN 76-341,596. LIDL STIFTUNG & CO. KG, 74172 NECK-ARSULM, FED REP GERMANY, FILED 11-26-2001.

HATHERWOOD

OWNER OF IRELAND REG. NO. 211921, DATED 1-21-1999, EXPIRES 1-21-2009.

FOR BEER, ALE, LAGER AND PORTER (U.S. CLS. 45, 46 AND 48).

SN 78-058,916. BEDFORD HOLDING, LLC, MAHOPAC, NY. FILED 4-17-2001.

ORANG-A-TANGY

FOR CARBONATED AND NON-CARBONATED FRUIT JUICES; FRUIT DRINKS; SOFT DRINKS; AND NON-ALCOHOLIC BEVERAGES, NAMELY, FLAVORED WATERS (U.S. CLS. 45, 46 AND 48).

SN 78-091,445. WONG, YONG M., ARCADIA, CA. FILED 11-2-2001.

SILVERHERON

FOR BEERS; MINERAL AND AERATED WATERS; NON-ALCOHOLIC FRUIT AND VEGETABLE-BASED DRINKS AND BEVERAGES; FRUIT JUICES AND VEGETABLE JUICES; CONCENTRATES, EXTRACTS, POWDERS, AND SYRUPS FOR MAKING NON-ALCOHOLIC BEVERAGES, NAMELY FRUIT AND VEGETABLE-BASED DRINKS AND BEVERAGES, FRUIT JUICES, AND VEGETABLE JUICES (U.S. CLS. 45, 46 AND 48).

CLASS 33—WINES AND SPIRITS

CLASS 33—(Continued).

SN 75-736,440. BUENA VISTA WINERY, INC., SONOMA, CA. FILED 6-24-1999.

SPICELING

FOR WINE (U.S. CLS. 47 AND 49).

SN 75-767,144. YEREVAN BRANDY COMPANY, 375082 YEREVAN, REPUBLIC OF ARMENIA, ARMENIA, FILED 8-3-1999.

ENTIR

THE ENGLISH TRANSLATION OF "ENTIR" IS "CHOSHEN".
FOR BRANDY (U.S. CLS. 47 AND 49).

SN 75-799,066. DEINHARD AG, D-65187 WIESBADEN, FED REP GERMANY, FILED 9-13-1999.

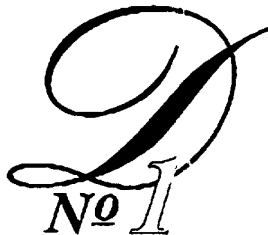

OWNER OF FED REP GERMANY REG. NO. 39920753, DATED 8-16-1999, EXPIRES 4-30-2009.
FOR ALCOHOLIC BEVERAGES, NAMELY WINES (U.S. CLS. 47 AND 49).

CLASS 33—(Continued).

SN 75-927,722. CODORNIU, S.A., 08770-SANT SADURNI D'ANOIA (BARCELONA), SPAIN, FILED 2-25-2000.



OWNER OF U.S. REG. NOS. 599,167 AND 2,275,505.
NO CLAIM IS MADE TO THE EXCLUSIVE RIGHT TO USE "1551", "BRUT", "OVER 400 YEARS OF TRADITION" AND "METODO TRADICIONAL" AND "THE SHAPE OF THE BOTTLE", APART FROM THE MARK AS SHOWN.

THE STIPPLING IN THE DRAWING IS NOT INTENDED TO INDICATE COLOR. THE MARK IS LINED FOR THE COLORS DARK GREEN, GOLD, AND BROWNISH GOLD.

THE MARK CONSISTS OF A CONFIGURATION OF A BOTTLE AND A DESIGN OF THREE LABELS STRATEGICALLY PLACED ON A BOTTLE. THE SIDES OF THE BOTTLE ARE INDENTED, THEN FLARE OUT TO THE BASE OF THE BOTTLE IN A BELL SHAPE; THE LABEL, PLACED BELOW THE INDENTATION OF THE BOTTLE SIDES, IS SLANTED ALONG THE TOP; THE LABEL ALSO FLARES ON EITHER SIDE IN THE SHAPE OF THE BOTTLE BASE. THE TIN FOIL CAP IS NOT A PART OF THE APPLICANT'S MARK.

"CODORNIU" IS SPANISH FOR "QUAIL". "METODO TRADICIONAL" IS SPANISH FOR "TRADITIONAL METHOD".

SEC. 2(F) AS TO THE SHAPE OF THE BOTTLE.
FOR SPARKLING WINES (U.S. CLS. 47 AND 49).
FIRST USE 7-0-1999; IN COMMERCE 7-0-1999.

SN 76-007,744. AGROPRODUCTOS BAUZA Y CIA. LTDA., LAS CONDES, SANTIAGO, CHILE, FILED 3-23-2000.

BAUZA

SEC. 2(F).
FOR SPIRITS, NAMELY, BRANDY SPIRITS AND DISTILLED SPIRITS MADE FROM GRAPES; WINE; BRANDY AND LIQUEURS (U.S. CLS. 47 AND 49).
FIRST USE 0-0-1930; IN COMMERCE 0-0-1975.

SN 76-089,014. ROTHBURY WINES PTY LTD, POKOLBIN, NEW SOUTH WALES, AUSTRALIA, FILED 7-14-2000.

SALTRAM

OWNER OF AUSTRALIA REG. NO. 256,110, DATED 2-23-1972, EXPIRES 2-23-2007.
FOR WINES (U.S. CLS. 47 AND 49).
FIRST USE 0-0-1996; IN COMMERCE 0-0-1996.

CLASS 33—(Continued).

SN 76-125,304. HEIDSIECK & CO MONOPOLE, 51200 EPERNAY, FRANCE, FILED 9-7-2000.

BLUE TOP

PRIORITY CLAIMED UNDER SEC. 44(D) ON FRANCE APPLICATION NO. 003019799, FILED 4-6-2000, REG. NO. 003019799, DATED 4-6-2000, EXPIRES 4-6-2010.
OWNER OF U.S. REG. NO. 2,351,085.
FOR CHAMPAGNE WINES (U.S. CLS. 47 AND 49).
FIRST USE 1-0-1997; IN COMMERCE 1-0-1997.

SN 76-177,627. COMPANIA LICORERA DE CENTROAMERICA, SA, MIAMI, FL. FILED 12-8-2000.

Flor de Caña
EXTRA DRY

OWNER OF U.S. REG. NO. 1,861,443.
NO CLAIM IS MADE TO THE EXCLUSIVE RIGHT TO USE "EXTRA DRY", APART FROM THE MARK AS SHOWN.

THE ENGLISH TRANSLATION OF "FLOR DE CANA" IS "FLOWER OF THE CANE".

FOR RUM (U.S. CLS. 47 AND 49).
FIRST USE 9-16-2000; IN COMMERCE 9-16-2000.

SN 76-192,099. COMPAGNIE DES GRANDS VINS GENEREUX DE FRANCE, 66600 CASES DE PENE, FRANCE, FILED 1-10-2001.

ESPINO BLANCO

PRIORITY CLAIMED UNDER SEC. 44(D) ON FRANCE APPLICATION NO. 003040423, FILED 7-12-2000, REG. NO. 003040423, DATED 7-12-2000, EXPIRES 7-12-2010.

NO CLAIM IS MADE TO THE EXCLUSIVE RIGHT TO USE "BLANCO", APART FROM THE MARK AS SHOWN.

THE ENGLISH TRANSLATION OF "ESPINO BLANCO" IS "WHITE HAWTHORN".

FOR WINES (U.S. CLS. 47 AND 49).

SN 76-207,274. REX HILL, INC., NEWBERG, OR. FILED 2-1-2001.

WE KNOW PINOT

NO CLAIM IS MADE TO THE EXCLUSIVE RIGHT TO USE "PINOT", APART FROM THE MARK AS SHOWN.

FOR ALCOHOLIC BEVERAGES, NAMELY, WINE AND DISTILLED SPIRITS (U.S. CLS. 47 AND 49).

CLASS 33—(Continued).

SN 76-212,343. PALANDRI PRODUCTION LTD., WEST PERTH, WESTERN AUSTRALIA, AUSTRALIA, FILED 2-16-2001.

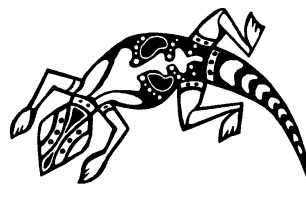

FOR ALCOHOLIC BEVERAGES, NAMELY WINE AND WINE COOLERS (U.S. CLS. 47 AND 49).

SN 76-212,344. PALANDRI PRODUCTION LTD., WEST PERTH, WESTERN AUSTRALIA, AUSTRALIA, FILED 2-16-2001.



FOR ALCOHOLIC BEVERAGES, NAMELY WINE AND WINE COOLERS (U.S. CLS. 47 AND 49).

SN 76-251,620. AZIENDA AGRICOLA MOLETTA DEL COMM. STIVAL MARIO, 31045 MOTTA DI LIVENZA (TV), ITALY, FILED 5-7-2001.

IL VINO DEL LUNEDI BISO

NO CLAIM IS MADE TO THE EXCLUSIVE RIGHT TO USE "VINO", APART FROM THE MARK AS SHOWN.

THE ENGLISH TRANSLATION OF "IL VINO DEL LUNEDI BISO" IS "BISO THE MONDAY WINE".

FOR WINE (U.S. CLS. 47 AND 49).

SN 76-254,062. LOMBARD BRANDS LIMITED, RAMSEY, ISLE OF MAN, FILED 5-9-2001.

DRIFTWOOD

PRIORITY CLAIMED UNDER SEC. 44(D) ON UNITED KINGDOM APPLICATION NO. 2260519, FILED 2-8-2001, REG. NO. 2260519, DATED 7-13-2001, EXPIRES 2-8-2011.

FOR ALCOHOLIC DRINKS, NAMELY, DISTILLED SPIRITS, LIQUEURS, WHISKEY, SCOTCH WHISKY, MALT WHISKY, SCOTCH WHISKY BASED LIQUEURS, GIN, VODKA AND TEQUILA (U.S. CLS. 47 AND 49).

CLASS 33—(Continued).

SN 76-254,298. LOMBARD BRANDS LIMITED, RAMSEY ISLE OF MAN IM8 1JW, UNITED KINGDOM, FILED 5-9-2001.

ANCHOR BAY

PRIORITY CLAIMED UNDER SEC. 44(D) ON UNITED KINGDOM APPLICATION NO. 2261526, FILED 2-17-2001, REG. NO. 2261526, DATED 2-17-2001, EXPIRES 2-17-2011.

FOR ALCOHOLIC DRINKS, NAMELY, DISTILLED SPIRITS, LIQUEURS, WHISKY, SCOTCH WHISKEY, MALT WHISKY, SCOTCH WHISKY BASED LIQUEURS, GIN, VODKA AND TEQUILA (U.S. CLS. 47 AND 49).

SN 76-266,788. ROBUSTO WINES & SPIRITS CC, STELLENBOSCH, 7600, SOUTH AFRICA, FILED 6-5-2001.

RUDERA

FOR ALCOHOLIC BEVERAGES, NAMELY, WINES, DISTILLED SPIRITS DERIVED FROM GRAPES AND LIQUEURS (U.S. CLS. 47 AND 49).

SN 76-269,539. SA C. LANVIN, 21700 NUITS ST. GEORGES, FRANCE, FILED 6-8-2001.



THE RECTANGULAR BOX CONNECTING THE TWO OCCURRENCES OF "DOMAINE DE CHARMY", THE TWO CONCENTRIC CIRCLES AROUND THE TOP OCCURRENCE OF THIS NAME, AND THE FOUR FLEUR DE LYS WITHIN THE CONCENTRIC CIRCLES ARE IN THE COLOR GOLD.

THE TRANSLATION OF THE WORDS "DOMAINE DE CHARMY" MEANS "ESTATE OF CHARMY".

FOR WINES AND BRANDIES (U.S. CLS. 47 AND 49).

CLASS 33—(Continued).

SN 76-309,032. SOCIEDAD ANONIMA VINA SANTA RITA, SANTIAGO, CHILE, FILED 9-4-2001.

SANTA RITA MEDALLA REAL

OWNER OF U.S. REG. NOS. 313,337, 1,237,574 AND 2,275,710.

THE ENGLISH TRANSLATION OF "SANTA RITA MEDALLA REAL" IS "SAINT RITA ROYAL MEDALLION".

FOR WINES (U.S. CLS. 47 AND 49).

SN 76-310,794. ODFJELL VINEYARDS S.A., SANTIAGO, CHILE, FILED 9-12-2001.

ARMADOR

THE MARK MAY BE TRANSLATED AS "SHIPOWNER" OR "SHIP CAPTAIN".

FOR WINES (U.S. CLS. 47 AND 49).

FIRST USE 0-0-1999; IN COMMERCE 5-1-2001.

SN 76-310,836. STOLLER WHOLESALE WINES & SPIRITS, INC., FRANKLIN PARK, IL. FILED 9-10-2001.

RANCHERO

FOR TEQUILA (U.S. CLS. 47 AND 49).

SN 76-312,543. GEKKEIKAN SAKE COMPANY, LTD., FUSHIMI-KU, KYOTO, JAPAN, FILED 9-14-2001.

ZIPANG

FOR ALCOHOLIC BEVERAGES, NAMELY, SAKE AND SPARKLING SAKE (U.S. CLS. 47 AND 49).

SN 76-316,048. SAFEWAY INC., PLEASANTON, CA. FILED 9-24-2001.

Diablo Creek Vineyards

NO CLAIM IS MADE TO THE EXCLUSIVE RIGHT TO USE "VINEYARD", APART FROM THE MARK AS SHOWN.

THE ENGLISH TRANSLATION OF "DIABLO" IS "DEVIL".

FOR WINE (U.S. CLS. 47 AND 49).

CLASS 33—(Continued).

SN 76-342,126. PRODUCTOS DE UVA, S.A. DE C. V., 22130 TIJUANA, BAJA CALIFORNIA, MEXICO, FILED 11-28-2001.

X'TASSY BAR

NO CLAIM IS MADE TO THE EXCLUSIVE RIGHT TO USE "BAR", APART FROM THE MARK AS SHOWN.
FOR PREPARED DRINK MIXES, MADE WITH RUM, TEQUILA AND VODKA (U.S. CLS. 47 AND 49).

SN 76-345,868. CASTELLI DEL GREVEPESA CANTINA SOCIALE SOC.COOP.A.R.L., FIRENZE, ITALY, FILED 12-6-2001.

VALGREVE

FOR WINES (U.S. CLS. 47 AND 49).
FIRST USE 12-0-1970; IN COMMERCE 7-0-1991.

SN 76-345,869. CASTELLI DEL GREVEPESA CANTINA SOCIALE SOC.COOP.A.R.L., FIRENZE, ITALY, FILED 12-6-2001.

PONTORMO

FOR WINES (U.S. CLS. 47 AND 49).
FIRST USE 3-0-1995; IN COMMERCE 7-0-1996.

SN 78-005,647. SILVERADO VINEYARDS, THE, NAPA, CA. FILED 4-25-2000.



NO CLAIM IS MADE TO THE EXCLUSIVE RIGHT TO USE "VINEYARDS", APART FROM THE MARK AS SHOWN.

THE MARK CONSISTS OF THE WORDS "SILVERADO VINEYARDS" IN DARK SILVER AGAINST A LIGHTER SILVER RECTANGULAR BACKGROUND.

FOR WINE (U.S. CLS. 47 AND 49).
FIRST USE 0-0-1983; IN COMMERCE 0-0-1983.

CLASS 34—SMOKERS' ARTICLES

SN 76-094,685. ORTIZ, ROSA VILANOVA, MAYAGUEZ, PUERTO RICO, FILED 7-24-2000.

NATIVO

THE ENGLISH TRANSLATION OF THE MARK IS "NATIVE".

FOR CIGARS (U.S. CLS. 2, 8, 9 AND 17).
FIRST USE 2-1-1997; IN COMMERCE 2-11-1997.

SN 76-168,197. DON RIVERA, INC., AVENTURA, FL. FILED 11-16-2000.



NO CLAIM IS MADE TO THE EXCLUSIVE RIGHT TO USE "HABANOS" AND THE DESIGNS OF THE ISLANDS OF CUBA AND HISPANIOLA, APART FROM THE MARK AS SHOWN.

THE MARK CONSISTS OF THE WORDING "HABANOS REY" AND DESIGN OF A CROWN, AND THE DESIGN OF THE ISLANDS OF CUBA AND HISPANIOLA ALL IN ONE OVAL.

THE WORD "REY" AS TRANSLATED IN THE SPANISH LANGUAGE MEANS "KING".

FOR CIGARS MADE FROM CUBAN SEED TOBACCO, HUMIDORS, CIGAR CUTTERS, MATCHES, TOBACCO LIGHTERS NOT FOR LAND VEHICLES AND NOT OF PRECIOUS METAL, AND ASHTRAYS NOT OF PRECIOUS METAL (U.S. CLS. 2, 8, 9 AND 17).

FIRST USE 6-26-2000; IN COMMERCE 7-6-2000.

SN 76-171,937. ELVIS PRESLEY ENTERPRISES, INC., MEMPHIS, TN. FILED 11-28-2000.

ELVIS PRESLEY

OWNER OF U.S. REG. NOS. 1,329,791, 2,061,619 AND OTHERS.

THE MARK "ELVIS PRESLEY" DOES NOT IDENTIFY A PARTICULAR LIVING INDIVIDUAL.

FOR CIGARETTE LIGHTERS NOT OF PRECIOUS METAL (U.S. CLS. 2, 8, 9 AND 17).

FIRST USE 12-1-1998; IN COMMERCE 12-1-1998.

CLASS 34—(Continued).

SN 76-268,311. CARIBBEAN-AMERICAN TOBACCO CORPORATION, SANTIAGO, DOMINICAN REP, FILED 6-7-2001.

FREMONT

FOR CIGARETTES, CIGARS AND CIGARETTE LIGHTERS NOT OF PRECIOUS METAL (U.S. CLS. 2, 8, 9 AND 17).

CLASS 34—(Continued).

SN 78-066,185. WCW, INC., STAMFORD, CT. FILED 5-29-2001.



FOR CIGARETTE LIGHTERS NOT OF PRECIOUS METAL (U.S. CLS. 2, 8, 9 AND 17).

SN 76-297,283. CIGAR EXPRESS, INC., LAS VEGAS, NV. FILED 8-9-2001.



NO CLAIM IS MADE TO THE EXCLUSIVE RIGHT TO USE "HAVANA HONEY'S", APART FROM THE MARK AS SHOWN.

THE WORDING "HAVANA HONEY'S" IS BLACK OUTLINED IN THE COLOR YELLOW; THE BACKGROUND OF THE MARK, STARTING AT THE TOP, CONSISTS OF A GRADATION OF ORANGE TO YELLOW-ORANGE; THE FLOWERS IN THE MARK CONSIST OF THE COLOR ORANGE; COLOR IS CLAIMED AS A FEATURE OF THE MARK.

THE MARK CONSISTS OF THE WORDING "HAVANA HONEY'S" AND DESIGN OF FLOWERS.

FOR CIGARS AND LITTLE CIGARS MADE FROM CUBAN SEED TOBACCO (U.S. CLS. 2, 8, 9 AND 17).

FIRST USE 7-17-1998; IN COMMERCE 7-17-1998.

SN 76-335,962. PTC BRANDS, INC., WILMINGTON, DE. FILED 11-9-2001.

**LEADERS STAND APART
BUT NOT ALONE**

FOR SMOKELESS TOBACCO (U.S. CLS. 2, 8, 9 AND 17).

SERVICE MARKS**CLASS 35—ADVERTISING AND BUSINESS**

SN 75-563,083. JOHNSON, WELDON R., GILBERT, AZ. BY ASSIGNMENT GRAVITY BROTHERS, INC., GILBERT, AZ. FILED 10-2-1998.

GRAVITY BROTHERS

FOR PROMOTING SPORTS COMPETITIONS AND EVENTS OF OTHERS (U.S. CLS. 100, 101 AND 102).
FIRST USE 9-11-1998; IN COMMERCE 9-11-1998.

SN 75-589,558. PHILBECK, TOMMIE M., MARIETTA, GA. FILED 12-1-1998.

HARBOUR ASSOCIATES

NO CLAIM IS MADE TO THE EXCLUSIVE RIGHT TO USE "ASSOCIATES", APART FROM THE MARK AS SHOWN.

FOR BUSINESS CONSULTATIONS IN THE NATURE OF EMPLOYEE PAY AND BENEFITS PROVIDED BY SENIOR LEVEL EXECUTIVES ON BEHALF OF BUSINESS OWNERS (U.S. CLS. 100, 101 AND 102).

SN 75-616,508. COMMONHEALTH L.P., DOVER, DE. FILED 1-6-1999.

THE XCHANGE GROUP

NO CLAIM IS MADE TO THE EXCLUSIVE RIGHT TO USE "GROUP", APART FROM THE MARK AS SHOWN.

FOR DIRECT MARKETING ADVERTISING; ADVERTISING AGENCY SERVICES, NAMELY PROMOTING THE HEALTHCARE SERVICES OF OTHERS BY PREPARING ADVERTISING AND MARKETING MATERIALS, AND THROUGH THE DISTRIBUTION OF PRINTED AND AUDIO PROMOTIONAL MATERIALS AND BY RENDERING SALES PROMOTION ADVICE (U.S. CLS. 100, 101 AND 102).

CLASS 35—(Continued).

SN 75-683,167. P.C. RICHARD & SON LONG ISLAND CORPORATION, FARMINGDALE, NY. FILED 4-15-1999.

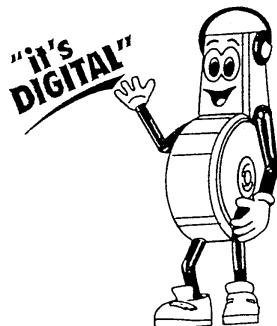

OWNER OF U.S. REG. NO. 1,975,104.
NO CLAIM IS MADE TO THE EXCLUSIVE RIGHT TO USE "DIGITAL", APART FROM THE MARK AS SHOWN.
FOR RETAIL STORE SERVICES IN THE FIELD OF APPLIANCES, ELECTRONICS AND RELATED GOODS (U.S. CLS. 100, 101 AND 102).
FIRST USE 3-16-1999; IN COMMERCE 3-16-1999.

SN 75-715,759. FLORAL VISIONS, INC., POMPANO BEACH, FL. FILED 5-27-1999.



The Planet Channel

FOR COMPUTER SERVICES, NAMELY, PROVIDING ONLINE LINKS TO WEB SITES OFFERING GOODS AND SERVICES OF OTHERS BY PROVIDING A WEB SITE AT WHICH USERS CAN LINK TO THE WEB SITES OF OTHERS WHO PROVIDE ELECTRONIC SHOPPING, NEWS, BUSINESS RESOURCES, WEATHER, AND SPORTS INFORMATION, THROUGH A PERSONALIZED WEB PAGE INTERFACE, ALL VIA LOCAL, WIDE-AREA, AND GLOBAL COMPUTER NETWORKS (U.S. CLS. 100, 101 AND 102).
FIRST USE 8-0-1993; IN COMMERCE 4-11-1999.

SN 75-759,967. EVERYTHING FOR A DOLLAR STORE (CANADA) INC., MARKHAM, ONTARIO, CANADA, FILED 7-26-1999.

EFADS

PRIORITY CLAIMED UNDER SEC. 44(D) ON CANADA APPLICATION NO. 1,003,373, FILED 1-28-1999, REG. NO. TMA528,283, DATED 5-24-2000, EXPIRES 5-24-2015.
FOR RETAIL STORE SERVICES, NAMELY, MARKETING OF DISCOUNT MERCHANDISE OF VARIOUS KINDS AND SUNDRY HOUSEHOLD AND CONSUMER PRODUCTS (U.S. CLS. 100, 101 AND 102).

CLASS 35—(Continued).

SN 75-779,861. ALTAVOZ, INC., ROCKVILLE, MD. FILED 8-20-1999.

ALTAVOZ

FOR WHOLESALE DISTRIBUTORSHIPS, FEATURING PRERECORDED AUDIO AND VIDEO COMPACT DISKS; MAIL ORDER SERVICES AND COMPUTERIZED ONLINE RETAIL SERVICES, FEATURING PRERECORDED AUDIO AND VIDEO COMPACT DISKS AND DOWNLOADABLE MUSIC, CONCERTS, AND VIDEOS (U.S. CLS. 100, 101 AND 102).
FIRST USE 9-0-1994; IN COMMERCE 9-0-1994.

SN 75-813,184. ABCO REFRIGERATION SUPPLY CORP., LONG ISLAND CITY, NY. FILED 9-28-1999.



FOR DISTRIBUTORSHIP SERVICES IN THE FIELDS OF REFRIGERATION SYSTEMS, ICE MACHINES, AIR CONDITIONING UNITS, HVAC AND HEATING UNITS, REFRIGERATION EQUIPMENT, PARTS, SUPPLIES AND MATERIALS (U.S. CLS. 100, 101 AND 102).
FIRST USE 0-0-1961; IN COMMERCE 0-0-1961.

SN 75-835,721. KIRGENER DE PLANTA, ERIC, 75015 PARIS, FRANCE, FILED 10-29-1999.

THE ULTIMATE REVOLUTION

FOR PUBLICITY, NAMELY PUBLICITY AGENTS; ORGANIZATION OF EXHIBITIONS IN THE COMPUTER INDUSTRY, NAMELY COMPUTER DESIGN; MARKET RESEARCH; OPINION POLLING FOR BUSINESS OR ADVERTISING PURPOSES; ECONOMIC FORECASTING; ADVERTISING AGENCY SERVICES, NAMELY PROMOTING THE SERVICES OF COMPUTER INDUSTRY, NAMELY COMPUTER DESIGN, THROUGH THE DISTRIBUTION OF PRINTED AND AUDIO PROMOTIONAL MATERIALS AND BY RENDERING SALES PROMOTION ADVICE; PUBLICATION OF PUBLICITY TEXTS; DISSEMINATION OF ADVERTISING MATTER; DIRECT MAIL ADVERTISING; RENTAL OF PUBLICITY MATERIAL, ALSO KNOWN AS RENTAL OF ADVERTISING SPACE; PUBLIC RELATIONS; PROVIDING STATISTICAL INFORMATION; TELEVISION AND RADIO ADVERTISING MORE SPECIFICALLY PROVIDING TELEVISION AND RADIO ADVERTISING FOR OTHERS, TELEVISION AND RADIO ADVERTISING AGENCIES, PRODUCTION AND DISTRIBUTION OF RADIO AND TELEVISION COMMERCIALS; ARRANGING OF SUBSCRIPTIONS FOR THE PUBLICATIONS OF OTHERS, SPECIFICALLY NEWSPAPERS (U.S. CLS. 100, 101 AND 102).

CLASS 35—(Continued).

SN 75-837,816. CATALINA MARKETING INTERNATIONAL, INC., ST. PETERSBURG, FL. FILED 11-2-1999.

CATALINA MARKETING

OWNER OF U.S. REG. NO. 1,776,720.
NO CLAIM IS MADE TO THE EXCLUSIVE RIGHT TO USE "MARKETING", APART FROM THE MARK AS SHOWN.

FOR PROMOTING THE SALE OF GOODS AND SERVICES OF OTHERS THROUGH COMPUTERIZED DISTRIBUTION OF MESSAGES AND INCENTIVES, NAMELY COUPONS, PREMIUMS, REBATES, CASH DISCOUNTS, AND/OR SAMPLES (U.S. CLS. 100, 101 AND 102).

FIRST USE 12-1-1983; IN COMMERCE 12-1-1983.

SN 75-839,298. BAINBRIDGE, INC., CAMBRIDGE, MA. FILED 11-3-1999.

ANGELSEEDS

FOR FINANCIAL SERVICES IN THE NATURE OF A MATCHING SERVICE WHICH MATCHES POTENTIAL PRIVATE INVESTORS WITH ENTREPRENEURS NEEDING FUNDING (U.S. CLS. 100, 101 AND 102).

SN 75-908,181. WEST PALM BEACH TECHNOLOGIES, INC., MIAMI, FL. FILED 2-2-2000.

EACTIVE

FOR PROMOTING THE GOODS AND SERVICES OF OTHERS BY PREPARING AND PLACING LINKS ON A PORTAL WEBSITE ACCESSED THROUGH A GLOBAL COMPUTER NETWORK AND ELECTRONIC COMMERCE SERVICES, NAMELY, ADVERTISING, FEATURING COMMERCIAL PRODUCTS OF ALL TYPES AND KINDS AND RELATED ONLINE PRODUCT COMMUNICATIONS, VIA A GLOBAL COMPUTER NETWORK (U.S. CLS. 100, 101 AND 102).

FIRST USE 1-27-2000; IN COMMERCE 1-27-2000.

SN 75-908,324. CATALINA MARKETING INTERNATIONAL, INC., ST. PETERSBURG, FL. FILED 2-2-2000.

BUYER ACTIVATED RESEARCH

NO CLAIM IS MADE TO THE EXCLUSIVE RIGHT TO USE "BUYER" AND "RESEARCH", APART FROM THE MARK AS SHOWN.

FOR CONDUCTING MARKET RESEARCH ON THE SALE OF GOODS AND SERVICES OF OTHERS THROUGH THE DISTRIBUTION OF INCENTIVES, NAMELY COUPONS, PREMIUMS, REBATES, CASH DISCOUNTS AND/OR SAMPLES, BASED ON CONSUMER PURCHASE BEHAVIOR (U.S. CLS. 100, 101 AND 102).

FIRST USE 3-16-1999; IN COMMERCE 3-16-1999.

CLASS 35—(Continued).

SN 75-919,153. METABYTE NETWORKS, INC., FREMONT, CA. FILED 2-15-2000.

YOUR THUMBPRINT ON TV

FOR PROVIDING PROMOTIONS SERVICES FOR THE GOODS AND SERVICES OF OTHERS BY PLACING ADS ON A GLOBAL COMPUTER NETWORK, THROUGH TELEVISION, CABLE AND SATELLITE BROADCASTING AND ELECTRONIC AND PRINT MEANS (U.S. CLS. 100, 101 AND 102).

SN 75-922,959. METABYTE NETWORKS, INC., FREMONT, CA. FILED 2-15-2000.



FOR PROVIDING PROMOTIONS SERVICES FOR THE GOODS AND SERVICES OF OTHERS BY PLACING ADS ON A GLOBAL COMPUTER NETWORK, THROUGH TELEVISION, CABLE AND SATELLITE BROADCASTING AND ELECTRONIC AND PRINT MEANS (U.S. CLS. 100, 101 AND 102).

SN 75-922,963. METABYTE NETWORKS, INC., FREMONT, CA. FILED 2-15-2000.

METABYTE NETWORKS

NO CLAIM IS MADE TO THE EXCLUSIVE RIGHT TO USE "NETWORK", APART FROM THE MARK AS SHOWN.

FOR PROVIDING PROMOTIONS SERVICES FOR THE GOODS AND SERVICES OF OTHERS BY PLACING ADS ON A GLOBAL COMPUTER NETWORK, THROUGH TELEVISION, CABLE AND SATELLITE BROADCASTING AND ELECTRONIC AND PRINT MEANS (U.S. CLS. 100, 101 AND 102).

SN 75-927,564. ATJAPAN LLC, WILMINGTON, DE. FILED 2-25-2000.

@JAPAN.COM

FOR BUSINESS CONSULTING SERVICES (U.S. CLS. 100, 101 AND 102).

CLASS 35—(Continued).

SN 75-927,568. ATJAPAN LLC, WILMINGTON, DE. FILED 2-25-2000.

ATJAPAN.COM

FOR BUSINESS CONSULTING SERVICES (U.S. CLS. 100, 101 AND 102).

SN 75-927,570. ATJAPAN LLC, WILMINGTON, DE. FILED 2-25-2000.

@JAPAN

FOR BUSINESS CONSULTING SERVICES (U.S. CLS. 100, 101 AND 102).

SN 75-927,894. ATJAPAN LLC, WILMINGTON, DE. FILED 2-25-2000.

ATJAPAN

FOR BUSINESS CONSULTING SERVICES (U.S. CLS. 100, 101 AND 102).

SN 75-932,647. EMPLOYMENT NEWS, LLC, THE, DENVER, CO. FILED 3-1-2000.

APPLICANT ALERT

NO CLAIM IS MADE TO THE EXCLUSIVE RIGHT TO USE "APPLICANT", APART FROM THE MARK AS SHOWN.

FOR PROVIDING EMPLOYMENT AGENCY SERVICES VIA GLOBAL COMPUTER NETWORK (U.S. CLS. 100, 101 AND 102).

FIRST USE 4-0-2000; IN COMMERCE 4-0-2000.

SN 75-938,419. BIG DADDY INTERNATIONAL, INC., MALVERN, PA. FILED 3-8-2000.

BIGDADDY.COM

OWNER OF U.S. REG. NO. 1,986,812.
FOR RETAIL STORE SERVICES FEATURING FRAGRANCES, PERSONAL CARE PRODUCTS, SUNGLASSES, EYEGLASSES, JEWELRY, WATCHES, HANDBAGS, BACKPACKS, SPORT BAGS, OTHER LEATHER ARTICLES, NAMELY, WALLETS, KEY CASES AND POCKET BOOKS, BOARD GAMES, CLOTHING, FOOTWEAR AND SOFT DRINKS; ELECTRONIC COMMERCE SERVICES, NAMELY RETAIL STORE SERVICES FEATURING FRAGRANCES, PERSONAL CARE PRODUCTS, SUNGLASSES, EYEGLASSES, JEWELRY, WATCHES; HANDBAGS, BACKPACKS, SPORT BAGS, OTHER LEATHER ARTICLES, NAMELY, WALLETS, KEY CASES AND POCKET BOOKS, BOARD GAMES, CLOTHING, FOOTWEAR AND SOFT DRINKS (U.S. CLS. 100, 101 AND 102).

CLASS 35—(Continued).

SN 75-955,986. BENNETT, JEFFREY KIMBRELL, CONCORD, CA. FILED 3-10-2000.

ACTUAL WEB

NO CLAIM IS MADE TO THE EXCLUSIVE RIGHT TO USE "WEB", APART FROM THE MARK AS SHOWN.

FOR PROMOTING THE GOODS AND SERVICES OF OTHERS BY PROVIDING A WEB SITE AT WHICH USERS CAN LINK TO ONLINE RETAILERS (U.S. CLS. 100, 101 AND 102).

SN 76-003,685. ANZAR, OMAR, SAN YSIDRO, CA. FILED 3-18-2000.

THRIFTYSTORE.COM

FOR ONLINE RETAIL STORE SERVICES IN THE FIELD OF COMPUTERS, CLOTHING, COMPACT DISCS; ONLINE TRADING, NAMELY ON LINE AUCTIONS; ADVERTISING, NAMELY PROMOTING THE GOODS AND SERVICES OF OTHERS VIA PREPARING AND PLACING ADVERTISEMENTS ON THE GLOBAL COMPUTER NETWORK (U.S. CLS. 100, 101 AND 102).

SN 76-004,112. COMMUNIQUE MARKETING & ASSOCIATES, INC., EAGLE MOUNTAIN, UT. FILED 3-4-2000.

COMMUNIQUE MARKETING

NO CLAIM IS MADE TO THE EXCLUSIVE RIGHT TO USE "MARKETING", APART FROM THE MARK AS SHOWN.

FOR DIRECT MAIL ADVERTISING (U.S. CLS. 100, 101 AND 102).

SN 76-011,501. MILLER, IAN R., CHICAGO, IL. FILED 3-28-2000.

ROCKET BRANDING

NO CLAIM IS MADE TO THE EXCLUSIVE RIGHT TO USE "BRANDING", APART FROM THE MARK AS SHOWN.

FOR BUSINESS CONSULTING SERVICES; CONSULTING SERVICES IN THE FIELD OF MARKETING AND ADVERTISING; BUSINESS SERVICES, NAMELY, PROMOTIONAL DEVELOPMENT OF PRODUCT NAMES, BRAND NAMES, AND BRAND LOGOS FOR OTHERS; ADVERTISING AGENCY SERVICES (U.S. CLS. 100, 101 AND 102).

CLASS 35—(Continued).

SN 76-011,958. INFO TECH, INC., GAINESVILLE, FL. FILED 3-29-2000.

BID EXPRESS

OWNER OF U.S. REG. NO. 2,368,342.
NO CLAIM IS MADE TO THE EXCLUSIVE RIGHT TO USE "BID", APART FROM THE MARK AS SHOWN.
FOR PROVIDING A WEB SITE ON WHICH PROSPECTIVE CONSTRUCTION COMPANIES CAN BID ON PARTICULAR HIGHWAY CONSTRUCTION PROJECTS (U.S. CLS. 100, 101 AND 102).
FIRST USE 4-17-1996; IN COMMERCE 1-17-1997.

SN 76-020,327. EBAGS, INC., GREENWOOD VILLAGE, CO. FILED 4-7-2000.



SEC. 2(F) AS TO "EBAGS".
FOR ON-LINE RETAIL STORE SERVICES FEATURING LEATHER, IMITATION LEATHER, BALLISTIC NYLON HANDBAGS, LUGGAGE AND BACKPACKS (U.S. CLS. 100, 101 AND 102).
FIRST USE 9-0-1999; IN COMMERCE 9-0-1999.

SN 76-032,968. PLANET EARTH FOUNDATION, SEATTLE, WA. FILED 4-24-2000.

WORLD ADVERTISEMENTS

NO CLAIM IS MADE TO THE EXCLUSIVE RIGHT TO USE "ADVERTISEMENTS", APART FROM THE MARK AS SHOWN.
FOR ADVERTISING SERVICES, NAMELY, PREPARING AND DISSEMINATING ADVERTISING AND PROMOTIONAL MATERIALS FOR OTHERS (U.S. CLS. 100, 101 AND 102).

SN 76-034,135. FLORAGIFT.COM LLC, PHILADELPHIA, PA. FILED 4-25-2000.

GIFIGURATOR

FOR ONLINE RETAIL AND BUSINESS TO BUSINESS SHOPPING SERVICES IN THE FIELDS OF GIFTS AND FLOWERS, ACCESSED THROUGH GLOBAL COMPUTER NETWORKS (U.S. CLS. 100, 101 AND 102).

CLASS 35—(Continued).

SN 76-038,496. LIROV, YUVAL, MORGANVILLE, NJ. FILED 5-2-2000.

TRADEMD

FOR PROVIDING A COMPUTERIZED ON-LINE TRADING SERVICES, NAMELY, AN ELECTRONIC MARKETPLACE FOR MATCHING BUYERS AND SELLERS OF MEDICAL EQUIPMENT AND MEDICAL SUPPLIES, INCLUDING SUCH MEDICAL EQUIPMENT AND SUPPLIES OFFERED IN LIQUIDATION (U.S. CLS. 100, 101 AND 102).
FIRST USE 3-15-2000; IN COMMERCE 3-15-2000.

SN 76-043,266. BROADWAY HALL OF FAME, LLC, NEW YORK, NY. FILED 5-8-2000.

BROADWAY HALL OF FAME

NO CLAIM IS MADE TO THE EXCLUSIVE RIGHT TO USE "BROADWAY", APART FROM THE MARK AS SHOWN.
FOR MAIL ORDER, CATALOG, RETAIL STORE SERVICES FEATURING GENERAL MERCHANDISE FOR THE PROMOTION OF PUBLIC INTEREST IN AND APPRECIATION OF BROADWAY THEATER, ITS HISTORY, PRODUCTIONS (U.S. CLS. 100, 101 AND 102).

SN 76-051,819. PREDICTIVE NETWORKS, INC., CAMBRIDGE, MA. FILED 5-19-2000.

PREDICTIVE NETWORKS

NO CLAIM IS MADE TO THE EXCLUSIVE RIGHT TO USE "NETWORKS", APART FROM THE MARK AS SHOWN.
FOR BUSINESS CONSULTATION SERVICES, NAMELY, PUBLIC RELATION SERVICES, PREPARING AND PLACING ADVERTISEMENTS ON GLOBAL COMPUTER NETWORKS FOR OTHERS, PLACING ADVERTISEMENT ON GLOBAL COMPUTER NETWORKS FOR ADVERTISING AGENCIES AND GLOBAL COMPUTER INFORMATION NETWORK PUBLISHERS, CONDUCTING BUSINESS AND MARKET RESEARCH SURVEYS, MARKET ANALYSIS SERVICES, MARKET RESEARCH AND PROFILING GLOBAL COMPUTER INFORMATION NETWORK SERVICE SUBSCRIBERS FOR OTHERS (U.S. CLS. 100, 101 AND 102).

SN 76-059,815. CARDREADY INTERNATIONAL, INC., CULVER CITY, CA. FILED 5-31-2000.

CARDREADY.COM

FOR PROVIDING ON-LINE BUSINESS AND COMMERCIAL INFORMATION (U.S. CLS. 100, 101 AND 102).
FIRST USE 1-3-2000; IN COMMERCE 1-3-2000.

CLASS 35—(Continued).

SN 76-059,816. CARDREADY INTERNATIONAL, INC., CULVER CITY, CA. FILED 5-31-2000.

BIZREADY

FOR PROVIDING ON-LINE BUSINESS AND COMMERCIAL INFORMATION (U.S. CLS. 100, 101 AND 102).

SN 76-059,954. PAYCYCLE, INC., LOS ALTOS, CA. FILED 5-30-2000.

PAYCYCLE

FOR ON-LINE HUMAN RESOURCES ADMINISTRATIVE SERVICES (U.S. CLS. 100, 101 AND 102).

SN 76-061,450. HIRE IMPACT, INC., AURORA, CO. FILED 6-1-2000.

HIRE IMPACT

NO CLAIM IS MADE TO THE EXCLUSIVE RIGHT TO USE "HIRE", APART FROM THE MARK AS SHOWN.
FOR EMPLOYEE SEARCH AND RECRUITING SERVICES (U.S. CLS. 100, 101 AND 102).
FIRST USE 6-1-1999; IN COMMERCE 6-1-1999.

SN 76-064,959. PLURIMS CORPORATION, DURHAM, NC. BY CHANGE OF NAME FOVEON CORPORATION, DURHAM, NC. FILED 6-6-2000.

MARKET INSITE

NO CLAIM IS MADE TO THE EXCLUSIVE RIGHT TO USE "MARKET", APART FROM THE MARK AS SHOWN.
FOR PROVIDING ONLINE INFORMATION IN THE FIELDS OF GLOBAL COMPUTER NETWORK USAGE AND MARKET RESEARCH, INCLUDING WEB TRAFFIC ANALYSIS AND REPORTING SERVICES, AND FEATURING GLOBAL COMPUTER NETWORK USAGE PATTERNS AND MARKET TRENDS, AND CONSULTATION SERVICES RELATED THERETO (U.S. CLS. 100, 101 AND 102).

CLASS 35—(Continued).

SN 76-068,050. MOTION INDUSTRIES, INC., BIRMINGHAM, AL. FILED 6-12-2000.



OWNER OF U.S. REG. NO. 1,979,661.
FOR DISTRIBUTORSHIP SERVICES IN THE FIELD OF HYDRAULIC AND PNEUMATIC POWER SYSTEMS, BEARINGS, MECHANICAL TRANSMISSION EQUIPMENT, CONVEYING AND ELEVATING EQUIPMENT, AND FLUID POWER EQUIPMENT (U.S. CLS. 100, 101 AND 102).
FIRST USE 12-14-1973; IN COMMERCE 12-14-1973.

SN 76-071,103. MAXCELL BIOSCIENCE, BROOMFIELD, CO. FILED 6-16-2000.

RECOMMERCE

FOR BUSINESS DEVELOPMENT SERVICES, NAMELY, PROVIDING START-UP SUPPORT FOR BUSINESSES OF OTHERS IN THE AREA OF HEALTH AND WELLNESS PRODUCTS (U.S. CLS. 100, 101 AND 102).
FIRST USE 4-5-1999; IN COMMERCE 4-5-1999.

SN 76-071,945. TILEPOINT.COM, INC., MASSAPEQUA PARK, NY. FILED 6-16-2000.

TILEPOINT.COM

FOR ON-LINE RETAIL STORE SERVICES PROVIDED VIA THE INTERNET IN THE FIELDS OF TILE AND FLOORING (U.S. CLS. 100, 101 AND 102).

SN 76-072,631. INDEPENDENT STATIONERS, INC., INDIANAPOLIS, IN. FILED 6-19-2000.

IS.GROUP

FOR PROCUREMENT, NAMELY, PURCHASING OFFICE SUPPLIES AND OFFICE FURNITURE FOR OTHERS; BUSINESS MARKETING CONSULTING SERVICES; INVENTORY CONTROL; BILLING SERVICES (U.S. CLS. 100, 101 AND 102).
FIRST USE 1-0-1999; IN COMMERCE 1-0-1999.

CLASS 35—(Continued).

SN 76-080,977. MADDENMEDIA, INC., TUCSON, AZ. FILED 6-30-2000.

MADDENMEDIA

FOR PROFESSIONAL CONSULTING SERVICES IN MARKETING, MARKETRESEARCH, SOFTWARE DEVELOPMENT AND WEB-RELATED APPLICATIONS DEVELOPMENT (U.S. CLS. 100, 101 AND 102).

FIRST USE 11-5-1997; IN COMMERCE 11-5-1997.

SN 76-083,853. TAX ANALYSTS, ARLINGTON, VA. FILED 7-6-2000.



OWNER OF U.S. REG. NO. 2,328,102. SEC. 2(F) AS TO "TAX ANALYSTS". FOR PROVIDING INFORMATION IN THE FIELD OF TAX ON A GLOBAL COMPUTER NETWORK (U.S. CLS. 100, 101 AND 102).

FIRST USE 6-7-2000; IN COMMERCE 6-7-2000.

SN 76-086,250. UNIVERSAL IMAGING CORPORATION, DOWNINGTOWN, PA. FILED 7-11-2000.

UNIVERSAL-IMAGING.COM

FOR ELECTRONIC RETAIL SERVICES FEATURING IMAGE PROCESSING AND ANALYSIS COMPUTER SOFTWARE FOR USE BY BIOMEDICAL RESEARCHERS, UNIVERSITY AND INDUSTRIAL RESEARCHERS AND QUALITY CONTROL PERSONNEL FOR PERFORMING APPLICATIONS RELATED TO THREE-DIMENSIONAL RECONSTRUCTION, VIDEO MICROSCOPY, IMAGE ENHANCEMENT, MORPHOMETRIC ANALYSIS, DESITOMETRY AND ON-LINE IMAGE ANALYSIS OF ANY IMAGES THAT ARE CAPABLE OF BEING DIGITIZED INCLUDING BUT NOT LIMITED TO HUMAN, ANIMAL, OR PLANT CELLS OR TISSUE, INDUSTRIAL TOOLS AND TEMPLATES, MACHINE PARTS AND ANY OTHER PRODUCED PRODUCT THAT MAY BE VISUALLY INSPECTED (U.S. CLS. 100, 101 AND 102).

CLASS 35—(Continued).

SN 76-091,529. RETAIL CONVERGENCE, INC., BOSTON, MA. FILED 7-18-2000.

SMARTBARGAINS.COM

OWNER OF U.S. REG. NO. 1,615,232.

FOR ON-LINE RETAIL STORE SERVICES FEATURING OFF-PRICE, CLOSE-OUT, LIQUIDATION, AND MARKED DOWN CLOTHING AND ACCESSORIES, JEWELRY, SPORTING GOODS AND EQUIPMENT, HOME FURNISHINGS AND DECOR, BATH LINENS AND ACCESSORIES, BED LINENS AND ACCESSORIES, CHINA, CRYSTAL, SILVER, KITCHEN AND DINING APPLIANCES AND ACCESSORIES, ELECTRONIC GOODS, AND TOYS (U.S. CLS. 100, 101 AND 102).

FIRST USE 7-18-2000; IN COMMERCE 7-18-2000.

SN 76-101,018. ADMINISTAFF, INC., KINGWOOD, TX. FILED 8-1-2000.



FOR OPERATION OF THE PERSONNEL PART OF A BUSINESS FOR OTHERS, NAMELY, CO-EMPLOYER SERVICES FOR THE PURPOSE OF SERVING AS AN OFFSITE HUMAN RESOURCES DEPARTMENT (U.S. CLS. 100, 101 AND 102).

FIRST USE 2-9-1998; IN COMMERCE 2-9-1998.

SN 76-102,189. DANIEL J. EDELMAN, INC., CHICAGO, IL. FILED 8-3-2000.

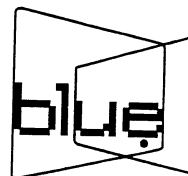

worldwide > colorful advertising

NO CLAIM IS MADE TO THE EXCLUSIVE RIGHT TO USE "WORLDWIDE COLORFUL ADVERTISING", APART FROM THE MARK AS SHOWN.

FOR PUBLIC RELATIONS SERVICES, NAMELY, PROMOTING THE SERVICES OF BROADCAST NETWORKS, POLITICAL MEDIA FIRMS, ADVERTISING AGENCIES AND CORPORATIONS THROUGH THE DISTRIBUTION OF PRINTED, AUDIO AND VIDEO PROMOTIONAL MATERIALS AND BY RENDERING SALES PROMOTION ADVICE; CREATING CORPORATE AND BRAND IDENTITY FOR OTHERS; CREATING CORPORATE LOGOS FOR OTHERS; ADVERTISING AND MARKETING; PROVIDING TELEVISION, RADIO, AND ON-LINE ADVERTISING FOR OTHERS (U.S. CLS. 100, 101 AND 102).

CLASS 35—(Continued).

SN 76-103,839. ROMERO, MARIA, CARPINTERIA, CA. AND ROMERO, SALVADOR, CARPINTERIA, CA. FILED 8-7-2000.



NO CLAIM IS MADE TO THE EXCLUSIVE RIGHT TO USE "MARKET", "EST. 1956", AND " AUTHENTIC MEXICAN FOOD", APART FROM THE MARK AS SHOWN.

FOR MEXICAN FOOD MARKET SERVICES (U.S. CLS. 100, 101 AND 102).

FIRST USE 0-0-1995; IN COMMERCE 0-0-1995.

SN 76-104,603. SIMPLEXIS.COM, INC., SAN FRANCISCO, CA. FILED 8-3-2000.

SIMPLECONTRACTS

FOR PROVIDING A WEBSITE ON THE INTERNET FEATURING INFORMATION IN THE NATURE OF REGIONAL STATEWIDE PURCHASING AGREEMENTS TO ASSIST EDUCATIONAL INSTITUTIONS AND GOVERNMENT ENTITIES IN PURCHASING A WIDE VARIETY OF GOODS AND SERVICES (U.S. CLS. 100, 101 AND 102).

SN 76-108,016. FACECAKE.COM, INC., WOODLAND HILLS, CA. FILED 8-11-2000.

FACECAKE

FOR COMPUTERIZED ONLINE RETAIL SERVICES AND RETAIL STORE SERVICES FEATURING PRODUCTS IN THE COSMETIC INDUSTRY (U.S. CLS. 100, 101 AND 102).

SN 76-110,958. KOHL'S ILLINOIS, INC., AURORA, IL. FILED 8-18-2000.

KOHL'S DEPARTMENT STORES

OWNER OF U.S. REG. NOS. 1,772,009, 2,295,922 AND OTHERS.

NO CLAIM IS MADE TO THE EXCLUSIVE RIGHT TO USE "DEPARTMENT STORES", APART FROM THE MARK AS SHOWN.

SEC. 2(F).

FOR RETAIL DEPARTMENT STORE SERVICES (U.S. CLS. 100, 101 AND 102).

FIRST USE 8-0-1962; IN COMMERCE 8-0-1962.

CLASS 35—(Continued).

SN 76-111,713. MACROMEDIA, INC., SAN FRANCISCO, CA. FILED 8-17-2000.

SHOCKWAVE

OWNER OF U.S. REG. NOS. 1,901,566 AND 2,388,945. FOR DISSEMINATION OF ADVERTISING FOR OTHERS VIA AN ON-LINE ELECTRONIC COMMUNICATIONS NETWORK; COMPUTERIZED ON-LINE RETAIL AND SUBSCRIPTION SERVICES FEATURING VIDEO GAMES, FILMS, VIDEOS, MUSIC, TOYS, RECORDED MUSIC, AND CONCERT TICKETS (U.S. CLS. 100, 101 AND 102).

FIRST USE 2-0-1998; IN COMMERCE 2-0-1998.

SN 76-112,195. BEDDING EXPERTS, INC., THE, CAROL STREAM, IL. FILED 8-18-2000.

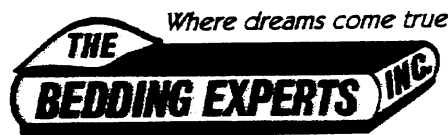

OWNER OF U.S. REG. NO. 1,613,341. NO CLAIM IS MADE TO THE EXCLUSIVE RIGHT TO USE "BEDDING" AND "INC.", APART FROM THE MARK AS SHOWN.

SEC. 2(F) AS TO "THE BEDDING EXPERTS". FOR RETAIL FURNITURE STORE SERVICES (U.S. CLS. 100, 101 AND 102).

FIRST USE 0-0-1984; IN COMMERCE 0-0-1984.

SN 76-112,258. WILLIAMS, SERENA, PALM BEACH GARDENS, FL. FILED 8-18-2000.

SERENA WILLIAMS

THE NAME "SERENA WILLIAMS" IDENTIFIES A LIVING INDIVIDUAL WHOSE CONSENT IS OF RECORD.

FOR PROMOTING THE GOODS AND SERVICES OF OTHERS THROUGH THE ISSUANCE OF PRODUCT ENDORSEMENTS (U.S. CLS. 100, 101 AND 102).

SN 76-114,896. OREN'S DAILY ROAST, INC., NEW YORK, NY. FILED 8-22-2000.

COFFEE ROASTED TO PERFECTION-NOT BEYOND RECOGNITION

FOR RETAIL AND WHOLESALE STORE SERVICES, NAMELY, SPECIALTY STORES FEATURING COFFEE BEANS, TEAS, AND OTHER BEVERAGES (U.S. CLS. 100, 101 AND 102).

FIRST USE 10-0-1996; IN COMMERCE 10-0-1996.

CLASS 35—(Continued).

SN 76-117,407. BRAINSTORMUSA, LLC, ATLANTA, GA.
FILED 8-28-2000.

BRAINSTAR

FOR DIRECT MARKETING SERVICES RELATING TO EDUCATIONAL PRODUCTS AND EQUIPMENT, NAMELY SOFTWARE BUNDLES, COMPUTER HARDWARE, EDUCATION WEB SITE REFERRALS, SCHOLARSHIPS, TUTORING PROGRAMS AND PRESENTATIONS, MATERIALS FOR USE BY EDUCATORS AND PARENTS OF STUDENTS, ALL PROVIDED VIA ELECTRONIC COMMUNICATION MEDIA AND WEB SITES (U.S. CLS. 100, 101 AND 102).

SN 76-117,890. IQ.COMMERCE CORPORATION, SARATOGA, CA. FILED 8-28-2000.

IQOFFERS

FOR ONLINE RETAIL STORE SERVICES IN THE FIELD OF GENERAL MERCHANDISE; CREATING AND PREPARING ONLINE ADVERTISEMENTS FOR OTHERS; INCENTIVE BUSINESS MARKETING CONSULTING SERVICES, NAMELY MERCHANDIZING, COUPONING, INCENTIVE PROGRAMS, SURVEYING, PRODUCT SALES, E-COMMERCE, EMAIL, RICH MEDIA ONLINE ADS, SERVING ADS AND PROMOTIONS, TRACKING PROMOTIONS AND ADS, DATAMINING, SWEEPSTAKES, AND GIVE-AWAYS (U.S. CLS. 100, 101 AND 102).

FIRST USE 4-21-2000; IN COMMERCE 4-21-2000.

SN 76-119,620. 1ST SOURCE BANK, SOUTH BEND, IN.
FILED 8-22-2000.



NO CLAIM IS MADE TO THE EXCLUSIVE RIGHT TO USE "VEHICLE SOURCE", APART FROM THE MARK AS SHOWN.

FOR PROCUREMENT, NAMELY, PURCHASING AUTOS, CARS AND TRUCKS FOR OTHERS (U.S. CLS. 100, 101 AND 102).

SN 76-120,812. CAVE SPRINGS, INC., WILMINGTON, DE.
FILED 9-1-2000.

MOTHERHOOD is everything GOOD..

FOR RETAIL STORE SERVICES FEATURING MATERNITY, INFANTS' AND CHILDREN'S CLOTHING AND ACCESSORIES (U.S. CLS. 100, 101 AND 102).

FIRST USE 8-1-2000; IN COMMERCE 8-1-2000.

CLASS 35—(Continued).

SN 76-120,830. CORPORATE STAFFING SERVICES, INC., ORLANDO, FL. FILED 9-5-2000.

Staffing911

FOR EMPLOYMENT OUTPLACEMENT SERVICES (U.S. CLS. 100, 101 AND 102).

FIRST USE 3-22-2000; IN COMMERCE 3-22-2000.

SN 76-121,227. WELLPOINT HEALTH NETWORKS INC., THOUSAND OAKS, CA. FILED 9-5-2000.

PrecisionRx

FOR MAIL ORDER SERVICES FEATURING PRESCRIPTIONS AND PRESCRIPTION REFILLS; COMPUTERIZED ONLINE ORDERING SERVICES FEATURING PRESCRIPTIONS AND PRESCRIPTION REFILLS (U.S. CLS. 100, 101 AND 102).

SN 76-123,321. RDR HOLDINGS L.L.C., WOODLAND HILLS, CA. FILED 9-5-2000.

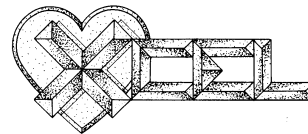

THE STIPPLING IS FOR SHADING PURPOSES ONLY.
FOR RETAIL PHARMACY SERVICES (U.S. CLS. 100, 101 AND 102).

FIRST USE 8-15-1995; IN COMMERCE 1-18-1997.

SN 76-127,989. TD BUSINESS VENTURES, INC., MORRISVILLE, PA. FILED 9-14-2000.

TD PHARMACY RETURNS

NO CLAIM IS MADE TO THE EXCLUSIVE RIGHT TO USE "PHARMACY RETURNS", APART FROM THE MARK AS SHOWN.

FOR BUSINESS SERVICES, NAMELY IDENTIFYING, RETURNING AND PROCESSING PHARMACEUTICAL PRODUCTS ON BEHALF OF PHARMACIES AND OTHER MEDICAL DRUG PROVIDERS (U.S. CLS. 100, 101 AND 102).

FIRST USE 1-15-1994; IN COMMERCE 1-15-1994.

CLASS 35—(Continued).

SN 76-128,640. SDCI LIMITED, HAMILTON, BERMUDA, FILED 9-14-2000.

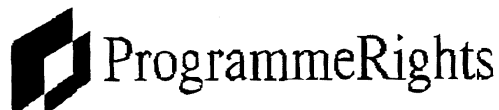

NO CLAIM IS MADE TO THE EXCLUSIVE RIGHT TO USE "PROGRAM RIGHTS", APART FROM THE MARK AS SHOWN.

FOR PROVIDING AN ONLINE WEBSITE FOR OTHERS FOR SELLING AND BUYING OF TELEVISION PROGRAMMING RIGHTS (U.S. CLS. 100, 101 AND 102).

SN 76-129,053. GOLD & DIAMOND MERCHANTS GROUP, INC., SECAUCUS, NJ. FILED 9-15-2000.

CIJNETWORK.NET

FOR CATALOG SERVICES AVAILABLE VIA A GLOBAL COMPUTER NETWORK FEATURING DIAMOND AND GOLD JEWELRY (U.S. CLS. 100, 101 AND 102).

SN 76-130,367. WRENCHSCIENCE, BERKELEY, CA. FILED 9-18-2000.

WRENCHSCIENCE

FOR ON-LINE ORDERING SERVICES IN THE FIELD OF CUSTOMIZED BIKES AND BICYCLE ACCESSORIES (U.S. CLS. 100, 101 AND 102).

SN 76-132,406. JOHNSON, JOYCE F., DBA MAISON DU JOUR, SOUTH EASTON, MA. FILED 9-21-2000.

THE MARK IS COMPRISED OF THE LETTERS "MDJ" IN STYLIZED FORM.

FOR RETAIL STORES FEATURING HOME AND OFFICE FURNISHINGS (U.S. CLS. 100, 101 AND 102).

FIRST USE 11-27-1998; IN COMMERCE 3-3-1999.

CLASS 35—(Continued).

SN 76-133,196. PROGOLF, INC., ENGLEWOOD, CO. FILED 9-21-2000.



PROFESSIONAL
GOLF COMMERCE

NO CLAIM IS MADE TO THE EXCLUSIVE RIGHT TO USE "PROFESSIONAL GOLF COMMERCE", APART FROM THE MARK AS SHOWN.

FOR PROVIDING ONLINE AUCTION AND TRADING SERVICES VIA INTERACTIVE ELECTRONIC CATALOGS AND WEB SITES FOR THE POSTING, PROMOTION, BUYING, SELLING AND TRADING OF GOLF EQUIPMENT APPAREL AND ACCESSORIES (U.S. CLS. 100, 101 AND 102).

FIRST USE 9-0-1999; IN COMMERCE 9-0-1999.

SN 76-134,152. BRAXTON, COLSTON & STAFFORD INSTITUTE, THE, BEVERLY HILLS, CA. FILED 9-19-2000.

UP HEALTH MERCHANTS

NO CLAIM IS MADE TO THE EXCLUSIVE RIGHT TO USE "MERCHANTS", APART FROM THE MARK AS SHOWN.

FOR RETAIL STORES FEATURING NATURAL AND ORGANIC PRODUCTS (U.S. CLS. 100, 101 AND 102).

FIRST USE 7-16-2000; IN COMMERCE 7-16-2000.

SN 76-136,362. THE CAREGIVERS ADVISORY PANEL, INC., CHARLESTOWN, RI. FILED 9-27-2000.

FOR MARKETING RESEARCH SERVICES IN THE MEDICAL PRODUCTS AND SERVICES BUSINESS (U.S. CLS. 100, 101 AND 102).

FIRST USE 6-2-2000; IN COMMERCE 6-2-2000.

SN 76-137,330. 3DLABS INC., LTD., SUNNYVALE, CA. FILED 9-27-2000.

VISUALENT

FOR TECHNOLOGY LICENSING, NAMELY, LICENSING OF INTEGRATED CIRCUITS AND COMPUTER SOFTWARE (U.S. CLS. 100, 101 AND 102).

CLASS 35—(Continued).

SN 76-139,874. IPARTY CORP., NEW YORK, NY. FILED 10-3-2000.

IPARTY.COM

FOR RETAIL STORE SERVICES IN THE FIELD OF PARTY SUPPLIES, CANDY, TOYS, GREETING CARDS, GIFT WRAP, BALLOONS AND GIFTS (U.S. CLS. 100, 101 AND 102).

CLASS 35—(Continued).

SN 76-141,407. SHOES.COM, INC., CHATSWORTH, CA. FILED 10-5-2000.



SN 76-139,918. PENNWELL CORPORATION, TULSA, OK. FILED 10-2-2000.

CLEANROOMS EUROPE

OWNER OF U.S. REG. NOS. 2,054,935, 2,279,416 AND OTHERS.

NO CLAIM IS MADE TO THE EXCLUSIVE RIGHT TO USE "EUROPE", APART FROM THE MARK AS SHOWN.

FOR ARRANGING AND CONDUCTING TRADE SHOW EXHIBITIONS IN THE FIELD OF CONTAMINATION CONTROL (U.S. CLS. 100, 101 AND 102).

NO CLAIM IS MADE TO THE EXCLUSIVE RIGHT TO USE "SHOES.COM", APART FROM THE MARK AS SHOWN.

THE DESIGN IN THE MARK CONSISTS OF A STYLIZED LETTER "S" MADE TO RESEMBLE LEGS WITH A SHOE ON EACH FOOT.

FOR ONLINE RETAIL STORE SERVICES FOR FOOTWEAR BY MEANS OF THE INTERNET (U.S. CLS. 100, 101 AND 102).

FIRST USE 4-0-2000; IN COMMERCE 4-0-2000.

SN 76-142,556. MSC MULTIMEDIA SUPPORT CENTER GMBH, LTD., 50827 KOLN, FED REP GERMANY, FILED 10-6-2000.

GERMANBETA

SN 76-141,066. WAL-MART STORES, INC., BENTONVILLE, AR. FILED 10-4-2000.



NO CLAIM IS MADE TO THE EXCLUSIVE RIGHT TO USE "BABIES", APART FROM THE MARK AS SHOWN.

FOR RETAIL SERVICES IN THE FIELD OF A WIDE VARIETY OF MERCHANDISE (U.S. CLS. 100, 101 AND 102).

FOR BUSINESS ADMINISTRATION, NAMELY, OPERATING OF A BUSINESS FOR OTHERS; BUSINESS MANAGEMENT; ADVERTISING AGENCIES BUSINESS APPRAISALS; BUSINESS INFORMATION IN THE FIELD OF BUSINESS MANAGEMENT; BUSINESS CONSULTATION; BUSINESS AUDITING; MARKET RESEARCH; OPINION POLLING FOR BUSINESS OR ADVERTISING PURPOSES; ORGANIZING TRADE SHOWS FOR THE BUSINESS INDUSTRY FOR COMMERCIAL AND ADVERTISING PURPOSES; PERSONNEL MANAGEMENT CONSULTATION; EMPLOYMENT AGENCIES; PUBLIC RELATIONS; ECONOMIC FORECASTING; MARKET ANALYSIS (U.S. CLS. 100, 101 AND 102).

CLASS 35—(Continued).

SN 76-145,978. DETROIT PISTONS BASKETBALL COMPANY, AUBURN HILLS, MI. FILED 10-10-2000.



OWNER OF U.S. REG. NOS. 1,085,718, 2,320,075 AND OTHERS.

SEC. 2(F) AS TO "DETROIT".

FOR RETAIL STORE SERVICES, COMPUTERIZED ON-LINE RETAIL SERVICES, ON-LINE ORDERING SERVICES, ELECTRONIC RETAILING VIA COMPUTER AND MAIL ORDER CATALOG SERVICES FEATURING AUDIO RECORDINGS, VIDEO RECORDINGS, COMPUTER ACCESSORIES, COMPUTER GAMES, COMPUTER SOFTWARE, COMPUTER DATABASES, VIDEO GAMES, TELEPHONES, BINOCULARS, EYEWEAR, MAGNETS, COLLECTIBLE AND NOVELTY ITEMS, COLLECTIBLE COINS, MEDALLIONS, ALBUMS, SCRAPBOOKS, PHOTO FRAMES, SPORTS MEMORABILIA, TIME-PIECES, JEWELRY, JEWELRY BOXES, CREDIT CARDS, CALLING CARDS, PUBLICATIONS, CALENDARS, CATALOGS, ORGANIZERS, DIRECTORIES, STATIONERY, SCHOOL SUPPLIES, GIFTWARE, GIFT SETS, PORTFOLIOS, POSTERS, PHOTOS, TRADING CARDS, BOOKS, CARD HOLDERS, PAMPHLETS, PENNANTS, FLAGS, BANNERS, SOUVENIRS, CATALOGS, BANK CHECKS, BAGS, TRAVEL BAGS, TRAVEL CASES, SPORTS BAGS, LUNCH BOXES, WALLETS, UMBRELLAS, CLOTHING, TOYS, GAMES, SPORTING GOODS, CHRISTMAS ORNAMENTS, DECORATIONS, HOUSEWARES, LAMPS, LIGHTING FIXTURES, BEVERAGeware, KITCHENWARE, HOUSEHOLD SUPPLIES, CONTAINERS, BOXES, BED, BATH AND TABLE LINENS, FURNITURE, OFFICE FURNITURE AND ACCESSORIES, LOCKERS AND FOOTLOCKERS (U.S. CLS. 100, 101 AND 102).

FIRST USE 5-0-1996; IN COMMERCE 5-0-1996.

CLASS 35—(Continued).

SN 76-147,510. CELTICS BASKETBALL, L.P., BOSTON, MA. FILED 10-4-2000.



OWNER OF U.S. REG. NOS. 1,003,131, 2,323,752 AND OTHERS.

FOR COMPUTERIZED ON-LINE RETAIL STORE SERVICES, COMPUTERIZED ON-LINE ORDERING SERVICES, ELECTRONIC RETAILING SERVICES, COMPUTERIZED CATALOG SERVICES AND MAIL ORDER CATALOG SERVICES, ALL FEATURING AUDIO RECORDINGS, VIDEO RECORDINGS, COMPUTER ACCESSORIES, COMPUTER GAMES, COMPUTER SOFTWARE, COMPUTER DATABASES, VIDEO GAMES, TELEPHONES, BINOCULARS, EYEWEAR, MAGNETS, COLLECTIBLE AND NOVELTY ITEMS, COLLECTIBLE COINS, MEDALLIONS, ALBUMS, SCRAPBOOKS, PHOTO FRAMES, SPORTS MEMORABILIA, TIME-PIECES, JEWELRY, JEWELRY BOXES, CREDIT CARDS, CALLING CARDS, PUBLICATIONS, CALENDARS, CATALOGS, ORGANIZERS, DIRECTORIES, STATIONERY, SCHOOL SUPPLIES, GIFTWARE, GIFT SETS, PORTFOLIOS, POSTERS, PHOTOS, TRADING CARDS, BOOKS, CARD HOLDERS, PAMPHLETS, PENNANTS, FLAGS, BANNERS, SOUVENIRS, CATALOGS, BANK CHECKS, BAGS, TRAVEL BAGS, TRAVEL CASES, SPORTS BAGS, LUNCH BOXES, WALLETS, UMBRELLAS, CLOTHING, TOYS, GAMES, SPORTING GOODS, CHRISTMAS ORNAMENTS, DECORATIONS, HOUSE WARES, LAMPS, LIGHTING FIXTURES, BEVERAGE WARE, KITCHENWARE, HOUSEHOLD SUPPLIES, CONTAINERS, BOXES, BED, BATH AND TABLE LINENS, FURNITURE, OFFICE FURNITURE AND ACCESSORIES, LOCKERS AND FOOTLOCKERS (U.S. CLS. 100, 101 AND 102).

FIRST USE 10-28-1995; IN COMMERCE 10-28-1995.

SN 76-147,614. YANKELOVICH PARTNERS INC., NORWALK, CT. FILED 10-16-2000.

MONITOR MINDBASE

OWNER OF U.S. REG. NOS. 1,664,340 AND 1,665,814.

FOR MARKET RESEARCH SERVICES; BUSINESS MARKETING CONSULTING; BUSINESS CONSULTATION; CONSUMER RESEARCH, NAMELY, CONSUMER PROFILING; INTERNET BUSINESS MARKETING CONSULTING; BUSINESS MARKETING CONSULTING SERVICES FOR NEW AND ESTABLISHED PRODUCTS AND SERVICES; ALL THE FOREGOING PROVIDED BY MEANS OF THE INTERNET; MARKET RESEARCH SERVICES; BUSINESS MARKETING CONSULTING; BUSINESS CONSULTATION; CONSUMER RESEARCH, NAMELY, CONSUMER PROFILING; INTERNET BUSINESS MARKETING CONSULTING; BUSINESS MARKETING CONSULTING SERVICES FOR NEW AND ESTABLISHED PRODUCTS AND SERVICES (U.S. CLS. 100, 101 AND 102).

CLASS 35—(Continued).

SN 76-147,664. PANGAEA GROUP, INC., SANDY, UT. FILED 10-16-2000.

CLICK ALLIANCE

FOR DISSEMINATION OF ADVERTISING FOR OTHERS VIA AN ON-LINE ELECTRONIC COMMUNICATIONS NETWORK (U.S. CLS. 100, 101 AND 102).
FIRST USE 3-1-2000; IN COMMERCE 3-1-2000.

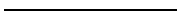

SN 76-150,466. HARLAN, MARY, DBA HARLAN CONSULTING, HOUSTON, TX. FILED 10-19-2000.

INTENT ≠ IMPACT

FOR BUSINESS CONSULTING SERVICES (U.S. CLS. 100, 101 AND 102).



SN 76-150,485. ZEBORG, INC., NEW YORK, NY. FILED 10-19-2000.

**SAVING COMPANIES
MONEY THEY DIDN'T EVEN
KNOW THEY LOST**

FOR BUSINESS TO BUSINESS E-COMMERCE SERVICES, NAMELY AUCTIONING, NEGOTIATION, MANAGEMENT OF PRICE DISCOVERY, TRANSACTION EXECUTION, AND MARKET MONITORING AND ANALYSIS TO EVALUATE INDIRECT GOODS AND SERVICES AND TO FACILITATE PROCUREMENT THEREOF BY OTHERS (U.S. CLS. 100, 101 AND 102).

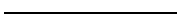

SN 76-152,257. KAUFMAN, HARLEY, NEW YORK, NY. FILED 10-23-2000.

O-O-O

THE MARK CONSISTS OF A SERIES OF "O'S" NOT A SERIES OF ZEROS.

FOR ONLINE DIRECTORY SERVICES FOR PROMOTING AND LISTING THE PRODUCTS AND SERVICES OF OTHERS BY PROVIDING TO CONSUMERS ON RETAIL AND WHOLESALE LEVEL, THE IDENTIFICATIONS AND GEOGRAPHIC LOCATIONS FOR OBTAINING THE PRODUCTS AND SERVICES (U.S. CLS. 100, 101 AND 102).

CLASS 35—(Continued).

SN 76-153,038. CATHOLIC HEALTHCARE AUDIT NETWORK, LLC, ST. LOUIS, MO. FILED 10-24-2000.

HAN

FOR BUSINESS AUDITING, NAMELY AUDIT CONSULTING SERVICES TO ASSIST HEALTHCARE INSTITUTIONS AND ORGANIZATIONS TO MEASURE CONFORMITY WITH STANDARDS FOR CLIENT-PROVIDED HEALTHCARE SERVICES, TO ACCURATELY RECORD AND REPORT FINANCIAL RECORDS, TO COMPLY WITH GOVERNING REGULATIONS, TO INTERNALLY COMPLY WITH POLICIES AND PROCEDURES, TO ACQUIRE AND USE INFORMATION TECHNOLOGY RESOURCES, AND TO PREPARE FOR TRANSACTIONAL DUE DILIGENCE REQUESTS AND REQUIREMENTS (U.S. CLS. 100, 101 AND 102).

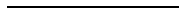

SN 76-155,411. JIM PATTISON LTD., VANCOUVER BRITISH COLUMBIA, CANADA, FILED 10-27-2000.



NO CLAIM IS MADE TO THE EXCLUSIVE RIGHT TO USE "ADVERTISING BY", APART FROM THE MARK AS SHOWN.

FOR ADVERTISING SERVICES, NAMELY PROVIDING ADVERTISING FOR OTHERS ON AIRCRAFT, TRAINS AND BUSES (U.S. CLS. 100, 101 AND 102).



SN 76-156,539. SIMS, STEPHEN D., W. PALM BEACH, FL. FILED 10-31-2000.



FOR PROMOTING THE SALE OF GOODS AND SERVICES OF OTHERS THROUGH THE DISTRIBUTION OF PRINTED MATERIAL AND PROMOTIONAL CONTESTS (U.S. CLS. 100, 101 AND 102).

CLASS 35—(Continued).

SN 76-157,392. TELIGISTICS.COM, THE WOODLANDS, TX. FILED 10-31-2000.

AUDITMYBILL

FOR BUSINESS CONSULTING SERVICES, NAMELY, PROVIDING UTILITY AND TELEPHONY RATE PLAN COMPARISONS FOR DETERMINISTIC UTILITY AND TELEPHONY RATE PLANS (U.S. CLS. 100, 101 AND 102). FIRST USE 1-1-1998; IN COMMERCE 1-1-1998.

SN 76-159,209. DASEIN DESIGN, INC., REDWOOD CITY, CA. FILED 11-6-2000.

DASEIN DESIGN

NO CLAIM IS MADE TO THE EXCLUSIVE RIGHT TO USE "DESIGN", APART FROM THE MARK AS SHOWN.

FOR BUSINESS CONSULTING SERVICES IN THE NATURE OF MARKET AND STRATEGY RESEARCH, STRATEGY FORMULATION, CREATIVE DESIGN MANAGEMENT, BRAND BUILDING AND INTEGRATION, EXECUTIVE MANAGEMENT, PROJECT MANAGEMENT AND TRACKING, AND OPERATIONAL PROCESS MANAGEMENT (U.S. CLS. 100, 101 AND 102). FIRST USE 2-28-1999; IN COMMERCE 2-28-1999.

CLASS 35—(Continued).

SN 76-164,173. CEPHREN, INC., PALO ALTO, CA. FILED 11-14-2000.

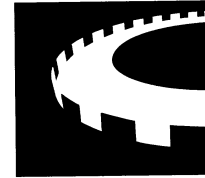
**Citadon**

FOR AUCTIONEERING SERVICES VIA THE INTERNET; ON-LINE TRADING SERVICES IN WHICH SELLERS POST PRODUCTS TO BE AUCTIONED AND BIDDING IS DONE VIA THE INTERNET; PROVIDING A WEBSITE WHEREBY BUYERS OF GOODS OR SERVICES LOCATE AND RECEIVE QUOTATIONS FROM MULTIPLE COMPETITIVE SOURCES AND SELLERS OF GOODS AND SERVICES IDENTIFY AND BID ON MULTIPLE NEW SALES OPPORTUNITIES; CATALOG SERVICES FEATURING CONSTRUCTION EQUIPMENT BY MEANS OF A GLOBAL COMPUTER NETWORK; DOCUMENT REPRODUCTION; COMPUTERIZED DATABASE MANAGEMENT; ON-LINE COMPUTER DATABASE FEATURING TRADE INFORMATION IN THE FIELD OF CONSTRUCTION MANAGEMENT, PROJECT MANAGEMENT, PROJECT ESTIMATING, PROJECT BIDDING, CONSTRUCTION PRODUCTS, CUSTOMER RELATIONSHIP MANAGEMENT, CONSTRUCTION TRANSACTION TRACKING AND MANAGEMENT, CREATING PURCHASE REQUISITIONS AND PURCHASE ORDERS, MONITORING THE STATUS OF PURCHASE ORDERS AND PROVIDING BLUEPRINT ORDER TRACKING; PROCUREMENT SERVICES, NAMELY, PURCHASING CONSTRUCTION SUPPLIES AND MATERIALS FOR OTHERS; WHOLESALE AND RETAIL SERVICES FEATURING CONSTRUCTION SUPPLIES (U.S. CLS. 100, 101 AND 102).

SN 76-164,352. PACE GLOBAL ENERGY SERVICES, LLC, FAIRFAX, VA. FILED 11-13-2000.



FOR BUSINESS SERVICES, NAMELY ENERGY USAGE MANAGEMENT AND ENERGY PURCHASE MANAGEMENT SERVICES; BUSINESS CONSULTING SERVICES IN THE FIELD OF ENERGY USAGE MANAGEMENT AND ENERGY PURCHASE MANAGEMENT (U.S. CLS. 100, 101 AND 102).

FIRST USE 2-26-1999; IN COMMERCE 2-26-1999.

CLASS 35—(Continued).

SN 76-167,657. LYNK INTERNATIONAL GROUP CORP., NEW YORK, NY. FILED 11-20-2000.



LYNK International Group

NO CLAIM IS MADE TO THE EXCLUSIVE RIGHT TO USE "INTERNATIONAL GROUP", APART FROM THE MARK AS SHOWN.

THE MARK CONSISTS OF THE WORDS "LYNK INTERNATIONAL GROUP" AND THE LETTERS "L", "I", AND "G" IN STYLIZED FORMAT SURROUNDING A TRIANGLE THAT IS ATOP THREE ASCENDING HORIZONTAL LINES.

FOR BUSINESS MANAGEMENT CONSULTATION IN THE FIELDS OF SCIENTIFIC STRATEGIC DECISION MAKING AND FORECASTING USING ADVANCED STOCHASTIC DYNAMIC MODELING, ADVANCED AND EMERGING TECHNOLOGIES INCLUDING AERONAUTICS, ASTRONAUTICS AND ROCKET PROPULSION, CREATIVE LEADERSHIP AND MANAGEMENT PROBLEM SOLVING, AND GLOBAL BUSINESS DEVELOPMENT AND INVESTORS' RELATIONS; PUBLIC RELATIONS SERVICES IN THE FIELDS OF MEDIA, IMAGE CRISIS AND PRESTIGE RELATIONS, AND REPRESENTATION, NEGOTIATION AND SHUTTLE DIPLOMACY FOR CONFLICT AND STRATEGIC PROBLEM SOLVING (U.S. CLS. 100, 101 AND 102).

FIRST USE 8-11-2000; IN COMMERCE 8-11-2000.

SN 76-167,658. LYNK INTERNATIONAL GROUP CORP., NEW YORK, NY. FILED 11-20-2000.

LYNK INTERNATIONAL GROUP

NO CLAIM IS MADE TO THE EXCLUSIVE RIGHT TO USE "INTERNATIONAL GROUP", APART FROM THE MARK AS SHOWN.

FOR BUSINESS MANAGEMENT CONSULTATION IN THE FIELDS OF SCIENTIFIC STRATEGIC DECISION MAKING AND FORECASTING USING ADVANCED STOCHASTIC DYNAMIC MODELING, ADVANCED AND EMERGING TECHNOLOGIES INCLUDING AERONAUTICS, ASTRONAUTICS AND ROCKET PROPULSION, CREATIVE LEADERSHIP AND MANAGEMENT PROBLEM SOLVING, AND GLOBAL BUSINESS DEVELOPMENT AND INVESTORS' RELATIONS; PUBLIC RELATIONS SERVICES IN THE FIELDS OF MEDIA, IMAGE CRISIS AND PRESTIGE RELATIONS, AND REPRESENTATION, NEGOTIATION AND SHUTTLE DIPLOMACY FOR CONFLICT AND STRATEGIC PROBLEM SOLVING (U.S. CLS. 100, 101 AND 102).

FIRST USE 8-11-2000; IN COMMERCE 8-11-2000.

CLASS 35—(Continued).

SN 76-168,846. DAVID S. HOYTE, MCCORDSVILLE, IN. FILED 11-21-2000.

TRANSFORMANAGER

FOR BUSINESS CONSULTATION SERVICES, NAMELY, PROVIDING BUSINESS WITH METHODOLOGIES, GUIDANCE, AND LEADERSHIP PROCESSES THAT FACILITATE THE TRANSFORMATION FROM TRADITIONAL OPERATING PRACTICES TO MORE EFFECTIVE TEAM-BASED MANAGEMENT SYSTEMS (U.S. CLS. 100, 101 AND 102).

SN 76-171,498. WALKER INDUSTRIES, INC., CHESTERFIELD, MO. BY ASSIGNMENT OUTDOOR EQUIPMENT COMPANY, CHESTERFIELD, MO. FILED 11-27-2000.

YOUR GROWING PARTNER

FOR RETAIL STORE SERVICES FEATURING GRASS SEED, FERTILIZER AND LAWN CARE EQUIPMENT (U.S. CLS. 100, 101 AND 102).

SN 76-175,247. MINNESOTA TIMBERWOLVES BASKETBALL LIMITED PARTNERSHIP, NORTH MANKATO, MN. FILED 12-4-2000.



OWNER OF U.S. REG. NOS. 2,091,986, 2,212,589 AND OTHERS.

SEC. 2(F) AS TO "MINNESOTA".

FOR ON-LINE RETAIL STORE SERVICES FEATURING AUDIO AND VIDEO RECORDINGS, EYEWEAR, JEWELRY, CLOTHING, TOYS AND OTHER VARIED MERCHANDISE WITH A PROFESSIONAL BASKETBALL THEME (U.S. CLS. 100, 101 AND 102).

FIRST USE 10-28-1995; IN COMMERCE 10-28-1995.

CLASS 35—(Continued).

SN 76-176,116. MIAMI HEAT LIMITED PARTNERSHIP, THE, MIAMI, FL. FILED 12-4-2000.



OWNER OF U.S. REG. NOS. 1,485,605, 2,199,708 AND OTHERS.

SEC. 2(F) AS TO "MIAMI".

FOR ON-RETAIL STORE SERVICES, ON-LINE ORDERING SERVICES, AND MAIL ORDER CATALOG SERVICES FEATURING AUDIO RECORDINGS, VIDEO RECORDINGS, COMPUTER ACCESSORIES, COMPUTER GAMES, COMPUTER SOFTWARE, COMPUTER DATABASES, VIDEO GAMES, TELEPHONES, BINOCULARS, EYEWEAR, MAGNETS, COLLECTIBLE AND NOVELTY ITEMS, COLLECTIBLE COINS, MEDALLIONS, COIN ALBUMS, PHOTOGRAPH ALBUMS, TRADING CARD ALBUMS, SCRAPBOOKS, PHOTO FRAMES, SPORTS MEMORABILIA, TIMEPIECES, NAMELY, WATCHES AND CLOCKS, JEWELRY, JEWELRY BOXES, CREDIT CARDS, CALLING CARDS, PUBLICATIONS, NAMELY, MAGAZINES, BOOKS AND NEWSLETTERS IN THE FIELD OF BASKETBALL, CALENDARS, CATALOGS IN THE FIELD OF BASKETBALL, ORGANIZERS, BLANK DIRECTORIES AND DIRECTORIES IN THE FIELD OF BASKETBALL, STATIONERY, SCHOOL SUPPLIES, GIFTWARE, GIFT SETS, STATIONERY-TYPE PORTFOLIOS, POSTERS, UNMOUNTED PHOTOGRAPHS, MOUNTED PHOTOGRAPHS, TRADING CARDS, REFERENCE BOOKS, YEARBOOKS, CHILDREN'S BOOKS, AND GUIDE BOOKS, ALL IN THE FIELD OF BASKETBALL, ADDRESS AND TELEPHONE BOOKS, COLORING BOOKS, CHILDREN'S ACTIVITY BOOKS, BUSINESS CARD HOLDERS, CREDIT CARD HOLDERS, PAMPHLETS IN THE FIELD OF BASKETBALL, PAPER AND FELT PENNANTS, PAPER AND FELT FLAGS, PLASTIC FLAGS, PAPER AND FELT BANNERS, CLOTH BANNERS, SOUVENIRS, BANK CHECKS, BAGS, NAMELY, TRAVEL BAGS, DUFFEL BAGS, TRAVEL BAGS, TRAVEL CASES SOLD EMPTY FOR TOILETRIES, ALL-PURPOSE SPORTS BAGS, ATHLETIC BAGS, LUNCH BOXES, WALLETS, UMBRELLAS, CLOTHING, TOYS, GAMES, SPORTING GOODS, CHRISTMAS ORNAMENTS, PAPER AND PLASTIC PARTY DECORATIONS, HOUSEWARES, LAMPS, LIGHTING FIXTURES, BEVERAGEWARE, KITCHENWARE, HOUSEHOLD SUPPLIES, ALL-PURPOSE PORTABLE HOUSEHOLD CONTAINERS, CARDBOARD BOXES, ALL-PURPOSE STORAGE CONTAINERS, TOY BOXES, BED, BATH AND TABLE LINENS, FURNITURE, OFFICE FURNITURE AND ACCESSORIES, LOCKERS AND FOOTLOCKERS (U.S. CLS. 100, 101 AND 102).

FIRST USE 10-28-1995; IN COMMERCE 10-28-1995.

CLASS 35—(Continued).

SN 76-182,350. VITAL LEADERSHIP, LLC., GRAND RAPIDS, MI. FILED 12-18-2000.

VITAL LEADERSHIP

NO CLAIM IS MADE TO THE EXCLUSIVE RIGHT TO USE "LEADERSHIP", APART FROM THE MARK AS SHOWN.

FOR CONSULTING SERVICES IN THE FIELD OF BUSINESS AND HUMAN RESOURCE MANAGEMENT (U.S. CLS. 100, 101 AND 102).

SN 76-182,784. FRANK J. CORBETT, INC., CHICAGO, IL. FILED 12-18-2000.

**CORBETT WORLDWIDE
HEALTHCARE
COMMUNICATIONS**

OWNER OF U.S. REG. NO. 1,962,823.

NO CLAIM IS MADE TO THE EXCLUSIVE RIGHT TO USE "WORLDWIDE HEALTHCARE COMMUNICATIONS", APART FROM THE MARK AS SHOWN.

SEC. 2(F) AS TO "CORBETT".

FOR PHARMACEUTICAL MANUFACTURERS AND DISTRIBUTORS, HEALTH CARE PROVIDERS, HEALTH INSURANCE UNDERWRITERS AND ADMINISTRATORS, PREFERRED PROVIDER PLANS, AND OTHER PRODUCERS AND PROVIDERS OF HEALTH CARE-RELATED GOODS AND SERVICES THROUGH THE PREPARATION AND DISTRIBUTION OF PRINTED, AUDIO, AND VIDEO PROMOTIONAL MATERIALS AND BY RENDERING SALES PROMOTION AND MARKETING ADVICE; AND CONSULTATION IN THE FIELD OF ADVERTISING AND MARKETING OF HEALTH CARE-RELATED GOODS AND SERVICES (U.S. CLS. 100, 101 AND 102).

SN 76-183,593. PACIFICARE HEALTH SYSTEMS, INC., DBA PRESCRIPTION SOLUTIONS, SANTA ANA, CA. FILED 12-20-2000.

PAL

FOR PHARMACY BENEFIT SERVICES, NAMELY ELECTRONICALLY DOCUMENTING, TRACKING AND REPORTING CLAIMANT MEDICATION AND DENIAL ACTIVITIES (U.S. CLS. 100, 101 AND 102).

FIRST USE 1-1-1998; IN COMMERCE 1-1-1998.

CLASS 35—(Continued).

SN 76-185,413. COMBS, SEAN PUFFY, NEW YORK, NY. FILED 12-21-2000.

BLUE FLAME MARKETING & ADVERTISING

NO CLAIM IS MADE TO THE EXCLUSIVE RIGHT TO USE "MARKETING & ADVERTISING", APART FROM THE MARK AS SHOWN.

FOR ADVERTISING AGENCY SERVICES; BUSINESS MARKETING AND DIRECT MAIL CONSULTING SERVICES (U.S. CLS. 100, 101 AND 102).

SN 76-186,849. ONDERICK-HARVEY, EDITH, DBA CHANGE DYNAMICS CONSULTING, ANDOVER, MA. FILED 12-26-2000.



c h a n g e d y n a m i c s
c o n s u l t i n g

NO CLAIM IS MADE TO THE EXCLUSIVE RIGHT TO USE "CONSULTING", APART FROM THE MARK AS SHOWN.

FOR STRATEGIC AND MANAGEMENT CORPORATE CONSULTING SERVICES; NAMELY ORGANIZATIONAL DEVELOPMENT INTERVENTIONS TO DRIVE STRATEGIC ALIGNMENT AND TRANSFORMATION (U.S. CLS. 100, 101 AND 102).

FIRST USE 4-0-2000; IN COMMERCE 4-0-2000.

SN 76-187,120. GAUTRAU SPARICO AND ASSOCIATES LLC, NEW YORK, NY. FILED 12-28-2000.

SG²

FOR PROVIDING BUSINESS MANAGEMENT CONSULTATION SERVICES, NAMELY, STRATEGY FORMULATION, TECHNICAL ANALYSIS, NEW BUSINESS DEVELOPMENT, SALES AND MARKETING, AND ORGANIZATIONAL STRUCTURE AND STAFFING, FOR INTERNET-BASED COMPANIES AND OTHERS (U.S. CLS. 100, 101 AND 102).

CLASS 35—(Continued).

SN 76-187,934. SHEAKLEY UNISERVICE, INC., CINCINNATI, OH. FILED 12-29-2000.

ADVANCED HR SOLUTIONS

NO CLAIM IS MADE TO THE EXCLUSIVE RIGHT TO USE "HR", APART FROM THE MARK AS SHOWN.

FOR HUMAN RESOURCES SERVICES, NAMELY, EMPLOYMENT AND PAYROLL VERIFICATION SERVICES (U.S. CLS. 100, 101 AND 102).

FIRST USE 7-0-1995; IN COMMERCE 7-0-1995.

SN 76-189,033. ALL INSTANT, INC., NEW YORK, NY. BY CHANGE OF NAME GDG INTERACTIVE, INC., NEW YORK, NY. FILED 1-3-2001.

ALL INSTANT

NO CLAIM IS MADE TO THE EXCLUSIVE RIGHT TO USE "INSTANT", APART FROM THE MARK AS SHOWN.

FOR DEVELOPING ONLINE PROMOTIONAL, ADVERTISING, AND MARKETING CAMPAIGNS FOR BUSINESS; ONLINE BUSINESS MARKETING CONSULTING SERVICES; DISSEMINATION OF ADVERTISING FOR OTHERS VIA THE INTERNET, OTHER COMPUTER NETWORKS, COMMERCIAL ONLINE NETWORKS, WEB TELEVISION, PORTABLE COMPUTING DEVICES, TELEPHONE, MOBILE TELEPHONE, SATELLITE, CELLULAR AND WIRELESS INFORMATION NETWORKS; OPINION POLLING FOR BUSINESS OR ADVERTISING PURPOSES; AND COMMERCIAL INFORMATION AGENCY SERVICES PROVIDING BUSINESS INFORMATION, MARKETING AND DEMOGRAPHIC DATA (U.S. CLS. 100, 101 AND 102).

SN 76-190,047. ACTION LABOR MANAGEMENT, INC., WEST PALM BEACH, FL. FILED 1-5-2001.



FOR PERSONNEL PLACEMENT AND RECRUITMENT SERVICES (U.S. CLS. 100, 101 AND 102).

FIRST USE 12-1-2000; IN COMMERCE 12-1-2000.

CLASS 35—(Continued).

SN 76-190,048. ACTION LABOR MANAGEMENT, INC., WEST PALM BEACH, FL. FILED 1-5-2001.



OWNER OF U.S. REG. NO. 1,887,400.
NO CLAIM IS MADE TO THE EXCLUSIVE RIGHT TO USE "LABOR & STAFFING", APART FROM THE MARK AS SHOWN.

FOR PERSONNEL PLACEMENT AND RECRUITMENT SERVICES (U.S. CLS. 100, 101 AND 102).
FIRST USE 9-1-2000; IN COMMERCE 9-1-2000.

SN 76-190,544. WOLFRAM RESEARCH, INC., CHAMPAIGN, IL. FILED 1-5-2001.

CALCULATIONCENTER



APPLICANT STATES THAT THE STIPLING CONSTITUTES SHADING.

FOR COMPUTATIONAL COMPUTER SOFTWARE FOR PERFORMING BASIC AND ADVANCED MATHEMATICS, GRAPHICS, DATA ANALYSIS AND SYMBOLIC MATHEMATICS (U.S. CLS. 100, 101 AND 102).

CLASS 35—(Continued).

SN 76-191,140. COBBLESTONE BRIDGE, LLC, CANNON FALLS, MN. FILED 1-8-2001.

COBBLESTONE BRIDGE

FOR WHOLESALE DISTRIBUTORSHIP FEATURING DECORATIVE GIFT AND ART ITEMS, NAMELY, CANDLES, BOOK ENDS, TABLETOP GIFT AND ART ITEMS, NAMELY, FIGURES AND FIGURINES MADE OF RESIN, FIGURES AND FIGURINES MADE OF PORCELAIN, CHRISTMAS WREATH HANGERS, CHRISTMAS STOCKING HOLDERS, SEASONAL ORNAMENTS THAT ARE NOT CHRISTMAS ORNAMENTS, PICTURE FRAMES, SNOW GLOBES, CANDLEHOLDERS, VOTIVE CANDLEHOLDERS, BASKETS, SALT AND PEPPER SHAKERS, COOKIE JARS, DECORATIVE PLATES, CANISTER SETS AND MUSIC BOXES; COLLECTIBLES, NAMELY, TABLETOP GIFT AND ART ITEMS, NAMELY FIGURES AND FIGURINES, CHRISTMAS WREATH HANGERS, CHRISTMAS STOCKING HOLDERS, SEASONAL ORNAMENTS THAT ARE NOT CHRISTMAS ORNAMENTS, PICTURE FRAMES, SNOW GLOBES, CANDLEHOLDERS, VOTIVE CANDLEHOLDERS, BASKETS, SALT AND PEPPER SHAKERS, COOKIE JARS, DECORATIVE PLATES, CANISTER SETS AND MUSIC BOXES; DECORATIONS, NAMELY, CHRISTMAS LIGHTS, CANDLES, TEXTILE WALL HANGINGS, CHRISTMAS TREE ORNAMENTS AND DECORATIONS, CHRISTMAS ORNAMENTS FOR DECORATING TOP OF CHRISTMAS TREES, CHRISTMAS GARLANDS, CHRISTMAS TREE SKIRTS, CHRISTMAS DECORATIVE FIREPLACE OR WALL STOCKINGS, CHRISTMAS WREATHS, DECORATIVE CHRISTMAS WINDSOCKS, CHRISTMAS TABLETOP AND DISPLAY ACCESSORIES, NAMELY, GARLAND, CHRISTMAS SEASONAL DECORATIONS, BASKETS, AND DECORATIVE CONTAINERS; AND DISHES; PAPER GIFT BAGS; GIFT WRAPPING PAPER; BOWS; TISSUE WRAPPING PAPER; PAPER GIFT BOXES; CHRISTMAS CARD HOLDERS AND TABLETOP AND DISPLAY ACCESSORIES FOR THE HOME (U.S. CLS. 100, 101 AND 102).
FIRST USE 10-1-2000; IN COMMERCE 10-1-2000.

SN 76-193,718. HALF MOON BAKERY, INC., CLACKAMAS, OR. FILED 1-12-2001.

HALF MOON BAKERY

NO CLAIM IS MADE TO THE EXCLUSIVE RIGHT TO USE "BAKERY", APART FROM THE MARK AS SHOWN.
FOR COOPERATIVE ADVERTISING AND MARKETING OF CHEESECAKES, BAKED GOODS AND CONFECTIONS (U.S. CLS. 100, 101 AND 102).

SN 76-194,782. NARODETSKY, ALEXANDER, LOS ANGELES, CA. FILED 1-10-2001.

COLLEGE BARGAIN

FOR ON-LINE TRADING SERVICES IN WHICH SELLER POSTS COLLEGE BOOKS TO BE SOLD AND WHERE BUYERS POST COLLEGE BOOKS WANTED TO PURCHASE, AND SALES ARE DONE ELECTRONICALLY (U.S. CLS. 100, 101 AND 102).

FIRST USE 10-1-2000; IN COMMERCE 10-1-2000.

CLASS 35—(Continued).

SN 76-195,524. WAKEFERN FOOD CORP., ELIZABETH, NJ. FILED 1-17-2001.



OWNER OF U.S. REG. NOS. 1,530,270, 2,099,502 AND OTHERS.
NO CLAIM IS MADE TO THE EXCLUSIVE RIGHT TO USE "RX", APART FROM THE MARK AS SHOWN.
FOR RETAIL PHARMACY SERVICES (U.S. CLS. 100, 101 AND 102).
FIRST USE 0-0-1985; IN COMMERCE 0-0-1985.



SN 76-198,172. BORGWARDT, STEPHEN P., MADISON, WI. FILED 1-22-2001.

DOUBLE TAKE

FOR ADVERTISING AND PROMOTIONAL SERVICES, NAMELY, CREATION AND PRODUCTION OF INFORMATIVE, PROMOTIONAL, AND MARKETING DISPLAYS FOR OTHERS BY COMMUNICATION MEANS EXCLUDING TELEVISION (U.S. CLS. 100, 101 AND 102).

CLASS 35—(Continued).

SN 76-198,282. HAWKES, JONATHAN GILES CAMERON, PEWSEY WILTSHIRE SN9 5DL, UNITED KINGDOM, FILED 1-23-2001.



OWNER OF UNITED KINGDOM REG. NO. 2199141, DATED 4-7-2000, EXPIRES 6-4-2009.
THE MARK CONSISTS OF A SOLID SPHERE COMPRISING TWO INTERLOCKING HELICES, EACH WITH A COMMON AXIS OF ROTATION, THE PITCH OF EACH HELIX BEING EQUAL TO THE DIAMETER OF THE SPHERE.
FOR DEVELOPING PROMOTIONAL CAMPAIGNS FOR THE BUSINESS OF OTHERS; PROMOTING THE GOODS AND SERVICES OF OTHERS THROUGH AUDIO VISUAL PRESENTATIONS; PUBLICATION OF PUBLICITY TEXTS (U.S. CLS. 100, 101 AND 102).



SN 76-200,916. CAPECE, BARRY, OAK LEAF, TX. FILED 1-25-2001.



FOR BUSINESS MANAGEMENT SERVICES, NAMELY, ASSISTING OTHERS IN FUNDING, CREATING, DEVELOPMENT AND MANAGEMENT OF THEIR BUSINESSES; COMMERCIAL AND INDUSTRIAL MANAGEMENT ASSISTANCE (U.S. CLS. 100, 101 AND 102).



SN 76-202,346. AFFINITY CORPORATION, WEST HILLS, CA. FILED 1-29-2001.

FRAUDGUARD

FOR ONLINE BUSINESS INVESTIGATIONS IN THE FIELD OF COMPREHENSIVE FRAUD PREVENTION (U.S. CLS. 100, 101 AND 102).
FIRST USE 1-1-2000; IN COMMERCE 2-1-2000.

CLASS 35—(Continued).

SN 76-204,600. ANATOLE'S FABRIC OUTLET, LTD., ST. LOUIS, MO. FILED S.R. 1-31-2001; AM. P.R. 1-30-2002.

Bridalfabric  com

NO CLAIM IS MADE TO THE EXCLUSIVE RIGHT TO USE "BRIDALFABRIC" AND "COM", APART FROM THE MARK AS SHOWN.

FOR ON-LINE RETAIL STORE SERVICES FEATURING FABRICS AND TRIMS FOR APPAREL AND FURNITURE, AND MILLINERY SUPPLIES (U.S. CLS. 100, 101 AND 102).

FIRST USE 1-1-1998; IN COMMERCE 1-1-1998.

SN 76-205,843. DENVER METRO CHAMBER OF COMMERCE, DENVER, CO. FILED 1-25-2001.

CONVERGENCE CORRIDOR

FOR CHAMBER OF COMMERCE SERVICES, NAMELY, PROMOTION OF BUSINESS AND TOURISM IN THE DENVER, COLORADO METROPOLITAN AREA (U.S. CLS. 100, 101 AND 102).

FIRST USE 6-20-2000; IN COMMERCE 6-20-2000.

SN 76-206,304. USADATA.COM, INC., NEW YORK, NY. FILED 2-7-2001.



NO CLAIM IS MADE TO THE EXCLUSIVE RIGHT TO USE "DIRECT MAIL PORTAL", APART FROM THE MARK AS SHOWN.

THE STIPPLING IN THE DRAWING APPEARS FOR SHADING PURPOSE ONLY.

THE MARK CONSISTS IN PART OF A PAIR OF STYLIZED STAMPS AND A STYLIZED ENVELOPE.

FOR PROVIDING CUSTOMIZED MAILING LISTS AND MARKETING INFORMATION BY MEANS OF THE INTERNET, INTRANETS AND EXTRANETS (U.S. CLS. 100, 101 AND 102).

FIRST USE 3-0-2000; IN COMMERCE 3-0-2000.

CLASS 35—(Continued).

SN 76-207,476. NBTY, INC., BOHEMIA, NY. FILED 2-9-2001.



NO CLAIM IS MADE TO THE EXCLUSIVE RIGHT TO USE "INC.", APART FROM THE MARK AS SHOWN.

FOR MAIL ORDER, RETAIL AND WHOLESALE STORE SERVICES ALL IN THE FIELD OF DIETARY, HERBAL, MINERAL AND VITAMIN SUPPLEMENTS; DISTRIBUTORSHIPS IN THE FIELD OF DIETARY, HERBAL, MINERAL AND VITAMIN SUPPLEMENTS; DIRECT MARKETING ADVERTISING FOR OTHERS IN THE FIELD OF DIETARY, HERBAL, MINERAL AND VITAMIN SUPPLEMENTS (U.S. CLS. 100, 101 AND 102).

FIRST USE 7-24-1979; IN COMMERCE 7-24-1979.

SN 76-208,847. RNK, INC., DEDHAM, MA. FILED 2-13-2001.

BUCKET OF MINUTES

NO CLAIM IS MADE TO THE EXCLUSIVE RIGHT TO USE "MINUTES", APART FROM THE MARK AS SHOWN.

FOR BUSINESS MANAGEMENT CONSULTATION AND BILLING (U.S. CLS. 100, 101 AND 102).

FIRST USE 11-1-2000; IN COMMERCE 11-1-2000.

SN 76-209,143. REYES, PEDRO J, DBA OUT TO GOLF, TAMPA, FL. FILED 2-13-2001.

OUT TO GOLF

FOR PROMOTING THE GOODS AND SERVICES OF OTHERS BY PREPARING AND PLACING WEBLINKS ON A WEBSITE ACCESSED THROUGH THE INTERNET IN THE FIELD OF GOLF, NAMELY, PROMOTING GOLF PRODUCTS, GOLF ESTABLISHMENTS, AND GOLF MEMBERSHIPS (U.S. CLS. 100, 101 AND 102).

FIRST USE 2-1-2001; IN COMMERCE 2-1-2001.

CLASS 35—(Continued).

SN 76-209,238. MOTION INDUSTRIES, INC., BIRMINGHAM, AL. FILED 2-12-2001.



OWNER OF U.S. REG. NO. 1,979,661.

NO CLAIM IS MADE TO THE EXCLUSIVE RIGHT TO USE "INDUSTRIES", APART FROM THE MARK AS SHOWN.

FOR DISTRIBUTORSHIPS IN THE FIELD OF HYDRAULIC AND PNEUMATIC POWER SYSTEMS, BEARINGS, MECHANICAL POWER TRANSMISSION EQUIPMENT, ELECTRICAL POWER TRANSMISSION EQUIPMENT, CONVEYING AND ELEVATING EQUIPMENT, FLUID POWER TRANSMISSION EQUIPMENT, AND HOSE PRODUCTS (U.S. CLS. 100, 101 AND 102).
FIRST USE 0-0-1976; IN COMMERCE 0-0-1976.

SN 76-209,393. NBTY, INC., BOHEMIA, NY. FILED 2-14-2001.

NBTY INC.

NO CLAIM IS MADE TO THE EXCLUSIVE RIGHT TO USE "INC.", APART FROM THE MARK AS SHOWN.

FOR MAIL ORDER, RETAIL AND WHOLESALE STORE SERVICES ALL IN THE FIELD OF DIETARY, HERBAL, MINERAL AND VITAMIN SUPPLEMENTS; DISTRIBUTORSHIPS IN THE FIELD OF DIETARY, HERBAL, MINERAL AND VITAMIN SUPPLEMENTS; DIRECT MARKETING ADVERTISING FOR OTHERS IN THE FIELD OF DIETARY, HERBAL, MINERAL AND VITAMIN SUPPLEMENTS (U.S. CLS. 100, 101 AND 102).
FIRST USE 7-24-1979; IN COMMERCE 7-24-1979.

SN 76-210,904. RJ MUNA INC., SAN FRANCISCO, CA. FILED 2-16-2001.

SILENT PICTURES GALLERY

NO CLAIM IS MADE TO THE EXCLUSIVE RIGHT TO USE "GALLERY", APART FROM THE MARK AS SHOWN.

FOR COMPUTERIZED ONLINE RETAIL SERVICES IN THE FIELD OF FINE ART (U.S. CLS. 100, 101 AND 102).
FIRST USE 1-3-2001; IN COMMERCE 1-3-2001.

SN 76-212,050. INFOTOPIA, INC., RAYHAM, MA. FILED 2-16-2001.

BETTER PRODUCTS FOR A BETTER WORLD

FOR PRODUCING TELEVISION AND RADIO INFORMATIONALS (U.S. CLS. 100, 101 AND 102).
FIRST USE 10-0-2000; IN COMMERCE 10-0-2000.

CLASS 35—(Continued).

SN 76-217,272. INERCORE, INC., LANTANA, FL. FILED 2-28-2001.

PEO CONNECT

NO CLAIM IS MADE TO THE EXCLUSIVE RIGHT TO USE "PEO", APART FROM THE MARK AS SHOWN.

FOR PROVIDING INFORMATION REGARDING EMPLOYEE BENEFIT PLANS AND STAFF LEASING VIA THE INTERNET (U.S. CLS. 100, 101 AND 102).
FIRST USE 12-20-2000; IN COMMERCE 12-20-2000.

SN 76-218,066. NEW FLYER INDUSTRIES, LTD., WINNIPEG, MANITOBA R2C - 3T4, CANADA, FILED 3-1-2001.

VCOM

FOR COLLECTING AND MONITORING TRANSIT BUS SYSTEM PERFORMANCE AND OPERATING DATA AND ROUTING SUCH INFORMATION TO A REMOTE LOCATION FOR TRACKING AND RESPONSE (U.S. CLS. 100, 101 AND 102).

SN 76-219,470. NATIONAL ACADEMY OF RECORDING ARTS & SCIENCES, SANTA MONICA, CA. FILED 3-6-2001.

GRAMMY ART OF MUSIC

FOR ONLINE AUCTION SERVICES FEATURING GENERAL CONSUMER GOODS, SUCH AS ARTISTIC WORKS AND MUSIC CDS, TAPES, AND RECORDS; PROVIDING HOME SHOPPING SERVICES IN THE FIELD OF GENERAL CONSUMER GOODS, SUCH AS ARTISTIC WORKS AND MUSIC CDS, TAPES, AND RECORDS BY MEANS OF TELEVISION (U.S. CLS. 100, 101 AND 102).

SN 76-220,887. HBR COMPUTER STORES, INC., DBA HBR TECHNOLOGIES, CARROLLTON, TX. FILED 3-5-2001.

HBR

FOR RETAIL SERVICES FEATURING COMPUTER HARDWARE, SOFTWARE SYSTEMS AND OTHER COMPUTER RELATED EQUIPMENT; BUSINESS CONSULTATION IN THE FIELD OF COMPUTER NETWORK SALES (U.S. CLS. 100, 101 AND 102).

CLASS 35—(Continued).

SN 76-220,898. HBR COMPUTER STORES, INC., DBA HBR TECHNOLOGIES, CARROLLTON, TX. FILED 3-5-2001.

THE POWER IS IN THE PARTNERSHIP

FOR RETAIL SERVICES FEATURING COMPUTER HARDWARE, SOFTWARE SYSTEMS, AND OTHER COMPUTER RELATED EQUIPMENT; BUSINESS CONSULTATION IN THE FIELD OF COMPUTER NETWORK SALES (U.S. CLS. 100, 101 AND 102).

FIRST USE 10-1-1999; IN COMMERCE 10-1-1999.

SN 76-223,200. MOTION INDUSTRIES, INC., BIRMINGHAM, AL. FILED 3-12-2001.

Mi HOSE AND RUBBER

OWNER OF U.S. REG. NO. 1,979,661.

NO CLAIM IS MADE TO THE EXCLUSIVE RIGHT TO USE "HOSE AND RUBBER", APART FROM THE MARK AS SHOWN.

FOR DISTRIBUTORSHIPS IN THE FIELD OF INDUSTRIAL AND HYDRAULIC HOSE PRODUCTS; AND INDUSTRIAL GRADE BELTS FOR USE WITH MECHANICAL POWER TRANSMISSION EQUIPMENT, NAMELY, ENDLESS BELTS, METRIC BELTS, POLY-CHAIN BELTS, ROUND BELTS, TIMING BELTS, VARIABLE SPEED BELTS, AND V-BELTS (U.S. CLS. 100, 101 AND 102).

FIRST USE 7-0-2000; IN COMMERCE 7-0-2000.

SN 76-224,568. TRANS WORLD NEW YORK, LLC, ALBANY, NY. FILED 3-14-2001.

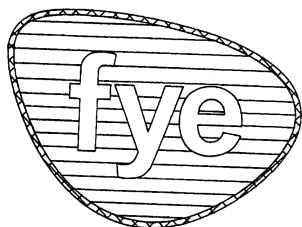

OWNER OF U.S. REG. NOS. 1,870,180 AND 1,880,186. THE MARK CONSISTS OF THE LOWER CASE LETTERS "fye" WHICH ARE INSIDE OF AN OVAL BLUE SHAPE WHICH HAS AN ORANGE BORDER.

FOR RETAIL STORE SERVICES IN THE FIELD OF PRE-RECORDED MUSIC AND VIDEO PRODUCTS, BOOKS, INTERACTIVE GAMES AND GAME ROOM MACHINES (U.S. CLS. 100, 101 AND 102).

CLASS 35—(Continued).

SN 76-227,174. BODY GROUP, INC., LAS VEGAS, NV. FILED 3-20-2001.

BODY ART & SCIENCE

FOR DISTRIBUTORSHIP SERVICES IN THE FIELD OF SKIN AND HAIR CARE PREPARATIONS, SPECIALTY FOODS AND SUPPLEMENTS, NAMELY, COSMETIC, ANTI-AGING, NUTRITIONAL, FOOD, HERBAL, DIETARY AND LONGEVITY PRODUCTS (U.S. CLS. 100, 101 AND 102).

FIRST USE 9-1-2000; IN COMMERCE 9-1-2000.

SN 76-227,877. SAMOUNA, MAZIN, ROSEVILLE, MI. FILED 3-20-2001.

SMOKERS OUTLET

NO CLAIM IS MADE TO THE EXCLUSIVE RIGHT TO USE "OUTLET", APART FROM THE MARK AS SHOWN. SEC. 2(F).

FOR RETAIL OUTLETS FEATURING TOBACCO AND TOBACCO RELATED PRODUCTS (U.S. CLS. 100, 101 AND 102).

FIRST USE 7-6-1994; IN COMMERCE 7-6-1994.

SN 76-229,934. YAVNEH DAY SCHOOL, CINCINNATI, OH. FILED 3-23-2001.

JAM (JEWISH ARTS MARKETPLACE)

NO CLAIM IS MADE TO THE EXCLUSIVE RIGHT TO USE "JEWISH ARTS MARKETPLACE", APART FROM THE MARK AS SHOWN.

FOR RETAIL GIFT AND BOOK STORE (U.S. CLS. 100, 101 AND 102).

FIRST USE 11-0-2000; IN COMMERCE 11-0-2000.

SN 76-231,068. EXECUTIVE LEADERSHIP GROUP, INC., ELIZABETH, CO. FILED 3-26-2001.

IMPLEMENTATION STRENGTH

NO CLAIM IS MADE TO THE EXCLUSIVE RIGHT TO USE "IMPLEMENTATION", APART FROM THE MARK AS SHOWN.

FOR BUSINESS MANAGEMENT CONSULTATION, NAMELY, ADVISING IN THE FIELD OF ORGANIZATIONAL STRUCTURE AND STRATEGY IMPLEMENTATION (U.S. CLS. 100, 101 AND 102).

FIRST USE 1-0-2000; IN COMMERCE 9-0-2000.

CLASS 35—(Continued).

SN 76-232,107. COUNTRY PEDDLERS AND COMPANY OF AMERICA, INC., THE, ALSIP, IL. FILED 3-28-2001.

AT HOME AMERICA

NO CLAIM IS MADE TO THE EXCLUSIVE RIGHT TO USE "AMERICA", APART FROM THE MARK AS SHOWN.

FOR BUSINESS CONSULTATION IN THE FIELD OF RETAIL SALES OF GENERAL MERCHANDISE AND GENERAL CONSUMER GOODS: RETAIL STORE, MAIL ORDER CATALOG, SHOP AT HOME PARTIES, ON-LINE RETAIL AND MAIL ORDER SERVICES FEATURING GENERAL MERCHANDISE AND GENERAL CONSUMER GOODS, NAMELY, ANTIQUES, DOMESTIC APPLIANCES, AROMA/SCENT PRODUCTS, BAKEWARE, BAKING/COOKING UTENSILS, BASKETS AND BASKETWARE, BATHROOM ACCESSORIES, BEDDING, BOWLS, CANDLES, CERAMICS, CHRISTMAS ORNAMENTS, CLOTHING, CLOCKS, COAT AND HAT RACKS, COLLECTABLES, COOKWARE, COSMETICS, CRAFTS, CUPS, DOORMATS, ELECTRONICS, FRAMED PRINTS, FURNITURE, GARDENING, ACCESSORIES, GIFTS, GRILLS, HANDBAGS, HOUSEWARES, JEWELRY, KITCHENWARE, LAMPS, NAPKINS, LUGGAGE, OIL LAMPS, PICNIC ACCESSORIES, PICTURE FRAMES, PLACEMATS, PLATES, POTHOLDERS, POTPOURRI, RUGS, SAUCERS, SERVING TRAYS, SPORTING GOODS, STORAGE CONTAINERS, TABLECLOTHS, TABLES, TABLEWARE, TOWELS, TOYS, VASES, WALL HANGINGS, WINE RACKS, WOODEN PLAQUES AND WOODEN SHELVES (U.S. CLS. 100, 101 AND 102).

SN 76-235,350. PERFORMANCEBASE.COM, CORP., NEW YORK, NY. FILED 3-28-2001.

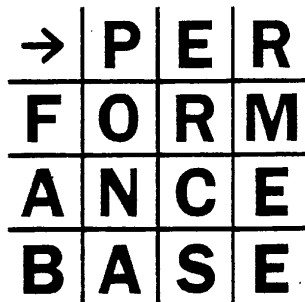

OWNER OF U.S. REG. NO. 2,458,852. NO CLAIM IS MADE TO THE EXCLUSIVE RIGHT TO USE "PERFORMANCE BASE", APART FROM THE MARK AS SHOWN.

FOR CONSULTING SERVICES IN THE FIELD OF EMPLOYEE MANAGEMENT AND EMPLOYEE ADMINISTRATION (U.S. CLS. 100, 101 AND 102).

FIRST USE 9-0-2000; IN COMMERCE 9-0-2000.

CLASS 35—(Continued).

SN 76-235,455. EBAY INC., SAN JOSE, CA. FILED 4-4-2001.



NO CLAIM IS MADE TO THE EXCLUSIVE RIGHT TO USE "GUARANTEE", APART FROM THE MARK AS SHOWN.

THE MARK FEATURES THE FOLLOWING COLOR SCHEME - AN UPWARD TURNED COLOR DASH ABOVE THE "I" IN LIGHT BLUE AND A DOWNWARD TURNED COLOR DASH ABOVE THE "I" IN YELLOW.

FOR ON-LINE TRADING SERVICES IN WHICH SELLER POSTS ITEMS TO BE SOLD AT A SET PRICE OR ALTERNATIVELY, IN AN AUCTION-STYLE FORMAT WHERE BIDDING IS DONE ELECTRONICALLY, AND PROVIDING EVALUATIVE FEEDBACK AND RATINGS OF SELLERS' GOODS AND SERVICES, THE VALUE AND PRICES OF SELLERS' GOODS, BUYERS' AND SELLERS' PERFORMANCE, DELIVERY AND OVERALL TRADING EXPERIENCE IN CONNECTION THEREWITH (U.S. CLS. 100, 101 AND 102).

FIRST USE 1-4-2001; IN COMMERCE 1-4-2001.

SN 76-235,635. DURON, INC., BELTSVILLE, MD. FILED 4-5-2001.

PAINTERS ADVANTAGE

NO CLAIM IS MADE TO THE EXCLUSIVE RIGHT TO USE "PAINTERS", APART FROM THE MARK AS SHOWN.

FOR PROVIDING TECHNICAL ASSISTANCE IN THE ESTABLISHMENT AND/OR OPERATION OF PAINTING AND DECORATING BUSINESSES (U.S. CLS. 100, 101 AND 102).

SN 76-236,815. NACLEARING, L.L.C., JERSEY CITY, NJ. FILED 4-5-2001.



NO CLAIM IS MADE TO THE EXCLUSIVE RIGHT TO USE "NACLEARING", APART FROM THE MARK AS SHOWN.

FOR BUSINESS INFORMATION MANAGEMENT IN THE FIELDS OF SECURITIES BROKERAGE SERVICES, INVESTMENT SERVICES AND OTHER RELATED FINANCIAL SERVICES, AND TELECOMMUNICATIONS SERVICES, NAMELY OUTSOURCING, MAINTAINING, MANAGING, CORRECTING, RECONCILING AND ANALYZING CUSTOMER DATA OVER A PRIVATE COMPUTER NETWORK (U.S. CLS. 100, 101 AND 102).

CLASS 35—(Continued).

SN 76-236,849. PEDIATRIC PHYSICIAN ALLIANCE, INC., NORCROSS, GA. FILED 4-9-2001.



FOR BUSINESS MANAGEMENT AND CONSULTATION SERVICES FOR OFFICE-BASED MEDICAL PRACTICES AND ORGANIZATIONS IN THE FIELD OF HEALTHCARE (U.S. CLS. 100, 101 AND 102).
FIRST USE 11-15-2000; IN COMMERCE 1-15-2001.

SN 76-237,871. PEDIATRIC PHYSICIAN ALLIANCE, INC., NORCROSS, GA. FILED 4-9-2001.

INTEGRIMED

FOR BUSINESS MANAGEMENT AND CONSULTATION SERVICES FOR OFFICE-BASED MEDICAL PRACTICES AND ORGANIZATIONS IN THE FIELD OF HEALTHCARE (U.S. CLS. 100, 101 AND 102).
FIRST USE 11-15-2000; IN COMMERCE 1-15-2001.

SN 76-237,972. OMI GEMS INC., LOS ANGELES, CA. FILED 4-9-2001.

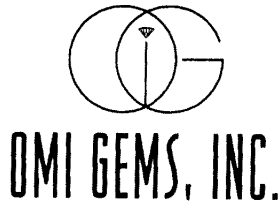

NO CLAIM IS MADE TO THE EXCLUSIVE RIGHT TO USE "GEMS, INC.", APART FROM THE MARK AS SHOWN.
FOR WHOLESALE DISTRIBUTORSHIP FEATURING COLORED GEMSTONES, PRECIOUS AND SEMI-PRECIOUS (U.S. CLS. 100, 101 AND 102).
FIRST USE 11-1-1985; IN COMMERCE 11-1-1985.

CLASS 35—(Continued).

SN 76-238,493. TOOL TOWN HARDWARE AND SUPPLY CO., INC., PARAMUS, NJ. FILED 4-10-2001.



OWNER OF U.S. REG. NO. 1,538,610.
NO CLAIM IS MADE TO THE EXCLUSIVE RIGHT TO USE "TOOL", APART FROM THE MARK AS SHOWN.
FOR RETAIL HARDWARE STORE SERVICES (U.S. CLS. 100, 101 AND 102).
FIRST USE 5-7-1956; IN COMMERCE 5-7-1956.

SN 76-240,572. NOBLE COMMUNICATIONS COMPANY, SPRINGFIELD, MO. FILED 4-12-2001.

BRANDMOTION

FOR ADVERTISING AND MARKETING SERVICES, NAMELY, BUSINESS MARKETING CONSULTING SERVICES; PREPARING BRAND MATERIALS FOR USE IN BROADCAST, PRINT, WEB-BASED AND IN-STORE ADVERTISING AND PROMOTING THE GOODS AND SERVICES OF OTHERS BY USING THE BRANDING MATERIALS FOR USE IN ADVERTISING AND MARKETING SERVICES AND BUSINESS MARKETING CONSULTING SERVICES (U.S. CLS. 100, 101 AND 102).
FIRST USE 4-9-2001; IN COMMERCE 4-9-2001.

SN 76-240,726. ACXIOM CORPORATION, LITTLE ROCK, AR. FILED 4-13-2001.

INFOBASE BESTADDRESS

OWNER OF U.S. REG. NO. 2,460,830.
FOR PREPARING MAILING LISTS AND TARGET CUSTOMER LISTS, AND IMPROVING THE ACCURACY AND DELIVERABILITY OF THE MAILING LISTS AND TARGET CUSTOMER LISTS OF OTHERS BY CORRECTING ERRONEOUS INFORMATION IN THOSE LISTS (U.S. CLS. 100, 101 AND 102).
FIRST USE 1-20-2000; IN COMMERCE 1-20-2000.

SN 76-241,247. BULLHORN, INC., BOSTON, MA. FILED 4-16-2001.

BULLHORN STAFFING

OWNER OF U.S. REG. NO. 2,449,121.
NO CLAIM IS MADE TO THE EXCLUSIVE RIGHT TO USE "STAFFING", APART FROM THE MARK AS SHOWN.
FOR PROVIDING RECRUITMENT AND PLACEMENT SERVICES TO EMPLOYEES, EMPLOYERS AND EMPLOYMENT AGENCIES; PREPARING AUDIO AND/OR VISUAL PRESENTATIONS OF EMPLOYEES AND EMPLOYERS FOR USE IN ADVERTISING EMPLOYEE QUALIFICATIONS AND EMPLOYMENT OPPORTUNITIES (U.S. CLS. 100, 101 AND 102).

CLASS 35—(Continued).

SN 76-241,679. MEREDITH, GEOFFREY E., DBA LIFE-STAGE MATRIX MARKETING, LAFAYETTE, CA. FILED 4-11-2001.

LIFESTAGE MATRIX MARKETING

OWNER OF U.S. REG. NOS. 1,886,805 AND 1,898,442.
NO CLAIM IS MADE TO THE EXCLUSIVE RIGHT TO USE "MATRIX MARKETING", APART FROM THE MARK AS SHOWN.

SEC. 2(F).

FOR CONDUCTING MARKETING STUDIES, MARKET RESEARCH SERVICES, MARKET ANALYSIS SERVICES, BUSINESS AND MARKETING CONSULTATION SERVICES, PRODUCT MERCHANDISING SERVICE, PUBLIC RELATIONS SERVICES; ADVERTISING SERVICES, NAMELY, PROMOTING THE SALE OF GOODS AND SERVICES OF OTHERS THROUGH THE DISTRIBUTION OF PRINTED AND ELECTRONIC PROMOTIONAL MATERIALS AND CONTESTS HELD IN CONNECTION THEREWITH, AND ADVERTISING AGENCIES, NAMELY, PROVIDING DIRECT MAIL ADVERTISING SERVICES (U.S. CLS. 100, 101 AND 102).

FIRST USE 10-0-1992; IN COMMERCE 10-0-1992.

SN 76-244,722. ZIMMERMAN, RACHEL, PHILADELPHIA, PA. FILED 4-20-2001.

INLIQUID.COM

FOR ART GALLERY SERVICES ACCESSIBLE VIA A GLOBAL COMPUTER NETWORK (U.S. CLS. 100, 101 AND 102).

FIRST USE 9-1-1999; IN COMMERCE 9-1-1999.

SN 76-254,254. HARRELL, ANDRE, NEW YORK, NY. FILED 5-8-2001.

NUAMERICA

FOR ADVERTISING AGENCY SERVICES (U.S. CLS. 100, 101 AND 102).

SN 76-257,113. DELAWARE CAPITAL FORMATION, INC., WILMINGTON, DE. FILED 5-15-2001.



FOR COMPUTERIZED ON-LINE ORDERING SERVICES FEATURING PUMP PARTS AND HARD TO FIND PUMP PARTS (U.S. CLS. 100, 101 AND 102).

FIRST USE 3-0-2001; IN COMMERCE 3-0-2001.

CLASS 35—(Continued).

SN 76-259,873. WATSON, PAUL, MELBOURNE, AUSTRALIA, FILED 5-21-2001.

HOTPOINTS

FOR PROMOTING THE GOODS AND SERVICES OF OTHERS THROUGH THE ADMINISTRATION OF INCENTIVE REWARD PROGRAMS; PROMOTING THE SALE OF GOODS AND SERVICES OF OTHERS THROUGH INCENTIVE REWARD PROGRAMS (U.S. CLS. 100, 101 AND 102).

SN 76-263,581. BACK TO BED, INC., BLOOMINGDALE, IL. FILED 5-25-2001.

BACK TO BED

FOR RETAIL STORE SERVICES FEATURING BEDROOM FURNITURE AND OTHER BEDROOM ACCESSORIES, MATTRESSES, BOX SPRINGS, BEDDING, NAMELY, PILLOWS, SHEETS, BLANKETS, BED COVERS, MATTRESS PADS AND PILLOW CASES; RETAIL STORE SERVICES ALSO FEATURING BACK CARE PRODUCTS, FEATURING MASSAGERS, CHAIRS, AND OTHER PRODUCTS TO CARE FOR A PERSON'S BACK (U.S. CLS. 100, 101 AND 102).

FIRST USE 4-0-2001; IN COMMERCE 4-0-2001.

SN 76-264,159. DEPARTMENT OF THE NAVY, ARLINGTON, VA. FILED 5-31-2001.



FOR PROVIDING BUSINESS INFORMATION, NAMELY PROVIDING INFORMATION IN THE FIELD OF PROCUREMENT, SERVICE CONTRACTING, AND BUYING AND SELLING PROFESSIONAL SUPPORT SERVICES FOR THE FEDERAL GOVERNMENT; LOGISTICS MANAGEMENT AND BUSINESS MANAGEMENT IN THE FIELD OF PROCUREMENT AND SERVICE CONTRACTING FOR THE FEDERAL GOVERNMENT (U.S. CLS. 100, 101 AND 102).

FIRST USE 4-2-2001; IN COMMERCE 4-2-2001.

CLASS 35—(Continued).

SN 76-266,815. VIGNEAULT, NELSON, CALGARY ALBERTA, T2G 3M3, CANADA, FILED 6-4-2001.



THE MARK CONSISTS IN PART OF A STYLIZED HUMAN FACE.

FOR PROVIDING AN ONLINE INTERACTIVE COMPUTER DATABASE FOR OTHERS IN THE FIELD OF CORPORATE DIGITAL BRANDING ASSETS, NAMELY, LOGOS, ADVERTISEMENTS, PRODUCT PICTURES, VIDEO AND SOUND CLIPS (U.S. CLS. 100, 101 AND 102).



SN 76-270,996. GREENBACKS, INC., SALT LAKE CITY, UT. FILED 6-13-2001.



OWNER OF U.S. REG. NOS. 1,900,182 AND 1,940,197. FOR RETAIL STORE SERVICES FEATURING GENERAL CONSUMER MERCHANDISE (U.S. CLS. 100, 101 AND 102). FIRST USE 11-0-1993; IN COMMERCE 11-0-1993.



SN 76-271,054. GREENBACKS, INC., SALT LAKE CITY, UT. FILED 6-13-2001.

ALL A DOLLAR

SEC. 2(F). FOR RETAIL STORE SERVICES FEATURE GENERAL CONSUMER MERCHANDISE (U.S. CLS. 100, 101 AND 102). FIRST USE 8-0-1991; IN COMMERCE 8-0-1991.

CLASS 35—(Continued).

SN 76-272,113. LEARNING IS FUN, LAS VEGAS, NV. FILED 6-14-2001.

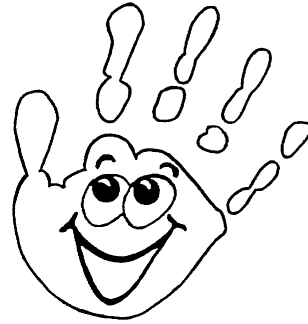

FOR RETAIL STORE SERVICES AND MAIL ORDER CATALOG SERVICES FEATURING PRINTED MATERIAL AND EDUCATIONAL MATERIALS, NAMELY BOOKS AND VIDEOCASSETTES (U.S. CLS. 100, 101 AND 102).

FIRST USE 8-25-1999; IN COMMERCE 8-25-1999.



SN 76-275,714. SOLARCOM HOLDINGS, INC., NORCROSS, GA. FILED 6-21-2001.



FOR ONLINE ORDERING SERVICES FEATURING COMPUTER HARDWARE, SOFTWARE AND SUPPLIES FOR COMPUTERS AND PRINTERS (U.S. CLS. 100, 101 AND 102).

FIRST USE 1-24-2001; IN COMMERCE 1-24-2001.

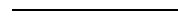

SN 76-283,086. BBDO CHICAGO INC., CHICAGO, IL. FILED 7-11-2001.

POWHER

FOR ADVERTISING AGENCY SERVICES; PUBLIC RELATIONS SERVICES; MARKET RESEARCH SERVICES; DIRECT MARKETING SERVICES FOR OTHERS; BUSINESS MARKETING CONSULTING SERVICES; BUSINESS MARKETING CONSULTING SERVICES IN THE FIELD OF ADVERTISING AND MARKETING VIA THE INTERNET (U.S. CLS. 100, 101 AND 102).

CLASS 35—(Continued).

SN 76-284,814. NORTH AMERICA TRADE SHOWS, INC., MIAMI BEACH, FL. FILED 7-16-2001.



THE PORTRAIT WHICH IS PART OF THE MARK DOES NOT DEPICT A LIVING INDIVIDUAL.

FOR ARRANGING AND CONDUCTING TRADE SHOWS PROMOTING BUSINESS IN BRAZIL IN THE FIELDS OF HIGH TECHNOLOGY, INFORMATION TECHNOLOGY, THE INTERNET, AND TELECOMMUNICATIONS; AND PROVIDING BUSINESS INFORMATION ABOUT BRAZIL IN THE FIELDS OF TECHNOLOGY, INFORMATION TECHNOLOGY, THE INTERNET, AND TELECOMMUNICATIONS (U.S. CLS. 100, 101 AND 102).

FIRST USE 3-31-1995; IN COMMERCE 3-31-1995.

SN 76-285,659. CROSS MEDIA MARKETING, CORP., NEW YORK, NY. FILED 7-16-2001.

PREMIA

FOR RETAIL STORE SERVICES FEATURING APPLIANCES, AUTOMOTIVE PRODUCTS, CAMPING EQUIPMENT, CLOTHING AND SHOES, ELECTRONICS, FURNITURE, ATHLETIC AND SPORTING GOODS EQUIPMENT, GIFTWARE, FLOWERS, HARDWARE, HEALTH AND PERSONAL CARE PRODUCTS, KITCHENWARE, LAWN AND GARDEN PRODUCTS, LUGGAGE, MUSIC, MEDICAL SUPPLIES, OFFICE SUPPLIES, OPTICAL SUPPLIES, PET PRODUCTS, PHOTOGRAPHY PRODUCTS, POOL TABLES AND EQUIPMENT, SAFETY AND SECURITY EQUIPMENT, TABLEWARE AND DISHES, JEWELRY; PROMOTING THE GOODS AND SERVICES OF OTHERS BY MEANS OF A CUSTOMER MEMBERSHIP PROGRAM FEATURING BONUS AND INCENTIVE PROGRAMS BASED UPON EXPENDITURES BY THE PROGRAM MEMBERS (U.S. CLS. 100, 101 AND 102).

FIRST USE 6-25-2001; IN COMMERCE 6-25-2001.

SN 76-289,971. TELECORP, INC., CARROLLTON, TX. FILED 7-25-2001.

TELECORP

FOR ACQUIRING TELECOMMUNICATIONS EQUIPMENT OF OTHERS FOR DISTRIBUTION TO AFTER-MARKET RETAILERS AND CUSTOMERS (U.S. CLS. 100, 101 AND 102).

FIRST USE 2-0-1993; IN COMMERCE 2-0-1993.

CLASS 35—(Continued).

SN 76-290,309. MEYER, PETER H., 33602 BIELEFELD, FED REP GERMANY, FILED 7-25-2001.

ZOW

OWNER OF FED REP GERMANY REG. NO. 2095440, DATED 4-25-1995, EXPIRES 3-16-2004.

FOR ARRANGING AND CONDUCTING TRADE SHOW EXHIBITIONS IN THE FIELDS OF FURNITURE, INTERIOR DECORATION, DOMESTIC LIGHTING, FURNITURE PRODUCTION MATERIALS, FURNITURE PRODUCTION CONSTRUCTIONAL PARTS, FURNITURE PRODUCTION ACCESSORIES, FURNITURE PRODUCTION MACHINES, FURNITURE PRODUCTION TOOLS, FURNITURE PRODUCTION EQUIPMENT AND AIDS, WOOD AND INTERIOR DESIGN, INTERIOR LIGHTING, AND FURNISHINGS; AND ORGANIZING EXHIBITIONS FOR ALL COMMERCIAL OR ADVERTISING PURPOSES RELATED TO FURNITURE, WOOD AND INTERIOR DESIGN AND THEIR PRODUCTION (U.S. CLS. 100, 101 AND 102).

SN 76-292,260. PROSAVVY, INC., ENGLEWOOD, CO. FILED 7-31-2001.

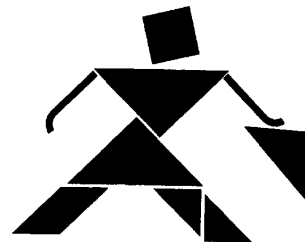

THE MARK CONSISTS OF THE DESIGN OF A PERSON MADE OF GEOMETRIC SHAPES.

FOR BUSINESS CONSULTING SERVICES; MATCHING PROFESSIONAL SERVICES PROVIDERS WITH BUSINESSES IN NEED OF SUCH PROFESSIONAL SERVICES (U.S. CLS. 100, 101 AND 102).

FIRST USE 4-30-2001; IN COMMERCE 5-12-2001.

SN 76-292,425. COPE, KENNETH L., O'FALLON, IL. FILED 7-31-2001.

WE SELL FUN

FOR RETAIL STORE SERVICES FEATURING NEW AND USED BOATS, BOAT MOTORS, BOAT TRAILERS, MARINE ACCESSORIES AND PARTS (U.S. CLS. 100, 101 AND 102).

FIRST USE 12-0-1972; IN COMMERCE 12-0-1972.

CLASS 35—(Continued).

SN 76-292,479. TOWNSEND ENGINEERING COMPANY, DES MOINES, IA. FILED 7-31-2001.

ULTRASERVICE

FOR DISTRIBUTORSHIP IN THE FIELD OF COMPONENT PARTS FOR MEAT PROCESSING EQUIPMENT (U.S. CLS. 100, 101 AND 102).
FIRST USE 12-31-1996; IN COMMERCE 12-31-1996.

SN 76-293,642. WINE NEWS, INC., ELMSFORD, NY. FILED 8-1-2001.

INTERNATIONAL WINE ENTHUSIASTS

OWNER OF U.S. REG. NOS. 1,396,180 AND 1,678,908.
NO CLAIM IS MADE TO THE EXCLUSIVE RIGHT TO USE "INTERNATIONAL WINE", APART FROM THE MARK AS SHOWN.
FOR CATALOG AND MAIL ORDER SERVICES IN THE FIELD OF WINE AND WINE RELATED ACCESSORIES (U.S. CLS. 100, 101 AND 102).

SN 76-294,797. KOHL'S ILLINOIS, INC., AURORA, IL. FILED 8-6-2001.

MÁS COMO A TI TE GUSTA

OWNER OF U.S. REG. NO. 2,095,246.
THE ENGLISH TRANSLATION OF THE MARK IS "MORE OF THE WAY YOU LIKE IT".
FOR RETAIL DEPARTMENT STORE SERVICES (U.S. CLS. 100, 101 AND 102).

SN 76-298,120. SKOP, BONNIE F., DEERFIELD BEACH, FL. FILED 8-13-2001.

TOAST TO HUMANITY

FOR PROMOTING GOODS AND SERVICES OF OTHERS IN THE WINE INDUSTRY, NAMELY, PREPARATION OF PROMOTIONAL MERCHANDISING MATERIALS (U.S. CLS. 100, 101 AND 102).

SN 76-298,293. RAMSAY, CAROLE BADIV, CLA, RM, POMPANO BEACH, FL. FILED 8-14-2001.

A DAY OF SELF-DISCOVERY

FOR PROMOTING AND CONDUCTING TRADE SHOWS IN THE FIELD OF ALTERNATIVE HEALTH AND WELLNESS (U.S. CLS. 100, 101 AND 102).
FIRST USE 7-1-2001; IN COMMERCE 7-1-2001.

CLASS 35—(Continued).

SN 76-300,527. DIGITAL RIVER, INC., EDEN PRAIRIE, MN. FILED 8-16-2001.

REGNOW

FOR REVERSE LOGISTICS IN THE FIELD OF COMPUTER SOFTWARE (U.S. CLS. 100, 101 AND 102).
FIRST USE 8-0-1999; IN COMMERCE 8-0-1999.

SN 76-301,592. CMTM, INCORPORATED, SAN DIEGO, CA. FILED 8-20-2001.

CMTM, INCORPORATED

NO CLAIM IS MADE TO THE EXCLUSIVE RIGHT TO USE "INCORPORATED", APART FROM THE MARK AS SHOWN.
FOR PROVIDING BUSINESS MARKETING INFORMATION VIA A GLOBAL COMPUTER NETWORK (U.S. CLS. 100, 101 AND 102).
FIRST USE 1-28-2001; IN COMMERCE 1-28-2001.

SN 76-302,791. BEST AT HOME LLC, ALBANY, NY. FILED 8-22-2001.

BESTATHOME

FOR PRE-SCREENING AND REFERRAL OF PERSONAL AND PROFESSIONAL SERVICES FOR INDIVIDUALS IN THE FIELDS OF TRANSPORTATION, LAWN CARE, SNOW REMOVAL, HOUSEKEEPING, MEAL PREPARATION, SHOPPING, COMPANIONSHIP, APPLIANCE REPAIRS, HOME REPAIRS, MAINTENANCE, NEWSPAPER AND MAIL START-STOP INSTRUCTIONS, HOUSE WATCHING, COMPUTER INTERNET CONNECTION, MAIL PROCESSING AND CORRESPONDENCE ASSISTANCE, BILL PAYING, MEDICAL, LEGAL, FINANCIAL, AND TRAVEL (U.S. CLS. 100, 101 AND 102).

SN 76-308,368. PAPPAS, STEPHEN L., ARLINGTON, VA. FILED 9-4-2001.

WHERE KNOWLEDGE GAINED IS VALUE REALIZED

FOR BUSINESS CONSULTING SERVICES, NAMELY PROVIDING ADVICE TO OTHERS REGARDING BUSINESS MANAGEMENT, AND RESEARCH ON BUSINESS ISSUES (U.S. CLS. 100, 101 AND 102).
FIRST USE 5-19-2001; IN COMMERCE 5-19-2001.

CLASS 35—(Continued).

SN 76-311,515. DIGITAL ARTIST MANAGEMENT, INC., EL SEGUNDO, CA. FILED 9-10-2001.

JOBSMACK

FOR PROVIDING A WEBSITE FEATURING INFORMATION IN THE FIELD OF EMPLOYMENT, RECRUITING, JOB PLACEMENT AND REFERRALS (U.S. CLS. 100, 101 AND 102).

FIRST USE 3-22-2001; IN COMMERCE 3-22-2001.

SN 76-315,686. FAMILY FARM GIFTS, INC., MARSHFIELD, WI. FILED 9-21-2001.

BUSINESS IN GOOD TASTE

FOR MAIL ORDER SERVICES IN THE FIELD OF FOODS (U.S. CLS. 100, 101 AND 102).

SN 76-316,538. ADVANCED MARKETING, INC., CHARLOTTE, NC. FILED 9-25-2001.

LETTUCE MAKE YOUR MEAL

FOR BUSINESS MARKETING CONSULTING SERVICES AND COOPERATIVE ADVERTISING AND MARKETING OF PACKAGED SALADS (U.S. CLS. 100, 101 AND 102).

FIRST USE 5-14-2001; IN COMMERCE 5-14-2001.

SN 76-316,685. REXEL, INC., DALLAS, TX. FILED 9-25-2001.



OWNER OF U.S. REG. NOS. 2,124,121 AND 2,127,573.
NO CLAIM IS MADE TO THE EXCLUSIVE RIGHT TO USE "GLOBAL INFORMATION SYSTEM", APART FROM THE MARK AS SHOWN.

FOR WHOLESALE DISTRIBUTORSHIP SERVICES IN THE FIELD OF ELECTRICAL SUPPLIES, LIGHTING FIXTURES AND DATA AND TELECOMMUNICATIONS PRODUCTS (U.S. CLS. 100, 101 AND 102).

CLASS 35—(Continued).

SN 76-317,141. JENUWINE ARTICLES, INC., TROY, MI. FILED 9-26-2001.



NO CLAIM IS MADE TO THE EXCLUSIVE RIGHT TO USE "DETROIT" OR "CIGAR", APART FROM THE MARK AS SHOWN.

FOR MARKETING SERVICES FOR OTHERS, NAMELY, HOSTING SOCIAL EVENTS FOR THE DISTRIBUTION OF CIGARS (U.S. CLS. 100, 101 AND 102).

FIRST USE 6-1-2000; IN COMMERCE 6-1-2000.

SN 76-317,614. DAN'S COMPETITION, INC., MT. VERNON, IN. FILED 9-26-2001.



OWNER OF U.S. REG. NOS. 2,176,580 AND 2,176,911.
FOR RETAIL STORE SERVICES AND ONLINE RETAIL SERVICES FEATURING BICYCLES, BICYCLE PARTS AND CLOTHING AND ACCESSORIES USED THEREWITH, AND MAIL ORDER CATALOGUE SERVICES AND ONLINE RETAIL ORDERING SERVICES FEATURING BICYCLES, BICYCLE PARTS AND CLOTHING AND ACCESSORIES USED THEREWITH (U.S. CLS. 100, 101 AND 102).

FIRST USE 9-29-1997; IN COMMERCE 9-29-1997.

SN 76-319,548. TGC, INC., ORLANDO, FL. FILED 10-2-2001.



OWNER OF U.S. REG. NOS. 1,940,162, 2,117,545 AND OTHERS.

FOR PROVIDING ON-LINE BUSINESS INFORMATION ABOUT THE GOODS AND SERVICES OF OTHERS AND DISSEMINATING ADVERTISING OF OTHERS VIA THE INTERNET, ALL RELATED TO GOLF AND GOLFING (U.S. CLS. 100, 101 AND 102).

CLASS 35—(Continued).

SN 76-320,399. DAYTON PROFESSIONAL BASEBALL CLUB, LLC, DAYTON, OH. FILED 10-1-2001.

DRAGONS DEN

FOR RETAIL OUTLET FEATURING BASEBALL TEAM MERCHANDISE IN THE NATURE OF SPORTS EQUIPMENT, CLOTHING AND SPORTS TEAM-RELATED PROMOTIONAL ITEMS (U.S. CLS. 100, 101 AND 102).

FIRST USE 5-3-1999; IN COMMERCE 5-3-1999.

SN 76-324,038. MUFFLER 1 AMERICA CORPORATION, NEW YORK, NY. FILED 10-12-2001.



NO CLAIM IS MADE TO THE EXCLUSIVE RIGHT TO USE "MUFFLER" AND "AMERICA", APART FROM THE MARK AS SHOWN.

FOR WHOLESALE OUTLET SERVICES IN THE FIELD OF AUTOMOTIVE EQUIPMENT (U.S. CLS. 100, 101 AND 102).

SN 76-325,566. ROGER B. DIGBY AND PATRICIA A. DIGBY PARTNERSHIP, THE, ALACHUA, FL. FILED 10-15-2001.

TIKI JIM'S

FOR RETAIL STORE SERVICES FOR GIFT AND SOUVENIR ITEMS, NAMELY CARDS, KEY CHAINS, HATS, STUFFED ANIMALS, TOYS, PICTURE FRAMES, POSTERS, AND CERAMICS, ADULT AND CHILDREN'S CLOTHING (U.S. CLS. 100, 101 AND 102).

FIRST USE 7-1-1997; IN COMMERCE 7-15-1997.

CLASS 35—(Continued).

SN 76-328,187. CUCORP, INCORPORATED, PLYMOUTH, MI. FILED 10-22-2001.

HRCURE

FOR PERSONNEL AND ADMINISTRATIVE SERVICES, NAMELY, ASSISTING CREDIT UNIONS WITH HUMAN RESOURCE SERVICES, INCLUDING DEVELOPING MANDATORY COMPLIANCE MANUALS, MANAGING COBRA COMPLIANCE, SIMPLIFYING THE INTERVIEW PRE-SCREENING PROCESS, PROVIDING PERFORMANCE APPRAISAL TOOLS, MANAGING COMPENSATION/SALARY STRUCTURE, DEVELOPING EMPLOYEE HANDBOOKS AND JOB DESCRIPTIONS, DEVELOPING OPERATION MANUALS, DISASTER RECOVERY MANUALS, PROVIDING BACK-OFFICE SERVICES RELATED TO HUMAN RESOURCE SERVICE AND DEVELOPMENT AND PROVIDING OF RECRUITMENT PRE-SCREENING SERVICES (U.S. CLS. 100, 101 AND 102).

FIRST USE 6-0-2001; IN COMMERCE 6-0-2001.

SN 76-329,545. RICHMOND METROPOLITAN CONVENTION AND VISITORS BUREAU, RICHMOND, VA. FILED 10-18-2001.

EASY TO LOVE

FOR PROMOTING BUSINESS AND ECONOMIC DEVELOPMENT IN THE RICHMOND METROPOLITAN AREA (U.S. CLS. 100, 101 AND 102).

SN 76-331,931. TRISTAR PRODUCTS, INC., PARSIPPANY, NJ. FILED 10-31-2001.

TV INVENTIONS

FOR RETAIL STORE SERVICES PROVIDED OVER THE INTERNET FOR THE SALE OF A WIDE VARIETY OF GOODS (U.S. CLS. 100, 101 AND 102).

FIRST USE 9-0-2000; IN COMMERCE 9-0-2000.

CLASS 35—(Continued).

SN 76-332,313. D'ARCY MASIUS BENTON AND BOWLES INTERNATIONAL, INC., NEW YORK, NY. FILED 10-30-2001.



FOR ADVERTISING AGENCY SERVICES IN ALL MEDIA (U.S. CLS. 100, 101 AND 102).

SN 76-333,235. UNITED DOMINION INDUSTRIES, INC., MUSKEGON, MI. FILED 11-2-2001.

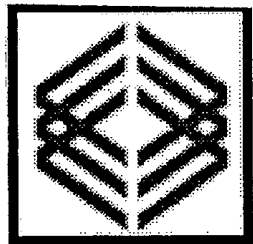

THE STIPPLING IS A FEATURE OF THE MARK AND DOES NOT INDICATE COLOR.
FOR DISTRIBUTORSHIP SERVICES IN THE FIELD OF MATERIAL HANDLING PRODUCTS (U.S. CLS. 100, 101 AND 102).
FIRST USE 0-0-1962; IN COMMERCE 0-0-1962.

SN 76-333,256. NATIONAL WOODEN PALLET AND CONTAINER ASSOCIATION, ALEXANDRIA, VA. FILED 11-5-2001.

PALLETCENTRAL

FOR COMPUTER SERVICES, NAMELY, PROVIDING A WEB SITE VIA THE GLOBAL COMPUTER NETWORK FEATURING INFORMATION ABOUT A MEMBERSHIP ORGANIZATION FOR THE PALLET INDUSTRY (U.S. CLS. 100, 101 AND 102).

CLASS 35—(Continued).

SN 76-333,406. MCGRATH, THOMAS J., ANCHORAGE, AK. FILED 11-2-2001.

FRIGID NORTH COMPANY

NO CLAIM IS MADE TO THE EXCLUSIVE RIGHT TO USE "COMPANY", APART FROM THE MARK AS SHOWN.
FOR DISTRIBUTORSHIP, WHOLESALE STORES, WHOLESALE ORDERING SERVICES, RETAIL STORE, MAIL ORDER CATALOG AND ON-LINE ELECTRONIC ORDERING SERVICES ALL FEATURING INDUSTRIAL, COMMERCIAL AND GENERAL ELECTRONIC, BRAND NAME ELECTRONIC, ELECTRICAL, TELECOMMUNICATIONS, TELEPHONE, RADIO AND COMPUTER PARTS, PRODUCTS, SUPPLIES, COMPONENTS, ACCESSORIES, TOOLS AND EQUIPMENT, TESTING EQUIPMENT, WIRE AND CABLE (U.S. CLS. 100, 101 AND 102).
FIRST USE 9-1-1979; IN COMMERCE 9-1-1979.

SN 76-333,407. MCGRATH, THOMAS J., ANCHORAGE, AK. FILED 11-2-2001.



NO CLAIM IS MADE TO THE EXCLUSIVE RIGHT TO USE "COMPANY" AND "ELECTRONIC TELECOM & COMPUTER PARTS SUPPLY", APART FROM THE MARK AS SHOWN.
FOR DISTRIBUTORSHIP, WHOLESALE STORES, WHOLESALE ORDERING SERVICES, RETAIL STORE, MAIL ORDER CATALOG AND ON-LINE ELECTRONIC ORDERING SERVICES ALL FEATURING INDUSTRIAL, COMMERCIAL AND GENERAL ELECTRONIC, BRAND NAME ELECTRONIC, ELECTRICAL, TELECOMMUNICATIONS, TELEPHONE, RADIO AND COMPUTER PARTS, PRODUCTS, SUPPLIES, COMPONENTS, ACCESSORIES, TOOLS AND EQUIPMENT, TESTING EQUIPMENT, WIRE AND CABLE (U.S. CLS. 100, 101 AND 102).
FIRST USE 11-24-2000; IN COMMERCE 11-27-2000.

SN 76-333,532. EUROBRAND, LTD., DUBLIN, OH. FILED 11-1-2001.

eurobrand

FOR COMPUTERIZED ON-LINE RETAIL SERVICES IN THE FIELD OF OFFICE FURNITURE, DIRECT RESPONSE RETAIL SERVICES BY MEANS OF PRINT AND ELECTRONIC SOLICITATIONS IN THE FIELD OF OFFICE FURNITURE, AND RETAIL SERVICES BY DIRECT SOLICITATION BY SALES AGENTS IN THE FIELD OF OFFICE FURNITURE (U.S. CLS. 100, 101 AND 102).

CLASS 35—(Continued).

SN 76-334,635. KARAM, JIM, CARLSBAD, CA. FILED 11-7-2001.

IF YOU DON'T BUY FROM US, WE BOTH LOSE MONEY!

FOR AUTOMOBILE DEALERSHIPS (U.S. CLS. 100, 101 AND 102).

SN 76-334,751. MATTRESS DISCOUNTERS CORPORATION, UPPER MARLBORO, MD. FILED 11-6-2001.

Have a good night's sleep on us.

OWNER OF U.S. REG. NOS. 1,382,786, 1,676,268 AND 1,754,344.

FOR RETAIL STORE SERVICES FEATURING MATTRESSES, BOX SPRINGS, BED FRAMES AND BEDDING (U.S. CLS. 100, 101 AND 102).

SN 76-334,844. THOMAS & BETTS INTERNATIONAL, INC., SPARKS, NV. FILED 11-6-2001.

T&B ACCESS

NO CLAIM IS MADE TO THE EXCLUSIVE RIGHT TO USE "ACCESS", APART FROM THE MARK AS SHOWN.

FOR COMPUTERIZED ON-LINE PRODUCT ORDERING SERVICES FEATURING ELECTRICAL, ELECTRONIC, LIGHTING AND HEATING PRODUCTS AND FOR RELATED EQUIPMENT AND ACCESSORIES, OFFERED VIA A GLOBAL COMPUTER NETWORK (U.S. CLS. 100, 101 AND 102).

FIRST USE 10-1-2000; IN COMMERCE 10-1-2000.

SN 76-335,831. FURNITURE MARKETING GROUP, INC., DALLAS, TX. FILED 11-7-2001.

WAVE

FOR STRATEGIC FACILITY ASSET AND MANAGEMENT SERVICES, NAMELY, TRACKING, REPORTING, ANALYZING, MANAGING AND DELIVERING FURNITURE ORDER, INVENTORY, CONFIGURATION, MAINTENANCE, REFURBISHMENT, REMOVAL, AND COST INFORMATION VIA AN ONLINE GLOBAL COMPUTER NETWORK (U.S. CLS. 100, 101 AND 102).

CLASS 35—(Continued).

SN 76-336,059. TODD HARRIS COMPANY, INC., EDISON, NJ. FILED 11-9-2001.

AQUATISING, INC.

NO CLAIM IS MADE TO THE EXCLUSIVE RIGHT TO USE "INC.", APART FROM THE MARK AS SHOWN.

FOR ADVERTISING SERVICES FOR OTHERS UTILIZING WATER-BASED ADVERTISING APPLICATIONS AND PRODUCTS, NAMELY, INFLATABLES, SAILS, FLOATING BILLBOARDS, TOWABLE BILLBOARDS, PARASAILS AND THE LIKE (U.S. CLS. 100, 101 AND 102).

SN 76-336,354. WILLIAMS-SONOMA, INC., SAN FRANCISCO, CA. FILED 11-9-2001.

EVERYTHING YOU NEED FOR EVERY ROOM IN YOUR HOME

FOR RETAIL STORE SERVICES, ONLINE RETAIL STORE SERVICES AND CATALOG MAIL ORDER SERVICES FEATURING HOUSEWARES, GLASSWARE, TABLEWARE, FLATWARE, INDOOR AND OUTDOOR FURNITURE, PILLOWS, SLIP COVERS, TABLE LINENS, BED AND BATH LINENS AND ACCESSORIES, BATH OILS, SKIN CARE LOTIONS AND OILS, CANDLES AND CANDLE HOLDERS, PICTURE FRAMES, MIRRORS, VASES, BASKETS, RUGS, LAMPS AND LIGHTING FIXTURES, CURTAINS, CURTAIN RODS, DRAPERY HARDWARE, WINDOW SHADES, WALL COVERINGS, INTERIOR WALL AND FURNITURE PAINT, INTERIOR DECORATING BOOKS, FABRIC FOR WINDOW TREATMENTS AND UPHOLSTERY (U.S. CLS. 100, 101 AND 102).

SN 76-338,566. POWER BUYING DEALERS, USA, INC., OAKBROOK, IL. FILED 11-15-2001.

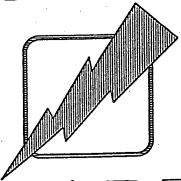
POWER

 MART

THE MARK AS IT APPEARS ON THE DRAWING IS LINED/SHADED TO DESIGNATE COLOR AS INDICATED BELOW, SAID DESIGNATED COLORS BEING A CLAIMED FEATURE OF THE MARK - LIGHTNING BOLT - RED, "O" IN "POWER" - RED, "A" IN "MART" - RED ALL OTHER LINES AND LETTERS - BLUE.

FOR FRANCHISING SERVICES, NAMELY, OFFERING TECHNICAL ASSISTANCE IN THE ESTABLISHMENT AND OPERATION OF RETAIL CONVENIENCE STORES FEATURING GASOLINE (U.S. CLS. 100, 101 AND 102).

CLASS 35—(Continued).

SN 76-338,966. TECHNOMIC, INC., CHICAGO, IL. FILED 11-19-2001.

BESTRENDS

FOR MARKET RESEARCH IN THE NATURE OF BRAND EVALUATION AND SHARE TRENDS IN THE RESTAURANT INDUSTRY (U.S. CLS. 100, 101 AND 102).
FIRST USE 10-1-2001; IN COMMERCE 10-1-2001.

SN 76-339,060. GRAONIC, MILOS, YARDLEY, PA. FILED 11-19-2001.

@FUTURES

FOR BUSINESS MARKETING RESEARCH SERVICES, NAMELY, ASSESSMENT OF PRODUCT SALES POTENTIAL PRIOR TO LAUNCH, PRODUCT POSITIONING, OPTIMAL MARKET STRATEGY, SALES FORECASTING, PRODUCT PRICING, PRODUCT LAUNCH TRACKING, DESIGN-TO-COST TRACKING AND RETURN-ON-INVESTMENT ANALYSIS, WEB SITE STRATEGY AND ANALYSIS, PROMOTION MIX MODELING, CONSUMER CHOICE MODELING, AND MARKET ANALYSIS USING LATENT CLASS SEGMENTATION METHODOLOGY (U.S. CLS. 100, 101 AND 102).
FIRST USE 4-1-1999; IN COMMERCE 4-1-1999.

SN 76-339,061. GRAONIC, MILOS, YARDLEY, PA. FILED 11-19-2001.

INNOVATION IN YOUR FUTURE

FOR BUSINESS MARKETING RESEARCH SERVICES, NAMELY, ASSESSMENT OF PRODUCT SALES POTENTIAL PRIOR TO LAUNCH, PRODUCT POSITIONING, OPTIMAL MARKET STRATEGY, SALES FORECASTING, PRODUCT PRICING, PRODUCT LAUNCH TRACKING, DESIGN-TO-COST TRACKING AND RETURN-ON-INVESTMENT ANALYSIS, WEB SITE STRATEGY AND ANALYSIS, PROMOTION MIX MODELING, CONSUMER CHOICE MODELING, AND MARKET ANALYSIS USING LATENT CLASS SEGMENTATION METHODOLOGY (U.S. CLS. 100, 101 AND 102).
FIRST USE 4-1-1999; IN COMMERCE 4-1-1999.

SN 76-341,579. MOLAR MOUNTAIN ENTERPRISES, LLC, GREENSBORO, GA. FILED 11-26-2001.

MOLAR MOUNTAIN

FOR CARTOON CHARACTER LICENSING (U.S. CLS. 100, 101 AND 102).

CLASS 35—(Continued).

SN 76-343,435. ASSOCIATION OF AMERICAN MEDICAL COLLEGES, WASHINGTON, DC. FILED 11-30-2001.

AMCAS

OWNER OF U.S. REG. NOS. 1,944,091 AND 2,065,946.
FOR DATA PROCESSING SERVICES FOR THE APPLICATION OF PROSPECTIVE MEDICAL STUDENTS FOR ADMISSION TO DESIGNATED MEDICAL SCHOOLS (U.S. CLS. 100, 101 AND 102).
FIRST USE 7-1-1970; IN COMMERCE 7-1-1970.

SN 76-345,242. DUCA, ROBERT J., ROCHESTER, NY. FILED 12-6-2001.

TTMX

FOR CONSULTING SERVICES THAT FOCUS ON THE MANAGEMENT OF THE OVERALL SUPPLY CHAIN FOR A PRODUCT FROM CONCEPT TO PRODUCTION (U.S. CLS. 100, 101 AND 102).

SN 76-346,498. JSJ FURNITURE CORPORATION, GRAND HAVEN, MI. FILED 12-10-2001.

IZZYSEATING

FOR WHOLESALE AND RETAIL STORE SERVICES FEATURING OFFICE FURNITURE (U.S. CLS. 100, 101 AND 102).

SN 76-346,537. PSISEARCH, LLC, DALLAS, TX. FILED 12-8-2001.

RESULTE UNIVERSAL

FOR EMPLOYEE STAFFING AND PERSONNEL RECRUITING SERVICES (U.S. CLS. 100, 101 AND 102).

SN 78-003,996. DEAK GROUP, THE, FORT LAUDERDALE, FL. FILED 4-13-2000.

MOVIE MOUNTAIN

NO CLAIM IS MADE TO THE EXCLUSIVE RIGHT TO USE "MOVIE", APART FROM THE MARK AS SHOWN.
FOR COMPUTERIZED ON-LINE RETAIL SERVICES IN THE FIELD OF PRE-RECORDED VIDEO TAPES AND DVDS FEATURING ADULT ENTERTAINMENT AND ADULT TOYS AND LUBRICANTS (U.S. CLS. 100, 101 AND 102).
FIRST USE 11-1-1998; IN COMMERCE 11-1-1998.

CLASS 35—(Continued).

SN 78-027,676. BUZZ-ABOUT BOUQUET COMPANY, YUMA, AZ. FILED 9-26-2000.

BUZZ-ABOUT BOUQUET COMPANY

NO CLAIM IS MADE TO THE EXCLUSIVE RIGHT TO USE "BOUQUET COMPANY", APART FROM THE MARK AS SHOWN.

FOR RETAIL SHOPS FEATURING FLOWER BOUQUETS; WHOLESALE DISTRIBUTORSHIPS FEATURING FLOWER BOUQUETS (U.S. CLS. 100, 101 AND 102).

SN 78-044,688. XEROX CORPORATION, STAMFORD, CT. FILED 1-24-2001.

ROR RETURN ON RESEARCH

NO CLAIM IS MADE TO THE EXCLUSIVE RIGHT TO USE "RETURN ON RESEARCH", APART FROM THE MARK AS SHOWN.

FOR MARKET RESEARCH SERVICES (U.S. CLS. 100, 101 AND 102).

SN 78-047,276. WEBMAGIC VENTURES, LLC, PASADENA, CA. FILED 2-8-2001.

TUSCANY

FOR PROVIDING INFORMATION ABOUT THE GOODS AND SERVICES OF OTHERS VIA GLOBAL COMPUTER NETWORK; PROVIDING ONLINE DIRECTORY INFORMATION SERVICES ALSO FEATURING HYPERLINKS TO THE WEBSITES OF OTHERS; AND DIRECT MARKETING ADVERTISING FOR THE SERVICES OF OTHERS (U.S. CLS. 100, 101 AND 102).

FIRST USE 8-13-1997; IN COMMERCE 8-13-1997.

SN 78-057,009. UNIVERSAL CHIROPRACTIC, L.L.C., CEDAR PARK, TX. FILED 4-5-2001.

UNIVERSAL CHIROPRACTIC

NO CLAIM IS MADE TO THE EXCLUSIVE RIGHT TO USE "CHIROPRACTIC", APART FROM THE MARK AS SHOWN.

FOR BUSINESS MANAGEMENT IN THE FIELD OF CHIROPRACTIC HEALTH CENTERS, NAMELY, POOLING AND MANAGEMENT OF ADVERTISING FUNDS FOR OTHERS IN THE FIELD OF CHIROPRACTIC HEALTH (U.S. CLS. 100, 101 AND 102).

CLASS 35—(Continued).

SN 78-058,320. PROJECT SOLVERS, INC., NEW YORK, NY. FILED 4-13-2001.

THE FREEDOM OF FREELANCE, THE SECURITY OF EMPLOYMENT

NO CLAIM IS MADE TO THE EXCLUSIVE RIGHT TO USE "EMPLOYMENT", APART FROM THE MARK AS SHOWN.

FOR HIRING AND STAFFING SERVICES (U.S. CLS. 100, 101 AND 102).

FIRST USE 2-14-2001; IN COMMERCE 2-14-2001.

SN 78-062,241. NORA MILL GRANARY, INC., HELEN, GA. FILED 5-6-2001.

NORA MILL GRANARY

NO CLAIM IS MADE TO THE EXCLUSIVE RIGHT TO USE "MILL GRANARY", APART FROM THE MARK AS SHOWN.

THE NAME "NORA MILL GRANARY" DOES NOT IDENTIFY A LIVING INDIVIDUAL.

FOR RETAIL AND MAIL ORDER STORES FEATURING FLOURS, GRAINS, BREAD MIXES, CANNED FOODS, AND COOKBOOKS (U.S. CLS. 100, 101 AND 102).

FIRST USE 6-1-1981; IN COMMERCE 6-1-1981.

SN 78-066,191. WCW, INC., STAMFORD, CT. FILED 5-29-2001.

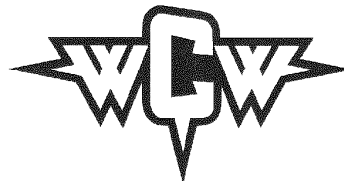

FOR RETAIL STORE SERVICES, ON-LINE RETAIL STORE SERVICES, AND MAIL-ORDER SERVICES FEATURING A WIDE VARIETY OF SPORTS ENTERTAINMENT MERCHANDISE ALL RELATED TO PROFESSIONAL WRESTLING (U.S. CLS. 100, 101 AND 102).

CLASS 35—(Continued).

SN 78-067,181. PRISTO, LARRY J., PHOENIX, AZ. FILED 6-4-2001.



THE MARK CONSISTS OF THE WORD "MARTELE" AND AN EAGLE SITTING ON TOP OF A SHIELD WITH AN ANCHOR ON IT, WITH A REPRESENTATION OF HERALDIC LION ON ONE SIDE OF THE SHIELD AND THE REPRESENTATION OF THE LETTER "G" ON THE OTHER SIDE.

THE ENGLISH TRANSLATION OF THE WORD "MARTELE" IN THE MARK IS "HAMMERED METAL".

FOR PROVIDING INFORMATION REGARDING BUYING AND SELLING OF ANTIQUE AND COLLECTIBLE SILVER AND BUYING AND SELLING ANTIQUE AND COLLECTIBLE SILVER (U.S. CLS. 100, 101 AND 102).

SN 78-068,007. MARKETING ADVANTAGE GROUP LLC, EVANSTON, IL. FILED 6-7-2001.

GOT CONSERVATION?

NO CLAIM IS MADE TO THE EXCLUSIVE RIGHT TO USE "CONSERVATION", APART FROM THE MARK AS SHOWN.

FOR ADVERTISING SERVICES, NAMELY, PROMOTING RESOURCE CONSERVATION ACTIVITIES (U.S. CLS. 100, 101 AND 102).

SN 78-068,025. MARTINEZ, CLAUDIA M., FT. LAUDERDALE, FL. FILED 6-7-2001.

PRIMURA

FOR IMPORT AND EXPORT AGENCY SERVICES (U.S. CLS. 100, 101 AND 102).

SN 78-068,374. ONLINE SOCIETY INC., ROCHESTER, MI. FILED 6-10-2001.

COPORTAL

FOR PROVIDING A GLOBAL COMPUTER INFORMATION NETWORK SITE FOR BUSINESSES TO PROMOTE, SELL, AND ADVERTISE THEIR BUSINESS, GOODS AND SERVICES (U.S. CLS. 100, 101 AND 102).

CLASS 35—(Continued).

SN 78-068,898. ERRAND CITY, INC., ROSWELL, GA. FILED 6-13-2001.

ERRAND CITY

FOR DRIVE-THROUGH AND WALK-IN RETAIL CONVENIENCE, DEPARTMENT, DRUG AND GROCERY STORES; DRIVE-THROUGH AND WALK-IN RETAIL PHARMACY SERVICES; DRIVE-THROUGH AND WALK-IN RETAIL STORE SERVICES FEATURING A WIDE VARIETY OF CONSUMER GOODS OF OTHERS (U.S. CLS. 100, 101 AND 102).

SN 78-068,959. 22ND CENTURY COMPUTERS, DANIA BEACH, FL. FILED 6-13-2001.

TOMMOROW'S SOLUTIONS TODAY

FOR RETAIL STORE SERVICES IN THE FIELD OF COMPUTERS AND COMPUTER SYSTEMS (U.S. CLS. 100, 101 AND 102).

SN 78-069,263. HEALTHY ACTIONS, L.L.C., OVERLAND PARK, KS. FILED 6-15-2001.

HEALTHY ACTIONS

FOR PRODUCTION AND DISTRIBUTION OF TELEVISION AND INTERNET COMMERCIALS IN THE FIELD OF HEALTH CARE (U.S. CLS. 100, 101 AND 102).

SN 78-072,921. NATIONS PAYROLL, INC., DALLAS, TX. FILED 7-9-2001.



NO CLAIM IS MADE TO THE EXCLUSIVE RIGHT TO USE "PAYROLL", APART FROM THE MARK AS SHOWN. FOR ADMINISTRATION OF BUSINESS PAYROLLS FOR OTHERS (U.S. CLS. 100, 101 AND 102).

CLASS 35—(Continued).

SN 78-074,019. MAIL CENTERS PLUS OFFICE SERVICES, INC., DECATUR, GA. FILED 7-16-2001.



NO CLAIM IS MADE TO THE EXCLUSIVE RIGHT TO USE "MAIL CENTERS", APART FROM THE MARK AS SHOWN.

FOR BUSINESS MANAGEMENT OF MAIL CENTER OPERATIONS FOR BUSINESSES AND INDUSTRIES (U.S. CLS. 100, 101 AND 102).

SN 78-074,375. WENDORF AND ASSOCIATES, INC., RICHFIELD, MN. FILED 7-18-2001.

EVALURATE

FOR MARKETING CONSULTING SERVICES FOR WEB-SITES (U.S. CLS. 100, 101 AND 102).

SN 78-088,257. KITCHEN KITCHEN INC., SAN DIEGO, CA. FILED 10-13-2001.

GUESS THE GADGET

FOR CONTESTS OFFERED VIA ONLINE WEBSITE TO PROMOTE THE SALE OF GOODS AND SERVICES OF OTHERS (U.S. CLS. 100, 101 AND 102).

SN 78-092,979. TARGET BRANDS, INC., MINNEAPOLIS, MN. FILED 11-13-2001.

PRICES SO LOW, YOU DON'T HAVE TO HOLD BACK

FOR RETAIL DEPARTMENT STORE SERVICES (U.S. CLS. 100, 101 AND 102).

CLASS 35—(Continued).

SN 78-094,136. INSIGHTS & SOLUTIONS, INC., TEMPE, AZ. FILED 11-19-2001.

TBDI

FOR BUSINESS MARKETING CONSULTING, NAMELY CONSULTING SERVICES RELATING TO BRAND MARKETING AND PROVIDING STATISTICAL ANALYSIS REGARDING BRAND MARKETING (U.S. CLS. 100, 101 AND 102).

SN 78-096,342. CUNNINGHAM FIELD & RESEARCH SERVICE, INC., ORMOND BEACH, FL. FILED 12-3-2001.

BIOTELLIGENCE

FOR MARKET RESEARCH SERVICE DEDICATED TO THE MEDICAL FIELD (U.S. CLS. 100, 101 AND 102).

CLASS 36—INSURANCE AND FINANCIAL

SN 75-402,460. ABN AMRO BANKING N.V., CHICAGO, IL. FILED 12-9-1997.

FACET

FOR GENERAL BANKING SERVICES, NAMELY, ON-LINE BANKING SERVICES (U.S. CLS. 100, 101 AND 102). FIRST USE 5-15-1997; IN COMMERCE 5-15-1997.

SN 75-546,337. GARRISON, MICHAEL B., WEST CHATHAM, MA. FILED 8-31-1998.



A Charitably Conscious Investment Advisory Firm

NO CLAIM IS MADE TO THE EXCLUSIVE RIGHT TO USE "A CHARITABLY CONSCIOUS INVESTMENT ADVISORY FIRM", APART FROM THE MARK AS SHOWN.

THE STIPPLING SHOWN ON THE DRAWING IS A FEATURE OF THE MARK AND IS NOT INTENDED TO INDICATE COLOR.

FOR FINANCIAL SERVICES, NAMELY, FINANCIAL MANAGEMENT, FINANCIAL PLANNING, FINANCIAL PORTFOLIO MANAGEMENT, AND INVESTMENT SERVICES, NAMELY INVESTMENT ADVICE, INVESTMENT BROKERAGE, INVESTMENT CONSULTATION AND INVESTMENT MANAGEMENT (U.S. CLS. 100, 101 AND 102).

CLASS 36—(Continued).

SN 75-598,206. D & E INC., CHESTER, VA. FILED 12-2-1998.

CASH CONCEPTS

NO CLAIM IS MADE TO THE EXCLUSIVE RIGHT TO USE "CASH", APART FROM THE MARK AS SHOWN.

FOR ADMINISTRATION OF ELECTRONIC DEBIT PROGRAM IN WHICH USERS PREPAY FOR LONG DISTANCE TELEPHONE SERVICES, LOCAL TELEPHONE SERVICES, MOBILE PHONE SERVICES, ELECTRONIC PAGER SERVICES, GLOBAL COMPUTER NETWORK ACCESS SERVICES AND FOOD STAMP REDEMPTION SERVICES (U.S. CLS. 100, 101 AND 102).

SN 75-670,055. LONG & FOSTER COMPANIES, INC., FAIRFAX, VA. FILED 3-29-1999.

EXTRAORDINARY PROPERTIES

OWNER OF U.S. REG. NOS. 1,456,462 AND 2,359,415.
NO CLAIM IS MADE TO THE EXCLUSIVE RIGHT TO USE "PROPERTIES", APART FROM THE MARK AS SHOWN.

SEC. 2(F) AS TO "EXTRAORDINARY".
FOR REAL ESTATE BROKERAGE SERVICES (U.S. CLS. 100, 101 AND 102).
FIRST USE 4-15-1986; IN COMMERCE 4-15-1986.

SN 75-696,964. IBSC SERVICES CORPORATION, IRMO, SC. FILED 5-3-1999.

**Personal ATM Location**

NO CLAIM IS MADE TO THE EXCLUSIVE RIGHT TO USE "ATM", APART FROM THE MARK AS SHOWN.
FOR AUTOMATED TELLER MACHINE SERVICES AND BANK SERVICES (U.S. CLS. 100, 101 AND 102).
FIRST USE 12-16-1998; IN COMMERCE 1-25-1999.

SN 75-752,859. FIRST CASH FINANCIAL SERVICES, INC., ARLINGTON, TX. FILED 7-16-1999.

CASH & GO

NO CLAIM IS MADE TO THE EXCLUSIVE RIGHT TO USE "CASH", APART FROM THE MARK AS SHOWN.
FOR CHECK CASHING SERVICES; CASH ADVANCES SERVICES, NAMELY PROVIDING TEMPORARY LOANS (U.S. CLS. 100, 101 AND 102).
FIRST USE 10-0-1996; IN COMMERCE 10-0-1996.

CLASS 36—(Continued).

SN 75-859,542. OSDE ORGANIZACION DE SERVICIOS DIRECTOS EMPRESARIOS, BUENOS AIRES, ARGENTINA, AND FUNDACION OSDE, BUENOS AIRES, ARGENTINA, FILED 11-29-1999.



PRIORITY CLAIMED UNDER SEC. 44(D) ON ARGENTINA APPLICATION NO. 2.237.279, FILED 8-27-1999, REG. NO. 1813573, DATED 12-19-2000, EXPIRES 12-19-2010.

THE ENGLISH TRANSLATION OF "BINARIA" IS "BINARY".
FOR INSURANCE ADMINISTRATION (U.S. CLS. 100, 101 AND 102).

SN 75-872,127. FORTIS (B), BRUSSELS, BELGIUM, AND FORTIS (NL) N.V., UTRECHT 3584 BA, NETHERLANDS, BY ASSIGNMENT FORTIS BENEFITS INSURANCE COMPANY, WOODBURY, MN. FILED 12-15-1999.

FORTIS BENEFITS PRO PLAN

NO CLAIM IS MADE TO THE EXCLUSIVE RIGHT TO USE "BENEFITS" AND "PLAN", APART FROM THE MARK AS SHOWN.

FOR NON-MEDICAL GROUP BENEFIT INSURANCE UNDERWRITING, NAMELY, UNDERWRITING SHORT-TERM DISABILITY INSURANCE, LONG-TERM DISABILITY INSURANCE, LIFE INSURANCE AND DENTAL INSURANCE (U.S. CLS. 100, 101 AND 102).
FIRST USE 4-1-2000; IN COMMERCE 4-1-2000.

SN 75-872,129. FORTIS, BRUSSELS, BELGIUM, AND FORTIS (NL) N.V., UTRECHT 3584 BA, NETHERLANDS, BY ASSIGNMENT FORTIS BENEFITS INSURANCE COMPANY, WOODBURY, MN. FILED 12-15-1999.

THE FORTIS BENEFITS ADVANTAGE

NO CLAIM IS MADE TO THE EXCLUSIVE RIGHT TO USE "BENEFITS", APART FROM THE MARK AS SHOWN.
FOR NON-MEDICAL GROUP BENEFIT INSURANCE UNDERWRITING, NAMELY, UNDERWRITING SHORT-TERM DISABILITY INSURANCE, LONG-TERM DISABILITY INSURANCE, LIFE INSURANCE AND DENTAL INSURANCE (U.S. CLS. 100, 101 AND 102).
FIRST USE 4-1-2000; IN COMMERCE 4-1-2000.

CLASS 36—(Continued).

SN 75-874,564. DR. BOB'S HOME, AKRON, OH. BY ASSIGNMENT FOUNDERS FOUNDATION, INC., AKRON, OH. FILED 12-18-1999.

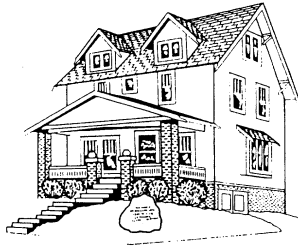

Dr. Bob's

FOR FINANCIAL SPONSORSHIP OF NOT FOR PROFIT FUNDRAISING SERVICES TO MAINTAIN A NATIONAL HISTORIC LANDMARK (U.S. CLS. 100, 101 AND 102).
FIRST USE 4-1-1992; IN COMMERCE 4-1-1992.

SN 75-887,057. TRADECARD, INC., NEW YORK, NY. FILED 1-4-2000.



OWNER OF U.S. REG. NOS. 2,214,998, 2,219,289 AND 2,240,975.
THE STIPPLING IS FOR SHADING PURPOSES ONLY AND DOES NOT INDICATE COLOR.
FOR FINANCING SERVICES, NAMELY, TRANSACTION RELATED FINANCING, PRE AND POST TRANSACTION FINANCING, WORKING CAPITAL FINANCING, AND DISCOUNTING OF RECEIVABLES FOR FINANCING PURPOSES; INSURANCE SERVICES, NAMELY, CARGO INSURANCE CONTRACTING AND ADMINISTRATION, AND PAYMENT GUARANTEE ASSURANCE UNDERWRITING (U.S. CLS. 100, 101 AND 102).
FIRST USE 4-30-1998; IN COMMERCE 4-30-1998.

CLASS 36—(Continued).

SN 75-889,381. UTICA MUTUAL INSURANCE COMPANY, DBA UTICA NATIONAL INSURANCE GROUP, NEW HARTFORD, NY. FILED 1-6-2000.



FOR PROVIDING ON-LINE CUSTOMER SERVICE FOR OTHERS IN THE INSURANCE INDUSTRY, NAMELY, PROVIDING INSURANCE ACCOUNT INFORMATION AND INSURANCE COVERAGE INFORMATION (U.S. CLS. 100, 101 AND 102).
FIRST USE 6-1-1999; IN COMMERCE 6-1-1999.

SN 75-908,882. MELLON BANK, N.A., PITTSBURGH, PA. FILED 2-2-2000.

MELLON MERCHANTLINKS

OWNER OF U.S. REG. NOS. 1,111,471, 2,238,353 AND OTHERS.
NO CLAIM IS MADE TO THE EXCLUSIVE RIGHT TO USE "MERCHANTLINKS", APART FROM THE MARK AS SHOWN.
FOR BANKING SERVICES (U.S. CLS. 100, 101 AND 102).

SN 75-909,644. AMERIQUEST MORTGAGE COMPANY, ORANGE, CA. FILED 2-4-2000.



OWNER OF U.S. REG. NO. 2,224,856.
NO CLAIM IS MADE TO THE EXCLUSIVE RIGHT TO USE "MORTGAGE COMPANY", APART FROM THE MARK AS SHOWN.
THE STIPPLING IN THE DRAWING APPEARS TO BE FOR SHADING PURPOSES ONLY.
FOR MORTGAGE LENDING AND FINANCIAL SERVICES; MORTGAGE BANKING; MORTGAGE BROKERAGE; AND WHOLESALE AND RETAIL MORTGAGE SERVICES, NAMELY PURCHASING MORTGAGE LOANS FROM REAL ESTATE BROKERS AND CORRESPONDENT LENDERS; AND MORTGAGE LENDING, BANKING, AND BROKERAGE SERVICES OVER THE GLOBAL COMPUTER NETWORK (U.S. CLS. 100, 101 AND 102).
FIRST USE 4-8-1997; IN COMMERCE 4-8-1997.

CLASS 36—(Continued).

SN 75-911,861. ME LICENSING CORPORATION, CLAYMONT, DE. FILED 2-7-2000.

NELSON'S INSTITUTIONAL MARKETPLACEWEB

NO CLAIM IS MADE TO THE EXCLUSIVE RIGHT TO USE "INSTITUTIONAL MARKETPLACEWEB", APART FROM THE MARK AS SHOWN.

FOR COMPUTER SERVICES, NAMELY, PROVIDING FINANCIAL AND INVESTMENT ANALYSIS AND CONSULTATION VIA A GLOBAL COMPUTER NETWORK (U.S. CLS. 100, 101 AND 102).

SN 75-912,729. MEADOWS CREDIT UNION, ARLINGTON HEIGHTS, IL. FILED 2-8-2000.

STARTPOINT

FOR CHECKING ACCOUNT SERVICES, INVESTMENT BANKING IN THE FIELD OF MONEY MARKETS, AND CREDIT CARD SERVICES (U.S. CLS. 100, 101 AND 102).

FIRST USE 1-11-2000; IN COMMERCE 1-11-2000.

SN 75-917,567. BRYN MAWR TRUST COMPANY, THE, BRYN MAWR, PA. FILED 2-14-2000.

A WORLD OF DIFFERENCE

FOR FINANCIAL, BANKING, TRUST, AND INVESTMENT SERVICES, NAMELY, MORTGAGE LENDING SERVICES, MORTGAGE BANKING SERVICES, PERSONAL, BUSINESS AND COMMERCIAL BANKING SERVICES, INDIVIDUAL RETIREMENT ACCOUNT SERVICES, CHECKING, SAVINGS, AND MONEY MARKET ACCOUNT SERVICES; CREDIT CARD AND LINE OF CREDIT SERVICES; FINANCIAL PLANNING SERVICES; ELECTRONIC TRANSFERS OF FUNDS; TRUST AND FIDUCIARY SERVICES, NAMELY, ACTING AS FIDUCIARY REPRESENTATIVES; INVESTMENT MANAGEMENT CONSULTING SERVICES; FINANCIAL AND INVESTMENT ADVISORY SERVICES; FINANCIAL CONSULTATION SERVICES IN THE FIELD OF CHARITABLE FOUNDATIONS; FAMILY BUSINESS OFFICE SERVICES, NAMELY, INVESTMENT ADVISORY SERVICES, BILL PAYMENT SERVICES, REAL ESTATE MANAGEMENT, AND CHARITABLE CONTRIBUTION MANAGEMENT; ESTATE PLANNING; INSURANCE BROKERAGE SERVICES FOR PROPERTY, CASUALTY, LIFE INSURANCE AND ANNUITIES; CONSULTING SERVICES IN THE FIELD OF FIDUCIARY REPRESENTATIVES; RETIREMENT PLANNING SERVICES; AND COMMERCIAL, CONSUMER, PERSONAL AND REAL ESTATE LENDING SERVICES (U.S. CLS. 100, 101 AND 102).

FIRST USE 4-0-1999; IN COMMERCE 4-0-1999.

CLASS 36—(Continued).

SN 75-927,550. ATJAPAN LLC, WILMINGTON, DE. FILED 2-25-2000.

ATJAPANMEDIA.COM

FOR FINANCIAL SERVICES, NAMELY, PROVIDING FINANCING AND INVESTING ADVICE (U.S. CLS. 100, 101 AND 102).

SN 75-927,558. ATJAPAN LLC, WILMINGTON, DE. FILED 2-25-2000.

ATJAPAN

FOR FINANCIAL SERVICES, NAMELY, PROVIDING FINANCING AND INVESTING ADVICE (U.S. CLS. 100, 101 AND 102).

SN 75-927,895. ATJAPAN LLC, WILMINGTON, DE. FILED 2-25-2000.

ATJAPANMEDIA

FOR FINANCIAL SERVICES, NAMELY, PROVIDING FINANCING AND INVESTING ADVICE (U.S. CLS. 100, 101 AND 102).

SN 75-935,733. GENERAL CASUALTY COMPANY OF WISCONSIN, SUN PRAIRIE, WI. FILED 3-3-2000.

CROWNE HOMEOWNERS

NO CLAIM IS MADE TO THE EXCLUSIVE RIGHT TO USE "HOMEOWNERS", APART FROM THE MARK AS SHOWN.

FOR INSURANCE SERVICES, NAMELY, INSURANCE UNDERWRITING, INSURANCE ADMINISTRATION AND INSURANCE CLAIMS ADMINISTRATION IN THE FIELD OF HOMEOWNERS INSURANCE (U.S. CLS. 100, 101 AND 102).

SN 76-050,633. SENTRE PARTNERS, INC., SAN DIEGO, CA. FILED 5-17-2000.

BANDWIDTH NOW

NO CLAIM IS MADE TO THE EXCLUSIVE RIGHT TO USE "BANDWIDTH", APART FROM THE MARK AS SHOWN.

FOR REAL ESTATE MANAGEMENT AND BROKERAGE SERVICES, NAMELY, BROKERING GOODS AND SERVICES OF OTHERS IN THE FIELDS OF COMPUTER NETWORKING, TELECOMMUNICATIONS AND HIGH SPEED TRANSMISSION OF INFORMATION, VIA A GLOBAL COMPUTER NETWORK (U.S. CLS. 100, 101 AND 102).

CLASS 36—(Continued).

SN 76-055,251. GOLDMAN, SACHS & CO., NEW YORK, NY. FILED 5-24-2000.

GSONLINE

FOR FINANCIAL SERVICES, NAMELY, SECURITIES BROKERAGE, FINANCIAL INVESTMENT, AND FINANCIAL PORTFOLIO MANAGEMENT SERVICES PROVIDED VIA AN ONLINE ELECTRONIC COMMUNICATIONS NETWORK; PROVIDING ONLINE DATABASES IN THE FIELDS OF FINANCE, INVESTMENT, ECONOMICS AND BUSINESS; AND PROVIDING ACCESS BY ELECTRONIC COMMUNICATION NETWORKS TO PORTFOLIO MANAGEMENT TOOLS AND/OR ACCOUNT INFORMATION; PROVIDING FINANCIAL SERVICES VIA THE INTERNET, NAMELY, STOCK, BOND, AND MUTUAL FUND INVESTING SERVICES (U.S. CLS. 100, 101 AND 102).

SN 76-064,996. AMERICAN FIDELITY ASSURANCE COMPANY, DBA AMERICAN FIDELITY EDIRECT, OKLAHOMA CITY, OK. FILED 6-7-2000.



NO CLAIM IS MADE TO THE EXCLUSIVE RIGHT TO USE "AMERICAN" AND "EDIRECT", APART FROM THE MARK AS SHOWN.

FOR INSURANCE AND FINANCIAL SERVICES, NAMELY, LIFE, ACCIDENT AND HEALTH COVERAGE THAT ARE ACCESSIBLE AT A SITE ON A GLOBAL COMPUTER NETWORK (U.S. CLS. 100, 101 AND 102).

SN 76-072,848. AMERIFLEX, LLC, CHERRY HILL, NJ. FILED 6-19-2000.

MONGOOSE

FOR ADMINISTRATION OF EMPLOYEE BENEFIT PLANS, NAMELY, COBRA/HIPAP COMPLIANCE MATTERS (U.S. CLS. 100, 101 AND 102).

FIRST USE 1-4-2000; IN COMMERCE 1-4-2000.

CLASS 36—(Continued).

SN 76-087,605. ASHTON TECHNOLOGY GROUP, INC., PHILADELPHIA, PA. FILED 7-12-2000.

iMATCH TRADING SYSTEM

NO CLAIM IS MADE TO THE EXCLUSIVE RIGHT TO USE "TRADING SYSTEM", APART FROM THE MARK AS SHOWN.

FOR FINANCIAL SERVICES, NAMELY PROVIDING ON-LINE COMPUTER SERVICES FOR STOCK AND SECURITY TRANSACTIONS (U.S. CLS. 100, 101 AND 102).

SN 76-091,661. FREEDOMPAY, INC., WILMINGTON, DE. FILED 7-17-2000.

YOUR GATEWAY TO CASHLESS

NO CLAIM IS MADE TO THE EXCLUSIVE RIGHT TO USE "CASHLESS", APART FROM THE MARK AS SHOWN.

FOR ELECTRONIC PAYMENT, NAMELY, ELECTRONIC PROCESSING AND TRANSMISSION OF PAYMENT DATA THAT PROVIDES THE ABILITY TO PURCHASE ITEMS AT VENDING MACHINES AND AT OTHER RETAIL POINTS-OF-SALE WITHOUT THE NEED FOR CASH OR CREDIT CARD ON HAND, THROUGH AN ACCOUNT SET UP ON A COMPUTER NETWORK (U.S. CLS. 100, 101 AND 102).

SN 76-098,304. BANK ONE CORPORATION, CHICAGO, IL. FILED 7-28-2000.

THE ONE SURVIVORSHIP VUL

OWNER OF U.S. REG. NOS. 1,120,175, 1,812,388 AND OTHERS.

NO CLAIM IS MADE TO THE EXCLUSIVE RIGHT TO USE "SURVIVORSHIP VUL", APART FROM THE MARK AS SHOWN.

FOR FINANCIAL SERVICES, NAMELY BROKERAGE OF INSURANCE AND CONSULTATION SERVICES RELATED THERETO (U.S. CLS. 100, 101 AND 102).

SN 76-102,009. CINCINNATI INSURANCE COMPANY, THE, CINCINNATI, OH. FILED 8-3-2000.

CFCNET

FOR COMPUTER SERVICES, NAMELY, PROVIDING AN ON-LINE NEWS AND INFORMATION DATABASE IN THE FIELD OF INSURANCE (U.S. CLS. 100, 101 AND 102).

FIRST USE 1-1-1998; IN COMMERCE 8-1-2000.

CLASS 36—(Continued).

SN 76-104,390. E*TRADE SECURITIES, INC., MENLO PARK, CA. FILED 8-7-2000.

E*TRADE FUNDINSIGHT

OWNER OF U.S. REG. NOS. 1,854,863, 2,220,629 AND OTHERS.

FOR FINANCIAL SERVICES, NAMELY INFORMATION ON MUTUAL FUNDS (U.S. CLS. 100, 101 AND 102).

FIRST USE 6-1-2000; IN COMMERCE 6-1-2000.

SN 76-104,682. STATE EMPLOYEES FEDERAL CREDIT UNION, ALBANY, NY. FILED 8-7-2000.

SEFCU eCheck

NO CLAIM IS MADE TO THE EXCLUSIVE RIGHT TO USE "ECHECK", APART FROM THE MARK AS SHOWN.

FOR PROVIDING ELECTRONIC BILL PAYMENT SERVICES FOR OTHERS VIA THE INTERNET (U.S. CLS. 100, 101 AND 102).

SN 76-104,684. STATE EMPLOYEES FEDERAL CREDIT UNION, ALBANY, NY. FILED 8-7-2000.

SEFCU iPay

NO CLAIM IS MADE TO THE EXCLUSIVE RIGHT TO USE "IPAY", APART FROM THE MARK AS SHOWN.

FOR PROVIDING ELECTRONIC BILL PAYMENT SERVICES FOR OTHERS VIA THE INTERNET (U.S. CLS. 100, 101 AND 102).

CLASS 36—(Continued).

SN 76-109,747. CENTEX CORPORATION, DALLAS, TX. FILED 8-14-2000.



OWNER OF U.S. REG. NOS. 1,872,817, 2,223,143 AND OTHERS.

NO CLAIM IS MADE TO THE EXCLUSIVE RIGHT TO USE "HOME OWNERSHIP CLUB", APART FROM THE MARK AS SHOWN.

FOR FINANCIAL CONSULTATION SERVICES IN CONNECTION WITH PROSPECTIVE HOME OWNERSHIP, NAMELY PROVIDING INFORMATION TO PROSPECTIVE HOME OWNERS CONCERNING HOME LOANS, HOME LOAN PROGRAMS AND THE HOME LOAN PROCESS, ANALYZING THE FINANCIAL SITUATION OF PROSPECTIVE HOME OWNERS, AND DEVELOPING AND ASSISTING WITH FINANCIAL SOLUTIONS FOR PROSPECTIVE HOME OWNERS WITH FINANCIAL DIFFICULTIES (U.S. CLS. 100, 101 AND 102).

FIRST USE 4-1-2000; IN COMMERCE 4-1-2000.

SN 76-112,468. PPA CAPITAL LIMITED, LONDON, UNITED KINGDOM, FILED 8-18-2000.

SECFINEX

FOR AUTOMATED SECURITIES BROKERAGE; PROVIDING FINANCIAL INFORMATION RELATING TO SECURITIES FINANCE TRANSACTIONS; PROVIDING FINANCIAL INFORMATION RELATING TO PROVIDERS OF SECURITIES FINANCE; PROVIDING AN ON-LINE COMPUTER DATABASE RELATING TO SECURITIES FINANCE TRANSACTIONS (U.S. CLS. 100, 101 AND 102).

SN 76-116,084. DOLLAR FINANCIAL GROUP, INC., BERYN, PA. FILED 8-25-2000.

CASH 'TIL PAYDAY

OWNER OF U.S. REG. NO. 1,987,764. SEC. 2(F).

FOR SHORT-TERM SMALL CONSUMER LOANS (U.S. CLS. 100, 101 AND 102).

FIRST USE 8-17-1995; IN COMMERCE 8-17-1995.

CLASS 36—(Continued).

SN 76-128,670. BELLEVUE HOLDING AG, 6301 ZUG, SWITZERLAND, FILED 9-15-2000.

BELLEVUE RESEARCH

NO CLAIM IS MADE TO THE EXCLUSIVE RIGHT TO USE "RESEARCH", APART FROM THE MARK AS SHOWN. THE ENGLISH TRANSLATION OF "BELLEVUE" IS "BEAUTIFUL VIEW".
FOR FINANCIAL RESEARCH (U.S. CLS. 100, 101 AND 102).



SN 76-128,673. BANK ASSET MANAGEMENT AG, 6301 ZUG, SWITZERLAND, FILED 9-15-2000.

BB BIOTECH

NO CLAIM IS MADE TO THE EXCLUSIVE RIGHT TO USE "BIOTECH", APART FROM THE MARK AS SHOWN. FOR INVESTMENT MANAGEMENT (U.S. CLS. 100, 101 AND 102).



SN 76-133,634. MINNESOTA DEPARTMENT OF HUMAN SERVICES, ST. PAUL, MN. FILED 9-18-2000.

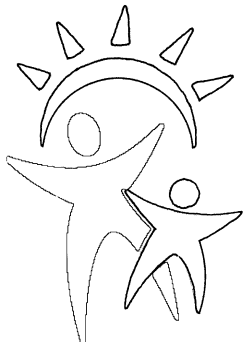

FOR UNDERWRITING STATE GOVERNMENT-PROVIDED INSURANCE FOR PRE-PAID HEALTH CARE (U.S. CLS. 100, 101 AND 102).
FIRST USE 9-1-1998; IN COMMERCE 9-1-1998.

CLASS 36—(Continued).

SN 76-136,765. CGB DIVERSIFIED SERVICES, INC., MT. VERNON, IN. FILED 9-25-2000.



NO CLAIM IS MADE TO THE EXCLUSIVE RIGHT TO USE "DIVERSIFIED SERVICES", APART FROM THE MARK AS SHOWN.
FOR FINANCIAL CONSULTATION SERVICES IN THE FIELD OF AGRICULTURE (U.S. CLS. 100, 101 AND 102).
FIRST USE 12-10-1997; IN COMMERCE 6-1-1998.



SN 76-136,994. KLUGA, DALE R., DOWNERS GROVE, IL. FILED 9-25-2000.

COBRA

FOR FINANCING SERVICES, NAMELY, BANKING AND LEASE-PURCHASE FINANCING (U.S. CLS. 100, 101 AND 102).
FIRST USE 9-1-2000; IN COMMERCE 9-1-2000.



SN 76-141,201. PROPEL PARTNERS LLC, PALO ALTO, CA. FILED 10-4-2000.

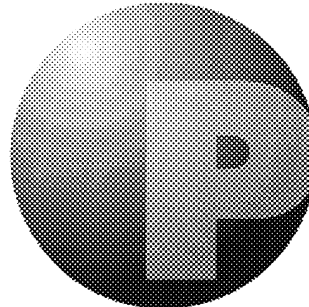

THE STIPLING IN THE DRAWING IS FOR SHADING PURPOSES ONLY.
FOR FINANCIAL SERVICES, NAMELY SECURITIES INVESTMENT INCLUDING ACQUISITION, MANAGEMENT AND SELLING OF INTERESTS IN COMPANIES, CAPITAL INVESTMENT CONSULTATION SERVICES AND REAL ESTATE INVESTMENT SERVICES (U.S. CLS. 100, 101 AND 102).

CLASS 36—(Continued).

SN 76-142,804. DEBMARK SOLUTIONS, INC., LANSDALE, PA. FILED 10-10-2000.

BREAKTIMECARD

FOR DEBIT CARD SERVICES AND ELECTRONIC CASH TRANSACTIONS (U.S. CLS. 100, 101 AND 102).

SN 76-149,769. PIONEER INVESTMENT MANAGEMENT USA INC., BOSTON, MA. BY CHANGE OF NAME PIONEER GROUP, INC., THE, BOSTON, MA. FILED 10-19-2000.



FOR MUTUAL FUND DISTRIBUTION; MUTUAL FUND BROKERAGE; INVESTMENT CONSULTATION; FUND INVESTMENT CONSULTATION; FINANCIAL INVESTMENT AND INVESTMENT ADVICE IN THE FIELDS OF MUTUAL FUNDS, ANNUITIES, RETIREMENT PLANS AND LIFE INSURANCE PRODUCTS (U.S. CLS. 100, 101 AND 102).

SN 76-151,813. PIONEER INVESTMENT MANAGEMENT, INC., BOSTON, MA. FILED 10-23-2000.

THE ONE YOU CAN LISTEN TO.

FOR MUTUAL FUND DISTRIBUTION, MUTUAL FUND BROKERAGE; INVESTMENT CONSULTATION; FUND INVESTMENT CONSULTATION; FINANCIAL INVESTMENT AND INVESTMENT ADVICE IN THE FIELDS OF MUTUAL FUNDS, ANNUITIES, RETIREMENT PLANS AND LIFE INSURANCE PRODUCTS (U.S. CLS. 100, 101 AND 102).
FIRST USE 9-25-2000; IN COMMERCE 9-25-2000.

CLASS 36—(Continued).

SN 76-152,965. KEYCORP, CLEVELAND, OH. FILED 10-24-2000.

ACHIEVE ANYTHING

OWNER OF U.S. REG. NOS. 1,915,415, 2,230,848 AND OTHERS.

FOR BANKING AND FINANCIAL SERVICES, NAMELY, CHECKING ACCOUNT SERVICES; CREDIT CARD SERVICES; EDUCATION FINANCING ADVISORY SERVICES; EDUCATIONAL LENDING SERVICES; ELECTRONIC AND ON-LINE BANKING SERVICES; ELECTRONIC INVESTMENT SERVICES, NAMELY, INVESTMENT CONSULTATION, BROKERAGE AND MANAGEMENT SERVICES; FINANCIAL MANAGEMENT, PLANNING AND PORTFOLIO MANAGEMENT SERVICES; INVESTMENT ADVISORY, CONSULTATION, BROKERAGE AND MANAGEMENT SERVICES; HOME EQUITY LENDING SERVICES; LEASE FINANCING SERVICES; LOAN FINANCING SERVICES; MORTGAGE BANKING AND MORTGAGE LENDING SERVICES; MUTUAL FUNDS INVESTMENT SERVICES; RETIREMENT FUND INVESTMENT SERVICES; SAVINGS ACCOUNT SERVICES; AND SMALL BUSINESS LENDING SERVICES (U.S. CLS. 100, 101 AND 102).

FIRST USE 12-13-2000; IN COMMERCE 12-13-2000.

SN 76-161,478. PECONIC PARTNERS LLC, NEW YORK, NY. FILED 11-7-2000.

PECONIC PARTNERS LLC

NO CLAIM IS MADE TO THE EXCLUSIVE RIGHT TO USE "PARTNERS LLC", APART FROM THE MARK AS SHOWN.

FOR INVESTMENT ADVISORY SERVICES (U.S. CLS. 100, 101 AND 102).

SN 76-170,762. CLEMENTS & COMPANY, WASHINGTON, DC. FILED 11-22-2000.



NO CLAIM IS MADE TO THE EXCLUSIVE RIGHT TO USE "INTERNATIONAL GLOBAL INSURANCE", APART FROM THE MARK AS SHOWN.

FOR INSURANCE BROKERAGE, AGENCY AND UNDERWRITING SERVICES IN THE FIELDS OF CASUALTY, PROPERTY, AUTOMOBILE, LIFE, HEALTH, AND DISABILITY INSURANCE (U.S. CLS. 100, 101 AND 102).

SN 76-182,287. ABACUS CAPITAL, LLC, MENDHAM, NJ. FILED 12-18-2000.

WHEN MONEY COUNTS

FOR FINANCIAL PLANNING SERVICES (U.S. CLS. 100, 101 AND 102).

CLASS 36—(Continued).

SN 76-185,954. ST. JOE COMPANY, THE, JACKSONVILLE, FL. FILED 12-22-2000.



NO CLAIM IS MADE TO THE EXCLUSIVE RIGHT TO USE "FLORIDA'S GREAT NORTHWEST", APART FROM THE MARK AS SHOWN.

FOR REAL ESTATE INVESTMENT AND MANAGEMENT (U.S. CLS. 100, 101 AND 102).

SN 76-187,701. LETERSKY, DARLENE, WESTPORT, CT. FILED 1-2-2001.

**FINE HOMES
CONNECTICUT**

NO CLAIM IS MADE TO THE EXCLUSIVE RIGHT TO USE "HOMES", APART FROM THE MARK AS SHOWN. SEC. 2(F).

FOR REAL ESTATE AGENCY SERVICES (U.S. CLS. 100, 101 AND 102).
FIRST USE 4-0-1995; IN COMMERCE 4-0-1995.

SN 76-189,617. FLATRATE-UTILITIES.COM, HOUSTON, TX. FILED 12-26-2000.

YULOC

FOR UTILITY BILL MANAGEMENT SERVICES, NAMELY, TRACKING, REPORTING, ANALYZING AND DELIVERING ENERGY INFORMATION IN THE FORM OF UTILITY BILLS AND UTILITY METER DATA RATE SCHEDULES FOR RESIDENTIAL AND SMALL BUSINESS (U.S. CLS. 100, 101 AND 102).

FIRST USE 5-10-2000; IN COMMERCE 5-10-2000.

SN 76-191,195. NOMURA HOLDING AMERICA, INC., NEW YORK, NY. FILED 1-9-2001.

NHA

FOR BROKERAGE SERVICES AND FINANCIAL INVESTMENT SERVICES IN THE FIELD OF SECURITIES AND DERIVATIVES (U.S. CLS. 100, 101 AND 102).

FIRST USE 4-5-1989; IN COMMERCE 4-5-1989.

CLASS 36—(Continued).

SN 76-194,669. CENTRAL DUPAGE HEALTH, WINFIELD, IL. FILED 1-16-2001.



OWNER OF U.S. REG. NOS. 1,930,588, 1,932,549 AND 1,946,241.

NO CLAIM IS MADE TO THE EXCLUSIVE RIGHT TO USE "CENTRAL DUPAGE HEALTH FOUNDATION", APART FROM THE MARK AS SHOWN.

FOR CHARITABLE FUNDRAISING AND CHARITABLE GRANT-MAKING FOR CENTRAL DUPAGE HEALTH (U.S. CLS. 100, 101 AND 102).

FIRST USE 12-1-2000; IN COMMERCE 12-1-2000.

SN 76-208,999. TRUSTEES OF THE PAYDEN & RYDEL INVESTMENT GROUP, THE TRUSTEES COMPRISING W.D. HILTON, JR., JAMES CLAYBURN LAFORCE, GERALD S. LEVEY, M.D., THOMAS V. MCKERNAN, JR., CHRISTOPHER N. ORNDORFF, JOAN A. PAYDEN, DENNIS C. POULSON, STENDER E. SWEENEY AND MARY BETH SYAL, ALL U.S. CITIZENS, THE, LOS ANGELES, CA. FILED 2-7-2001.

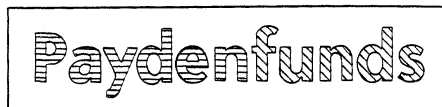

THE DRAWING IS LINED FOR THE COLORS GREEN AND BLUE.

THE MARK IDENTIFIES A PARTICULAR LIVING INDIVIDUAL WHOSE CONSENT IS OF RECORD.

FOR MUTUAL FUNDS MANAGEMENT AND INVESTMENT (U.S. CLS. 100, 101 AND 102).

FIRST USE 12-31-2000; IN COMMERCE 12-31-2000.

CLASS 36—(Continued).

SN 76-214,249. HIGHGROVE COMMUNITY FEDERAL CREDIT UNION, ST. PAUL, MN. FILED 2-22-2001.

YOUR NEIGHBORHOOD NON-BANK

FOR FINANCIAL SERVICES, NAMELY, DEBIT AND CREDIT CARD SERVICES; LOAN FINANCING, NAMELY PROVIDING CONSUMER LOANS, AUTOMOBILE LOANS, RECREATIONAL VEHICLE LOANS, PERSONAL LOANS, HOME EQUITY LOANS, HOME IMPROVEMENT LOANS, CREDIT RE-BUILDER LOANS; MORTGAGE LENDING; LINES OF CREDIT SERVICES; PROVIDING HOME BANKING SERVICES; SELF-BANKING SERVICES, AND COMPUTER BANKING SERVICES VIA TELEPHONE, GLOBAL TELECOMMUNICATIONS NETWORKS, DATA TRANSMISSION LINES, AND OTHER ELECTRONIC MEANS; BILL PAYMENT SERVICES VIA COMPUTER AND TELEPHONE, GLOBAL TELECOMMUNICATIONS NETWORK, DATA TRANSMISSION LINES, AND OTHER ELECTRONIC MEANS; INVESTMENT SERVICES, NAMELY, PROVIDING CERTIFICATES OF DEPOSIT, INDIVIDUAL RETIREMENT ACCOUNTS, AND MONEY MARKET ACCOUNTS; SAVINGS SERVICES, NAMELY PROVIDING SHARE SAVINGS ACCOUNTS AND CREDIT RE-BUILDER SAVINGS ACCOUNTS; AND CHECKING ACCOUNT SERVICES (U.S. CLS. 100, 101 AND 102).
FIRST USE 8-0-1999; IN COMMERCE 8-0-1999.

SN 76-215,198. THOMPSON STREET CAPITAL GP LLC, SANDS POINT, NY. FILED 2-22-2001.

THOMPSON STREET CAPITAL PARTNERS

NO CLAIM IS MADE TO THE EXCLUSIVE RIGHT TO USE "CAPITAL PARTNERS", APART FROM THE MARK AS SHOWN.

FOR FINANCIAL SERVICES IN THE NATURE OF PRIVATE EQUITY INVESTING FOR OTHERS (U.S. CLS. 100, 101 AND 102).
FIRST USE 9-25-2000; IN COMMERCE 9-25-2000.

SN 76-219,458. ALBIEZ INSURANCE AGENCY, WOODBRIDGE, NJ. FILED 3-1-2001.

GLASSPRO

FOR INSURANCE SERVICES, NAMELY, COMMERCIAL PROPERTY AND CASUALTY PROGRAM ADMINISTRATION AND AGENCY SERVICES, NAMELY POLICY ISSUANCE, CLAIMS ADMINISTRATION AND INSURANCE UNDERWRITING, FOR THE FLAT GLASS MANUFACTURING, RETAIL, AND WHOLESALE SALES INDUSTRIES (U.S. CLS. 100, 101 AND 102).
FIRST USE 8-1-2001; IN COMMERCE 8-1-2001.

CLASS 36—(Continued).

SN 76-220,841. MERCANTILE-SAFE DEPOSIT AND TRUST COMPANY, BALTIMORE, MD. FILED 3-7-2001.

UFACS

FOR PROVIDING A WEBSITE ON A GLOBAL COMPUTER NETWORK WHEREBY USERS ARE ABLE TO MONITOR INVESTMENTS AND TRUST ACCOUNTS (U.S. CLS. 100, 101 AND 102).
FIRST USE 3-7-2001; IN COMMERCE 3-7-2001.

SN 76-223,724. CNA FINANCIAL CORPORATION, CHICAGO, IL. FILED 3-13-2001.

CNA NATIONAL

NO CLAIM IS MADE TO THE EXCLUSIVE RIGHT TO USE "NATIONAL", APART FROM THE MARK AS SHOWN. FOR INSURANCE SERVICES, NAMELY, UNDERWRITING EXTENDED WARRANTY CONTRACTS IN THE FIELD OF AUTOMOBILES FOR FRANCHISE AUTO DEALERS (U.S. CLS. 100, 101 AND 102).
FIRST USE 1-1-2000; IN COMMERCE 1-1-2000.

SN 76-226,923. NORTH PEAK LLC, NEW YORK, NY. FILED 3-19-2001.

HILLEM PARTNERS

NO CLAIM IS MADE TO THE EXCLUSIVE RIGHT TO USE "PARTNERS", APART FROM THE MARK AS SHOWN. FOR FINANCIAL SERVICES, NAMELY, HEDGE FUND SERVICES (U.S. CLS. 100, 101 AND 102).
FIRST USE 1-1-1996; IN COMMERCE 1-1-1996.

SN 76-227,013. MT LAUREL MORTGAGE, LLC, BIRMINGHAM, AL. FILED 3-20-2001.

MT LAUREL MORTGAGE

NO CLAIM IS MADE TO THE EXCLUSIVE RIGHT TO USE "MORTGAGE", APART FROM THE MARK AS SHOWN. FOR MORTGAGE BANKING AND LENDING (U.S. CLS. 100, 101 AND 102).

CLASS 36—(Continued).

SN 76-234,647. HANDS OF HOPE, CHICAGO, IL. FILED 4-3-2001.

HANDS OF HOPE

FOR ELEEMOSYNARY SERVICES IN THE FIELD OF MONETARY DONATIONS FOR VOCATIONAL TRAINING, EDUCATIONAL SERVICES, SOCIAL REHABILITATION, FOOD, CLOTHING, SHELTER, MEDICINE AND MEDICAL SERVICES FOR WOMEN AND CHILDREN AS A CONSEQUENCE OF FEMALE MUTILATION, NATURAL DISASTERS, PHYSICAL AND MENTAL ABUSE, DISEASE AND SIMILAR MALADIES (U.S. CLS. 100, 101 AND 102).

FIRST USE 3-27-2000; IN COMMERCE 3-27-2000.

SN 76-236,225. BUILDINGLINK.COM, LLC, LONG ISLAND CITY, NY. FILED 4-5-2001.



OWNER OF U.S. REG. NO. 1,744,762.
FOR PROVIDING A WEB SITE ON THE GLOBAL COMPUTER INFORMATION NETWORK FEATURING INFORMATION FOR TENANTS AND MANAGEMENT OF, AND PROVIDERS OF MAINTENANCE AND OTHER SERVICES TO, COMMERCIAL AND RESIDENTIAL BUILDINGS AND ALLOWING USERS TO COMMUNICATE WITH EACH OTHER REGARDING SUCH BUILDINGS OR SERVICES (U.S. CLS. 100, 101 AND 102).

FIRST USE 5-15-2000; IN COMMERCE 5-15-2000.

SN 76-236,229. BUILDINGLINK.COM, LLC, LONG ISLAND CITY, NY. FILED 4-5-2001.

BuildingLink.com

OWNER OF U.S. REG. NO. 1,744,762.
FOR PROVIDING A WEB SITE ON THE GLOBAL COMPUTER INFORMATION NETWORK FEATURING INFORMATION FOR TENANTS AND MANAGEMENT OF, AND PROVIDERS OF MAINTENANCE AND OTHER SERVICES TO, COMMERCIAL AND RESIDENTIAL BUILDINGS AND ALLOWING USERS TO COMMUNICATE WITH EACH OTHER REGARDING SUCH BUILDINGS OR SERVICES (U.S. CLS. 100, 101 AND 102).

FIRST USE 5-15-2000; IN COMMERCE 5-15-2000.

CLASS 36—(Continued).

SN 76-243,722. MEREDITH, KATHRYN J., PITTSFORD, NY. FILED 4-20-2001.

THE PROSPERITY PROCESS

FOR FINANCIAL PLANNING SERVICES (U.S. CLS. 100, 101 AND 102).
FIRST USE 1-0-1999; IN COMMERCE 3-0-1999.

SN 76-245,149. MURIEL SIEBERT & CO., INC., NEW YORK, NY. FILED 4-23-2001.

WOMEN'S FINANCIAL NETWORK AT SIEBERT

NO CLAIM IS MADE TO THE EXCLUSIVE RIGHT TO USE "WOMEN'S FINANCIAL NETWORK", APART FROM THE MARK AS SHOWN.

FOR FINANCIAL CONSULTING SERVICES (U.S. CLS. 100, 101 AND 102).

FIRST USE 1-15-2001; IN COMMERCE 1-15-2001.

SN 76-247,557. WESTERN MUTUAL INSURANCE COMPANY, TAYLORSVILLE, UT. FILED 4-27-2001.

WMI

FOR INSURANCE SERVICES, NAMELY, ISSUING INSURANCE POLICIES AND UNDERWRITING INSURANCE IN THE AREAS OF HEALTH, DENTAL, LIFE, VISION AND DISABILITY; AND INSURANCE ADMINISTRATION SERVICES (U.S. CLS. 100, 101 AND 102).

FIRST USE 1-1-1995; IN COMMERCE 1-1-1995.

SN 76-254,208. G&P FOUNDATION FOR CANCER RESEARCH, INC., NEW YORK, NY. FILED 5-7-2001.

ANGEL WALL

FOR PROVIDING INFORMATION ON A WEBSITE FOR THE PURPOSE OF ACKNOWLEDGING CONTRIBUTIONS DUE TO FUND RAISING SERVICES (U.S. CLS. 100, 101 AND 102).

CLASS 36—(Continued).

SN 76-260,673. CIT GROUP, THE, LIVINGSTON, NJ. FILED 5-21-2001.

CITDIGITALEEDGE

OWNER OF U.S. REG. NOS. 1,000,360, 1,452,503 AND OTHERS.

FOR PROVIDING AN ON-LINE COMPUTER DATABASE FEATURING INFORMATION SERVICES WHICH ENABLE ACCOUNT HOLDERS TO ACQUIRE INFORMATION REGARDING THEIR INDIVIDUAL LOAN ACCOUNTS AND PERMIT ACCOUNT HOLDERS TO MAKE ELECTRONIC TRANSACTIONS (U.S. CLS. 100, 101 AND 102).

SN 76-265,043. EKKO EIENDOM AS, 7434 TRONDHEIM, NORWAY, FILED 5-31-2001.

NOTAR

OWNER OF NORWAY REG. NO. 208231, DATED 4-26-2001, EXPIRES 4-26-2011.

FOR REAL ESTATE BROKERAGE; REAL ESTATE APPRAISAL; REAL ESTATE MANAGEMENT (U.S. CLS. 100, 101 AND 102).

SN 76-265,624. TRUELINK, INC., SAN LUIS OBISPO, CA. FILED 5-30-2001.

 SuInformeDeCredito

NO CLAIM IS MADE TO THE EXCLUSIVE RIGHT TO USE "SUINFORMEDECREBITO", APART FROM THE MARK AS SHOWN.

THE ENGLISH TRANSLATION OF THE WORD "SUINFORMEDECREBITO" IN THE MARK IS "YOUR CREDIT INFORMATION".

FOR PROVIDING FINANCIAL INFORMATION, DATA AND REPORTS BY MEANS OF THE INTERNET; PROVIDING INFORMATION, DATA AND REPORTS IN THE FIELD OF MORTGAGE AND LOAN UNDERWRITING BY MEANS OF THE INTERNET; PROVIDING ONLINE CREDIT SCORING AND EVALUATION SERVICES; PROVIDING CONSUMER LOAN AND CREDIT APPLICATION SERVICES VIA A GLOBAL COMPUTER NETWORK; PROVIDING MORTGAGE UNDERWRITING SERVICES VIA A GLOBAL COMPUTER NETWORK; CONSULTING SERVICES IN THE FIELD OF CONSUMER LOANS, CREDIT AND DEBT CONSOLIDATION; PROVIDING LOANS PREQUALIFYING ANALYSIS AND LOAN DOCUMENT PREPARATION SERVICES; PROVIDING INFORMATION IN THE FIELD OF CREDIT REPORTING VIA AN ONLINE COMPUTER NETWORK; PROVIDING ONLINE CREDIT REPORTING FOR THE WEBSITES OF OTHERS (U.S. CLS. 100, 101 AND 102).

FIRST USE 6-26-2000; IN COMMERCE 6-26-2000.

CLASS 36—(Continued).

SN 76-265,726. AMERICAN HUMANE ASSOCIATION, ENGLEWOOD, CO. FILED 6-1-2001.

SECOND CHANCE

FOR FUNDRAISING SERVICES; CHARITABLE SERVICES, NAMELY, PROVIDING FINANCIAL ASSISTANCE AND FINANCIAL CONSULTATION IN THE FIELD OF THE CARE, PROTECTION AND REHABILITATION OF ANIMALS (U.S. CLS. 100, 101 AND 102).

FIRST USE 0-0-1994; IN COMMERCE 0-0-1994.

SN 76-268,171. AVIATION SHOPPING NETWORK, INC., THE, HOOD RIVER, OR. FILED 6-8-2001.

SKYMACHINES, THE AIRPLANE STORE

NO CLAIM IS MADE TO THE EXCLUSIVE RIGHT TO USE "THE AIRPLANE STORE", APART FROM THE MARK AS SHOWN.

FOR BROKERAGE SERVICES IN THE FIELD OF AIRCRAFT AND RELATED AVIATION EQUIPMENT AND APPRAISAL SERVICES IN THE FIELD OF AIRCRAFT AND RELATED AVIATION EQUIPMENT (U.S. CLS. 100, 101 AND 102).

FIRST USE 6-15-2000; IN COMMERCE 4-1-2001.

SN 76-269,362. WHY NOT SHARE? LLC, LAYTON, UT. FILED 6-11-2001.

SMARTSHARE

FOR FORMATION, BROKERAGE AND MANAGEMENT OF TIME-SHARE INTERESTS IN RECREATIONAL VEHICLES (U.S. CLS. 100, 101 AND 102).

FIRST USE 4-0-2001; IN COMMERCE 4-0-2001.

SN 76-270,880. THIRD FEDERAL SAVINGS AND LOAN ASSOCIATION OF CLEVELAND, DBA THIRD FEDERAL SAVINGS, CLEVELAND, OH. FILED 6-13-2001.

THIRD FEDERAL INVESTMENTS

OWNER OF U.S. REG. NOS. 1,869,923, 2,484,609 AND OTHERS.

NO CLAIM IS MADE TO THE EXCLUSIVE RIGHT TO USE "FEDERAL INVESTMENTS", APART FROM THE MARK AS SHOWN.

FOR FINANCIAL SERVICES IN THE NATURE OF INVESTMENT SECURITIES (U.S. CLS. 100, 101 AND 102).

FIRST USE 7-0-2000; IN COMMERCE 7-0-2000.

CLASS 36—(Continued).

SN 76-272,493. ALIC INVESTMENT ADVISORS, INC., ATLANTA, GA. FILED 6-15-2001.

ALIC INVESTMENT ADVISORS, INC.

NO CLAIM IS MADE TO THE EXCLUSIVE RIGHT TO USE "INVESTMENT ADVISORS, INC.", APART FROM THE MARK AS SHOWN.

FOR INVESTMENT CONSULTATION AND ADVISORY SERVICES (U.S. CLS. 100, 101 AND 102).

SN 76-278,564. PISANO, GARY, STUART, FL. FILED 6-25-2001.



NO CLAIM IS MADE TO THE EXCLUSIVE RIGHT TO USE "MARINE", APART FROM THE MARK AS SHOWN.

FOR BROKERAGE IN THE FIELD OF BOATS AND INSURANCE UNDERWRITING IN THE FIELD OF MARINE INSURANCE (U.S. CLS. 100, 101 AND 102).
FIRST USE 5-8-2001; IN COMMERCE 5-8-2001.

SN 76-281,002. UNITED GUARANTY CORPORATION, GREENSBORO, NC. FILED 7-6-2001.

UNITED GUARANTY'S PERSONAL PLEDGE

OWNER OF U.S. REG. NO. 1,287,252.
FOR MORTGAGE GUARANTY UNDERWRITING INSURANCE SERVICES (U.S. CLS. 100, 101 AND 102).
FIRST USE 2-0-2000; IN COMMERCE 2-0-2000.

SN 76-281,721. UNITED GUARANTY CORPORATION, GREENSBORO, NC. FILED 7-5-2001.

ACTIVE COMMITMENTS

FOR PROVIDING MORTGAGE GUARANTY UNDERWRITING INSURANCE SERVICES (U.S. CLS. 100, 101 AND 102).

CLASS 36—(Continued).

SN 76-291,205. GRIZZARD COMMUNICATIONS GROUP, INC., ATLANTA, GA. FILED 7-26-2001.

THE GRIZZARD AGENCY- FIRST IN FUNDRAISING

NO CLAIM IS MADE TO THE EXCLUSIVE RIGHT TO USE "AGENCY" AND "FUNDRAISING", APART FROM THE MARK AS SHOWN.

FOR CHARITABLE FUND RAISING SERVICES FOR NON-PROFIT ORGANIZATIONS (U.S. CLS. 100, 101 AND 102).

SN 76-294,040. BUCKINGHAM MANAGEMENT, LLC, INDIANAPOLIS, IN. FILED 8-2-2001.

RENTNUDE.COM

FOR COMPUTER SERVICES, NAMELY, PROVIDING ONLINE INFORMATION IN THE FIELD OF RESIDENTIAL LEASING (U.S. CLS. 100, 101 AND 102).

SN 76-294,042. BUCKINGHAM MANAGEMENT, LLC, INDIANAPOLIS, IN. FILED 8-2-2001.

RENTNAKED.COM

FOR COMPUTER SERVICES, NAMELY, PROVIDING ONLINE INFORMATION IN THE FIELD OF RESIDENTIAL LEASING (U.S. CLS. 100, 101 AND 102).

SN 76-295,226. TRICAST, INC., MILWAUKEE, WI. FILED 8-7-2001.



THE MARK CONSISTS, IN PART, OF A STYLIZED DEPICTION OF MEDICATION TABLETS AND CAPSULE.
FOR UNDERWRITING AND ADMINISTRATION OF PRESCRIPTION DRUG INSURANCE PLANS (U.S. CLS. 100, 101 AND 102).

FIRST USE 5-1-1999; IN COMMERCE 5-1-1999.

CLASS 36—(Continued).

SN 76-298,430. BANK ONE CORPORATION, CHICAGO, IL. FILED 8-13-2001.

BANK ONE DIRECT INCENTIVE CARD

OWNER OF U.S. REG. NOS. 1,120,175, 2,282,111 AND OTHERS.

NO CLAIM IS MADE TO THE EXCLUSIVE RIGHT TO USE "BANK" AND "INCENTIVE CARD", APART FROM THE MARK AS SHOWN.

FOR BANKING SERVICES (U.S. CLS. 100, 101 AND 102).

FIRST USE 7-16-2001; IN COMMERCE 7-16-2001.

SN 76-298,704. FLYING J INC., OGDEN, UT. FILED 8-14-2001.

TRANSPORTATION ALLIANCE BANK

NO CLAIM IS MADE TO THE EXCLUSIVE RIGHT TO USE "BANK", APART FROM THE MARK AS SHOWN.

FOR BANKING SERVICES, CREDIT CARD SERVICES AND DEBIT CARD SERVICES (U.S. CLS. 100, 101 AND 102).

FIRST USE 7-1-1997; IN COMMERCE 7-1-1997.

SN 76-300,406. NATIONAL BUSINESS CREDIT EXCHANGE, INC., CHARLOTTE, NC. FILED 8-14-2001.



NO CLAIM IS MADE TO THE EXCLUSIVE RIGHT TO USE "NATIONAL BUSINESS CREDIT EXCHANGE", APART FROM THE MARK AS SHOWN.

FOR CREDIT MANAGEMENT SERVICES (U.S. CLS. 100, 101 AND 102).

FIRST USE 10-4-2000; IN COMMERCE 10-4-2000.

SN 76-301,763. E-SPAN, INC., RICHARDSON, TX. FILED 8-20-2001.

E-SPAN SOLUTIONS

FOR FINANCIAL PLANNING, ANALYSIS AND CONSULTATION SERVICES (U.S. CLS. 100, 101 AND 102).

CLASS 36—(Continued).

SN 76-307,773. AMERICAN FAMILY LIFE ASSURANCE COMPANY OF COLUMBUS, COLUMBUS, GA. FILED 8-30-2001.

NO DRAWING-SENSORY MARK

OWNER OF U.S. REG. NOS. 1,570,222, 1,679,644 AND 1,747,403.

THE MARK CONSISTS OF THE SOUND OF A DUCK QUACKING THE WORD "AFLAC".

FOR INSURANCE UNDERWRITING SERVICES IN THE FIELDS OF DENTAL, HEALTH, LIFE, CANCER, HOSPITAL INTENSIVE CARE, ACCIDENT AND DISABILITY, HOSPITAL INDEMNITY, HOSPITAL CONFINEMENT INDEMNITY, MEDICARE SUPPLEMENT, SICKNESS, HOME HEALTHCARE, LONG-TERM HEALTHCARE, AND CONVALESCENT HEALTH CARE (U.S. CLS. 100, 101 AND 102).

FIRST USE 12-31-1999; IN COMMERCE 12-31-1999.

SN 76-313,007. PROJECT MANAGEMENT INSTITUTE EDUCATIONAL FOUNDATION, NEWTOWN SQUARE, PA. FILED 9-13-2001.

EMPOWERING THE FUTURE OF PROJECT MANAGEMENT

FOR PROVIDING GRANTS AND SCHOLARSHIPS TO INDIVIDUALS AND ORGANIZATIONS IN THE FIELD OF PROJECT MANAGEMENT (U.S. CLS. 100, 101 AND 102).

FIRST USE 3-22-2001; IN COMMERCE 3-22-2001.

SN 76-314,188. QUANTUM FINANCIAL ADVISORS, INC., WASHINGTON, DC. FILED 9-19-2001.

QFA

FOR RISK MANAGEMENT SERVICES, FINANCIAL PORTFOLIO MANAGEMENT SERVICES, FINANCIAL MANAGEMENT SERVICES, FINANCIAL ANALYSIS SERVICES, FINANCIAL ADVISORY SERVICES, AND FINANCIAL ADVICE IN THE FIELD OF PENSION AND RETIREMENT PLANNING (U.S. CLS. 100, 101 AND 102).

FIRST USE 3-27-1996; IN COMMERCE 3-27-1996.

SN 76-315,900. FORTIS, INC., NEW YORK, NY. FILED 9-24-2001.

MAXGREEN

FOR INSURANCE SERVICES, NAMELY, UNDERWRITING EXTENDED SERVICE CONTRACTS IN THE FIELD OF RESIDENTIAL LAWN AND GARDEN EQUIPMENT (U.S. CLS. 100, 101 AND 102).

CLASS 36—(Continued).

SN 76-317,793. WELLS FARGO & COMPANY, MINNEAPOLIS, MN. FILED 9-27-2001.

NORWEST VENTURE PARTNERS

OWNER OF U.S. REG. NOS. 1,323,659 AND 1,362,379.
NO CLAIM IS MADE TO THE EXCLUSIVE RIGHT TO USE "VENTURE PARTNERS", APART FROM THE MARK AS SHOWN.
FOR VENTURE CAPITAL INVESTMENT SERVICES (U.S. CLS. 100, 101 AND 102).

SN 76-319,080. KLUGA, DALE R., DOWNERS GROVE, IL. FILED 10-1-2001.



NO CLAIM IS MADE TO THE EXCLUSIVE RIGHT TO USE "CAPITAL LLC", APART FROM THE MARK AS SHOWN.
FOR FINANCING SERVICES, NAMELY, BANKING AND LEASE-PURCHASE FINANCING (U.S. CLS. 100, 101 AND 102).
FIRST USE 2-5-2001, THE MARK WAS USED ANYWHERE IN A DIFFERENT FORM OTHER THAN THAT SOUGHT TO BE REGISTERED ON 09/01/2000, AND AND IN COMMERCE ON 09/01/2000; IN COMMERCE 2-5-2001, THE MARK WAS USED ANYWHERE IN A DIFFERENT FORM OTHER THAN THAT SOUGHT TO BE REGISTERED ON 09/01/2000, AND AND IN COMMERCE ON 09/01/2000..

SN 76-321,259. PULSE EFT ASSOCIATION, HOUSTON, TX. FILED 10-4-2001.

ANOMALY WIZARD

FOR FRAUD DETECTION SERVICES IN THE FIELD OF ONLINE, POINT OF SALE, WHOLESALE, AND RETAIL PURCHASING AND PAYMENT SYSTEMS (U.S. CLS. 100, 101 AND 102).

SN 76-322,066. HIDROCK REALTY INC., NEW YORK, NY. FILED 10-9-2001.

HIDROCK REALTY

NO CLAIM IS MADE TO THE EXCLUSIVE RIGHT TO USE "REALTY", APART FROM THE MARK AS SHOWN.
FOR REAL ESTATE INVESTMENT AND MANAGEMENT SERVICES (U.S. CLS. 100, 101 AND 102).

CLASS 36—(Continued).

SN 76-322,142. NATIONAL WESTERN LIFE INSURANCE COMPANY, AUSTIN, TX. FILED 10-5-2001.

NWL LIFE 100

NO CLAIM IS MADE TO THE EXCLUSIVE RIGHT TO USE "LIFE", APART FROM THE MARK AS SHOWN.
FOR LIFE INSURANCE UNDERWRITING SERVICES (U.S. CLS. 100, 101 AND 102).

SN 76-325,648. HEMISPHERE NATIONAL BANK, THE, MIAMI, FL. FILED 10-16-2001.

IMPORTCARD FINANCIAL

NO CLAIM IS MADE TO THE EXCLUSIVE RIGHT TO USE "FINANCIAL", APART FROM THE MARK AS SHOWN.
FOR INTERNATIONAL TRADE FINANCIAL SERVICES, NAMELY, BANKING (U.S. CLS. 100, 101 AND 102).
FIRST USE 7-0-2000; IN COMMERCE 7-0-2000.

SN 76-326,019. NORTH CASCADES NATIONAL BANK, CHELAN, WA. FILED 10-15-2001.



NO CLAIM IS MADE TO THE EXCLUSIVE RIGHT TO USE "TECHNOLOGY, INC.", APART FROM THE MARK AS SHOWN.
FOR BANKING FINANCIAL SERVICES: FINANCIAL ANALYSIS AND CONSULTATION IN THE FIELD OF BANKING SERVICES; FINANCIAL INFORMATION PROVIDED BY ELECTRONIC MEANS IN THE FIELD OF BANKING SERVICES; FINANCIAL INFORMATION PROCESSING FOR OTHERS IN THE FIELD OF BANKING SERVICES; FINANCIAL SERVICES, NAMELY PROVIDING ON-LINE STORED VALUE ACCOUNTS IN AN ELECTRONIC ENVIRONMENT (U.S. CLS. 100, 101 AND 102).

SN 76-327,579. J. & W. SELIGMAN & CO. INCORPORATED, NEW YORK, NY. FILED 10-19-2001.

COLLEGEHORIZON ILLUSTRATOR

FOR MUTUAL FUND INVESTMENT SERVICES, NAMELY PROVIDING HISTORICAL ANALYSIS OF MARKET RETURNS (U.S. CLS. 100, 101 AND 102).

CLASS 36—(Continued).

SN 76-327,654. DREAMS TO REALTY, LLC, LEANDER, TX. FILED 10-19-2001.



NO CLAIM IS MADE TO THE EXCLUSIVE RIGHT TO USE "REALTY", APART FROM THE MARK AS SHOWN. THE MARK CONSISTS OF THE WORDS "DREAMS TO REALTY" AND A DESIGN DEPICTING A HOUSE AND AN OUTLINE OF A HOUSE AMIDST CLOUDS.

FOR REAL ESTATE AGENCY SERVICES (U.S. CLS. 100, 101 AND 102).
FIRST USE 7-31-2001; IN COMMERCE 7-31-2001.

SN 76-329,632. WABASH CAPITAL, INC., TERRE HAUTE, IN. FILED 10-25-2001.



NO CLAIM IS MADE TO THE EXCLUSIVE RIGHT TO USE "INVESTMENT MANAGEMENT SERVICES", APART FROM THE MARK AS SHOWN.

FOR INVESTMENT ADVICE (U.S. CLS. 100, 101 AND 102).
FIRST USE 9-0-2001; IN COMMERCE 9-0-2001.

SN 76-329,980. COVEST BANCSHARES, INC., DES PLAINES, IL. FILED 10-23-2001.



OWNER OF U.S. REG. NOS. 2,228,080, 2,230,467 AND OTHERS.

THE MARK CONSISTS OF THE TERM "COVESTBANC" WITH THE LETTER "V" BEING THE DESIGN OF A DOVE. FOR BANKING, CONSUMER LENDING AND FINANCIAL MANAGEMENT SERVICES (U.S. CLS. 100, 101 AND 102).

CLASS 36—(Continued).

SN 76-330,431. MANATRON, INC., PORTAGE, MI. FILED 10-26-2001.

MANATRON

FOR SERVICES TO GOVERNMENTAL UNITS, NAMELY REAL ESTATE PROPERTY APPRAISAL (U.S. CLS. 100, 101 AND 102).
FIRST USE 11-14-1994; IN COMMERCE 11-14-1994.

SN 76-336,454. NASDAQ LIFFE LLC, NEW YORK, NY. FILED 11-9-2001.

NQLX

FOR FUTURES EXCHANGE SERVICES (U.S. CLS. 100, 101 AND 102).

SN 76-336,612. AMERICAN AGRISURANCE, INC., COUNCIL BLUFFS, IA. FILED 11-13-2001.

LEADING THE WAY IN CROP INSURANCE

NO CLAIM IS MADE TO THE EXCLUSIVE RIGHT TO USE "CROP INSURANCE", APART FROM THE MARK AS SHOWN.

FOR INSURANCE UNDERWRITING IN THE FIELD OF AGRICULTURE; INSURANCE AGENCIES IN THE FIELD OF AGRICULTURE (U.S. CLS. 100, 101 AND 102).

SN 76-338,258. WELLS FARGO & COMPANY, MINNEAPOLIS, MN. FILED 11-15-2001.

FASTER, SAFER, SMARTER

FOR BANKING SERVICES, NAMELY CREDIT CARD AND DEBIT CARD SERVICES (U.S. CLS. 100, 101 AND 102).

FIRST USE 12-1-1997; IN COMMERCE 12-1-1997.

SN 76-342,194. VAN KAMPEN FUNDS INC., OAKBROOK TERRACE, IL. FILED 11-27-2001.

ONE CLICK ONE COMPANY

FOR FINANCIAL SERVICES, NAMELY, INVESTMENT MANAGEMENT, UNIT INVESTMENT TRUST AND OPEN- AND CLOSED-END INVESTMENT COMPANY SERVICES, INVESTMENT TRANSFER AGENCY SERVICES, AND RETIREMENT TRUST MANAGEMENT SERVICES, VIA PRIVATE AND GLOBAL COMPUTER NETWORKS (U.S. CLS. 100, 101 AND 102).

CLASS 36—(Continued).

SN 76-342,561. AMERICAN ACADEMY OF OPHTHALMOLOGY, INC., SAN FRANCISCO, CA. FILED 11-28-2001.

DON'T LET YOUR EYESIGHT BE AN OVERSIGHT

FOR CHARITABLE FUND-RAISING IN THE FIELDS OF EYE CARE AND OPHTHALMOLOGY (U.S. CLS. 100, 101 AND 102).

SN 76-342,696. WELLS FARGO & COMPANY, MINNEAPOLIS, MN. FILED 11-28-2001.

WELLS FARGO ONLINE PAYMENT SOLUTIONS

OWNER OF U.S. REG. NOS. 779,187, 2,476,743 AND OTHERS.

NO CLAIM IS MADE TO THE EXCLUSIVE RIGHT TO USE "ONLINE PAYMENT SOLUTIONS", APART FROM THE MARK AS SHOWN.

FOR BANKING SERVICES, NAMELY ELECTRONIC BILL PAYMENT AND PROCESSING SERVICES AND THE PROVISION OF PAYMENT ACTIVITY REPORTS (U.S. CLS. 100, 101 AND 102).

SN 76-345,200. DOLLARWORKS, INC., SAN MARINO, CA. FILED 12-6-2001.

DOLLARWORKS

FOR FINANCIAL SERVICES - NAMELY-CHECK CASHING SERVICES, PAYDAY LOAN ADVANCES, MONEY TRANSFER SERVICES (U.S. CLS. 100, 101 AND 102).

FIRST USE 10-1-2001; IN COMMERCE 10-1-2001.

SN 76-345,491. FARM FAMILY CASUALTY INSURANCE COMPANY, GLENMONT, NY. FILED 12-6-2001.

SFP 10

FOR INSURANCE SERVICES, NAMELY PROPERTY, CASUALTY, AND LIABILITY INSURANCE UNDERWRITING (U.S. CLS. 100, 101 AND 102).

FIRST USE 10-0-1995; IN COMMERCE 10-0-1995.

CLASS 36—(Continued).

SN 76-345,896. VILLAGE VENTURES, INC., WILLIAMSTOWN, MA. FILED 12-7-2001.

LIMESTONE

FOR FINANCIAL AND INVESTMENT SERVICES, NAMELY, INVESTMENT AND MANAGEMENT SERVICES RELATED TO THE OPERATION OF VENTURE CAPITAL FUNDS; MANAGING VENTURE CAPITAL FUNDS FOR OTHERS; VENTURE CAPITAL SERVICES, NAMELY, PROVIDING VENTURE CAPITAL FOR THE ESTABLISHMENT, OPERATION AND EXPANSION OF EMERGING TECHNOLOGY COMPANIES; AND VENTURE CAPITAL FINANCING SERVICES (U.S. CLS. 100, 101 AND 102).

FIRST USE 7-20-2001; IN COMMERCE 7-20-2001.

SN 76-348,331. GOLDMAN, SACHS & CO., NEW YORK, NY. FILED 12-11-2001.

GOLDMAN SACHS QUANTUM

FOR FINANCIAL SERVICES, NAMELY, DATABASES IN THE FIELDS OF FINANCE, INVESTMENT, ECONOMICS (U.S. CLS. 100, 101 AND 102).

SN 78-034,058. BLUEPRINT HEALTH, INC., OCEANSIDE, CA. FILED 11-6-2000.

BluePrint^{Health}

NO CLAIM IS MADE TO THE EXCLUSIVE RIGHT TO USE "HEALTH", APART FROM THE MARK AS SHOWN.

FOR DISCOUNT HEALTH CARE PLANS FEATURING CASH DISCOUNTS AT THE POINT OF SALE ON VARIOUS PRODUCTS AND SERVICES, NAMELY PRESCRIPTION PURCHASES, PHYSICIAN OFFICE VISITS, TRAVEL, FINANCIAL CONSULTATION, DENTAL, VISION AND HEARING (U.S. CLS. 100, 101 AND 102).

FIRST USE 10-18-2000; IN COMMERCE 10-18-2000.

SN 78-039,274. QUALITY CARE SOLUTIONS, INC., PHOENIX, AZ. FILED 12-14-2000.

AQHEALTH

FOR HEALTH INSURANCE CLAIMS ADMINISTRATION SERVICES, NAMELY CONFIRMING PATIENT ELIGIBILITY FOR TREATMENT, PROVIDING PATIENT CARE AUTHORIZATIONS, PROVIDING PATIENT CARE REFERRAL AUTHORIZATIONS, TRACKING COMPLETION OF PATIENT TREATMENTS, UPDATING OF PATIENT TREATMENT RECORDS, INSURANCE CLAIMS PROCESSING, CLAIMS ADJUDICATION AND INITIATING CLAIMS PAYMENTS BY ELECTRONIC FUNDS TRANSFER, ALL VIA LOCAL, PROPRIETARY OR GLOBAL COMPUTER NETWORKS (U.S. CLS. 100, 101 AND 102).

CLASS 36—(Continued).

SN 78-042,585. COLLABORATE SOLUTIONS, INC., TUCSON, AZ. FILED 1-10-2001.



NO CLAIM IS MADE TO THE EXCLUSIVE RIGHT TO USE "COLLABORATE FINANCIAL", APART FROM THE MARK AS SHOWN.

FOR FINANCIAL MANAGEMENT SERVICES PROVIDED VIA THE INTERNET TO FACILITATE BETWEEN A CLIENT AND MULTIPLE FINANCIAL ADVISORS THE COORDINATION OF THE CLIENT'S FINANCIAL DOCUMENTS, RECORDS AND COMMUNICATIONS TO ASSIST IN DECISION-MAKING (U.S. CLS. 100, 101 AND 102).

SN 78-042,593. METROPOLITAN LIFE INSURANCE COMPANY, NEW YORK, NY. FILED 1-10-2001.

HAVE YOU MET LIFE TODAY?

FOR INSURANCE UNDERWRITING, AGENCY, BROKERAGE, AND ADMINISTRATION SERVICES FOR INDIVIDUAL AND GROUP LIFE, DISABILITY, LONG TERM CARE, PROPERTY AND CASUALTY, AND DENTAL INSURANCE, ANNUITIES, EMPLOYEE BENEFITS, MUTUAL FUNDS, INVESTMENT CONTRACTS, AND RETIREMENT AND SAVINGS PLANS; FINANCIAL ANALYSIS AND CONSULTATION WITH RESPECT TO LIFE AND LONG TERM CARE INSURANCE, ANNUITIES, RETIREMENT AND SAVINGS PLANS, AND SECURITIES; INVESTMENT ADVISORY SERVICES; INVESTMENT MANAGEMENT SERVICES; BANKING SERVICES; CREDIT CARD SERVICES; ESTATE TRUST MANAGEMENT SERVICES; COMMERCIAL LENDING SERVICES; RESIDENTIAL AND COMMERCIAL MORTGAGE LENDING SERVICES; REAL ESTATE BROKERAGE, MANAGEMENT, AND INVESTMENT SERVICES; PROVIDING INFORMATION IN THE FIELDS OF INSURANCE, BANKING, INVESTMENTS, AND FINANCIAL SERVICES VIA THE INTERNET; AND A HOUSE MARK FOR A FULL RANGE OF INSURANCE, BANKING, INVESTMENT, AND FINANCIAL SERVICES (U.S. CLS. 100, 101 AND 102).

CLASS 36—(Continued).

SN 78-053,523. MEDIMMUNE, INC., GAITHERSBURG, MD. FILED 3-16-2001.

SYNAGIS SECURE PLUS + PROGRAM

OWNER OF U.S. REG. NO. 2,248,349.
NO CLAIM IS MADE TO THE EXCLUSIVE RIGHT TO USE "PROGRAM", APART FROM THE MARK AS SHOWN.
FOR INSURANCE REIMBURSEMENT SUPPORT PROVIDED TO DOCTORS WHO ADMINISTER PHARMACEUTICALS TO PATIENTS (U.S. CLS. 100, 101 AND 102).
FIRST USE 12-1-1999; IN COMMERCE 12-1-1999.

SN 78-064,323. MEDICAL RESEARCH AGENCIES OF AMERICA, INC., SPRINGFIELD, VA. FILED 5-18-2001.

MEDICAL RESEARCH AGENCIES OF AMERICA

NO CLAIM IS MADE TO THE EXCLUSIVE RIGHT TO USE "MEDICAL RESEARCH AGENCIES", APART FROM THE MARK AS SHOWN.

SEC. 2(F).
FOR MANAGEMENT OF FUND RAISING CAMPAIGN AND CHARITABLE FUND RAISING SERVICES (U.S. CLS. 100, 101 AND 102).
FIRST USE 3-1-1992; IN COMMERCE 3-1-1992.

SN 78-084,688. WISCONSIN HOUSING AND ECONOMIC DEVELOPMENT AUTHORITY, MADISON, WI. FILED 9-20-2001.

HOUSEKEY WISCONSIN

NO CLAIM IS MADE TO THE EXCLUSIVE RIGHT TO USE "WISCONSIN", APART FROM THE MARK AS SHOWN.
FOR PROVIDING MORTGAGE LOAN APPLICATION PROCESSING SERVICES TO HOMEBUYERS AND LENDERS VIA THE INTERNET (U.S. CLS. 100, 101 AND 102).
FIRST USE 8-27-2001; IN COMMERCE 8-27-2001.

SN 78-093,526. PULASKI BANK & TRUST COMPANY, LITTLE ROCK, AR. FILED 11-15-2001.

EQUICARD

FOR HOME EQUITY CREDIT LINE SERVICES ACCESSIBLE VIA A CREDIT CARD (U.S. CLS. 100, 101 AND 102).

CLASS 36—(Continued).

SN 78-093,706. CAREY, CHARLES R., POTOMAC, MD.
FILED 11-16-2001.

RENNIE MAE

FOR LEASE APPLICATION, CREDIT EVALUATION,
PAYMENT PROCESSING AND GUARANTEE SERVICES
(U.S. CLS. 100, 101 AND 102).

SN 78-093,839. COMMODITIES MANAGEMENT EX-
CHANGE, INC., NORTHFIELD, IL. FILED 11-16-2001.

CMXFLEXCLEAR

FOR COMMODITIES EXCHANGE SERVICES,
NAMELY, SERVICES RELATING TO CLEARED, CASH-
SETTLED FORWARD SWAPS FOR METALS (U.S. CLS.
100, 101 AND 102).

SN 78-096,482. BFS BRANDS, LLC, NASHVILLE, TN. FILED
12-4-2001.

BFS

FOR BANKING SERVICES, NAMELY CREDIT CARD
SERVICES (U.S. CLS. 100, 101 AND 102).

SN 78-097,260. GATEWAY FINANCIAL LTD., GREENVALE,
NY. FILED 12-7-2001.

**YOUR GATEWAY TO HOME
OWNERSHIP**

FOR MORTGAGE BANKING SERVICES (U.S. CLS.
100, 101 AND 102).
FIRST USE 4-1-2001; IN COMMERCE 4-1-2001.

CLASS 37—CONSTRUCTION AND REPAIR

SN 75-704,752. SANTA BARBARA LAND & CATTLE, INC.,
SANTA BARBARA, CA. FILED 5-13-1999.

STAR POWER

NO CLAIM IS MADE TO THE EXCLUSIVE RIGHT TO
USE "POWER", APART FROM THE MARK AS SHOWN.

FOR RENTAL OF INDUSTRIAL EQUIPMENT,
NAMELY GENERATORS AND OTHER POWER DISTRI-
BUTION EQUIPMENT, LIGHTING EQUIPMENT, HVAC
EQUIPMENT AND RELATED REFUELING EQUIP-
MENT AND THE ON-SITE SET UP, OPERATION AND
REMOVAL OF SAID EQUIPMENT (U.S. CLS. 100, 103
AND 106).

FIRST USE 8-3-1998; IN COMMERCE 2-10-1999.

CLASS 37—(Continued).

SN 75-847,921. LUNDGREN BROS. CONSTRUCTION, INC.,
WAYZATA, MN. FILED 11-12-1999.

**YOUR NEIGHBORHOOD
BUILDER**

LUNDGREN BROS. CONSTRUCTION, INC., 935 EAST
WAYZATA BLVD., WAYZATA, MN 55391. APPLICANT
USES THE MARK "YOUR NEIGHBORHOOD BUILDER"
FOR RESIDENTIAL BUILDING CONSTRUCTION SER-
VICES IN MINNESOTA AND THE CONTIGUOUS STATES
OF WISCONSIN, IOWA, NORTH DAKOTA, AND SOUTH
DAKOTA, "APPLICANT'S TERRITORY." THUS APPLI-
CANT CLAIMS EXCLUSIVE USE OF THE MARK SOLELY
WITHIN THE GEOGRAPHIC AREA WHICH COMPRISES
THE "APPLICANT'S TERRITORY". STANDARD PACIFIC
CORP., 15326 ALTON PARKWAY, IRVINE PARKWAY,
CALIFORNIA 92618. STANDARD PACIFIC CORP. HAS
USED AND CONTINUES TO USE THE MARK OUTSIDE
OF THE APPLICANT'S TERRITORY, AND MORE SPECIFI-
CALLY USES THE MARK IN CALIFORNIA ARIZONA AND
TEXAS.

NO CLAIM IS MADE TO THE EXCLUSIVE RIGHT TO
USE "BUILDER", APART FROM THE MARK AS SHOWN.

FOR RESIDENTIAL BUILDING CONSTRUCTION
(U.S. CLS. 100, 103 AND 106).

FIRST USE 12-31-1995; IN COMMERCE 12-31-1995.

SN 76-008,458. APPLIED AERODYNAMICS, INC., DALLAS,
TX. FILED 3-23-2000.



NO CLAIM IS MADE TO THE EXCLUSIVE RIGHT TO
USE "AERODYNAMICS, INC.", APART FROM THE MARK
AS SHOWN.

FOR AIRCRAFT MAINTENANCE AND REPAIR SER-
VICES, NAMELY, THE MAINTENANCE AND REPAIR
OF AIRCRAFT AND AIRCRAFT COMPONENTS (U.S.
CLS. 100, 103 AND 106).

FIRST USE 10-0-1997; IN COMMERCE 10-0-1997.

SN 76-041,421. GENDRON, DAN, ROSWELL, NM. FILED 5-4-
2000.

The logo for Watch Fix features the words "Watch Fix" in a large, bold, italicized sans-serif font. The "W" is significantly larger and more prominent than the other letters.

FOR WATCH REPAIR (U.S. CLS. 100, 103 AND 106).
FIRST USE 1-1-1996; IN COMMERCE 1-1-1996.

CLASS 37—(Continued).

SN 76-053,567. WATERMARK COMMUNITIES, INC., BONITA SPRINGS, FL. FILED 5-22-2000.

WATERLEFE

FOR REAL ESTATE DEVELOPMENT AND CONSTRUCTION SERVICES, NAMELY, THE DEVELOPMENT AND CONSTRUCTION OF LEISURE-ORIENTED MASTER PLANNED COMMUNITIES, RESIDENTIAL HOMES, GOLF COURSES, RESIDENTIAL COMMUNITY AMENITIES, LUXURY MID-RISE BUILDINGS AND HOTEL RESORTS (U.S. CLS. 100, 103 AND 106).

FIRST USE 2-8-1999; IN COMMERCE 2-8-1999.

SN 76-077,411. AARDEX CORPORATION, LAKEWOOD, CO. FILED 6-26-2000.

AARDEX

FOR REAL ESTATE SERVICES, NAMELY, SITE SELECTION AND DEVELOPMENT OF COMMERCIAL PROPERTIES FOR OTHERS (U.S. CLS. 100, 103 AND 106).

FIRST USE 5-31-1983; IN COMMERCE 5-31-1983.

SN 76-120,668. PROJECT CONSULTING SERVICES, INC., METAIRIE, LA. FILED 8-31-2000.

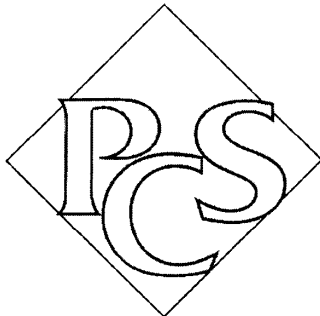

THE MARK CONSISTS OF THE LETTERS "PCS" ENCLOSED IN A DIAMOND.

FOR CONSTRUCTION MANAGEMENT IN THE FIELD OF BOTH ONSHORE AND OFFSHORE PROJECTS IN THE OIL AND GAS INDUSTRY (U.S. CLS. 100, 103 AND 106).

CLASS 37—(Continued).

SN 76-121,875. THUNDER SPRING LLC, KETCHUM, ID. FILED 9-1-2000.

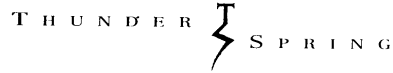

THE MARK CONSISTS OF THE STYLIZED LETTERS "TS".

FOR REAL ESTATE DEVELOPMENT (U.S. CLS. 100, 103 AND 106).

FIRST USE 2-0-1998; IN COMMERCE 2-0-1998.

SN 76-142,834. MSC MULTIMEDIA SUPPORT CENTER GMBH, 50827 KOLN, FED REP GERMANY, FILED 10-6-2000.

GERMANBETA

FOR INSTALLATION, ON-SITE AND REMOTE MAINTENANCE, SERVICING AND REPAIR OF TELECOMMUNICATIONS DEVICES, IN PARTICULAR TELEPHONE NETWORKS, TELEPHONE SYSTEMS, MOBILE TELEPHONES AND FAX APPARATUS, OFFICE MACHINES AND EQUIPMENT, AND ACCESSORIES THEREFORE, DATA AND MESSAGE PROCESSING EQUIPMENT, COMPUTER NETWORKS AND EQUIPMENT OR CABLES FOR DATA TRANSMISSION; TELECOMMUTING SERVICES, NAMELY, INSTALLATION OF COMPUTER NETWORKS AND TELEPHONE LINES TO FACILITATE WORKING OFFSITE (U.S. CLS. 100, 103 AND 106).

SN 76-159,632. TRIGEN ENERGY CORPORATION, WHITE PLAINS, NY. FILED 11-6-2000.

DOWNTOWN SOLUTIONS

FOR PROVIDING OPERATIONAL MAINTENANCE OF HEATING AND COOLING POWER SYSTEMS IN COMMERCIAL, INDUSTRIAL, AND INSTITUTIONAL ENTITIES AND DISTRICTS (U.S. CLS. 100, 103 AND 106).

SN 76-159,633. TRIGEN ENERGY CORPORATION, WHITE PLAINS, NY. FILED 11-6-2000.

CUSTOMER SOLUTIONS

FOR PROVIDING OPERATIONAL MAINTENANCE OF HEATING AND COOLING POWER SYSTEMS IN COMMERCIAL, INDUSTRIAL, AND INSTITUTIONAL ENTITIES AND DISTRICTS (U.S. CLS. 100, 103 AND 106).

CLASS 37—(Continued).

SN 76-165,731. PHONE HOUSE B.V., THE, AMSTERDAM, NETHERLANDS, FILED 11-15-2000.



FOR INSTALLATION, MAINTENANCE AND REPAIR OF COMMUNICATIONS AND TELECOMMUNICATIONS APPARATUS, EQUIPMENT AND ACCESSORIES, NAMELY, AMPLIFIERS, HEADPHONES, SPEAKERS, MICROPHONES, MOBILE PHONES, FAX MACHINES, TELEPHONES, ANSWERING MACHINES, TWO-WAY RADIOS, POWER ADAPTERS, POWER CHARGERS, ANTENNAS, BATTERIES, CAMERAS, BINOCULARS, CAMCORDERS, HANDHELD COMPUTERS, CD DRIVES, PRINTERS, SCANNERS, WEB CAMERAS, ELECTRONIC ORGANIZERS, CALCULATORS, REMOTE CONTROLS, PERSONAL COMPUTERS AND LAPTOP COMPUTERS; INSTALLATION, MAINTENANCE AND REPAIR OF PAGING APPARATUS AND EQUIPMENT, NAMELY, PAGERS, POWER ADAPTERS AND POWER CHARGERS; INSTALLATION, MAINTENANCE AND REPAIR OF COMPUTER HARDWARE; PROVISION OF INFORMATION RELATING TO INSTALLATION, SERVICE, MAINTENANCE AND REPAIR OF COMMUNICATIONS, COMPUTER, TELECOMMUNICATIONS, AND PAGING APPARATUS, EQUIPMENT AND ACCESSORIES; INSTALLATION, REPAIR AND MAINTENANCE SERVICES FOR CONSUMER ELECTRONIC PRODUCTS, NAMELY, AMPLIFIERS, HEADPHONES, SPEAKERS, MICROPHONES, MOBILE PHONES, FAX MACHINES, TELEPHONES, ANSWERING MACHINES, TWO-WAY RADIOS, POWER ADAPTERS, POWER CHARGERS, CAMERAS, BINOCULARS, CAMCORDERS, HANDHELD COMPUTERS, CD DRIVES, PRINTERS, SCANNERS, WEB CAMERAS, ELECTRONIC ORGANIZERS, CALCULATORS, REMOTE CONTROLS, PERSONAL COMPUTERS, LAPTOP COMPUTERS, RADIOS, CLOCK RADIOS, PORTABLE CD RADIO CASSETTE PLAYERS, DIGITAL AUDIO PLAYERS AND CD PLAYERS; INSTALLATION, REPAIR AND MAINTENANCE SERVICES FOR PHOTOGRAPHIC APPARATUS, EQUIPMENT AND ACCESSORIES, NAMELY, CAMERAS, CAMCORDERS, WEB CAMERAS, POWER ADAPTERS, POWER CHARGERS, REMOTE CONTROLS, SCANNERS, PERSONAL COMPUTERS, HANDHELD COMPUTERS, AND LAPTOP COMPUTERS (U.S. CLS. 100, 103 AND 106).

CLASS 37—(Continued).

SN 76-165,739. PHONE HOUSE B.V., THE, AMSTERDAM, NETHERLANDS, FILED 11-15-2000.

PHONE HOUSE

NO CLAIM IS MADE TO THE EXCLUSIVE RIGHT TO USE "PHONE", APART FROM THE MARK AS SHOWN.

FOR INSTALLATION, MAINTENANCE AND REPAIR OF COMMUNICATIONS AND TELECOMMUNICATIONS APPARATUS, EQUIPMENT AND ACCESSORIES, NAMELY, AMPLIFIERS, HEADPHONES, SPEAKERS, MICROPHONES, MOBILE PHONES, FAX MACHINES, TELEPHONES, ANSWERING MACHINES, TWO-WAY RADIOS, POWER ADAPTERS, POWER CHARGERS, ANTENNAS, BATTERIES, CAMERAS, BINOCULARS, CAMCORDERS, HANDHELD COMPUTERS, CD DRIVES, PRINTERS, SCANNERS, WEB CAMERAS, ELECTRONIC ORGANIZERS, CALCULATORS, REMOTE CONTROLS, PERSONAL COMPUTERS AND LAPTOP COMPUTERS; INSTALLATION, MAINTENANCE AND REPAIR OF PAGING APPARATUS AND EQUIPMENT, NAMELY, PAGERS, POWER ADAPTERS AND POWER CHARGERS; INSTALLATION, MAINTENANCE AND REPAIR OF COMPUTER HARDWARE; PROVISION OF INFORMATION RELATING TO INSTALLATION, SERVICE, MAINTENANCE AND REPAIR OF COMMUNICATIONS, COMPUTER, TELECOMMUNICATIONS, AND PAGING APPARATUS, EQUIPMENT AND ACCESSORIES; INSTALLATION, REPAIR AND MAINTENANCE SERVICES FOR CONSUMER ELECTRONIC PRODUCTS, NAMELY, AMPLIFIERS, HEADPHONES, SPEAKERS, MICROPHONES, MOBILE PHONES, FAX MACHINES, TELEPHONES, ANSWERING MACHINES, TWO-WAY RADIOS, POWER ADAPTERS, POWER CHARGERS, CAMERAS, BINOCULARS, CAMCORDERS, HANDHELD COMPUTERS, CD DRIVES, PRINTERS, SCANNERS, WEB CAMERAS, ELECTRONIC ORGANIZERS, CALCULATORS, REMOTE CONTROLS, PERSONAL COMPUTERS, LAPTOP COMPUTERS, RADIOS, CLOCK RADIOS, PORTABLE CD RADIO CASSETTE PLAYERS, DIGITAL AUDIO PLAYERS AND CD PLAYERS; INSTALLATION, REPAIR AND MAINTENANCE SERVICES FOR PHOTOGRAPHIC APPARATUS, EQUIPMENT AND ACCESSORIES, NAMELY, CAMERAS, CAMCORDERS, WEB CAMERAS, POWER ADAPTERS, POWER CHARGERS, REMOTE CONTROLS, SCANNERS, PERSONAL COMPUTERS, HANDHELD COMPUTERS, AND LAPTOP COMPUTERS (U.S. CLS. 100, 103 AND 106).

SN 76-191,539. CHARLESTON CONSTRUCTION COMPANY, LLC, SUMMERVILLE, SC. FILED 1-9-2001.



Charleston Construction Company
The Strength of Steel the Comfort of Home

NO CLAIM IS MADE TO THE EXCLUSIVE RIGHT TO USE "CHARLESTON CONSTRUCTION COMPANY", APART FROM THE MARK AS SHOWN.

FOR RESIDENTIAL AND COMMERCIAL BUILDING CONSTRUCTION (U.S. CLS. 100, 103 AND 106).

CLASS 37—(Continued).

SN 76-203,316. VINCITI NETWORKS, INC., SANTA CLARA, CA. FILED 1-30-2001.

VINCITI

FOR INSTALLATION, REPAIR AND MAINTENANCE OF COMPUTER HARDWARE, COMPUTER SYSTEMS, COMPUTER NETWORKS AND COMMUNICATION NETWORKS (U.S. CLS. 100, 103 AND 106).

SN 76-220,889. HBR COMPUTER STORES, INC., DBA HBR TECHNOLOGIES, CARROLLTON, TX. FILED 3-5-2001.

HBR

FOR MAINTENANCE AND INSTALLATION OF COMPUTER HARDWARE AND COMPUTER NETWORKS (U.S. CLS. 100, 103 AND 106).

SN 76-220,891. HBR COMPUTER STORES, INC., DBA HBR TECHNOLOGIES, CARROLLTON, TX. FILED 3-5-2001.

HBR TECHNOLOGIES

NO CLAIM IS MADE TO THE EXCLUSIVE RIGHT TO USE "TECHNOLOGIES", APART FROM THE MARK AS SHOWN.

FOR MAINTENANCE AND INSTALLATION OF COMPUTER HARDWARE AND COMPUTER NETWORKS (U.S. CLS. 100, 103 AND 106).
FIRST USE 10-1-1999; IN COMMERCE 10-1-1999.

SN 76-220,895. HBR COMPUTER STORES, INC., DBA HBR TECHNOLOGIES, CARROLLTON, TX. FILED 3-5-2001.

HBR TECHNOLOGIES

NO CLAIM IS MADE TO THE EXCLUSIVE RIGHT TO USE "TECHNOLOGIES", APART FROM THE MARK AS SHOWN.

FOR MAINTENANCE AND INSTALLATION OF COMPUTER HARDWARE AND COMPUTER NETWORKS (U.S. CLS. 100, 103 AND 106).
FIRST USE 3-1-1999; IN COMMERCE 3-1-1999.

SN 76-220,897. HBR COMPUTER STORES, INC., DBA HBR TECHNOLOGIES, CARROLLTON, TX. FILED 3-5-2001.

THE POWER IS IN THE PARTNERSHIP

FOR MAINTENANCE AND INSTALLATION OF COMPUTER HARDWARE AND COMPUTER NETWORKS (U.S. CLS. 100, 103 AND 106).
FIRST USE 10-1-1999; IN COMMERCE 10-1-1999.

CLASS 37—(Continued).

SN 76-227,264. A.T. MASSEY COAL COMPANY, INC., RICHMOND, VA. FILED 3-19-2001.

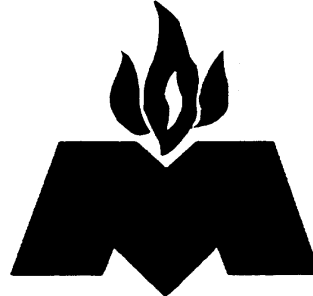

FOR COAL MINING EXTRACTION SERVICES (U.S. CLS. 100, 103 AND 106).
FIRST USE 1-3-1960; IN COMMERCE 1-3-1960.

SN 76-227,601. A.T. MASSEY COAL COMPANY, INC., RICHMOND, VA. FILED 3-19-2001.



Massey Energy

NO CLAIM IS MADE TO THE EXCLUSIVE RIGHT TO USE "ENERGY", APART FROM THE MARK AS SHOWN.
FOR COAL MINING EXTRACTION SERVICES (U.S. CLS. 100, 103 AND 106).
FIRST USE 6-8-2000; IN COMMERCE 6-8-2000.

SN 76-232,494. MARSON CORPORATION, BRACKNEY, PA. FILED 3-29-2001.



NO CLAIM IS MADE TO THE EXCLUSIVE RIGHT TO USE "ENERGY", APART FROM THE MARK AS SHOWN.
FOR CONSTRUCTION OF POWER PLANTS AND LAND DEVELOPMENT TO FACILITATE THE BUILDING OF POWER PLANTS (U.S. CLS. 100, 103 AND 106).
FIRST USE 1-1-1992; IN COMMERCE 1-1-1992.

CLASS 37—(Continued).

SN 76-267,184. USA AIRMOBILE, INC., FORT LAUDERDALE, FL. FILED 6-5-2001.

USA AIRMOBILE

OWNER OF U.S. REG. NOS. 1,278,324, 1,455,757 AND 1,643,908.

NO CLAIM IS MADE TO THE EXCLUSIVE RIGHT TO USE "USA", APART FROM THE MARK AS SHOWN.

FOR MAINTENANCE OF POWER TRANSMISSION LINES AND DISTRIBUTION EQUIPMENT; AND POWER TRANSMISSION LINE CONSTRUCTION SERVICES (U.S. CLS. 100, 103 AND 106).

FIRST USE 4-0-1991; IN COMMERCE 4-0-1991.

SN 76-272,774. DOMINION MAIDS, INC., ALEXANDRIA, VA. FILED 6-18-2001.

DOMINION MAIDS

NO CLAIM IS MADE TO THE EXCLUSIVE RIGHT TO USE "MAIDS", APART FROM THE MARK AS SHOWN.

FOR DOMESTIC SERVICES, NAMELY, CLOTHING LAUNDRY, AND DRY CLEANING (U.S. CLS. 100, 103 AND 106).

SN 76-298,721. MERLIN CORPORATION, GENEVA, IL. FILED 8-14-2001.

AT MERLIN'S MUFFLER & BRAKE, WE DO MORE THAN FIX CARS. WE TAKE CARE OF PEOPLE.

OWNER OF U.S. REG. NOS. 1,025,371, 1,390,714 AND OTHERS.

FOR AUTOMOTIVE REPAIR SERVICES (U.S. CLS. 100, 103 AND 106).

FIRST USE 3-15-1997; IN COMMERCE 3-15-1997.

SN 76-312,756. PIPE SPY INC., BERKELEY, CA. FILED 9-17-2001.

UNTRENCHING AMERICA

NO CLAIM IS MADE TO THE EXCLUSIVE RIGHT TO USE "AMERICA", APART FROM THE MARK AS SHOWN.

FOR PLUMBING SERVICES AND INSTALLATION AND REPAIR OF HEATING AND SEWER SYSTEMS (U.S. CLS. 100, 103 AND 106).

FIRST USE 9-12-1999; IN COMMERCE 9-12-1999.

CLASS 37—(Continued).

SN 76-330,103. TROPIX POOLS, INC., DALLAS, TX. FILED 10-19-2001.



NO CLAIM IS MADE TO THE EXCLUSIVE RIGHT TO USE "THE POOL SERVICE PEOPLE", APART FROM THE MARK AS SHOWN.

FOR SWIMMING POOL MAINTENANCE SERVICES (U.S. CLS. 100, 103 AND 106).

FIRST USE 11-20-2000; IN COMMERCE 11-20-2000.

SN 76-334,798. TAYLOR, MICHAEL L., BAKERSFIELD, CA. FILED 11-5-2001.

REGROUT



NO CLAIM IS MADE TO THE EXCLUSIVE RIGHT TO USE "REGROUT", APART FROM THE MARK AS SHOWN. FOR INSTALLATION AND REMOVAL OF TILE GROUT (U.S. CLS. 100, 103 AND 106).

FIRST USE 12-31-1993; IN COMMERCE 12-31-1993.

SN 76-334,918. LA PLATA INVESTMENTS, LLC, COLORADO SPRINGS, CO. FILED 11-6-2001.



OWNER OF U.S. REG. NO. 2,321,290. FOR COMMERCIAL REAL ESTATE DEVELOPMENT SERVICES (U.S. CLS. 100, 103 AND 106).

SN 76-334,919. LA PLATA INVESTMENTS, LLC, COLORADO SPRINGS, CO. FILED 11-6-2001.

BRIARGATE CROSSING

OWNER OF U.S. REG. NO. 2,321,290. FOR COMMERCIAL REAL ESTATE DEVELOPMENT SERVICES (U.S. CLS. 100, 103 AND 106).

CLASS 37—(Continued).

SN 76-340,380. NATURALLY CLEAN INC., NORWOOD, MA.
FILED 11-21-2001.

NATURALLY CLEAN

FOR MAID SERVICES (U.S. CLS. 100, 103 AND 106).
FIRST USE 12-15-1999; IN COMMERCE 1-10-2000.

SN 76-349,114. DESERT TROON LIMITED, LLC, SCOTTSDALE, AZ. FILED 12-17-2001.

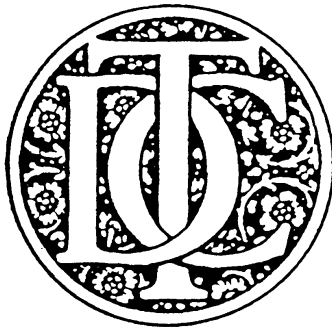

FOR CONSTRUCTION SERVICES, NAMELY, PLANNING, LAYING OUT AND CUSTOM CONSTRUCTION OF RESIDENTIAL COMMUNITIES AND REAL ESTATE DEVELOPMENT SERVICES (U.S. CLS. 100, 103 AND 106).
FIRST USE 3-1-1989; IN COMMERCE 3-1-1989.

SN 78-020,757. SIG COMBIBLOC INC., COLUMBUS, OH.
FILED 8-11-2000.

BYESVILLE ASEPTICS

NO CLAIM IS MADE TO THE EXCLUSIVE RIGHT TO USE "ASEPTICS", APART FROM THE MARK AS SHOWN.
FOR MAINTENANCE SERVICES OR REPAIR SERVICES FOR PACKAGE FILLING MACHINES AND PACKAGING MACHINES (U.S. CLS. 100, 103 AND 106).

SN 78-029,988. FRIEDMAN, HARVEY, BEVERLY HILLS, CA.
FILED 10-10-2000.

2C CONSTRUCTION AND REPAIR

NO CLAIM IS MADE TO THE EXCLUSIVE RIGHT TO USE "CONSTRUCTION AND REPAIR", APART FROM THE MARK AS SHOWN.
FOR PROVIDING INFORMATION IN THE FIELD OF BUILDING CONSTRUCTION AND REPAIR VIA WEBSITES ON THE INTERNET (U.S. CLS. 100, 103 AND 106).

CLASS 37—(Continued).

SN 78-032,669. KINGSLEY MANAGEMENT, LLC, BOSTON, MA. FILED 10-27-2000.

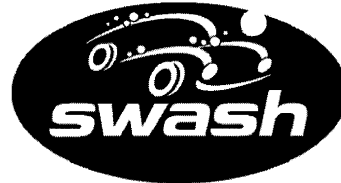

NO CLAIM IS MADE TO THE EXCLUSIVE RIGHT TO USE "SWASH", APART FROM THE MARK AS SHOWN.

COLORS ARE A FEATURE OF THE MARK. THE WORD "SWASH" IN THE DRAWING IS THE COLOR WHITE, THE BACKGROUND OF THE DESIGN IS THE COLOR NAVY BLUE, THE OUTLINE OF THE STYLIZED CAR AND ITS TWO WHEELS IS THE COLOR LIGHT BLUE, AND THE CIRCLES (BUBBLES) AND TWO HEADLIGHTS ARE THE COLOR WHITE.

FOR WASHING, CLEANING AND WAXING SERVICES FOR AUTOMOBILES AND OTHER MOTOR VEHICLES (U.S. CLS. 100, 103 AND 106).

SN 78-047,328. SARAMAR, L.L.C., CHICAGO, IL. FILED 2-8-2001.



FOR SHOE REPAIR SERVICES AND SHOE SHINE SERVICES (U.S. CLS. 100, 103 AND 106).

CLASS 37—(Continued).

SN 78-056,826. INTERMEC TECHNOLOGIES CORPORATION, EVERETT, WA. FILED 4-4-2001.

SILVER REPLACEMENT

OWNER OF U.S. REG. NOS. 1,460,337 AND 1,915,868.
NO CLAIM IS MADE TO THE EXCLUSIVE RIGHT TO USE "REPLACEMENT", APART FROM THE MARK AS SHOWN.

FOR REPAIR, REPLACEMENT, AND MAINTENANCE OF AUTOMATIC IDENTIFICATION, DATA COLLECTION AND DATA STORAGE, AND SUPPLY CHAIN APPARATUS, NAMELY, DATA PRINTING AND BAR CODE READING DEVICES, NAMELY, ELECTRONIC LABEL AND TAG PRINTERS, BAR CODE READERS, SCANNERS, AND IMAGERS; HAND-HELD LIGHT PENS AND WANDS INCLUDING SIGNAL MULTIPLEXERS FOR COUPLING A PLURALITY OF BAR CODE READERS TO A COMPUTER; BATTERIES, BATTERY CHARGERS AND DISCHARGERS, INTERCONNECT CABLES, SIGNAL INTERFACE MODULES AND UNITS, POWER SUPPLIED LASER SCANNERS, CONTACT AND NON-CONTACT SCANNERS, CONCENTRATORS AND PROTOCOL CONVERTERS FOR PROVIDING BI-DIRECTIONAL DATA COMMUNICATIONS BETWEEN A PLURALITY OF BAR CODE READERS AND PRINTERS AND A HOST COMPUTER OR INTEGRATED TERMINAL DEVICES HAVING KEYBOARDS FOR PROVIDING DATA TO A CENTRAL DATA BASE, SUCH TERMINALS ALSO PROCESSING AND SCANNING INDICIA CONTAINING BAR CODES AND OTHER SYMBOLOGY, ELECTRONIC CONTROLLERS FOR MACHINING AND ASSEMBLY OF MACHINES, HAND-HELD DATA COLLECTION COMPUTER TERMINALS, PORTABLE PROGRAMMABLE BAR CODE READERS, AND HAND-HELD SCANNERS WITH A KEYPAD AND DISPLAY, RADIO FREQUENCY IDENTIFICATION INTERROGATORS, WIRELESS SCANNERS, TERMINALS, AND INTERROGATORS; ALL THE FOREGOING DATA COLLECTION, IDENTIFICATION, AND DATA STORAGE APPARATUS FOR USE IN WAN AND LAN APPLICATIONS (U.S. CLS. 100, 103 AND 106).

CLASS 38—COMMUNICATION

SN 75-325,992. DAJ/JAJ, LLC, HELENA, MT. FILED 7-17-1997.



FOR PAGING SERVICES, ELECTRONIC AND LIVE TELEPHONE ANSWERING SERVICES, ELECTRONIC VOICE MESSAGING BY TELEPHONE, CELLULAR TELEPHONE SERVICES, FACSIMILE SERVICES, AND RELATED TELEPHONE COMMUNICATION SERVICES (U.S. CLS. 100, 101 AND 104).

FIRST USE 10-0-1987; IN COMMERCE 10-0-1987.

CLASS 38—(Continued).

SN 75-533,308. ROSEVILLE TELEPHONE COMPANY, ROSEVILLE, CA. FILED 8-10-1998.

RCS

FOR TELECOMMUNICATIONS SERVICES, NAMELY, WIRELESS TELEPHONE SERVICES, ELECTRONIC VOICE MESSAGING, NAMELY, THE RECORDING, STORAGE AND SUBSEQUENT TRANSMISSION OF VOICE MESSAGES BY TELEPHONE, FACSIMILE TRANSMISSION, DATA AND VOICE TELECOMMUNICATION, ISDN SERVICES, GATEWAY SERVICES, NAMELY, ANALOG/DIGITAL SIGNAL PROTOCOL CONVERSION, TELEPHONE COMMUNICATION SERVICES, AND PROVIDING MULTIPLE-USER ACCESS TO A GLOBAL COMPUTER NETWORK; PROVIDING MULTIPLE-USER ACCESS TO A GLOBAL COMPUTER INFORMATION NETWORK FOR THE TRANSFER AND DISSEMINATION OF A WIDE RANGE OF INFORMATION (U.S. CLS. 100, 101 AND 104).

SN 75-547,329. GTE SERVICE CORPORATION, IRVING, TX. FILED 9-3-1998.

SPEECHCONNECT

FOR TELECOMMUNICATION SERVICES; NAMELY, AUTOMATED SPEECH RECOGNITION AND VOICE DIALING SERVICES (U.S. CLS. 100, 101 AND 104).

SN 75-657,420. INFONXX, INC., BETHLEHEM, PA. FILED S.R. 3-10-1999; AM. P.R. 12-7-2001.

WIRELESS WHITE PAGES

NO CLAIM IS MADE TO THE EXCLUSIVE RIGHT TO USE "WIRELESS", APART FROM THE MARK AS SHOWN.

FOR PROVIDING TELECOMMUNICATIONS SERVICES, NAMELY, DIRECTORY ASSISTANCE AND CALL COMPLETION SERVICES FEATURING WIRELESS PHONES AND PAGERS AND OTHER PERSONAL COMMUNICATION DEVICES, NAMELY, HAND-HELD COMPUTING DEVICES (U.S. CLS. 100, 101 AND 104).

FIRST USE 2-26-1999; IN COMMERCE 2-26-1999.

SN 75-744,157. DIGITAL BROADBAND COMMUNICATIONS, INC., WINCHESTER, MA. FILED 7-6-1999.

MB2U

FOR TELECOMMUNICATIONS SERVICES, NAMELY, PROVIDING MULTIPLE USER ACCESS TO PUBLICLY AVAILABLE COMPUTER INFORMATION NETWORKS FOR THE TRANSFER AND DISSEMINATION OF INFORMATION VIA ASYMMETRIC DIGITAL SUBSCRIBER LINE CONNECTIVITY FOR ELECTRONIC TRANSMISSION AND RECEPTION OF INFORMATION (U.S. CLS. 100, 101 AND 104).

CLASS 38—(Continued).

SN 75-855,440. DISCOVERY COMMUNICATIONS, INC.,
BETHESDA, MD. FILED 12-10-1999.

VTHHERE

FOR WEBSITE OFFERING INTERACTIVE ACCESS TO
REAL TIME IMAGES OF VARIOUS GEOGRAPHICAL
LOCALS (U.S. CLS. 100, 101 AND 104).

SN 75-855,450. DISCOVERY COMMUNICATIONS, INC.,
BETHESDA, MD. FILED 12-10-1999.

**DISCOVERY VTHHERE
JOURNEYS**

OWNER OF U.S. REG. NOS. 883,953, 2,108,208 AND
2,109,581.

FOR WEBSITE OFFERING INTERACTIVE ACCESS TO
REAL TIME IMAGES OF VARIOUS GEOGRAPHICAL
LOCALS (U.S. CLS. 100, 101 AND 104).

SN 75-855,463. DISCOVERY COMMUNICATIONS, INC.,
BETHESDA, MD. FILED 12-10-1999.

DISCOVERY VTJ

OWNER OF U.S. REG. NOS. 883,953, 2,108,208 AND
2,109,581.

FOR WEBSITE OFFERING INTERACTIVE ACCESS TO
REAL TIME IMAGES OF VARIOUS GEOGRAPHICAL
LOCALS (U.S. CLS. 100, 101 AND 104).

SN 75-862,755. QUANTUM BRIDGE COMMUNICATIONS,
INC., NORTH ANDOVER, MA. FILED 12-2-1999.

**DYNAMIC WAVELENGTH
SLICING**

NO CLAIM IS MADE TO THE EXCLUSIVE RIGHT TO
USE "WAVELENGTH SLICING", APART FROM THE
MARK AS SHOWN.

FOR TELECOMMUNICATIONS SYSTEMS AND
EQUIPMENT FOR BROADBAND DATA ACCESS,
NAMESLY, OPTICAL ACCESS TERMINALS AND OPTI-
CAL ACCESS SWITCHES (U.S. CLS. 100, 101 AND 104).

CLASS 38—(Continued).

SN 75-938,156. CULVER, THOMAS P., SAN MARCOS, CA.
FILED 3-7-2000.

WALLETPC.COM

FOR WIRELESS TELEPHONE SERVICES, NAMELY
TELEPHONE COMMUNICATION SERVICES, AND PRO-
VIDING MULTIPLE-USER ACCESS TO A GLOBAL
COMPUTER INFORMATION NETWORK, FOR HAND-
HELD WIRELESS DEVICES, NAMELY, WIRELESS PER-
SONAL DATA ASSISTANTS AND WIRELESS PALMTOP
DEVICES (U.S. CLS. 100, 101 AND 104).

SN 76-003,981. BROADWAY TELEVISION NETWORK, INC.,
NEW YORK, NY. FILED 3-20-2000.

**BROADWAY CINEMA
SCREEN**

NO CLAIM IS MADE TO THE EXCLUSIVE RIGHT TO
USE "BROADWAY", APART FROM THE MARK AS
SHOWN.

FOR TELEVISION BROADCASTING OF LIVE STAGE
SHOWS IN DIGITAL HIGH DEFINITION (U.S. CLS. 100,
101 AND 104).

SN 76-011,336. PRODIGY COMMUNICATIONS CORPORA-
TION, WHITE PLAINS, NY. FILED 3-28-2000.

SMARTPALS

FOR PROVIDING MULTIPLE-USER ACCESS TO A
GLOBAL COMPUTER INFORMATION NETWORK FEAT-
URING AN INCENTIVE AWARD PROGRAM WHERE
MEMBERS CAN EARN DISCOUNTS AND CASH FOR
REFERRING NEW MEMBERS (U.S. CLS. 100, 101 AND
104).

SN 76-025,472. CONCERT COMMUNICATIONS COMPANY,
LONDON, EC1A 7AJ, UNITED KINGDOM, FILED 4-13-
2000.



NO CLAIM IS MADE TO THE EXCLUSIVE RIGHT TO
USE "E POWERED", APART FROM THE MARK AS
SHOWN.

THE STIPPLING IS MERELY TO INDICATE SHADING.
FOR PROVIDING USER ACCESS AND TELECOMMU-
UNICATIONS CONNECTIONS TO A GLOBAL COMPU-
TER NETWORK; BROADCASTING PROGRAMS VIA A
GLOBAL COMPUTER NETWORK; WIRELESS TELE-
COMMUNICATION SERVICES, NAMELY, THE WIRE-
LESS TRANSMISSION OF VOICE AND DATA, AND
FACSIMILE TRANSMISSION (U.S. CLS. 100, 101 AND
104).

CLASS 38—(Continued).

SN 76-041,934. PEGASUS COMMUNICATIONS CORPORATION, BALA CYNWYD, PA. FILED 5-5-2000.



OWNER OF U.S. REG. NO. 2,362,857.
NO CLAIM IS MADE TO THE EXCLUSIVE RIGHT TO USE "BROADCAST TELEVISION", APART FROM THE MARK AS SHOWN.

FOR TELECOMMUNICATIONS SERVICES, NAMELY, CABLE AND SATELLITE TELEVISION, AUDIO, AND INTERNET BROADCASTING SERVICES (U.S. CLS. 100, 101 AND 104).

SN 76-086,559. CENTURYTEL, INC., MONROE, LA. FILED 7-11-2000.

DIRECT TALK

NO CLAIM IS MADE TO THE EXCLUSIVE RIGHT TO USE "DIRECT", APART FROM THE MARK AS SHOWN.

FOR WIRELESS TELEPHONE COMMUNICATION SERVICES FEATURING A RATE PLAN (U.S. CLS. 100, 101 AND 104).

FIRST USE 6-29-2000; IN COMMERCE 6-29-2000.

SN 76-120,354. KONINKLIJKE PHILIPS ELECTRONICS N.V., EINDHOVEN, NETHERLANDS, FILED 8-31-2000.

@TMOSPHERE

FOR TELECOMMUNICATION SERVICES, NAMELY, TO PROVIDE ACCESS TO THE INTERNET (U.S. CLS. 100, 101 AND 104).

CLASS 38—(Continued).

SN 76-125,990. XO COMMUNICATIONS, INC., RESTON, VA. BY CHANGE OF NAME NEXTLINK COMMUNICATIONS, INC., MCLEAN, VA. FILED 9-8-2000.

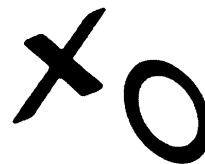

THE MARK CONSISTS OF THE LETTERS "XO" IN STYLIZED FORM.

FOR TELECOMMUNICATIONS SERVICES, NAMELY, LONG DISTANCE, AND INTERNATIONAL VOICE, TEXT, FACSIMILE, VIDEO AND DATA TELECOMMUNICATIONS SERVICES; PROVIDING FRAME RELAY CONNECTIVITY SERVICES FOR DATA TRANSFER; VIRTUAL NETWORK TELECOMMUNICATIONS SERVICES; ELECTRONIC MAIL, VOICE MAIL, AND WIRELESS DIGITAL MESSAGING SERVICES; PACKET SERVICES; COMPUTER AIDED TRANSMISSION OF MESSAGES AND IMAGES; AUDIO AND VIDEO TELECONFERENCING SERVICES; PRIVATE LINE VOICE, TEXT, FACSIMILE, VIDEO AND DATA TELECOMMUNICATIONS SERVICES; TELECOMMUNICATION SERVICES, NAMELY INTEGRATED SERVICES DIGITAL NETWORK; TELEMISSION OF VOICE, TEXT, FACSIMILE, VIDEO AND DATA VIA SATELLITE, TERRESTRIAL, AND UNDERSEA TELECOMMUNICATIONS LINKS; TELECOMMUNICATIONS SERVICES, NAMELY, COLLECT CALL SERVICES; ASYNCHRONOUS TRANSFER MODE SERVICES; VERY SMALL APERTURE SATELLITE TERMINAL SERVICE; LOCATION INDEPENDENT PERSONAL COMMUNICATIONS SERVICES COMPRISING OF MOBILE VOICE, DATA, AND FACSIMILE SERVICES; PROVIDING TELECOMMUNICATIONS CONNECTIONS TO GLOBAL COMPUTER NETWORKS; PROVIDING ON-LINE ELECTRONIC BULLETIN BOARDS FOR TRANSMISSION OF MESSAGES AMONG COMPUTER USERS CONCERNING TELECOMMUNICATIONS SERVICES, TELECOMMUNICATION SECURITY, AND INTERNET SECURITY; PROVIDING ON-LINE ELECTRONIC BULLETIN BOARDS FOR TELECOMMUNICATION SERVICES AND SECURITY; INTERNET BROADCAST SERVICES; COMPUTER AIDED TRANSMISSION OF MESSAGES AND IMAGES; COMMUNICATION BY COMPUTER TERMINAL; TELECOMMUNICATIONS SERVICES PROVIDED THROUGH DIGITAL MEANS, NAMELY, TELECOMMUNICATIONS SERVICES, NAMELY, LONG DISTANCE, AND INTERNATIONAL VOICE, TEXT, FACSIMILE, VIDEO AND DATA TELECOMMUNICATIONS SERVICES; PROVIDING FRAME RELAY CONNECTIVITY SERVICES FOR DATA TRANSFER; ELECTRONIC COLLECTION, TRANSMISSION, AND PROCESSING OF MESSAGES AND DATA; REMOTE DATA ACCESS SERVICES, NAMELY VIRTUAL PRIVATE NETWORKS, DIRECT INTERNET ACCESS, DIAL-UP INTERNET ACCESS, DIAL-UP NETWORK ACCESS, AND DIGITAL SUBSCRIBER LINES; ELECTRONIC DATA INTERCHANGE SERVICES; ELECTRONIC MAIL SERVICES TELECOMMUNICATIONS AND DATA COMMUNICATIONS SERVICES, NAMELY PROVIDING ACCESS TO TELECOMMUNICATIONS SERVERS, RELAYS, AND LINES OF OTHERS FOR THE COLLABORATIVE AND DISTRIBUTED USE OF COMPUTER SOFTWARE OVER COMMUNICATION LINES; ON-LINE INFORMATION SERVICES RELATING TO TELECOMMUNICATIONS SERVICES AND SECURITY; ELECTRONIC TRANSMISSION OF DATA, IMAGES, AND DOCUMENTS VIA COMPUTER TERMINALS; AND PROVIDING MULTIPLE USER ACCESS TO COMPUTER VIA COMPUTER TERMINALS; PROVIDING MULTIPLE USER ACCESS TO COMPUTER NETWORKS; TELECOMMUNICATIONS TRANSPONDER LEASING SERVICES; AND PROVIDING ONLINE FACILITIES FOR OTHERS FOR REAL-TIME INTERACTION WITH OTHER COMPUTER USERS, NAMELY, INSTANT MESSAGING (U.S. CLS. 100, 101 AND 104).

CLASS 38—(Continued).

SN 76-126,662. BIG LEAGUE BROADCASTING, L.L.C., ATLANTA, GA. FILED 9-12-2000.

ATLANTA'S SPORTS LEADER

NO CLAIM IS MADE TO THE EXCLUSIVE RIGHT TO USE "ATLANTA'S SPORTS", APART FROM THE MARK AS SHOWN.

FOR RADIO BROADCASTING SERVICES (U.S. CLS. 100, 101 AND 104).

FIRST USE 1-1-2000; IN COMMERCE 1-1-2000.

SN 76-126,777. XO COMMUNICATIONS, INC., RESTON, VA. BY CHANGE OF NAME NEXTLINK COMMUNICATIONS, INC., MCLEAN, VA. FILED 9-8-2000.



THE MARK CONSISTS OF THE LETTERS "XO" IN STYLIZED FORM IMMEDIATELY ABOVE THE PHRASE "NOT JUST TALK".

FOR TELECOMMUNICATIONS SERVICES, NAMELY, LONG DISTANCE, AND INTERNATIONAL VOICE, TEXT, FACSIMILE, VIDEO AND DATA TELECOMMUNICATIONS SERVICES; PROVIDING FRAME RELAY CONNECTIVITY SERVICES FOR DATA TRANSFER; VIRTUAL NETWORK TELECOMMUNICATIONS SERVICES; ELECTRONIC MAIL, VOICE MAIL, AND WIRELESS DIGITAL MESSAGING SERVICES; PACKET SERVICES; COMPUTER AIDED TRANSMISSION OF MESSAGES AND IMAGES; AUDIO AND VIDEO TELECONFERENCING SERVICES; PRIVATE LINE VOICE, TEXT, FACSIMILE, VIDEO AND DATA TELECOMMUNICATIONS SERVICES; TELECOMMUNICATION SERVICES, NAMELY INTEGRATED SERVICES DIGITAL NETWORK; TELEMISSION OF VOICE, TEXT, FACSIMILE, VIDEO AND DATA VIA SATELLITE, TERRESTRIAL, AND UNDERSEA TELECOMMUNICATIONS LINKS; TELECOMMUNICATIONS SERVICES, NAMELY, COLLECT CALL SERVICES; ASYNCHRONOUS TRANSFER MODE SERVICES; VERY SMALL APERTURE SATELLITE TERMINAL SERVICE; LOCATION INDEPENDENT PERSONAL COMMUNICATIONS SERVICES COMPRISING OF MOBILE VOICE, DATA, AND FACSIMILE SERVICES; PROVIDING TELECOMMUNICATIONS CONNECTIONS TO GLOBAL COMPUTER NETWORKS; PROVIDING ON-LINE ELECTRONIC BULLETIN BOARDS FOR TRANSMISSION OF MESSAGES AMONG COMPUTER USERS CONCERNING TELECOMMUNICATIONS SERVICES, TELECOMMUNICATION SECURITY, AND INTERNET SECURITY; PROVIDING ON-LINE ELECTRONIC BULLETIN BOARDS FOR TELECOMMUNICATION SERVICES AND SECURITY; INTERNET BROADCAST SERVICES; COMPUTER AIDED TRANSMISSION OF MESSAGES AND IMAGES; COMMUNICATION BY COMPUTER TERMINAL; TELECOMMUNICATIONS SERVICES PROVIDED THROUGH DIGITAL MEANS, NAMELY, TELECOMMUNICATIONS SERVICES, NAMELY, LONG DISTANCE, AND INTERNATIONAL VOICE, TEXT, FACSIMILE, VIDEO AND DATA TELECOMMUNICATIONS SERVICES; PROVIDING FRAME RELAY CONNECTIVITY SERVICES FOR DATA TRANSFER; ELECTRONIC COLLECTION, TRANSMISSION, AND PROCESSING OF MESSAGES AND DATA; REMOTE DATA ACCESS SERVICES, NAMELY VIRTUAL PRIVATE NETWORKS, DIRECT INTERNET ACCESS, DIAL-UP INTERNET ACCESS,

CLASS 38—(Continued).

DIAL-UP NETWORK ACCESS, AND DIGITAL SUBSCRIBER LINES; ELECTRONIC DATA INTERCHANGE SERVICES; ELECTRONIC MAIL SERVICES TELECOMMUNICATIONS AND DATA COMMUNICATIONS SERVICES, NAMELY PROVIDING ACCESS TO TELECOMMUNICATIONS SERVERS, RELAYS, AND LINES OF OTHERS FOR THE COLLABORATIVE AND DISTRIBUTED USE OF COMPUTER SOFTWARE OVER COMMUNICATION LINES; ON-LINE INFORMATION SERVICES RELATING TO TELECOMMUNICATIONS SERVICES AND SECURITY; ELECTRONIC TRANSMISSION OF DATA, IMAGES, AND DOCUMENTS VIA COMPUTER TERMINALS; AND PROVIDING MULTIPLE USER ACCESS TO COMPUTER VIA COMPUTER TERMINALS; PROVIDING MULTIPLE USER ACCESS TO COMPUTER NETWORKS; TELECOMMUNICATIONS RESPONDER LEASING SERVICES; AND PROVIDING ONLINE FACILITIES FOR OTHERS FOR REAL-TIME INTERACTION WITH OTHER COMPUTER USERS, NAMELY, INSTANT MESSAGING (U.S. CLS. 100, 101 AND 104).

SN 76-129,645. BRIDGEBAND COMMUNICATIONS, INC., BOZEMAN, MT. FILED 9-18-2000.

BRIDGEBAND

FOR PROVIDING TELECOMMUNICATIONS CONNECTIONS TO A GLOBAL COMPUTER NETWORK (U.S. CLS. 100, 101 AND 104).

FIRST USE 9-30-1999; IN COMMERCE 9-30-1999.

SN 76-140,083. FLAMENCO CORPORATION, ALPHARETTA, GA. FILED 10-3-2000.

FLAMENCO

FOR ELECTRONIC COMMERCE DISTRIBUTED VIA EXTENSIBLE MARKUP LANGUAGE (XML) NETWORKING SERVICES, NAMELY, PROVIDING MULTIPLE-USER ACCESS TO A GLOBAL COMPUTER INFORMATION NETWORK (U.S. CLS. 100, 101 AND 104).

FIRST USE 7-3-2000; IN COMMERCE 7-17-2000.

SN 76-150,123. KTVO LICENSE SUBSIDIARY, INC., MONTGOMERY, AL. FILED 10-18-2000.

KTVO

FOR TELEVISION BROADCASTING SERVICES (U.S. CLS. 100, 101 AND 104).

FIRST USE 11-21-1955; IN COMMERCE 11-21-1955.

CLASS 38—(Continued).

SN 76-164,175. PEGASUS COMMUNICATIONS CORPORATION, BALA CYNWYD, PA. FILED 11-13-2000.

A BETTER WAY TO WATCH

FOR TELECOMMUNICATION SERVICES, NAMELY, CABLE AND SATELLITE TELEVISION, AUDIO, AND INTERNET BROADCASTING SERVICES (U.S. CLS. 100, 101 AND 104).

SN 76-176,114. MIAMI HEAT LIMITED PARTNERSHIP, THE, MIAMI, FL. FILED 12-4-2000.



OWNER OF U.S. REG. NOS. 1,485,605, 2,199,708 AND OTHERS.

SEC. 2(F) AS TO "MIAMI".
FOR WEBCASTING SERVICES IN THE NATURE OF PROVIDING ON-LINE CHAT ROOMS AND ON-LINE INTERACTIVE CHAT ROOMS WITH GUESTS FOR TRANSMISSION OF MESSAGES AMONG COMPUTER USERS CONCERNING THE FIELD OF BASKETBALL; BROADCASTING PROGRAMS VIA A GLOBAL COMPUTER NETWORK (U.S. CLS. 100, 101 AND 104).

FIRST USE 10-28-1995; IN COMMERCE 10-28-1995.

SN 76-190,410. A&E TELEVISION NETWORKS, NEW YORK, NY. FILED 1-2-2001.

AETN DIGITAL

NO CLAIM IS MADE TO THE EXCLUSIVE RIGHT TO USE "DIGITAL", APART FROM THE MARK AS SHOWN.

FOR TELEVISION BROADCASTING (U.S. CLS. 100, 101 AND 104).

FIRST USE 1-2-2001; IN COMMERCE 1-2-2001.

CLASS 38—(Continued).

SN 76-191,742. KABUSHIKI KAISHA KENWOOD, TA KENWOOD CORPORATION, SHIBUYA-KU, TOKYO, JAPAN, FILED 1-9-2001.

KENWOOD

OWNER OF JAPAN REG. NO. 3036382, DATED 4-28-1995, EXPIRES 4-28-2005.

OWNER OF U.S. REG. NOS. 1,355,018, 1,658,049 AND OTHERS.

THE MARK CONSISTS OF THE WORD "KENWOOD" IN STYLIZED FORM, WITH A TRIANGULAR DESIGN ELEMENT.

FOR TRANSMISSION OF DATA, MUSIC, AND IMAGES VIA THE INTERNET (U.S. CLS. 100, 101 AND 104).

SN 76-207,775. QWEST COMMUNICATIONS INTERNATIONAL INC, DENVER, CO. FILED 2-2-2001.

MESSAGEPAK

FOR TELECOMMUNICATIONS SERVICES, NAMELY, PROVIDING MULTIPLE USER ACCESS TO A GLOBAL INFORMATION NETWORK AND PROVIDING ELECTRONIC MAIL AND DATA VIA A WIRELESS TELEPHONE (U.S. CLS. 100, 101 AND 104).

SN 76-208,845. RNK, INC., DEDHAM, MA. FILED 2-13-2001.

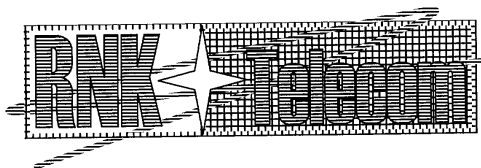

NO CLAIM IS MADE TO THE EXCLUSIVE RIGHT TO USE "TELECOM", APART FROM THE MARK AS SHOWN. THE MARK CONSISTS OF BLUE LETTERING SPELLING "RNK TELECOM", A WHITE BACKGROUND BEHIND THE LETTERS "RNK" AND A YELLOW BACKGROUND BEHIND THE WORD "TELECOM". A YELLOW RECTANGLE OUTLINES THE LOGO. A BLUE ROPE ENCIRCLES THE RECTANGLE. A WHITE STAR IS BETWEEN THE LETTERS "RNK" AND THE WORD "TELECOM".

FOR TELECOMMUNICATIONS SERVICES, NAMELY PERSONAL COMMUNICATION SERVICES (U.S. CLS. 100, 101 AND 104).

FIRST USE 1-11-1997; IN COMMERCE 1-11-1997.

CLASS 38—(Continued).

SN 76-208,846. RNK, INC., DEDHAM, MA. FILED 2-13-2001.

RNK TELECOM

NO CLAIM IS MADE TO THE EXCLUSIVE RIGHT TO USE "TELECOM", APART FROM THE MARK AS SHOWN. FOR TELECOMMUNICATIONS SERVICES, NAMELY PERSONAL COMMUNICATION SERVICES (U.S. CLS. 100, 101 AND 104).

FIRST USE 1-11-1997; IN COMMERCE 1-11-1997.

SN 76-210,127. TSUNAMI NETWORKS, INC., NEW YORK, NY. BY CHANGE OF NAME EPANA NETWORKS, NEW YORK, NY. FILED 2-15-2001.

REVOLUTION THROUGH EVOLUTION

FOR TELECOMMUNICATIONS SERVICES, NAMELY, PROVIDING ETHERNET-BASED NETWORK SERVICES (U.S. CLS. 100, 101 AND 104).

FIRST USE 1-5-2001; IN COMMERCE 1-5-2001.

SN 76-216,520. BENNETT, CHRISTOPHER R., SPRINGFIELD, PA. FILED 2-27-2001.



THE MARK "MAIL PALS PLUS DESIGN" SHOWN BELOW CONTAINS COLOR AS A FEATURE OF THE MARK. THE LETTERS "PALS" ARE DISPLAYED IN LIGHT-BLUE.

FOR PROVIDING AN ON-LINE ELECTRONIC BULLETIN BOARD FOR TRANSMISSION OF E-MAIL MESSAGES AMONG MEMBERS OF A COMPUTER USER GROUP CONCERNING TOPICS OF GENERAL INTEREST (U.S. CLS. 100, 101 AND 104).

FIRST USE 5-1-1997; IN COMMERCE 5-1-1997.

CLASS 38—(Continued).

SN 76-219,969. SOUTHERNSKIES COMMUNICATIONS GROUP, INC., VIRGINIA BEACH, VA. FILED 3-5-2001.

*Entertainment*

NO CLAIM IS MADE TO THE EXCLUSIVE RIGHT TO USE "ENTERTAINMENT", APART FROM THE MARK AS SHOWN.

FOR SUBSCRIPTION TELEVISION BROADCASTING SERVICES; TRANSMISSION OF CABLE AND NETWORK TELEVISION AND INTERACTIVE AUDIO AND VIDEO SERVICES; AND TRANSMISSION OF PERSONALIZED AND INTERACTIVE TELEVISION PROGRAMMING (U.S. CLS. 100, 101 AND 104).

SN 76-220,997. CHIPDATA, INC., RICHARDSON, TX. FILED 3-5-2001.



FOR ELECTRONIC TRANSMISSION OF DATA VIA A GLOBAL COMPUTER NETWORK (U.S. CLS. 100, 101 AND 104).

FIRST USE 6-5-2000; IN COMMERCE 6-5-2000.

SN 76-223,568. NEXTEL COMMUNICATIONS, INC., RESTON, VA. FILED 3-13-2001.

NEXTEL MOBILE EXTENSION

NO CLAIM IS MADE TO THE EXCLUSIVE RIGHT TO USE "MOBILE EXTENSION", APART FROM THE MARK AS SHOWN.

FOR TELECOMMUNICATIONS SERVICES, NAMELY, INTEGRATING THE ATTRIBUTES OF A WIRED TELEPHONE WITH A WIRELESS PHONE, SO THAT THE WIRELESS PHONE WILL BE ABLE TO UTILIZE THE SAME FEATURES AVAILABLE WITH A WIRED TELEPHONE, NAMELY, DIALTONE, ABBREVIATED DIALING, ACCESS TO CORPORATE LONG DISTANCE PLANS, ACCESS TO CORPORATE LONG DISTANCE PLANS, ACCESS TO CORPORATE VOICE MAIL AND SIMULTANEOUS OR SEQUENTIAL RINGING OF THE WIRED TELEPHONE AND THE WIRELESS PHONE (U.S. CLS. 100, 101 AND 104).

CLASS 38—(Continued).

SN 76-237,531. ASIANATELECOM, LOS ANGELES, CA. FILED 4-9-2001.



Asiana Telecom

NO CLAIM IS MADE TO THE EXCLUSIVE RIGHT TO USE "TELECOM", APART FROM THE MARK AS SHOWN. FOR LONG DISTANCE TELEPHONE COMMUNICATION SERVICES (U.S. CLS. 100, 101 AND 104). FIRST USE 8-15-1999; IN COMMERCE 8-15-1999.

SN 76-250,027. NORTHWEST OPEN ACCESS NETWORK, EAST WENATCHEE, WA. FILED 5-2-2001.



NoaNet

THE MARK CONSISTS OF THE TERMS "NOANET" AND A DESIGN OF A STAR CONTAINING EIGHT POINTS. FOR PROVIDING ACCESS AND USE OF ITS BROADBAND, FIBER OPTIC CABLE SYSTEM FOR LOCAL AND LONG DISTANCE TELEPHONE COMMUNICATIONS, A GLOBAL COMPUTER NETWORK AND CABLE TELEVISION (U.S. CLS. 100, 101 AND 104). FIRST USE 2-9-2000; IN COMMERCE 2-9-2000.

SN 76-251,082. MULTISALES, INC., CLEVELAND, GA. FILED 5-3-2001.

AIRTAG

FOR PROVIDING INFORMATION ABOUT WIRELESS SERVICE PROVIDERS AND WIRELESS TELECOMMUNICATIONS SERVICES, NAMELY, LOCAL AND LONG DISTANCE TRANSMISSION OF VOICE, DATA AND GRAPHICS, BY MEANS OF WIRELESS TRANSMISSIONS; WIRELESS DIGITAL MESSAGING SERVICES; WIRELESS FACSIMILE SERVICES; AND WIRELESS PBX SERVICES; BY MEANS OF THE INTERNET (U.S. CLS. 100, 101 AND 104).

CLASS 38—(Continued).

SN 76-265,195. SUSQUEHANNA CABLE INVESTMENT CO., YORK, PA. FILED 6-4-2001.

SUSCOM DIGITAL CABLE

NO CLAIM IS MADE TO THE EXCLUSIVE RIGHT TO USE "DIGITAL CABLE", APART FROM THE MARK AS SHOWN.

FOR CABLE TELEVISION TRANSMISSION SERVICES; CABLE RADIO TRANSMISSION SERVICES; TELECOMMUNICATIONS, NAMELY VIDEO AND DATA TRANSMISSIONS AND INTERACTIVE VIDEO SERVICES PROVIDED THROUGH THE USE OF CABLE TELEVISION DISTRIBUTION FACILITIES, HYBRID FIBER COAXIAL CABLE NETWORKS AND DIGITAL TERMINALS (U.S. CLS. 100, 101 AND 104). FIRST USE 10-22-1999; IN COMMERCE 10-22-1999.

SN 76-288,667. NTCH, INC., DBA CLEAR TALK, EL SEGUNDO, CA. FILED 7-24-2001.

WIRELESS MADE SIMPLE

NO CLAIM IS MADE TO THE EXCLUSIVE RIGHT TO USE "WIRELESS", APART FROM THE MARK AS SHOWN. FOR TELECOMMUNICATION SERVICES; NAMELY, WIRELESS LOCAL AND LONG DISTANCE VOICE AND MESSAGING SERVICES (U.S. CLS. 100, 101 AND 104). FIRST USE 9-0-1999; IN COMMERCE 12-0-1999.

SN 76-306,760. VOICESTREAM WIRELESS CORPORATION, BELLEVUE, WA. FILED 8-29-2001.

GET MORE FROM LIFE

OWNER OF U.S. REG. NOS. 2,473,677 AND 2,473,682. FOR PROVIDING MULTIPLE-USER ACCESS TO A GLOBAL COMPUTER NETWORK; TWO WAY WIRELESS TRANSMISSION OF E-MAIL AND TEXT BETWEEN WIRELESS TELECOMMUNICATIONS TERMINALS AND COMPUTERS (U.S. CLS. 100, 101 AND 104). FIRST USE 12-12-2000; IN COMMERCE 12-12-2000.

CLASS 38—(Continued).

SN 76-307,784. FLAMENCO CORPORATION, DBA FLAMENCO NETWORKS, ALPHARETTA, GA. FILED 8-31-2001.



FOR ELECTRONIC COMMERCE DISTRIBUTED VIA EXTENSIBLE MARKUP LANGUAGE (XML) NETWORKING SERVICES, NAMELY, PROVIDING MULTIPLE USER ACCESS TO A GLOBAL COMPUTER NETWORK (U.S. CLS. 100, 101 AND 104).

SN 76-308,411. UNITED STATES CELLULAR CORPORATION, CHICAGO, IL. FILED 9-4-2001.

excellence
GUARANTEE

NO CLAIM IS MADE TO THE EXCLUSIVE RIGHT TO USE "GUARANTEE", APART FROM THE MARK AS SHOWN.

FOR TELECOMMUNICATIONS SERVICES, NAMELY, WIRELESS TELEPHONE, WIRELESS VOICE MAIL, WIRELESS DIGITAL MESSAGING AND WIRELESS FACSIMILE MAIL SERVICES FEATURING A PROGRAM OF BENEFITS PROVIDED TO CUSTOMERS (U.S. CLS. 100, 101 AND 104).

FIRST USE 9-4-2001; IN COMMERCE 9-4-2001.

SN 76-308,412. UNITED STATES CELLULAR CORPORATION, CHICAGO, IL. FILED 9-4-2001.

EXCELLENCE GUARANTEE

NO CLAIM IS MADE TO THE EXCLUSIVE RIGHT TO USE "GUARANTEE", APART FROM THE MARK AS SHOWN.

FOR TELECOMMUNICATIONS SERVICES, NAMELY, WIRELESS TELEPHONE, WIRELESS VOICE MAIL, WIRELESS DIGITAL MESSAGING AND WIRELESS FACSIMILE MAIL SERVICES ALL FEATURING A PROGRAM OF BENEFITS PROVIDED TO CUSTOMERS (U.S. CLS. 100, 101 AND 104).

FIRST USE 9-4-2001; IN COMMERCE 9-4-2001.

CLASS 38—(Continued).

SN 76-315,812. M&G ENTERPRISES, LLC, DBA HEYYOITSME.COM, GREAT NECK, NY. FILED 9-24-2001.

HEYWIRE

FOR PROVIDING ON-LINE MESSAGE BOARDS FOR TRANSMISSION OF MESSAGES AMONG COMPUTER AND WIRELESS USERS CONCERNING PERSONAL INTRODUCTION, LOCAL EVENTS, PARTIES, AND EVENT AND PARTY VENUES (U.S. CLS. 100, 101 AND 104).

SN 76-321,128. COMMUNITY TELEVISION OF SOUTHERN CALIFORNIA, LOS ANGELES, CA. FILED 10-3-2001.

KCET INFINITELY MORE

FOR COMMUNICATION SERVICES, NAMELY RADIO, TELEVISION, AND ENHANCED TELEVISION TRANSMISSION SERVICES AND BROADCASTING; CHAT ROOM DISCUSSION GROUP SERVICES, NAMELY PROVIDING A REAL-TIME INTERACTIVE ELECTRONIC ENVIRONMENT FOR SOCIAL INTERACTION BETWEEN COMPUTER USERS CONCERNING A WIDE RANGE OF TOPICS OF GENERAL INTEREST (U.S. CLS. 100, 101 AND 104).

FIRST USE 9-21-1999; IN COMMERCE 9-21-1999.

SN 76-333,892. UNIVISION COMMUNICATIONS INC., LOS ANGELES, CA. FILED 11-5-2001.

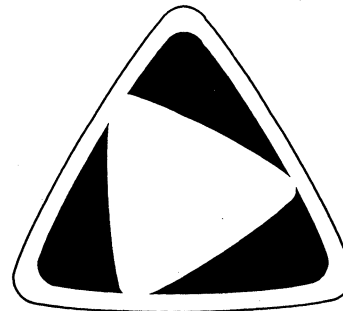

FOR TELEVISION TRANSMISSION AND BROADCASTING (U.S. CLS. 100, 101 AND 104).

SN 76-338,118. QWEST COMMUNICATIONS INTERNATIONAL INC., DENVER, CO. FILED 11-13-2001.

SELECTPAK

FOR TELECOMMUNICATIONS SERVICES, NAMELY, PROVISION OF A TELEPHONE LINE ALONG WITH CUSTOM CALLING FEATURES (U.S. CLS. 100, 101 AND 104).

FIRST USE 10-29-2001; IN COMMERCE 10-29-2001.

CLASS 38—(Continued).

SN 76-344,345. ANDESAT S.A. E.M.A. CORP., MIAMI, FL. FILED 12-3-2001.

ANDESAT

FOR SATELLITE COMMUNICATION SERVICES (U.S. CLS. 100, 101 AND 104).
FIRST USE 4-0-1999; IN COMMERCE 4-0-1999.

SN 76-347,938. CELLCO PARTNERSHIP, DBA VERIZON WIRELESS, BEDMINSTER, NJ. FILED 12-11-2001.

FREEUP

FOR WIRELESS TELECOMMUNICATIONS SERVICES, NAMELY, WIRELESS TELEPHONE SERVICES (U.S. CLS. 100, 101 AND 104).
FIRST USE 8-1-2001; IN COMMERCE 8-1-2001.

SN 78-008,743. CONNECT 24 INC., DOWNSVIEW, ONTARIO, FILED 5-18-2000.

SKY FLEX

FOR COMMUNICATION SERVICES, NAMELY RECEIVING WIRELESS DATA SIGNALS FROM REMOTE LOCATIONS AND RE-TRANSMITTING SUCH DATA SIGNALS TO CENTRAL MONITORING STATIONS (U.S. CLS. 100, 101 AND 104).
FIRST USE 4-27-2000; IN COMMERCE 4-27-2000.

SN 78-039,330. LINKTONE LTD, NEW YORK, NY. BY CHANGE OF NAME INTRINSIC TECHNOLOGY LTD., NEW YORK, NY. FILED 12-14-2000.

INTRINSIC TECHNOLOGY

NO CLAIM IS MADE TO THE EXCLUSIVE RIGHT TO USE "TECHNOLOGY", APART FROM THE MARK AS SHOWN.

FOR WIRELESS COMMUNICATION SERVICES, NAMELY PROVIDING WIRELESS DATA TRANSMISSION SERVICES FEATURING ADVANCED MESSAGING SERVICES PERMITTING THE TRANSMISSION OF ENTERTAINMENT INFORMATION, MOBILE ELECTRONIC COMMERCE AND OTHER INFORMATION (U.S. CLS. 100, 101 AND 104).

CLASS 38—(Continued).

SN 78-039,722. INTRINSIC TECHNOLOGY LTD., NEW YORK, NY. FILED 12-18-2000.



FOR WIRELESS COMMUNICATION SERVICES, NAMELY DIGITAL MESSAGING SERVICES, MOBILE TELEPHONE COMMUNICATION SERVICES, PAGING SERVICES AND SATELLITE TRANSMISSION SERVICES (U.S. CLS. 100, 101 AND 104).

SN 78-039,726. INTRINSIC TECHNOLOGY LTD., NEW YORK, NY. FILED 12-18-2000.



FOR WIRELESS COMMUNICATION SERVICES, NAMELY DIGITAL MESSAGING SERVICES, MOBILE TELEPHONE COMMUNICATION SERVICES, PAGING SERVICES AND SATELLITE TRANSMISSION SERVICES (U.S. CLS. 100, 101 AND 104).

SN 78-043,510. BRIGHTMAIL, INC., SAN FRANCISCO, CA. FILED 1-17-2001.

EMAIL YOU CAN TRUST

NO CLAIM IS MADE TO THE EXCLUSIVE RIGHT TO USE "EMAIL", APART FROM THE MARK AS SHOWN.

FOR ELECTRONIC MAIL SERVICES OFFERED VIA A GLOBAL COMPUTER INFORMATION NETWORK, NAMELY, SERVICES AIMED AT REDUCING JUNK E-MAIL, RECOGNIZING, DETECTING AND ANALYZING UNSOLICITED BULK E-MAIL AND CREATING COUNTERMEASURES TO REDUCE, COMBAT AND PREVENT UNWANTED E-MAIL; COMPUTER SERVICES AIMED AT IMPROVING AND PRESERVING THE UTILITY OF ELECTRONIC MAIL (U.S. CLS. 100, 101 AND 104).
FIRST USE 9-1-1998; IN COMMERCE 9-1-1998.

SN 78-049,442. FAIRCARD CORPORATION, DELRAY BEACH, FL. FILED 2-21-2001.

FAIRCARD

OWNER OF U.S. REG. NO. 1,920,874.
FOR TELECOMMUNICATIONS RESELLER SERVICES, NAMELY, PROVIDING LOCAL AND LONG DISTANCE TELECOMMUNICATIONS SERVICES, OFFERED VIA A GLOBAL COMPUTER NETWORK (U.S. CLS. 100, 101 AND 104).

FIRST USE 2-23-2001; IN COMMERCE 2-23-2001.

CLASS 38—(Continued).

SN 78-092,483. INTRADO INC, BOULDER, CO. FILED 11-8-2001.

INTELLILINK

FOR TELECOMMUNICATIONS SERVICES, NAMELY A NATIONWIDE COMPREHENSIVE SERVICE FOR WIRELESS, LONG DISTANCE AND LOCAL TELEPHONE COMMUNICATIONS PROVIDERS TO INTERCONNECT DISPARATE SYSTEMS TO PROVIDE WIRELESS SUBSCRIBERS AUTOMATED CALL ROUTING FOR ACCESS TO 9-1-1 SAFETY ANSWERING POINTS; TELECOMMUNICATIONS SERVICES, NAMELY A NATIONWIDE COMPREHENSIVE SERVICE FOR WIRELESS, LONG DISTANCE AND LOCAL TELEPHONE COMPANIES, SATELLITE COMMUNICATIONS, ALTERNATIVE AND LOCAL EXCHANGE CARRIERS, AND OTHER TELECOMMUNICATIONS PROVIDERS TO INTERCONNECT DISPARATE SYSTEMS AND TRADITIONAL TELECOMMUNICATIONS PROVIDERS TO PROVIDE AUTOMATED CALL ROUTING; TELECOMMUNICATIONS SERVICES, NAMELY IDENTIFICATION OF THE GEOGRAPHIC LOCATION OF TELECOMMUNICATIONS DEVICES TO PROVIDE LOCATION INFORMATION TO COMMERCIAL SERVICE PROVIDERS AND TO EMERGENCY RESPONSE PERSONNEL (U.S. CLS. 100, 101 AND 104).

SN 78-093,951. BACHMANN, CHRISTOPHER, EVANSTON, IL. FILED 11-17-2001.

MAGNACHAT

FOR PROVIDING ON-LINE CHAT ROOMS FOR TRANSMISSION OF MESSAGES AMONG COMPUTER USERS CONCERNING A VARIETY OF SUBJECTS OF HUMAN INTEREST (U.S. CLS. 100, 101 AND 104).
FIRST USE 11-17-2000; IN COMMERCE 11-17-2000.

SN 78-096,479. BFS BRANDS, LLC, NASHVILLE, TN. FILED 12-4-2001.

BFS

FOR RETAIL TIRE STORE SERVICES (U.S. CLS. 100, 101 AND 104).

CLASS 39—TRANSPORTATION AND STORAGE

SN 75-406,816. AIRPORT SATELLITE PARKING LLC, NEWARK, NJ. FILED 12-16-1997.

AVISTAR

FOR PARKING LOT SERVICES AND GROUND TRANSPORTATION OF PASSENGERS TO AND FROM AN AIRPORT AND A PARKING LOT (U.S. CLS. 100 AND 105).

CLASS 39—(Continued).

SN 75-532,701. CNF TRANSPORTATION INC., PALO ALTO, CA. FILED 8-7-1998.



THE LINING SHOWN IN THE DRAWING IS A FEATURE OF THE MARK AND IS NOT INTENDED TO INDICATE COLOR.

FOR TRANSPORTATION OF THE GOODS OF OTHERS BY TRUCK, RAIL, SHIP AND AIR (U.S. CLS. 100 AND 105).

FIRST USE 1-0-1991; IN COMMERCE 1-0-1991.

SN 75-713,458. RMC GROUP PLC, SURREY, UNITED KINGDOM, FILED 5-25-1999.

RMC CAROLINA MATERIALS

OWNER OF U.S. REG. NO. 1,804,492.
NO CLAIM IS MADE TO THE EXCLUSIVE RIGHT TO USE "RMC" AND "MATERIALS", APART FROM THE MARK AS SHOWN.

FOR TRANSPORTATION AND DELIVERY OF CONCRETE, CONCRETE BUILDING MATERIALS, NAMELY, CONCRETE BLOCKS, BRICKS AND SLABS, AND RELATED MASONRY MATERIALS (U.S. CLS. 100 AND 105).

SN 75-801,293. SGC SWISSGLOBALCARGO AG, CH-4002 BASEL, SWITZERLAND, FILED 9-15-1999.

SwissGlobalCargo

a Panalpina SAirLogistics Company

PRIORITY CLAIMED UNDER SEC. 44(D) ON SWITZERLAND APPLICATION NO. 03822/1999, FILED 4-30-1999, REG. NO. 466188, DATED 11-24-1999, EXPIRES 4-30-2009.

NO CLAIM IS MADE TO THE EXCLUSIVE RIGHT TO USE "SWISS GLOBAL CARGO" AND "COMPANY", APART FROM THE MARK AS SHOWN.

FOR FREIGHT FORWARDING; TRANSPORTATION OF GOODS VIA AIR, TRUCK, BOAT AND TRAIN; PACKAGING OF ARTICLES FOR TRANSPORTATION; WAREHOUSE STORAGE OF GOODS; DELIVERY OF GOODS VIA AIR, TRUCK, BOAT AND TRAIN; PROVIDING INFORMATION IN THE FIELD OF TRANSPORTATION AND FORWARDING OF GOODS (U.S. CLS. 100 AND 105).

CLASS 39—(Continued).

SN 75-902,688. CALIFORNIA STATE AUTOMOBILE ASSOCIATION, SAN FRANCISCO, CA. FILED 1-24-2000.

CAR CARE PLUS

NO CLAIM IS MADE TO THE EXCLUSIVE RIGHT TO USE "CAR CARE", APART FROM THE MARK AS SHOWN. FOR AUTOMOBILE REPAIR AND MAINTENANCE SERVICES (U.S. CLS. 100 AND 105).

FIRST USE 3-0-1999; IN COMMERCE 3-0-1999.

SN 76-006,077. IBERAIL, S.A., MADRID, SPAIN, FILED 3-21-2000.



IBERAVE

THE DRAWING IS LINED FOR THE COLORS BLUE, GREEN, ORANGE, YELLOW AND RED.

FOR TRANSPORT RESERVATIONS; TRAVEL INFORMATION SERVICES; TRANSPORT OF PASSENGERS BY TRAIN, CRUISE AND AIR; ARRANGING TRAVEL TOURS AND CRUISES; TRAVEL BOOKING AGENCIES (U.S. CLS. 100 AND 105).

FIRST USE 1-1-1996; IN COMMERCE 1-1-1996.

CLASS 39—(Continued).

SN 76-034,164. TRANS-GLOBAL SOLUTIONS, INC., HOUSTON, TX. FILED 4-25-2000.



NO CLAIM IS MADE TO THE EXCLUSIVE RIGHT TO USE "INC.", APART FROM THE MARK AS SHOWN.

THE MARK CONSISTS, IN PART, OF A STYLIZED DEPICTION OF A GLOBE WITH AN ARROW POINTING DOWNWARD ON THE LEFT OF THE GLOBE AND AN ARROW POINTING UPWARD ON THE RIGHT OF THE GLOBE.

FOR LEASING OF LOCOMOTIVES; RAILCAR STORAGE; OPERATION OF BULK TERMINALS; OPERATION OF RIVER TERMINALS, PORT OPERATIONS; OPERATING BULK TERMINAL FACILITIES, OPERATION OF RAIL YARDS, ENGINEERING AND CONVEYING SYSTEMS COMPOSED OF RAIL CARS, RAILROADS, RAIL YARDS, CONVEYORS, CRANES, STORAGE YARDS, RAIL CAR REPAIR FACILITIES, BULK MATERIAL HANDLING EQUIPMENT, FLOATING BULK TERMINALS, BULK TERMINALS, SHIP LOADERS, PORTABLE STACKERS, PORTABLE SCREENING PLANTS, DRAGGABLE CONVEYORS, OVERLAND CONVEYORS, FEEDERS, RECLAIMERS, HORIZONTAL CURVE CONVEYORS, RAIL-TO-SHIP BULK TRANSFER SYSTEMS, DOCKS, DUST SUPPRESSION EQUIPMENT, SOUND SUPPRESSION EQUIPMENT, ELEVATING TRUCK DUMPS, OCEAN-GOING BULK CARRIERS, TURN-KEY RAIL PACKAGES COMPOSED OF RAIL CARS, RAILROADS, RAIL YARDS, RAIL CAR REPAIR FACILITIES, RAIL-TO-SHIP BULK TRANSFER SYSTEMS (U.S. CLS. 100 AND 105).

FIRST USE 11-0-1998; IN COMMERCE 11-0-1998.

SN 76-101,775. CULTURAL HERITAGE ALLIANCE, INC., PHILADELPHIA, PA. FILED 8-2-2000.



C·H·A
educational tours

NO CLAIM IS MADE TO THE EXCLUSIVE RIGHT TO USE "EDUCATIONAL TOURS", APART FROM THE MARK AS SHOWN.

FOR ARRANGING AND CONDUCTING EDUCATIONAL TRAVEL AND SIGHTSEEING TOURS FOR HIGHSCHOOL AND COLLEGE STUDENTS AND FOR ADULTS GROUPS (U.S. CLS. 100 AND 105).

FIRST USE 9-0-1985; IN COMMERCE 9-0-1985.

CLASS 39—(Continued).

SN 76-126,565. AEROVIAS DE MEXICO, S.A. DE C.V., 06500 MEXICO, D.F., MEXICO, FILED 9-12-2000.

AEROMEXICO.COM

OWNER OF U.S. REG. NO. 1,712,266 AND OTHERS.
FOR AIR TRANSPORTATION SERVICES, NAMELY, TRANSPORTING OF PASSENGERS AND FREIGHT BY AIR, LAND AND SEA; TRAVEL INFORMATION SERVICES VIA THE INTERNET; AIR TRANSPORTATION SERVICES, NAMELY PROVIDING A PROGRAM OF BONUS FLIGHTS FOR PURCHASERS OF SPECIFIED TRAVEL AND ENTERTAINMENT SERVICES VIA THE INTERNET (U.S. CLS. 100 AND 105).
FIRST USE 1-1-1997; IN COMMERCE 1-1-1997.

SN 76-131,292. SENIORS CAB, INC., HOUSTON, TX. FILED 9-20-2000.

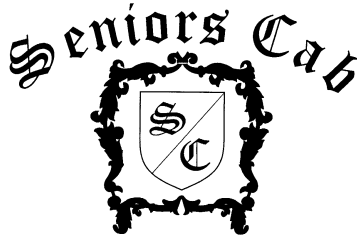

NO CLAIM IS MADE TO THE EXCLUSIVE RIGHT TO USE "SENIORS CAB", APART FROM THE MARK AS SHOWN.
FOR TRANSPORTATION OF SENIOR PASSENGERS BY AUTOMOBILE (U.S. CLS. 100 AND 105).

SN 76-144,869. ACCESS TRANSPORTATION SERVICES, INC., LAKE MARY, FL. FILED 10-11-2000.

THE MARK CONSISTS OF THE WORD MARK "ACCESS ON TIME" IN A STYLIZED FORMAT WITH THE "O" DIRECTED TO THE WORD "ON" DEPICTING THE FACE OF THE CLOCK.

FOR TRANSPORTATION SERVICES PROVIDED TO WORKMEN'S COMPENSATION CASE MANAGERS, NAMELY, TRANSPORT OF PASSENGERS AND/OR GOODS BY CAR, VAN, BUS, AMBULANCE, LIMOUSINE, AIR AND/OR BOAT (U.S. CLS. 100 AND 105).
FIRST USE 0-0-1998; IN COMMERCE 0-0-1998.

CLASS 39—(Continued).

SN 76-198,988. PETER HUGHES DIVING, INC., MIAMI LAKES, FL. FILED 1-25-2001.

DIVE EASY TRAVEL

NO CLAIM IS MADE TO THE EXCLUSIVE RIGHT TO USE "TRAVEL", APART FROM THE MARK AS SHOWN.
FOR TRAVEL BOOKING AGENCY SERVICES (U.S. CLS. 100 AND 105).
FIRST USE 8-1-1998; IN COMMERCE 8-1-1998.

SN 76-216,396. 3034998 NOVA SCOTIA COMPANY, CHURCHILL, MANITOBA R0B 0E0, CANADA, FILED 2-26-2001.



FOR ARRANGING AND OPERATING TRAVEL TOURS (U.S. CLS. 100 AND 105).

SN 76-218,781. NEW JAS INTERNATIONAL INC., TORRANCE, CA. FILED 3-5-2001.

i-LOGISTICS (USA)

NO CLAIM IS MADE TO THE EXCLUSIVE RIGHT TO USE "USA", APART FROM THE MARK AS SHOWN.
FOR TRANSPORTATION SERVICES, NAMELY, PROVIDING MARITIME FREIGHT FORWARDING SERVICES (U.S. CLS. 100 AND 105).

SN 76-220,600. AFTERTHOUGHT, INC., THE, HOPLAND, CA. FILED 3-5-2001.

EPARQ

FOR VEHICLE PARKING SERVICES, NAMELY, VEHICLE PARKING, PARKING RESERVATIONS AND PARKING VALIDATION (U.S. CLS. 100 AND 105).

CLASS 39—(Continued).

SN 76-231,276. MANAGEDSTORAGE INTERNATIONAL, INC., WESTMINSTER, CO. FILED 3-28-2001.

GRIDLINK

FOR ELECTRONIC STORAGE OF DATA FOR OTHERS (U.S. CLS. 100 AND 105).

SN 76-231,670. MANAGEDSTORAGE INTERNATIONAL, INC., WESTMINSTER, CO. FILED 3-28-2001.

GRIDMON

FOR ELECTRONIC STORAGE OF DATA FOR OTHERS (U.S. CLS. 100 AND 105).

SN 76-234,064. EURO-LOG TELEKOMMUNIKATIONS-MEHRWERTDIENSTE GMBH, 85399 HALLBERGMOOS, FED REP GERMANY, FILED 3-30-2001.

TRANSPO-HUB

PRIORITY CLAIMED UNDER SEC. 44(D) ON FED REP GERMANY APPLICATION NO. 30102512.639, FILED 1-16-2001, REG. NO. 30102512, DATED 2-6-2001, EXPIRES 2-6-2011.

FOR TRANSPORT OF GOODS OF ALL KINDS BY ROAD, RAIL, SEA AND AIR; RESERVATION AND BOOKING OF TRANSPORT BY LAND, AIR AND SEA FOR THIRD PARTIES; MONITORING AND CONTROL OF GOODS IN TRANSPORT, IN PARTICULAR ROAD TRANSPORT (U.S. CLS. 100 AND 105).

SN 76-239,728. POINT 2 POINT LOGISTICS, INC., HOUSTON, TX. FILED 4-12-2001.



THE MARK CONSISTS OF THE STYLIZED LETTERS "P2P". THE BORDER AND LEFT HALF OF EACH LETTER ALONG WITH THE BORDER AND LEFT HALF OF THE NUMBER 2 ARE IN BLACK. ACROSS THE MIDDLE OF THE MARK IS A SERIES OF SEMICIRCLES IN THE COLOR RED. COLOR IS CLAIMED AS A FEATURE OF THE MARK.

FOR TRANSPORTATION SERVICES FOR OTHERS, NAMELY, STORING AND PACKAGING PORTABLE GOODS, SUCH AS TOYS, VIDEO GAMES, ELECTRONIC GAMES, CONSUMER ELECTRONIC, PRINTED MATTER, AND TOOLS; AND TRANSPORTING, AND DELIVERING THOSE GOODS BY AIR FREIGHT, RAIL, TRUCK, AUTOMOTIVE VEHICLE, SHIP OR VESSEL (U.S. CLS. 100 AND 105).

FIRST USE 9-1-2000; IN COMMERCE 9-1-2000.

CLASS 39—(Continued).

SN 76-251,265. WHEATON VAN LINES, INC., INDIANAPOLIS, IN. FILED 5-3-2001.

WE MOVE YOUR LIFE

FOR STORAGE AND TRANSPORT OF ALL HOUSEHOLD GOODS OTHER THAN HAZARDOUS MATERIALS, BULK PRODUCTS, OR PERISHABLE CARGO BY TRUCK, BOAT OR PLANE (U.S. CLS. 100 AND 105).
FIRST USE 3-0-1997; IN COMMERCE 3-0-1997.

SN 76-254,374. V3 SOFTWARE DEVELOPMENT CORPORATION, ORLANDO, FL. FILED 5-9-2001.

E-CON

FOR SERVICES, NAMELY, OF ELECTRONIC STORAGE OF DATA (U.S. CLS. 100 AND 105).

SN 76-264,510. GOLDENWARE TRAVEL TECHNOLOGIES, LLC, NASHUA, NH. FILED 5-31-2001.

POCKETFLY

FOR TRAVEL INFORMATION SERVICES NAMELY PROVIDING AIRLINE FLIGHT INFORMATION TO HAND HELD PERSONAL DIGITAL DEVICES AND WIRELESS PHONES VIA THE GLOBAL COMPUTER NETWORK AND OTHER WIRELESS COMMUNICATION (U.S. CLS. 100 AND 105).

FIRST USE 9-1-2000; IN COMMERCE 9-1-2000.

SN 76-274,769. EURO-LOG TELEKOMMUNIKATIONS-MEHRWERTDIENSTE GMBH, 85399 HALLBERGMOOS, FED REP GERMANY, FILED 6-20-2001.

TRANSPO-TRUCK

PRIORITY CLAIMED UNDER SEC. 44(D) ON FED REP GERMANY APPLICATION NO. 30107101.2/0, FILED 2-2-2001, REG. NO. 30107101, DATED 5-30-2001, EXPIRES 2-28-2011.

FOR TRANSPORT OF GOODS OF ALL KINDS BY ROAD, RAIL, SEA AND AIR; RESERVATION AND BOOKING OF TRANSPORT BY LAND, AIR AND SEA FOR THIRD PARTIES; MONITORING AND CONTROL OF GOODS IN TRANSPORT, IN PARTICULAR ROAD TRANSPORT (U.S. CLS. 100 AND 105).

CLASS 39—(Continued).

SN 76-285,414. DURHAM, RANDAL, EAST BERNSTADT, KY. FILED 7-16-2001.



NO CLAIM IS MADE TO THE EXCLUSIVE RIGHT TO USE "EXPRESS", APART FROM THE MARK AS SHOWN.

COLOR IS A FEATURE OF THE MARK: THE HAT IS BLACK, WITH A BLUE HAT BAND WITH GOLD DOTS; THE BANDANNA IS BLUE WITH GOLD DOTS; THE WORD "SHILOH" IS WHITE; THE WORD "EXPRESS" IS GOLD; THE BACKGROUND AND THE SHERIFF'S STAR ARE RED.

FOR FOOD DELIVERY (U.S. CLS. 100 AND 105).

SN 76-289,467. NAVAJO SHIPPERS, INC., COMMERCE CITY, CO. FILED 7-25-2001.



THE NAME, PORTRAIT, AND/OR SIGNATURE SHOWN IN THE MARK IDENTIFIES REBECCA MICHELLE DIGBY, WHOSE CONSENT TO REGISTER HAS BEEN SUBMITTED.

FOR INTERSTATE AND INTERNATIONAL TRUCKLOAD AND LESS-THAN-TRUCKLOAD TRANSPORTATION OF GOODS BY MOTOR CARRIER; ARRANGING AND BROKERING THE INTERSTATE AND INTERNATIONAL TRANSPORTATION OF GOODS; LEASING TRACTORS AND TRAILERS (U.S. CLS. 100 AND 105).

FIRST USE 3-1-1989; IN COMMERCE 3-1-1989.

CLASS 39—(Continued).

SN 76-293,271. W4HF, L.L.C., ORANGE, CA. FILED 8-2-2001.

W4

"W4" REPRESENTS THE INITIALS OF APPLICANT'S OWNER, "WILLIAM IV".

FOR ARRANGING GUIDED HUNTING AND FISHING EXCURSIONS (U.S. CLS. 100 AND 105).

SN 76-309,749. DOMAZ PROJECT, THE, SEATTLE, WA. FILED 9-6-2001.

MUSESHIP

FOR CRUISE SHIP SERVICES (U.S. CLS. 100 AND 105).

SN 76-309,886. EL PASO CORPORATION, HOUSTON, TX. FILED 9-6-2001.



NO CLAIM IS MADE TO THE EXCLUSIVE RIGHT TO USE "TRANSMISSION SYSTEM", APART FROM THE MARK AS SHOWN.

FOR NATURAL GAS DISTRIBUTION FOR OTHERS, NAMELY, PIPELINE TRANSMISSION AND STORAGE OF NATURAL GAS FOR OTHERS (U.S. CLS. 100 AND 105).

SN 76-319,144. BOOKRITE LIMITED, PARNELL, AUCKLAND, NEW ZEALAND, FILED 9-28-2001.

BOOKRITE

FOR TRAVEL AND TOURIST SERVICES, NAMELY, TRAVEL AND TRANSPORTATION RESERVATION AND BOOKING SERVICES; TRAVEL INFORMATION SERVICES; INTERNET BASED TRAVEL AND TRANSPORTATION RESERVATION AND BOOKING SERVICES, AND INTERNET BASED TRAVEL INFORMATION SERVICES (U.S. CLS. 100 AND 105).

FIRST USE 11-24-2000; IN COMMERCE 11-24-2000.

SN 76-326,444. PACIFIC DELIGHT TOURS, INC., NEW YORK, NY. FILED 10-15-2001.

PDT PLATINUM PROGRAMS

NO CLAIM IS MADE TO THE EXCLUSIVE RIGHT TO USE "PROGRAMS", APART FROM THE MARK AS SHOWN.

FOR ARRANGING AND CONDUCTING TRAVEL TOURS (U.S. CLS. 100 AND 105).

CLASS 39—(Continued).

SN 76-327,504. PARKHOMCHUK, DMITRI, MOSCOW
125167, RUSSIAN FEDERATIO, FILED 10-22-2001.

VODOLEY

FOR CRUISE SHIP SERVICES (U.S. CLS. 100 AND 105).
FIRST USE 3-12-1993; IN COMMERCE 3-12-1993.

SN 76-334,082. ADAM'S STORAGE LP, BEAUMONT, TX.
FILED 11-6-2001.

ADAM'S SELF STORAGE

NO CLAIM IS MADE TO THE EXCLUSIVE RIGHT TO
USE "SELF STORAGE", APART FROM THE MARK AS
SHOWN.

FOR OPERATING CLIMATE CONTROLLED SELF-
STORAGE FACILITIES (U.S. CLS. 100 AND 105).

SN 76-334,607. WYCLIFFE BIBLE TRANSLATORS, INC.,
ORLANDO, FL. FILED 11-5-2001.

GET GLOBAL

NO CLAIM IS MADE TO THE EXCLUSIVE RIGHT TO
USE "GLOBAL", APART FROM THE MARK AS SHOWN.

FOR ARRANGING TRAVEL FOR SHORT-TERM
TRIPS OVERSEAS FOR YOUTHS WHO ENLIST IN A
PROGRAM TO LEARN FOREIGN LANGUAGES AND
OTHER CULTURES (U.S. CLS. 100 AND 105).

FIRST USE 1-15-2001; IN COMMERCE 3-15-2001.

SN 76-336,137. KEESEE, CHRISTIAN K., OKLAHOMA CITY,
OK. FILED 11-9-2001.

TIME AIR

NO CLAIM IS MADE TO THE EXCLUSIVE RIGHT TO
USE "AIR", APART FROM THE MARK AS SHOWN.

FOR TRANSPORTATION OF PASSENGERS AND
GOODS BY AIR (U.S. CLS. 100 AND 105).

SN 76-336,138. KEESEE, CHRISTIAN K., OKLAHOMA CITY,
OK. FILED 11-9-2001.

TIME AIRLINES

NO CLAIM IS MADE TO THE EXCLUSIVE RIGHT TO
USE "AIRLINES", APART FROM THE MARK AS SHOWN.

FOR TRANSPORTATION OF PASSENGERS AND
GOODS BY AIR (U.S. CLS. 100 AND 105).

CLASS 39—(Continued).

SN 76-344,913. BUILDFILE, INC., JACKSONVILLE, FL.
FILED 12-4-2001.

BUILDFILE

FOR PROVIDING SECURE ELECTRONIC STORAGE
OF PROJECT DATA VIA A GLOBAL COMPUTER NET-
WORK (U.S. CLS. 100 AND 105).

SN 78-013,419. EBOX.COM INC, TORONTO, ONTARIO,
CANADA, FILED 6-19-2000.

L'EBOX

FOR COURIER SERVICES, NAMELY, THE DELIVERY
OF FOOD AND PARCELS TO AND FROM SPECIALLY
DESIGNED DROP AND PICKUP BOXES (U.S. CLS. 100
AND 105).

SN 78-013,421. EBOX.COM INC, TORONTO, ONTARIO,
CANADA, FILED 6-19-2000.

**THINGS I WANT ... WHEN I
WANT**

FOR COURIER SERVICES, NAMELY, THE DELIVERY
OF FOOD AND PARCELS TO AND FROM SPECIALLY
DESIGNED DROP AND PICKUP BOXES (U.S. CLS. 100
AND 105).

SN 78-013,422. EBOX.COM INC, TORONTO, ONTARIO,
CANADA, FILED 6-19-2000.

EBOX DELIVERS

FOR COURIER SERVICES, NAMELY, THE DELIVERY
OF FOOD AND PARCELS TO AND FROM SPECIALLY
DESIGNED DROP AND PICKUP BOXES (U.S. CLS. 100
AND 105).

SN 78-013,432. EBOX.COM INC, TORONTO, ONTARIO,
CANADA, FILED 6-20-2000.

WHY FIGHT WITH CROWDS

FOR COURIER SERVICES, NAMELY, THE DELIVERY
OF FOOD AND PARCELS TO AND FROM SPECIALLY
DESIGNED DROP AND PICKUP BOXES (U.S. CLS. 100
AND 105).

CLASS 39—(Continued).

SN 78-074,706. AMERICAN MOTORCYCLIST ASSOCIATION, PICKERINGTON, OH. FILED 7-19-2001.

MOTOW

FOR VEHICLE TOWING, NAMELY, EMERGENCY MOTORCYCLE TOWING SERVICES (U.S. CLS. 100 AND 105).
FIRST USE 1-1-1995; IN COMMERCE 1-1-1995.

CLASS 40—(Continued).

SN 76-069,318. PIXEL MAGIC IMAGING, INC., SAN MARCOS, TX. FILED 6-13-2000.



MyPhotoLab.com

FOR ELECTRONIC IMAGING, SCANNING, DIGITIZING, ALTERATION, RETOUCHING AND RESTORATION OF PHOTOGRAPHIC IMAGES; PHOTOGRAPHIC PRINTING; MEDIA DUPLICATION OF DATA AND DIGITAL INFORMATION; PHOTOFINISHING SERVICES PROVIDED OVER AN ELECTRONIC COMPUTER NETWORK; FILM PROCESSING SERVICES WHICH ALLOW CUSTOMERS TO RECEIVE, VIEW, MANIPULATE, TRANSMIT AND STORE DIGITIZED PHOTOGRAPHS VIA A GLOBAL COMPUTER INFORMATION NETWORK (U.S. CLS. 100, 103 AND 106).
FIRST USE 3-1-2000; IN COMMERCE 3-1-2000.

CLASS 40—MATERIAL TREATMENT

SN 75-929,980. STAMPS.COM INC., SANTA MONICA, CA. FILED 2-27-2000.



NO CLAIM IS MADE TO THE EXCLUSIVE RIGHT TO USE ".COM", APART FROM THE MARK AS SHOWN.
FOR DOCUMENT DATA TRANSFER AND PHYSICAL CONVERSION SERVICES FROM ONE MEDIA TO ANOTHER (U.S. CLS. 100, 103 AND 106).

SN 76-078,440. SPENGLER, CHARLES W., DBA BIOBUBBLE, INC., FT. COLLINS, CO. FILED 6-27-2000.

THE COLORADO CLEAN ROOM COMPANY

NO CLAIM IS MADE TO THE EXCLUSIVE RIGHT TO USE "COMPANY", APART FROM THE MARK AS SHOWN.
SEC. 2(F).
FOR CUSTOM FABRICATION SERVICES TO THE ORDER OF OTHERS IN THE FIELD OF CLEAN ROOMS AND DEVICES TO SANITIZE ROOMS (U.S. CLS. 100, 103 AND 106).
FIRST USE 9-26-1995; IN COMMERCE 9-26-1995.

SN 76-062,477. SEETHEBABY.COM, INC., RAMAT HASHARON, ISRAEL, FILED 6-5-2000.

SEETHEBABY

FOR ELECTRONIC IMAGING, SCANNING, DIGITIZING, ALTERATION AND/OR RETOUCHING OF PRE-NATAL AND NEONATAL IMAGES; PHOTOGRAPHIC REPRODUCTION AND PRINTING; DIGITAL IMAGING SERVICES; DIGITAL ENHANCEMENT OF ULTRASOUND IMAGES; PHOTOGRAPHIC COMPUTER IMAGING (U.S. CLS. 100, 103 AND 106).

SN 76-087,771. ARDMORE GRAPHIC SERVICES, INC., WALPOLE, MA. FILED 7-1-2000.

PRESSKITS

SEC. 2(F).
FOR MANUFACTURING, DIE-CUTTING, FOLDING AND GLUING OF PAPER PRODUCTS, NAMELY, CD MAILERS, POCKET FOLDERS AND VIDEO SLEEVES, TO THE SPECIFICATIONS OF OTHERS (U.S. CLS. 100, 103 AND 106).
FIRST USE 1-1-1984; IN COMMERCE 1-1-1984.

CLASS 40—(Continued).

SN 76-089,383. ANDERSON, KENT G, BISMARCK, ND.
FILED 7-14-2000.

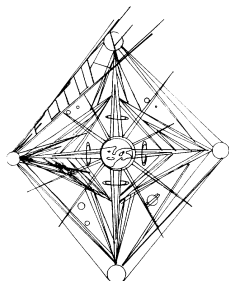

FOR MANUFACTURE OF CARS, VEHICLES, AIRCRAFT, LAND CRAFT, WATERCRAFT, SPACE VEHICLES, FURNITURE, APPLIANCES, HOUSEHOLD PRODUCTS AND TOYS TO THE ORDER AND/OR SPECIFICATION OF OTHERS (U.S. CLS. 100, 103 AND 106).

SN 76-122,408. HARDCOATING TECHNOLOGIES, LTD., TALLMADGE, OH. FILED 9-5-2000.



NO CLAIM IS MADE TO THE EXCLUSIVE RIGHT TO USE "HARDCOATING TECHNOLOGIES LIMITED", APART FROM THE MARK AS SHOWN.
FOR HARDCOATING OF TOOLS AND MACHINE PARTS (U.S. CLS. 100, 103 AND 106).
FIRST USE 8-15-2000; IN COMMERCE 8-15-2000.

SN 76-131,513. INDIGOVISION LIMITED, EDINBURGH, UNITED KINGDOM, BY CHANGE OF NAME INDIGO ACTIVE VISION SYSTEMS LIMITED, EDINBURGH EH26 9PY, UNITED KINGDOM, FILED 9-13-2000.

VISIONWORKS

PRIORITY CLAIMED UNDER SEC. 44(D) ON ERP/NTM CMNTY TM OFC APPLICATION NO. 1553080, FILED 3-13-2000.
FOR DIGITAL IMAGING SERVICES; NONE RELATING TO COMPUTER GRAPHIC SERVICES AND PHOTOGRAPHY SERVICES (U.S. CLS. 100, 103 AND 106).

CLASS 40—(Continued).

SN 76-154,182. GREAT WESTERN PRESS, INC., DALLAS, TX. FILED 10-26-2000.

LIQUID GLASS PROCESS

NO CLAIM IS MADE TO THE EXCLUSIVE RIGHT TO USE "PROCESS", APART FROM THE MARK AS SHOWN.
FOR TREATMENT OF MATERIALS, NAMELY, COATING SHEETS MADE PRIMARILY OF PAPER OR CARDBOARD PRODUCTS OR OTHER PRINTABLE MATERIALS WITH A COATING FOR USE IN ABSORBING ULTRAVIOLET LIGHT (U.S. CLS. 100, 103 AND 106).

SN 76-165,122. YAFFE COMPANIES INCORPORATED, MUSKOGEE, OK. FILED 11-14-2000.

SCRAP HAPPENS

FOR SCRAP METAL RECYCLING SERVICES (U.S. CLS. 100, 103 AND 106).
FIRST USE 8-21-2000; IN COMMERCE 8-21-2000.

SN 76-179,258. ROCKET BUSINESS SERVICES, LLC, MILWAUKEE, WI. FILED 12-12-2000.

ROCKET PHOTO EXPRESS

NO CLAIM IS MADE TO THE EXCLUSIVE RIGHT TO USE "PHOTO EXPRESS", APART FROM THE MARK AS SHOWN.
FOR FILM PROCESSING AND PHOTO FINISHING SERVICES (U.S. CLS. 100, 103 AND 106).
FIRST USE 6-12-2000; IN COMMERCE 6-12-2000.

SN 76-188,627. PARASCRIPT, LLC, NIWOT, CO. FILED 1-2-2001.

TRS

FOR SERVICES FOR CONVERTING HANDWRITTEN AND MACHINE PRINTED DOCUMENTS INTO ELECTRONIC TEXT (U.S. CLS. 100, 103 AND 106).

SN 76-199,881. CANON KABUSHIKI KAISHA, TOKYO, JAPAN, FILED 1-25-2001.

IMAGELAND.NET

FOR COMPUTERIZED ON-LINE DIGITAL PHOTO SERVICES, NAMELY, PHOTOCOMPOSITION SERVICES, PHOTOGRAPHIC REPRODUCTION, AND PHOTOGRAPHIC PRINT PROCESSING (U.S. CLS. 100, 103 AND 106).
FIRST USE 11-0-1999; IN COMMERCE 11-0-1999.

CLASS 40—(Continued).

SN 76-201,384. CENTERLINE AUTOMATION SERVICES INC., SHREWSBURY, MA. FILED 1-29-2001.



NO CLAIM IS MADE TO THE EXCLUSIVE RIGHT TO USE "AUTOMATION SERVICES INC.", APART FROM THE MARK AS SHOWN.

FOR CUSTOM MANUFACTURE OF TOOLING FOR MOLDED PARTS AND REPAIRS, REPLACEMENT AND UPGRADE PARTS FOR AUTOMATION MACHINERY (U.S. CLS. 100, 103 AND 106).

FIRST USE 10-26-2000; IN COMMERCE 10-26-2000.

SN 76-282,811. ADVANCE BAG, INC., HARTFORD, WI. FILED 7-10-2001.

ADVANCE BAG

NO CLAIM IS MADE TO THE EXCLUSIVE RIGHT TO USE "BAG", APART FROM THE MARK AS SHOWN.

FOR CONVERTING HIGH AND LOW DENSITY POLYETHYLENE AND POLYPROPYLENE INTO POLYBAGS WITH VARIABLE SHAPES, DESIGNS, CLOSURES, AND THICKNESS, AND PRINTING SERVICES (U.S. CLS. 100, 103 AND 106).

FIRST USE 11-1-1998; IN COMMERCE 11-1-1998.

SN 76-331,935. PACUSMA COMPANY LTD., HUNG HOM, KOWLOON, HONG KONG, FILED 10-30-2001.



FOR CUSTOM MANUFACTURE OF ELECTRICAL PRODUCTS TO THE ORDER OF OTHERS (U.S. CLS. 100, 103 AND 106).

FIRST USE 8-0-1978; IN COMMERCE 8-0-1978.

CLASS 40—(Continued).

SN 78-029,845. REBEL WITHOUT A PAUSE, TUCSON, AZ. FILED 10-10-2000.

REBEL WITHOUT A PAUSE

FOR DIGITAL IMAGING SERVICES; DIGITAL RESTORATION AND/OR ENHANCEMENT OF PHOTOGRAPHS; DUPLICATION OF AUDIO TAPES, TAPE RECORDINGS, VIDEO CASSETTES AND VIDEO TAPES; FILM DEVELOPING, PROCESSING AND PHOTOFINISHING; PHOTOCOMPOSITION SERVICES; PHOTOGRAPHIC COMPUTER IMAGING, PHOTOGRAPHIC ENLARGING, PHOTOGRAPHIC FILM DEVELOPING, PHOTOGRAPHIC PRINTING, PHOTOGRAPHIC REPRODUCTION, PHOTOGRAPHIC RESTORATION, PHOTOGRAPHIC RETOUCHING AND PHOTOGRAPHIC SLIDE AND/OR PRINT PROCESSING (U.S. CLS. 100, 103 AND 106).

SN 78-089,936. AAA PRECIOUS METALS, INC., PORTLAND, OR. FILED 10-24-2001.

AAA PRECIOUS METALS

NO CLAIM IS MADE TO THE EXCLUSIVE RIGHT TO USE "PRECIOUS METALS", APART FROM THE MARK AS SHOWN.

FOR MATERIAL TREATMENT SERVICES, NAMELY, REFINING, CASTING, SMELTING, MELTING AND PROCESSING PRECIOUS METALS; PROCESSING OF NON-FERROUS METALS; METAL TREATMENT AND CASTING SERVICES, NAMELY, TREATMENT OF HAZARDOUS MATERIALS AND LIQUIDS CONTAINING PRECIOUS METALS; RECOVERY OF PRECIOUS METALS FOR RECYCLING PURPOSES; ALLOYING OF PRECIOUS METALS FOR OTHERS; PRODUCTION OF NON-PRECIOUS METAL ALLOYS FOR OTHERS, PRODUCTION OF CASTING ALLOYS AND KARAT ALLOYS FOR OTHERS (U.S. CLS. 100, 103 AND 106).

FIRST USE 8-16-1980; IN COMMERCE 10-16-1980.

CLASS 41—EDUCATION AND ENTERTAINMENT

SN 75-151,421. NYT MANAGEMENT SERVICES, TAMPA, FL. BY ASSIGNMENT NEW YORK TIMES COMPANY, THE, NEW YORK, NY. FILED 8-16-1996.

GATORSPORTS

FOR PROVIDING SPORTS NEWS AND SPORTS INFORMATION THROUGH A GLOBAL COMPUTER NETWORK (U.S. CLS. 100, 101 AND 107).

FIRST USE 6-23-1996; IN COMMERCE 6-23-1996.

CLASS 41—(Continued).

SN 75-277,062. MEYER CREATIVITY ASSOCIATES, INC., CHICAGO, IL. FILED 4-18-1997.

QUANTUM CREATIVITY

FOR EDUCATIONAL SERVICES, NAMELY, CONDUCTING SEMINARS, WORKSHOPS AND TRAINING SESSIONS INCLUDING LECTURES, IMPROVISATION AND THEATRE GAMES IN THE FIELD OF BUSINESS MANAGEMENT AND ORGANIZATIONAL DEVELOPMENT, AND DISTRIBUTING PRINTED MATERIALS IN CONNECTION THEREWITH (U.S. CLS. 100, 101 AND 107).
FIRST USE 9-0-1994; IN COMMERCE 8-3-1995.

SN 75-622,421. WEST ISLAND COLLEGE INTERNATIONAL, INC., QUEBEC H9B 2L2, CANADA, FILED 1-19-1999.

CLASS AFLOAT

NO CLAIM IS MADE TO THE EXCLUSIVE RIGHT TO USE "CLASS", APART FROM THE MARK AS SHOWN. SEC. 2(F).
FOR EDUCATIONAL SERVICES, NAMELY, CONDUCTING EXPERIENTIAL COURSES OF INSTRUCTION AT THE SENIOR HIGH SCHOOL AND JUNIOR COLLEGE LEVELS (U.S. CLS. 100, 101 AND 107).
FIRST USE 10-31-1984; IN COMMERCE 12-31-1990.

SN 75-668,444. PLASMANET, INC., NEW ROCHELLE, NY. FILED 3-26-1999.

FREELOTTO.COM

NO CLAIM IS MADE TO THE EXCLUSIVE RIGHT TO USE "LOTTO", APART FROM THE MARK AS SHOWN.
FOR ENTERTAINMENT SERVICES, NAMELY, PROVIDING AN ON-LINE COMPUTER GAMES (U.S. CLS. 100, 101 AND 107).
FIRST USE 6-1-1999; IN COMMERCE 6-1-1999.

SN 75-772,800. KENTON GROUP, L.L.C., ST. LOUIS, MO. FILED 8-11-1999.

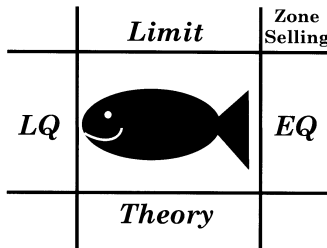

NO CLAIM IS MADE TO THE EXCLUSIVE RIGHT TO USE "ZONE SELLING", APART FROM THE MARK AS SHOWN.
FOR WORKSHOPS AND SEMINARS IN THE FIELD OF SALES AND MANAGEMENT OF SALES (U.S. CLS. 100, 101 AND 107).
FIRST USE 0-0-1999; IN COMMERCE 0-0-1999.

CLASS 41—(Continued).

SN 75-826,817. MUSICHALL WORLDWIDE LIMITED, HAMILTON HM CX, BERMUDA, FILED 10-18-1999.

AUDIO GRAFFITI

NO CLAIM IS MADE TO THE EXCLUSIVE RIGHT TO USE "AUDIO", APART FROM THE MARK AS SHOWN.
FOR PROVIDING AN AUDIO, ON-LINE COMPUTER DATABASE IN THE FIELD OF MUSIC; PROVIDING A WEBSITE ON A GLOBAL COMPUTER NETWORK FEATURING INFORMATION IN THE FIELD OF MUSIC (U.S. CLS. 100, 101 AND 107).
FIRST USE 1-1-1999; IN COMMERCE 1-1-1999.

SN 75-829,476. BULLOCK, SANDRA, WEST HOLLYWOOD, CA. FILED 10-22-1999.

SANDRA BULLOCK

FOR ENTERTAINMENT SERVICES, NAMELY, ACTING IN MOTION PICTURES, FILM, AND TELEVISION, AND LIVE THEATRICAL PERFORMANCES AND TELEVISION APPEARANCES; MOTION PICTURE FILM PRODUCTION AND DIRECTING (U.S. CLS. 100, 101 AND 107).
FIRST USE 0-0-1988; IN COMMERCE 0-0-1988.

SN 75-884,305. MICROSOFT CORPORATION, REDMOND, WA. FILED 12-30-1999.

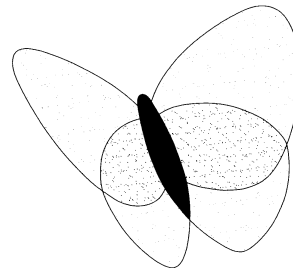

THE STIPPLING IS FOR SHADING ONLY. COLOR IS NOT CLAIMED AS PART OF THE MARK.
THE MARK COMPRISES A BUTTERFLY DESIGN.
FOR ENTERTAINMENT SERVICES, NAMELY, PROVIDING INTERACTIVE ON-LINE COMPUTER GAMES VIA LOCAL COMPUTER NETWORKS AND GLOBAL COMMUNICATION NETWORKS; PROVIDING INFORMATION IN THE FIELDS OF MOVIES AND SPORTS VIA LOCAL COMPUTER NETWORKS AND GLOBAL COMMUNICATION NETWORKS; PROVIDING EDUCATIONAL INFORMATION FOR USE IN PREPARING LESSON PLANS IN THE FIELDS OF ART, FOREIGN LANGUAGES, HEALTH, INFORMATION TECHNOLOGY, LANGUAGE ARTS, MATH, PHILOSOPHY, PHYSICAL EDUCATION, RELIGION, SCIENCE, SOCIAL STUDIES AND VOCATIONAL EDUCATION VIA COMPUTER NETWORKS AND GLOBAL COMMUNICATION NETWORKS; ON-LINE EDUCATION SERVICES, NAMELY, PROVIDING INFORMATION ON SPECIFIC EDUCATIONAL PROGRAMS, NAMELY, INFORMATION IN THE FIELDS OF ACADEMIC PROGRAMS SUCH AS ADULT AND CONTINUING EDUCATION PROGRAMS, INFORMATION ON SPECIFIC COLLEGES AND UNIVERSITIES, COMMUNITY COLLEGES, INFORMATION ON ONLINE EDUCATIONAL COURSES, INFORMATION ON FINANCIAL AID PROGRAMS PRO-

CLASS 41—(Continued).

VIDED BY EDUCATIONAL INSTITUTIONS, INFORMATION ON GRADUATE STUDIES PROGRAMS, INFORMATION ON PROGRAMS FEATURING COURSES OF INSTRUCTION FOR K-12 EDUCATION, INFORMATION ON EDUCATIONAL EXCHANGE PROGRAMS, INFORMATION ON PROGRAMS FEATURING THEORY AND METHODS OF EDUCATION, INFORMATION ON HOME SCHOOLING PROGRAMS, ALL OFFERED VIA COMPUTER NETWORKS AND GLOBAL COMMUNICATION NETWORKS; ON-LINE INFORMATION SERVICES, NAMELY, PROVIDING REFERENCE AND ENCYCLOPEDIA INFORMATION IN THE FIELDS OF SCIENCE, TECHNOLOGY, GEOGRAPHY, HISTORY, SOCIAL SCIENCE, RELIGION, PHILOSOPHY, ART, LANGUAGE, LITERATURE, PERFORMING ARTS, SPORTS, HOBBIES AND PETS; AND PROVIDING VISITOR AND ENTERTAINMENT INFORMATION VIA LOCAL COMPUTER NETWORKS AND GLOBAL COMMUNICATION NETWORKS CONCERNING CITIES, CITY SERVICES, EVENTS AND SITES OF INTEREST LOCATED IN AND AROUND CITIES, INFORMATION AND REVIEWS ON SPORTS, MOVIES, ARTS, CULTURE AND CIVIC EVENTS AND ATTRACTIONS, AND TRANSPORTATION SERVICES (U.S. CLS. 100, 101 AND 107).

SN 75-889,436. SAN FRANCISCO LESBIAN, GAY, BISEXUAL, TRANSGENDER PRIDE CELEBRATION COMMITTEE, INC., SAN FRANCISCO, CA. FILED 1-5-2000.

SAN FRANCISCO GAY PRIDE PARADE

NO CLAIM IS MADE TO THE EXCLUSIVE RIGHT TO USE "GAY PRIDE PARADE", APART FROM THE MARK AS SHOWN.

SEC. 2(F).

FOR EDUCATION AND ENTERTAINMENT SERVICES, NAMELY ORGANIZING AND CONDUCTING COMMUNITY FESTIVALS, EVENTS, ART EXHIBITS, PARADES, STREET FAIRS, THEATER PERFORMANCES, MUSIC PERFORMANCES, FORUMS, SEMINARS, PARTIES AND RALLIES WHICH FOSTER PRIDE IN A WIDE VARIETY OF SEXUAL ORIENTATIONS, NAMELY, LESBIAN, GAY, BISEXUAL AND TRANSGENDER IDENTITIES (U.S. CLS. 100, 101 AND 107).

FIRST USE 6-0-1970; IN COMMERCE 6-0-1970.

SN 75-889,691. TASMANIA RESOURCE, INC., NEWARK, DE. FILED 1-6-2000.

PHARMAQUEST

FOR EDUCATIONAL SERVICES, NAMELY PROVIDING EDUCATIONAL SEMINARS AND CONFERENCES RELATING TO TOPICS OF INTEREST TO THE PHARMACEUTICAL INDUSTRY (U.S. CLS. 100, 101 AND 107).

FIRST USE 5-0-1999; IN COMMERCE 5-0-1999.

CLASS 41—(Continued).

SN 75-904,361. PROFESSIONAL GOLFERS' ASSOCIATION OF AMERICA, THE, PALM BEACH GARDENS, FL. FILED 1-27-2000.

PGA TOUR SHOTLINK SYSTEM

OWNER OF U.S. REG. NOS. 1,264,248, 2,122,140 AND OTHERS.

NO CLAIM IS MADE TO THE EXCLUSIVE RIGHT TO USE "SYSTEM", APART FROM THE MARK AS SHOWN.

SEC. 2(F) AS TO "TOUR".

FOR ONLINE ENTERTAINMENT SERVICES, NAMELY, PROVIDING REAL TIME REPORTING OF SPORTING EVENTS, FEATURING GOLF SHOTS, GOLF COURSE MAPPING AND SCORING GATHERED DURING PROFESSIONAL GOLF TOURNAMENT COMPETITIONS (U.S. CLS. 100, 101 AND 107).

SN 75-913,463. MICROSOFT CORPORATION, REDMOND, WA. FILED 2-7-2000.

T1 MSN

OWNER OF U.S. REG. NOS. 2,014,296, 2,153,763 AND OTHERS.

NO CLAIM IS MADE TO THE EXCLUSIVE RIGHT TO USE "T1", APART FROM THE MARK AS SHOWN.

FOR ENTERTAINMENT SERVICES, NAMELY, PROVIDING INTERACTIVE ON-LINE COMPUTER GAMES VIA LOCAL COMPUTER NETWORKS AND GLOBAL COMMUNICATION NETWORKS; PROVIDING INFORMATION IN THE FIELDS OF MOVIES AND SPORTS VIA LOCAL COMPUTER NETWORKS AND GLOBAL COMMUNICATION NETWORKS; PROVIDING EDUCATIONAL INFORMATION FOR USE IN PREPARING LESSON PLANS IN THE FIELDS OF ART, FOREIGN LANGUAGES, HEALTH, INFORMATION TECHNOLOGY, LANGUAGE ARTS, MATH, PHILOSOPHY, PHYSICAL EDUCATION, RELIGION, SCIENCE, SOCIAL STUDIES AND VOCATIONAL EDUCATION VIA COMPUTER NETWORKS; AND GLOBAL COMMUNICATION NETWORKS; ON-LINE EDUCATION SERVICES, NAMELY, PROVIDING INFORMATION ON SPECIFIC EDUCATIONAL PROGRAMS, NAMELY, INFORMATION IN THE FIELDS OF ACADEMIC PROGRAMS SUCH AS ADULT AND CONTINUING EDUCATION PROGRAMS, INFORMATION ON SPECIFIC COLLEGES AND UNIVERSITIES, COMMUNITY COLLEGES, INFORMATION ON ONLINE EDUCATIONAL COURSES, INFORMATION ON FINANCIAL AID PROGRAMS PROVIDED BY EDUCATIONAL INSTITUTIONS, INFORMATION ON GRADUATE STUDIES PROGRAMS, INFORMATION ON PROGRAMS FEATURING COURSES OF INSTRUCTION FOR K-12 EDUCATION, INFORMATION ON EDUCATIONAL EXCHANGE PROGRAMS, INFORMATION ON PROGRAMS FEATURING THEORY AND METHODS OF EDUCATION, INFORMATION ON HOME SCHOOLING PROGRAMS, ALL OFFERED VIA COMPUTER NETWORKS AND GLOBAL COMMUNICATION NETWORKS; ON-LINE INFORMATION SERVICES, NAMELY, PROVIDING REFERENCE AND ENCYCLOPEDIA INFORMATION IN THE FIELDS OF SCIENCE, TECHNOLOGY, GEOGRAPHY, HISTORY, SOCIAL SCIENCE, RELIGION, PHILOSOPHY, ART, LANGUAGE, LITERATURE, PERFORMING ARTS, SPORTS, HOBBIES AND PETS; AND PROVIDING VISITOR AND ENTERTAINMENT INFORMATION VIA LOCAL COMPUTER NETWORKS; AND GLOBAL COMMUNICATION NETWORKS CONCERNING CITIES, CITY SERVICES, EVENTS AND SITES OF INTEREST LOCATED IN AND AROUND CITIES, INFORMATION AND REVIEWS ON SPORTS, MOVIES, ARTS, CULTURE AND CIVIC EVENTS AND ATTRACTIONS, AND TRANSPORTATION SERVICES (U.S. CLS. 100, 101 AND 107).

CLASS 41—(Continued).

SN 75-913,469. MICROSOFT CORPORATION, REDMOND, WA. FILED 2-7-2000.

T1MSN

OWNER OF U.S. REG. NOS. 2,014,296, 2,153,763 AND OTHERS.

FOR ENTERTAINMENT SERVICES, NAMELY, PROVIDING INTERACTIVE ON-LINE COMPUTER GAMES VIA LOCAL COMPUTER NETWORKS AND GLOBAL COMMUNICATION NETWORKS; PROVIDING INFORMATION IN THE FIELDS OF MOVIES AND SPORTS VIA LOCAL COMPUTER NETWORKS AND GLOBAL COMMUNICATION NETWORKS; PROVIDING EDUCATIONAL INFORMATION FOR USE IN PREPARING LESSON PLANS IN THE FIELDS OF ART, FOREIGN LANGUAGES, HEALTH, INFORMATION TECHNOLOGY, LANGUAGE ARTS, MATH, PHILOSOPHY, PHYSICAL EDUCATION, RELIGION, SCIENCE, SOCIAL STUDIES AND VOCATIONAL EDUCATION VIA COMPUTER NETWORKS AND GLOBAL COMMUNICATION NETWORKS; ON-LINE EDUCATION SERVICES, NAMELY, PROVIDING INFORMATION ON SPECIFIC EDUCATIONAL PROGRAMS, NAMELY, INFORMATION IN THE FIELDS OF ACADEMIC PROGRAMS SUCH AS ADULT AND CONTINUING EDUCATION PROGRAMS, INFORMATION ON SPECIFIC COLLEGES AND UNIVERSITIES, COMMUNITY COLLEGES, INFORMATION ON ONLINE EDUCATIONAL COURSES, INFORMATION ON FINANCIAL AID PROGRAMS PROVIDED BY EDUCATIONAL INSTITUTIONS, INFORMATION ON GRADUATE STUDIES PROGRAMS, INFORMATION ON PROGRAMS FEATURING COURSES OF INSTRUCTION FOR K-12 EDUCATION, INFORMATION ON EDUCATIONAL EXCHANGE PROGRAMS, INFORMATION ON PROGRAMS FEATURING THEORY AND METHODS OF EDUCATION, INFORMATION ON HOME SCHOOLING PROGRAMS, ALL OFFERED VIA COMPUTER NETWORKS AND GLOBAL COMMUNICATION NETWORKS; ON-LINE INFORMATION SERVICES, NAMELY, PROVIDING REFERENCE AND ENCYCLOPEDIA INFORMATION IN THE FIELDS OF SCIENCE, TECHNOLOGY, GEOGRAPHY, HISTORY, SOCIAL SCIENCE, RELIGION, PHILOSOPHY, ART, LANGUAGE, LITERATURE, PERFORMING ARTS, SPORTS, HOBBIES AND PETS; AND PROVIDING VISITOR AND ENTERTAINMENT INFORMATION VIA LOCAL COMPUTER NETWORK AND GLOBAL COMMUNICATION NETWORKS CONCERNING CITIES, CITY SERVICES, EVENTS AND SITES OF INTEREST LOCATED IN AND AROUND CITIES, INFORMATION AND REVIEWS ON SPORTS, MOVIES, ARTS, CULTURE AND CIVIC EVENTS AND ATTRACTIONS, AND TRANSPORTATION SERVICES (U.S. CLS. 100, 101 AND 107).

SN 76-003,044. UNIVERSITY OF PITTSBURGH OF THE COMMONWEALTH SYSTEM OF HIGHER EDUCATION, PITTSBURGH, PA. FILED 3-17-2000.



FOR PROVIDING INCENTIVES TO NURSES TO DEMONSTRATE EXCELLENCE IN THE FIELD OF CLINICAL PRACTICE THROUGH THE ISSUANCE OF AWARDS (U.S. CLS. 100, 101 AND 107).

FIRST USE 6-15-1999; IN COMMERCE 6-15-1999.

CLASS 41—(Continued).

SN 76-020,895. WORLD TRIBE, RANCHO PALOS VERDES, CA. FILED 4-6-2000.

WORLD TRIBE

FOR ENTERTAINMENT SERVICES, NAMELY, LIVE PERFORMANCES BY A MUSICAL GROUP (U.S. CLS. 100, 101 AND 107).

FIRST USE 9-1-1991; IN COMMERCE 1-1-1996.

SN 76-025,110. CHAMBERBENEFITS, INC., ORLANDO, FL. FILED 4-13-2000.



NO CLAIM IS MADE TO THE EXCLUSIVE RIGHT TO USE "WORK FORCE", APART FROM THE MARK AS SHOWN.

FOR EDUCATIONAL SERVICES, NAMELY CONDUCTING WORKSHOPS AND CONFERENCES IN THE FIELD OF WORKFORCE DEVELOPMENT, AND DISTRIBUTION OF COURSE MATERIALS IN CONNECTION THEREWITH (U.S. CLS. 100, 101 AND 107).

FIRST USE 5-21-1999; IN COMMERCE 5-21-1999.

SN 76-027,422. WEISS, MARTIN, DBA READY READ, AGOURA HILLS, CA. FILED 4-18-2000.

READY READ

NO CLAIM IS MADE TO THE EXCLUSIVE RIGHT TO USE "READ", APART FROM THE MARK AS SHOWN.

FOR EDUCATIONAL SERVICES, NAMELY CONDUCTING CLASSES, SEMINARS AND LECTURES IN THE FIELD OF READING (U.S. CLS. 100, 101 AND 107).

FIRST USE 7-25-1988; IN COMMERCE 7-25-1988.

SN 76-029,564. ALEXOFF, CARL, CALLAO, VA. FILED 4-20-2000.

POWERPLAY

FOR LOTTERY SERVICES (U.S. CLS. 100, 101 AND 107).

FIRST USE 3-4-1999; IN COMMERCE 3-4-1999.

CLASS 41—(Continued).

SN 76-033,278. ILLINOIS CPA SOCIETY, CHICAGO, IL. FILED 4-24-2000.



NO CLAIM IS MADE TO THE EXCLUSIVE RIGHT TO USE "CENTER FOR CORPORATE FINANCIAL LEADERSHIP" AND ANY COLOR IN THE MARK, APART FROM THE MARK AS SHOWN.

THE LINES, SPHERE, AND ELLIPTICAL RING SHALL BE IN BLUE. THE COLORING ON THE SPHERE SHALL FADE GRADUALLY TO WHITE TO GIVE THE APPEARANCE OF SHINE ON THE SPHERE. THE COLOR ON THE ELLIPTICAL RING SHALL GRADUALLY FADE AWAY AS ONE PORTION OF THE RING APPROACHES THE "C" IN THE WORD "CORPORATE".

FOR EDUCATIONAL SERVICES, NAMELY, CONDUCTING COURSES, CONFERENCE AND WORKSHOPS IN THE FIELD OF CORPORATE FINANCIAL LEADERSHIP FOR CORPORATE FINANCIAL EXECUTIVES (U.S. CLS. 100, 101 AND 107).

FIRST USE 3-1-2000; IN COMMERCE 3-1-2000.

SN 76-039,684. SMITHSONIAN INSTITUTION, WASHINGTON, DC. FILED 5-3-2000.

TREASURES TO GO

FOR MUSEUM AND EDUCATIONAL SERVICES, NAMELY, PROVIDING THEMATIC TRAVELING EXHIBITIONS, WORKSHOPS AND LIVE PRESENTATIONS RELATING TO AMERICAN ART PAINTINGS AND SCULPTURE; ENTERTAINMENT SERVICES, NAMELY, ON-GOING TELEVISION AND VIDEO PROGRAMS IN THE FIELD OF AMERICAN ART; PROVIDING INFORMATION ABOUT AMERICAN ART VIA A WEBSITE ON A GLOBAL COMPUTER NETWORK (U.S. CLS. 100, 101 AND 107).

FIRST USE 6-1-1999; IN COMMERCE 6-1-1999.

SN 76-046,981. ANONYMOUS CONTENT, LLC, CULVER CITY, CA. FILED 5-12-2000.

ANONYMOUS

FOR ENTERTAINMENT AND EDUCATIONAL SERVICES, NAMELY, PRODUCING AND DIRECTING MUSIC VIDEOS, TELEVISION SHOWS AND HOME VIDEOS (U.S. CLS. 100, 101 AND 107).

SN 76-046,983. ANONYMOUS CONTENT, LLC, CULVER CITY, CA. FILED 5-12-2000.

ANONYMOUS CONTENT

FOR ENTERTAINMENT AND EDUCATIONAL SERVICES, NAMELY, PRODUCING AND DIRECTING MUSIC VIDEOS, TELEVISION SHOWS AND HOME VIDEOS (U.S. CLS. 100, 101 AND 107).

CLASS 41—(Continued).

SN 76-057,099. INSTITUTE FOR TECHNOLOGY TRAINING AND EXCELLENCE, APTOS, CA. FILED 5-25-2000.

MEGAMIND

FOR EDUCATIONAL SERVICES, NAMELY, CONDUCTING CLASSES, SEMINARS, CONFERENCES, AND WORKSHOPS IN THE FIELD OF TECHNOLOGY TRAINING IN THE AREAS OF COMPUTER HARDWARE, COMPUTER SOFTWARE APPLICATIONS, COMPUTER PROGRAMMING, WEB PROGRAMMING, ECOMMERCE, COMPUTER NETWORKING AND SYSTEM MANAGEMENT, COMPUTER GRAPHICS AND ANIMATION, COMPUTER AND NETWORKING SECURITY, CUSTOM DEVELOPMENT OF TECHNICAL COMPUTER AND WEB-BASED TRAINING, AND EMERGING TECHNOLOGIES, NAMELY, THE DEVELOPMENT OF APPLICATIONS TO BE USED ON WIRELESS NETWORKS, CREATING AND MAINTAINING WEB SITES WITH REGARD TO WIRELESS DESIGNATIONS, AND COMPUTER DISASTER RECOVERY PLANNING (U.S. CLS. 100, 101 AND 107).

SN 76-057,771. LASKER, SONYA ANTOINETTE, PEARL CITY, HI. FILED 5-26-2000.

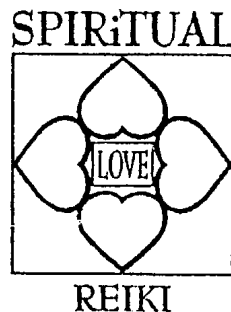

NO CLAIM IS MADE TO THE EXCLUSIVE RIGHT TO USE "REIKI", APART FROM THE MARK AS SHOWN.

THE ENGLISH TRANSLATION OF THE WORD "REIKI" IN THE MARK IS "UNIVERSAL LIFE FORCE ENERGY".

FOR EDUCATIONAL SERVICES, NAMELY, CONDUCTING CLASSES IN THE FIELD OF REIKI HEALING AND DISTRIBUTING COURSE MATERIALS IN CONNECTION THEREWITH (U.S. CLS. 100, 101 AND 107).

FIRST USE 7-24-1998; IN COMMERCE 7-24-1998.

SN 76-060,467. PROEIN SA, MADRID, SPAIN, FILED 5-31-2000.

**COMMANDOS: BEYOND
THE CALL OF DUTY**

FOR PROVIDING COMPUTER GAMES THAT MAY BE ACCESSED NETWORK-WIDE BY NETWORK USERS (U.S. CLS. 100, 101 AND 107).

CLASS 41—(Continued).

SN 76-061,019. LEIGH, CHRISTOPHER L., MYSTIC, CT. FILED 6-1-2000.

SUGARDADDY

FOR ENTERTAINMENT SERVICES, NAMELY MUSIC PERFORMANCES PROVIDED BY A LIVE BAND (U.S. CLS. 100, 101 AND 107).
FIRST USE 3-17-1994; IN COMMERCE 5-15-1998.

SN 76-072,199. E! ENTERTAINMENT TELEVISION, INC., LOS ANGELES, CA. FILED 6-16-2000.



NO CLAIM IS MADE TO THE EXCLUSIVE RIGHT TO USE "16", "SIXTEEN" AND "2000", APART FROM THE MARK AS SHOWN.

THE MARK CONSISTS OF THE NUMBER "16" INSIDE A CIRCLE SURROUNDED BY FLAMES.

FOR ENTERTAINMENT IN THE NATURE OF TAPED TELEVISION SHOWS OF A LIVE EVENT, NAMELY, A YEARLY AWARDS SHOW FEATURING NOMINATIONS AND SELECTIONS FOR THE SIXTEEN HOTTEST UP-AND-COMING TALENT IN THE ENTERTAINMENT INDUSTRY FOR THE FOLLOWING YEAR (U.S. CLS. 100, 101 AND 107).

SN 76-086,869. PEARSON EDUCATION, INC., UPPER SADDLE RIVER, NJ. FILED 7-11-2000.

THE SOCIOLOGY PLACE

NO CLAIM IS MADE TO THE EXCLUSIVE RIGHT TO USE "SOCIOLOGY", APART FROM THE MARK AS SHOWN.

FOR PROVIDING AN INTERACTIVE MULTIMEDIA WEB SITE WHICH STUDENTS AND INSTRUCTORS CAN INTERFACE WITH AN ABUNDANCE OF INFORMATION RELATING TO THE SUBJECT OF SOCIOLOGY (U.S. CLS. 100, 101 AND 107).

FIRST USE 8-1-2000; IN COMMERCE 8-1-2000.

SN 76-105,571. YAYA, LLC, LOS ANGELES, CA. BY CHANGE OF NAME FTK GAMES LLC, LOS ANGELES, CA. FILED 8-9-2000.

YAYA.COM

FOR PROVIDING COMPUTER GAMES THAT MAY BE ACCESSED THROUGH A GLOBAL COMPUTER NETWORK (U.S. CLS. 100, 101 AND 107).

CLASS 41—(Continued).

SN 76-109,905. FACECAKE.COM, INC., WOODLAND HILLS, CA. FILED 8-11-2000.

FACECAKE

FOR ENTERTAINMENT SERVICES IN THE NATURE OF A COMPETITIVE MODEL SEARCH (U.S. CLS. 100, 101 AND 107).
FIRST USE 6-9-2000; IN COMMERCE 6-9-2000.

SN 76-113,371. DEVELOP YOUR GAME, INC., MCKINNEY, TX. FILED 8-18-2000.

PERFECT PUTTING

NO CLAIM IS MADE TO THE EXCLUSIVE RIGHT TO USE "PUTTING", APART FROM THE MARK AS SHOWN.

FOR INSTRUCTIONS IN THE FIELD OF GOLF (U.S. CLS. 100, 101 AND 107).

SN 76-117,302. PICK ONE, INC., INDEPENDENCE, MO. FILED 8-25-2000.



NO CLAIM IS MADE TO THE EXCLUSIVE RIGHT TO USE "21", APART FROM THE MARK AS SHOWN.

FOR ENTERTAINMENT SERVICES IN THE NATURE OF A CASINO GAME (U.S. CLS. 100, 101 AND 107).

CLASS 41—(Continued).

SN 76-120,785. MORAL COMPASS FOUNDATION, INC., THE, MINNEAPOLIS, MN. FILED 8-31-2000.

MORAL COMPASS FOUNDATION

NO CLAIM IS MADE TO THE EXCLUSIVE RIGHT TO USE "FOUNDATION", APART FROM THE MARK AS SHOWN.

FOR EDUCATION IN THE FIELDS OF ETHICAL BEHAVIOR, PERSONAL IMPROVEMENT, MENTORING, PERSONAL EMPOWERMENT, AND POSITIVE BEHAVIOR; EDUCATIONAL SERVICES, NAMELY, ARRANGING AND CONDUCTING SEMINARS, CONFERENCES AND WORKSHOPS IN THE FIELDS OF ETHICAL BEHAVIOR, PERSONAL IMPROVEMENT, MENTORING, PERSONAL EMPOWERMENT, AND POSITIVE BEHAVIOR; ARRANGING AND CONDUCTING CLASSES, SEMINARS, AND WORKSHOPS TO TEACHERS, PARENTS, COUNSELORS, COACHES AND GROUP LEADERS IN THE FIELDS OF INSTRUCTING OTHERS IN ETHICAL BEHAVIOR, PERSONAL IMPROVEMENT, MENTORING, PERSONAL EMPOWERMENT, AND POSITIVE BEHAVIOR; PROVIDING INCENTIVES TO CHILDREN TO DEMONSTRATE EXCELLENCE IN THE FIELDS OF POSITIVE BEHAVIOR AND ETHICAL UNDERSTANDING; PROVIDING INCENTIVES TO PARTICIPANTS IN SEMINARS, CONFERENCES, AND WORKSHOPS TO DEMONSTRATE EXCELLENCE IN THE FIELDS OF POSITIVE BEHAVIOR AND ETHICAL UNDERSTANDING THROUGH THE ISSUANCE OF AWARDS; DEVELOPMENT AND DISSEMINATION OF EDUCATIONAL MATERIALS OF OTHERS IN THE FIELDS OF ETHICAL BEHAVIOR, PERSONAL IMPROVEMENT, MENTORING, PERSONAL EMPOWERMENT, AND POSITIVE BEHAVIOR, DEVELOPING EDUCATIONAL MANUALS FOR OTHERS IN THE FIELDS OF ETHICAL BEHAVIOR, PERSONAL IMPROVEMENT, MENTORING, PERSONAL EMPOWERMENT, AND POSITIVE BEHAVIOR (U.S. CLS. 100, 101 AND 107).

SN 76-120,862. KICK.COM, INC., SAN FRANCISCO, CA. FILED 9-1-2000.

YOUR MUSIC, WITH KICK

FOR ENTERTAINMENT IN THE NATURE OF ONGOING PROGRAMS FEATURING MUSIC NEWS AND MUSIC IDENTIFICATION, PICTURES OF RECORDING ARTISTS, PICTURES OF ALBUM COVER GRAPHICS, SONG INFORMATION, ARTIST BIOGRAPHIES, RECORD REVIEWS, MUSIC LYRICS, AND CONCERT INFORMATION, BY MEANS OF A GLOBAL COMPUTER NETWORK; ARRANGING FOR TICKET RESERVATIONS FOR CONCERTS AND OTHER ENTERTAINMENT EVENTS; ENTERTAINMENT ONLINE INFORMATION SERVICES, NAMELY PROVIDING DATA BASES AND WEBSITE LINKS TO OTHER CONTENT PROVIDERS IN THE FIELD OF MUSICAL ENTERTAINMENT (U.S. CLS. 100, 101 AND 107).

CLASS 41—(Continued).

SN 76-126,351. JAMES MARTIN WORLDWIDE PLC, CHERTSEY, SURREY, ENGLAND, FILED 9-12-2000.

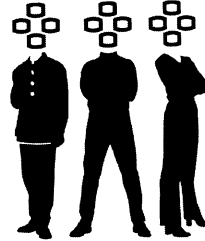

THE MARK CONSISTS OF THREE, CLOTHED HUMAN FIGURES WITH FOUR "BOX" SHAPES IN A "CROSS" CONFIGURATION IN PLACE OF THE FIGURES' HEADS.

FOR EDUCATIONAL SERVICES, NAMELY, CONDUCTING CLASSES, SEMINARS AND WORKSHOPS IN THE FIELD OF BUSINESS MANAGEMENT, BUSINESS REENGINEERING, AND SOFTWARE DESIGN AND DISTRIBUTING COURSE MATERIALS IN CONNECTION THEREWITH; COMPUTER TRAINING SERVICES, NAMELY, TRAINING BUSINESS ORGANIZATIONS IN THE IMPLEMENTATION OF COMPUTER INFORMATION SYSTEMS; AND PROVIDING ON-LINE CLASSES ON THE SUBJECT OF BUSINESS REENGINEERING, INFORMATION ENGINEERING, SOFTWARE DESIGN, AND E-COMMERCE (U.S. CLS. 100, 101 AND 107).

SN 76-129,391. JERSEY FILMS, LLC, LOS ANGELES, CA. FILED 9-18-2000.



OWNER OF U.S. REG. NOS. 253,326, 2,336,668 AND OTHERS.

NO CLAIM IS MADE TO THE EXCLUSIVE RIGHT TO USE "TELEVISION", APART FROM THE MARK AS SHOWN.

FOR ENTERTAINMENT SERVICES, NAMELY TELEVISION PRODUCTION SERVICES (U.S. CLS. 100, 101 AND 107).

FIRST USE 12-0-1999; IN COMMERCE 8-0-1998.

SN 76-130,453. BID.COM INTERNATIONAL INC., MISSISSAUGA, ONTARIO, CANADA, FILED 9-18-2000.

CLUB R.A.D.D.

NO CLAIM IS MADE TO THE EXCLUSIVE RIGHT TO USE "CLUB", APART FROM THE MARK AS SHOWN.

FOR ONLINE ENTERTAINMENT SERVICES, NAMELY, FAN CLUB SERVICES PROVIDED BY COMPUTER (U.S. CLS. 100, 101 AND 107).

CLASS 41—(Continued).

SN 76-132,205. MEYER, VIRGINIA H., DBA INTELLECTUAL PROPERTY INTERNATIONAL, MILL VALLEY, CA. FILED 9-20-2000.

INTELLECTUAL PROPERTY INTERNATIONAL

OWNER OF U.S. REG. NO. 1,914,379.
NO CLAIM IS MADE TO THE EXCLUSIVE RIGHT TO USE "INTELLECTUAL PROPERTY", APART FROM THE MARK AS SHOWN.

SEC. 2(F).
FOR EDUCATIONAL SERVICES, NAMELY CONDUCTING AND SPONSORING SEMINARS IN THE FIELDS OF US AND FOREIGN PATENTS, TRADEMARKS, COPYRIGHTS, TRADE SECRETS, MULTIMEDIA, COMPUTER AND TECHNOLOGY LAW, AND INTERNATIONAL TREATIES RELATED THERETO (U.S. CLS. 100, 101 AND 107).

FIRST USE 10-14-1993; IN COMMERCE 10-14-1993.

SN 76-139,125. ANAHEIM ANGELS, L.P., ANAHEIM, CA. FILED 10-2-2000.

ANGELS

OWNER OF U.S. REG. NOS. 1,485,613, 1,881,515 AND OTHERS.

FOR ENTERTAINMENT, EDUCATIONAL AND INFORMATION SERVICES, NAMELY, BASEBALL GAMES, COMPETITIONS AND EXHIBITIONS RENDERED LIVE, THROUGH BROADCAST MEDIA INCLUDING TELEVISION AND RADIO AND VIA A GLOBAL COMPUTER NETWORK OR A COMMERCIAL ON-LINE SERVICE; PROVIDING INFORMATION IN THE FIELD OF SPORTS, ENTERTAINMENT AND RELATED TOPICS; PROVIDING FOR INFORMATIONAL MESSAGES RELATING TO BASEBALL; PROVIDING MULTI-USER INTERACTIVE COMPUTER GAMES ALL VIA A GLOBAL COMPUTER NETWORK OR A COMMERCIAL ON-LINE SERVICE (U.S. CLS. 100, 101 AND 107).

FIRST USE 4-11-1961; IN COMMERCE 4-11-1961.

SN 76-139,126. ANAHEIM ANGELS, L.P., ANAHEIM, CA. FILED 10-2-2000.

ANAHEIM ANGELS

NO CLAIM IS MADE TO THE EXCLUSIVE RIGHT TO USE "ANAHEIM", APART FROM THE MARK AS SHOWN.

FOR ENTERTAINMENT, EDUCATIONAL AND INFORMATION SERVICES, NAMELY, BASEBALL GAMES, COMPETITIONS AND EXHIBITIONS RENDERED LIVE, THROUGH BROADCAST MEDIA INCLUDING TELEVISION AND RADIO AND VIA A GLOBAL COMPUTER NETWORK OR A COMMERCIAL ON-LINE SERVICE; PROVIDING INFORMATION IN THE FIELD OF SPORTS, ENTERTAINMENT AND RELATED TOPICS; PROVIDING FOR INFORMATIONAL MESSAGES RELATING TO BASEBALL; PROVIDING MULTI-USER INTERACTIVE COMPUTER GAMES ALL VIA A GLOBAL COMPUTER NETWORK OR A COMMERCIAL ON-LINE SERVICE (U.S. CLS. 100, 101 AND 107).

FIRST USE 11-19-1996; IN COMMERCE 11-19-1996.

CLASS 41—(Continued).

SN 76-141,874. EXECUTIVE CONVERSATION, INC., THE, SEATTLE, WA. FILED 10-6-2000.

SIA

FOR EDUCATIONAL SERVICES, NAMELY CONDUCTING CLASSES AND SEMINARS IN PERSON AND ONLINE IN THE FIELD OF BUSINESS MANAGEMENT, SALES AND MARKETING, ADMINISTRATION, EDUCATION, PERSONAL AND INTERPERSONAL SKILLS, INDIVIDUAL TUTORING AND TRAINING PROVIDED IN CONNECTION THEREWITH, AND COURSE MATERIALS IN THE NATURE OF COMPUTER PROGRAMS, TEXT BOOKS, WORKBOOKS, LESSON PLANS, EXAMPLE PROBLEMS, CASE STUDIES AND BUSINESS DESCRIPTIONS DISTRIBUTED FOR USE IN CONNECTION THEREWITH (U.S. CLS. 100, 101 AND 107).

SN 76-147,732. RES MEDIA GROUP, INC., NEW YORK, NY. FILED 10-16-2000.

RES

FOR ARRANGING AND CONDUCTING FILM FESTIVALS AND CONFERENCES; DISTRIBUTION OF MOTION PICTURES AND OTHER AUDIO-VISUAL ENTERTAINMENT; ELECTRONIC PUBLICATION SERVICES, NAMELY PUBLISHING OF TEXT AND GRAPHIC WORKS OF OTHERS ON CD-ROMS AND DVDS FEATURING AUDIO-VISUAL ENTERTAINMENT AND ANIMATION (U.S. CLS. 100, 101 AND 107).

FIRST USE 5-21-2000; IN COMMERCE 5-21-2000.

SN 76-149,026. TABIOS, EILEEN, SAN FRANCISCO, CA. FILED 10-18-2000.

MERITAGE PRESS

NO CLAIM IS MADE TO THE EXCLUSIVE RIGHT TO USE "PRESS", APART FROM THE MARK AS SHOWN.
FOR BOOK PUBLISHING SERVICES (U.S. CLS. 100, 101 AND 107).

SN 76-150,255. GAMESVILLE.COM, INC., WATERTOWN, MA. FILED 10-19-2000.

FRANTIC FISH

NO CLAIM IS MADE TO THE EXCLUSIVE RIGHT TO USE "FISH", APART FROM THE MARK AS SHOWN.

FOR PROVIDING COMPUTER GAMES, NAMELY, SLOT MACHINE GAMES THAT MAY BE ACCESSED BY USERS ON A GLOBAL COMPUTER NETWORK (U.S. CLS. 100, 101 AND 107).

FIRST USE 9-26-2000; IN COMMERCE 9-26-2000.

CLASS 41—(Continued).

SN 76-150,428. VOICE MALE B.V.B.A., 2600 BERCHEM, BELGIUM, FILED 10-19-2000.



OWNER OF BENELUX REG. NO. 0631825, DATED 5-8-1998, EXPIRES 5-8-2008.
FOR ENTERTAINMENT SERVICES, NAMELY, LIVE PERFORMANCES BY A MUSICAL BAND (U.S. CLS. 100, 101 AND 107).

CLASS 41—(Continued).

SN 76-152,952. B.F.C. INTERNATIONAL, INC., EL PASO, TX, FILED 10-24-2000.

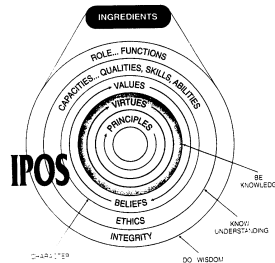

NO CLAIM IS MADE TO THE EXCLUSIVE RIGHT TO USE "INGREDIENTS, ROLE, FUNCTIONS, CAPACITIES, QUALITIES, SKILLS, ABILITIES, VALUES, VIRTUES, PRINCIPLES, BELIEFS, ETHICS, INTEGRITY, CHARACTER, DO WISDOM, KNOW UNDERSTANDING, BE KNOWLEDGE", APART FROM THE MARK AS SHOWN.

THE STIPPLING IN THE DRAWING IS A FEATURE OF THE MARK AND NOT FOR SHADING PURPOSES.

FOR EDUCATIONAL SERVICES, NAMELY, PROVIDING SEMINARS, LECTURES, AND CONFERENCES IN THE FIELD OF LEADERSHIP TRAINING (U.S. CLS. 100, 101 AND 107).

SN 76-150,859. TELEVISION FOOD NETWORK, G.P., NEW YORK, NY. FILED 10-20-2000.

UNWRAPPED

FOR ENTERTAINMENT SERVICES, NAMELY, AN ON-GOING AUDIO-VISUAL PROGRAM DISTRIBUTED OVER AUDIO AND VISUAL MEDIA IN THE FIELDS OF FOOD, COOKING, RECIPES, RESTAURANTS, ENTERTAINING AND THE CULINARY ARTS (U.S. CLS. 100, 101 AND 107).

SN 76-154,251. THOMSON INFORMATION LICENSING CORPORATION, WILMINGTON, DE. FILED 10-26-2000.

**EXPANDED ACADEMIC
ASAP**

SN 76-152,148. MILWAUKEE PSYCHIATRIC HOSPITAL, WAUWATOSA, WI. FILED 10-23-2000.

KRADWELL SCHOOL

NO CLAIM IS MADE TO THE EXCLUSIVE RIGHT TO USE "SCHOOL", APART FROM THE MARK AS SHOWN.

FOR EDUCATIONAL SERVICES, NAMELY, PROVIDING COURSES OF INSTRUCTION AT THE PRIMARY AND SECONDARY LEVEL WITH A FOCUS ON EMOTIONALLY CHALLENGED OR HANDICAPPED STUDENTS (U.S. CLS. 100, 101 AND 107).

FIRST USE 0-0-1968; IN COMMERCE 0-0-1968.

NO CLAIM IS MADE TO THE EXCLUSIVE RIGHT TO USE "ACADEMIC", APART FROM THE MARK AS SHOWN.

FOR PROVIDING ACADEMIC LIBRARIES WITH ABSTRACTS AND FULL TEXT ARTICLES IN ALL ACADEMIC DISCIPLINES VIA A GLOBAL COMPUTER NETWORK (U.S. CLS. 100, 101 AND 107).

FIRST USE 3-0-1997; IN COMMERCE 3-0-1997.

CLASS 41—(Continued).

SN 76-155,245. CAMP HEARTLAND PRODUCTIONS, INC., MINNEAPOLIS, MN. FILED 10-27-2000.



NO CLAIM IS MADE TO THE EXCLUSIVE RIGHT TO USE "FESTIVAL", APART FROM THE MARK AS SHOWN. FOR ENTERTAINMENT SERVICES, NAMELY, PRODUCTION AND PERFORMANCE OF LIVE MUSICAL SHOWS (U.S. CLS. 100, 101 AND 107). FIRST USE 12-30-1999; IN COMMERCE 12-30-1999.

SN 76-157,923. SCENARIONOW INC., CHESTERFIELD, MO. BY CHANGE OF NAME SCENARIONOW.COM, INC., CHESTERFIELD, MO. FILED 11-2-2000.

TOOLS FOR SERIOUS PLAY

FOR EDUCATIONAL SERVICES, NAMELY, CONDUCTING CLASSES, SEMINARS, CONFERENCES, WORKSHOPS AND COMPUTER BASED TRAINING IN THE FIELD OF PERSONAL FINANCIAL PLANNING (U.S. CLS. 100, 101 AND 107).

SN 76-169,285. FOREVER LIVING PRODUCTS INTERNATIONAL, INC., SCOTTSDALE, AZ. FILED 11-21-2000.

TEAM FLP

NO CLAIM IS MADE TO THE EXCLUSIVE RIGHT TO USE "TEAM", APART FROM THE MARK AS SHOWN. FOR EDUCATIONAL SERVICES, NAMELY PROVIDING SEMINARS AND INSTRUCTIONAL COURSES IN THE FIELD OF PROFESSIONAL SALES TECHNIQUES (U.S. CLS. 100, 101 AND 107).

CLASS 41—(Continued).

SN 76-169,786. PROSTATONLINE.COM, OVERLAND PARK, KS. FILED 11-21-2000.



NO CLAIM IS MADE TO THE EXCLUSIVE RIGHT TO USE "ONLINE", APART FROM THE MARK AS SHOWN. FOR EDUCATION SERVICES, NAMELY PROVIDING AN ONLINE SELF-GUIDED AND INTERACTIVE TUTORIAL TO USERS VIA THE GLOBAL COMPUTER NETWORK IN THE FIELDS OF HEALTHCARE AND PRACTICE MANAGEMENT FOR MEDICAL PRACTICES (U.S. CLS. 100, 101 AND 107). FIRST USE 3-15-2000; IN COMMERCE 3-15-2000.

SN 76-185,938. DISHER, JOHN THOMAS, SAN FRANCISCO, CA. FILED 12-22-2000.

sound creative

NO CLAIM IS MADE TO THE EXCLUSIVE RIGHT TO USE "SOUND", APART FROM THE MARK AS SHOWN. FOR RECORDING STUDIO PROVIDING A FULL SPECTRUM OF MUSIC COMPOSITION, SOUND DESIGN, NARRATION RECORDING, TECHNICAL SERVICES, AND AUDIO POST PRODUCTION SERVICES (U.S. CLS. 100, 101 AND 107). FIRST USE 8-2-2000; IN COMMERCE 8-2-2000.

SN 76-186,810. PHYSICIANS PRACTICE, INC., GLEN BURNIE, MD. FILED 12-26-2000.

PHYSICIANS PRACTICE.COM

OWNER OF U.S. REG. NO. 2,195,323. SEC. 2(F). FOR COMPUTER SERVICES, NAMELY PROVIDING ON-LINE MAGAZINES RELATING TO BUSINESS, MARKETING, FINANCIAL AND GENERAL PRACTICE MANAGEMENT FOR PHYSICIANS AND MEDICAL PERSONNEL VIA A GLOBAL COMPUTER NETWORK (U.S. CLS. 100, 101 AND 107).

CLASS 41—(Continued).

SN 76-188,362. CULINARY INSTITUTE OF AMERICA, HYDE PARK, NY. FILED 12-28-2000.

PROCHEF

FOR EDUCATIONAL SERVICES, NAMELY, CONDUCTING SEMINARS IN THE FIELD OF ADMINISTRATIVE AND CULINARY SKILLS IN THE FOOD SERVICE INDUSTRY FOR EXECUTIVE CHEFS (U.S. CLS. 100, 101 AND 107).

FIRST USE 7-0-2000; IN COMMERCE 7-0-2000.

SN 76-188,977. PROFESSIONAL COMPOUNDING CENTERS OF AMERICA, INC., HOUSTON, TX. FILED 1-3-2001.



OWNER OF U.S. REG. NOS. 1,252,120, 2,002,241 AND OTHERS.

NO CLAIM IS MADE TO THE EXCLUSIVE RIGHT TO USE "INSTITUTE" AND "PHARMACY E*LEARNING", APART FROM THE MARK AS SHOWN.

FOR EDUCATIONAL SERVICES, NAMELY PROVIDING COURSES IN THE FIELD OF PHARMACEUTICAL COMPOUNDING (U.S. CLS. 100, 101 AND 107).

FIRST USE 1-1-2000; IN COMMERCE 1-1-2000.

SN 76-192,261. COACHING STAFF, INC., THE, JACKSONVILLE, FL. FILED 1-10-2001.

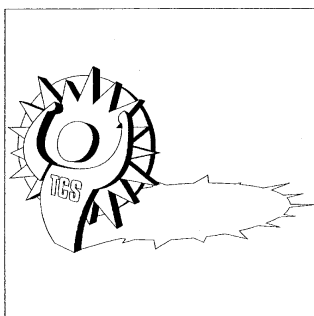

FOR EDUCATIONAL SERVICES, NAMELY CORPORATE TRAINING IN THE NATURE OF INTERACTIVE E-LEARNING OVER THE WORLDWIDE WEB COMBINING EDUCATION, MOTIVATION AND ENTERTAINMENT IN THE AREA OF SOFT SKILLS, NAMELY, MANAGEMENT, LEADERSHIP COMMUNICATIONS, TEAM BUILDING, SALES, MARKETING, HUMAN RESOURCES AND PERSONAL DEVELOPMENT (U.S. CLS. 100, 101 AND 107).

CLASS 41—(Continued).

SN 76-193,871. LINKIN PARK, BEVERLY HILLS, CA. FILED 1-12-2001.

LINKIN PARK

FOR ENTERTAINMENT SERVICES IN THE NATURE OF LIVE MUSICAL PERFORMANCES (U.S. CLS. 100, 101 AND 107).

FIRST USE 6-0-2000; IN COMMERCE 6-0-2000.

SN 76-198,989. PETER HUGHES DIVING, INC., MIAMI LAKES, FL. FILED 1-25-2001.

WORK HARD, DIVE EASY

FOR RECREATIONAL SERVICES IN THE NATURE OF SCUBA DIVING AND EDUCATIONAL SERVICES, NAMELY CONDUCTING CLASSES AND WORKSHOPS IN THE FIELD OF SCUBA DIVING (U.S. CLS. 100, 101 AND 107).

FIRST USE 12-1-1997; IN COMMERCE 12-1-1997.

SN 76-199,246. QUICKSTICK INTENSIVE LACROSSE CAMPS, INC., LANGHORNE, PA. FILED 1-25-2001.



NO CLAIM IS MADE TO THE EXCLUSIVE RIGHT TO USE "INTENSIVE LACROSSE CAMP", APART FROM THE MARK AS SHOWN.

FOR CONDUCTING CLASSES, CLINICS, CAMPS, AND SEMINARS IN THE FIELD OF LACROSSE (U.S. CLS. 100, 101 AND 107).

FIRST USE 1-13-1999; IN COMMERCE 6-23-1999.

SN 76-199,333. ATTENTION DEFICIT PRODUCTIONS, INC., LOS ANGELES, CA. FILED 1-25-2001.

SKETCH PAD

FOR ENTERTAINMENT SERVICES IN THE NATURE OF AN ONGOING TELEVISION PROGRAM FEATURING COMEDY (U.S. CLS. 100, 101 AND 107).

CLASS 41—(Continued).

SN 76-201,201. CJZ LLC, BALTIMORE, MD. FILED 1-29-2001.

RUNERVALS

FOR EDUCATIONAL SERVICES, NAMELY CONDUCTING WORKSHOPS, SEMINARS, CLASSES, LESSONS AND ATHLETIC TRAINING RELATED TO THE SPORT OF RUNNING AND TRIATHLON UTILIZING WORKOUT VIDEOS AND PERSONAL INSTRUCTION (U.S. CLS. 100, 101 AND 107).

FIRST USE 12-18-2000; IN COMMERCE 12-18-2000.

SN 76-204,021. NATIONAL PARK FOUNDATION, WASHINGTON, DC. FILED 2-2-2001.

EXPERIENCE YOUR AMERICA

NO CLAIM IS MADE TO THE EXCLUSIVE RIGHT TO USE "AMERICA", APART FROM THE MARK AS SHOWN, FOR CONDUCTING INFORMATIONAL SEMINARS, WORKSHOPS, LECTURES AND INTERACTIVE PROGRAMS RELATING TO NATIONAL PARKS, RECREATIONAL FACILITIES AND PUBLIC LANDS AND RESOURCES (U.S. CLS. 100, 101 AND 107).

SN 76-204,901. ST. OLAF COLLEGE, NORTHFIELD, MN. FILED 2-5-2001.

ST. OLAF CHOIR

OWNER OF U.S. REG. NOS. 2,193,738 AND 2,238,301. NO CLAIM IS MADE TO THE EXCLUSIVE RIGHT TO USE "CHOIR", APART FROM THE MARK AS SHOWN, FOR ENTERTAINMENT SERVICES, NAMELY, PRESENTING LIVE CHORAL CONCERTS (U.S. CLS. 100, 101 AND 107).

FIRST USE 9-1-1911; IN COMMERCE 3-1-1912.

SN 76-205,680. UNCLE BEN'S, INC., VERNON, CA. FILED 2-6-2001.

MASTERSPROGRAM

FOR TRAINING PROGRAMS, NAMELY, CLASSES, SEMINARS, AND LECTURES IN THE FIELDS OF FOOD SERVICES AND SALES TRAINING TOGETHER WITH ASSOCIATED MATERIALS (U.S. CLS. 100, 101 AND 107).

CLASS 41—(Continued).

SN 76-207,356. ARGOSY GAMING COMPANY, ALTON, IL. FILED 2-8-2001.

ARGOSYCASINOS.COM

OWNER OF U.S. REG. NOS. 1,928,190, 2,417,562 AND OTHERS.

FOR CASINO GAMING SERVICES (U.S. CLS. 100, 101 AND 107).

FIRST USE 1-17-2001; IN COMMERCE 1-17-2001.

SN 76-209,269. HERSKOVITZ, MARTIN, FREEDOM, PA. FILED 2-14-2001.

PARTY WITH MARTY

FOR DISC JOCKEY FOR PARTIES AND SPECIAL EVENTS (U.S. CLS. 100, 101 AND 107).

FIRST USE 0-0-1987; IN COMMERCE 0-0-1987.

SN 76-212,852. BRIDGE GROUP, INC., THE, BOSTON, MA. FILED 2-16-2001.

BRIDGESTAR

FOR EDUCATIONAL SERVICES, NAMELY CONDUCTING SEMINARS AND WORKSHOPS IN THE FIELDS OF COMMUNICATION AND LEADERSHIP SKILLS FOR NON-PROFIT ORGANIZATIONS (U.S. CLS. 100, 101 AND 107).

SN 76-215,067. TRIVANTIS CORPORATION, CINCINNATI, OH. FILED 2-26-2001.

TRIVANTIS.COM

FOR DEVELOPMENT AND DISSEMINATION OF EDUCATIONAL MATERIALS FOR CORPORATIONS AND EDUCATIONAL INSTITUTIONS BY MEANS OF THE GLOBAL COMPUTER NETWORK (U.S. CLS. 100, 101 AND 107).

FIRST USE 5-15-2000; IN COMMERCE 5-15-2000.

SN 76-217,079. IN TOUCH MINISTRIES, INC., ATLANTA, GA. FILED 2-28-2001.

PRAYER TOUCH

NO CLAIM IS MADE TO THE EXCLUSIVE RIGHT TO USE "PRAYER", APART FROM THE MARK AS SHOWN.

FOR SEMINARS, CONFERENCES, CLASSES, WORKSHOPS AND COURSES IN THE FIELDS OF SPIRITUALITY, RELIGION, ETHICS, SOCIAL ISSUES, AND LIFESTYLE, AND PRINTED EDUCATIONAL MATERIALS PROVIDED IN CONJUNCTION THEREWITH (U.S. CLS. 100, 101 AND 107).

CLASS 41—(Continued).

SN 76-218,255. FREEDOM OF INFORMATION FOUNDATION OF TEXAS, THE, DALLAS, TX. FILED 3-1-2001.

FOIFT

FOR EDUCATIONAL SERVICES, NAMELY, CONDUCTING CLASSES, SEMINARS, CONFERENCES, WORKSHOPS IN THE FIELD OF FIRST AMENDMENT ISSUES, THE ACCESSIBILITY OF GOVERNMENT AND PUBLIC RECORDS AND PRIVACY ISSUES RELATED TO GOVERNMENT AND PUBLIC RECORDS, DISTRIBUTING COURSE MATERIALS IN CONNECTION THEREWITH (U.S. CLS. 100, 101 AND 107).

FIRST USE 1-1-1984; IN COMMERCE 1-1-1984.

SN 76-220,912. EXILE PARK LTD., GRAND RAPIDS, MI. FILED 3-7-2001.



FOR ENTERTAINMENT, NAMELY, PRODUCTION OF MOTION PICTURES AND TELEVISION SHOWS; CUSTOM WRITING SERVICES; CONSULTING SERVICES REGARDING THE PRODUCTION OF MOTION PICTURES AND TELEVISION SHOWS OF OTHERS (U.S. CLS. 100, 101 AND 107).

SN 76-223,916. ESPN, INC., BRISTOL, CT. FILED 3-12-2001.

THE LIFE

FOR ENTERTAINMENT SERVICES IN THE NATURE OF AN ON-GOING TELEVISION PROGRAM FEATURING SPORTS INFORMATION AND INFORMATION ON INDIVIDUALS IN THE FIELD OF SPORTS (U.S. CLS. 100, 101 AND 107).

FIRST USE 12-25-2000; IN COMMERCE 12-25-2000.

SN 76-230,678. BUSINESS VENTURES, L.L.C., ST. LOUIS, MO. FILED 3-22-2001.

Student Choice Awards

NO CLAIM IS MADE TO THE EXCLUSIVE RIGHT TO USE "STUDENT" OR "AWARDS", APART FROM THE MARK AS SHOWN.

FOR ENTERTAINMENT IN THE NATURE OF INTERNATIONAL AWARD CEREMONY PROMOTING THE EXCELLANCE IN STUDENTS THROUGH THE ISSUANCE AND PRESENTATION OF AWARDS (U.S. CLS. 100, 101 AND 107).

FIRST USE 3-2-2001; IN COMMERCE 3-2-2001.

CLASS 41—(Continued).

SN 76-233,708. ANDRIANO, MARIA, NEW YORK, NY. FILED 3-30-2001.

BRING A YOGI TO WORK

FOR EDUCATIONAL AND TRAINING SERVICES, NAMELY, CONDUCTING COURSES, SEMINARS, WORKSHOPS, AND CONFERENCES IN THE FIELDS OF LEADERSHIP, PERSONAL AND PROFESSIONAL SUCCESS, SELF-AWARENESS, PERSONAL AWARENESS, SELF-IMPROVEMENT, SELF-HELP, SELF-FULFILLMENT, ENLIGHTENMENT, SELF-EMPOWERMENT, MEDITATION, METAPHYSICAL AND SPIRITUAL DISCOVERY, RELAXATION, HEALING TECHNIQUES, AND PHYSICAL NURTURING, AND DISTRIBUTION OF COURSE MATERIALS IN CONNECTION THEREWITH; YOGA INSTRUCTION (U.S. CLS. 100, 101 AND 107).

FIRST USE 11-0-2000; IN COMMERCE 12-0-2000.

SN 76-234,223. COX COMMUNICATIONS, INC., ATLANTA, GA. FILED 3-30-2001.

VIVA CALIFORNIA VIVA MEXICO

THE ENGLISH TRANSLATION OF "VIVA" IS "HOORAY".

FOR ENTERTAINMENT IN THE NATURE OF AN ON-GOING TELEVISION PROGRAM IN THE FIELD OF NEWS AND GENERAL INTEREST (U.S. CLS. 100, 101 AND 107).

SN 76-240,467. PRODUCTLINK.COM, LLC, AKRON, OH. FILED 4-16-2001.

MORE TRAINING - LESS TIME

FOR COMPUTER EDUCATIONAL SERVICES, NAMELY, PRODUCT AND SALES TRAINING SERVICES TO INDIVIDUALS ENGAGED IN THE FIELD OF SALES VIA THE GLOBAL COMPUTER NETWORKS (U.S. CLS. 100, 101 AND 107).

FIRST USE 2-10-2001; IN COMMERCE 2-10-2001.

SN 76-241,845. ST. JOE COMPANY, THE, JACKSONVILLE, FL. FILED 4-17-2001.

MONTEITH PARK

NO CLAIM IS MADE TO THE EXCLUSIVE RIGHT TO USE "PARK", APART FROM THE MARK AS SHOWN.

FOR PROVIDING FACILITIES FOR RECREATIONAL ACTIVITIES (U.S. CLS. 100, 101 AND 107).

CLASS 41—(Continued).

SN 76-247,226. ROSE, FORREST E., COLUMBIA, MO. FILED 4-27-2001.

PERFECT STRANGERS

FOR ENTERTAINMENT SERVICES, NAMELY, LIVE PERFORMANCES BY A MUSICAL BAND (U.S. CLS. 100, 101 AND 107).

FIRST USE 1-0-2000; IN COMMERCE 1-0-2000.

SN 76-250,643. UBS PAINWEBBER INC., WEEHAWKEN, NJ. FILED 5-3-2001.

MY ASSETS

FOR EDUCATION AND TRAINING SERVICES, NAMELY, PROVIDING CLASSES, SEMINARS, WORKSHOPS, AND TRAINING IN THE FIELD OF FINANCE, FINANCIAL INFORMATION AND DATA AGGREGATION (U.S. CLS. 100, 101 AND 107).

SN 76-256,826. LIVING FAITH MINISTRIES OF CAMDEN COUNTY, NEW JERSEY, INC., CHERRY HILL, NJ. FILED 5-14-2001.

FAITH SPEAKS MINISTRIES

NO CLAIM IS MADE TO THE EXCLUSIVE RIGHT TO USE "MINISTRIES", APART FROM THE MARK AS SHOWN.

FOR TELEVISION PROGRAMS IN THE FIELD OF EVANGELISTIC AND MINISTERIAL SERVICES (U.S. CLS. 100, 101 AND 107).

FIRST USE 4-3-2001; IN COMMERCE 4-3-2001.

SN 76-256,929. WEINMAN, RIC, TUCSON, AZ. FILED 5-14-2001.

VORTEXHEALING

OWNER OF U.S. REG. NO. 1,956,412.
FOR EDUCATIONAL SERVICES, NAMELY WORKSHOPS, COURSES, CONFERENCES AND SEMINARS IN THE FIELD OF PHYSICAL THERAPY SERVICES IN THE NATURE OF A HEALING BODYWORK TECHNIQUE THAT RELEASES PHYSICAL AND EMOTIONAL TENSIONS (U.S. CLS. 100, 101 AND 107).

FIRST USE 3-0-1995; IN COMMERCE 4-0-1995.

SN 76-257,030. HSN LP, ST. PETERSBURG, FL. FILED 5-15-2001.

THE CUTTING EDGE

FOR ENTERTAINMENT SERVICES IN THE NATURE OF A ON-GOING TELEVISION PROGRAM OFFERING ELECTRONICS PRODUCTS THAT CAN BE PURCHASED BY VIEWERS (U.S. CLS. 100, 101 AND 107).

CLASS 41—(Continued).

SN 76-263,625. BANGLA BIBLE CORRESPONDENCE INSTITUTE, GRAND RAPIDS, MI. FILED 5-29-2001.

**BANGLA MINISTRIES
WORLDWIDE**

NO CLAIM IS MADE TO THE EXCLUSIVE RIGHT TO USE "MINISTRIES WORLDWIDE", APART FROM THE MARK AS SHOWN.

FOR EDUCATION IN THE FIELD OF RELIGION IN CONNECTION WITH LITERATURE ON THE BIBLE RENDERED THROUGH CORRESPONDENCE COURSES (U.S. CLS. 100, 101 AND 107).

SN 76-265,322. KOWALCZYK, BARBARA A., ROCHESTER, NY. FILED 6-1-2001.



FOR EDUCATIONAL SERVICES NAMELY PROVIDING SEMINARS AND WORKSHOPS IN THE FIELD OF PROCESS IMPROVEMENT (U.S. CLS. 100, 101 AND 107).
FIRST USE 9-0-2000; IN COMMERCE 9-0-2000.

SN 76-271,580. HIGHMARK INC., PITTSBURGH, PA. FILED 6-14-2001.



NO CLAIM IS MADE TO THE EXCLUSIVE RIGHT TO USE "OSTEOPOROSIS PREVENTION AND EDUCATION PROGRAM", APART FROM THE MARK AS SHOWN.

FOR EDUCATIONAL SERVICES NAMELY CONDUCTING CLASSES AND SEMINARS AND WORKSHOPS IN THE FIELD OF OSTEOPOROSIS AND DISTRIBUTING COURSE MATERIALS THEREWITH (U.S. CLS. 100, 101 AND 107).

FIRST USE 4-1-1999; IN COMMERCE 4-1-1999.

CLASS 41—(Continued).

SN 76-272,830. WHITETAIL ADVENTURES, SNOW HILL, NC. FILED 6-18-2001.



NO CLAIM IS MADE TO THE EXCLUSIVE RIGHT TO USE "ADVENTURES", APART FROM THE MARK AS SHOWN.

THE STIPPLING IS FOR SHADING PURPOSES ONLY AND DOES NOT INDICATE COLOR.

FOR HUNTING GUIDE SERVICES (U.S. CLS. 100, 101 AND 107).

FIRST USE 10-0-1998; IN COMMERCE 10-0-1998.

SN 76-274,476. EN ROUTE ENTERTAINMENT, INC., WASHINGTON, DC. FILED 6-19-2001.

EN ROUTE ENTERTAINMENT

NO CLAIM IS MADE TO THE EXCLUSIVE RIGHT TO USE "ENTERTAINMENT", APART FROM THE MARK AS SHOWN.

FOR ENTERTAINMENT SERVICES, NAMELY RENTAL OF ENTERTAINMENT AND COMMUNICATION PLAYERS, AUDIO AND VIDEO TAPES, DVDS, DISCS, GAMES AND INTERNET ACCESS DEVICES TO TRAVELERS (U.S. CLS. 100, 101 AND 107).

SN 76-275,660. HOTEXAMS.COM, INC., EDISON, NJ. FILED 6-22-2001.

HOTEXAMS.COM

FOR ONLINE EDUCATIONAL SERVICES FOR STUDENTS, NAMELY, PROVIDING ONLINE PRACTICE TESTS AND TEST PREPARATION FOR PROFESSIONAL ENTRANCE EXAMS, CERTIFICATION EXAMS, COLLEGE ENTRANCE EXAMS AND POST GRADUATE ENTRANCE EXAMS; ON-LINE TUTORING IN THE AREA OF TEST PREPARATION (U.S. CLS. 100, 101 AND 107).

FIRST USE 4-13-2000; IN COMMERCE 4-13-2000.

CLASS 41—(Continued).

SN 76-283,189. ASSOCIATION TO PRESERVE THE EATONVILLE COMMUNITY, INC., THE, EATONVILLE, FL. FILED 7-11-2001.



THE MARK DOES NOT IDENTIFY A LIVING INDIVIDUAL.

FOR EDUCATIONAL AND ENTERTAINMENT SERVICES, NAMELY, ORGANIZING AND CONDUCTING ART, HISTORICAL AND CULTURAL EXHIBITIONS FEATURING A VARIETY OF ACTIVITIES, NAMELY, THE DISPLAY AND SALE OF WORKS OF ART OF OTHERS, MUSICAL CONCERTS, PUBLIC TALKS, ACADEMIC FORUMS, DRAMATIC PRESENTATIONS, DANCE PRESENTATIONS, FOOD AND MERCHANDISE SALES BY VENDORS (U.S. CLS. 100, 101 AND 107).

FIRST USE 1-0-1990; IN COMMERCE 1-0-1990.

SN 76-283,842. GAIL SAMUELSON, DBA SPA FOR THE SPIRIT, SIGNAL HILL, CA. FILED 7-13-2001.

SPA FOR THE SPIRIT

FOR EDUCATIONAL SERVICES, NAMELY CONDUCTING SEMINARS, CONFERENCES, AND WORKSHOPS IN THE FIELD OF SELF-HELP, SELF-ASSURANCE, AND MOTIVATION, AND IN THE PROVISION OF COURSE MATERIALS IN CONNECTION THEREWITH (U.S. CLS. 100, 101 AND 107).

FIRST USE 7-6-2001; IN COMMERCE 7-6-2001.

SN 76-291,208. NEW ORLEANS JAZZ & HERITAGE FOUNDATION, INC., NEW ORLEANS, LA. FILED 7-26-2001.

NEW ORLEANS JAZZ & HERITAGE FESTIVAL

OWNER OF U.S. REG. NO. 2,424,393.

NO CLAIM IS MADE TO THE EXCLUSIVE RIGHT TO USE "JAZZ & HERITAGE FESTIVAL", APART FROM THE MARK AS SHOWN.

SEC. 2(F).

FOR ENTERTAINMENT SERVICES IN THE NATURE OF A MUSIC AND CULTURAL HERITAGE FESTIVAL (U.S. CLS. 100, 101 AND 107).

FIRST USE 1-1-1970; IN COMMERCE 1-1-1970.

CLASS 41—(Continued).

SN 76-294,254. NINA BROWNFIELD-BERRY, LOS ANGELES, CA. FILED 8-6-2001.

WHIRLIEGIRL PRODUCTIONS

NO CLAIM IS MADE TO THE EXCLUSIVE RIGHT TO USE "PRODUCTIONS", APART FROM THE MARK AS SHOWN.

FOR INDEPENDENT MOTION PICTURE FILM PRODUCTION (U.S. CLS. 100, 101 AND 107).

FIRST USE 7-23-2001; IN COMMERCE 7-23-2001.

SN 76-296,991. DIROCCO, SUSAN, BRAINTREE, MA. AND MACPHERSON, CATHY L., NEWBURYPORT, MA. FILED 8-9-2001.

PLAY THROUGH

FOR EDUCATION SERVICES IN THE NATURE OF A GOLF CLINIC IN WHICH BOTH GOLF AND MEDICAL PROFESSIONALS ANALYZE INDIVIDUAL'S NOTION AND GOLF SWINGS TO DEVELOP A PERSONALIZED PROGRAM DESIGNED TO IMPROVE THE INDIVIDUAL'S SWING AND FITNESS FOR GOLF (U.S. CLS. 100, 101 AND 107).

SN 76-300,408. ALLIANCE FRANCAISE, PARIS, FRANCE, FILED 8-17-2001.

AF

FOR EDUCATIONAL SERVICES, NAMELY CONDUCTING COURSES IN FRENCH AND FRENCH CULTURE (U.S. CLS. 100, 101 AND 107).

FIRST USE 9-0-2000; IN COMMERCE 9-0-2000.

SN 76-300,721. RIVERDEEP INTERACTIVE LEARNING LTD., DUBLIN 2, IRELAND, FILED 8-16-2001.

NOOTLE

FOR EDUCATIONAL SERVICES, NAMELY, PROVIDING COURSES OF INSTRUCTION IN THE FIELD OF MATHEMATICS AT THE PRIMARY AND SECONDARY EDUCATIONAL LEVELS VIA A GLOBAL COMPUTER NETWORK DISTRIBUTING PRINTED MATERIALS AND CD-ROMS IN CONNECTION THEREWITH (U.S. CLS. 100, 101 AND 107).

CLASS 41—(Continued).

SN 76-301,910. HEALTHSOUTH CORPORATION, BIRMINGHAM, AL. FILED 8-17-2001.



NO CLAIM IS MADE TO THE EXCLUSIVE RIGHT TO USE "TV", APART FROM THE MARK AS SHOWN.

FOR ENTERTAINMENT IN THE NATURE OF ONGOING TELEVISION PROGRAMS IN THE FIELD OF CHILDREN'S HEALTH AND FITNESS (U.S. CLS. 100, 101 AND 107).

SN 76-305,423. DAYTON PROFESSIONAL BASEBALL CLUB, LLC, DAYTON, OH. FILED 8-27-2001.



OWNER OF U.S. REG. NOS. 2,385,665 AND 2,399,983.

THE MARK CONSISTS OF A STYLIZED REPRESENTATION OF A PERSON COSTUMED AS A DRAGON WEARING A BASEBALL UNIFORM. THE DOTTED LINES OF THE BASEBALL AND THE BASEBALL GLOVE ARE NOT PART OF THE MARK.

FOR ENTERTAINMENT SERVICES IN THE NATURE OF A TEAM MASCOT FOR A PROFESSIONAL BASEBALL TEAM, PUBLIC APPEARANCES BY A MASCOT, BOTH LIVE AND VIA BROADCAST OVER TELEVISION, CABLE, SATELLITE AND/OR WORLDWIDE WEB (U.S. CLS. 100, 101 AND 107).

FIRST USE 5-3-2000; IN COMMERCE 5-3-2000.

CLASS 41—(Continued).

SN 76-309,597. DISCOVERY COMMUNICATIONS, INC., BETHESDA, MD. FILED 9-6-2001.

ADRENALINE RUSH HOUR

NO CLAIM IS MADE TO THE EXCLUSIVE RIGHT TO USE "HOUR", APART FROM THE MARK AS SHOWN. FOR ENTERTAINMENT SERVICES IN THE NATURE OF A SERIES OF NON-FICTION TELEVISION PROGRAMS (U.S. CLS. 100, 101 AND 107).
FIRST USE 1-28-1998; IN COMMERCE 1-28-1998.

SN 76-311,191. MEETING EXPECTATIONS, INC., UPPER MONTCLAIR, NJ. FILED 9-12-2001.

**THE MEETING
PRESCRIPTION**

NO CLAIM IS MADE TO THE EXCLUSIVE RIGHT TO USE "MEETING", APART FROM THE MARK AS SHOWN. FOR PLANNING, ORGANIZING, AND CONDUCTING CONVENTIONS, CONFERENCES, SEMINARS, EVENTS AND MEETINGS IN THE FIELD OF MEDICINE AND PHARMACEUTICALS (U.S. CLS. 100, 101 AND 107).

SN 76-312,457. HANKS-LIVINGSTON, INC., JACKSONVILLE, FL. FILED 9-17-2001.

SPEAKERS FOR LIFE

NO CLAIM IS MADE TO THE EXCLUSIVE RIGHT TO USE "SPEAKERS", APART FROM THE MARK AS SHOWN. FOR EDUCATIONAL AND ENTERTAINMENT SERVICES, NAMELY, PROVIDING MOTIVATIONAL AND EDUCATIONAL SPEAKERS AND LECTURERS FOR SPEAKING ENGAGEMENTS (U.S. CLS. 100, 101 AND 107).
FIRST USE 9-5-2001; IN COMMERCE 9-5-2001.

SN 76-312,954. DAKTRONICS, INC., BROOKINGS, SD. FILED 9-17-2001.

SPORTSLINK

FOR RENTAL OF LARGE SCREEN VIDEO AND ELECTRONIC DISPLAYS (U.S. CLS. 100, 101 AND 107).
FIRST USE 4-30-1996; IN COMMERCE 4-30-1996.

CLASS 41—(Continued).

SN 76-315,264. MERCK & CO., INC., WHITEHOUSE STATION, NJ. FILED 9-21-2001.



NO CLAIM IS MADE TO THE EXCLUSIVE RIGHT TO USE "THERAPY", APART FROM THE MARK AS SHOWN. FOR EDUCATIONAL SERVICES, NAMELY, CONDUCTING SYMPOSIUMS ON ANTI-INFECTIVES (U.S. CLS. 100, 101 AND 107).

SN 76-315,425. THOMAS, DAVID L., OKLAHOMA CITY, OK. FILED 9-21-2001.

THE WORLD OF MAGIC

NO CLAIM IS MADE TO THE EXCLUSIVE RIGHT TO USE "MAGIC", APART FROM THE MARK AS SHOWN. FOR ENTERTAINMENT SERVICES IN THE NATURE OF MAGIC SHOWS (U.S. CLS. 100, 101 AND 107).
FIRST USE 6-1-2001; IN COMMERCE 6-1-2001.

SN 76-315,688. BRINER, NATHAN I., SANDY, UT. FILED 9-21-2001.

EIGHT O' ONE

FOR ENTERTAINMENT IN THE NATURE OF VISUAL, AUDIO AND LIVE PERFORMANCES BY A MUSICAL BAND (U.S. CLS. 100, 101 AND 107).

SN 76-316,759. BAYLESS, THOMAS H., CORONADO, CA. AND MCBRATNEY, MAURA E., CORONADO, CA. FILED 9-24-2001.

CONNECTIONS FOR LIFE

FOR PERSONAL COACHING IN THE FIELD OF PERSONAL AND BUSINESS DEVELOPMENT (U.S. CLS. 100, 101 AND 107).
FIRST USE 6-25-2001; IN COMMERCE 6-25-2001.

CLASS 41—(Continued).

SN 76-323,045. CINCINNATI BENGALS, INC., CINCINNATI, OH. FILED 10-9-2001.

WHO DEY

FOR EDUCATION AND ENTERTAINMENT SERVICES IN THE NATURE OF PROFESSIONAL FOOTBALL GAMES AND EXHIBITIONS; PROVIDING SPORTS AND ENTERTAINMENT INFORMATION VIA A GLOBAL COMPUTER NETWORK OR A COMMERCIAL ON-LINE SERVICE; ORGANIZATION OF SPORTS EVENTS; FAN CLUB SERVICES; EDUCATIONAL SERVICES, NAMELY, PHYSICAL EDUCATION PROGRAMS; ENTERTAINMENT SERVICES, NAMELY, MUSICAL AND DANCE PERFORMANCES PROVIDED DURING INTERVALS AT SPORTS EVENTS; PRODUCTION OF RADIO AND TELEVISION PROGRAMS, LIVE SHOWS FEATURING FOOTBALL GAMES, EXHIBITIONS, COMPETITIONS AND MUSICAL, COMEDY AND DANCE PERFORMANCES, FESTIVALS AND EVENTS FOR FANS OF A PROFESSIONAL FOOTBALL TEAM; ENTERTAINMENT SERVICES IN THE NATURE OF A TEAM MASCOT FOR A PROFESSIONAL FOOTBALL TEAM; PUBLIC APPEARANCES BY A MASCOT, BOTH LIVE AND VIA BROADCAST OVER TELEVISION, CABLE, SATELLITE AND/OR WORLDWIDE WEB (U.S. CLS. 100, 101 AND 107).

SN 76-325,048. ENCORE PHOTO, INC., SARASOTA, FL. FILED 10-15-2001.

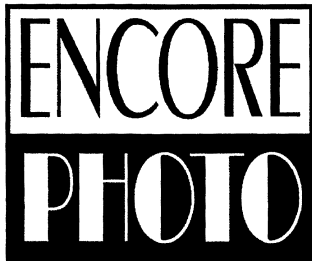

NO CLAIM IS MADE TO THE EXCLUSIVE RIGHT TO USE "PHOTO", APART FROM THE MARK AS SHOWN. FOR PORTRAIT PHOTOGRAPHY SERVICES FOR SCHOOL, SPORTS AND SPECIAL EVENTS (U.S. CLS. 100, 101 AND 107). FIRST USE 9-1-1986; IN COMMERCE 9-1-1986.

CLASS 41—(Continued).

SN 76-325,242. MILLS LIMITED PARTNERSHIP, THE, ARLINGTON, VA. FILED 10-15-2001.



NO CLAIM IS MADE TO THE EXCLUSIVE RIGHT TO USE "GEORGIA" OR THE REPRESENTATION OF THE MAP OF GEORGIA, APART FROM THE MARK AS SHOWN.

FOR ENTERTAINMENT SERVICES IN THE NATURE OF PROMOTING GEORGIA HISTORY AND HONORING FAMOUS PERSONS WHO WERE BORN IN OR LIVED IN GEORGIA BY MEANS OF DISPLAYS AND EXHIBITS LOCATED IN A SHOPPING CENTER (U.S. CLS. 100, 101 AND 107).

SN 76-325,334. CYPRESS POINT CLUB, PEBBLE BEACH, CA. FILED 10-15-2001.

CYPRESS POINT CLUB

NO CLAIM IS MADE TO THE EXCLUSIVE RIGHT TO USE "CLUB", APART FROM THE MARK AS SHOWN. FOR GOLF CLUB SERVICES (U.S. CLS. 100, 101 AND 107).

FIRST USE 0-0-1928; IN COMMERCE 0-0-1928.

SN 76-325,340. AF2 ENTERPRISES LLC, CHICAGO, IL. FILED 10-15-2001.



NO CLAIM IS MADE TO THE EXCLUSIVE RIGHT TO USE "WILKES-BARRE/SCRANTON", APART FROM THE MARK AS SHOWN.

FOR ENTERTAINMENT SERVICES, NAMELY ORGANIZING AND PRESENTING FOOTBALL GAMES BEFORE LIVE AUDIENCES AND ON TELEVISION, RADIO, FOR GLOBAL COMPUTER NETWORK DISPLAY AND OTHER MEDIA (U.S. CLS. 100, 101 AND 107).

CLASS 41—(Continued).

SN 76-326,276. ANCHOR GAMING, LAS VEGAS, NV. FILED 10-17-2001.

CLASS 41—(Continued).

SN 76-332,936. DYNAMIC SKATING, LTD., MIDDLETON, MA. FILED 10-30-2001.

MAX 5

FOR LOTTERY AND LOTTO GAME SERVICES (U.S. CLS. 100, 101 AND 107).

POWER ON ICE

FOR EDUCATIONAL SERVICES, NAMELY, ICE HOCKEY INSTRUCTION (U.S. CLS. 100, 101 AND 107).

SN 76-328,470. YANKS AIR MUSEUM, CHINO, CA. FILED 10-22-2001.



NO CLAIM IS MADE TO THE EXCLUSIVE RIGHT TO USE "USA" AND "AIR MUSEUM", APART FROM THE MARK AS SHOWN.

FOR MUSEUM DEDICATED TO AIR FLIGHT (U.S. CLS. 100, 101 AND 107).
FIRST USE 10-0-1991; IN COMMERCE 10-0-1991.

SN 76-333,795. EAST TEXAS YAMBOREE CORPORATION, GILMER, TX. FILED 11-2-2001.

YAMBOREE

OWNER OF U.S. REG. NO. 2,399,898.
FOR ORGANIZING AND CONDUCTING AN ANNUAL COUNTY FAIR (U.S. CLS. 100, 101 AND 107).
FIRST USE 10-0-1935; IN COMMERCE 10-0-1935.

SN 76-329,698. DEKKO FOUNDATION, THE, KENDALLVILLE, IN. FILED 10-25-2001.

ALL WRITE!!!

FOR EDUCATIONAL SERVICES, NAMELY CONDUCTING SEMINARS, CONFERENCES, AND WORKSHOPS IN THE FIELD OF LANGUAGE ARTS, AND DISTRIBUTING COURSE MATERIALS THEREWITH (U.S. CLS. 100, 101 AND 107).
FIRST USE 8-0-1999; IN COMMERCE 10-0-1999.

SN 76-334,397. SUMMITT MANAGEMENT CORPORATION, MEMPHIS, TN. FILED 11-7-2001.

SOUTHERN HERITAGE CLASSIC

SN 76-332,262. EDWARDS THEATRES, INC., NEWPORT BEACH, CA. FILED 10-29-2001.

GET THE BIG PICTURE

FOR ENTERTAINMENT SERVICES, NAMELY MOVIE THEATERS AND CINEMAS (U.S. CLS. 100, 101 AND 107).

OWNER OF U.S. REG. NO. 1,937,171.
NO CLAIM IS MADE TO THE EXCLUSIVE RIGHT TO USE "CLASSIC", APART FROM THE MARK AS SHOWN.
FOR ENTERTAINMENT SERVICES IN THE NATURE OF AN ANNUAL CULTURAL CELEBRATION CONSISTING OF AN ANNUAL FOOTBALL GAME, GOLF TOURNAMENT, MUSICAL ENTERTAINMENT, AND FASHION SHOW (U.S. CLS. 100, 101 AND 107).
FIRST USE 9-1-1990; IN COMMERCE 9-1-1990.

CLASS 41—(Continued).

SN 76-334,691. SUMMITT MANAGEMENT CORPORATION, MEMPHIS, TN. FILED 11-7-2001.



OWNER OF U.S. REG. NO. 1,937,171.
NO CLAIM IS MADE TO THE EXCLUSIVE RIGHT TO USE "CLASSIC", APART FROM THE MARK AS SHOWN.
THE LINING IS FOR SHADING PURPOSES ONLY.
FOR ENTERTAINMENT SERVICES IN THE NATURE OF AN ANNUAL CULTURAL CELEBRATION CONSISTING OF AN ANNUAL FOOTBALL GAME, GOLF TOURNAMENT, MUSICAL ENTERTAINMENT, AND FASHION SHOW (U.S. CLS. 100, 101 AND 107).
FIRST USE 9-1-1990; IN COMMERCE 9-1-1990.

SN 76-336,157. HOWARD COUNTY ECONOMIC DEVELOPMENT AUTHORITY, COLUMBIA, MD. FILED 11-9-2001.

TECHENTRE

FOR EDUCATIONAL SERVICES, NAMELY, CONDUCTING CLASSES IN THE FIELD OF BUSINESS (U.S. CLS. 100, 101 AND 107).
FIRST USE 10-16-2001; IN COMMERCE 10-16-2001.

SN 76-336,524. HONDROGEN, ALTHEA CALIOPE, SAN FRANCISCO, CA. FILED 11-9-2001.

DEFY GRAVITY

FOR PROVIDING FITNESS, EXERCISE AND SPORTS FACILITIES; PHYSICAL FITNESS INSTRUCTION; PHYSICAL EDUCATION SERVICES; PERSONAL TRAINING SERVICES, NAMELY, STRENGTH AND CONDITIONING TRAINING; PERSONAL TRAINER SERVICES; HEALTH CLUB SERVICES; EDUCATIONAL SERVICES, NAMELY, CONDUCTING CLASSES IN THE FIELD OF FITNESS AND EXERCISE AND DISTRIBUTING COURSE MATERIALS IN CONNECTION THEREWITH (U.S. CLS. 100, 101 AND 107).
FIRST USE 1-2-1997; IN COMMERCE 1-2-1997.

CLASS 41—(Continued).

SN 76-339,209. AF2 ENTERPRISES, LLC, CHICAGO, IL. FILED 11-19-2001.

MOHEGAN WOLVES

NO CLAIM IS MADE TO THE EXCLUSIVE RIGHT TO USE "MOHEGAN", APART FROM THE MARK AS SHOWN.
FOR ENTERTAINMENT SERVICES, NAMELY ORGANIZING AND PRESENTING FOOTBALL GAMES BEFORE LIVE AUDIENCES AND ON TELEVISION, RADIO, FOR GLOBAL COMPUTER NETWORK DISPLAY AND OTHER MEDIA (U.S. CLS. 100, 101 AND 107).

SN 76-342,111. ESPN, INC., BRISTOL, CT. FILED 11-26-2001.

PARDON THE INTERRUPTION

FOR ENTERTAINMENT SERVICES, NAMELY, AN ONGOING TELEVISION PROGRAM ON THE SUBJECT OF SPORTS (U.S. CLS. 100, 101 AND 107).
FIRST USE 10-17-2001; IN COMMERCE 10-17-2001.

SN 76-342,239. BIG HORN PRODUCTIONS/CABLE RADIO NETWORK, INC., SUNLAND, CA. FILED 11-27-2001.

CABLETALK

FOR ENTERTAINMENT SERVICES, NAMELY RADIO TALK SHOW SERVICES (U.S. CLS. 100, 101 AND 107).
FIRST USE 4-0-1983; IN COMMERCE 4-0-1983.

SN 76-343,408. YELLOW YOUSE PRODUCTION COMPANY LLC, THE, THOMASTON, CT. FILED 12-3-2001.

THE SUNSHINE ROAD

FOR ENTERTAINMENT SERVICES, NAMELY THE PRODUCTION AND PERFORMANCE OF LIVE MUSICAL SHOWS (U.S. CLS. 100, 101 AND 107).
FIRST USE 1-1-1998; IN COMMERCE 9-1-1998.

SN 76-345,107. PEACEMAKERS UNLIMITED, INC., RICHARDSON, TX. FILED 12-5-2001.

WORKING TO MAKE THE WORLD WORTHY OF ITS CHILDREN

FOR TRAINING IN MEDIATION AND NEGOTIATION SKILLS TO ASSIST IN CONFLICT RESOLUTION BETWEEN PEERS, CO-WORKERS, FAMILY AND FRIENDS (U.S. CLS. 100, 101 AND 107).

CLASS 41—(Continued).

SN 76-345,108. PEACEMAKERS UNLIMITED, INC., RICHARDSON, TX. FILED 12-5-2001.

SUN PEACE

FOR YOUTH SERVICES PROGRAMS, NAMELY TRAINING IN MEDIATION AND NEGOTIATION SKILLS TO ASSIST PEERS IN CONFLICT RESOLUTION (U.S. CLS. 100, 101 AND 107).

SN 76-345,109. PEACEMAKERS UNLIMITED, INC., RICHARDSON, TX. FILED 12-5-2001.

PAX UNITED

FOR TRAINING IN MEDIATION AND NEGOTIATION SKILLS TO ASSIST IN CONFLICT RESOLUTION BETWEEN PEERS, CO-WORKERS, FAMILY AND FRIENDS (U.S. CLS. 100, 101 AND 107).

SN 76-346,901. LEAPFROG ENTERPRISES, INC., EMERYVILLE, CA. FILED 12-7-2001.

LEAPTRACK

FOR EDUCATIONAL INFORMATION SERVICES FOR EDUCATORS, PARENTS AND CHILDREN, NAMELY, PROVIDING INFORMATION ON ACADEMIC SUBJECTS AND STATE GRADE AND MIDDLE SCHOOL ACADEMIC STANDARDS IN THE FIELDS OF ACADEMIC TESTING AND IN LANGUAGE ARTS, SCIENCE, SOCIAL SCIENCES, AND MATH (U.S. CLS. 100, 101 AND 107).

SN 76-347,939. REAL 101, INC., THE, NEW YORK, NY. FILED 12-13-2001.



FOR ENTERTAINMENT SERVICES IN THE NATURE OF PERFORMANCES BY A LIVE MUSICAL GROUP (U.S. CLS. 100, 101 AND 107).
FIRST USE 6-10-2001; IN COMMERCE 6-10-2001.

CLASS 41—(Continued).

SN 76-349,113. DESERT TROON LIMITED, LLC, SCOTTSDALE, AZ. FILED 12-17-2001.

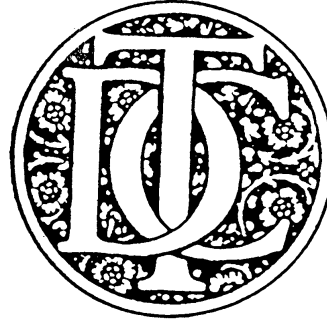

FOR GOLF COURSES AND GOLF CLUB SERVICES (U.S. CLS. 100, 101 AND 107).
FIRST USE 3-1-1989; IN COMMERCE 3-1-1989.

SN 76-350,999. KC PUBLICATIONS INC., LAS VEGAS, NV. FILED 12-20-2001.

KC PUBLICATIONS

NO CLAIM IS MADE TO THE EXCLUSIVE RIGHT TO USE "PUBLICATIONS", APART FROM THE MARK AS SHOWN.

FOR PUBLICATION OF HARD COVER AND SOFT COVER BOOKS (U.S. CLS. 100, 101 AND 107).
FIRST USE 0-0-1964; IN COMMERCE 0-0-1977.

SN 78-024,618. NATIONAL YOUTH SPORTS PROGRAM FUND, THE, INDIANAPOLIS, IN. FILED 9-6-2000.

NATIONAL YOUTH SPORTS CORPORATION

OWNER OF U.S. REG. NO. 2,057,009.
SEC. 2(F).

FOR ATHLETIC INSTRUCTION, NAMELY, TEACHING AND SUPERVISING CHILDREN IN BASKETBALL, FOOTBALL, TENNIS, SOFTBALL, TRACK AND FIELD, SOCCER, VOLLEYBALL, DANCE, AEROBICS, BADMINTON, GYMNASTICS, WRESTLING AND OTHER SPORTS; AND EDUCATIONAL SERVICES, NAMELY, CONDUCTING SEMINARS AND WORKSHOPS IN THE FIELD OF DRUG AND ALCOHOL ABUSE PREVENTION, NUTRITION, PERSONAL HEALTH, CAREER OPPORTUNITIES, JOB RESPONSIBILITIES, HIGHER EDUCATION OPPORTUNITIES AND CAREERS, COMMUNITY INVOLVEMENT, AND OTHER LIFE SKILLS (U.S. CLS. 100, 101 AND 107).

CLASS 41—(Continued).

SN 78-031,647. CARSON INTERNATIONAL, INC., KETCHUM, ID. FILED 10-20-2000.

TRIPLE CROWN OF DOG SHOWS

NO CLAIM IS MADE TO THE EXCLUSIVE RIGHT TO USE "DOG SHOWS", APART FROM THE MARK AS SHOWN.

FOR ENTERTAINMENT SERVICES IN THE NATURE OF CANINE SHOWS (U.S. CLS. 100, 101 AND 107).

SN 78-038,729. FENSTER, LLC, COLUMBUS, OH. FILED 12-11-2000.

FENSTER

FOR ENTERTAINMENT SERVICES IN THE NATURE OF A LIVE PERFORMANCE MUSICAL GROUP (U.S. CLS. 100, 101 AND 107).

FIRST USE 8-1-1997; IN COMMERCE 8-10-1997.

SN 78-041,663. CAHN, JERRY, NEW YORK CITY, NY. FILED 1-4-2001.

THE CORPORATE BUGLE

NO CLAIM IS MADE TO THE EXCLUSIVE RIGHT TO USE "CORPORATE", APART FROM THE MARK AS SHOWN.

FOR PUBLICATION OF ONLINE CORPORATE NEWSLETTERS FOR OTHERS (U.S. CLS. 100, 101 AND 107).
FIRST USE 5-30-2001; IN COMMERCE 10-9-2001.

SN 78-042,836. KRELL RECORDS PTY. LTD., PORT VILLA, VANUATU, FILED 1-11-2001.

D.R.E.E.M. ANGELS

FOR ENTERTAINMENT SERVICES, NAMELY, PRODUCTION OF TELEVISION AND RADIO PROGRAMS, ANIMATED AND LIVE ACTION TELEVISION SERIES, AND THEATRICAL PRODUCTIONS; AUDIO RECORDING AND PRODUCTION; VIDEO RECORDING AND PRODUCTION; MOTION PICTURE FILM PRODUCTION; MUSIC VIDEO PRODUCTION; AND LIVE PERFORMANCES BY A MUSICAL GROUP (U.S. CLS. 100, 101 AND 107).

CLASS 41—(Continued).

SN 78-042,841. KRELL RECORDS PTY. LTD., PORT VILLA, VANUATU, FILED 1-11-2001.

D.R.E.E.M. VOYAGERS

FOR ENTERTAINMENT SERVICES, NAMELY, PRODUCTION OF TELEVISION AND RADIO PROGRAMS, ANIMATED AND LIVE ACTION TELEVISION SERIES, AND THEATRICAL PRODUCTIONS; AUDIO RECORDING AND PRODUCTION; VIDEO RECORDING AND PRODUCTION; MOTION PICTURE FILM PRODUCTION; MUSIC VIDEO PRODUCTION; AND LIVE PERFORMANCES BY A MUSICAL GROUP (U.S. CLS. 100, 101 AND 107).

SN 78-045,477. PRODEV, SAN DIEGO, CA. FILED 1-29-2001.



NO CLAIM IS MADE TO THE EXCLUSIVE RIGHT TO USE "PRODEV", APART FROM THE MARK AS SHOWN.

FOR EDUCATIONAL SERVICES, NAMELY, PROVIDING COURSES OF INSTRUCTION, CLASSES, SEMINARS, CONFERENCES, WORKSHOPS AND COURSE MATERIAL AT THE COLLEGE, GRADUATE, POST-GRADUATE AND CONTINUING EDUCATION LEVEL (U.S. CLS. 100, 101 AND 107).

SN 78-045,492. MCATLIN, DAVID WILLIAM, LAKE HAVASU CITY, AZ. FILED 1-29-2001.



NO CLAIM IS MADE TO THE EXCLUSIVE RIGHT TO USE ".COM", APART FROM THE MARK AS SHOWN.

FOR PROVIDING A WEBSITE FEATURING INFORMATION IN THE FIELD OF MOTOR SPORTS VIA THE INTERNET (U.S. CLS. 100, 101 AND 107).

CLASS 41—(Continued).

SN 78-048,093. CIAO PRODUCTIONS INTERNATIONAL, INC., LOS ANGELES, CA. FILED 2-13-2001.

POP-N-JAZZ Y MUCHO MAS

NO CLAIM IS MADE TO THE EXCLUSIVE RIGHT TO USE "POP" AND "JAZZ", APART FROM THE MARK AS SHOWN.

THE ENGLISH TRANSLATION OF "Y MUCHO MAS" IS "AND MUCH MORE".

FOR ENTERTAINMENT, NAMELY PRODUCTION OF MUSICAL CONCERTS, ARRANGING AND CONDUCTING SONG-WRITING COMPETITIONS AND SONG FESTIVALS (U.S. CLS. 100, 101 AND 107).

FIRST USE 0-0-1989; IN COMMERCE 12-0-1998.

SN 78-048,956. CREATIVE PLANNING INTERNATIONAL, INC., SILVER SPRING, MD. FILED 2-18-2001.

LINKS TO SUCCESS

FOR TRAINING SERVICES, NAMELY, PROVIDING COURSES, SEMINARS AND WORKSHOPS ON THE SUBJECTS OF BUSINESS ETIQUETTE AND PROTOCOL, PARTICULARLY AS APPLIED TO BUSINESS GOLF AND ENTERTAINING, AND CONSULTATION SERVICES IN CONNECTION THEREWITH (U.S. CLS. 100, 101 AND 107).

FIRST USE 9-4-2000; IN COMMERCE 11-1-2000.

SN 78-049,079. FRANCO'S ATHLETIC CLUB, INC., MANDEVILLE, LA. FILED 2-19-2001.

FIT NOT PERFECT

FOR HEALTH, FITNESS, AND ATHLETIC CLUB SERVICES (U.S. CLS. 100, 101 AND 107).

FIRST USE 1-1-1995; IN COMMERCE 1-1-1995.

SN 78-049,516. FANATIC SPORTS NETWORK, INC., OMAHA, NE. FILED 2-21-2001.



NO CLAIM IS MADE TO THE EXCLUSIVE RIGHT TO USE "SPORTS", APART FROM THE MARK AS SHOWN.

FOR ORGANIZING AND CONDUCTING FANTASY SPORTS CONTESTS AND SWEEPSTAKES (U.S. CLS. 100, 101 AND 107).

CLASS 41—(Continued).

SN 78-059,327. CANADIAN (21) STOOK LTD., RED DEER, ALBERTA, CANADA, FILED 4-19-2001.

CANADIAN 21 STOOK

NO CLAIM IS MADE TO THE EXCLUSIVE RIGHT TO USE "CANADIAN 21", APART FROM THE MARK AS SHOWN.

FOR ENTERTAINMENT SERVICES, NAMELY PROVIDING LIVE CASINO AND/OR GAMING ENVIRONMENT GAMES IN THE NATURE OF A GAME OF CHANCE PLAYED WITH PLAYING CARDS (U.S. CLS. 100, 101 AND 107).

SN 78-064,935. BLUE WORLD PRODUCTIONS, INC., DRIPPING SPRINGS, TX. FILED 5-22-2001.



FOR ENTERTAINMENT IN THE NATURE OF LIVE MUSICAL PERFORMANCES; ENTERTAINMENT IN THE NATURE OF PRODUCTION OF LIVE MUSICAL PERFORMANCES (U.S. CLS. 100, 101 AND 107).

FIRST USE 1-1-2001; IN COMMERCE 1-1-2001.

SN 78-066,341. HAYES, MILTON, DEERFIELD BEACH, FL. FILED 5-30-2001.

CRITICAL RECORDS

NO CLAIM IS MADE TO THE EXCLUSIVE RIGHT TO USE "RECORDS", APART FROM THE MARK AS SHOWN.

FOR AUDIO RECORDING AND PRODUCTION IN THE NATURE OF RECORDING AND PRODUCING RECORDS AND COMPACT DISCS (U.S. CLS. 100, 101 AND 107).

SN 78-074,517. FARNER, MARK, PETOSKEY, MI. FILED 7-18-2001.

FLINT

FOR ENTERTAINMENT SERVICES, NAMELY, LIVE PERFORMANCES BY A MUSICAL BAND (U.S. CLS. 100, 101 AND 107).

CLASS 41—(Continued).

SN 78-090,875. PPG- DEPT OF EMERGENCY MEDICINE MEDICAL COLLEGE OF GA, AUGUSTA, GA. FILED 10-30-2001.

ADLS

FOR TRAINING PROGRAMS IN THE EDUCATION OF FIRST RESPONDERS AND MEDICAL PROVIDERS TO DISASTERS (U.S. CLS. 100, 101 AND 107).

SN 78-092,677. PALMER, HARRY N., ALTAMONTE SPRINGS, FL. FILED 11-9-2001.

RESURFACING

OWNER OF U.S. REG. NO. 1,937,956.
FOR WORKSHOPS, SEMINARS, AND INSTRUCTION IN THE FIELD OF PERSONAL AWARENESS AND SELF-IMPROVEMENT, AND PROVIDING RELATED MATERIALS (U.S. CLS. 100, 101 AND 107).
FIRST USE 9-1-1993; IN COMMERCE 10-23-1993.

SN 78-093,854. MCCOURRY & ROBIN, LOS ANGELES, CA. FILED 11-16-2001.

FASHION OBSESSION

FOR CONTINUING DRAMATIC SHOW DISTRIBUTED OVER TELEVISION, SATELLITE, CABLE, AUDIO, AND VIDEO MEDIA; TELEVISION PRODUCTION (U.S. CLS. 100, 101 AND 107).

SN 78-093,954. PHILIP, ROY M, PHILADELPHIA, PA. FILED 11-17-2001.

ROYLS

FOR MUSIC AND AUDIO PRODUCTION FOR ENTERTAINMENT PURPOSES IN SHOWS AND TV AND RADIO DISPLAY (U.S. CLS. 100, 101 AND 107).
FIRST USE 11-1-2001; IN COMMERCE 11-1-2001.

CLASS 42—SCIENTIFIC, COMPUTER AND LEGAL SERVICES

SN 75-423,222. FIREHOUSE WINGS CO., INC., JACKSONVILLE, FL. FILED 1-26-1998.

FIREHOUSE SUBS

OWNER OF U.S. REG. NOS. 1,903,135 AND 1,983,934.
NO CLAIM IS MADE TO THE EXCLUSIVE RIGHT TO USE "SUBS", APART FROM THE MARK AS SHOWN.
FOR RESTAURANT SERVICES SPECIALIZING IN SUBMARINE STYLE SANDWICHES FOR PUBLIC CONSUMPTION (U.S. CLS. 100 AND 101).
FIRST USE 9-1-1994; IN COMMERCE 2-15-1995.

CLASS 42—(Continued).

SN 75-519,954. CONSOL, STOCKTON, CA. FILED 7-16-1998.

COMFORTWISE

SUBJECT TO CONCURRENT USE PROCEEDING WITH WISCONSIN PUBLIC SERVICE CORPORATION, P.O. BOX 19001 GREEN BAY, WISCONSIN 54307, THE OWNER OF REGISTRATION NO. 2055493. APPLICANT CLAIMS EXCLUSIVE RIGHT TO THE AREA COMPRISING THE STATES OF ARIZONA, CALIFORNIA, COLORADO, NEW MEXICO, NEVADA, OREGON, TEXAS AND WASHINGTON.

FOR CONSULTATION SERVICES IN THE FIELD OF BUILDING RESOURCE EFFICIENT HOMES (U.S. CLS. 100 AND 101).
FIRST USE 6-0-1995; IN COMMERCE 6-0-1995.

SN 75-545,761. AGILE TECHNOLOGIES, L.L.C., MOUNT OLIVE, NJ. FILED 9-1-1998.

AGILE TECHNOLOGIES

NO CLAIM IS MADE TO THE EXCLUSIVE RIGHT TO USE "TECHNOLOGIES", APART FROM THE MARK AS SHOWN.

FOR COMPUTER CONSULTATION SERVICES IN THE FIELD OF INFORMATION TECHNOLOGY (U.S. CLS. 100 AND 101).
FIRST USE 4-1-1997; IN COMMERCE 4-1-1997.

SN 75-603,513. INFORMATION BUILDERS, INC., NEW YORK, NY. FILED 12-11-1998.

FOCUS

FOR COMPUTER SERVICES, NAMELY, PROVIDING ONLINE INFORMATION TO FACILITATE DEMONSTRATION, TEST USE, AND ORDERING OF COMPUTER SOFTWARE (U.S. CLS. 100 AND 101).
FIRST USE 12-0-1996; IN COMMERCE 12-0-1996.

SN 75-708,890. CRIMEBITE, LTD., AIKEN, SC. FILED 5-18-1999.

CRIME BITE

FOR SECURITY SERVICES TO IDENTIFY FRAUD, FORGERY, AND COUNTERFEITING, THROUGH THE USE OF A FINGERPRINT IDENTIFICATION/SIGNATURE SYSTEM AND TRACKING SYSTEM FOR CHECKS, COMP CHECKS, CREDIT CARDS, CREDIT CARD RECEIPTS, BANK ACCOUNT APPLICATIONS, RETAIL CREDIT APPLICATIONS, INSTANT CREDIT APPLICATIONS, RENTAL AGREEMENTS, PURCHASE ORDERS, LOCKSMITH ORDER, NOTARIZED DOCUMENTS AND DOCUMENTS ISSUED BY LAW ENFORCEMENT AGENCIES (U.S. CLS. 100 AND 101).
FIRST USE 1-1-1996; IN COMMERCE 1-1-1996.

CLASS 42—(Continued).

SN 75-771,646. RADIOLOGY.COM, INC., LOS ANGELES, CA.
FILED 8-9-1999.

ImageExpress

FOR PROVIDING AN ON-LINE COMPUTER DATA-BASE IN THE FIELD OF RADIOLOGY AND MEDICAL IMAGING RELATED SERVICES FOR RADIOLOGISTS AND IMAGING PROFESSIONALS (U.S. CLS. 100 AND 101).

SN 75-775,576. WELLER, BRADFORD S., SUNSET, UT.
FILED 9-10-1999.

NETEGORIES

FOR COMPUTER SERVICES, NAMELY, PROVIDING SEARCH ENGINES FOR OBTAINING DATA ON A GLOBAL COMPUTER NETWORK (U.S. CLS. 100 AND 101).

SN 75-782,611. DIGITAL CREATIONS, INC., GAINESVILLE, FL. FILED 8-23-1999.



NO CLAIM IS MADE TO THE EXCLUSIVE RIGHT TO USE "BIG MEDIA STUDIOS", APART FROM THE MARK AS SHOWN.

FOR COMPUTER SERVICES, NAMELY, CREATING, DESIGNING, HOSTING, MAINTAINING WEBSITES AND OTHER DIGITAL MEDIA FOR OTHERS, DATABASE DEVELOPMENT SERVICES FOR OTHERS, COMPUTER SOFTWARE PROGRAMMING SERVICES FOR OTHERS, GRAPHIC DESIGN SERVICES FOR OTHERS, NAMELY, COPY-WRITING, WRITTEN TEXT EDITING, PRINTING, AND DESKTOP PUBLISHING SERVICES, PROVIDING ELECTRONIC COMMERCE SERVICES FOR OTHERS (U.S. CLS. 100 AND 101).

FIRST USE 6-1-1999; IN COMMERCE 6-1-1999.

CLASS 42—(Continued).

SN 75-790,863. ITT INDUSTRIES, INC., WHITE PLAINS, NY.
FILED 9-2-1999.

HOFFMAN SPECIALTY

OWNER OF U.S. REG. NOS. 1,589,727 AND 2,332,924.
FOR PROVIDING INFORMATION CONCERNING PRODUCT RESEARCH AND DEVELOPMENT IN THE FIELD OF STEAM AND HYDRONIC SYSTEMS AND BOILER AND LEVEL CONTROL PRODUCTS BY MEANS OF THE WORLD WIDE COMPUTER NETWORK (U.S. CLS. 100 AND 101).

FIRST USE 1-0-1999; IN COMMERCE 1-0-1999.

SN 75-798,827. YOURDOCTOR, INC., SAUSALITO, CA.
FILED 10-30-1999.

The Internet Site Doctors Prescribe Most

FOR PROVIDING HEALTHCARE INFORMATION ON A GLOBAL COMPUTER NETWORK AND PROVIDING USER LINKS TO HEALTHCARE INFORMATION ON A GLOBAL COMPUTER NETWORK (U.S. CLS. 100 AND 101).

FIRST USE 4-0-1999; IN COMMERCE 4-0-1999.

SN 75-799,251. LINCOLN GLOBAL, INC., CLEVELAND, OH.
FILED 9-15-1999.

ONESOURCE

OWNER OF U.S. REG. NO. 2,397,044.
FOR CONSULTING SERVICES, NAMELY, ADVISING OTHERS IN THE PURCHASE OF GOODS IN THE FIELD OF WELDING EQUIPMENT, WELDING ACCESSORIES, WELDING CONSUMABLES, AND METAL CUTTING EQUIPMENT (U.S. CLS. 100 AND 101).

FIRST USE 9-19-1996; IN COMMERCE 9-19-1996.

SN 75-802,686. SOFTWARE ASSOCIATES, INC., WEST CHICAGO, IL. FILED 9-16-1999.

NATIONSOFT

FOR COMPUTER SERVICES, NAMELY, WEB PAGE DESIGN, COMPUTER SOFTWARE DESIGN, COMPUTER NETWORK PROGRAMMING FOR OTHERS, COMPUTER SERVER PROGRAMMING FOR OTHERS, AND DATA ENCRYPTION SERVICES AIMED AT ENSURING COMPUTER NETWORK SECURITY (U.S. CLS. 100 AND 101).

FIRST USE 7-10-1999; IN COMMERCE 7-10-1999.

CLASS 42—(Continued).

SN 75-818,071. ZIP TIDE, LLC, HOUSTON, TX. FILED 10-8-1999.



FOR PROVIDING INFORMATION FEATURING A WIDE VARIETY OF TOPICS OF GENERAL INTEREST TO THE CONSUMING PUBLIC, BUSINESSES AND PRIVATE INSTITUTIONS VIA WEB SITES ON THE GLOBAL COMPUTER NETWORK (U.S. CLS. 100 AND 101).

FIRST USE 1-29-1999; IN COMMERCE 1-29-1999.

SN 75-849,921. GB ACQUISTION, INC., CHATTANOOGA, TN. BY ASSIGNMENT GORDON BIERSCHE BREWING COMPANY, LAS VEGAS, NV. FILED 11-13-1999.



NO CLAIM IS MADE TO THE EXCLUSIVE RIGHT TO USE "HEFE WEIZEN" AND "CLASSIC", APART FROM THE MARK AS SHOWN.

THE TERM "HEFE WEIZEN" IS A GERMAN TERM MEANING "YEAST AND WHEAT".

FOR RESTAURANT AND CATERING SERVICES EXCLUDING CONCESSION SERVICES PROVIDED IN STANDS, BOOTHS, BARS AND KIOSKS IN SPORTS ARENAS, STADIUMS, COLISEUMS, SKI RESORTS, UNIVERSITIES, AIRPORTS, PUBLIC PARKS AND ZOOS (U.S. CLS. 100 AND 101).

FIRST USE 4-15-1998; IN COMMERCE 4-15-1998.

SN 75-857,077. KEYBANK NATIONAL ASSOCIATION, PORTLAND, ME. BY ASSIGNMENT ENVISIONET COMPUTER SERVICES, INC., BRUNSWICK, ME. FILED 11-24-1999.

ENVISIONET

FOR COMPUTER SERVICES, NAMELY PROVIDING SUPPORT SERVICES TO SOFTWARE AND HARDWARE MANUFACTURERS IN THE NATURE OF REAL-TIME TELEPHONE PROVISION OF SOFTWARE INFORMATION SERVICES; PROVIDING TECHNICAL SUPPORT AND OPERATIONAL CONSULTIVE SERVICES IN THE FIELD OF COMPUTER SOFTWARE (U.S. CLS. 100 AND 101).

FIRST USE 12-24-1994; IN COMMERCE 12-24-1994.

CLASS 42—(Continued).

SN 75-857,560. ELEGRITY, INC., SAN FRANCISCO, CA. BY CHANGE OF NAME SPICER COMMUNICATIONS, INC., SAN FRANCISCO, CA. FILED 11-24-1999.

ELEGRITY

FOR COMPUTER CONSULTATION; COMPUTER PROGRAMMING FOR OTHERS; DESIGN AND IMPLEMENTATION OF COMPUTER SYSTEMS, LOCAL AND WIDE AREA NETWORKS, AND VIRTUAL PRIVATE NETWORKS FOR OTHERS; DESIGNING AND SUPPORTING LARGE COMPLEX COMMUNICATIONS SYSTEMS, LOCAL AND WIDE AREA NETWORKS, DATA PROCESSING CENTERS AND VIDEO CONFERENCING NETWORKS FOR OTHERS; NETWORK ADMINISTRATION OF LARGE COMPLEX COMMUNICATIONS SYSTEMS, COMPUTER SYSTEMS, LOCAL AND WIDE AREA NETWORKS, DATA PROCESSING CENTERS AND VIDEO CONFERENCING NETWORKS FOR OTHERS; COMPUTER NETWORK INTEGRATION; TECHNICAL SUPPORT SERVICES FOR TECHNOLOGY INFRASTRUCTURE VIA TELEPHONE, E-MAIL, IN PERSON AND THE USE OF REMOTE ACCESS TOOLS; PROVIDING TEMPORARY USE OF ON-LINE NON-DOWNLOADABLE SOFTWARE FOR DATABASE MANAGEMENT, OPERATING SYSTEMS, TERMINAL SERVERS, DOCUMENT IMAGING, DOCUMENT MANAGEMENT WORD PROCESSING, SCHEDULING, ELECTRONIC MAIL, PROJECT MANAGEMENT, SPREADSHEETS, NETWORK BROWSING, AND CREATING PRESENTATIONS IN THE BUSINESS, SCIENTIFIC, TECHNICAL, COMMERCIAL, AND EDUCATIONAL FIELDS; APPLICATION SERVICE PROVIDER, NAMELY, HOSTING COMPUTER SOFTWARE APPLICATIONS OF OTHERS (U.S. CLS. 100 AND 101).

SN 75-873,455. CHERNITZKY, CARLOS ZAIDENWEBER, Z.C. 11570 MEXICO CITY, MEXICO, FILED 12-16-1999.



NO CLAIM IS MADE TO THE EXCLUSIVE RIGHT TO USE "VISIONCARE", APART FROM THE MARK AS SHOWN.

FOR OPTICIAN AND OPTOMETRIC SERVICES (U.S. CLS. 100 AND 101).

SN 75-882,698. D.J. ARDORE, INC., BOONTON, NJ. FILED 12-28-1999.

RESTAURANT ARDORE

NO CLAIM IS MADE TO THE EXCLUSIVE RIGHT TO USE "RESTAURANT", APART FROM THE MARK AS SHOWN.

THE ENGLISH TRANSLATION OF "ARDORE" IS "ARDOR" OR "PASSION".

FOR PROVIDING INFORMATION ON RESTAURANTS AND HOTELS VIA MULTI-USE GLOBAL COMPUTER INFORMATION NETWORK (U.S. CLS. 100 AND 101).

CLASS 42—(Continued).

SN 75-883,252. LONE STAR STEAKHOUSE & SALOON, INC., WICHITA, KS. FILED 12-29-1999.

LONE STAR TAKE AWAY

OWNER OF U.S. REG. NOS. 1,155,907, 2,229,771 AND OTHERS.

NO CLAIM IS MADE TO THE EXCLUSIVE RIGHT TO USE "TAKE AWAY", APART FROM THE MARK AS SHOWN.

FOR RESTAURANT AND BAR SERVICES (U.S. CLS. 100 AND 101).

SN 75-885,135. HARPER, KENNETH JOSEPH, DBA EBUSINESS 1, HOUSTON, TX. FILED 1-6-2000.

eBusiness

FOR SOFTWARE CONSULTING SERVICES FOR INTERNET-BASED BUSINESSES (U.S. CLS. 100 AND 101).
FIRST USE 10-1-1999; IN COMMERCE 10-1-1999.

SN 75-886,985. DIET DESIGNS, INC., CULVER CITY, CA. FILED 1-4-2000.

DIET DESIGNS

NO CLAIM IS MADE TO THE EXCLUSIVE RIGHT TO USE "DIET", APART FROM THE MARK AS SHOWN.
FOR NUTRITIONAL COUNSELING AND DIET PLANNING AND SUPERVISION (U.S. CLS. 100 AND 101).
FIRST USE 5-0-1992; IN COMMERCE 5-0-1992.

SN 75-888,030. ETHERMACHINE, LLC, YPSILANTI, MI. FILED 1-6-2000.

SOFTPRACTICE

FOR PROVIDING TEMPORARY USE OF ON-LINE NON-DOWNLOADABLE SOFTWARE FOR A PRACTICE MANAGEMENT SYSTEM FOR THE MEDICAL COMMUNITY (U.S. CLS. 100 AND 101).
FIRST USE 12-31-1993; IN COMMERCE 12-31-1993.

CLASS 42—(Continued).

SN 75-889,690. TASMANIA RESOURCE, INC., NEWARK, DE. FILED 1-6-2000.

SELL AHEAD OF THE CURVE

FOR COMPUTER CONSULTING AND TECHNICAL SUPPORT SERVICES FOR OTHERS NAMELY, DESIGN, DEVELOPMENT, IMPLEMENTATION, CONFIGURATION AND INTEGRATION OF SALES FORCE AND BUSINESS INFORMATION MANAGEMENT COMPUTER SOFTWARE AND RELATED COMPUTER HARDWARE AND NETWORK INFRASTRUCTURE; RELATED COMPUTER AND TECHNICAL SUPPORT, EDUCATIONAL, AND CONSULTING SERVICES; RELATED DATA INTEGRATION, ANALYSIS, AND CONSULTING SERVICES; ALL VIA IN-PERSON, BY TELEPHONE, IN PRINTED MATERIAL, AND OVER A GLOBAL COMPUTER NETWORK; ALL FOR THE HEALTH CARE, PHARMACEUTICAL, BIOTECHNOLOGY, CONSUMER PACKAGED GOODS, MEDICAL DEVICE, AND CONTRACT SALES ORGANIZATION INDUSTRIES, AMONG OTHERS (U.S. CLS. 100 AND 101).
FIRST USE 1-0-1999; IN COMMERCE 1-0-1999.

SN 75-890,051. SHREVEPORT LOUISIANA HAYRIDE CO., L.L.C., THE, SHREVEPORT, LA. FILED 1-7-2000.

SHREVEPORT LOUISIANA HAYRIDE CAFE

OWNER OF U.S. REG. NO. 1,897,126.
NO CLAIM IS MADE TO THE EXCLUSIVE RIGHT TO USE "SHREVEPORT LOUISIANA" AND "CAFE", APART FROM THE MARK AS SHOWN.
FOR RESTAURANT SERVICES IN AN ENTERTAINMENT RELATED ENVIRONMENT (U.S. CLS. 100 AND 101).

SN 75-906,496. GREEN, ISRAEL, BROOKLYN, NY. FILED 1-31-2000.

LIVE! 365 WORLD PRODUCT CENTRE

NO CLAIM IS MADE TO THE EXCLUSIVE RIGHT TO USE "WORLD PRODUCT CENTRE", APART FROM THE MARK AS SHOWN.
FOR PROVIDING FACILITIES FOR INTERNATIONAL MANUFACTURERS TO DISPLAY PRODUCTS (U.S. CLS. 100 AND 101).

SN 75-910,514. DESIGN HOTELS, INC., SAUSALITO, CA. FILED 1-28-2000.

DESIGN HOTELS

NO CLAIM IS MADE TO THE EXCLUSIVE RIGHT TO USE "HOTELS", APART FROM THE MARK AS SHOWN.
FOR HOTELS, MOTELS, RESORT INNS, AND RESTAURANT SERVICES (U.S. CLS. 100 AND 101).

CLASS 42—(Continued).

SN 75-921,867. DANTHERM HMS, INC., SPARTANBURG, SC. FILED 2-16-2000.

TECHNOLOGY'S THERMOSTAT

NO CLAIM IS MADE TO THE EXCLUSIVE RIGHT TO USE "THERMOSTAT", APART FROM THE MARK AS SHOWN.

FOR CUSTOM DESIGN OF HEAT EXCHANGE AND AIR CONDITIONING SYSTEMS TO OTHERS (U.S. CLS. 100 AND 101).

FIRST USE 12-1-1999; IN COMMERCE 12-1-1999.

SN 75-930,772. XEROX CORPORATION, STAMFORD, CT. FILED 2-28-2000.



OWNER OF U.S. REG. NO. 2,078,823.

NO CLAIM IS MADE TO THE EXCLUSIVE RIGHT TO USE "HELP", APART FROM THE MARK AS SHOWN.

FOR TECHNICAL SUPPORT SERVICES, NAMELY TROUBLESHOOTING DOCUMENT PRINTER, DOCUMENT COPIER, FACSIMILE MACHINE, OPTICAL CHARACTER RECOGNITION SCANNER, AND OPERATING SOFTWARE PROBLEMS VIA TELEPHONE, E-MAIL, AND IN PERSON; CONSULTATION IN THE FIELD OF DOCUMENT PRINTING, COPYING, SCANNING, AND FAXING (U.S. CLS. 100 AND 101).

SN 75-938,904. VISION SERVICE PLAN INSURANCE COMPANY, RANCHO CORDOVA, CA. FILED 3-8-2000.

EYEFINITY

FOR COMPUTER SERVICES, NAMELY, THE DESIGN, IMPLEMENTATION AND HOSTING OF WEB SITES FOR OTHERS ON A COMPUTER SERVER FOR A GLOBAL COMPUTER NETWORK; PROVIDING INFORMATION AND NEWS RELATING TO EYE CARE AND EYE HEALTH BY MEANS OF A GLOBAL COMPUTER NETWORK; PROVIDING A WEB SITE FOR LABORATORIES CONTAINING PRESCRIPTION INFORMATION FROM DOCTORS' OFFICES; SCHEDULING PERSONAL APPOINTMENTS FOR OTHERS, NAMELY, MEDICAL APPOINTMENTS (U.S. CLS. 100 AND 101).

CLASS 42—(Continued).

SN 76-003,248. ROBERTA S. FINE, P.A., KEY WEST, FL. FILED 3-17-2000.



The Barrister House

NO CLAIM IS MADE TO THE EXCLUSIVE RIGHT TO USE "BARRISTER HOUSE", APART FROM THE MARK AS SHOWN.

THE STRUCTURE SHOWN IN THE DRAWING HAS WOODEN SIDING NOT DEPICTED IN THE DRAWING.

FOR LAW OFFICE (U.S. CLS. 100 AND 101).

FIRST USE 1-0-1995; IN COMMERCE 1-0-1995.

SN 76-003,686. ANZAR, OMAR, SAN YSIDRO, CA. FILED 3-18-2000.

THRIFTYSTORE.NET

FOR ONLINE RETAIL STORE SERVICES IN THE FIELD OF COMPUTERS, CLOTHING, COMPACT DISCS; ONLINE TRADING, NAMELY ON LINE AUCTIONS; ADVERTISEMENTS, NAMELY PROMOTING THE GOODS AND SERVICES OF OTHERS VIA PREPARING AND PLACING ADVERTISEMENTS ON THE GLOBAL COMPUTER NETWORK (U.S. CLS. 100 AND 101).

SN 76-020,828. ATHENA PUBLICATIONS INC., SAN ANTONIO, TX. FILED 4-6-2000.

ADVANCING WOMEN

NO CLAIM IS MADE TO THE EXCLUSIVE RIGHT TO USE "WOMEN", APART FROM THE MARK AS SHOWN.

FOR PROVIDING A WEBSITE FEATURING INFORMATION ON A WIDE VARIETY OF SUBJECTS OF INTERESTS TO WOMEN (U.S. CLS. 100 AND 101).

FIRST USE 3-0-1996; IN COMMERCE 3-0-1996.

CLASS 42—(Continued).

SN 76-021,830. TOMATO RESTAURANT, INC., THE, NEW YORK, NY. FILED 4-7-2000.



NO CLAIM IS MADE TO THE EXCLUSIVE RIGHT TO USE "RESTAURANT" AND "NEW YORK CITY", APART FROM THE MARK AS SHOWN.

THE STIPPLING IS A FEATURE OF THE MARK AND DOES NOT INDICATE COLOR.

THE MARK CONSISTS OF IN PART OF A STYLIZED MERMAID WITH A TOMATO.

FOR RESTAURANT SERVICES (U.S. CLS. 100 AND 101).

FIRST USE 3-10-1999; IN COMMERCE 3-10-1999.

CLASS 42—(Continued).

SN 76-039,331. SILICON DEFENSE, INC., ARCADA, CA. FILED 5-1-2000.

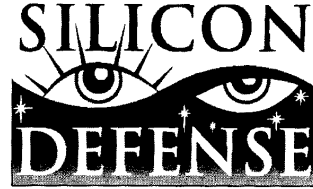

FOR COMPUTER CONSULTATION AND RESEARCH, NAMELY RESEARCH FOCUSING ON COMPUTER SECURITY FOR GOVERNMENT FUNDED CONTRACTS AND CONSULTATION NAMELY WITH REGARD TO OPEN SOURCE SUPPORT AND OUTSOURCE NETWORK MONITORING SERVICES (U.S. CLS. 100 AND 101).

FIRST USE 6-29-1998; IN COMMERCE 6-29-1998.

SN 76-040,974. WEBINTELLECTS, INC., VISTA, CA. FILED 5-1-2000.

SN 76-021,950. TELENISUS CORPORATION, ROLLING MEADOWS, IL. FILED 4-10-2000.

BUILT FOR E-BUSINESS

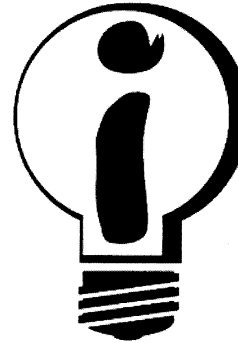

NO CLAIM IS MADE TO THE EXCLUSIVE RIGHT TO USE "E-BUSINESS", APART FROM THE MARK AS SHOWN.

FOR COMPUTER SECURITY SERVICES ENABLED THROUGH AN INTEGRATED TECHNOLOGY PLATFORM, NAMELY, COMPUTER SECURITY CONSULTING, MANAGED FIREWALL SERVICES FOR OTHERS; DESIGN OF COMPUTER SECURITY FOR NETWORKS; COMPUTER APPLICATION HOSTING FOR OTHERS; WEB SITE INFRASTRUCTURE DEVELOPMENT; HOSTING AND MONITORING THE WEB SITES OF OTHERS ON A SERVER FOR A GLOBAL COMPUTER NETWORK; COMPUTER SERVICES, NAMELY, PROVIDING A VIRTUAL PRIVATE NETWORK FOR OTHERS (U.S. CLS. 100 AND 101).

THE STIPPLING SHOWN IN THE DRAWING IS A FEATURE OF THE MARK AND NOT INTENDED TO INDICATE COLOR. IT IS FOR SHADING PURPOSES ONLY.

FOR HOSTING THE WEB SITES OF OTHERS ON A COMPUTER SERVER FOR A GLOBAL COMPUTER NETWORK COMPUTER SERVICES, NAMELY, DESIGNING AND IMPLEMENTING WEB SITES FOR OTHERS; COMPUTER ELECTRONIC COMMERCE SERVICES, NAMELY, DESIGN AND MAINTENANCE OF WEB SITES FOR OTHERS, VIA A GLOBAL COMPUTER NETWORK, AND PROVIDING ON-LINE TRANSACTION THIRD PARTY DEBIT ACCOUNT SERVICES VIA A GLOBAL COMPUTER INFORMATION NETWORK; PROVIDING COMPUTER DIAL-UP SERVICES AND INFORMATION TO SUBSCRIBERS IN THE FIELD OF SMALL BUSINESS AND PERSONAL USE (U.S. CLS. 100 AND 101).

FIRST USE 7-1-1999; IN COMMERCE 8-1-1999.

CLASS 42—(Continued).

SN 76-041,034. SWS SOFTWARE TECHNOLOGIES GROUP AG, 8835 FEUSIBERG, SWITZERLAND, BY CHANGE OF NAME SWS DASE SOFTWARE SYSTEMS HOLDING (SCHWEIZ) AG, 8835 FEUSIBERG, SWITZERLAND, FILED 5-4-2000.

YES2WEB

OWNER OF SWITZERLAND REG. NO. 475093, DATED 10-15-2001, EXPIRES 3-3-2011.

FOR COMPUTER SOFTWARE DEVELOPMENT AND CONSULTING SERVICES IN THE FIELD OF DATA PROCESSING (U.S. CLS. 100 AND 101).

SN 76-071,501. UNIPAT BEHEER B.V., NIEUWE PARK-LAAN, NETHERLANDS, FILED 6-16-2000.



PRIORITY CLAIMED UNDER SEC. 44(D) ON BENELUX APPLICATION NO. 952798, FILED 12-16-1999, REG. NO. 657894, DATED 12-16-1999, EXPIRES 12-16-2009.

THE MARK CONSISTS OF A V DESIGN ROTATED 90 DEGREES TO THE LEFT SO THE OPEN PART OF THE V POINTS TO THE LEFT. THE BALL IS ONE HALF WAY UP THE TOP EXTENSION OF THE V.

FOR LEGAL SERVICES IN THE FIELD OF PATENT, TRADEMARK, DESIGN AND COPYRIGHT LAW AS WELL AS IN LICENSING; CONSULTING SERVICES RELATED TO IMPLEMENTATION OF PATENT RIGHTS; CONSULTING RELATING TO THE INTERPRETATION OF CHEMICAL FORMULAS, NAMELY, SEQUENCE IDENTIFICATION (U.S. CLS. 100 AND 101).

SN 76-079,166. XCYTE THERAPIES, INC., SEATTLE, WA. FILED 6-28-2000.

XCYTE

FOR RESEARCH AND DEVELOPMENT FOR NEW IMMUNOTHERAPY PRODUCTS FOR OTHERS (U.S. CLS. 100 AND 101).

SN 76-086,110. ROYAL FIESTA CATERERS, INC., DEER-FIELD BEACH, FL. FILED 7-10-2000.

ROYAL FIESTA

FOR RESTAURANT AND CATERING SERVICES (U.S. CLS. 100 AND 101).

CLASS 42—(Continued).

SN 76-087,755. GLOBAL INTERNET BILLING (INTELLECTUAL PROPERTY) LIMITED, ST ALBANS HERTFORDSHIRE, UNITED KINGDOM, FILED 7-11-2000.

FOR PROVIDING TEMPORARY USE OF ON-LINE NON-DOWNLOADABLE SOFTWARE APPLICATIONS FOR USE IN ELECTRONIC FINANCIAL TRANSACTIONS, ELECTRONIC PROCESSING AND TRANSMISSION OF BILL PAYMENT DATA; COMPUTER SOFTWARE DESIGN AND CONSULTATION FOR OTHERS; PROVIDING A WEB SITE AND INFORMATION VIA A GLOBAL COMPUTER NETWORK IN THE FIELD OF COMPUTER NETWORKS AND SOFTWARE (U.S. CLS. 100 AND 101).

FIRST USE 10-18-1999; IN COMMERCE 10-18-1999.

SN 76-088,874. INTERNATIONAL TRANSLATION BUREAU, MINNEAPOLIS, MN. FILED 7-14-2000.

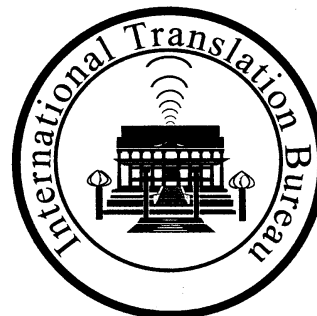

NO CLAIM IS MADE TO THE EXCLUSIVE RIGHT TO USE "INTERNATIONAL TRANSLATION BUREAU", APART FROM THE MARK AS SHOWN.

FOR LANGUAGE TRANSLATION SERVICES, NAMELY INTERPRETING LANGUAGES AND SIGN LANGUAGE, TRANSLATING LANGUAGE (U.S. CLS. 100 AND 101).

FIRST USE 5-1-2000; IN COMMERCE 5-1-2000.

SN 76-091,021. INFORMATION MANAGEMENT CONSULTANTS, INC., MCLEAN, VA. FILED 7-19-2000.

**BUSINESS SOLUTIONS
FRAMEWORK**

NO CLAIM IS MADE TO THE EXCLUSIVE RIGHT TO USE "BUSINESS SOLUTIONS", APART FROM THE MARK AS SHOWN.

FOR INFORMATION TECHNOLOGY CONSULTING SERVICES (U.S. CLS. 100 AND 101).

FIRST USE 10-1-1996; IN COMMERCE 10-1-1996.

CLASS 42—(Continued).

SN 76-095,528. HOUSING4STUDENTS.COM, WOODSIDE, CA. FILED 7-24-2000.



NO CLAIM IS MADE TO THE EXCLUSIVE RIGHT TO USE ".COM", APART FROM THE MARK AS SHOWN.

FOR PROVIDING AN INTERACTIVE WEB SITE VIA A GLOBAL COMPUTER INFORMATION NETWORK FEATURING INFORMATION TO ASSIST COLLEGE STUDENTS IN FINDING HOUSING (U.S. CLS. 100 AND 101).

SN 76-099,861. ODYSSEY PHARMACEUTICALS, INC., SAN RAMON, CA. FILED 7-31-2000.

EPIC

FOR PROVIDING AN ON-LINE COMPUTER SUBSCRIPTION DATABASE IN THE FIELDS OF BIOTECHNICAL AND BIOPHARMACEUTICAL INFORMATION, NAMELY, GENOMIC, PROTEOMIC, MOLECULAR TARGET DISCOVERY, MOLECULAR TARGET VALIDATION, DRUG DISCOVERY, DRUG VALIDATION, AND MECHANISM OF DISEASE INFORMATION (U.S. CLS. 100 AND 101).

SN 76-108,014. FACECAKE.COM, INC., WOODLAND HILLS, CA. FILED 8-11-2000.

FACECAKE

FOR PROVIDING A WEB SITE FEATURING INFORMATION OF INTEREST TO WOMEN, NAMELY MAKE-UP APPLICATION AND GENERAL INFORMATION REGARDING THE COSMETIC INDUSTRY AND COSMETIC PRODUCTS (U.S. CLS. 100 AND 101).

SN 76-116,716. LA COSTA COMPANY LP, THE, ROCKVILLE, MD. FILED 8-25-2000.

LA COSTA

OWNER OF U.S. REG. NOS. 1,197,419, 1,445,623 AND 1,481,948.

THE ENGLISH TRANSLATION OF "LA COSTA" IS "THE COAST".

FOR RESORT HOTEL, RESTAURANT, HEALTH SPA AND BEAUTY SPA SERVICES (U.S. CLS. 100 AND 101). FIRST USE 7-0-1964; IN COMMERCE 7-1-1965.

CLASS 42—(Continued).

SN 76-117,303. MYMIRROR NETWORKS INC., CALGARY T2P 1E5, CANADA, FILED 8-25-2000.

MYMIRROR

FOR PROVIDING AN INTERACTIVE INTERFACE OVER A GLOBAL COMMUNICATION NETWORK FOR ENTERING HEALTH OR LIFESTYLE INFORMATION ABOUT A USER FOR THE PURPOSE OF MONITORING THE HEALTH OR LIFESTYLE OF A USER (U.S. CLS. 100 AND 101).

SN 76-117,466. V.S.V.S. INC., WALNUT, CA. FILED 8-24-2000.

VSVS

FOR PROVIDING A SECURED METHOD OF CONDUCTING BUSINESS TRANSACTIONS THROUGH THE INTERNET AND THROUGH TRADITIONAL METHODS, NAMELY, IDENTIFICATION, AUTHORIZATION, AUTHENTICATION AND VERIFICATION OF INDIVIDUALS, ORGANIZATIONS, DOCUMENTS, TRANSACTIONS, HANDWRITTEN SIGNATURE VERIFICATION AND ELECTRONIC "SIGNATURE" VERIFICATION AND AUTHORIZATION; DIGITAL "SIGNATURE" VERIFICATION AND AUTHORIZATION (U.S. CLS. 100 AND 101).

FIRST USE 7-1-2000; IN COMMERCE 7-1-2000.

SN 76-118,681. CHEPREN, JOSEPH, OLATHE, KS. FILED 8-29-2000.

PROJECT MATE

NO CLAIM IS MADE TO THE EXCLUSIVE RIGHT TO USE "PROJECT", APART FROM THE MARK AS SHOWN.

FOR DESIGN OF CUSTOM CASE GOODS FOR OTHERS (U.S. CLS. 100 AND 101).

FIRST USE 8-23-2000; IN COMMERCE 8-23-2000.

SN 76-118,684. COLLAGE FOOD CONCEPTS, INC., MANHATTAN BEACH, CA. FILED 8-29-2000.

ZAZOU

FOR RESTAURANT SERVICES (U.S. CLS. 100 AND 101).

FIRST USE 11-0-1996; IN COMMERCE 12-0-1996.

CLASS 42—(Continued).

SN 76-128,203. CORLIANT, INC., TREVOSE, PA. FILED 9-14-2000.

CORLIANT CYPHERWORKS

FOR COMPUTER SECURITY SERVICES, NAMELY, DATA ENCRYPTION, DESIGNING AND IMPLEMENTING SECURE NETWORK WEB PAGES FOR OTHERS, AND MONITORING OF COMPUTER SYSTEMS (U.S. CLS. 100 AND 101).

SN 76-130,219. PRITCHARD, LAVERN A., DBA PRITCHARD LAW WEBS, MINNEAPOLIS, MN. FILED 9-18-2000.

LAWMOOSE

FOR COMPUTER SERVICES, NAMELY, PROVIDING A WEBSITE ON GLOBAL COMPUTER NETWORKS THAT SEARCHES, RETRIEVES, AND DISPLAYS INFORMATION CONCERNING LAW, COURTS, THE LEGAL FIELD, AND THE AVAILABILITY OF LEGAL AND PROFESSIONAL SERVICES AND PRODUCTS (U.S. CLS. 100 AND 101).

FIRST USE 2-16-2000; IN COMMERCE 2-16-2000.

SN 76-131,109. A&E TELEVISION NETWORKS, NEW YORK, NY. FILED 9-19-2000.

HISTORY PASTFINDER

NO CLAIM IS MADE TO THE EXCLUSIVE RIGHT TO USE "HISTORY", APART FROM THE MARK AS SHOWN.

FOR INFORMATION SERVICES, NAMELY, PROVIDING ON-LINE DATABASES AND LINKS TO OTHER CONTENT PROVIDERS IN THE FIELD OF HISTORY, HISTORICAL PEOPLE, PLACES AND EVENTS VIA THE GLOBAL COMPUTER NETWORK; PROVIDING INDEXES OF, INFORMATION ON, AND LINKS TO WEB SITES FEATURING TOPICS RELATING TO HISTORY, HISTORICAL PEOPLE, PLACES AND EVENTS BY MEANS OF A GLOBAL COMPUTER DATABASE; PROVIDING A SEARCH ENGINE FOR OBTAINING INFORMATION ABOUT HISTORY, HISTORICAL PEOPLE, PLACES AND EVENTS; PROVIDING INFORMATION REGARDING HISTORY, HISTORICAL PEOPLE, PLACES AND EVENTS BY MEANS OF A GLOBAL COMPUTER NETWORK (U.S. CLS. 100 AND 101).

CLASS 42—(Continued).

SN 76-132,191. PURCHASINGNET, INC., LINCROFT, NJ. FILED 9-20-2000.



FOR COMPUTER CONSULTATION SERVICES, NAMELY, COMPUTER SOFTWARE DESIGN FOR OTHERS IN THE NATURE OF CUSTOMIZING COMPUTER SOFTWARE; COMPUTER PROGRAMMING FOR OTHERS IN THE NATURE OF WRITING STANDARD AND CUSTOM SYSTEM AND END USER DOCUMENTATION FOR OTHERS, WRITING CUSTOM INTERFACES TO TRANSFER DATA BETWEEN TWO OR MORE SOFTWARE APPLICATIONS; COMPUTER SYSTEMS ANALYSIS IN THE NATURE OF TESTING STANDARD AND CUSTOM SOFTWARE, UPDATING OF COMPUTER SOFTWARE IN THE NATURE OF CONVERTING DATA FROM LEGACY COMPUTER SOFTWARE APPLICATIONS AND DATABASE APPLICATIONS TO UPDATED APPLICATIONS AND DATA FORMATS, MAPPING SUPPLIERS' CATALOG DATA INTO UPDATED APPLICATIONS AND DATA FORMATS; PROVIDING ON-SITE INSTALLATION OF COMPUTER SOFTWARE; AND TECHNICAL SUPPORT SERVICES, NAMELY, TROUBLESHOOTING OF COMPUTER HARDWARE AND SOFTWARE PROBLEMS VIA A GLOBAL COMPUTER NETWORK (U.S. CLS. 100 AND 101).

FIRST USE 2-0-2000; IN COMMERCE 2-0-2000.

SN 76-132,193. PURCHASINGNET, INC., LINCROFT, NJ. FILED 9-20-2000.

PURCHASINGNET

FOR COMPUTER CONSULTATION SERVICES, NAMELY, COMPUTER SOFTWARE DESIGN FOR OTHERS IN THE NATURE OF CUSTOMIZING COMPUTER SOFTWARE; COMPUTER PROGRAMMING FOR OTHERS IN THE NATURE OF WRITING STANDARD AND CUSTOM SYSTEM AND END USER DOCUMENTATION FOR OTHERS, WRITING CUSTOM INTERFACES TO TRANSFER DATA BETWEEN TWO OR MORE SOFTWARE APPLICATIONS; COMPUTER SYSTEMS ANALYSIS IN THE NATURE OF TESTING STANDARD AND CUSTOM SOFTWARE, UPDATING OF COMPUTER SOFTWARE IN THE NATURE OF CONVERTING DATA FROM LEGACY COMPUTER SOFTWARE APPLICATIONS AND DATABASE APPLICATIONS TO UPDATED APPLICATIONS AND DATABASE FORMATS, MAPPING SUPPLIERS' CATALOG DATA INTO UPDATED APPLICATIONS AND DATA FORMATS; PROVIDING ON-SITE INSTALLATION OF COMPUTER SOFTWARE; AND TECHNICAL SUPPORT SERVICES, NAMELY, TROUBLESHOOTING OF COMPUTER HARDWARE AND SOFTWARE PROBLEMS VIA A GLOBAL COMPUTER NETWORK (U.S. CLS. 100 AND 101).

FIRST USE 4-0-1996; IN COMMERCE 4-0-1996.

CLASS 42—(Continued).

SN 76-134,570. TAVERNA OPA TRADEMARK CORP., HOLLYWOOD, FL. FILED 9-25-2000.



NO CLAIM IS MADE TO THE EXCLUSIVE RIGHT TO USE "TAVERNA", APART FROM THE MARK AS SHOWN.

THE LITERAL TRANSLATION OF "TAVERNA" IS "[A] CAFE OR SMALL RESTAURANT IN GREECE. "OPA" IS A TRADITIONAL GREEK EXPRESSION LOOSELY TRANSLATED INTO ENGLISH AS A VARIETY OF THINGS INCLUDING: "EXPRESSION OF GLEE", "HAPPY TIMES", "JOY OF LIFE", "TRADITIONAL EXPRESSION IN GREEK WHEN YOU DANCE AND FEEL HAPPY", "GET UP AND DANCE, CELEBRATE".

FOR RESTAURANT SERVICES FEATURING DINING IN AND CARRY OUT OF GREEK AND ETHNIC FOODS (U.S. CLS. 100 AND 101).

FIRST USE 3-20-1998; IN COMMERCE 3-20-1998.

SN 76-134,636. AUCTION BROKER SOFTWARE, INC., TAMPA, FL. FILED 9-20-2000.

TRADING INTELLIGENCE

FOR COMPUTER SERVICES, NAMELY DESIGNING AND MAINTAINING WEB SITES FOR OTHERS, INTEGRATION OF COMPUTER SYSTEMS AND NETWORKS, COMPUTER PROGRAMING FOR OTHERS IN THE FIELDS OF THE GLOBAL COMPUTER NETWORKS AND AUCTIONS (U.S. CLS. 100 AND 101).

SN 76-135,995. PACIFIC LAW GROUP, PORTLAND, OR. FILED 9-27-2000.

PACIFIC LAW GROUP

NO CLAIM IS MADE TO THE EXCLUSIVE RIGHT TO USE "LAW GROUP", APART FROM THE MARK AS SHOWN.

FOR LEGAL SERVICES (U.S. CLS. 100 AND 101).

FIRST USE 7-1-1998; IN COMMERCE 7-1-1998.

CLASS 42—(Continued).

SN 76-138,111. DALE, CHARLES, ASPEN, CO. FILED 9-29-2000.



NO CLAIM IS MADE TO THE EXCLUSIVE RIGHT TO USE "BISTRO", APART FROM THE MARK AS SHOWN.

THE TERM "RUSTIQUE" IS DEFINED AS "RUSTIC". FOR RESTAURANT SERVICES (U.S. CLS. 100 AND 101).

SN 76-142,552. TRADING PLACES INTERNATIONAL, LAGUNA NIGUEL, CA. FILED 10-10-2000.

RESORTS TO PORTS

FOR RESORT RESERVATION AGENCY SERVICES FOR TIME SHARE FACILITY UTILIZATION, NAMELY, OFFERING TO CLIENTS OPPORTUNITIES TO EXCHANGE OR APPLY THE VALUE OF RESORT TIME-SHARE RIGHTS TOWARD CRUISE VACATIONS, MANAGING A TIMESHARE RIGHTS EXCHANGE PROGRAM AND COUNSELING CLIENTS OWNING RESORT TIMESHARES FOR DERIVING RELATED BENEFITS FROM CRUISE VACATIONS (U.S. CLS. 100 AND 101).

FIRST USE 9-27-2000; IN COMMERCE 9-27-2000.

SN 76-145,739. PLAYSTREAM, L.L.C., SEATTLE, WA. FILED 10-12-2000.

DIGITAL RIGHTS MEDIA

NO CLAIM IS MADE TO THE EXCLUSIVE RIGHT TO USE "DIGITAL" AND "MEDIA", APART FROM THE MARK AS SHOWN.

FOR COMPUTER SERVICES, NAMELY PROVIDING TEMPORARY USE OF ON-LINE NON-DOWNLOADABLE COMPUTER SOFTWARE FOR USE IN DATABASE MANAGEMENT, FOR ENABLING THE TRANSMISSION AND RECEPTION OF DIGITAL BROADCASTS OF MULTIMEDIA FILES TO QUALIFIED CUSTOMERS VIA A GLOBAL COMPUTER NETWORK (U.S. CLS. 100 AND 101).

FIRST USE 8-3-2000; IN COMMERCE 8-3-2000.

CLASS 42—(Continued).

SN 76-147,754. ROBINSON, JOHN WILLIAM, VAN NUYS, CA. FILED 10-16-2000.

THE HANGMEN

FOR SERVICE ART INSTALLATION (U.S. CLS. 100 AND 101).
FIRST USE 2-1-1997; IN COMMERCE 2-1-1997.

SN 76-152,784. WATERMOOR GROUP LIMITED, WEST SAYVILLE, NY. FILED 10-24-2000.

EDUTALK

FOR CONSULTING SERVICES IN THE FIELD OF COMMUNICATIONS, INFORMATION TECHNOLOGY STATISTICAL RESEARCH, QUANTIFICATION OF STATISTICAL STUDIES, AND INFORMATION TECHNOLOGY (U.S. CLS. 100 AND 101).
FIRST USE 8-1-2000; IN COMMERCE 8-1-2000.

SN 76-154,812. NATIONAL FEDERATION OF THE BLIND, THE, BALTIMORE, MD. FILED 10-27-2000.

NATIONAL RESEARCH AND TRAINING INSTITUTE FOR THE BLIND

NO CLAIM IS MADE TO THE EXCLUSIVE RIGHT TO USE "RESEARCH AND TRAINING INSTITUTE FOR THE BLIND", APART FROM THE MARK AS SHOWN.

SEC. 2(F) AS TO "NATIONAL".
FOR RESEARCH INTO TECHNIQUES AND METHODS FOR PROVIDING EDUCATIONAL, EMPLOYMENT, AND SOCIAL OPPORTUNITIES FOR THE BLIND; RESEARCH INTO TECHNICAL DEVICES FOR ENHANCING OPPORTUNITIES FOR THE BLIND (U.S. CLS. 100 AND 101).

SN 76-155,917. MIEI AMICI, LTD., BARRINGTON, IL. FILED 10-27-2000.

MIEI AMICI

THE ENGLISH TRANSLATION OF THE WORD "MIEI AMICI" IN THE MARK IS "MY FRIENDS".

FOR COFFEE HOUSE SERVING COFFEE, COFFEE-BASED BEVERAGES, SANDWICHES AND PASTRIES FOR CONSUMPTION ON OR OFF THE PREMISES (U.S. CLS. 100 AND 101).

FIRST USE 1-1-1999; IN COMMERCE 1-1-1999.

CLASS 42—(Continued).

SN 76-156,624. MGAINTERACTIVE, INC., MARIETTA, GA. FILED 10-31-2000.

MGAINTERACTIVE, INC.

NO CLAIM IS MADE TO THE EXCLUSIVE RIGHT TO USE "INC.", APART FROM THE MARK AS SHOWN.

FOR APPLICATION SERVICE PROVIDER TO THE INSURANCE INDUSTRY, NAMELY, PROVIDING SOFTWARE TO FACILITATE INSURANCE POLICY ISSUANCE, NAMELY, PROVIDING INSURANCE RATES, QUOTES, AND ISSUING INSURANCE BINDERS AND POLICIES TO SUBSCRIBING INSURANCE CARRIERS, MANAGING GENERAL AGENTS AND THEIR AGENTS (U.S. CLS. 100 AND 101).

SN 76-157,196. ROBERTS, KIRK, NEW YORK, NY. FILED 10-31-2000.

ASK LUCILLE

FOR COMPUTER SERVICES, NAMELY, PROVIDING AN ONLINE ADVICE COLUMN DEALING WITH HEALTH, FITNESS, NUTRITION, BEAUTY CARE AND RELATED ISSUES OF INTEREST TO WOMEN (U.S. CLS. 100 AND 101).

SN 76-158,634. KENT COUNTY MENTAL HEALTH CENTER, INC, WARWICK, RI. FILED 11-2-2000.



FOR PSYCHOTHERAPY SERVICES, NAMELY, COUNSELING IN THE FIELD OF BEHAVIORAL AND MENTAL HEALTH (U.S. CLS. 100 AND 101).

FIRST USE 2-0-1991; IN COMMERCE 2-0-1991.

SN 76-159,828. HENRY, MICHAEL CASEY, WILMINGTON, DE. FILED 11-1-2000.



THE NON-LATIN CHARACTERS IN THE MARK TRANSLITERATE TO "AXA" AND THIS MEANS "LAMBDA", "CHI", AND "LAMBDA" IN ENGLISH.

FOR SOCIAL CLUB SERVICES (U.S. CLS. 100 AND 101).

FIRST USE 8-1-1996; IN COMMERCE 10-1-2000.

CLASS 42—(Continued).

SN 76-160,066. VALBAY HOTEL LIMITED, THUNDER BAY, CANADA, FILED 11-6-2000.

VALHALLA INN

OWNER OF CANADA REG. NO. TMA153,976, DATED 11-3-1967, EXPIRES 11-3-2012.
NO CLAIM IS MADE TO THE EXCLUSIVE RIGHT TO USE "INN", APART FROM THE MARK AS SHOWN.
FOR HOTEL SERVICES (U.S. CLS. 100 AND 101).

SN 76-160,389. NUTMANN BALDWIN PARTNERS, LLC, DBA NUVOOLUTION, ST. PAUL, MN. FILED 11-7-2000.



FOR INFORMATION TECHNOLOGY CONSULTING SERVICES IN THE FIELD OF DESIGNING COMPUTER NETWORK SYSTEMS FOR THE NEEDS OF VARIOUS BUSINESSES (U.S. CLS. 100 AND 101).

SN 76-161,237. XENCOR, PASADENA, CA. FILED 11-7-2000.

PROCEDURE

FOR MEDICAL AND SCIENTIFIC RESEARCH AND DEVELOPMENT SERVICES FOR THIRD PARTIES; MEDICAL AND SCIENTIFIC CONSULTING SERVICES FOR THIRD PARTIES, NAMELY, CONSULTATION REGARDING DRUG TARGETS, DRUG PROFILES, COMPOUND PROFILES, AND MEDICAL AND SCIENTIFIC COMPOUNDS; PROVIDING AN ON-LINE COMPUTER DATABASE IN THE FIELD OF MEDICAL AND SCIENTIFIC INFORMATION (U.S. CLS. 100 AND 101).

CLASS 42—(Continued).

SN 76-162,142. ORIGINAL STEAKHOUSE AND SPORTS THEATER, L.L.C., THE, FORT LAUDERDALE, FL. FILED 11-9-2000.



NO CLAIM IS MADE TO THE EXCLUSIVE RIGHT TO USE "ORIGINAL STEAKHOUSE & SPORTS THEATRE", APART FROM THE MARK AS SHOWN.

THE MARK CONSISTS OF THE STYLIZED WORDING "THE ORIGINAL STEAKHOUSE & SPORTS THEATRE" WITH THE ENTIRE WORDING SUPERIMPOSED ON A DEPICTION OF AN ADVERTISING BOARD SIGN AND THE WORD "STEAKHOUSE" CAPTURED WITHIN A DEPICTION OF A BANNER.

FOR RESTAURANT SERVICES (U.S. CLS. 100 AND 101).

SN 76-162,419. KONINKLIJKE PHILIPS ELECTRONICS N.V., EINDHOVEN, NETHERLANDS, FILED 11-9-2000.

ARANUA

PRIORITY CLAIMED UNDER SEC. 44(D) ON BENELUX APPLICATION NO. 0964375, FILED 5-11-2000, REG. NO. 0671622, DATED 2-0-2001, EXPIRES 5-11-2010.

FOR DESIGN AND DEVELOPMENT FOR OTHERS OF INTEGRATED CIRCUITS (ICS), COMPUTER CHIPS AND SEMICONDUCTORS, MICROPROCESSORS, EMBEDDED SOFTWARE, REPROGRAMMABLE COMPUTER CHIPS AND PRINTED CIRCUIT BOARDS (U.S. CLS. 100 AND 101).

SN 76-162,882. VERISIGN, INC., MOUNTAIN VIEW, CA. FILED 11-9-2000.

ENUM WORLD

FOR DATA CONVERSION OF COMPUTER DATA OR INFORMATION, NAMELY, CONVERSION OF EXISTING TELEPHONE NUMBER OR ASSIGNED NUMBER SEQUENCE INTO AN INTERNET PROTOCOL ("IP") ADDRESS OR UNIFORM RESOURCE LOCATOR ("URL") FOR THE PURPOSE OF ENABLING ACCESS, SELECTION AND DISPLAY OF ONLINE CONTENT VIA A WIRELESS NETWORK (U.S. CLS. 100 AND 101).

CLASS 42—(Continued).

SN 76-164,264. COOLTOUCH CORPORATION, ROSEVILLE, CA. FILED 11-7-2000.

PIRL

FOR MEDICAL, COSMETIC AND DERMATOLOGICAL SERVICES (U.S. CLS. 100 AND 101).

SN 76-164,993. PALS FOUNDATION, SAN LUIS OBISPO, CA. FILED 11-13-2000.



NO CLAIM IS MADE TO THE EXCLUSIVE RIGHT TO USE "WORLD REVERENCE FOR LIFE AWARENESS", APART FROM THE MARK AS SHOWN.

THE MARK CONSISTS OF THE WORDS "WORLD REVERENCE FOR LIFE AWARENESS" AND DESIGN OF A PAWPRINT / FOOTPRINT CIRCLE EMBODYING A SHADED SEMICIRCLE WITH A CHILD, CANINE AND FELINE; AT BOTH SIDES OF THE PAWPRINT / FOOTPRINT CIRCLE ARE PAWPRINT RIBBONS ENVELOPED BY A DIMENSIONAL HEART.

FOR PROMOTING PUBLIC AWARENESS OF THE NEED FOR REVERENCE, HUMANE TREATMENT, CONSERVATION, PROTECTION OF ALL LIVING THINGS, RESPECTIVELY, NON-HUMAN ANIMALS, HUMANS AND THE NATURAL ENVIRONMENT (U.S. CLS. 100 AND 101).

FIRST USE 1-3-1991; IN COMMERCE 1-3-1991.

SN 76-166,746. EXPERIENCE LEARNING COMMUNITY, SEATTLE, WA. BY ASSIGNMENT VULCAN NORTHWEST INC., BELLEVUE, WA. FILED 11-16-2000.

EXPERIENCE BUSINESS AND TECHNOLOGY PROJECT

OWNER OF U.S. REG. NOS. 2,067,610, 2,289,131 AND OTHERS.

NO CLAIM IS MADE TO THE EXCLUSIVE RIGHT TO USE "BUSINESS AND TECHNOLOGY PROJECT", APART FROM THE MARK AS SHOWN.

FOR PROVIDING AN ON-LINE ELECTRONIC DATABASE ON THE INTERNET, WIDE-AREA NETWORKS, AND LOCAL AREA-NETWORKS, IN THE FIELDS OF BUSINESS AND TECHNOLOGY, INTERNET COMMUNICATIONS, COMPUTER PROGRAMMING AND MULTIMEDIA PROGRAMMING; COMPUTER PROGRAMMING FOR OTHERS; MULTIMEDIA COMPUTER SOFTWARE DESIGN FOR OTHERS; PROVIDING WEBSITES ON THE INTERNET FEATURING INFORMATION IN THE FIELDS OF BUSINESS AND TECHNOLOGY, COMPUTER PROGRAMMING AND MULTIMEDIA PROGRAMMING; WEB-HOSTING SERVICES FOR OTHERS; COMPUTER SOFTWARE DEVELOPMENT SERVICES FOR OTHERS; PROVIDING PRODUCT RESEARCH AND DEVELOPMENT FOR OTHERS (U.S. CLS. 100 AND 101).

CLASS 42—(Continued).

SN 76-167,159. DAVID EVANS AND ASSOCIATES, INC., PORTLAND, OR. FILED 11-17-2000.



THE MARK CONSISTS, IN PART, OF THE STYLIZED REPRESENTATION OF THE LETTERS, "DEA", AND MISCELLANEOUS DESIGN.

FOR CONSULTING SERVICES IN THE AREAS OF ARCHITECTURE, AIRPORT ENGINEERING AND DESIGN, TELECOMMUNICATIONS SYSTEMS ENGINEERING AND DESIGN, ECOSYSTEM AND ENVIRONMENTAL MANAGEMENT, ENGINEERING, LAND AND HYDROGRAPHIC SURVEYING, LAND USE PLANNING, REAL ESTATE, AND DESIGN OF BRIDGES, TRANSPORTATION SYSTEMS AND STATIONS, AND COMMUNICATIONS FACILITIES (U.S. CLS. 100 AND 101).

FIRST USE 4-1-2001; IN COMMERCE 4-1-2001.

SN 76-168,573. TEXTURA DESIGN, INC., THE WOOLANDS, TX. FILED 11-20-2000.

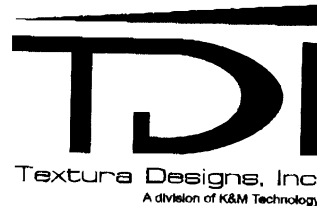

NO CLAIM IS MADE TO THE EXCLUSIVE RIGHT TO USE "DESIGNS INC." AND "A DIVISION OF K&M TECHNOLOGY", APART FROM THE MARK AS SHOWN.

FOR COMPUTER SERVICES, NAMELY, INTERNET WEB DESIGN FOR OTHERS (U.S. CLS. 100 AND 101).

FIRST USE 4-12-2000; IN COMMERCE 5-26-2000.

SN 76-170,157. KAHN-GAUTHIER LAW GROUP, L.L.C., METAIRIE, LA. FILED 11-21-2000.

JUSTICE IS NOW A CLICK AWAY!

FOR LEGAL SERVICES; INFORMATION SERVICES, NAMELY, PROVIDING AN ON-LINE COMPUTER DATABASE IN THE FIELD OF LEGAL INFORMATION, NAMELY, INFORMATION CONCERNING CLASS, OR OTHER MULTI-PLAINTIFF, LEGAL ACTIONS; INFORMATION SERVICES, NAMELY, PROVIDING LEGAL INFORMATION ON ONE OR MORE LEGAL PROCEEDINGS INVOLVING CLASS, OR OTHER MULTI-PLAINTIFF, ACTIONS VIA A GLOBAL COMPUTER NETWORK (U.S. CLS. 100 AND 101).

CLASS 42—(Continued).

SN 76-170,318. EURO ENTERPRISES, INC., DBA COMFORT CARE 4 KIDS, LAS VEGAS, NV. FILED 11-24-2000.



COMFORT CARE 4 KIDS

Serving Kids, Parents, and Employers

THE MARK CONSISTS OF A LITERAL ELEMENT PLUS A TEDDY BEAR HOLDING A SHADED OR LIGHT GREEN BLANKET.

FOR EMPLOYER-PROVIDED CHILD CARE FOR CHILDREN WHO ARE NOT SERIOUSLY ILL (U.S. CLS. 100 AND 101).

SN 76-171,289. CABC, INC., DALLAS, TX. FILED 11-27-2000.

BACKGROUND DELIVERY

FOR INTEGRATED SERVICE PROVIDER (ISP) SERVICES, SPECIFICALLY, INTEGRATION OF SOFTWARE COMPONENTS FOR PROVIDING COMPLETE SOLUTIONS FOR THE STORAGE, TARGETING, DELIVERY AND MANAGEMENT OF VIDEO, AUDIO, SOFTWARE AND OTHER FILES OVER THE INTERNET, AND CUSTOMIZATION OF USER INTERFACES TO PROVIDE SEPARATE COMMUNICATIONS CHANNELS, PROVIDING PUSH TECHNOLOGY USED TO TRANSFER INFORMATION BACK TO USER, INTEGRATED SYSTEMS FOR TARGETING AND REPORTING MEDIA DIGITIZATION, AND NETWORK PLATFORMS TO DELIVER DIGITIZED FILES TO SPECIFIC AUDIENCES (U.S. CLS. 100 AND 101).

FIRST USE 1-1-2000; IN COMMERCE 1-1-2000.

SN 76-171,527. DAUGHERTY SYSTEMS, INC., ST. LOUIS, MO. FILED 11-27-2000.



OWNER OF U.S. REG. NO. 2,417,626.
FOR CONSULTATION SERVICES IN THE FIELD OF COMPUTER SOFTWARE DEVELOPMENT (U.S. CLS. 100 AND 101).

FIRST USE 1-22-2000; IN COMMERCE 1-22-2000.

CLASS 42—(Continued).

SN 76-176,338. SMARTPIPES, INC., REDWOOD CITY, CA. FILED 12-4-2000.



FOR NETWORKING SERVICES IN THE NATURE OF INTEGRATION OF COMPUTER SYSTEMS AND NETWORKS NAMELY, ENABLING THE CREATION AND MANAGEMENT OF SECURE COMMUNICATIONS OVER A VARIETY OF DATA COMMUNICATION NETWORKS (U.S. CLS. 100 AND 101).

FIRST USE 3-0-2000; IN COMMERCE 3-0-2000.

SN 76-176,615. SYNXIS CORPORATION, MCLEAN, VA. FILED 12-6-2000.

SYNXIS AGENT

FOR APPLICATION SERVICES PROVIDER COMPUTER SERVICES, NAMELY PROVIDING, HOSTING, AND MAINTAINING ONLINE SOFTWARE FOR OTHERS THAT INTERFACES WITH A VARIETY OF DISTRIBUTION SYSTEMS, TRAVEL ARRANGERS, AND PROPERTY MANAGEMENT SYSTEMS TO ALLOW THE REAL-TIME BOOKING OF RESERVATIONS, MANAGEMENT OF ROOM INVENTORY, AND THE COLLECTION AND MANAGEMENT OF GUEST INFORMATION, ALL IN CONNECTION WITH THE HOSPITALITY INDUSTRY (U.S. CLS. 100 AND 101).

FIRST USE 12-0-1999; IN COMMERCE 12-0-1999.

CLASS 42—(Continued).

SN 76-176,797. VISA INTERNATIONAL SERVICE ASSOCIATION, FOSTER CITY, CA. FILED 12-6-2000.



OWNER OF U.S. REG. NOS. 1,071,114, 2,005,663 AND OTHERS.

FOR PROVIDING SEARCH ENGINES FOR OBTAINING DATA ON A GLOBAL COMPUTER NETWORK; COMPUTER SERVICES, NAMELY, PROVIDING INDEXES OF INFORMATION SITES AND OTHER RESOURCES AVAILABLE ON GLOBAL COMPUTER NETWORKS; PROVIDING SPECIFIC INFORMATION AS REQUESTED BY CUSTOMERS VIA THE INTERNET (U.S. CLS. 100 AND 101).

FIRST USE 8-11-2000; IN COMMERCE 8-11-2000.

SN 76-177,124. INT MEDIA GROUP, INCORPORATED, DARIEN, CT. BY CHANGE OF NAME INTERNET.COM CORPORATION, DARIEN, CT. FILED 12-7-2000.

ALL NET TRAINING

NO CLAIM IS MADE TO THE EXCLUSIVE RIGHT TO USE "NET TRAINING", APART FROM THE MARK AS SHOWN.

FOR COMPUTER SERVICES IN THE NATURE OF PROVIDING ONLINE ELECTRONIC PUBLICATIONS, NAMELY, BROCHURES, PAMPHLETS, AND DIRECTORIES IN THE FIELD OF INFORMATION TECHNOLOGIES (U.S. CLS. 100 AND 101).

SN 76-178,148. UNION PACIFIC CORPORATION, OMAHA, NE. FILED 12-7-2000.

VINVISION

FOR COMPUTER SERVICES, NAMELY, PROVIDING TEMPORARY USE OF NON-DOWNLOADABLE SOFTWARE THROUGH A GLOBAL COMPUTER NETWORK AND PRIVATE COMMUNICATION NETWORKS FOR MANAGEMENT OF INBOUND AND OUTBOUND INVENTORY, AND SHIPMENT MANAGEMENT; TRACKING AND PRODUCT MANAGEMENT FROM ORIGIN TO DESTINATION; CALCULATION, PROJECTION, MONITORING AND UPDATING OF TRANSIT TIMES; TRACKING AND MANAGEMENT OF ON-SITE STORAGE; CONSUMPTION RATES AND REPLENISHMENT PROJECTIONS; ORDER AND SHIPMENT TIMING; MONITORING INVENTORY; AND PREPARING MANAGEMENT REPORTS, ALERTS EXCEPTIONS AND STATISTICS FOR OTHERS; SOFTWARE MAINTENANCE AND SUPPORT (U.S. CLS. 100 AND 101).

CLASS 42—(Continued).

SN 76-180,826. SHEAHAN, MARGARET T., CALEDONIA, MI. FILED 12-14-2000.

TRUE GRITZ

FOR GRAPHIC ILLUSTRATION SERVICES FOR OTHERS, NAMELY, CREATING LOGOS AND IMAGES FOR WINDOWS, GLASS, STONES, METAL OBJECTS AND FIGURINES AND OTHER MATERIALS USING ETCHING (U.S. CLS. 100 AND 101).

FIRST USE 10-0-1991; IN COMMERCE 10-0-1991.

SN 76-181,966. SMITHKLINE BEECHAM CORPORATION, PHILADELPHIA, PA. FILED 12-15-2000.

MY WELLNESS MATTERS

OWNER OF U.S. REG. NOS. 1,928,735, 2,030,617 AND 2,050,611.

NO CLAIM IS MADE TO THE EXCLUSIVE RIGHT TO USE "WELLNESS", APART FROM THE MARK AS SHOWN.

FOR HEALTHCARE INFORMATION SERVICES (U.S. CLS. 100 AND 101).

SN 76-181,968. SMITHKLINE BEECHAM CORPORATION, PHILADELPHIA, PA. FILED 12-15-2000.

WELLNESS MATTERS

OWNER OF U.S. REG. NOS. 1,928,735, 2,030,617 AND 2,050,611.

NO CLAIM IS MADE TO THE EXCLUSIVE RIGHT TO USE "WELLNESS", APART FROM THE MARK AS SHOWN.

FOR HEALTHCARE INFORMATION SERVICES (U.S. CLS. 100 AND 101).

SN 76-183,034. BECTON DICKINSON AND COMPANY, FRANKLIN LAKES, NJ. FILED 12-18-2000.

INDISPENSABLE TO HUMAN HEALTH

FOR HEALTHCARE AND HEALTHCARE CONSULTING SERVICES (U.S. CLS. 100 AND 101).

FIRST USE 12-1-1999; IN COMMERCE 12-1-1999.

SN 76-186,607. WYNMAN, STANLEY JOE, BOGOTA, NJ. FILED 12-26-2000.

SPENCE-CHAPIN

FOR ADOPTION CONSULTATION SERVICES (U.S. CLS. 100 AND 101).

CLASS 42—(Continued).

SN 76-187,059. SUNFLOWER, INC., BROOKLYN, NY. FILED 12-15-2000.

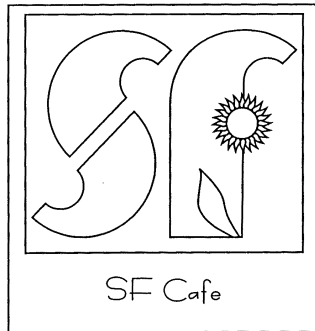

NO CLAIM IS MADE TO THE EXCLUSIVE RIGHT TO USE "CAFE", APART FROM THE MARK AS SHOWN, FOR RESTAURANT SERVICES (U.S. CLS. 100 AND 101).
FIRST USE 1-0-2000; IN COMMERCE 1-0-2000.

SN 76-188,737. CITY OF CONCORD, CONCORD, NC. FILED 1-2-2001.

CONCORD
NORTH CAROLINA
a city meeting the future...

NO CLAIM IS MADE TO THE EXCLUSIVE RIGHT TO USE "CONCORD NORTH CAROLINA", APART FROM THE MARK AS SHOWN.
FOR MUNICIPAL SERVICES (U.S. CLS. 100 AND 101).
FIRST USE 12-9-1999; IN COMMERCE 12-13-1999.

SN 76-189,216. GLOBAL MED-NET, INC., NAPERVILLE, IL. FILED 1-3-2001.

TRAVEL  NET

OWNER OF U.S. REG. NO. 2,397,512.
NO CLAIM IS MADE TO THE EXCLUSIVE RIGHT TO USE "TRAVEL" AND "NET", APART FROM THE MARK AS SHOWN.
FOR INFORMATION SERVICES, NAMELY, PROVIDING A COMPUTER DATABASE FEATURING EMERGENCY MEDICAL INFORMATION AND PERSONAL TRAVEL DATA (U.S. CLS. 100 AND 101).
FIRST USE 6-1-1999; IN COMMERCE 6-1-1999.

CLASS 42—(Continued).

SN 76-190,072. THOUGHTWARE TECHNOLOGIES, INC., GERMANTOWN, TN. FILED 1-8-2001.



THE MARK CONSISTS OF TWO VERTICAL OVALS AND ONE HORIZONTAL OVAL.
FOR APPLICATION SERVICE PROVIDER SERVICES, NAMELY, PROVIDING TEMPORARY USE OF ONLINE NON-DOWNLOADABLE SOFTWARE APPLICATIONS FOR EDUCATION AND TRAINING IN THE FIELD OF BUSINESS MANAGEMENT (U.S. CLS. 100 AND 101).
FIRST USE 7-0-1991; IN COMMERCE 7-0-1991.

SN 76-190,120. CELLEXCHANGE.COM, INC., CAMBRIDGE, MA. FILED 1-5-2001.

 **CELLEXCHANGE**

FOR COMPUTER SOFTWARE DESIGN AND DEVELOPMENT FOR OTHERS, COMPUTER SOFTWARE MAINTENANCE; COMPUTER CONSULTING SERVICES TO ENABLE MOBILE WIRELESS COMMUNICATION AND COMPUTING DEVICES TO ACCESS, SEND, RECEIVE, AND PROCESS INFORMATION VIA THE INTERNET AND PRIVATE COMPUTER NETWORKS (U.S. CLS. 100 AND 101).

SN 76-192,275. EVEREST CONNECTIONS CORPORATION, O'FALLON, MO. FILED 1-10-2001.

FULL CIRCUIT

FOR PROVIDING TECHNICAL SUPPORT SERVICES IN CONNECTION WITH ON-LINE NETWORK ACCESS (U.S. CLS. 100 AND 101).

CLASS 42—(Continued).

SN 76-192,442. TECHNOGYM S.R.L., I-47035 GAMBETTOLA (FORLI), ITALY, FILED 1-11-2001.

MY WELLNESS

PRIORITY CLAIMED UNDER SEC. 44(D) ON ITALY APPLICATION NO. IT-B02000C00, FILED 7-28-2000, REG. NO. 848.604, DATED 7-11-2001, EXPIRES 7-11-2011.

NO CLAIM IS MADE TO THE EXCLUSIVE RIGHT TO USE "WELLNESS", APART FROM THE MARK AS SHOWN.

FOR TECHNICAL CONSULTANCY IN THE MANAGEMENT AND USE OF COMPUTERS, COMPUTER SOFTWARE APPLICATIONS, EQUIPMENT FOR PHYSICAL EXERCISE AND MUSCLE REHABILITATION, AND DATABASES, ALL RELATING TO ACTIVITIES FOR PERSONAL FITNESS AND PHYSICAL WELL-BEING (U.S. CLS. 100 AND 101).

SN 76-193,098. KIPP, FLORES ARCHITECTS, AUSTIN, TX, FILED 1-12-2001.

KIPP ★ FLORES
ARCHITECTS

NO CLAIM IS MADE TO THE EXCLUSIVE RIGHT TO USE "ARCHITECTS", APART FROM THE MARK AS SHOWN.

FOR DESIGN, DRAFTING AND GRAPHIC RENDERING OF ARCHITECTURAL PLANS (U.S. CLS. 100 AND 101).

FIRST USE 1-0-1999; IN COMMERCE 1-0-1999.

SN 76-193,099. KIPP, FLORES ARCHITECTS, AUSTIN, TX, FILED 1-12-2001.

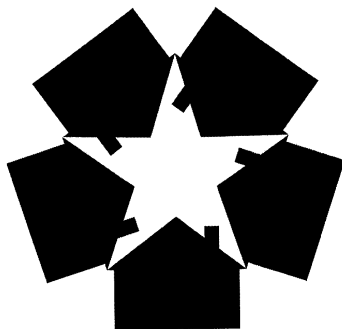

FOR DESIGN, DRAFTING AND GRAPHIC RENDERING OF ARCHITECTURAL PLANS (U.S. CLS. 100 AND 101).

FIRST USE 1-0-1999; IN COMMERCE 1-0-1999.

CLASS 42—(Continued).

SN 76-193,581. REXALL SUNDOWN, INC., BOCA RATON, FL. FILED 1-16-2001.

PLANET MUSCLE

FOR PROVIDING INFORMATION IN THE FIELD OF HEALTH, FITNESS AND NUTRITION VIA A WEB SITE ON A MULTI-USER GLOBAL COMPUTER INFORMATION NETWORK (U.S. CLS. 100 AND 101).

FIRST USE 8-15-1998; IN COMMERCE 8-15-1998.

SN 76-195,361. ALSUP, JANE, BRENTWOOD, TN. FILED 1-17-2001.

**NOTES FOR ANY MOMENT,
ANY TIME**

NO CLAIM IS MADE TO THE EXCLUSIVE RIGHT TO USE "NOTES", APART FROM THE MARK AS SHOWN.

FOR PROVIDING TEMPORARY USE OF ON-LINE NON-DOWNLOADABLE SOFTWARE FOR USE IN PREPARING COMPUTERIZED PERSONAL GREETINGS AND OTHER PERSONAL MESSAGES (U.S. CLS. 100 AND 101).

SN 76-199,549. ELDERPORT, INC., FALLS CHURCH, VA, FILED 1-25-2001.

ELDERPORT.COM

FOR PROVIDING A WEBSITE FOR FACILITATING THE COORDINATION OF CARE OF PERSONS IN LONG-TERM CARE FACILITIES AND HOME ENVIRONMENTS; DISSEMINATING INFORMATION CONCERNING CARE SERVICES, CARE FACILITIES, AND LONG-TERM HEALTHCARE PROVIDERS VIA THE INTERNET (U.S. CLS. 100 AND 101).

FIRST USE 11-0-1999; IN COMMERCE 11-0-1999.

SN 76-200,236. ZENGEN, INC., WOODLAND HILLS, CA, FILED 1-25-2001.

ABITIS

FOR TECHNICAL CONSULTATION AND RESEARCH AND DEVELOPMENT IN THE FIELDS OF PHARMACEUTICAL AND CHEMICAL PRODUCTS AND DRUG THERAPIES; PHARMACEUTICAL AND CHEMICAL DRUG DEVELOPMENT; PHARMACEUTICAL AND CHEMICAL ANALYSIS; DESIGN AND TESTING FOR NEW PRODUCT DEVELOPMENT; PRODUCT DEVELOPMENT CONSULTATION TO PHARMACEUTICAL AND CHEMICAL COMPANIES; AND PRODUCT RESEARCH AND DEVELOPMENT (U.S. CLS. 100 AND 101).

CLASS 42—(Continued).

SN 76-202,539. BRENTWOOD BAPTIST CHURCH, HOUSTON, TX. FILED 1-16-2001.

B BRENTWOOD BAPTIST CHURCH

NO CLAIM IS MADE TO THE EXCLUSIVE RIGHT TO USE "BAPTIST CHURCH", APART FROM THE MARK AS SHOWN.

FOR RELIGIOUS RETREAT SERVICES; CHARITABLE SERVICES, NAMELY, PROVIDING FOOD, CLOTHING AND/OR MEDICINE; COUNSELING IN THE FIELD OF RELIGION; AND MINISTERIAL SERVICES (U.S. CLS. 100 AND 101).

FIRST USE 11-27-2000; IN COMMERCE 11-27-2000.

SN 76-202,793. AMOROSO, CATHARINE B., BOCA RATON, FL. FILED 1-30-2001.

WILD HAIR SPA

NO CLAIM IS MADE TO THE EXCLUSIVE RIGHT TO USE "SPA", APART FROM THE MARK AS SHOWN.

FOR BEAUTY SALON AND SPA PERSONAL BODILY CARE, NAMELY COLORING, COSMETIC APPLICATION, CLEANSING, CUTTING, DYING, STYLING AND TRIMMING, OF HAIR, SKIN AND NAILS, FOR MEN, WOMEN AND CHILDREN (U.S. CLS. 100 AND 101).

SN 76-203,650. INTELLEGO, INC., MIDDLETOWN, OH. FILED 2-1-2001.

NETSEATS

FOR COMPUTER SERVICES, NAMELY DEVELOPING SOFTWARE FOR OTHERS FOR PROVIDING EVENT TICKETING INFORMATION AND SALES OVER A GLOBAL COMPUTER NETWORK, THROUGH TELECOMMUNICATIONS AND IN PERSON (U.S. CLS. 100 AND 101).

FIRST USE 12-2-1999; IN COMMERCE 12-2-1999.

SN 76-204,786. LOUISIANA DEPARTMENT OF SOCIAL SERVICES, BATON ROUGE, LA. FILED 2-1-2001.

GET R.E.A.L. DON'T GET PREGNANT

FOR PROMOTING THE PUBLIC AWARENESS OF THE NEED TO REDUCE TEEN PREGNANCY (U.S. CLS. 100 AND 101).

CLASS 42—(Continued).

SN 76-207,432. DAVID A. KOMATZ AND ASSOCIATES, INC., KALAMAZOO, MI. FILED 2-9-2001.

THE SOUP KETTLE

FOR RESTAURANTS (U.S. CLS. 100 AND 101).
FIRST USE 3-12-2001; IN COMMERCE 3-12-2001.

SN 76-208,554. VIVID MEDIA CREATIONS, INC, ATHENS, GA. FILED 2-12-2001.

EO STUDIOS

NO CLAIM IS MADE TO THE EXCLUSIVE RIGHT TO USE "STUDIOS", APART FROM THE MARK AS SHOWN.

FOR COMPUTER SERVICES, NAMELY, DESIGNING AND IMPLEMENTING WEBSITES FOR OTHERS; COMPUTER SOFTWARE DESIGN FOR OTHERS; COMPUTER PROGRAMMING FOR OTHERS; DATABASE DEVELOPMENT SERVICES; COMMERCIAL ART DESIGN; HOSTING THE WEBSITES OF OTHERS ON A COMPUTER SERVER FOR A GLOBAL COMPUTER NETWORK (U.S. CLS. 100 AND 101).

FIRST USE 9-30-1998; IN COMMERCE 10-21-1998.

SN 76-208,573. INTELLECTUAL PROPERTY GROUP, PLLC, THE, WASHINGTON, DC. FILED 2-9-2001.

IPG

FOR LEGAL SERVICES, NAMELY, LEGAL COUNSELING AND REPRESENTATION OF CLIENTS, AND THE PROVISION OF LEGAL ADVICE AND INFORMATION, ALSO SOMETIMES INVOLVING THE PROVISION OF LEGAL SERVICES IN THE AREAS OF LITIGATION OR IN CLIENT MATTERS INVOLVING BUSINESS OR PERSONAL AFFAIRS, AND THE PROVISION OF LEGAL SERVICES AND REPRESENTATION IN MATTERS INVOLVING INTELLECTUAL PROPERTY, AS WELL AS THE GENERAL PROVISION OF LEGAL SERVICES THAT INVOLVE THE REPRESENTATION OF CLIENTS AND THE PROVISION OF LEGAL ADVICE, INFORMATION, AND SERVICES THAT ARE DIRECTED TO BUSINESSES AND PROFESSIONALS IN THE ARTS, ADVERTISING, ACTING, COMMUNICATIONS, COMPUTER, DESIGN, ENTERTAINMENT, FILM AND VIDEO, INTERNET, MEDIA, MERCHANDISING, MUSIC, NEW MEDIA, PERFORMANCE, PHOTOGRAPHY, PUBLISHING, SOFTWARE, TELEVISION, WRITING AND RELATED INDUSTRIES AND PROFESSIONS (U.S. CLS. 100 AND 101).

FIRST USE 1-4-2001; IN COMMERCE 1-11-2001.

CLASS 42—(Continued).

SN 76-209,104. LOS ANGELES COUNTY SHERIFF'S DEPARTMENT, MONTEREY PARK, CA. FILED 2-12-2001.



NO CLAIM IS MADE TO THE EXCLUSIVE RIGHT TO USE "L.A. COUNTY SHERIFF" AND "EST. 1850" AND "DEPUTY", APART FROM THE MARK AS SHOWN.
 SEC. 2(F).
 FOR POLICE AND CIVIL PROTECTION SERVICES (U.S. CLS. 100 AND 101).
 FIRST USE 1-0-2000; IN COMMERCE 1-0-2000.

SN 76-211,217. EL PASO CORPORATION, HOUSTON, TX. FILED 2-15-2001.



OWNER OF U.S. REG. NOS. 1,876,839, 2,201,934 AND OTHERS.
 SEC. 2(F) AS TO "EL PASO".
 FOR GEOLOGICAL CONSULTING SERVICES; DESIGN OF PIPELINE SYSTEMS AND ENERGY GENERATING FACILITIES TO THE ORDER AND SPECIFICATION OF OTHERS; TESTING OF PIPELINE SYSTEMS; NATURAL GAS EXPLORATION AND PROVIDING CONSULTING SERVICES IN THE FIELDS OF ESTABLISHMENT OF TURN-KEY PIPELINE SYSTEMS AND ELECTRICITY GENERATION FACILITIES, NAMELY, DESIGN, STARTUP, TESTING AND INITIAL OPERATION OF SUCH SYSTEMS AND FACILITIES; DIAGNOSTIC TESTING SERVICES IN THE FIELD OF EQUIPMENT AND FACILITIES FOR ENERGY GENERATION, TRANSMISSION AND DISTRIBUTION SYSTEMS AND RELATED FACILITIES; CHARITABLE AND PHILANTHROPIC FOUNDATION SERVICES IN THE NATURE OF IN-KIND DONATIONS TO COMMUNITIES, EDUCATIONAL INSTITUTIONS, CHARITIES AND OTHERS; AND SERVING AS LIAISON BETWEEN NATURAL GAS END-USERS AND NATURAL GAS MARKETERS, NAMELY, ASSISTING UTILITIES, INDUSTRIAL AND COMMERCIAL CUSTOMERS AND OTHERS ARRANGE THE MOST COST-EFFECTIVE GAS SUPPLIES AND TRANSPORTATION ARRANGEMENTS FOR THEIR FACILITIES (U.S. CLS. 100 AND 101).
 FIRST USE 2-5-2001; IN COMMERCE 2-5-2001.

CLASS 42—(Continued).

SN 76-211,219. EL PASO CORPORATION, FORMERLY EL PASO ENERGY CORPORATION, HOUSTON, TX. FILED 2-15-2001.



FOR GEOLOGICAL CONSULTING SERVICES; DESIGN OF PIPELINE SYSTEMS AND ENERGY GENERATING FACILITIES TO THE ORDER AND SPECIFICATION OF OTHERS; TESTING OF PIPELINE SYSTEMS; NATURAL GAS EXPLORATION AND PROVIDING CONSULTING SERVICES IN THE FIELDS OF ESTABLISHMENT OF TURN-KEY PIPELINE SYSTEMS AND ELECTRICITY GENERATION FACILITIES, NAMELY, DESIGN, STARTUP, TESTING AND INITIAL OPERATION OF SUCH SYSTEMS AND FACILITIES; DIAGNOSTIC TESTING SERVICES IN THE FIELD OF EQUIPMENT AND FACILITIES FOR ENERGY GENERATION, TRANSMISSION AND DISTRIBUTION SYSTEMS AND RELATED FACILITIES; AND, CHARITABLE AND PHILANTHROPIC FOUNDATION SERVICES IN THE NATURE OF IN-KIND DONATIONS TO COMMUNITIES, EDUCATIONAL INSTITUTIONS, CHARITIES AND OTHERS; AND SERVING AS LIAISON BETWEEN NATURAL GAS END-USERS AND NATURAL GAS MARKETERS, NAMELY, ASSISTING UTILITIES, INDUSTRIAL AND COMMERCIAL CUSTOMERS AND OTHERS ARRANGE THE MOST COST-EFFECTIVE GAS SUPPLIES AND TRANSPORTATION ARRANGEMENTS FOR THEIR FACILITIES (U.S. CLS. 100 AND 101).
 FIRST USE 2-5-2001; IN COMMERCE 2-5-2001.

SN 76-212,105. CLINICAL TRIALS NET, INC., CHARLESTON, SC. FILED 2-20-2001.

CLINTRINET

FOR PROVIDING ACCESS TO ON-LINE NON-DOWNLOADABLE SOFTWARE FOR DESIGNING AND OPERATING CLINICAL TRIALS DATA MANAGEMENT DATABASES (U.S. CLS. 100 AND 101).

SN 76-212,106. CLINICAL TRIALS NET, INC., CHARLESTON, SC. FILED 2-20-2001.



FOR PROVIDING ACCESS TO ON-LINE NON-DOWNLOADABLE SOFTWARE FOR DESIGNING AND OPERATING CLINICAL TRIALS DATA MANAGEMENT DATABASES (U.S. CLS. 100 AND 101).

CLASS 42—(Continued).

SN 76-212,107. CLINICAL TRIALS NET, INC., CHARLESTON, SC. FILED 2-20-2001.

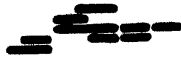

Clinical Trials Net

NO CLAIM IS MADE TO THE EXCLUSIVE RIGHT TO USE "CLINICAL TRIALS" AND "NET", APART FROM THE MARK AS SHOWN.

FOR PROVIDING ACCESS TO ON-LINE NON-DOWNLOADABLE SOFTWARE FOR DESIGNING AND OPERATING CLINICAL TRIALS DATA MANAGEMENT DATABASES (U.S. CLS. 100 AND 101).



SN 76-212,349. BIOMET, INC., WARSAW, IN. FILED 2-14-2001.

MEDMENTOR

FOR PROVIDING AN INTERACTIVE WEBSITE ON THE INTERNET FEATURING INFORMATION IN THE FIELD OF ORTHOPEDIC AND SPORTS MEDICINE (U.S. CLS. 100 AND 101).



SN 76-212,622. ALATRON CORPORATION, SEATTLE, WA. FILED 2-20-2001.

**REVOLUTIONIZING
PRODUCT DEVELOPMENT**

NO CLAIM IS MADE TO THE EXCLUSIVE RIGHT TO USE "PRODUCT DEVELOPMENT", APART FROM THE MARK AS SHOWN.

FOR PROVIDING INFORMATION OVER COMPUTER NETWORKS AND GLOBAL COMMUNICATIONS NETWORKS IN THE FIELD OF ENGINEERING, ELECTRONICS, SEMICONDUCTORS, WIRELESS DEVICES, COMPUTERS, AND PRODUCT DEVELOPMENT; PROVIDING TEMPORARY USE OF ON-LINE NON-DOWNLOADABLE SOFTWARE FOR PRODUCT DEVELOPMENT AND SAMPLE PROCUREMENT; AND PROVIDING SEARCH ENGINES FOR OBTAINING DATA ON A GLOBAL COMPUTER NETWORK (U.S. CLS. 100 AND 101).

CLASS 42—(Continued).

SN 76-213,780. PARAISO LOS CABOS S.A. DE CV, BAJA CALIFORNIA SUR 23400, MEXICO, FILED 2-20-2001.

LAS VENTANAS TELLURIDE

NO CLAIM IS MADE TO THE EXCLUSIVE RIGHT TO USE "TELLURIDE", APART FROM THE MARK AS SHOWN.

THE ENGLISH TRANSLATION OF "LAS VENTANAS" IS "WINDOWS".

FOR HOTEL AND RESORT SERVICES; PROVISION OF GENERAL PURPOSE FACILITIES FOR MEETINGS, CONFERENCES AND EXHIBITIONS, AND RESERVATION SERVICES FOR HOTEL ACCOMMODATIONS (U.S. CLS. 100 AND 101).



SN 76-213,931. GLOBALFILINGS, INC., NEW YORK, NY. FILED 2-21-2001.

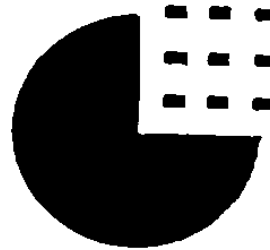

FOR DATABASE DEVELOPMENT SERVICES; CONSULTATION SERVICES IN THE FIELD OF DATABASE AND SOFTWARE DEVELOPMENT; COMPUTER SOFTWARE DESIGN FOR OTHERS (U.S. CLS. 100 AND 101).



SN 76-216,326. CORLIANT, INC., TREVOSE, PA. FILED 2-23-2001.

**CORLIANT INTELLIGENT
INTERNETWORKING**

NO CLAIM IS MADE TO THE EXCLUSIVE RIGHT TO USE "INTELLIGENT INTERNETWORKING", APART FROM THE MARK AS SHOWN.

FOR COMPUTER AND COMPUTER SOFTWARE CONSULTATION; TECHNICAL CONSULTATION IN THE FIELD OF COMPUTER NETWORKING (U.S. CLS. 100 AND 101).

FIRST USE 9-11-2000; IN COMMERCE 9-11-2000.

CLASS 42—(Continued).

SN 76-219,478. SAUNDERS HOTEL GROUP, LTD., BOSTON, MA. FILED 3-5-2001.

SERVING YOU & THE ENVIRONMENT

FOR HOTEL AND RESTAURANT SERVICES; HOTEL SERVICES FOR PREFERRED CUSTOMERS (U.S. CLS. 100 AND 101).

FIRST USE 3-0-1999; IN COMMERCE 3-0-1999.

SN 76-219,646. DAIRY MANAGEMENT INC., ROSEMONT, IL. FILED 3-6-2001.



NO CLAIM IS MADE TO THE EXCLUSIVE RIGHT TO USE "THE INTERACTIVE DAIRY INGREDIENTS ADVISOR", APART FROM THE MARK AS SHOWN.

FOR PROVIDING INFORMATION IN THE FIELD OF DAIRY INGREDIENTS, THEIR USES, AND SUPPLIERS AND RECOMMENDATIONS ABOUT DAIRY INGREDIENTS TO FOOD TECHNOLOGISTS VIA THE INTERNET (U.S. CLS. 100 AND 101).

FIRST USE 3-1-2001; IN COMMERCE 3-1-2001.

SN 76-220,562. ALSON, JOEL T., DBA OS THESAURUS, HOUSTON, TX. FILED 3-6-2001.

OS THESAURUS

NO CLAIM IS MADE TO THE EXCLUSIVE RIGHT TO USE "OS", APART FROM THE MARK AS SHOWN.

FOR COMPUTER SERVICES, NAMELY COMPUTER CODE CONVERSION FOR OTHERS FROM ONE OPERATING SYSTEM TO ANOTHER (U.S. CLS. 100 AND 101).

FIRST USE 2-20-2001; IN COMMERCE 2-20-2001.

SN 76-221,217. ASPEN LOGIC, INC., BROOMFIELD, CO. FILED 3-7-2001.

ASPENLOGIC

FOR CONSULTING SERVICES IN THE FIELD OF ELECTRONIC HARDWARE DESIGN, ELECTRONIC HARDWARE DESIGN VERIFICATION AND ELECTRONIC HARDWARE IMPLEMENTATION IN THE NATURE OF DESIGN REQUIREMENT DEVELOPMENT (U.S. CLS. 100 AND 101).

FIRST USE 9-0-1999; IN COMMERCE 9-0-1999.

CLASS 42—(Continued).

SN 76-221,416. TWINSTRAND THERAPEUTICS, INC., BUR-NABY, BRITISH COLUMBIA, CANADA, FILED 3-7-2001.

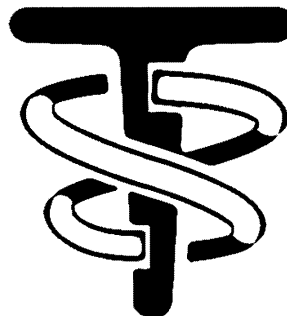

THE MARK CONSISTS OF THE STYLIZED LETTER "T". FOR MEDICAL TESTING AND RESEARCH SERVICES IN THE FIELD OF BIOPHARMACOLOGY (U.S. CLS. 100 AND 101).

SN 76-222,864. GALINDO INDUSTRIES CORPORATION, HOLLYWOOD, CA. FILED 3-9-2001.

DAY AFTER

FOR OPERATION A NIGHTCLUB (U.S. CLS. 100 AND 101).

SN 76-227,900. HEALTHANSWERS, INC., NORTH WALES, PA. FILED 3-21-2001.



OWNER OF U.S. REG. NO. 1,769,012. SEC. 2(F) AS TO "HEALTH ANSWERS". FOR MEDICAL INFORMATION SERVICES (U.S. CLS. 100 AND 101).

FIRST USE 5-0-2000; IN COMMERCE 5-0-2000.

CLASS 42—(Continued).

SN 76-229,172. U.S. FRANCHISE SYSTEMS, INC., ATLANTA, GA. FILED 3-23-2001.



NO CLAIM IS MADE TO THE EXCLUSIVE RIGHT TO USE "INN", APART FROM THE MARK AS SHOWN.
FOR HOTEL AND MOTEL SERVICES (U.S. CLS. 100 AND 101).

FIRST USE 4-0-1974; IN COMMERCE 4-0-1974.

SN 76-229,971. U.S. FRANCHISE SYSTEMS, INC., ATLANTA, GA. FILED 3-23-2001.



NO CLAIM IS MADE TO THE EXCLUSIVE RIGHT TO USE "SUITES", APART FROM THE MARK AS SHOWN.
FOR HOTEL AND MOTEL SERVICES (U.S. CLS. 100 AND 101).

FIRST USE 11-2-1997; IN COMMERCE 11-2-1997.

SN 76-231,713. METROMEDIA STEAKHOUSES COMPANY, L.P., PLANO, TX. FILED 3-28-2001.

A REAL MEAL. REAL FAST.

NO CLAIM IS MADE TO THE EXCLUSIVE RIGHT TO USE "MEAL", APART FROM THE MARK AS SHOWN.
FOR RESTAURANT SERVICES (U.S. CLS. 100 AND 101).

CLASS 42—(Continued).

SN 76-232,775. USGENWEB PROJECT, THE, CHATTANOOGA, TN. FILED 3-30-2001.

THE USGENWEB PROJECT

NO CLAIM IS MADE TO THE EXCLUSIVE RIGHT TO USE "PROJECT", APART FROM THE MARK AS SHOWN.

FOR GENEALOGY RESEARCH, NAMELY, PROVIDING GENEALOGICAL DATA AND ASSISTANCE IN THE FORM OF GENEALOGICAL QUERIES, SURNAME LISTINGS, VITAL RECORDS, NAMELY, BIRTH RECORDS, MARRIAGE RECORDS, DEATH RECORDS, CENSUS RECORDS, WILLS AND OTHER PROBATE RECORDS, DEEDS AND OTHER LAND RECORDS, CEMETERY RECORDS, OBITUARIES, BIOGRAPHIES, FAMILY HISTORIES, BIBLE RECORDS, CHURCH RECORDS, PENSION RECORDS, MILITARY RECORDS, COUNTY HISTORIES, MAPS, AND OTHER GENEALOGICAL RESEARCH RESOURCES, AND PROVIDING CUSTOMIZED ONLINE WEB PAGES FEATURING USER-DEFINED INFORMATION, WHICH FEATURE ONLINE WEB LINKS TO OTHER WEB SITES IN THE FIELD OF GENEALOGY (U.S. CLS. 100 AND 101).

FIRST USE 6-0-1996; IN COMMERCE 6-0-1996.

SN 76-232,944. SUSHI DELI EXPRESS, INC., SAN DIEGO, CA. FILED 3-26-2001.

SUSHI DELI

SEC. 2(F).
FOR RESTAURANT AND CATERING SERVICES (U.S. CLS. 100 AND 101).

FIRST USE 6-18-1983; IN COMMERCE 6-18-1993.

SN 76-238,976. PRECISION FOODS, INC., ST. LOUIS, MO. FILED 4-11-2001.

MRS. WAGES

OWNER OF U.S. REG. NOS. 952,764, 1,245,534 AND OTHERS.

THE NAME "MRS. WAGES" DOES NOT IDENTIFY A PARTICULAR LIVING INDIVIDUAL.

FOR PROVIDING INFORMATION ON FOOD CANNING, CANNING INGREDIENTS, AND RECIPES THROUGH A GLOBAL COMPUTER NETWORK (U.S. CLS. 100 AND 101).

FIRST USE 12-1-1998; IN COMMERCE 12-1-1998.

CLASS 42—(Continued).

SN 76-241,154. FRESH START RECOVERY RESIDENCE, INC., FREEPORT, NY. FILED 4-16-2001.

**FRESH START RECOVERY
RESIDENCE, INC.**

NO CLAIM IS MADE TO THE EXCLUSIVE RIGHT TO USE "RECOVERY RESIDENCE, INC.", APART FROM THE MARK AS SHOWN.

FOR PROVIDING TEMPORARY HOUSING ACCOMMODATIONS, NAMELY, A RESIDENCE FOR HOMELESS PERSONS AND PERSONS IN RECOVERY FROM SUBSTANCE ABUSE (U.S. CLS. 100 AND 101).

FIRST USE 8-1-1997; IN COMMERCE 8-0-1998.

CLASS 42—(Continued).

SN 76-249,397. AMERICAN ACCESSORIES INTERNATIONAL LLC, KNOXVILLE, TN. FILED 5-1-2001.



OWNER OF U.S. REG. NO. 1,735,460.

NO CLAIM IS MADE TO THE EXCLUSIVE RIGHT TO USE "ACCESSORIES", APART FROM THE MARK AS SHOWN.

SEC. 2(F) AS TO "AMERICAN".

FOR DESIGN AND DEVELOPMENT OF PRIVATE LABEL AND PREMIUM INCENTIVE PRODUCTS, FOR OTHERS, UTILIZED BY CLIENTS TO ASSIST IN THE SALE OF THEIR PRODUCTS (U.S. CLS. 100 AND 101).

FIRST USE 0-0-1984; IN COMMERCE 0-0-1984.

SN 76-246,841. CHRISTIAN MEDICAL AND DENTAL SOCIETY, BRISTOL, TN. FILED 4-20-2001.



NO CLAIM IS MADE TO THE EXCLUSIVE RIGHT TO USE "CHRISTIAN MEDICAL ASSOCIATION", APART FROM THE MARK AS SHOWN.

FOR ASSOCIATION SERVICES, NAMELY PROMOTING THE INTERESTS, GOALS AND OBJECTIVES OF CHRISTIAN PHYSICIANS (U.S. CLS. 100 AND 101).

FIRST USE 6-8-2000; IN COMMERCE 6-8-2000.

SN 76-254,269. KANSAS HEALTH FOUNDATION, WICHITA, KS. FILED 5-8-2001.

**TAKE A SECOND. MAKE A
DIFFERENCE.**

FOR CHARITABLE HEALTHCARE FOUNDATION SERVICES, NAMELY, PROMOTING AND IMPROVING HEALTH THROUGH THE DISSEMINATION OF INFORMATION AND PUBLIC CAMPAIGNS (U.S. CLS. 100 AND 101).

FIRST USE 1-22-2001; IN COMMERCE 1-22-2001.

SN 76-247,957. POWERSHIFT, INC., ORLANDO, FL. FILED 4-30-2001.



FOR APPLICATION SERVICE PROVIDER (ASP) FEATURING SOFTWARE IN THE FIELD OF INFORMATION DATABASE MANAGEMENT AND BUSINESS ANALYTICS (U.S. CLS. 100 AND 101).

SN 76-254,982. PRINTERON CORPORATION, KITCHENER, ONTARIO, CANADA. FILED 5-10-2001.

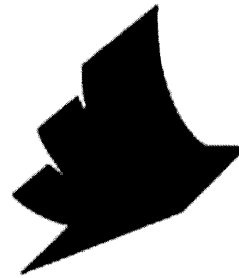

PRIORITY CLAIMED UNDER SEC. 44(D) ON CANADA APPLICATION NO. 1096619, FILED 3-20-2001.

FOR PROVISION OF A GLOBAL PRINT NETWORK AND A GLOBAL PRINT REGISTRY WHICH ENABLE GLOBAL COMPUTER NETWORK USERS TO LOCATE, ACCESS, SEARCH, STORE AND PRINT INFORMATION TO GLOBAL COMPUTER NETWORK ENABLED PRINTERS OR FAX MACHINES; CONVERTING ORDINARY PRINTERS INTO GLOBAL COMPUTER NETWORK ENABLED PRINTERS (U.S. CLS. 100 AND 101).

FIRST USE 3-13-2001; IN COMMERCE 3-13-2001.

CLASS 42—(Continued).

SN 76-256,646. AOA FINANCIAL SERVICES, DBA RESORT FINANCIAL SERVICES, HALEIWA, HI. FILED 5-15-2001.

CLASS 42—(Continued).

SN 76-259,394. KAPLAN, BEN, NEW YORK, NY. FILED 5-18-2001.

RENOVATION MADE EASY

FOR LEASING SERVICES FOR INTERIOR AND EXTERIOR IMPROVEMENTS TO PROPERTIES, NAMELY, LEASING OF HOUSEHOLD FURNISHINGS, FURNITURE, CARPETS AND RUGS, HOUSEHOLD DECORATIONS, PAINTINGS AND PICTURES, HOUSEHOLD APPLIANCES, DISHWARE AND LINENS (U.S. CLS. 100 AND 101).

FIRST USE 5-16-1997; IN COMMERCE 5-16-1997.

SN 76-258,208. GEISINGER HEALTH SYSTEM FOUNDATION, DANVILLE, PA. FILED 5-17-2001.



OWNER OF U.S. REG. NOS. 1,362,526, 2,089,159 AND OTHERS.

NO CLAIM IS MADE TO THE EXCLUSIVE RIGHT TO USE "HEART INSTITUTE", APART FROM THE MARK AS SHOWN.

FOR PROVIDING HEALTH CARE SERVICES FOR CARDIAC PATIENTS (U.S. CLS. 100 AND 101).
FIRST USE 10-20-2000; IN COMMERCE 10-20-2000.

SN 76-259,393. KAPLAN, BEN, NEW YORK, NY. FILED 5-18-2001.



FOR PEN PAL SUBSCRIPTION SERVICE (U.S. CLS. 100 AND 101).



GALICAT

FOR PEN PAL SUBSCRIPTION SERVICE (U.S. CLS. 100 AND 101).

SN 76-259,395. KAPLAN, BEN, NEW YORK, NY. FILED 5-18-2001.



EGO TRIP

FOR PEN PAL SUBSCRIPTION SERVICE (U.S. CLS. 100 AND 101).

CLASS 42—(Continued).

SN 76-259,396. KAPLAN, BEN, NEW YORK, NY. FILED 5-18-2001.

**ALISON ADVENTURE**

FOR PEN PAL SUBSCRIPTION SERVICE (U.S. CLS. 100 AND 101).

SN 76-262,778. LANDATA SYSTEMS, INC., HOUSTON, TX. FILED 5-25-2001.

TITLELOGIX.COM

FOR APPLICATION SERVICE PROVIDER, NAMELY, CREATING AND MAINTAINING COMPUTER SOFTWARE PROGRAMS FOR USE BY OTHERS, AND HOSTING SUCH SOFTWARE ON A COMPUTER SERVER FOR A GLOBAL COMPUTER NETWORK (U.S. CLS. 100 AND 101).

FIRST USE 4-1-2001; IN COMMERCE 4-1-2001.

SN 76-264,206. HAESTAD METHODS, INC., WATERBURY, CT. FILED 5-31-2001.

CLIENTCARE

FOR OFFERING ENGINEERING AND TECHNICAL ASSISTANCE BY TELEPHONE, ELECTRONIC MAIL AND IN-PERSON RELATING TO CIVIL ENGINEERING; PROVIDING INFORMATION RELATING TO CIVIL ENGINEERING, HYDROLOGY, HYDRAULICS AND TECHNICAL DEVELOPMENTS IN THE FIELD OF CIVIL ENGINEERING; COMPUTER SOFTWARE MAINTENANCE IN THE FIELD OF CIVIL ENGINEERING; UPDATING COMPUTER SOFTWARE FOR OTHERS IN THE FIELD OF CIVIL ENGINEERING COMPUTER SOFTWARE; COMPUTER CONSULTATION SERVICES RELATING TO CIVIL ENGINEERING (U.S. CLS. 100 AND 101).

FIRST USE 2-0-2000; IN COMMERCE 2-0-2000.

CLASS 42—(Continued).

SN 76-265,351. MARY M. GOOLEY HEMOPHILIA CENTER, INC., ROCHESTER, NY. FILED 6-1-2001.



NO CLAIM IS MADE TO THE EXCLUSIVE RIGHT TO USE "HEMOPHILIA CENTER", APART FROM THE MARK AS SHOWN.

THE NAME IN THE MARK IDENTIFIES A LIVING INDIVIDUAL WHOSE CONSENT IS OF RECORD.

FOR MEDICAL SERVICES; COUNSELING SERVICES AND CLINICAL RESEARCH IN THE FIELD OF INHERITED DISORDERS RELATED TO HEMATOLOGY AND ADVOCACY SERVICES FOR PATIENTS (U.S. CLS. 100 AND 101).

FIRST USE 6-15-2001; IN COMMERCE 6-15-2001.

SN 76-265,641. HEALTHCOMMUNITIES.COM, INC., NORTHAMPTON, MA. FILED 6-4-2001.



NO CLAIM IS MADE TO THE EXCLUSIVE RIGHT TO USE "SLEEP NEWS & INFORMATION", APART FROM THE MARK AS SHOWN.

THE MARK CONSISTS IN PART OF THE WORDS "SLEEPWORLD" BESIDE A CIRCULAR GRAPHIC DESIGN OF A LOWER CASE "S" AND UPPER CASE "W" INSIDE OF THE CIRCLE.

FOR PROVIDING A WEBSITE FEATURING INFORMATION ON MEDICAL TOPICS CONCERNING SLEEP ILLNESSES AND RELATED MATTERS BY MEANS OF A GLOBAL COMPUTER NETWORK (U.S. CLS. 100 AND 101).

FIRST USE 10-1-2000; IN COMMERCE 10-1-2000.

SN 76-267,708. TRIO SALON LTD., CHICAGO, IL. FILED 6-6-2001.

T-R-I-O REASON IS OBVIOUS

OWNER OF U.S. REG. NOS. 1,845,244 AND 1,935,504. FOR HAIR SALON SERVICES (U.S. CLS. 100 AND 101). FIRST USE 11-7-1998; IN COMMERCE 11-7-1998.

CLASS 42—(Continued).

SN 76-269,145. DESSAINT, STEPHANE, NEW YORK, NY. FILED 4-4-2001.

DOMICILE

FOR RESTAURANTS (U.S. CLS. 100 AND 101).

SN 76-270,200. TOM'S GUIDES PUBLISHING AG, D-85622 FELDKIRCHEN, FED REP GERMANY, FILED 6-11-2001.

TOM'S HARDWARE GUIDE

NO CLAIM IS MADE TO THE EXCLUSIVE RIGHT TO USE "HARDWARE GUIDE", APART FROM THE MARK AS SHOWN.

FOR PROVIDING ON-LINE MAGAZINES FEATURING INFORMATION AND PRODUCT REVIEWS ABOUT THE COMPUTER HARDWARE AND SOFTWARE PRODUCTS OF OTHERS VIA A GLOBAL COMPUTER NETWORK (U.S. CLS. 100 AND 101).

FIRST USE 9-0-1996; IN COMMERCE 9-0-1996.

SN 76-271,549. HEALTHCOMP EVALUATION SERVICES CORPORATION, SARASOTA, FL. FILED 6-15-2001.

EXEMPLAR

FOR SUBSTANCE ABUSE AND HEALTH SCREENING SERVICES; NAMELY, PERFORMANCE OF SCREENING SERVICES, MAINTENANCE OF SCREENING AND HEALTH RECORDS, WORKSITE MEDICAL SURVEILLANCE, AND INDUSTRIAL HYGIENE AND SAFETY CONSULTING (U.S. CLS. 100 AND 101).

FIRST USE 4-9-2001; IN COMMERCE 4-9-2001.

SN 76-273,326. EDWARDS LIFESCIENCES CORPORATION, IRVINE, CA. FILED 6-19-2001.

SAPIEN THERAPEUTICS

NO CLAIM IS MADE TO THE EXCLUSIVE RIGHT TO USE "THERAPEUTICS", APART FROM THE MARK AS SHOWN.

FOR MEDICAL SERVICES RELATED TO CARDIOVASCULAR THERAPEUTICS AND DELIVERY SYSTEMS BY ENGINEERING OF GENES AND OR PROTIENS (U.S. CLS. 100 AND 101).

SN 76-280,160. GAX CORP., MT. LAUREL, NJ. FILED 7-3-2001.

GAX

FOR COMPUTER SERVICES, NAMELY, CREATING AND MAINTAINING WEB SITES FOR OTHERS (U.S. CLS. 100 AND 101).

FIRST USE 9-19-1995; IN COMMERCE 9-19-1995.

CLASS 42—(Continued).

SN 76-283,731. WASHINGTON MUTUAL, INC., SEATTLE, WA. FILED 7-10-2001.

OPTISVALUE

FOR PROVIDING TEMPORARY USE OF ONLINE NON-DOWNLOADABLE LOAN APPRAISAL, ORIGINATION, PROCESSING AND MAINTENANCE SOFTWARE FOR USE BY REAL PROPERTY, REAL ESTATE AND COLLATERAL APPRAISERS, LENDERS, BANKS, MORTGAGE BROKERS, LOAN CONSULTANTS, CONSUMER LOAN CUSTOMERS, AND MORTGAGE LOAN CUSTOMERS; PROVIDING TEMPORARY USE OF ONLINE NON-DOWNLOADABLE SOFTWARE FOR USE BY REAL PROPERTY, REAL ESTATE AND COLLATERAL APPRAISERS, LENDERS, MORTGAGE BROKERS, LOAN CONSULTANTS, CONSUMER LOAN CUSTOMERS, AND MORTGAGE LOAN CUSTOMERS TO TRACK THE STATUS OF LOANS, NAMELY TO TRACK INFORMATION REGARDING LOAN APPRAISALS, ORIGINATION, PROCESSING AND MAINTENANCE; PROVIDING TEMPORARY USE OF ONLINE NON-DOWNLOADABLE SOFTWARE FOR USE IN PROVIDING CONSUMER AND MORTGAGE LENDING SERVICES; PROVIDING TEMPORARY USE OF ONLINE NON-DOWNLOADABLE SOFTWARE FOR USE IN CONNECTION WITH REAL PROPERTY, REAL ESTATE AND COLLATERAL APPRAISALS AND FORECLOSURES (U.S. CLS. 100 AND 101).

SN 76-283,843. JOSEPH, RICHARD ANTHONY, ATLANTA, GA. FILED 7-13-2001.

AFRICAN PATHWAYS

NO CLAIM IS MADE TO THE EXCLUSIVE RIGHT TO USE "AFRICAN", APART FROM THE MARK AS SHOWN.

FOR EDUCATIONAL SERVICES, NAMELY, PROVIDING POLICY RELATED PROJECTS ON APPROPRIATE STRATEGIES FOR PROMOTING PEACE, DEVELOPMENT AND DEMOCRACY IN AFRICA (U.S. CLS. 100 AND 101).

SN 76-287,526. AMERICAN MEDICAL REHAB ASSOCIATES, INC., PLANTATION, FL. FILED 7-19-2001.

AMEDRA

FOR MEDICAL SERVICES, INCLUDING PHYSICAL THERAPY, CHIROPRACTIC, MASSAGE, WEIGHT LOSS, DIET, ACUPUNCTURE, URGENT CARE, PHYSICAL EXAMINATION AND DRUG TESTING (U.S. CLS. 100 AND 101).

CLASS 42—(Continued).

SN 76-291,225. GOODTHINGS.COM, INC., SEATTLE, WA. FILED 7-6-2001.

VITAMIN G

FOR COMPUTER SERVICES, NAMELY PROVIDING AND SYNDICATING AN ON-LINE COLUMN OFFERING TIPS AND ADVICE FOR DAILY LIVING; PROVIDING TIPS AND ADVICE FOR DAILY LIVING VIA ELECTRONIC MAIL AND WIRELESS APPLICATIONS (U.S. CLS. 100 AND 101).

SN 76-292,363. USPOWERSOLUTIONS CORPORATION, CAMBRIDGE, MA. FILED 8-1-2001.



OWNER OF U.S. REG. NO. 2,392,732.
 ANY STIPPLING THAT MAY APPEAR IS A FEATURE OF THE MARK AND IS NOT INTENDED TO INDICATE COLOR.
 FOR COMPUTER HARDWARE AND SOFTWARE DESIGN SERVICES FOR DEREGULATED ENERGY SUPPLIERS, MARKETERS, AGGREGATORS, AND CONVERGENT SERVICE PROVIDERS (U.S. CLS. 100 AND 101).
 FIRST USE 1-1-2001; IN COMMERCE 1-1-2001.

SN 76-293,121. FINE HOST CORPORATION, GREENWICH, CT. FILED 8-1-2001.



THE STIPPLING SHOWN IN THE DRAWING IS A FEATURE OF THE MARK AND NOT INTENDED TO INDICATE COLOR.
 FOR RESTAURANT, CAFETERIA AND CONTRACT FOOD SERVICES (U.S. CLS. 100 AND 101).

CLASS 42—(Continued).

SN 76-294,076. HYATT CORPORATION, CHICAGO, IL. FILED 7-30-2001.

E-MMEDIATE MEETINGS

NO CLAIM IS MADE TO THE EXCLUSIVE RIGHT TO USE "MEETINGS", APART FROM THE MARK AS SHOWN.
 FOR PROVIDING GENERAL PURPOSE CONVENTION FACILITIES; PARTY PLANNING CONSULTATION SERVICES; AND MAKING CONVENTION AND MEETING RESERVATIONS FOR OTHERS (U.S. CLS. 100 AND 101).

SN 76-299,054. WILDLIFE LEGISLATIVE FUND OF AMERICA, COLUMBUS, OH. FILED 8-13-2001.



NO CLAIM IS MADE TO THE EXCLUSIVE RIGHT TO USE "WILDLIFE LEGISLATIVE FUND OF AMERICA" OR THE GEOGRAPHICAL OUTLINE OF THE UNITED STATES, APART FROM THE MARK AS SHOWN.
 FOR ASSOCIATION SERVICES, NAMELY, PROMOTING THE INTERESTS OF HUNTERS, TRAPPERS AND ANGLERS THROUGH THE LEGISLATIVE PROCESS (U.S. CLS. 100 AND 101).
 FIRST USE 6-26-1978; IN COMMERCE 6-26-1978.

SN 76-300,569. DIGIRAD CORPORATION, SAN DIEGO, CA. FILED 8-15-2001.

DIGISPECT

FOR PERFORMING MEDICAL IMAGING, NAMELY, SINGLE PHOTON EMISSION COMPUTED TOMOGRAPHY, FOR OTHERS (U.S. CLS. 100 AND 101).

SN 76-303,136. GIBNEY, ANTHONY & FLAHERTY, LLP, NEW YORK, NY. FILED 8-22-2001.

HOOTLINE

FOR PROVIDING INFORMATION IN THE LEGAL FIELD OVER THE INTERNET (U.S. CLS. 100 AND 101).

CLASS 42—(Continued).

SN 76-305,049. PROMD.COM, LAKE FOREST, FL. FILED 8-27-2001.



FOR CONDUCTING RESEARCH AND SURVEYS REGARDING HEALTHCARE PLANS, HEALTH MAINTENANCE ORGANIZATIONS AND PHARMACEUTICAL DRUGS VIA THE INTERNET; PROVIDING INFORMATION AND SURVEY RESULTS REGARDING HEALTHCARE PLANS, HEALTH MAINTENANCE ORGANIZATIONS AND PHARMACEUTICAL DRUGS VIA THE INTERNET (U.S. CLS. 100 AND 101).

FIRST USE 9-0-1999; IN COMMERCE 9-0-1999.

SN 76-305,693. DYNAMIC GRAPHICS, INC., PEORIA, IL. FILED 8-27-2001.

CREATAS

FOR STOCK PHOTOGRAPHY, GRAPHIC ILLUSTRATION, AND FOOTAGE SERVICES; NAMELY, LICENSING REPRODUCTION RIGHTS OF PHOTOGRAPHS, GRAPHIC ILLUSTRATIONS, AND VIDEO FOOTAGE (U.S. CLS. 100 AND 101).

FIRST USE 6-15-2001; IN COMMERCE 6-15-2001.

SN 76-306,934. WESSELMANN, PAUL T., MADISON, WI. FILED 8-30-2001.

ERIPPLES

FOR COMPUTER SERVICES, NAMELY PROVIDING INSPIRATIONAL CONTENT, QUOTES, POEMS, SONG LYRICS AND ESSAYS VIA THE INTERNET AND ELECTRONIC MAIL (U.S. CLS. 100 AND 101).

FIRST USE 2-27-2000; IN COMMERCE 2-27-2000.

CLASS 42—(Continued).

SN 76-307,047. CYKON TECHNOLOGY LIMITED, DOVER, DE. FILED 8-30-2001.

WHERE THE TECHNOLOGY TOUCHES PEOPLE

FOR REGISTRATION OF DOMAIN NAMES FOR IDENTIFICATION OF USERS ON A GLOBAL COMPUTER NETWORK; TECHNICAL CONSULTATION AND RESEARCH IN THE FIELD OF AEROSPACE; COMPUTER PROGRAMMING FOR OTHERS; CONSULTING SERVICES IN THE FIELD OF DESIGN, SELECTION, IMPLEMENTATION AND USE OF COMPUTER HARDWARE AND SOFTWARE SYSTEMS FOR OTHERS; COMPUTER SERVICES, NAMELY, DESIGNING AND IMPLEMENTING WEB SITES FOR OTHERS; COMPUTER SERVICES, NAMELY PROVIDING ON-LINE BOOKS IN THE FIELD OF COMPUTERS (U.S. CLS. 100 AND 101).

SN 76-307,103. ARMSTRONG, DANIEL J., SOUTH PORTLAND, ME. FILED 8-31-2001.



NO CLAIM IS MADE TO THE EXCLUSIVE RIGHT TO USE "ESTHETIC DENTISTRY OF MAINE", APART FROM THE MARK AS SHOWN.

THE MARK CONSISTS OF THE OUTLINE OF A FACE IN BLACK WITH FILLED IN RED COLORED LIPS.

FOR DENTAL SERVICES (U.S. CLS. 100 AND 101).

SN 76-310,232. DAVIS, GEORGE, LOS ANGELES, CA. FILED 9-10-2001.

BROADBAND AMBASSADOR

NO CLAIM IS MADE TO THE EXCLUSIVE RIGHT TO USE "BROADBAND", APART FROM THE MARK AS SHOWN.

FOR COMPUTER SERVICES, NAMELY, PROVIDING AN ON-LINE NEWSLETTER FEATURING TOPICS IN THE FIELD OF TELEVISION DEVELOPMENT, SATELLITE DEVELOPMENT, VIDEO STREAMING, AND OTHER RELATED SUBJECTS, NAMELY, TELEVISION OPERATIONS (U.S. CLS. 100 AND 101).

CLASS 42—(Continued).

SN 76-311,084. BIODEVELOPMENTS INTERNATIONAL INSTITUTE, ITHACA, NY. FILED 9-12-2001.

DEVELOPING THE POTENTIAL OF LIFE...FOR LIFE.

FOR BIOTECHNOLOGY CONSULTING SERVICES (U.S. CLS. 100 AND 101).

SN 76-313,641. SPIRIT OF FREEDOM MINISTRIES, THE, METAIRIE, LA. FILED 9-17-2001.

FREEDOMLINE

OWNER OF U.S. REG. NO. 1,308,931.
FOR TELEPHONE HOT LINE COUNSELING,
NAMELY OFFERING ADVICE REGARDING SUB-
STANCE ABUSE (U.S. CLS. 100 AND 101).
FIRST USE 2-18-1982; IN COMMERCE 5-17-1982.

SN 76-315,682. MCCALL ENVIRONMENTAL, P.A., GREENVILLE, SC. FILED 9-21-2001.



FOR ENGINEERING; LEGAL SERVICES (U.S. CLS. 100 AND 101).
FIRST USE 10-0-2000; IN COMMERCE 12-0-2000.

SN 76-315,703. REYNOLDS, TIM, ARLINGTON, TX. FILED 9-12-2001.

YOUR PET'S CHOICE

FOR IN-HOME PET-SITTING SERVICES (U.S. CLS. 100 AND 101).
FIRST USE 4-15-1987; IN COMMERCE 4-15-1987.

SN 76-316,208. COHEN, MARTHA A., CINCINNATI, OH. FILED 9-22-2001.

PARTITIONING THE VARIANCES

FOR LICENSING OF INTELLECTUAL PROPERTY (U.S. CLS. 100 AND 101).

CLASS 42—(Continued).

SN 76-316,544. NATIONAL MULTIPLE SCLEROSIS SOCIETY, NEW YORK, NY. FILED 9-25-2001.

MS NEXT STEP

NO CLAIM IS MADE TO THE EXCLUSIVE RIGHT TO USE "MS", APART FROM THE MARK AS SHOWN.

FOR INFORMATION SERVICES, NAMELY, PROVIDING INFORMATION ABOUT MULTIPLE SCLEROSIS (U.S. CLS. 100 AND 101).

SN 76-317,949. PENNSYLVANIA BAR ASSOCIATION, HARRISBURG, PA. FILED 9-20-2001.

INCITE

FOR PROVIDING LEGAL INFORMATION VIA AN ONLINE INTERACTIVE WEBSITE (U.S. CLS. 100 AND 101).

SN 76-319,619. YEAGER, LISA C., MISSOULA, MT. FILED 10-1-2001.

PHARMWAY

FOR CONSULTATION IN THE FIELD OF PHARMACOLOGY (U.S. CLS. 100 AND 101).

SN 76-320,624. ASHLEY MANOR LLC, BOISE, ID. FILED 10-4-2001.

AARENBROOKE PLACE

NO CLAIM IS MADE TO THE EXCLUSIVE RIGHT TO USE "PLACE", APART FROM THE MARK AS SHOWN.

FOR PROVIDING ASSISTED LIVING FACILITIES FOR THE ELDERLY (U.S. CLS. 100 AND 101).

SN 76-320,875. DNA WEAR, INC., RICHMOND, CA. FILED 10-3-2001.

ARCHETYPE

FOR CUSTOM CLOTHING DESIGN SERVICES FOR OTHERS; PROVIDING CUSTOM SIZING OF CLOTHING VIA THE INTERNET (U.S. CLS. 100 AND 101).

CLASS 42—(Continued).

SN 76-322,902. TRIBUTE'S, INC., PORTLAND, OR. FILED 10-8-2001.

Tribute's
SERVING
THE AMERICAN DREAM

FOR RESTAURANT SERVICES (U.S. CLS. 100 AND 101).
FIRST USE 7-1-2001; IN COMMERCE 7-1-2001.

SN 76-327,164. DASHA RESTAURANT GROUP, LLC, NEW YORK, NY. FILED 10-18-2001.

TOUGH CLUB

NO CLAIM IS MADE TO THE EXCLUSIVE RIGHT TO USE "CLUB", APART FROM THE MARK AS SHOWN.
FOR RESTAURANT SERVICES (U.S. CLS. 100 AND 101).

SN 76-327,444. ZING NETWORK, INC., SAN FRANCISCO, CA. FILED 10-17-2001.

LUMERO

FOR SOFTWARE DEVELOPMENT AND CONSULTING SERVICES IN THE FIELD OF ELECTRONIC IMAGING (U.S. CLS. 100 AND 101).

SN 76-327,814. BEIJING DONG AN FOOD & DRINK CO., BEIJING, CHINA, FILED 10-19-2001.

東來順

OWNER OF CHINA REG. NO. 1007534, DATED 5-14-1997, EXPIRES 5-13-2007.

THE TRANSLITERATION OF THE CHINESE CHARACTERS ON THE MARK IS "DONG", "LAI" AND "SHUN". THE MARK IS COINED AND DOES NOT HAVE ANY MEANING

FOR RESTAURANT SERVICES (U.S. CLS. 100 AND 101).

CLASS 42—(Continued).

SN 76-330,429. MANATRON, INC., PORTAGE, MI. FILED 10-26-2001.

GOVERNMAX

FOR INSTALLATION OF COMPUTER SOFTWARE, TECHNICAL SUPPORT SERVICES, NAMELY TROUBLESHOOTING OF COMPUTER SOFTWARE AND HARDWARE PROBLEMS AND HOSTING WEB SITES FOR GOVERNMENTAL ENTITIES ON A COMPUTER SERVER FOR A GLOBAL COMPUTER NETWORK, ALL CONCERNING THE FIELDS OF GOVERNMENT RECORDS AND INFORMATION CONCERNING REAL PROPERTY (U.S. CLS. 100 AND 101).

SN 76-330,712. DOLCETTO, INC., DBA WINESTUFF, CENTRAL ISLIP, NY. FILED 10-25-2001.

WINESTUFF

FOR PROVIDING GENERAL INFORMATION REGARDING THE WINE GROWING PROCESS AND VARIETIES OF WINE (U.S. CLS. 100 AND 101).

SN 76-330,868. CEPHALON, INC., WEST CHESTER, PA. FILED 10-29-2001.

GABITRIL

OWNER OF U.S. REG. NO. 2,155,299.
FOR PROVIDING INFORMATION BY MEANS OF A GLOBAL COMPUTER NETWORK REGARDING RESEARCH AND DEVELOPMENT, BUSINESS, AND EDUCATIONAL TOPICS RELATING TO THE TREATMENT OF NEUROLOGICAL DISORDERS (U.S. CLS. 100 AND 101).

SN 76-331,815. RELIANCE ELECTRIC INDUSTRIAL COMPANY, CLEVELAND, OH. FILED 10-30-2001.

POWER LEAN

NO CLAIM IS MADE TO THE EXCLUSIVE RIGHT TO USE "POWER", APART FROM THE MARK AS SHOWN.

FOR CONSULTING SERVICES FOR IMPROVING THE EFFICIENCY OF A MANUFACTURING PLANT; NAMELY IMPROVING PLANT LAYOUT, WORK FLOW ON MANUFACTURING FLOOR, RAW MATERIAL FLOW, EQUIPMENT UTILIZATION, AND DEFECT REDUCTION (U.S. CLS. 100 AND 101).

FIRST USE 6-0-2000; IN COMMERCE 10-0-2000.

CLASS 42—(Continued).

SN 76-333,384. KTK MEDICAL SOLUTIONS L.L.C., FISHERS, IN. FILED 11-2-2001.

KTK MEDICAL SOLUTIONS

NO CLAIM IS MADE TO THE EXCLUSIVE RIGHT TO USE "MEDICAL SOLUTIONS", APART FROM THE MARK AS SHOWN.

FOR COMPUTER SOFTWARE UPDATING, REPAIR, INSTALLATION AND MAINTENANCE SERVICES FOR MEDICAL RECORDS SYSTEMS, AND COMPUTER SOFTWARE UPDATING, REPAIR, INSTALLATION AND MAINTENANCE SERVICES FOR HEALTH CARE PROVIDERS, MANAGED CARE ORGANIZATIONS, AND MEDICAL PERSONNEL AND INSTITUTIONS (U.S. CLS. 100 AND 101).

SN 76-334,956. COMPUTER DIMENSIONS, INC., FLORENCE, SC. FILED 11-6-2001.

OURMINISTRY.ORG

FOR PROVIDING INFORMATION IN THE FIELD OF RELIGION VIA THE INTERNET; PROVIDING INFORMATION CONCERNING ESTABLISHING, MODIFYING, AND MAINTAINING A WEBSITE ON THE INTERNET (U.S. CLS. 100 AND 101).

FIRST USE 4-0-2001; IN COMMERCE 4-0-2001.

SN 76-335,824. PROJECT OPEN HAND, SAN FRANCISCO, CA. FILED 11-9-2001.



FOR CHARITABLE SERVICES, NAMELY PREPARING AND DELIVERING MEALS TO HOME-BOUND INDIVIDUALS NOT OTHERWISE ELIGIBLE FOR PUBLIC-ASSISTED MEAL SERVICES (U.S. CLS. 100 AND 101).

FIRST USE 1-1-1987; IN COMMERCE 1-14-1989.

SN 76-336,942. ORCHID BIOSCIENCES, INC., PRINCETON, NJ. FILED 11-13-2001.

SNPCONTENT

FOR GENETIC RESEARCH AND TESTING (U.S. CLS. 100 AND 101).

CLASS 42—(Continued).

SN 76-337,100. HC STUDIOS, SALEM, OR. FILED 11-14-2001.

HEADACHE-FREE WEB DEVELOPMENT

NO CLAIM IS MADE TO THE EXCLUSIVE RIGHT TO USE "WEB DEVELOPMENT", APART FROM THE MARK AS SHOWN.

FOR COMPUTER SERVICES, NAMELY, DESIGNING, CREATING, MAINTAINING AND IMPLEMENTING WEB SITES FOR OTHERS (U.S. CLS. 100 AND 101).

FIRST USE 6-20-2001; IN COMMERCE 10-1-2001.

SN 76-338,268. TORTILLA, INC., ALBUQUERQUE, NM. FILED 11-16-2001.

GARDUÑOS RESTAURANT & CANTINA

OWNER OF U.S. REG. NOS. 1,950,385, 2,013,016 AND OTHERS.

NO CLAIM IS MADE TO THE EXCLUSIVE RIGHT TO USE "RESTAURANT & CANTINA", APART FROM THE MARK AS SHOWN.

FOR RESTAURANT/BAR SERVICES (U.S. CLS. 100 AND 101).

FIRST USE 8-1-1982; IN COMMERCE 8-1-1982.

SN 76-339,153. DNP, INC., BRASELTON, GA. FILED 11-16-2001.

THE SUBTLE DIFFERENCE OF EXCELLENCE

OWNER OF U.S. REG. NO. 2,283,424.
FOR RESORT HOTELS AND RESTAURANT SERVICES (U.S. CLS. 100 AND 101).

FIRST USE 1-1-2000; IN COMMERCE 1-1-2000.

SN 76-340,771. LIPOMICS TECHNOLOGIES, INC., WEST SACRAMENTO, CA. FILED 11-20-2001.

TRUEMASS

FOR QUANTITATIVE ANALYSIS OF METABOLITES (U.S. CLS. 100 AND 101).

FIRST USE 9-9-2000; IN COMMERCE 9-9-2000.

CLASS 42—(Continued).

SN 76-341,694. ASSOCIATED CREDIT BUREAUS, INC., WASHINGTON, DC. FILED 11-26-2001.

CDIA

FOR ASSOCIATION SERVICES, NAMELY PROMOTING THE INTERESTS OF THOSE INVOLVED IN THE CONSUMER CREDIT INDUSTRY (U.S. CLS. 100 AND 101).

SN 76-343,887. AMC CANCER RESEARCH CENTER, ST. LOUIS, MO. FILED 11-30-2001.

CELEBRATE SURVIVAL

FOR PROMOTING AWARENESS OF THE NEED FOR EARLY DETECTION OF BREAST CANCER AND AWARENESS OF BREAST CANCER GENERALLY (U.S. CLS. 100 AND 101).

FIRST USE 5-0-1997; IN COMMERCE 5-0-1997.

SN 76-345,655. BIOMECHANICS RESEARCH & CONSULTING, INC., TEMPE, AZ. FILED 12-6-2001.

**THE RECOGNIZED CHOICE
FOR ENGINEERING
EXPERTISE**

FOR RESEARCH, CONSULTATION AND EXPERT WITNESS SERVICES IN THE FIELDS OF BIOMECHANICAL ANALYSIS, MECHANICAL FAILURE ANALYSIS, ACCIDENT RECONSTRUCTION, INJURY CAUSATION ANALYSIS, ACCIDENT VEHICLE INSPECTIONS, ACCIDENT SCENE INSPECTIONS, ERGONOMICS, HUMAN FACTORS ANALYSIS, RESTRAINT SYSTEM TESTING AND SEAT BELT ANALYSIS (U.S. CLS. 100 AND 101).

FIRST USE 11-30-2001; IN COMMERCE 11-30-2001.

SN 76-347,143. KISSES FROM HEAVEN, INC., INDEPENDENCE, MO. FILED 12-10-2001.

TOUCH FOR LIFE

FOR PROMOTING PUBLIC, CAREGIVER AND FAMILY AWARENESS OF THE NEED FOR POSITIVE, PHYSICAL CONTACT WITH THE ELDERLY; AND ELDERLY CARE SERVICES (U.S. CLS. 100 AND 101).

FIRST USE 11-5-2001; IN COMMERCE 11-5-2001.

CLASS 42—(Continued).

SN 76-347,819. JENKENS & GILCHRIST, P.C., DALLAS, TX. FILED 12-11-2001.

J&G HIRE AUTHORITY

FOR PROVIDING LEGAL NEWS AND INFORMATION IN THE FIELD OF LABOR AND EMPLOYMENT LAW VIA PRINTED AND ELECTRONIC PUBLICATIONS (U.S. CLS. 100 AND 101).

FIRST USE 3-0-2000; IN COMMERCE 3-0-2000.

SN 76-347,850. KLIMAN, HARVEY JON, WOODBRIDGE, CT. FILED 12-12-2001.

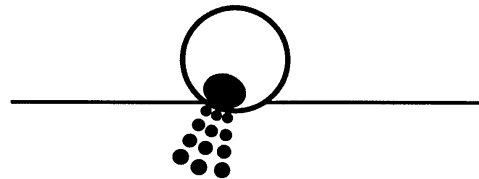

FOR PATHOLOGY SERVICES, NAMELY MEDICAL TESTING OF TISSUES AND BIOLOGICAL SAMPLES TO DIAGNOSE DISEASES RELATED TO INFERTILITY, ABNORMAL UTERINE BLEEDING, PREGNANCY LOSS AND PREGNANCY COMPLICATIONS FROM ENDOMETRIAL BIOPSIES, PRODUCTS OF CONCEPTION, PLACENTAS AND OTHER SPECIMENS (U.S. CLS. 100 AND 101).

FIRST USE 10-26-2001; IN COMMERCE 10-26-2001.

SN 76-351,026. ITELLIGENCE, INC., CINCINNATI, OH. FILED 12-18-2001.

**PROFIT FROM OUR
EXPERIENCE**

FOR COMPUTER SERVICES, NAMELY, COMPUTER PROGRAMMING FOR OTHERS, COMPUTER SOFTWARE INSTALLATION AND MAINTENANCE, COMPUTER CONSULTATION SERVICES, DATA CONVERSION OF COMPUTER PROGRAM DATA OR INFORMATION, REMOTE AND ON-SITE MONITORING OF COMPUTER SYSTEMS OF OTHERS AND PROVIDING BACK-UP COMPUTER PROGRAMS AND FACILITIES, CREATING, IMPLEMENTING AND MAINTAINING WEB SITES AND WEB PAGES FOR OTHERS, AND CONSULTING SERVICES IN THE FIELD OF INTERNET AND INTRANET SOFTWARE AND HARDWARE APPLICATIONS AND PLANNING (U.S. CLS. 100 AND 101).

CLASS 42—(Continued).

SN 76-355,335. DTN WEATHER SERVICES, LLC, BURNSVILLE, MN. FILED 1-4-2002.

MXVISION WEATHERWIRE

NO CLAIM IS MADE TO THE EXCLUSIVE RIGHT TO USE "WEATHER WIRE", APART FROM THE MARK AS SHOWN.

FOR WEATHER FORECASTING AND REPORTING SERVICES, NAMELY ELECTRONICALLY PROVIDING TEXT-BASED WEATHER DATA TO SUBSCRIBERS FOR DISPLAY ON COMPUTERS (U.S. CLS. 100 AND 101).

SN 76-355,337. DTN WEATHER SERVICES, LLC, BURNSVILLE, MN. FILED 1-4-2002.

MXVISION WEATHERWEB

NO CLAIM IS MADE TO THE EXCLUSIVE RIGHT TO USE "WEATHER WEB", APART FROM THE MARK AS SHOWN.

FOR WEATHER FORECASTING AND REPORTING SERVICES, NAMELY PROVIDING WEATHER INFORMATION TO COMPANIES AND ORGANIZATIONS FOR DISTRIBUTION TO PERSONNEL USING NETWORKS MAINTAINED BY THE COMPANY OR ORGANIZATION (U.S. CLS. 100 AND 101).

SN 78-004,115. KALIS, JANAL M., MINNEAPOLIS, MN. FILED 4-14-2000.

PATENTSTATS.COM

FOR PROVIDING TEMPORARY USE OF ON-LINE, NON-DOWNLOADABLE SOFTWARE, NAMELY A CALCULATOR FOR CALCULATING US PATENT TERM EXTENSIONS (U.S. CLS. 100 AND 101).

SN 78-009,701. CORPORATE HEALTH OF AMERICA, L.L.C., DEERFIELD BEACH, FL. FILED 5-24-2000.

JOBGUARD

FOR REVIEWING STANDARDS AND PRACTICES TO ASSURE COMPLIANCE WITH WORKERS' COMPENSATION LAWS AND REGULATIONS BY PROVIDING ONSITE EVALUATION OF WORKPLACE IDENTIFYING NONCOMPLIANCE, POTENTIAL HAZARDS, ESSENTIAL FUNCTIONING AND CRITICAL DEMANDS OF EMPLOYEES TO CONTROL WORKERS' COMPENSATION COSTS; PROVIDING HEALTH CARE SERVICES TO CONTROL WORKERS' COMPENSATION COSTS, NAMELY, CONDUCTING POST OFFER FUNCTIONAL CAPACITY PHYSICAL EXAMINATIONS, PHYSICAL REHABILITATION (U.S. CLS. 100 AND 101).

FIRST USE 6-1-2000; IN COMMERCE 6-1-2000.

CLASS 42—(Continued).

SN 78-019,463. HOLLY KATHLEEN DRIGGERS AND HOLLY KATHLEEN PARTNERSHIP, THE, BREMER-TON, WA. FILED 8-2-2000.

HERWEBHOST

FOR HOSTING THE WEB SITES OF OTHERS ON A COMPUTER SERVER FOR A GLOBAL COMPUTER NETWORK; REGISTRATION OF DOMAIN NAMES FOR IDENTIFICATION OF USERS ON A GLOBAL COMPUTER NETWORK (U.S. CLS. 100 AND 101).

FIRST USE 8-23-1999; IN COMMERCE 8-23-1999.

SN 78-024,309. 270 WEB, INC., FREDERICK, MD. BY ASSIGNMENT PERFORMANCE ENHANCEMENT PRODUCTS, INC., FREDERICK, MD. FILED 9-4-2000.



NO CLAIM IS MADE TO THE EXCLUSIVE RIGHT TO USE "270", APART FROM THE MARK AS SHOWN.

FOR COMPUTER SERVICES, NAMELY, DESIGNING AND IMPLEMENTING WEB SITES FOR OTHERS; DATABASE DEVELOPMENT SERVICES, NAMELY, CREATING CUSTOM DATABASES FOR OTHERS; HOSTING THE WEB SITES OF OTHERS ON A COMPUTER SERVER FOR A GLOBAL COMPUTER NETWORK (U.S. CLS. 100 AND 101).

FIRST USE 6-13-2000; IN COMMERCE 6-28-2000.

SN 78-030,509. STUFT PIZZA & BREWING COMPANY, SAN DIEGO, CA. FILED 10-13-2000.

STUFT PIZZA & BREWING COMPANY

NO CLAIM IS MADE TO THE EXCLUSIVE RIGHT TO USE "STUFFED PIZZA & BREWING", APART FROM THE MARK AS SHOWN.

FOR RESTAURANT AND BAR SERVICES (U.S. CLS. 100 AND 101).

SN 78-036,491. POBEDA SYSTEMS, INC., GURNEE, IL. FILED 11-24-2000.



FOR SOFTWARE DEVELOPMENT IN THE NATURE OF CREATING COMPUTER SOFTWARE FOR ENABLING ACCESS TO FILES STORED ON A MAIN-FRAME COMPUTER (U.S. CLS. 100 AND 101).

FIRST USE 2-1-2000; IN COMMERCE 2-1-2000.

CLASS 42—(Continued).

SN 78-037,476. OPENGLOBE, INC., INDIANAPOLIS, IN. FILED 12-1-2000.



FOR DESIGN AND TESTING FOR PRODUCT DEVELOPMENT FOR OTHERS, NAMELY, DESIGNING AND TESTING PRODUCTS FOR USE IN ACCESSING DATABASES OF MUSIC AND MOVIE INFORMATION VIA THE INTERNET AND PRODUCTS FOR DISTRIBUTING TARGET MARKET ADVERTISING TO USERS BASED ON THEIR PURCHASE OR USE OF SELECTED CDS, DVD'S, OR OTHER ENTERTAINMENT DELIVERY VEHICLES (U.S. CLS. 100 AND 101).

SN 78-039,539. LAPISH, ROY WILLIAM, NORCO, LA. FILED 12-15-2000.

HUF

FOR PROVIDE GRAPHIC ART DESIGN SERVICES FOR OTHERS, NAMELY, PREPARING DESIGNS FOR BUSINESS LOGOS, WEBSITES, BUSINESS CARDS, COMPACT DISC COVERS, FLIERS, MAGAZINE LAYOUT; AND DESIGN SERVICES FOR OTHERS IN THE FIELD OF CLOTHING (U.S. CLS. 100 AND 101).

SN 78-042,503. DOGTOYS.COM, INC., WEST CHESTER, PA. FILED 1-10-2001.

TOYS BY BREED

SEC. 2(F).
FOR PROVIDING RECOMMENDATIONS FOR DOG AND CAT TOYS BY ANIMAL'S BREED VIA A WEB SITE ON A GLOBAL COMPUTER NETWORK (U.S. CLS. 100 AND 101).
FIRST USE 11-17-1997; IN COMMERCE 11-17-1997.

CLASS 42—(Continued).

SN 78-044,389. BOWNE GLOBAL SOLUTIONS, INC., NEW YORK, NY. FILED 1-22-2001.

TERMGLOBAL

FOR COMPUTER SERVICES, NAMELY, CREATING, MANAGING, MAINTAINING AND IMPLEMENTING WEB SITES FOR OTHERS; COMPUTER PROGRAMMING SERVICES; COMPUTER SOFTWARE AND MODIFICATION SERVICES; COMPUTER SOFTWARE DEVELOPMENT SERVICES; COMPUTER CONSULTATION SERVICES; COMPUTER SOFTWARE TRANSLATION AND LOCALIZATION SERVICES; WEB PAGE AND WEB SITE TRANSLATION AND LOCALIZATION SERVICES; PRODUCT RESEARCH AND LOCALIZATION SERVICES; TRANSLATION SERVICES; DATABASE DEVELOPMENT SERVICES; DATABASE CREATION AND MANAGEMENT OF LARGE TERMINOLOGY REPOSITORIES FOR TERMINOLOGY MANAGEMENT; AND PROVIDING AN ELECTRONIC DATABASE OF LARGE TERMINOLOGY REPOSITORIES FOR TERMINOLOGY MANAGEMENT ON A GLOBAL COMPUTER NETWORK, WIDE-AREA NETWORK, AND LOCAL-AREA NETWORK (U.S. CLS. 100 AND 101).

SN 78-046,765. SHAWGUIDES, INC., NEW YORK, NY. FILED 2-6-2001.

TRAVELCHUMS

FOR WEBSITE THAT FEATURES INFORMATION AND PROCEDURES FOR MEETING TRAVEL COMPANIONS WITH SIMILAR TRAVEL INTERESTS AND PLANS (U.S. CLS. 100 AND 101).
FIRST USE 7-1-1999; IN COMMERCE 7-1-1999.

SN 78-047,239. FOODCOURT.COM, INC., FLAGSTAFF, AZ. FILED 2-8-2001.



NO CLAIM IS MADE TO THE EXCLUSIVE RIGHT TO USE ".COM", APART FROM THE MARK AS SHOWN.
THE MARK CONSIST OF A STYLIZED CARROT OVERLAPPING THE LETTER "F" AND AN ILLUSTRATED ORANGE IN THE PLACE OF THE SECOND "O".
FOR HOSTING OF DIGITAL CONTENT ON THE INTERNET (U.S. CLS. 100 AND 101).

SN 78-051,193. YAN, JACK, WELLINGTON 6041, NEW ZEALAND, FILED 3-2-2001.

LUCIRE

FOR PROVIDING AN ONLINE MAGAZINE FEATURING FASHION, APPAREL, BEAUTY, LIFESTYLE AND HOME FURNISHINGS (U.S. CLS. 100 AND 101).
FIRST USE 3-1-1997; IN COMMERCE 10-20-1997.

CLASS 42—(Continued).

SN 78-051,505. DAVIS-REUSS, INC., WOODLAND HILLS, CA. FILED 3-6-2001.

MISTRESS LUV THANG

FOR PROVIDING COUNSELING AND ADVICE IN FIELD OF HUMAN RELATIONSHIPS (U.S. CLS. 100 AND 101).

FIRST USE 2-14-1999; IN COMMERCE 2-14-1999.

CLASS 42—(Continued).

SN 78-054,530. MARK IV REALTY GROUP, INC., CHICAGO, IL. FILED 3-22-2001.



SN 78-052,121. THOUGHTWARE TECHNOLOGIES, INC., MEMPHIS, TN. FILED 3-9-2001.

WLM

FOR APPLICATION SERVICE PROVIDER SERVICES, NAMELY, PROVIDING TEMPORARY USE OF AN INTEGRATED SUITE OF ONLINE NON-DOWNLOADABLE SOFTWARE APPLICATIONS FOR ACCESSING AND MANAGING INFORMATION IN THE FIELDS OF EMPLOYEE RECRUITING, STAFFING AND RETENTION, CAREER PLANNING AND MANAGEMENT, HUMAN RESOURCES MANAGEMENT, EMPLOYEE TRAINING, MONITORING AND EVALUATION, PRODUCT AND SERVICE INFORMATION, AND CORPORATE POLICIES AND PROCEDURES (U.S. CLS. 100 AND 101).

NO CLAIM IS MADE TO THE EXCLUSIVE RIGHT TO USE "HOTEL & CASINO", APART FROM THE MARK AS SHOWN.

FOR HOTEL SERVICES, HOTEL CONCIERGE SERVICES, NIGHT CLUB SERVICES, PROVIDING FACILITIES FOR CONVENTIONS, SOCIAL FUNCTIONS, FUND RAISING, AND SPECIAL EVENTS (U.S. CLS. 100 AND 101).

FIRST USE 8-4-2001; IN COMMERCE 8-4-2001.

SN 78-052,123. THOUGHTWARE TECHNOLOGIES, INC., MEMPHIS, TN. FILED 3-9-2001.

**WORKFORCE LIFECYCLE
MANAGEMENT**

NO CLAIM IS MADE TO THE EXCLUSIVE RIGHT TO USE "WORKFORCE" AND "MANAGEMENT", APART FROM THE MARK AS SHOWN.

FOR APPLICATION SERVICE PROVIDER SERVICES, NAMELY, PROVIDING TEMPORARY USE OF AN INTEGRATED SUITE OF ONLINE NON-DOWNLOADABLE SOFTWARE APPLICATIONS FOR ACCESSING AND MANAGING INFORMATION IN THE FIELDS OF EMPLOYEE RECRUITING, STAFFING AND RETENTION, CAREER PLANNING AND MANAGEMENT, HUMAN RESOURCES MANAGEMENT, EMPLOYEE TRAINING, MONITORING AND EVALUATION, PRODUCT AND SERVICE INFORMATION, AND CORPORATE POLICIES AND PROCEDURES (U.S. CLS. 100 AND 101).

SN 78-056,915. STERNLIEB, JACK J., RANCHO MIRAGE, CA. FILED 4-5-2001.

**HEART INSTITUTE OF THE
DESERT MEDICAL GROUP,
INC.**

NO CLAIM IS MADE TO THE EXCLUSIVE RIGHT TO USE "HEART INSTITUTE" AND "MEDICAL GROUP, INC.", APART FROM THE MARK AS SHOWN.

FOR MEDICAL SERVICES (U.S. CLS. 100 AND 101).

CLASS 42—(Continued).

SN 78-057,547. BELL, SCOTT A., DBA APPEMED, MONTGOMERY, AL. FILED 4-9-2001.

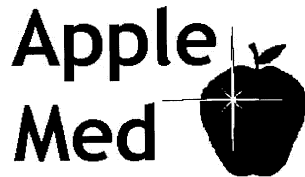

**Advanced Practice of
Preventive and
Life Enhancement
Medicine**

NO CLAIM IS MADE TO THE EXCLUSIVE RIGHT TO USE "MED ADVANCED PRACTICE OF PREVENTIVE AND LIFE ENHANCEMENT MEDICINE", APART FROM THE MARK AS SHOWN.

FOR MEDICAL SERVICES CONSISTING OF PREVENTIVE HEALTH CARE TO INCLUDE CARDIOVASCULAR RISK ASSESSMENT AND MANAGEMENT, HORMONE REPLACEMENT THERAPY, NONSURGICAL COSMETIC PROCEDURES, GENERAL INTERNAL MEDICINE CARE, CHELATION THERAPY, WEIGHT LOSS, NUTRITIONAL EVALUATIONS, MASSAGE THERAPY, BEHAVIORAL THERAPY (U.S. CLS. 100 AND 101).

SN 78-059,257. MIDWEST TOMATO, INC., NEW YORK, NY. FILED 4-19-2001.

PUTTANESCA

THE WORDING "PUTTANESCA" IS AN ITALIAN WORD THAT DESCRIBES A SAUCE FOR PASTA. THE SAUCE CONSISTS OF TOMATO, CAPERS AND OLIVES.

FOR ITALIAN RESTAURANT SERVICES (U.S. CLS. 100 AND 101).

FIRST USE 10-1-1993; IN COMMERCE 10-1-1993.

CLASS 42—(Continued).

SN 78-062,372. YENOM, INC., BEVERLY HILLS, CA. FILED 5-7-2001.



FOR COMPUTER CONSULTATION, DATABASE DEVELOPMENT SERVICES, DESIGNING AND IMPLEMENTING NETWORK WEB PAGES FOR OTHERS; HOSTING THE WEB SITES OF OTHERS ON A COMPUTER SERVER FOR A GLOBAL COMPUTER NETWORK; CREATING AND MAINTAINING WEB SITES FOR OTHERS; PROVIDING SEARCH ENGINES FOR OBTAINING DATA ON A GLOBAL COMPUTER NETWORK; PROVIDING GLOBAL COMPUTER INFORMATION NETWORK INTERFACE FOR UPLOADING, PRESENTING, RECEIVING AND VIEWING, LOAN APPLICATIONS AND RELATED DOCUMENTS, LOAN RELATED FORMS, RATE SHEETS, COMPANY NEWS, AND MESSAGES; PROVIDING A PERSONALIZED MULTIMEDIA DATABASE WITH USER INTERFACE FOR SEARCHING FOR TRANSACTIONAL PARTNERS, SERVICE PROVIDERS, AND SERVICES IN A REAL ESTATE FINANCIAL TRANSACTION OVER AN ELECTRONIC COMPUTER NETWORK; PROVIDING DATABASES FEATURING GENERAL AND LOCAL NEWS, AND INFORMATION OF INTEREST TO INDIVIDUALS AND COMPANIES OVER AND ELECTRONIC COMMUNICATIONS NETWORK (U.S. CLS. 100 AND 101).

FIRST USE 12-28-1998; IN COMMERCE 12-28-1998.

SN 78-063,498. RISK ASSESSMENT & REDUCTION, LLC, LOS ALAMOS, NM. FILED 5-14-2001.

RARDIRECT

FOR TECHNICAL SERVICES, NAMELY, CONSULTING IN THE FIELD OF ENGINEERING ON THE SUBJECTS OF SHOCK, VIBRATION, STRUCTURAL DYNAMICS, STRESS ANALYSIS, FRACTURE, MECHANICAL DESIGN, HEAT TRANSFER, FLUID MECHANICS, BLAST EFFECTS AND SAFETY; AND COMPUTER SOFTWARE DESIGN SERVICES FOR OTHERS FOR THE CREATION OF PROGRAMS IN THE FIELD OF ENGINEERING (U.S. CLS. 100 AND 101).

CLASS 42—(Continued).

SN 78-066,318. GLOBAL SCIENCE & TECHNOLOGY, INC., GREENBELT, MD. FILED 5-30-2001.



NO CLAIM IS MADE TO THE EXCLUSIVE RIGHT TO USE "GLOBAL SCIENCE & TECHNOLOGY, INC.", APART FROM THE MARK AS SHOWN.

FOR SCIENTIFIC RESEARCH AND ENGINEERING SERVICES IN THE FIELD OF SPACE AND EARTH SCIENCES (U.S. CLS. 100 AND 101).

FIRST USE 0-0-2001; IN COMMERCE 0-0-2001.

SN 78-068,403. MISSOURI CARDIOVASCULAR SPECIALISTS, L.L.P., COLUMBIA, MO. FILED 6-11-2001.



NO CLAIM IS MADE TO THE EXCLUSIVE RIGHT TO USE "MISSOURI HEART CENTER", APART FROM THE MARK AS SHOWN.

FOR MEDICAL SERVICES IN THE FIELDS OF CARDIOLOGY AND VASCULAR DISEASE (U.S. CLS. 100 AND 101).

FIRST USE 1-0-2000; IN COMMERCE 1-0-2000.

CLASS 42—(Continued).

SN 78-069,413. MINK HOLLOW SYSTEMS, INC., HIGHLAND, MD. FILED 6-15-2001.

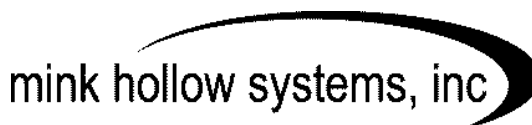

NO CLAIM IS MADE TO THE EXCLUSIVE RIGHT TO USE "SYSTEMS, INC", APART FROM THE MARK AS SHOWN.

FOR COMPUTER CONSULTATION; COMPUTER HARDWARE DEVELOPMENT; COMPUTER PROGRAMMING FOR OTHERS; COMPUTER SOFTWARE DESIGN FOR OTHERS; COMPUTER SOFTWARE DEVELOPMENT; COMPUTER SYSTEMS ANALYSIS; DATA AUTOMATION AND COLLECTION SERVICE USING PROPRIETARY SOFTWARE TO EVALUATE, ANALYZE AND COLLECT SERVICE DATA; DESIGN AND TESTING FOR NEW PRODUCT DEVELOPMENT; DESIGN AND TESTING OF NEW PRODUCTS FOR OTHERS; ENGINEERING; INSTALLATION OF COMPUTER SOFTWARE; INTEGRATION OF COMPUTER SYSTEMS AND NETWORKS; MAINTENANCE OF COMPUTER SOFTWARE; MATERIAL TESTING; MEASUREMENT EVALUATIONS, NAMELY, PROVIDING TESTING FOR, MEASUREMENT OF, AND EVALUATIONS OF MANUFACTURING PRODUCTION LINE TEST SYSTEMS IN THE AEROSPACE, AUTOMOTIVE, BIOMEDICAL, BIOTECHNOLOGY, CHEMICAL, CONTRACT MANUFACTURING, COMPUTER, DEFENSE, ELECTRONICS, INDUSTRIAL AUTOMATION, MANUFACTURING, MEDICAL TESTING, MEDICAL INSTRUMENT, OPTICAL TELECOMMUNICATIONS, SEMICONDUCTOR AND TELECOMMUNICATIONS INDUSTRIES; PRODUCT DEVELOPMENT; PRODUCT DEVELOPMENT CONSULTATION; TECHNICAL CONSULTATION, NAMELY TECHNICAL CONSULTATION IN RELATION TO AUTOMATION SYSTEMS IN THE AEROSPACE, AUTOMOTIVE, BIOMEDICAL, BIOTECHNOLOGY, CHEMICAL, CONTRACT MANUFACTURING, COMPUTER, DEFENSE, ELECTRONICS, INDUSTRIAL AUTOMATION, MANUFACTURING, MEDICAL TESTING, MEDICAL INSTRUMENT, OPTICAL TELECOMMUNICATIONS, SEMICONDUCTOR AND TELECOMMUNICATIONS INDUSTRIES (U.S. CLS. 100 AND 101).

SN 78-069,726. ALABANZA CORPORATION, BALTIMORE, MD. FILED 6-18-2001.

ALABANZA

THE ENGLISH TRANSLATION OF "ALABANZA" IS "PRAISE" IN SPANISH.

FOR PROVIDING TEMPORARY USE OF ON-LINE NON-DOWNLOADABLE SOFTWARE FOR THE AUTOMATED HOSTING OF WEB SITES (U.S. CLS. 100 AND 101).

FIRST USE 1-1-1998; IN COMMERCE 1-1-1998.

CLASS 42—(Continued).

SN 78-072,589. BELCZYNSKI, DOANNA LISA JUAREZ, MUNDELIEN, IL. FILED 7-6-2001.

MEDIAVIRTUE

FOR WEB SITE DESIGN AND DEVELOPMENT SERVICES, AND PRINT AND LOGO DESIGN SERVICES (U.S. CLS. 100 AND 101).
FIRST USE 3-15-2000; IN COMMERCE 3-15-2000.

SN 78-076,229. BLOOM, STEPHEN E., HIGHLAND HGTS, OH. FILED 7-27-2001.

SMILES IN BLOOM

FOR COSMETIC DENTISTRY (U.S. CLS. 100 AND 101).
FIRST USE 6-1-2001; IN COMMERCE 6-1-2001.

SN 78-078,072. LONE STAR STEAKHOUSE & SALOON, INC., WICHITA, KS. FILED 8-7-2001.

LONE STAR BARBECUE & STEAKHOUSE

OWNER OF U.S. REG. NOS. 1,155,907, 2,229,771 AND OTHERS.

NO CLAIM IS MADE TO THE EXCLUSIVE RIGHT TO USE "BARBECUE & STEAKHOUSE", APART FROM THE MARK AS SHOWN.

FOR RESTAURANT AND BAR SERVICES (U.S. CLS. 100 AND 101).

SN 78-078,720. NEW NEWYORKERS INC., LOS ANGELES, CA. FILED 8-10-2001.

NNYS

FOR COMPUTER SERVICES, NAMELY, CREATING AND MAINTAINING WEB SITE FOR OTHERS; COMPUTER SERVICES, NAMELY, PROVIDING GRAPHIC ART AND WEB SITE DESIGN SERVICES FOR OTHERS (U.S. CLS. 100 AND 101).

SN 78-083,443. NBBJ, SEATTLE, WA. FILED 9-11-2001.

NBBJ

FOR ARCHITECTURAL SERVICES, PLANNING AND URBAN DESIGN, INTERIOR DESIGN AND SPACE PLANNING, GRAPHIC AND ENVIRONMENTAL DESIGN, ECONOMICS AND FINANCIAL FEASIBILITY STUDIES, AND MEDICAL EQUIPMENT DEVELOPMENT FOR OTHERS (U.S. CLS. 100 AND 101).
FIRST USE 12-31-1943; IN COMMERCE 12-31-1943.

CLASS 42—(Continued).

SN 78-093,816. SIERANT, ANDREW MARCUS, HALIFAX, UNITED KINGDOM, FILED 11-16-2001.

BACKUP&RUNNING

FOR COMPUTER PROGRAMMING, AUTOMATIC OFF-SITE DATA BACKUP SERVICES (U.S. CLS. 100 AND 101).

SN 78-094,026. SODEXHO OPERATIONS, LLC, GAITHERSBURG, MD. FILED 11-19-2001.



NO CLAIM IS MADE TO THE EXCLUSIVE RIGHT TO USE "FOOD SAFETY", APART FROM THE MARK AS SHOWN.

FOR PROMOTING PUBLIC AWARENESS BY FOOD SERVICE PROVIDERS OF THE NEED FOR SAFE PRACTICES IN THE FIELD OF FOOD PREPARATION AND HANDLING (U.S. CLS. 100 AND 101).

SN 78-096,330. CBOCS GENERAL PARTNERSHIP, BELLEVILLE, MI. FILED 12-3-2001.

WHERE COMFORT MEETS FOOD

FOR RESTAURANT SERVICES (U.S. CLS. 100 AND 101).
FIRST USE 8-31-2000; IN COMMERCE 8-31-2000.

SN 78-096,726. COMPUMENTOR, SAN FRANCISCO, CA. FILED 12-5-2001.

DISCOUNTECH

FOR ONLINE COMPUTER DATABASE IN THE FIELD OF PROVIDING COMPUTER TECHNOLOGY ASSISTANCE AND PRODUCTS TO NONPROFIT ORGANIZATIONS (U.S. CLS. 100 AND 101).

CLASS 43—HOTEL AND RESTAURANT SERVICES

CLASS 44—(Continued).

SN 76-335,489. ERICKSON RETIREMENT COMMUNITIES, LLC, BALTIMORE, MD. FILED 11-7-2001.

ANN'S CHOICE

FOR LIFE CARE RETIREMENT HOME SERVICES (U.S. CLS. 100 AND 101).
FIRST USE 10-15-2001; IN COMMERCE 10-15-2001.

CLASS 44—(Continued).

SN 76-324,263. HALL, DEANA, APOPKA, FL. FILED 10-10-2001.

Loving Donation

NO CLAIM IS MADE TO THE EXCLUSIVE RIGHT TO USE "DONATION", APART FROM THE MARK AS SHOWN. FOR COMPUTER SERVICES, NAMELY, PROVIDING ON-LINE INFORMATION WITH A DATABASE IN THE FIELD OF INVITRO-FERTILIZATION (U.S. CLS. 100 AND 101).
FIRST USE 1-1-2001; IN COMMERCE 1-1-2001.

CLASS 44—MEDICAL, BEAUTY AND AGRICULTURAL SERVICES

SN 76-322,495. VISION SERVICE PLAN, RANCHO CORDOVA, CA. FILED 10-9-2001.

SENIORVISION

FOR OPTOMETRY, OPHTHALMOLOGY AND OPTICIAN SERVICES FOR SENIOR CITIZENS (U.S. CLS. 100 AND 101).

SN 76-333,816. PERFORMANCE MODALITIES, INC., DBA PERFORMANCE HOME MEDICAL, KENT, WA. FILED 11-6-2001.

PERFORMANCE HOME MEDICAL

NO CLAIM IS MADE TO THE EXCLUSIVE RIGHT TO USE "HOME MEDICAL", APART FROM THE MARK AS SHOWN. FOR HOME MEDICAL SERVICES, NAMELY, LEASING AND RENTAL OF MEDICAL EQUIPMENT, AND RESPIRATORY THERAPY SERVICES (U.S. CLS. 100 AND 101).
FIRST USE 9-17-2001; IN COMMERCE 9-17-2001.

* * * * *

SECTION 4.—PRIOR UNITED STATES CLASSIFICATION

APPLICATION IN ONE CLASS

COLLECTIVE MEMBERSHIP MARKS

CLASS 200—COLLECTIVE MEMBERSHIP
SN 75-629,427. BUILDING INDUSTRY ASSOCIATION OF
SOUTHEASTERN MICHIGAN, FARMINGTON HILLS,
MI. FILED 1-28-1999.

SN 76-161,523. INTERIOR REDESIGN INDUSTRY SPECIALISTS, BONSALL, CA. FILED 11-8-2000.

PROFESSIONAL MASTER
CRAFTSMAN



OWNER OF U.S. REG. NO. 2,124,467.
SEC. 2(F).
FOR INDICATING MEMBERSHIP IN AN ASSOCIATION OF BUILDING CONSTRUCTION SERVICES PROVIDERS.
FIRST USE 0-0-1995; IN COMMERCE 0-0-1995.

NO CLAIM IS MADE TO THE EXCLUSIVE RIGHT TO USE "INTERIOR REDESIGN INDUSTRY SPECIALISTS", APART FROM THE MARK AS SHOWN.

FOR "APPLICANT IS EXERCISING LEGITIMATE CONTROL OVER THE USE OF THE MARK IN COMMERCE BY ITS MEMBERS" - ONLY MEMBERS WHO ARE IN GOOD STANDING AND PAY THEIR YEARLY DUES ARE THE CLASS OF PERSONS ENTITLED TO USE THE MARK AND THEIR RELATIONSHIP TO THE APPLICANT WOULD BE MEMBERS AND THE NATURE OF THE APPLICANT'S CONTROL OVER THE USE OF THE MARK WOULD BE THAT IT SETS CERTAIN STANDARDS FOR ITS MEMBERS, NAMELY THAT THE MEMBERS OF THIS ORGANIZATION ARE REQUIRED TO BE CERTIFIED INTERIOR DESIGNERS AND INDEPENDENT BUSINESS OWNERS.
FIRST USE 10-6-2000; IN COMMERCE 10-6-2000.

SN 75-636,881. BUILDING INDUSTRY ASSOCIATION OF SOUTHEASTERN MICHIGAN, SOUTHFIELD, MI. FILED 2-9-1999.

INDUSTRY PROFESSIONAL

SEC. 2(F).
FOR INDICATING MEMBERSHIP IN AN ASSOCIATION OF BUILDING CONSTRUCTION SERVICES PROVIDERS.
FIRST USE 0-0-1995; IN COMMERCE 0-0-1995.

SN 76-328,063. INTERNATIONAL BROTHERHOOD OF TEAMSTERS, WASHINGTON, DC. FILED 10-22-2001.

INTERNATIONAL
BROTHERHOOD OF
TEAMSTERS

SN 76-157,225. BROTHERS WORD, KEARNEY, MO. FILED 11-2-2000.

OWNER OF U.S. REG. NOS. 1,286,640, 1,994,996 AND OTHERS.

SEC. 2(F).
FOR INDICATING MEMBERSHIP IN A LABOR UNION OF TRANSPORTATION, MAINTENANCE, HANDLING AND HEALTHCARE WORKERS, AND PUBLIC EMPLOYEES.
FIRST USE 7-0-1991; IN COMMERCE 7-0-1991.

BROTHERS WORD

FOR INDICATING MEMBERSHIP IN A SOCIAL CLUB FOR MOTORCYCLE RIDERS.
FIRST USE 1-1-1974; IN COMMERCE 1-1-1974.

CERTIFICATION MARKS

CLASS B—SERVICES

SN 76-097,084. AUDITORY-VERBAL INTERNATIONAL, INC., ALEXANDRIA, VA. FILED 7-26-2000.

SN 76-298,798. UPNP IMPLEMENTERS CORPORATION, NEW YORK, NY. FILED 8-13-2001.

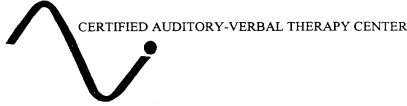

NO CLAIM IS MADE TO THE EXCLUSIVE RIGHT TO USE "CERTIFIED" AND "THERAPY CENTER", APART FROM THE MARK AS SHOWN.

THE CERTIFICATION, AS INTENDED TO BE USED, CERTIFIES THAT "HEALTH SERVICES FACILITIES" AUTHORIZED BY CERTIFIER, INDICATES THAT FACILITIES HAVE ACHIEVED A SPECIFIC LEVEL OF PROFESSIONAL KNOWLEDGE IN THE FIELD OF TEACHING LISTENING AND SPEAKING SKILLS TO CHILDREN WHO ARE DEAF OR HARD OF HEARING ACCORDING TO STANDARDS SET BY THE CERTIFIER.

SEC. 2(F) AS TO "AUDITORY-VERBAL".

FOR BUSINESSES AND HEALTH SERVICES FACILITIES INVOLVED IN EDUCATIONAL SERVICES, NAMELY, DEVELOPING COMMUNICATION AND SOCIALIZATION SKILLS FOR CHILDREN WITH HEARING IMPAIRMENTS.



THE CERTIFICATION MARK, AS INTENDED TO BE USED BY AUTHORIZED PERSONS, IS INTENDED TO CERTIFY THAT THE SERVICES ARE BEING PERFORMED BY A PERSON MEETING STANDARDS AND TESTS OF COMPETENCY, SKILL, EXPERIENCE AND KNOWLEDGE REGARDING THE INTEROPERABILITY OF GOODS ON A GLOBAL OR PRIVATE COMPUTER NETWORK.

FOR COMPUTER HARDWARE AND SOFTWARE PROGRAMMING AND RELATED CONSULTING, SCIENTIFIC RESEARCH, BUILDING CONSTRUCTION AND REPAIR SERVICES, BUSINESS ADMINISTRATION SERVICES AND EDUCATION AND TRAINING SERVICES.

* * * * *

TRADEMARK REGISTRATIONS ISSUED

PRINCIPAL REGISTER

SECTION 1.— INTERNATIONAL CLASSIFICATION

The short titles associated below with the international class numbers are terms designed merely for quick identification and are not an official part of the international classification. The full names of international classes are given in section 6.1 of the trademark rules of practice.

The designation "U.S. Cl." appearing in this section refers to the U.S. class in effect prior to Sep. 1, 1973 rather than the international class which applies to applications filed on or after that date. For adoption of international classification see notice in the OFFICIAL GAZETTE of Jun. 26, 1973 (911 O.G. TM 210).

CLASS 1—CHEMICALS

- 2,570,523. **ORICA**. ORICA AUSTRALIA PTY LTD, BY CHANGE OF NAME ICI AUSTRALIA OPERATIONS PROPRIETARY LIMITED, (U.S. CLS. 1, 5, 6, 10, 26 AND 46). SN 75-423,220. PUB. 9-4-2001. FILED 1-23-1998.
- 2,570,531. **INUTEC**. RAFFINERIE TIRLEMONTAISE S.A., EN NEERLANDAIS TIENSE SUIKERRAFFINADERIJ N.V., (U.S. CLS. 1, 5, 6, 10, 26 AND 46). SN 75-487,080. PUB. 2-26-2002. FILED 5-18-1998.
- 2,570,535. **ORICA AND DESIGN**. ORICA AUSTRALIA PTY LTD, (U.S. CLS. 1, 5, 6, 10, 26 AND 46). SN 75-505,626. PUB. 9-4-2001. FILED 6-19-1998.
- 2,570,553. **QTC**. XENOVA LTD., MULTIPLE CLASS, (INT. CLS. 1, 5 AND 42), (U.S. CLS. 1, 5, 6, 10, 18, 26, 44, 46, 51, 52, 100 AND 101). SN 75-582,112. PUB. 11-27-2001. FILED 11-3-1998.
- 2,570,577. **SILFAR**. WACKER-CHEMIE GMBH, MULTIPLE CLASS, (INT. CLS. 1 AND 5), (U.S. CLS. 1, 5, 6, 10, 18, 26, 44, 46, 51 AND 52). SN 75-635,204. PUB. 11-27-2001. FILED 2-5-1999.
- 2,570,587. **ELASTAMAX**. M.A. HANNA COMPANY, (U.S. CLS. 1, 5, 6, 10, 26 AND 46). SN 75-669,721. PUB. 12-7-1999. FILED 3-29-1999.
- 2,570,734. **ATLANGENE APPLICATIONS**. ATLANGENE APPLICATIONS, MULTIPLE CLASS, (INT. CLS. 1, 5 AND 42), (U.S. CLS. 1, 5, 6, 10, 18, 26, 44, 46, 51, 52, 100 AND 101). SN 75-929,390. PUB. 1-22-2002. FILED 2-28-2000.
- 2,570,742. **RONACOAT**. SHIPLEY COMPANY, L.L.C., (U.S. CLS. 1, 5, 6, 10, 26 AND 46). SN 75-938,546. PUB. 2-26-2002. FILED 3-8-2000.
- 2,571,019. **POLYPURE**. PURESYN, INC., (U.S. CLS. 1, 5, 6, 10, 26 AND 46). SN 76-126,747. PUB. 2-26-2002. FILED 9-12-2000.
- 2,571,043. **VARA**. SCHUMANN SASOL GMBH, MULTIPLE CLASS, (INT. CLS. 1, 3, 4 AND 5), (U.S. CLS. 1, 4, 5, 6, 10, 15, 18, 26, 44, 46, 50, 51 AND 52). SN 76-136,194. PUB. 2-26-2002. FILED 9-27-2000.
- 2,571,086. **MOTORKOTE 100**. MOTORKOTE, INC., (U.S. CLS. 1, 5, 6, 10, 26 AND 46). SN 76-156,207. PUB. 2-26-2002. FILED 10-30-2000.
- 2,571,154. **COLOR DNA**. COLOR DNA, (U.S. CLS. 1, 5, 6, 10, 26 AND 46). SN 76-180,132. PUB. 2-26-2002. FILED 12-13-2000.
- 2,571,188. **SURELIGHT**. MARTEK BIOSCIENCES CORPORATION, MULTIPLE CLASS, (INT. CLS. 1 AND 5), (U.S. CLS. 1, 5, 6, 10, 18, 26, 44, 46, 51 AND 52). SN 76-210,460. PUB. 2-26-2002. FILED 2-15-2001.
- 2,571,228. **SMOKE! IN A CAN**. INTERLOGIX, INC., (U.S. CLS. 1, 5, 6, 10, 26 AND 46). SN 76-226,864. PUB. 2-26-2002. FILED 3-12-2001.
- 2,571,289. **GARDEN SONG**. BONIDE PRODUCTS, INC., MULTIPLE CLASS, (INT. CLS. 1 AND 5), (U.S. CLS. 1, 5, 6, 10, 18, 26, 44, 46, 51 AND 52). SN 76-255,148. PUB. 2-26-2002. FILED 5-10-2001.
- 2,571,299. **LOVOC**. COMPOSITE TECHNOLOGY GROUP, LLC, (U.S. CLS. 1, 5, 6, 10, 26 AND 46). SN 76-261,074. PUB. 2-26-2002. FILED 4-27-2001.
- 2,571,326. **ULTRA NATURAL**. INTERNATIONAL FLAVORS & FRAGRANCES INC., MULTIPLE CLASS, (INT. CLS. 1, 3 AND 30), (U.S. CLS. 1, 4, 5, 6, 10, 26, 46, 50, 51 AND 52). SN 76-269,936. PUB. 2-26-2002. FILED 6-11-2001.

- 2,571,378. **BUGBUSTER**. NOVAGEN, INC., (U.S. CLS. 1, 5, 6, 10, 26 AND 46). SN 76-292,367. PUB. 2-26-2002. FILED 8-1-2001.
- 2,571,396. **NATURE'S TURF**. NATURCOM ENTERPRISES, LLC, (U.S. CLS. 1, 5, 6, 10, 26 AND 46). SN 76-306,037. PUB. 2-26-2002. FILED 8-28-2001.
- 2,571,473. **HYDRO-REZ**. LAWTER INTERNATIONAL, INC., (U.S. CLS. 1, 5, 6, 10, 26 AND 46). SN 76-322,557. PUB. 2-26-2002. FILED 10-9-2001.
- 2,571,564. **PERCTEK (STYLIZED)**. NUTEK INTERNATIONAL, INC., (U.S. CLS. 1, 5, 6, 10, 26 AND 46). SN 78-041,768. PUB. 2-26-2002. FILED 1-4-2001.
- 2,571,585. **MISCELLANEOUS DESIGN**. SAF-T-LOK INTERNATIONAL, (U.S. CLS. 1, 5, 6, 10, 26 AND 46). SN 78-048,745. PUB. 2-26-2002. FILED 2-16-2001.
- 2,571,608. **TACS.XL**. TREVIGEN, INC., (U.S. CLS. 1, 5, 6, 10, 26 AND 46). SN 78-055,186. PUB. 2-26-2002. FILED 3-27-2001.

CLASS 2—PAINTS

- 2,570,525. **CHROMA-SPHERES**. CHROMA CORPORATION, (U.S. CLS. 6, 11 AND 16). SN 75-429,445. PUB. 2-26-2002. FILED 2-5-1998.
- 2,570,747. **PEGASUS**. APOLLO COLORS, INC., (U.S. CLS. 6, 11 AND 16). SN 75-942,316. PUB. 4-24-2001. FILED 3-13-2000.
- 2,570,813. **CLIMASHIELD**. ILLINOIS TOOL WORKS INC., (U.S. CLS. 6, 11 AND 16). SN 76-047,977. PUB. 4-3-2001. FILED 5-15-2000.
- 2,570,964. **STP**. ARMOR AII/STP PRODUCTS COMPANY, THE, MULTIPLE CLASS, (INT. CLS. 2 AND 4), (U.S. CLS. 1, 6, 11, 15 AND 16). SN 76-112,854. PUB. 2-26-2002. FILED 8-21-2000.
- 2,570,988. **HYDROBLOCK**. BURGESS CHEMICALS, LTD., (U.S. CLS. 6, 11 AND 16). SN 76-117,966. PUB. 2-26-2002. FILED 8-29-2000.
- 2,571,286. **BOTTOMSHIELD**. WEST MARINE IHC I, INC., (U.S. CLS. 6, 11 AND 16). SN 76-253,371. PUB. 2-26-2002. FILED 5-4-2001.
- 2,571,481. **MICROBRITE**. ADSIL LC, (U.S. CLS. 6, 11 AND 16). SN 76-325,463. PUB. 2-26-2002. FILED 10-16-2001.

CLASS 3—COSMETICS AND CLEANING PREPARATIONS

- 2,570,490. **NODDY**. ENID BLYTON LIMITED, MULTIPLE CLASS, (INT. CLS. 3, 9, 14, 16, 18, 20, 21, 24, 25, 27, 28, 29, 30 AND 41), (U.S. CLS. 1, 2, 3, 4, 5, 6, 13, 19, 20, 21, 22, 23, 25, 26, 27, 28, 29, 30, 32, 33, 36, 37, 38, 39, 40, 41, 42, 46, 50, 51, 52, 100, 101 AND 107). SN 75-193,403. PUB. 7-10-2001. FILED 11-5-1996.
- 2,570,554. **LIGHT'NING GEL**. GOLDEN SUN, INC., (U.S. CLS. 1, 4, 6, 50, 51 AND 52). SN 75-583,879. PUB. 2-26-2002. FILED 11-2-1998.
- 2,570,571. **QUICK STICK**. L'OREAL, (U.S. CLS. 1, 4, 6, 50, 51 AND 52). SN 75-610,619. PUB. 2-26-2002. FILED 12-22-1998.

- 2,570,572. **QUIK STICK**. L'OREAL, (U.S. CLS. 1, 4, 6, 50, 51 AND 52). SN 75-610,623. PUB. 2-26-2002. FILED 12-22-1998.
- 2,570,581. **DRI-CLEAN (STYLIZED)**. DECON LABORATORIES, INC., (U.S. CLS. 1, 4, 6, 50, 51 AND 52). SN 75-646,077. PUB. 2-26-2002. FILED 2-22-1999.
- 2,570,617. **TASK TOOL AND SHOP CLEANER AND DESIGN**. MASTER CHEMICAL CORPORATION, (U.S. CLS. 1, 4, 6, 50, 51 AND 52). SN 75-744,904. PUB. 9-4-2001. FILED 7-6-1999.
- 2,570,740. **RADIANCE**. WARSAW CHEMICAL CO., INC., (U.S. CLS. 1, 4, 6, 50, 51 AND 52). SN 75-938,231. PUB. 2-26-2002. FILED 3-8-2000.
- 2,570,741. **RADIANCE THE SIGHT & SCENT EXPERIENCE AND DESIGN**. WARSAW CHEMICAL CO., INC., (U.S. CLS. 1, 4, 6, 50, 51 AND 52). SN 75-938,242. PUB. 2-26-2002. FILED 3-8-2000.
- 2,570,801. **ORGANIC ROOT STIMULATOR**. NAMASTE LABORATORIES, L.L.C., (U.S. CLS. 1, 4, 6, 50, 51 AND 52). SN 76-038,139. PUB. 2-26-2002. FILED 5-1-2000.
- 2,570,824. **CLEAN AT LAST (STYLIZED)**. HAMPTON DIRECT INC., (U.S. CLS. 1, 4, 6, 50, 51 AND 52). SN 76-053,582. PUB. 2-26-2002. FILED 5-22-2000.
- 2,570,828. **AM A-MIRACLE GENTLE SILK AND DESIGN**. D & D BEAUTY DISTRIBUTORS, INC., (U.S. CLS. 1, 4, 6, 50, 51 AND 52). SN 76-055,071. PUB. 2-26-2002. FILED 5-22-2000.
- 2,570,846. **C CARA COSMETICS INTERNATIONAL AND DESIGN**. CARA COSMETICS INTERNATIONAL, INC., (U.S. CLS. 1, 4, 6, 50, 51 AND 52). SN 76-066,992. PUB. 2-26-2002. FILED 6-9-2000.
- 2,570,848. **BRONZER SOLEIL**. SOFT SHEEN/CARSON INC., BY MERGER; BY MERGER. BY CHANGE OF NAME; BY CHANGE OF NAME DERMABLEND, INC., A DIVISION OF CARSON PRODUCTS COMPANY, (U.S. CLS. 1, 4, 6, 50, 51 AND 52). SN 76-067,779. PUB. 2-26-2002. FILED 6-12-2000.
- 2,570,861. **U2B PLUS**. DODO CORP., (U.S. CLS. 1, 4, 6, 50, 51 AND 52). SN 76-073,656. PUB. 10-23-2001. FILED 6-20-2000.
- 2,570,907. **LEMONCARE**. COCOCARE PRODUCTS, INC., (U.S. CLS. 1, 4, 6, 50, 51 AND 52). SN 76-087,572. PUB. 2-26-2002. FILED 7-12-2000.
- 2,570,909. **BON GELLE**. AMERICAN CONSUMER PRODUCTS, LLC, (U.S. CLS. 1, 4, 6, 50, 51 AND 52). SN 76-088,712. PUB. 2-26-2002. FILED 7-12-2000.
- 2,570,951. **P PIERREL (STYLIZED)**. PIERREL FARMACEUTICI S.P.A., MULTIPLE CLASS, (INT. CLS. 3 AND 5), (U.S. CLS. 1, 4, 6, 18, 44, 46, 50, 51 AND 52). SN 76-105,889. PUB. 2-26-2002. FILED 8-9-2000.
- 2,570,954. **BOUMATIC AND DESIGN**. DEC INTERNATIONAL, INC., MULTIPLE CLASS, (INT. CLS. 3, 4, 5, 6, 7, 8, 9, 11, 17, 20 AND 21), (U.S. CLS. 1, 2, 4, 5, 6, 12, 13, 14, 15, 18, 19, 21, 22, 23, 25, 26, 28, 29, 30, 31, 32, 33, 34, 35, 36, 38, 40, 44, 46, 50, 51 AND 52). SN 76-108,510. PUB. 2-26-2002. FILED 8-14-2000.
- 2,570,956. **AL AND DESIGN**. ALBION COSMETICS CO., LTD., (U.S. CLS. 1, 4, 6, 50, 51 AND 52). SN 76-109,209. PUB. 2-26-2002. FILED 8-15-2000.
- 2,571,043 (*See Class 1 for this trademark*).
- 2,571,053. **THE FASTEST WAY TO A SMOOTH BIKINI LINE**. PRIVA SHAVE CORPORATION, (U.S. CLS. 1, 4, 6, 50, 51 AND 52). SN 76-142,321. PUB. 2-26-2002. FILED 10-6-2000.
- 2,571,134. **BRITE-BAK**. HILLYARD ENTERPRISES, INC., (U.S. CLS. 1, 4, 6, 50, 51 AND 52). SN 76-171,728. PUB. 8-14-2001. FILED 11-28-2000.
- 2,571,151. **SAPPHIRE BLUE**. HERMES SCHLEIFMITTEL GMBH & CO., (U.S. CLS. 1, 4, 6, 50, 51 AND 52). SN 76-179,084. PUB. 2-26-2002. FILED 12-11-2000.
- 2,571,191. **LENIBAIN**. PIERRE FABRE DERMO-COSMETIQUE, (U.S. CLS. 1, 4, 6, 50, 51 AND 52). SN 76-211,751. PUB. 2-26-2002. FILED 2-16-2001.
- 2,571,219. **STICK FRISSON ZONES SENSORIELLES**. KENZO, (U.S. CLS. 1, 4, 6, 50, 51 AND 52). SN 76-224,839. PUB. 2-26-2002. FILED 3-15-2001.
- 2,571,255. **BEACH BUM GEAR**. TODD CHRISTOPHER INTERNATIONAL, INC., DBA VOGUE INTERNATIONAL, INC., (U.S. CLS. 1, 4, 6, 50, 51 AND 52). SN 76-241,818. PUB. 10-9-2001. FILED 4-12-2001.
- 2,571,275. **LANSINOH BRAND LANOLIN THE WORLD'S PUREST LANOLIN AND DESIGN**. LANSINOH LABORATORIES, INC., MULTIPLE CLASS, (INT. CLS. 3 AND 4), (U.S. CLS. 1, 4, 6, 15, 50, 51 AND 52). SN 76-248,258. PUB. 2-26-2002. FILED 4-30-2001.
- 2,571,302. **STONE CARE MADE EASY**. DRAZGA, EDWARD A., MULTIPLE CLASS, (INT. CLS. 3 AND 17), (U.S. CLS. 1, 4, 5, 6, 12, 13, 35, 50, 51 AND 52). SN 76-261,480. PUB. 2-26-2002. FILED 5-18-2001.
- 2,571,303. **RELEASE**. LIFE INDUSTRIES CORPORATION, (U.S. CLS. 1, 4, 6, 50, 51 AND 52). SN 76-261,844. PUB. 2-26-2002. FILED 5-24-2001.
- 2,571,321. **RX SENSODYNE 2X A DAY EVERY DAY AND DESIGN**. DENTCO, INC., (U.S. CLS. 1, 4, 6, 50, 51 AND 52). SN 76-268,955. PUB. 2-26-2002. FILED 6-8-2001.
- 2,571,326 (*See Class 1 for this trademark*).
- 2,571,329. **SPA BLENDS**. SPA BLENDS, (U.S. CLS. 1, 4, 6, 50, 51 AND 52). SN 76-272,479. PUB. 2-26-2002. FILED 6-15-2001.
- 2,571,352. **ENPHUSE INTENSIVE RECONSTRUCTOR**. NEXXUS PRODUCTS COMPANY, (U.S. CLS. 1, 4, 6, 50, 51 AND 52). SN 76-282,540. PUB. 2-26-2002. FILED 7-9-2001.
- 2,571,356. **STRUNG OUT!**. LADOVE, INC., (U.S. CLS. 1, 4, 6, 50, 51 AND 52). SN 76-283,001. PUB. 2-26-2002. FILED 7-10-2001.
- 2,571,395. **CHILCA MIRACLEMUD**. WORLD WIDE BEAUTY, INC., (U.S. CLS. 1, 4, 6, 50, 51 AND 52). SN 76-305,510. PUB. 2-26-2002. FILED 8-28-2001.
- 2,571,425. **SWEET SATIN SHAVE**. BENEFIT COSMETICS LLC, (U.S. CLS. 1, 4, 6, 50, 51 AND 52). SN 76-313,514. PUB. 2-26-2002. FILED 9-17-2001.
- 2,571,445. **ECOLO-CLEAN**. VARN INTERNATIONAL, INC., (U.S. CLS. 1, 4, 6, 50, 51 AND 52). SN 76-316,886. PUB. 2-26-2002. FILED 9-25-2001.
- 2,571,496. **LUXURIA**. VELLUS PRODUCTS, INC., (U.S. CLS. 1, 4, 6, 50, 51 AND 52). SN 78-017,260. PUB. 5-29-2001. FILED 7-18-2000.
- 2,571,549. **FACE IT COSMETICS, INC.**. FACE IT COSMETICS, INC., (U.S. CLS. 1, 4, 6, 50, 51 AND 52). SN 78-037,343. PUB. 2-26-2002. FILED 12-1-2000.
- 2,571,577. **MIA MONTE**. MIYAMONTE U.S.A., INC., (U.S. CLS. 1, 4, 6, 50, 51 AND 52). SN 78-045,933. PUB. 2-26-2002. FILED 1-31-2001.
- 2,571,581. **BOD MAN**. PARFUMS DE COEUR, LTD., (U.S. CLS. 1, 4, 6, 50, 51 AND 52). SN 78-047,042. PUB. 2-26-2002. FILED 2-7-2001.
- 2,571,602. **MONTECATINI**. TERME DI MONTECATINI S.P.A., (U.S. CLS. 1, 4, 6, 50, 51 AND 52). SN 78-054,352. PUB. 2-26-2002. FILED 3-21-2001.
- 2,571,667. **STONER**. STONER INCORPORATED, (U.S. CLS. 1, 4, 6, 50, 51 AND 52). SN 78-077,757. PUB. 2-26-2002. FILED 8-6-2001.
- 2,571,670. **MOTIONS FOR KIDS**. ALBERTO-CULVER COMPANY, (U.S. CLS. 1, 4, 6, 50, 51 AND 52). SN 78-081,926. PUB. 2-26-2002. FILED 8-30-2001.
- 2,571,684. **APRIL FRESH**. PROCTER & GAMBLE COMPANY, THE, (U.S. CLS. 1, 4, 6, 50, 51 AND 52). SN 78-087,673. PUB. 2-26-2002. FILED 10-10-2001.

CLASS 4—LUBRICANTS AND FUELS

- 2,570,504. **MISCELLANEOUS DESIGN**. BP AMOCO P.L.C., BY CHANGE OF NAME BRITISH PETROLEUM COMPANY P.L.C., THE, (U.S. CLS. 1, 6 AND 15). SN 75-320,784. PUB. 7-25-2000. FILED 7-8-1997.
- 2,570,562. **NESCO**. NESTOR SALES LLC, BY ASSIGNMENT NESTOR SALES CO., INC., MULTIPLE CLASS, (INT. CLS. 4, 6, 7, 8, 9, 11, 12, 17 AND 20), (U.S. CLS. 1, 2, 5, 6, 12, 13, 14, 15, 19, 21, 22, 23, 25, 26, 28, 31, 32, 34, 35, 36, 38, 44 AND 50). SN 75-605,474. PUB. 1-9-2001. FILED 12-14-1998.
- 2,570,954 (*See Class 3 for this trademark*).
- 2,570,964 (*See Class 2 for this trademark*).
- 2,571,043 (*See Class 1 for this trademark*).
- 2,571,184. **SMOKEHOUSE**. ROYAL OAK SALES, INC., (U.S. CLS. 1, 6 AND 15). SN 76-208,567. PUB. 2-26-2002. FILED 2-12-2001.
- 2,571,274. **PRIMOL**. EXXON MOBIL CORPORATION (FORMERLY EXXON CORPORATION), (U.S. CLS. 1, 6 AND 15). SN 76-248,025. PUB. 2-26-2002. FILED 4-27-2001.
- 2,571,275 (*See Class 3 for this trademark*).

- 2,571,476. **ACADIAN AND DESIGN**. ACADIAN CANDLE COMPANY, (U.S. CLS. 1, 6 AND 15). SN 76-324,305. PUB. 2-26-2002. FILED 10-12-2001.
- 2,571,477. **ACADIAN**. ACADIAN CANDLE COMPANY, (U.S. CLS. 1, 6 AND 15). SN 76-324,306. PUB. 2-26-2002. FILED 10-12-2001.
- 2,571,676. **SMOOTH LUBE**. TRIPP, MARTHA J., (U.S. CLS. 1, 6 AND 15). SN 78-084,405. PUB. 2-26-2002. FILED 9-18-2001.

CLASS 5—PHARMACEUTICALS

- 2,570,539. **LINE DRIED LINEN**. THOMAS PINK LIMITED, (U.S. CLS. 6, 18, 44, 46, 51 AND 52). SN 75-506,979. PUB. 1-9-2001. FILED 6-22-1998.
- 2,570,553 (*See Class 1 for this trademark*).
- 2,570,577 (*See Class 1 for this trademark*).
- 2,570,661. **I-OXY**. SITUS CORPORATION, (U.S. CLS. 6, 18, 44, 46, 51 AND 52). SN 75-821,586. PUB. 7-3-2001. FILED 10-12-1999.
- 2,570,674. **MAGICAL**. ROYAL BODYCARE, INC., (U.S. CLS. 6, 18, 44, 46, 51 AND 52). SN 75-846,288. PUB. 2-26-2002. FILED 11-10-1999.
- 2,570,676. **CEMACER**. ASTRA AKTIEBOLAG, (U.S. CLS. 6, 18, 44, 46, 51 AND 52). SN 75-849,061. PUB. 2-26-2002. FILED 11-15-1999.
- 2,570,723. **BIBLUEPRINT**. BIOSPECIFICS, LLC, (U.S. CLS. 6, 18, 44, 46, 51 AND 52). SN 75-920,193. PUB. 5-22-2001. FILED 2-4-2000.
- 2,570,734 (*See Class 1 for this trademark*).
- 2,570,756. **MIPRAAX**. SANOFI-SYNTHELABO, (U.S. CLS. 6, 18, 44, 46, 51 AND 52). SN 76-002,155. PUB. 10-16-2001. FILED 3-16-2000.
- 2,570,757. **PERFECT START**. NIKKEN USA, INC., (U.S. CLS. 6, 18, 44, 46, 51 AND 52). SN 76-002,290. PUB. 1-9-2001. FILED 3-16-2000.
- 2,570,890. **TADIN**. GONZALEZ-BLANCO, JOSE M., (U.S. CLS. 6, 18, 44, 46, 51 AND 52). SN 76-081,619. PUB. 2-26-2002. FILED 6-29-2000.
- 2,570,951 (*See Class 3 for this trademark*).
- 2,570,954 (*See Class 3 for this trademark*).
- 2,570,982. **CYBER-CLENZ AND DESIGN**. CYBER-CLENZ, L.L.C., MULTIPLE CLASS, (INT. CLS. 5 AND 21), (U.S. CLS. 2, 6, 13, 18, 23, 29, 30, 33, 40, 44, 46, 50, 51 AND 52). SN 76-117,598. PUB. 2-26-2002. FILED 8-29-2000.
- 2,571,000. **AIR-POWER**. CALIFORNIA SCENTS, (U.S. CLS. 6, 18, 44, 46, 51 AND 52). SN 76-123,147. PUB. 2-26-2002. FILED 9-6-2000.
- 2,571,041. **ADULT STRENGTH YET CHILD SAFE**. NORSTAR CONSUMER PRODUCTS CO., INC., (U.S. CLS. 6, 18, 44, 46, 51 AND 52). SN 76-135,708. PUB. 2-26-2002. FILED 9-26-2000.
- 2,571,043 (*See Class 1 for this trademark*).
- 2,571,135. **MEDITERRANEAN LIFESTYLE**. PHARMED GROUP HOLDINGS, INC., (U.S. CLS. 6, 18, 44, 46, 51 AND 52). SN 76-171,796. PUB. 2-26-2002. FILED 11-29-2000.
- 2,571,188 (*See Class 1 for this trademark*).
- 2,571,203. **ISOPTO**. ALCON MANUFACTURING, LTD., (U.S. CLS. 6, 18, 44, 46, 51 AND 52). SN 76-218,840. PUB. 9-11-2001. FILED 3-2-2001.
- 2,571,213. **SCOUR STOP**. BOVINE HEALTH PRODUCTS, INC., (U.S. CLS. 6, 18, 44, 46, 51 AND 52). SN 76-223,335. PUB. 2-26-2002. FILED 3-12-2001.
- 2,571,268. **THE HEALTHY LINK TO THE MEDITERRANEAN**. PHARMED GROUP HOLDINGS, INC., (U.S. CLS. 6, 18, 44, 46, 51 AND 52). SN 76-245,155. PUB. 2-26-2002. FILED 4-12-2001.
- 2,571,269. **THE ESSENCE OF MEDITERRANEAN WELLNESS**. PHARMED GROUP HOLDINGS, INC., (U.S. CLS. 6, 18, 44, 46, 51 AND 52). SN 76-245,159. PUB. 2-26-2002. FILED 4-12-2001.
- 2,571,283. **SLUG-FEST**. ORCAL, INC., (U.S. CLS. 6, 18, 44, 46, 51 AND 52). SN 76-250,784. PUB. 2-26-2002. FILED 5-2-2001.
- 2,571,289 (*See Class 1 for this trademark*).
- 2,571,324. **JOINT-RITIS AND DESIGN**. NATUROPATHIC LABORATORIES INTERNATIONAL INC., (U.S. CLS. 6, 18, 44, 46, 51 AND 52). SN 76-269,773. PUB. 2-26-2002. FILED 6-11-2001.

- 2,571,402. **MISCELLANEOUS DESIGN**. JACOBSON, CORINNE, (U.S. CLS. 6, 18, 44, 46, 51 AND 52). SN 76-308,682. PUB. 2-26-2002. FILED 9-5-2001.
- 2,571,403. **GLOBORIX**. SMITHKLINE BEECHAM BIOLOGICALS, S.A., (U.S. CLS. 6, 18, 44, 46, 51 AND 52). SN 76-309,023. PUB. 2-26-2002. FILED 9-4-2001.
- 2,571,478. **SUPEREBA**. HARRY J. BOSWORTH COMPANY, (U.S. CLS. 6, 18, 44, 46, 51 AND 52). SN 76-324,903. PUB. 2-26-2002. FILED 10-15-2001.
- 2,571,494. **CERVAPLEXX 13C**. MSKC GROUP LLC DBA PHARMOGENEXX, (U.S. CLS. 6, 18, 44, 46, 51 AND 52). SN 78-014,169. PUB. 9-18-2001. FILED 6-24-2000.
- 2,571,530. **NEON NITS**. NEON NITS, LLC, (U.S. CLS. 6, 18, 44, 46, 51 AND 52). SN 78-033,374. PUB. 2-26-2002. FILED 11-1-2000.
- 2,571,599. **1-AD**. LPJ RESEARCH, INC., (U.S. CLS. 6, 18, 44, 46, 51 AND 52). SN 78-051,648. PUB. 2-26-2002. FILED 3-6-2001.
- 2,571,609. **ANTASTIC ANT BAIT**. HILL, GREGORY, (U.S. CLS. 6, 18, 44, 46, 51 AND 52). SN 78-055,263. PUB. 2-26-2002. FILED 3-27-2001.
- 2,571,611. **THE NATURAL BLADDER**. GREEN, LONNY, S., (U.S. CLS. 6, 18, 44, 46, 51 AND 52). SN 78-056,151. PUB. 2-26-2002. FILED 4-1-2001.
- 2,571,620. **HELFTER FEEDS, INC AND DESIGN**. HELFTER FEEDS, INC., (U.S. CLS. 6, 18, 44, 46, 51 AND 52). SN 78-057,942. PUB. 2-26-2002. FILED 4-11-2001.

CLASS 6—METAL GOODS

- 2,570,562 (*See Class 4 for this trademark*).
- 2,570,566. **GLY.PXG**. FEDERAL-MOGUL WIESBADEN GMBH, MULTIPLE CLASS, (INT. CLS. 6, 7 AND 12), (U.S. CLS. 2, 12, 13, 14, 19, 21, 23, 25, 31, 34, 35, 44 AND 50). SN 75-608,580. PUB. 6-12-2001. FILED 12-17-1998.
- 2,570,567. **GLY.PGZ**. FEDERAL-MOGUL WIESBADEN GMBH, MULTIPLE CLASS, (INT. CLS. 6, 7 AND 12), (U.S. CLS. 2, 12, 13, 14, 19, 21, 23, 25, 31, 34, 35, 44 AND 50). SN 75-608,581. PUB. 6-12-2001. FILED 12-17-1998.
- 2,570,568. **GLY.PBG**. FEDERAL-MOGUL WIESBADEN GMBH, MULTIPLE CLASS, (INT. CLS. 6, 7 AND 12), (U.S. CLS. 2, 12, 13, 14, 19, 21, 23, 25, 31, 34, 35, 44 AND 50). SN 75-608,582. PUB. 6-12-2001. FILED 12-17-1998.
- 2,570,569. **GLY.PG**. FEDERAL-MOGUL WIESBADEN GMBH, MULTIPLE CLASS, (INT. CLS. 6, 7 AND 12), (U.S. CLS. 2, 12, 13, 14, 19, 21, 23, 25, 31, 34, 35, 44 AND 50). SN 75-608,583. PUB. 6-12-2001. FILED 12-17-1998.
- 2,570,570. **GLY..** FEDERAL-MOGUL WIESBADEN GMBH, MULTIPLE CLASS, (INT. CLS. 6, 7 AND 12), (U.S. CLS. 2, 12, 13, 14, 19, 21, 23, 25, 31, 34, 35, 44 AND 50). SN 75-608,584. PUB. 6-12-2001. FILED 12-17-1998.
- 2,570,670. **SICOAT**. SIEMENS AKTIENGESELLSCHAFT, MULTIPLE CLASS, (INT. CLS. 6 AND 40), (U.S. CLS. 2, 12, 13, 14, 23, 25, 50, 100, 103 AND 106). SN 75-839,335. PUB. 2-20-2001. FILED 11-3-1999.
- 2,570,711. **FIT**. VICTAULIC COMPANY OF AMERICA, (U.S. CLS. 2, 12, 13, 14, 23, 25 AND 50). SN 75-901,288. PUB. 1-9-2001. FILED 1-21-2000.
- 2,570,910. **IMPACT**. TIMKEN COMPANY, THE, (U.S. CLS. 2, 12, 13, 14, 23, 25 AND 50). SN 76-089,606. PUB. 2-26-2002. FILED 7-13-2000.
- 2,570,941. **ATS**. HAFELE AMERICA CO., (U.S. CLS. 2, 12, 13, 14, 23, 25 AND 50). SN 76-102,227. PUB. 2-26-2002. FILED 8-3-2000.
- 2,570,954 (*See Class 3 for this trademark*).
- 2,570,980. **BLINDS TO GO**. BLINDS TO GO (U.S.) INC., (U.S. CLS. 2, 12, 13, 14, 23, 25 AND 50). SN 76-117,202. PUB. 2-26-2002. FILED 8-25-2000.
- 2,571,238. **ELIASON**. ELIASON CORPORATION, MULTIPLE CLASS, (INT. CLS. 6 AND 19), (U.S. CLS. 1, 2, 12, 13, 14, 23, 25, 33 AND 50). SN 76-233,448. PUB. 2-26-2002. FILED 3-30-2001.
- 2,571,354. **WESTCHESTER**. DUNBARTON CORPORATION, (U.S. CLS. 2, 12, 13, 14, 23, 25 AND 50). SN 76-282,562. PUB. 2-26-2002. FILED 7-9-2001.
- 2,571,558. **BUYFORMETALS (STYLIZED)**. USINOR, MULTIPLE CLASS, (INT. CLS. 6, 35, 38 AND 42), (U.S. CLS. 2, 12,

- 13, 14, 23, 25, 50, 100, 101, 102 AND 104). SN 78-040,206. PUB. 2-26-2002. FILED 12-21-2000.
- 2,571,572. **WOODHAVEN**. ALEXANDER MFG. CO., (U.S. CLS. 2, 12, 13, 14, 23, 25 AND 50). SN 78-044,753. PUB. 2-26-2002. FILED 1-24-2001.
- 2,571,658. **FASTJACK**. STANLEY ALLEN ULLMAN, DBA PROFESSIONAL SOLAR PRODUCTS, (U.S. CLS. 2, 12, 13, 14, 23, 25 AND 50). SN 78-075,813. PUB. 2-26-2002. FILED 7-26-2001.

CLASS 7—MACHINERY

- 2,570,479. **ZPS**. ZAVODY PRESNEHO STROJIRENSTVI, (U.S. CLS. 13, 19, 21, 23, 31, 34 AND 35). SN 74-118,389. PUB. 4-18-2000. FILED 11-27-1990.
- 2,570,562 (*See Class 4 for this trademark*).
- 2,570,566 (*See Class 6 for this trademark*).
- 2,570,567 (*See Class 6 for this trademark*).
- 2,570,568 (*See Class 6 for this trademark*).
- 2,570,569 (*See Class 6 for this trademark*).
- 2,570,570 (*See Class 6 for this trademark*).
- 2,570,603. **TORQUEMASTER**. WAYNE-DALTON CORP., (U.S. CLS. 13, 19, 21, 23, 31, 34 AND 35). SN 75-710,677. PUB. 12-26-2000. FILED 5-20-1999.
- 2,570,618. **G GERARDI AND DESIGN**. GERARDI S.P.A., MULTIPLE CLASS, (INT. CLS. 7 AND 8), (U.S. CLS. 13, 19, 21, 23, 28, 31, 34, 35 AND 44). SN 75-752,318. PUB. 6-26-2001. FILED 7-15-1999.
- 2,570,681. **HIGHLINER**. BALDWIN GRAFOTEC GMBH, MULTIPLE CLASS, (INT. CLS. 7 AND 11), (U.S. CLS. 13, 19, 21, 23, 31, 34 AND 35). SN 75-861,640. PUB. 12-18-2001. FILED 12-1-1999.
- 2,570,712. **DISC-O-MATIC**. ARIENS COMPANY, MULTIPLE CLASS, (INT. CLS. 7 AND 8), (U.S. CLS. 13, 19, 21, 23, 28, 31, 34, 35 AND 44). SN 75-902,195. PUB. 2-26-2002. FILED 1-26-2000.
- 2,570,748. **LAWNPARTS**. AUTOMOTLVE EQUIPMENT SERVICE, INC., DBA AES-LAWNPARTS, (U.S. CLS. 13, 19, 21, 23, 31, 34 AND 35). SN 75-942,353. PUB. 11-6-2001. FILED 3-13-2000.
- 2,570,754. **KIPP AND DESIGN**. HEINRICH KIPP WERK, MULTIPLE CLASS, (INT. CLS. 7, 9, 20 AND 26), (U.S. CLS. 2, 13, 19, 21, 22, 23, 25, 26, 31, 32, 34, 35, 36, 37, 38, 39, 40, 42 AND 50). SN 75-982,095. PUB. 6-27-2000. FILED 10-13-1998.
- 2,570,764. **PES**. PES INC., MULTIPLE CLASS, (INT. CLS. 7, 9 AND 42), (U.S. CLS. 13, 19, 21, 23, 26, 31, 34, 35, 36, 38, 100 AND 101). SN 76-011,166. PUB. 2-26-2002. FILED 3-28-2000.
- 2,570,809. **SPIREX**. SPIREX CORPORATION, (U.S. CLS. 13, 19, 21, 23, 31, 34 AND 35). SN 76-046,316. PUB. 2-26-2002. FILED 5-10-2000.
- 2,570,826. **OSM OPTIMUM SPLICE MATCH**. BANDAG LICENSING CORPORATION, (U.S. CLS. 13, 19, 21, 23, 31, 34 AND 35). SN 76-054,116. PUB. 2-26-2002. FILED 5-23-2000.
- 2,570,853. **SERVITEL E-SERVICE**. SCHINDLER AUGZUGE AG, MULTIPLE CLASS, (INT. CLS. 7, 9, 37 AND 42), (U.S. CLS. 13, 19, 21, 23, 26, 31, 34, 35, 36, 38, 100, 101, 103 AND 106). SN 76-070,577. PUB. 2-26-2002. FILED 6-15-2000.
- 2,570,869. **TYPHOON INTAKE SYSTEMS AND DESIGN**. K&N ENGINEERING, INC., (U.S. CLS. 13, 19, 21, 23, 31, 34 AND 35). SN 76-076,465. PUB. 2-26-2002. FILED 6-23-2000.
- 2,570,954 (*See Class 3 for this trademark*).
- 2,571,078. **SAW-LUTIONS**. WATKINS MANUFACTURING COMPANY INC., (U.S. CLS. 13, 19, 21, 23, 31, 34 AND 35). SN 76-153,072. PUB. 2-26-2002. FILED 10-23-2000.
- 2,571,149. **V-DRIVE (STYLIZED)**. ALPHA GETRIEBEBAU GMBH, (U.S. CLS. 13, 19, 21, 23, 31, 34 AND 35). SN 76-178,026. PUB. 9-4-2001. FILED 12-8-2000.
- 2,571,342. **ENVIROPRIME SYSTEM**. THOMPSON PUMP & MANUFACTURING COMPANY, INC., (U.S. CLS. 13, 19, 21, 23, 31, 34 AND 35). SN 76-276,525. PUB. 2-26-2002. FILED 6-25-2001.
- 2,571,363. **HAPMAN**. PRAB, INC., (U.S. CLS. 13, 19, 21, 23, 31, 34 AND 35). SN 76-284,996. PUB. 2-26-2002. FILED 7-13-2001.
- 2,571,387. **NORDSON AND DESIGN**. NORDSON CORPORATION, (U.S. CLS. 13, 19, 21, 23, 31, 34 AND 35). SN 76-

- 301,346. PUB. 2-26-2002. FILED 8-20-2001.
- 2,571,522. **CLEAR-VU**. MAGUIRE PRODUCTS, INC., (U.S. CLS. 13, 19, 21, 23, 31, 34 AND 35). SN 78-031,358. PUB. 10-2-2001. FILED 10-19-2000.
- 2,571,544. **CF34**. GENERAL ELECTRIC COMPANY, BY ASSIGNMENT GE ENGINE SERVICES, INC., (U.S. CLS. 13, 19, 21, 23, 31, 34 AND 35). SN 78-036,099. PUB. 2-26-2002. FILED 11-20-2000.
- 2,571,562. **SMARTSPIN**. IPSO USA, INC., (U.S. CLS. 13, 19, 21, 23, 31, 34 AND 35). SN 78-040,674. PUB. 2-26-2002. FILED 12-27-2000.
- 2,571,621. **REMCO ROCKMAX AND DESIGN**. RODRIGUEZ, DAMIAN E., (U.S. CLS. 13, 19, 21, 23, 31, 34 AND 35). SN 78-058,175. PUB. 2-26-2002. FILED 4-12-2001.
- 2,571,685. **REAMASTER**. SMITH INTERNATIONAL, INC., (U.S. CLS. 13, 19, 21, 23, 31, 34 AND 35). SN 78-087,697. PUB. 2-26-2002. FILED 10-10-2001.

CLASS 8—HAND TOOLS

- 2,570,562 (*See Class 4 for this trademark*).
- 2,570,594. **BODANOVA**. BODA NOVA HOLDING AB, MULTIPLE CLASS, (INT. CLS. 8 AND 21), (U.S. CLS. 2, 13, 23, 28, 29, 30, 33, 40, 44 AND 50). SN 75-681,486. PUB. 3-6-2001. FILED 4-13-1999.
- 2,570,618 (*See Class 7 for this trademark*).
- 2,570,688. **MOON PRODUCTS**. MATHEWS, MATT, (U.S. CLS. 23, 28 AND 44). SN 75-866,717. PUB. 2-26-2002. FILED 12-6-1999.
- 2,570,712 (*See Class 7 for this trademark*).
- 2,570,954 (*See Class 3 for this trademark*).
- 2,571,023. **ALLPAX**. GUARDAIR CORPORATION, (U.S. CLS. 23, 28 AND 44). SN 76-129,350. PUB. 2-26-2002. FILED 9-18-2000.
- 2,571,061. **KCPROAM AND DESIGN**. A.O.K. INDUSTRIAL CO., (U.S. CLS. 23, 28 AND 44). SN 76-145,166. PUB. 2-26-2002. FILED 10-12-2000.

CLASS 9—ELECTRICAL AND SCIENTIFIC APPARATUS

- 2,570,487. **CVTNET**. UNIVERSAL TECHNOLOGY CORPORATION, BY ASSIGNMENT SCHINDLER ELEVATOR CORPORATION, DBA MILLAR ELEVATOR SERVICE COMPANY, (U.S. CLS. 21, 23, 26, 36 AND 38). SN 75-114,247. PUB. 2-26-2002. FILED 6-4-1996.
- 2,570,490 (*See Class 3 for this trademark*).
- 2,570,493. **POSI-LOCK**. SWENCO PRODUCTS, INC., (U.S. CLS. 21, 23, 26, 36 AND 38). SN 75-222,358. PUB. 10-28-1997. FILED 1-6-1997.
- 2,570,505. **ACTIVE IDEAS**. OBJECTWORKS, INC., MULTIPLE CLASS, (INT. CLS. 9 AND 42), (U.S. CLS. 21, 23, 26, 36, 38, 100 AND 101). SN 75-338,124. PUB. 11-7-2000. FILED 8-8-1997.
- 2,570,511. **EPG**. AESCULAP-MEDITEC GMBH, MULTIPLE CLASS, (INT. CLS. 9 AND 10), (U.S. CLS. 21, 23, 26, 36, 38, 39 AND 44). SN 75-357,667. PUB. 5-11-1999. FILED 9-16-1997.
- 2,570,514. **ZIP**. IOMEGA CORPORATION, (U.S. CLS. 21, 23, 26, 36 AND 38). SN 75-378,779. PUB. 7-3-2001. FILED 10-24-1997.
- 2,570,515. **QED**. QED INFORMATION SYSTEMS, INC., (U.S. CLS. 21, 23, 26, 36 AND 38). SN 75-384,019. PUB. 6-19-2001. FILED 11-3-1997.
- 2,570,516. **SOFTWISE (STYLIZED)**. SOFTWISE CONSULTING SERVICES, INC., (U.S. CLS. 21, 23, 26, 36 AND 38). SN 75-398,361. PUB. 2-26-2002. FILED 12-1-1997.
- 2,570,519. **INTELAVOICE**. VOS SYSTEMS LLC, (U.S. CLS. 21, 23, 26, 36 AND 38). SN 75-412,947. PUB. 8-17-1999. FILED 1-2-1998.
- 2,570,522. **CENTURION GUARD**. CENTURION TECHNOLOGIES, INC., (U.S. CLS. 21, 23, 26, 36 AND 38). SN 75-422,647. PUB. 2-26-2002. FILED 1-26-1998.
- 2,570,526. **TLG**. REGENTS OF THE UNIVERSITY OF CALI-

- FORNIA, THE, (U.S. CLS. 21, 23, 26, 36 AND 38). SN 75-431,808. PUB. 2-26-2002. FILED 2-10-1998.
- 2,570,527. **TRAFFICA**. NOKIA TELECOMMUNICATIONS, MULTIPLE CLASS, (INT. CLS. 9, 37 AND 38), (U.S. CLS. 21, 23, 26, 36, 38, 100, 101, 103, 104 AND 106). SN 75-437,644. PUB. 2-26-2002. FILED 2-20-1998.
- 2,570,528. **MAGIC BALL**. BOTHE, KLAUS, AND HIESINGER, REINHARD, AND MANN, KURT, MULTIPLE CLASS, (INT. CLS. 9 AND 11), (U.S. CLS. 13, 21, 23, 26, 31, 34, 36 AND 38). SN 75-448,071. PUB. 6-19-2001. FILED 3-11-1998.
- 2,570,529. **SIRIUSWARE**. SIRIUSWARE, INC., (U.S. CLS. 21, 23, 26, 36 AND 38). SN 75-467,551. PUB. 10-12-1999. FILED 4-14-1998.
- 2,570,530. **SONERA**. SONERA OJY, BY MERGER, BY CHANGE OF NAME GESAM OY, MULTIPLE CLASS, (INT. CLS. 9, 38 AND 42), (U.S. CLS. 21, 23, 26, 36, 38, 100, 101 AND 104). SN 75-477,319. PUB. 2-26-2002. FILED 4-30-1998.
- 2,570,533. **INNOVATION SCORECARD**. TELIA AB, MULTIPLE CLASS, (INT. CLS. 9, 20, 35, 38, 39, 41 AND 42), (U.S. CLS. 2, 13, 21, 22, 23, 25, 26, 32, 36, 38, 50, 100, 101, 102, 104, 105 AND 107). SN 75-503,394. PUB. 12-12-2000. FILED 6-17-1998.
- 2,570,544. **METROSITE**. NOKIA NETWORKS OY, BY CHANGE OF NAME NOKIA TELECOMMUNICATIONS OY, (U.S. CLS. 21, 23, 26, 36 AND 38). SN 75-542,747. PUB. 2-26-2002. FILED 8-25-1998.
- 2,570,545. **MESSAGEQUEST AND DESIGN**. COMMERCE-QUEST, INC., BY CHANGE OF NAME; BY CHANGE OF NAME TECHNOLOGY INVESTMENTS OF TAMPA BAY, INC., MULTIPLE CLASS, (INT. CLS. 9 AND 42), (U.S. CLS. 21, 23, 26, 36, 38, 100 AND 101). SN 75-544,166. PUB. 9-25-2001. FILED 8-27-1998.
- 2,570,547. **KIPSTA**. DECATHLON, MULTIPLE CLASS, (INT. CLS. 9, 18, 25, 28, 38 AND 41), (U.S. CLS. 1, 2, 3, 21, 22, 23, 26, 36, 38, 39, 41, 50, 100, 101, 104 AND 107). SN 75-548,631. PUB. 1-25-2000. FILED 9-1-1998.
- 2,570,548. **ARKEIA**. ROUSSEL, PHILIPPE, MULTIPLE CLASS, (INT. CLS. 9 AND 42), (U.S. CLS. 21, 23, 26, 36, 38, 100 AND 101). SN 75-551,155. PUB. 2-27-2001. FILED 9-4-1998.
- 2,570,557. **FX66**. SIEMENS AKTIENGESELLSCHAFT, (U.S. CLS. 21, 23, 26, 36 AND 38). SN 75-591,266. PUB. 3-28-2000. FILED 11-18-1998.
- 2,570,562 (*See Class 4 for this trademark*).
- 2,570,564. **DIPOS**. WIELAND ELECTRIC GMBH, (U.S. CLS. 21, 23, 26, 36 AND 38). SN 75-606,746. PUB. 8-28-2001. FILED 12-16-1998.
- 2,570,565. **SYNDEO**. MACADAMIAN TECHNOLOGIES, INC., (U.S. CLS. 21, 23, 26, 36 AND 38). SN 75-608,578. PUB. 7-17-2001. FILED 12-17-1998.
- 2,570,578. **VIP SERIES**. MOTOROLA, INC., (U.S. CLS. 21, 23, 26, 36 AND 38). SN 75-635,512. PUB. 2-26-2002. FILED 2-4-1999.
- 2,570,595. **AGW**. AURA LENS PRODUCTS, INC., (U.S. CLS. 21, 23, 26, 36 AND 38). SN 75-683,832. PUB. 10-17-2000. FILED 4-15-1999.
- 2,570,611. **BELTPACK**. CANAC INC., (U.S. CLS. 21, 23, 26, 36 AND 38). SN 75-737,417. PUB. 11-20-2001. FILED 6-25-1999.
- 2,570,624. **MICRONAS AND DESIGN**. MICRONAS SEMICONDUCTOR HOLDING AG, (U.S. CLS. 21, 23, 26, 36 AND 38). SN 75-764,889. PUB. 10-24-2000. FILED 7-30-1999.
- 2,570,626. **EC3 (STYLIZED)**. PYDERION CONTACT TECHNOLOGIES INC., (U.S. CLS. 21, 23, 26, 36 AND 38). SN 75-773,748. PUB. 2-26-2002. FILED 8-12-1999.
- 2,570,627. **QUOTATIONARY (STYLIZED)**. QUOTATIONARY, L.C., (U.S. CLS. 21, 23, 26, 36 AND 38). SN 75-774,318. PUB. 7-3-2001. FILED 8-12-1999.
- 2,570,628. **HYPERFACT (STYLIZED)**. OPENMIND SOFTWARE TECHNOLOGIES GMBH, MULTIPLE CLASS, (INT. CLS. 9, 16, 41 AND 42), (U.S. CLS. 2, 5, 21, 22, 23, 26, 29, 36, 37, 38, 50, 100, 101 AND 107). SN 75-774,751. PUB. 6-26-2001. FILED 8-13-1999.
- 2,570,629. **YOBET.COM**. YOBET.COM, INC., (U.S. CLS. 21, 23, 26, 36 AND 38). SN 75-774,832. PUB. 11-14-2000. FILED 8-13-1999.
- 2,570,649. **ATLINK**. ADVANCED SYSTEMS INTERNATIONAL, (U.S. CLS. 21, 23, 26, 36 AND 38). SN 75-803,134. PUB. 8-21-2001. FILED 9-20-1999.
- 2,570,658. **DENTAL VISION**. DISCUS DENTAL IMPRESSIONS, INC., (U.S. CLS. 21, 23, 26, 36 AND 38). SN 75-819,433. PUB. 2-26-2002. FILED 10-12-1999.
- 2,570,663. **APPSECURE**. APPSECURE, INC., (U.S. CLS. 21, 23, 26, 36 AND 38). SN 75-824,913. PUB. 5-23-2000. FILED 10-18-1999.
- 2,570,673. **POLAR DESIGN**. INTERNATIONAL MARKETING SERVICES, INC., MULTIPLE CLASS, (INT. CLS. 9 AND 42), (U.S. CLS. 21, 23, 26, 36, 38, 100 AND 101). SN 75-845,038. PUB. 10-16-2001. FILED 11-29-1999.
- 2,570,682. **KONEX**. CISCO SALES CORPORATION, (U.S. CLS. 21, 23, 26, 36 AND 38). SN 75-863,189. PUB. 2-26-2002. FILED 12-3-1999.
- 2,570,683. **EMPAC**. EPC CORPORATION, (U.S. CLS. 21, 23, 26, 36 AND 38). SN 75-863,684. PUB. 5-29-2001. FILED 12-3-1999.
- 2,570,685. **V CORP**. V CORP TECHNOLOGIES, INC., (U.S. CLS. 21, 23, 26, 36 AND 38). SN 75-865,183. PUB. 2-26-2002. FILED 12-17-1999.
- 2,570,686. **V CORP AND DESIGN**. V CORP TECHNOLOGIES, INC., (U.S. CLS. 21, 23, 26, 36 AND 38). SN 75-865,189. PUB. 2-26-2002. FILED 12-17-1999.
- 2,570,692. **TIMEWAP**. MOBIPRO A/S, BY ASSIGNMENT TIME/SYSTEM INTERNATIONAL A/S, (U.S. CLS. 21, 23, 26, 36 AND 38). SN 75-872,494. PUB. 2-26-2002. FILED 12-16-1999.
- 2,570,693. **ICHECKOUT.COM**. ICHECKOUT, INC., MULTIPLE CLASS, (INT. CLS. 9 AND 35), (U.S. CLS. 21, 23, 26, 36, 38, 100, 101 AND 102). SN 75-873,626. PUB. 2-26-2002. FILED 12-17-1999.
- 2,570,701. **PARTQUEST**. COOPERATIVE COMPUTING, INC., (U.S. CLS. 21, 23, 26, 36 AND 38). SN 75-880,730. PUB. 2-26-2002. FILED 12-22-1999.
- 2,570,704. **1-800-WEDDING**. 1-800-WEDDING, INC., (U.S. CLS. 21, 23, 26, 36 AND 38). SN 75-889,736. PUB. 2-26-2002. FILED 1-7-2000.
- 2,570,707. **SCHEMA ELECTRONIC DOCUMENTATION SOLUTIONS GMBH AND DESIGN**. SCHEMA GMBH, MULTIPLE CLASS, (INT. CLS. 9, 35 AND 42), (U.S. CLS. 21, 23, 26, 36, 38, 100, 101 AND 102). SN 75-898,149. PUB. 9-18-2001. FILED 1-19-2000.
- 2,570,709. **OREA**. ZUMTOBEL STAFF GMBH, MULTIPLE CLASS, (INT. CLS. 9, 11 AND 42), (U.S. CLS. 13, 21, 23, 26, 31, 34, 36, 38, 100 AND 101). SN 75-899,007. PUB. 12-25-2001. FILED 1-19-2000.
- 2,570,710. **TARIS**. WIELAND ELECTRIC GMBH, (U.S. CLS. 21, 23, 26, 36 AND 38). SN 75-900,948. PUB. 2-26-2002. FILED 1-21-2000.
- 2,570,713. **STRATUX**. STRATEGIC RESOURCES, INC., (U.S. CLS. 21, 23, 26, 36 AND 38). SN 75-902,539. PUB. 7-3-2001. FILED 1-25-2000.
- 2,570,733. **DIGITAL LIGHT PROCESSING**. TEXAS INSTRUMENTS INCORPORATED, (U.S. CLS. 21, 23, 26, 36 AND 38). SN 75-929,080. PUB. 2-26-2002. FILED 2-28-2000.
- 2,570,739. **COD**. RED HERRING COMMUNICATIONS, INC., (U.S. CLS. 21, 23, 26, 36 AND 38). SN 75-938,095. PUB. 2-26-2002. FILED 3-8-2000.
- 2,570,743. **CITS**. GORDON-DARBY, INC., (U.S. CLS. 21, 23, 26, 36 AND 38). SN 75-939,071. PUB. 2-26-2002. FILED 3-8-2000.
- 2,570,745. **STARBEAM AND DESIGN**. ENTREON CORPORATION, (U.S. CLS. 21, 23, 26, 36 AND 38). SN 75-940,091. PUB. 5-8-2001. FILED 2-18-2000.
- 2,570,754 (*See Class 7 for this trademark*).
- 2,570,761. **INFOTERIA AND DESIGN**. INFOTERIA INC., (U.S. CLS. 21, 23, 26, 36 AND 38). SN 76-006,484. PUB. 2-26-2002. FILED 3-22-2000.
- 2,570,764 (*See Class 7 for this trademark*).
- 2,570,768. **SENTINEL**. TEKONSHA ENGINEERING COMPANY, (U.S. CLS. 21, 23, 26, 36 AND 38). SN 76-013,909. PUB. 2-26-2002. FILED 3-27-2000.
- 2,570,786. **SP**. SYSTEMS MATERIAL HANDLING CO., (U.S. CLS. 21, 23, 26, 36 AND 38). SN 76-025,885. PUB. 2-26-2002. FILED 4-17-2000.
- 2,570,818. **SPYDUS**. SANDERSON COMPUTERS INC., (U.S. CLS. 21, 23, 26, 36 AND 38). SN 76-051,427. PUB. 2-26-2002. FILED 5-18-2000.
- 2,570,834. **NETFORCE**. PROCOM TECHNOLOGY, (U.S. CLS.

- 21, 23, 26, 36 AND 38). SN 76-058,616. PUB. 2-26-2002. FILED 5-30-2000.
- 2,570,840. **MISCELLANEOUS DESIGN. ROSETTI HANDBAGS & ACCESSORIES, LTD.**, MULTIPLE CLASS, (INT. CLS. 9, 16 AND 18), (U.S. CLS. 1, 2, 3, 5, 21, 22, 23, 26, 29, 36, 37, 38, 41 AND 50). SN 76-061,114. PUB. 2-26-2002. FILED 6-1-2000.
- 2,570,844. **TITUS AND DESIGN. TITUS SOFTWARE CORPORATION**, (U.S. CLS. 21, 23, 26, 36 AND 38). SN 76-066,313. PUB. 2-26-2002. FILED 6-8-2000.
- 2,570,850. **INDUSTRIAL DYNAMICS. INDUSTRIAL DYNAMICS COMPANY, LTD.**, (U.S. CLS. 21, 23, 26, 36 AND 38). SN 76-068,118. PUB. 2-26-2002. FILED 6-12-2000.
- 2,570,853 (*See Class 7 for this trademark*).
- 2,570,857. **CV. JAI A/S**, (U.S. CLS. 21, 23, 26, 36 AND 38). SN 76-072,120. PUB. 2-26-2002. FILED 6-15-2000.
- 2,570,860. **BUYLINK. BUYLINK CORPORATION, BY CHANGE OF NAME BUYLINK.COM, INC.**, (U.S. CLS. 21, 23, 26, 36 AND 38). SN 76-073,631. PUB. 2-26-2002. FILED 6-19-2000.
- 2,570,884. **MAGCOM. MAGNER CORPORATION OF AMERICA, BY MERGER MAGNER CORPORATION**, (U.S. CLS. 21, 23, 26, 36 AND 38). SN 76-080,065. PUB. 2-26-2002. FILED 6-29-2000.
- 2,570,891. **ASSETDECIDE. NETDECIDE CORP.**, (U.S. CLS. 21, 23, 26, 36 AND 38). SN 76-082,185. PUB. 2-26-2002. FILED 7-3-2000.
- 2,570,892. **PERSONALDECIDE. NETDECIDE CORP.**, (U.S. CLS. 21, 23, 26, 36 AND 38). SN 76-082,711. PUB. 2-26-2002. FILED 7-3-2000.
- 2,570,893. **CREDITDECIDE. NETDECIDE CORP.**, (U.S. CLS. 21, 23, 26, 36 AND 38). SN 76-082,716. PUB. 2-26-2002. FILED 7-3-2000.
- 2,570,894. **TAXDECIDE. NETDECIDE CORP.**, (U.S. CLS. 21, 23, 26, 36 AND 38). SN 76-082,721. PUB. 2-26-2002. FILED 7-3-2000.
- 2,570,895. **ADVISORDECIDE. NETDECIDE CORP.**, (U.S. CLS. 21, 23, 26, 36 AND 38). SN 76-082,776. PUB. 2-26-2002. FILED 7-3-2000.
- 2,570,905. **LOVE MONKEY MUSIC AND DESIGN. DIPIERO, BOB**, MULTIPLE CLASS, (INT. CLS. 9, 28 AND 41), (U.S. CLS. 21, 22, 23, 26, 36, 38, 50, 100, 101 AND 107). SN 76-087,390. PUB. 2-26-2002. FILED 7-12-2000.
- 2,570,906. **LOVE MONKEY MUSIC. DIPIERO, BOB**, MULTIPLE CLASS, (INT. CLS. 9, 28 AND 41), (U.S. CLS. 21, 22, 23, 26, 36, 38, 50, 100, 101 AND 107). SN 76-087,391. PUB. 2-26-2002. FILED 7-12-2000.
- 2,570,914. **THE WATCH OF THE LORD. ALL NATIONS CHURCH, INC.**, MULTIPLE CLASS, (INT. CLS. 9, 16, 41 AND 42), (U.S. CLS. 2, 5, 21, 22, 23, 26, 29, 36, 37, 38, 50, 100, 101 AND 107). SN 76-092,366. PUB. 2-26-2002. FILED 7-19-2000.
- 2,570,918. **TOTALNET. IEX CORPORATION**, (U.S. CLS. 21, 23, 26, 36 AND 38). SN 76-093,953. PUB. 2-26-2002. FILED 7-21-2000.
- 2,570,919. **TOTALVIEW. IEX CORPORATION**, (U.S. CLS. 21, 23, 26, 36 AND 38). SN 76-093,954. PUB. 2-26-2002. FILED 7-21-2000.
- 2,570,932. **HOMEXAM. HOMEXAM, INC.**, MULTIPLE CLASS, (INT. CLS. 9 AND 16), (U.S. CLS. 2, 5, 21, 22, 23, 26, 29, 36, 37, 38 AND 50). SN 76-098,970. PUB. 2-26-2002. FILED 7-17-2000.
- 2,570,936. **CLANGO. AUDIBLE MAGIC CORPORATION**, (U.S. CLS. 21, 23, 26, 36 AND 38). SN 76-100,486. PUB. 2-26-2002. FILED 8-1-2000.
- 2,570,945. **PRONTO. KONINKLIJKE PHILIPS ELECTRONICS N.V.**, (U.S. CLS. 21, 23, 26, 36 AND 38). SN 76-103,286. PUB. 2-26-2002. FILED 8-4-2000.
- 2,570,947. **SIMPLESCALAR. AUSTIN, TODD M.**, (U.S. CLS. 21, 23, 26, 36 AND 38). SN 76-104,322. PUB. 2-26-2002. FILED 8-7-2000.
- 2,570,954 (*See Class 3 for this trademark*).
- 2,570,978. **UNITREK. CARLISLE MANAGEMENT COMPANY**, (U.S. CLS. 21, 23, 26, 36 AND 38). SN 76-116,705. PUB. 6-26-2001. FILED 8-25-2000.
- 2,571,005. **AVS AND DESIGN. AERIAL VIEW SYSTEMS, INC.**, (U.S. CLS. 21, 23, 26, 36 AND 38). SN 76-123,999. PUB. 2-26-2002. FILED 9-7-2000.
- 2,571,008. **PROSHOTS.COM. HICKS EQUIPMENT, INC.**, MULTIPLE CLASS, (INT. CLS. 9 AND 42), (U.S. CLS. 21, 23, 26, 36, 38, 100 AND 101). SN 76-124,652. PUB. 2-26-2002. FILED 9-11-2000.
- 2,571,009. **DICHONICS. SONIDO, INC.**, (U.S. CLS. 21, 23, 26, 36 AND 38). SN 76-124,673. PUB. 10-23-2001. FILED 9-11-2000.
- 2,571,016. **LISTEN ...WITHOUT DISTURBING !. PETER J. LISTRO ASSOCIATES, LTD.**, (U.S. CLS. 21, 23, 26, 36 AND 38). SN 76-126,224. PUB. 2-26-2002. FILED 9-12-2000.
- 2,571,017. **RFS COMPACT LINE. RADIO FREQUENCY SYSTEMS, INC.**, (U.S. CLS. 21, 23, 26, 36 AND 38). SN 76-126,331. PUB. 2-26-2002. FILED 9-12-2000.
- 2,571,029. **INNOVASIC. INNOVASIC, INC.**, MULTIPLE CLASS, (INT. CLS. 9, 40 AND 42), (U.S. CLS. 21, 23, 26, 36, 38, 100, 101, 103 AND 106). SN 76-132,669. PUB. 9-18-2001. FILED 9-20-2000.
- 2,571,032. **MISCELLANEOUS DESIGN. CORIOLIS GROUP, L.L.C., THE**, (U.S. CLS. 21, 23, 26, 36 AND 38). SN 76-133,429. PUB. 2-26-2002. FILED 9-21-2000.
- 2,571,047. **ACTION FACTOR. ACTION FACTOR INC.**, (U.S. CLS. 21, 23, 26, 36 AND 38). SN 76-139,083. PUB. 2-26-2002. FILED 10-2-2000.
- 2,571,063. **MISCELLANEOUS DESIGN. ARGUS SYSTEMS GROUP, INC.**, (U.S. CLS. 21, 23, 26, 36 AND 38). SN 76-145,947. PUB. 2-26-2002. FILED 10-13-2000.
- 2,571,070. **PIPETBOY. INTEGRA BIOSCIENCES AG**, (U.S. CLS. 21, 23, 26, 36 AND 38). SN 76-148,809. PUB. 2-26-2002. FILED 10-12-2000.
- 2,571,087. **EMASTER AND DESIGN. EMASTER CORPORATION**, (U.S. CLS. 21, 23, 26, 36 AND 38). SN 76-156,290. PUB. 2-26-2002. FILED 10-30-2000.
- 2,571,091. **PACKETHOUND. PALISADE SYSTEMS, INC.**, (U.S. CLS. 21, 23, 26, 36 AND 38). SN 76-158,918. PUB. 2-26-2002. FILED 11-6-2000.
- 2,571,102. **PATIENT ONLINE. IDX SYSTEMS CORPORATION**, MULTIPLE CLASS, (INT. CLS. 9, 37 AND 42), (U.S. CLS. 21, 23, 26, 36, 38, 100, 101, 103 AND 106). SN 76-162,245. PUB. 2-26-2002. FILED 11-6-2000.
- 2,571,106. **SOLUTIONS FOR THE HEALTH OF HEALTH-CARE. AMERICAN MANAGEMENT SYSTEMS**, (U.S. CLS. 21, 23, 26, 36 AND 38). SN 76-165,264. PUB. 2-26-2002. FILED 11-13-2000.
- 2,571,111. **GEOMAGIC SHAPE. RAINDROP GEOMAGIC, INC.**, (U.S. CLS. 21, 23, 26, 36 AND 38). SN 76-165,924. PUB. 2-26-2002. FILED 11-14-2000.
- 2,571,114. **EMERSA * PLUS. PRT SOFTWARE, INC.**, (U.S. CLS. 21, 23, 26, 36 AND 38). SN 76-166,595. PUB. 2-26-2002. FILED 11-16-2000.
- 2,571,115. **THE STATE BAR OF CALIFORNIA. STATE BAR OF CALIFORNIA, THE**, (U.S. CLS. 21, 23, 26, 36 AND 38). SN 76-166,599. PUB. 2-26-2002. FILED 11-15-2000.
- 2,571,116. **SPEEDSCAN 3D. PPT VISION, INC.**, (U.S. CLS. 21, 23, 26, 36 AND 38). SN 76-166,726. PUB. 2-26-2002. FILED 11-16-2000.
- 2,571,128. **YOGA CLOCK AND MEDITATION TIMER BECAUSE THERE'S NO TIME LIKE THE PRESENT. NOW AND ZEN, INC.**, (U.S. CLS. 21, 23, 26, 36 AND 38). SN 76-169,680. PUB. 2-26-2002. FILED 11-22-2000.
- 2,571,129. **ROUNDCAST. EGS, INC.**, (U.S. CLS. 21, 23, 26, 36 AND 38). SN 76-169,747. PUB. 2-26-2002. FILED 11-21-2000.
- 2,571,130. **COGENTRIC. COGENTRIC, INC.**, MULTIPLE CLASS, (INT. CLS. 9 AND 42), (U.S. CLS. 21, 23, 26, 36, 38, 100 AND 101). SN 76-170,084. PUB. 8-14-2001. FILED 11-22-2000.
- 2,571,137. **FOCALITE. VISION-EASE LENS, INC.**, (U.S. CLS. 21, 23, 26, 36 AND 38). SN 76-172,205. PUB. 2-26-2002. FILED 11-28-2000.
- 2,571,138. **ABA AND DESIGN. ABA, INC.**, (U.S. CLS. 21, 23, 26, 36 AND 38). SN 76-172,641. PUB. 2-26-2002. FILED 11-29-2000.
- 2,571,140. **EPAYEASE AND DESIGN. SEMTEK INNOVATION SOLUTIONS, INC.**, (U.S. CLS. 21, 23, 26, 36 AND 38). SN 76-174,935. PUB. 9-18-2001. FILED 12-4-2000.
- 2,571,141. **GEOMAGIC DECIMATE. RAINDROP GEOMAGIC, INC.**, (U.S. CLS. 21, 23, 26, 36 AND 38). SN 76-174,951. PUB. 2-26-2002. FILED 12-1-2000.
- 2,571,146. **WINRAP. BHA GROUP HOLDINGS, INC.**, (U.S.

- CLS. 21, 23, 26, 36 AND 38). SN 76-176,810. PUB. 2-26-2002. FILED 12-7-2000.
- 2,571,150. **ACADEMIC SYSTEMS A AND DESIGN. LIGHTSPAN, INC.**, MULTIPLE CLASS, (INT. CLS. 9 AND 16), (U.S. CLS. 2, 5, 21, 22, 23, 26, 29, 36, 37, 38 AND 50). SN 76-178,613. PUB. 2-26-2002. FILED 12-7-2000.
- 2,571,152. **ACADEMIC SYSTEMS. LIGHTSPAN, INC.**, MULTIPLE CLASS, (INT. CLS. 9 AND 16), (U.S. CLS. 2, 5, 21, 22, 23, 26, 29, 36, 37, 38 AND 50). SN 76-179,314. PUB. 2-26-2002. FILED 12-7-2000.
- 2,571,155. **ANADIGMDESIGNER. ANADIGM LTD.**, (U.S. CLS. 21, 23, 26, 36 AND 38). SN 76-180,173. PUB. 2-26-2002. FILED 12-13-2000.
- 2,571,161. **TOUCH 'N TRACK. BACOU USA SAFETY, INC.**, (U.S. CLS. 21, 23, 26, 36 AND 38). SN 76-186,110. PUB. 2-26-2002. FILED 12-26-2000.
- 2,571,175. **MESSAGE IN A MELODY. BARNES, RUTH**, (U.S. CLS. 21, 23, 26, 36 AND 38). SN 76-196,537. PUB. 2-26-2002. FILED 1-16-2001.
- 2,571,177. **LEAP FROG LEARNING POND. LEAPFROG ENTERPRISES, INC.**, BY CHANGE OF NAME KNOWLEDGE KIDS ENTERPRISES, INC., DBA LEAPFROG, (U.S. CLS. 21, 23, 26, 36 AND 38). SN 76-197,255. PUB. 2-26-2002. FILED 1-19-2001.
- 2,571,178. **STRAIGHT A. ROLAND MEINL MUSIKINSTRUMENTE GMBH & CO.**, (U.S. CLS. 21, 23, 26, 36 AND 38). SN 76-197,675. PUB. 2-26-2002. FILED 1-22-2001.
- 2,571,185. **NUTRIGOAL (STYLIZED). VATTIER, CLAUDE**, (U.S. CLS. 21, 23, 26, 36 AND 38). SN 76-208,994. PUB. 2-26-2002. FILED 2-12-2001.
- 2,571,190. **IREPORTS. ECCOUNTING SOLUTIONS, LLC**, (U.S. CLS. 21, 23, 26, 36 AND 38). SN 76-210,903. PUB. 10-9-2001. FILED 2-16-2001.
- 2,571,196. **LECTORA. TRIVANTIS CORPORATION**, (U.S. CLS. 21, 23, 26, 36 AND 38). SN 76-214,989. PUB. 2-26-2002. FILED 2-26-2001.
- 2,571,214. **THE BRAND THAT DELIVERS THE ACTION. CONWEST RESOURCES INC.**, (U.S. CLS. 21, 23, 26, 36 AND 38). SN 76-223,375. PUB. 2-26-2002. FILED 3-12-2001.
- 2,571,230. **TERATOMA. HARRISON, HOWARD W.**, MULTIPLE CLASS, (INT. CLS. 9 AND 41), (U.S. CLS. 21, 23, 26, 36, 38, 100, 101 AND 107). SN 76-227,397. PUB. 2-26-2002. FILED 3-20-2001.
- 2,571,239. **MII. TELTRON TECHNOLOGIES, INC.**, (U.S. CLS. 21, 23, 26, 36 AND 38). SN 76-233,681. PUB. 2-26-2002. FILED 3-30-2001.
- 2,571,254. **ROCKETCHIPS AND DESIGN. XILINX, INC.**, (U.S. CLS. 21, 23, 26, 36 AND 38). SN 76-241,328. PUB. 2-26-2002. FILED 4-16-2001.
- 2,571,262. **BEAMDIAL. AVITAN, ASHER**, (U.S. CLS. 21, 23, 26, 36 AND 38). SN 76-243,607. PUB. 2-26-2002. FILED 4-19-2001.
- 2,571,267. **"THE EXERCISES YOU CAN DO FOR LIFE". ARTHRITISIZE, INC.**, (U.S. CLS. 21, 23, 26, 36 AND 38). SN 76-245,115. PUB. 2-26-2002. FILED 4-24-2001.
- 2,571,273. **LIVING DAYLIGHT. LIVING DAYLIGHT DISPLAYS, LLC**, (U.S. CLS. 21, 23, 26, 36 AND 38). SN 76-247,988. PUB. 2-26-2002. FILED 4-30-2001.
- 2,571,285. **ALIEN ANT FARM. ALIEN ANT FARM**, MULTIPLE CLASS, (INT. CLS. 9, 25 AND 41), (U.S. CLS. 21, 22, 23, 26, 36, 38, 39, 100, 101 AND 107). SN 76-253,215. PUB. 2-26-2002. FILED 5-8-2001.
- 2,571,287. **RENU. BAUSCH & LOMB INCORPORATED**, (U.S. CLS. 21, 23, 26, 36 AND 38). SN 76-254,317. PUB. 2-26-2002. FILED 5-7-2001.
- 2,571,337. **QB QUICKBLOCKS AND DESIGN. CORPORATION 2000, INC.**, (U.S. CLS. 21, 23, 26, 36 AND 38). SN 76-275,570. PUB. 2-26-2002. FILED 6-25-2001.
- 2,571,349. **PHOENIX CLINICAL DOCUMENTATION SYSTEM. ADVENTIST HEALTH SYSTEM/WEST. DBA ADVENTIST HEALTH**, (U.S. CLS. 21, 23, 26, 36 AND 38). SN 76-281,296. PUB. 2-26-2002. FILED 7-6-2001.
- 2,571,366. **VTOC. ADDCO, INC.**, (U.S. CLS. 21, 23, 26, 36 AND 38). SN 76-286,478. PUB. 2-26-2002. FILED 7-17-2001.
- 2,571,372. **LARNELL STARKEY & THE SPIRITUAL SEVEN GOSPEL SINGERS. ALEXANDER, DARLEDIA**, (U.S. CLS. 21, 23, 26, 36 AND 38). SN 76-290,479. PUB. 2-26-2002. FILED 7-26-2001.
- 2,571,376. **CS (STYLIZED). CONCEPT SYSTEMS INC.**, (U.S. CLS. 21, 23, 26, 36 AND 38). SN 76-292,253. PUB. 2-26-2002. FILED 7-31-2001.
- 2,571,424. **PHARMMED. CARECENTRIC NATIONAL, LLC**, (U.S. CLS. 21, 23, 26, 36 AND 38). SN 76-313,209. PUB. 2-26-2002. FILED 9-17-2001.
- 2,571,427. **WOLFPPOWER. UNIWELD PRODUCTS, INC.**, (U.S. CLS. 21, 23, 26, 36 AND 38). SN 76-313,664. PUB. 2-26-2002. FILED 9-17-2001.
- 2,571,430. **BORDERGUARD. IMAGING AUTOMATION, INC.**, (U.S. CLS. 21, 23, 26, 36 AND 38). SN 76-314,045. PUB. 2-26-2002. FILED 9-18-2001.
- 2,571,444. **CONVERTABLE. PEL-FREEZ CLINICAL SYSTEMS, LLC**, (U.S. CLS. 21, 23, 26, 36 AND 38). SN 76-316,533. PUB. 2-26-2002. FILED 9-25-2001.
- 2,571,448. **STERLING. SCHALOW, ROLAND WAYNE, DBA MICHIGAN FIRST RESPONSE**, MULTIPLE CLASS, (INT. CLS. 9 AND 12), (U.S. CLS. 19, 21, 23, 26, 31, 35, 36, 38 AND 44). SN 76-317,912. PUB. 2-26-2002. FILED 9-28-2001.
- 2,571,449. **VMP. TENSOLITE-CDI, INC.**, (U.S. CLS. 21, 23, 26, 36 AND 38). SN 76-318,128. PUB. 2-26-2002. FILED 9-28-2001.
- 2,571,450. **CYCLOMATIC. ILLINOIS TOOL WORKS INC.**, (U.S. CLS. 21, 23, 26, 36 AND 38). SN 76-318,323. PUB. 2-26-2002. FILED 9-27-2001.
- 2,571,453. **INSERTERVISION. VIDEK, INC.**, (U.S. CLS. 21, 23, 26, 36 AND 38). SN 76-319,410. PUB. 2-26-2002. FILED 10-1-2001.
- 2,571,454. **TEMP-TIME. SPRINGFIELD PRECISION INSTRUMENTS, INC.**, (U.S. CLS. 21, 23, 26, 36 AND 38). SN 76-319,520. PUB. 2-26-2002. FILED 10-1-2001.
- 2,571,462. **GENEPIX. AXON INSTRUMENTS, INC.**, (U.S. CLS. 21, 23, 26, 36 AND 38). SN 76-320,326. PUB. 2-26-2002. FILED 10-1-2001.
- 2,571,463. **MAXSCAN AND DESIGN. MAXSCAN INC.**, (U.S. CLS. 21, 23, 26, 36 AND 38). SN 76-320,528. PUB. 2-26-2002. FILED 10-2-2001.
- 2,571,479. **AEROTECH 6. AEROTECH LABORATORIES, INC.**, (U.S. CLS. 21, 23, 26, 36 AND 38). SN 76-324,986. PUB. 2-26-2002. FILED 10-15-2001.
- 2,571,512. **BAL. BREATHE AMERICA, INC.**, (U.S. CLS. 21, 23, 26, 36 AND 38). SN 78-027,878. PUB. 2-26-2002. FILED 9-27-2000.
- 2,571,516. **PEGAREACH. PEGASYSTEMS INC.**, (U.S. CLS. 21, 23, 26, 36 AND 38). SN 78-029,030. PUB. 2-26-2002. FILED 10-4-2000.
- 2,571,528. **CHRYSIZON. STUMP, ROBERT FRANK**, (U.S. CLS. 21, 23, 26, 36 AND 38). SN 78-032,847. PUB. 2-26-2002. FILED 10-29-2000.
- 2,571,533. **MISCELLANEOUS DESIGN. LATTICE COMMUNICATIONS, LLC**, MULTIPLE CLASS, (INT. CLS. 9, 37 AND 38), (U.S. CLS. 21, 23, 26, 36, 38, 100, 101, 103, 104 AND 106). SN 78-034,954. PUB. 2-26-2002. FILED 11-13-2000.
- 2,571,548. **INTUSOFT AND DESIGN. MEARES, LISE**, (U.S. CLS. 21, 23, 26, 36 AND 38). SN 78-037,071. PUB. 2-26-2002. FILED 11-29-2000.
- 2,571,551. **SWFX. WILDFORM, INC.**, (U.S. CLS. 21, 23, 26, 36 AND 38). SN 78-038,128. PUB. 2-26-2002. FILED 12-6-2000.
- 2,571,552. **AQUA LATCH NETWORK. LINJAN, CORP.**, (U.S. CLS. 21, 23, 26, 36 AND 38). SN 78-038,208. PUB. 2-26-2002. FILED 12-7-2000.
- 2,571,553. **NYFIX. NYFIX, INC.**, (U.S. CLS. 21, 23, 26, 36 AND 38). SN 78-038,270. PUB. 2-26-2002. FILED 12-7-2000.
- 2,571,556. **PERSONAL SERVANT. EYE STATE INC**, (U.S. CLS. 21, 23, 26, 36 AND 38). SN 78-039,472. PUB. 2-26-2002. FILED 12-15-2000.
- 2,571,561. **BEARSHARE THE POWER TO SHARE AND DESIGN. FREE PEERS, INC.**, (U.S. CLS. 21, 23, 26, 36 AND 38). SN 78-040,588. PUB. 2-26-2002. FILED 12-26-2000.
- 2,571,566. **LPB AND DESIGN. LPB COMMUNICATIONS, INC.**, (U.S. CLS. 21, 23, 26, 36 AND 38). SN 78-042,951. PUB. 2-26-2002. FILED 1-12-2001.
- 2,571,586. **VISUAL PACKRAT PLUS. SPECTRUM SOFTWARE, INC.**, (U.S. CLS. 21, 23, 26, 36 AND 38). SN 78-049,228. PUB. 2-26-2002. FILED 2-20-2001.
- 2,571,589. **THERMVIEW. MRK INDUSTRIES LLC.**, (U.S. CLS. 21, 23, 26, 36 AND 38). SN 78-049,811. PUB. 2-26-2002. FILED 2-22-2001.
- 2,571,590. **LOGGER 100. MRK INDUSTRIES LLC.**, (U.S. CLS. 21, 23, 26, 36 AND 38). SN 78-049,815. PUB. 2-26-2002. FILED

- 2-22-2001.
 2,571,603. **ASTORM**. ABB AUTOMATION INC., (U.S. CLS. 21, 23, 26, 36 AND 38). SN 78-054,669. PUB. 10-2-2001. FILED 3-23-2001.
 2,571,623. **LIMIT ALERT**. PROCESS AUTOMATION INC., (U.S. CLS. 21, 23, 26, 36 AND 38). SN 78-061,306. PUB. 2-26-2002. FILED 5-1-2001.
 2,571,625. **INTELLISWIM**. SCHMIDT, CRAIG A., DBA KARRIER COMMUNICATIONS, (U.S. CLS. 21, 23, 26, 36 AND 38). SN 78-062,759. PUB. 2-26-2002. FILED 5-9-2001.
 2,571,626. **EVENT CENTRAL AND DESIGN**. KALEIDOSCOPE SPORTS & ENTERTAINMENT L.L.C., (U.S. CLS. 21, 23, 26, 36 AND 38). SN 78-063,458. PUB. 2-26-2002. FILED 5-14-2001.
 2,571,634. **UCALL 32**. UNIQUE COMMUNICATIONS OF DENVER, INC., (U.S. CLS. 21, 23, 26, 36 AND 38). SN 78-068,650. PUB. 2-26-2002. FILED 6-12-2001.
 2,571,639. **VX SHAPING THE FUTURE OF CAD/CAM**. VARIMETRIX CORPORATION, (U.S. CLS. 21, 23, 26, 36 AND 38). SN 78-070,811. PUB. 2-26-2002. FILED 6-25-2001.
 2,571,642. **SPISI**. SPIROX SYSTEMS CORPORATION, (U.S. CLS. 21, 23, 26, 36 AND 38). SN 78-071,608. PUB. 2-26-2002. FILED 6-29-2001.
 2,571,646. **ZEMETER AND DESIGN**. SUPPLY CHAIN CONSULTANTS, INC., (U.S. CLS. 21, 23, 26, 36 AND 38). SN 78-072,236. PUB. 2-26-2002. FILED 7-3-2001.
 2,571,654. **POCKETPYRO AND DESIGN**. POCKETPYRO, INC., (U.S. CLS. 21, 23, 26, 36 AND 38). SN 78-074,155. PUB. 2-26-2002. FILED 7-16-2001.
 2,571,672. **AZERITY**. AZERITY, MULTIPLE CLASS, (INT. CLS. 9 AND 35), (U.S. CLS. 21, 23, 26, 36, 38, 100, 101 AND 102). SN 78-081,971. PUB. 2-26-2002. FILED 8-30-2001.
 2,571,677. **BULLSEYE**. APACHE TECHNOLOGIES, INC., (U.S. CLS. 21, 23, 26, 36 AND 38). SN 78-084,470. PUB. 2-26-2002. FILED 9-19-2001.
 2,571,678. **MUSENKI**. MUSENKI, INC., (U.S. CLS. 21, 23, 26, 36 AND 38). SN 78-084,918. PUB. 2-26-2002. FILED 9-21-2001.
 2,571,682. **MISCELLANEOUS DESIGN**. HEADLIGHT SOFTWARE, INC., (U.S. CLS. 21, 23, 26, 36 AND 38). SN 78-086,225. PUB. 2-26-2002. FILED 9-29-2001.
 2,571,686. **AUTOSCALE**. AUTOMATION SERVICES, INC., (U.S. CLS. 21, 23, 26, 36 AND 38). SN 78-087,712. PUB. 2-26-2002. FILED 10-10-2001.

CLASS 10—MEDICAL APPARATUS

- 2,570,480. **FREEDOM**. FRESSENIUS USA, INC., (U.S. CL. 26). SN 74-454,812. PUB. 2-26-2002. FILED 11-1-1993.
 2,570,492. **VACUMOTION**. KONINKLIJKE PHILIPS ELECTRONICS N.V., BY CHANGE OF NAME PHILIPS ELECTRONICS N.V., (U.S. CLS. 26, 39 AND 44). SN 75-217,217. PUB. 5-5-1998. FILED 12-17-1996.
 2,570,495. **ZOOMTECH**. PHONAK HOLDING AG, (U.S. CLS. 26, 39 AND 44). SN 75-258,858. PUB. 9-25-2001. FILED 3-13-1997.
 2,570,496. **ORIGINALZOOM**. PHONAK HOLDING AG, (U.S. CLS. 26, 39 AND 44). SN 75-258,878. PUB. 8-28-2001. FILED 3-13-1997.
 2,570,497. **MICROZOOM**. PHONAK HOLDING AG, (U.S. CLS. 26, 39 AND 44). SN 75-258,879. PUB. 8-28-2001. FILED 3-13-1997.
 2,570,498. **SUPERZOOM**. PHONAK HOLDING AG, (U.S. CLS. 26, 39 AND 44). SN 75-258,882. PUB. 8-14-2001. FILED 3-13-1997.
 2,570,499. **HANDYZOOM**. PHONAK HOLDING AG, (U.S. CLS. 26, 39 AND 44). SN 75-258,883. PUB. 8-28-2001. FILED 3-13-1997.
 2,570,511 (*See Class 9 for this trademark*).
 2,570,576. **TINNEX AND DESIGN**. TINNITRONICS HANDLES - UND VERTRIEBSGMBH, MULTIPLE CLASS, (INT. CLS. 10, 16 AND 41), (U.S. CLS. 2, 5, 22, 23, 26, 29, 37, 38, 39, 44, 50, 100, 101 AND 107). SN 75-629,416. PUB. 11-27-2001. FILED 1-28-1999.
 2,570,590. **DELSYS AND DESIGN**. DELSYS INCORPORATED, (U.S. CLS. 26, 39 AND 44). SN 75-674,598. PUB. 5-8-2001. FILED 4-5-1999.
 2,570,645. **SENSIT (STYLIZED)**. KALTENBACH & VOIGT

- GMBH & CO., MULTIPLE CLASS, (INT. CLS. 10 AND 20), (U.S. CLS. 2, 13, 22, 25, 26, 32, 39, 44 AND 50). SN 75-796,833. PUB. 2-26-2002. FILED 9-10-1999.
 2,570,675. **AVA 3XL**. EDWARDS LIFESCIENCES CORPORATION, BY ASSIGNMENT BAXTER INTERNATIONAL INC., (U.S. CLS. 26, 39 AND 44). SN 75-848,868. PUB. 9-4-2001. FILED 11-15-1999.
 2,570,791. **WAVEPRINT AND DESIGN**. VISX, INCORPORATED, (U.S. CLS. 26, 39 AND 44). SN 76-028,733. PUB. 11-6-2001. FILED 4-18-2000.
 2,570,833. **AUTOVPAP**. RESMED LIMITED, (U.S. CLS. 26, 39 AND 44). SN 76-058,584. PUB. 12-4-2001. FILED 5-30-2000.
 2,570,962. **JOGRAPHY**. JOMED GMBH, (U.S. CLS. 26, 39 AND 44). SN 76-111,794. PUB. 2-26-2002. FILED 8-17-2000.
 2,571,092. **MED-LOGICS**. MED-LOGICS, INC., (U.S. CLS. 26, 39 AND 44). SN 76-158,964. PUB. 2-26-2002. FILED 11-3-2000.
 2,571,142. **IONTO PATCH (STYLIZED)**. BIRCH POINT MEDICAL, INC., (U.S. CLS. 26, 39 AND 44). SN 76-175,432. PUB. 2-26-2002. FILED 12-5-2000.
 2,571,386. **V-BRACE**. FEMBRACE, INC., (U.S. CLS. 26, 39 AND 44). SN 76-300,928. PUB. 2-26-2002. FILED 8-17-2001.
 2,571,469. **FINALLY WHITE**. TACTICA INTERNATIONAL, INC., (U.S. CLS. 26, 39 AND 44). SN 76-322,312. PUB. 2-26-2002. FILED 10-9-2001.
 2,571,534. **DUAL DENSITY**. VAST RESOURCES, INC., DBA TOPCO SALES, (U.S. CLS. 26, 39 AND 44). SN 78-034,991. PUB. 2-26-2002. FILED 11-13-2000.
 2,571,535. **DIAL-A-PLEASURE**. VAST RESOURCES, INC., DBA TOPCO SALES, (U.S. CLS. 26, 39 AND 44). SN 78-035,083. PUB. 2-26-2002. FILED 11-13-2000.

CLASS 11—ENVIRONMENTAL CONTROL APPARATUS

- 2,570,528 (*See Class 9 for this trademark*).
 2,570,562 (*See Class 4 for this trademark*).
 2,570,632. **HYDROPAC**. S.D.L. TECHNOLOGIES (SOL) LTD., (U.S. CLS. 13, 21, 23, 31 AND 34). SN 75-776,652. PUB. 1-16-2001. FILED 8-16-1999.
 2,570,635. **BALEEN**. BALEEN FILTERS PTY LIMITED, (U.S. CLS. 13, 21, 23, 31 AND 34). SN 75-778,751. PUB. 10-24-2000. FILED 8-17-1999.
 2,570,666. **QUICKLINK**. ALOHA HOUSEWARES, INC., (U.S. CLS. 13, 21, 23, 31 AND 34). SN 75-827,702. PUB. 11-6-2001. FILED 10-20-1999.
 2,570,681 (*See Class 7 for this trademark*).
 2,570,709 (*See Class 9 for this trademark*).
 2,570,736. **PARADISO**. TAMA PLASTIC INDUSTRY, MULTIPLE CLASS, (INT. CLS. 11 AND 21), (U.S. CLS. 2, 13, 21, 23, 29, 30, 31, 33, 34, 40 AND 50). SN 75-931,816. PUB. 7-24-2001. FILED 2-24-2000.
 2,570,800. **MINIBRITE**. LYTE OPTRONICS, INC., (U.S. CLS. 13, 21, 23, 31 AND 34). SN 76-036,691. PUB. 2-26-2002. FILED 4-27-2000.
 2,570,875. **QUANTUM 2000**. BENNETT, BRAD, (U.S. CLS. 13, 21, 23, 31 AND 34). SN 76-078,146. PUB. 2-26-2002. FILED 6-26-2000.
 2,570,885. **POLYDEPTH**. PLYMOUTH PRODUCTS, INC., (U.S. CLS. 13, 21, 23, 31 AND 34). SN 76-080,403. PUB. 9-18-2001. FILED 6-29-2000.
 2,570,897. **CANTALUPI**. CANTALUPI S.R.L., (U.S. CLS. 13, 21, 23, 31 AND 34). SN 76-083,289. PUB. 4-10-2001. FILED 7-5-2000.
 2,570,954 (*See Class 3 for this trademark*).
 2,571,233. **6000 SERIES**. DELFIELD COMPANY, THE, (U.S. CLS. 13, 21, 23, 31 AND 34). SN 76-231,423. PUB. 2-26-2002. FILED 3-23-2001.
 2,571,355. **HYDRAQUEST**. ALAMO WATER REFINERS, INC., (U.S. CLS. 13, 21, 23, 31 AND 34). SN 76-282,567. PUB. 2-26-2002. FILED 7-9-2001.
 2,571,400. **OZONE FRESH**. NATURE'S SUNSHINE PRODUCTS, INC., (U.S. CLS. 13, 21, 23, 31 AND 34). SN 76-308,222. PUB. 2-26-2002. FILED 8-31-2001.
 2,571,523. **SUPER-Q**. MILLIPORE CORPORATION, (U.S. CLS. 13, 21, 23, 31 AND 34). SN 78-031,407. PUB. 2-26-2002. FILED 10-19-2000.

2,571,565. **SIGNATURE 2000.** STA-RITE INDUSTRIES, INC., (U.S. CLS. 13, 21, 23, 31 AND 34). SN 78-042,670. PUB. 10-2-2001. FILED 1-10-2001.

CLASS 12—VEHICLES

2,570,562 (*See Class 4 for this trademark.*)
 2,570,566 (*See Class 6 for this trademark.*)
 2,570,567 (*See Class 6 for this trademark.*)
 2,570,568 (*See Class 6 for this trademark.*)
 2,570,569 (*See Class 6 for this trademark.*)
 2,570,570 (*See Class 6 for this trademark.*)
 2,570,691. **CONCEPT D. VOLKSWAGEN AKTIENGESELLSCHAFT,** MULTIPLE CLASS, (INT. CLS. 12, 28 AND 37), (U.S. CLS. 19, 21, 22, 23, 31, 35, 38, 44, 50, 100, 103 AND 106). SN 75-872,476. PUB. 2-26-2002. FILED 12-16-1999.
 2,571,099. **BLOWER BUGGY AND DESIGN.** GOODES, JAMES, (U.S. CLS. 19, 21, 23, 31, 35 AND 44). SN 76-160,476. PUB. 7-3-2001. FILED 11-6-2000.
 2,571,183. **X MINE.** MICHELIN NORTH AMERICA, INC., (U.S. CLS. 19, 21, 23, 31, 35 AND 44). SN 76-207,043. PUB. 8-14-2001. FILED 2-8-2001.
 2,571,209. **TERRA COTTA TAXI.** MCCONNELL, TYRON J., (U.S. CLS. 19, 21, 23, 31, 35 AND 44). SN 76-221,908. PUB. 2-26-2002. FILED 3-9-2001.
 2,571,296. **ALL TERRAIN AND DESIGN.** RADIO FLYER INC., (U.S. CLS. 19, 21, 23, 31, 35 AND 44). SN 76-260,748. PUB. 2-26-2002. FILED 5-22-2001.
 2,571,448 (*See Class 9 for this trademark.*)
 2,571,505. **HYPERBLADES AND DESIGN.** CLEARCO PRODUCT LIMITED, (U.S. CLS. 19, 21, 23, 31, 35 AND 44). SN 78-025,822. PUB. 2-26-2002. FILED 9-14-2000.
 2,571,520. **SNOPRO AND DESIGN.** C & C DISTRIBUTORS, INC., MULTIPLE CLASS, (INT. CLS. 12 AND 19), (U.S. CLS. 1, 12, 19, 21, 23, 31, 33, 35, 44 AND 50). SN 78-030,542. PUB. 2-26-2002. FILED 10-13-2000.
 2,571,593. **REVIVAL.** HT USA, INC., (U.S. CLS. 19, 21, 23, 31, 35 AND 44). SN 78-050,063. PUB. 2-26-2002. FILED 2-23-2001.
 2,571,627. **ORION.** DAYCO PRODUCTS, LLC, (U.S. CLS. 19, 21, 23, 31, 35 AND 44). SN 78-064,082. PUB. 2-26-2002. FILED 5-17-2001.

CLASS 13—FIREARMS

2,570,876. **LEVY'S LEATHERS LIMITED AND DESIGN.** LEVY'S LEATHERS LIMITED, MULTIPLE CLASS, (INT. CLS. 13 AND 15), (U.S. CLS. 2, 9, 21 AND 36). SN 76-078,267. PUB. 2-26-2002. FILED 6-27-2000.

CLASS 14—JEWELRY

2,570,490 (*See Class 3 for this trademark.*)
 2,570,541. **TRUE LOVE WAITS.** LIFEWAY CHRISTIAN RESOURCES OF THE SOUTHERN BAPTIST CONVENTION, BY CHANGE OF NAME SUNDAY SCHOOL BOARD, THE, (U.S. CLS. 2, 27, 28 AND 50). SN 75-519,104. PUB. 2-26-2002. FILED 7-15-1998.
 2,570,619. **GELEE BY ALUMA.** ALUMA USA INC., (U.S. CLS. 2, 27, 28 AND 50). SN 75-753,104. PUB. 2-26-2002. FILED 7-16-1999.
 2,570,817. **HUSH-A-BYES.** COLOR MERCHANTS, INC., (U.S. CLS. 2, 27, 28 AND 50). SN 76-051,201. PUB. 2-26-2002. FILED 5-19-2000.
 2,570,841. **AB AND DESIGN.** ABSOLUTE BRILLIANCE, INC., (U.S. CLS. 2, 27, 28 AND 50). SN 76-061,801. PUB. 2-26-2002. FILED 6-2-2000.
 2,570,948. **HUBERT AND DESIGN.** GESSER, HUBERT PINHEIRO, (U.S. CLS. 2, 27, 28 AND 50). SN 76-104,324. PUB. 2-26-2002. FILED 8-7-2000.
 2,570,968. **MIKE MULLIGAN AND HIS STEAM SHOVEL.**

HOUGHTON MIFFLIN COMPANY, (U.S. CLS. 2, 27, 28 AND 50). SN 76-115,022. PUB. 2-26-2002. FILED 8-23-2000.
 2,571,028. **XYBER.** XYBERNAUT CORPORATION, MULTIPLE CLASS, (INT. CLS. 14 AND 25), (U.S. CLS. 2, 22, 27, 28, 39 AND 50). SN 76-131,620. PUB. 2-26-2002. FILED 9-20-2000.
 2,571,044. **SIGNATURE COLLECTION.** UNITED SERVICES AUTOMOBILE ASSOCIATION, (U.S. CLS. 2, 27, 28 AND 50). SN 76-136,302. PUB. 2-26-2002. FILED 9-27-2000.
 2,571,108. **OF (STYLIZED).** OLD FLORENCE S.R.L., (U.S. CLS. 2, 27, 28 AND 50). SN 76-165,824. PUB. 2-26-2002. FILED 11-14-2000.
 2,571,182. **PUPPY PAWS.** PUPPY PAWS, INC., MULTIPLE CLASS, (INT. CLS. 14 AND 28), (U.S. CLS. 2, 22, 23, 27, 28, 38 AND 50). SN 76-206,738. PUB. 9-4-2001. FILED 2-8-2001.
 2,571,194. **BIRCH TREE STUDIO.** BIRCH TREE STUDIO, LLC, (U.S. CLS. 2, 27, 28 AND 50). SN 76-213,783. PUB. 2-26-2002. FILED 2-20-2001.
 2,571,284. **MISHKA AND DESIGN.** QUINN ENTERPRISES, INC., (U.S. CLS. 2, 27, 28 AND 50). SN 76-253,189. PUB. 2-26-2002. FILED 5-8-2001.
 2,571,323. **THE LINEAGE DIAMOND.** ZALE DELAWARE, INC., (U.S. CLS. 2, 27, 28 AND 50). SN 76-269,604. PUB. 2-26-2002. FILED 6-8-2001.
 2,571,422. **DIRACHI.** DIRACHI, INC., (U.S. CLS. 2, 27, 28 AND 50). SN 76-313,053. PUB. 2-26-2002. FILED 9-18-2001.
 2,571,457. **B JEWELRY BY PEDRO BOREGAARD (STYLIZED).** BOREGAARD, PEDRO, (U.S. CLS. 2, 27, 28 AND 50). SN 76-319,731. PUB. 2-26-2002. FILED 10-2-2001.
 2,571,461. **YM.** GRUNER + JAHR PRINTING & PUBLISHING CO., (U.S. CLS. 2, 27, 28 AND 50). SN 76-320,253. PUB. 2-26-2002. FILED 10-1-2001.
 2,571,471. **MISCELLANEOUS DESIGN.** PAUL FRANK INDUSTRIES, INC., (U.S. CLS. 2, 27, 28 AND 50). SN 76-322,346. PUB. 2-26-2002. FILED 10-10-2001.
 2,571,488. **PILGRIM.** MARKVAD, PILGRIM V/ANNE-METTE, MULTIPLE CLASS, (INT. CLS. 14 AND 26), (U.S. CLS. 2, 27, 28, 37, 39, 40, 42 AND 50). SN 76-326,757. PUB. 2-26-2002. FILED 10-18-2001.
 2,571,495. **E-WEDDINGBANDS.COM AND DESIGN.** GOLDESIGN L.L.C., (U.S. CLS. 2, 27, 28 AND 50). SN 78-016,826. PUB. 2-26-2002. FILED 7-14-2000.
 2,571,616. **MISCELLANEOUS DESIGN.** PROFESSIONAL GOLFERS' ASSOCIATION OF AMERICA, THE, (U.S. CLS. 2, 27, 28 AND 50). SN 78-056,775. PUB. 2-26-2002. FILED 4-4-2001.
 2,571,641. **ENDANGERED LITTLE ONES PEWTER BEAD COLLECTION AND DESIGN.** COUSIN CORPORATION OF AMERICA, (U.S. CLS. 2, 27, 28 AND 50). SN 78-071,299. PUB. 2-26-2002. FILED 6-27-2001.

CLASS 15—MUSICAL INSTRUMENTS

2,570,599. **MYCHIME.** MUSIC FOR YOUNG CHILDREN BY FRANCES BALODIS LTD., MULTIPLE CLASS, (INT. CLS. 15, 28 AND 41), (U.S. CLS. 2, 21, 22, 23, 36, 38, 50, 100, 101 AND 107). SN 75-697,166. PUB. 3-13-2001. FILED 5-4-1999.
 2,570,653. **HENRI SELMER PARIS AND DESIGN.** SELMER COMPANY, INC., THE, (U.S. CLS. 2, 21 AND 36). SN 75-814,034. PUB. 9-11-2001. FILED 10-4-1999.
 2,570,876 (*See Class 13 for this trademark.*)
 2,570,938. **AMUN.** ROLAND MEINL MUSIKINSTRUMENTE GMBH & CO., (U.S. CLS. 2, 21 AND 36). SN 76-101,110. PUB. 2-26-2002. FILED 8-2-2000.
 2,571,353. **TRICK STIX.** SIMBA ENTERTAINMENT, LLC, (U.S. CLS. 2, 21 AND 36). SN 76-282,554. PUB. 2-26-2002. FILED 7-9-2001.
 2,571,361. **REGENCY BY LEBLANC.** G. LEBLANC CORPORATION, (U.S. CLS. 2, 21 AND 36). SN 76-284,573. PUB. 2-26-2002. FILED 7-16-2001.
 2,571,441. **PINEHURST.** PINEHURST, INC., (U.S. CLS. 2, 21 AND 36). SN 76-316,173. PUB. 2-26-2002. FILED 9-24-2001.
 2,571,474. **DYNATIP AND DESIGN.** TAY-E CO., LTD., (U.S. CLS. 2, 21 AND 36). SN 76-323,672. PUB. 2-26-2002. FILED 10-10-2001.

CLASS 16—PAPER GOODS AND PRINTED MATTER

- 2,570,481. **HMA REMEDY**. HEALTHCARE MANAGEMENT ADVISORS, INC., (U.S. CL. 38). SN 74-542,378. PUB. 2-26-2002. FILED 6-27-1994.
- 2,570,482. **HMA PROFIT**. HEALTHCARE MANAGEMENT ADVISORS, INC., (U.S. CL. 38). SN 74-542,523. PUB. 2-26-2002. FILED 6-27-1994.
- 2,570,490 (*See Class 3 for this trademark*).
- 2,570,503. **WILDEATS ENTERPRISES (STYLIZED)**. MCGANNON, JOHN, DBA WILDEATS ENTERPRISES, (U.S. CLS. 2, 5, 22, 23, 29, 37, 38 AND 50). SN 75-307,774. PUB. 10-6-1998. FILED 6-12-1997.
- 2,570,512. **SAFECARD**. SAFETEL, INC., (U.S. CLS. 2, 5, 22, 23, 29, 37, 38 AND 50). SN 75-372,196. PUB. 2-26-2002. FILED 10-14-1997.
- 2,570,561. **DAUGHTERS**. PLEASANT COMPANY, BY ASSIGNMENT; BY ASSIGNMENT HOOS COMMUNICATIONS, INC., (U.S. CLS. 2, 5, 22, 23, 29, 37, 38 AND 50). SN 75-603,730. PUB. 2-26-2002. FILED 12-11-1998.
- 2,570,576 (*See Class 10 for this trademark*).
- 2,570,591. **THE PARENTING JOURNEY**. FAMILY CENTER, INC., THE, MULTIPLE CLASS, (INT. CLS. 16, 41 AND 42), (U.S. CLS. 2, 5, 22, 23, 29, 37, 38, 50, 100, 101 AND 107). SN 75-675,875. PUB. 2-26-2002. FILED 4-6-1999.
- 2,570,597. **MS.MIS**. INTERNATIONAL DATA GROUP, INC., (U.S. CLS. 2, 5, 22, 23, 29, 37, 38 AND 50). SN 75-691,836. PUB. 2-26-2002. FILED 4-26-1999.
- 2,570,628 (*See Class 9 for this trademark*).
- 2,570,641. **ANGRY LITTLE ASIAN GIRL**. LEE, LELA, DBA GORILLA PRODUCTIONS, MULTIPLE CLASS, (INT. CLS. 16 AND 41), (U.S. CLS. 2, 5, 22, 23, 29, 37, 38, 50, 100, 101 AND 107). SN 75-787,520. PUB. 2-26-2002. FILED 8-30-1999.
- 2,570,662. **EYVIND EARLE (STYLIZED)**. EARLE, EYVIND A., (U.S. CLS. 2, 5, 22, 23, 29, 37, 38 AND 50). SN 75-821,897. PUB. 2-26-2002. FILED 10-14-1999.
- 2,570,694. **HEALING WITHOUT HATE: HOW TO FORGIVE TO LIVE**. HEALING WITHOUT HATE ENTERPRISES, INC., (U.S. CLS. 2, 5, 22, 23, 29, 37, 38 AND 50). SN 75-874,166. PUB. 2-26-2002. FILED 12-18-1999.
- 2,570,696. **TALENT.COM**. SPENCER STUART MANAGEMENT CONSULTANTS N.V., (U.S. CLS. 2, 5, 22, 23, 29, 37, 38 AND 50). SN 75-874,524. PUB. 2-26-2002. FILED 12-17-1999.
- 2,570,752. **ORCA DESIGNS CO. AND DESIGN**. GOLD, SAMANTHA, (U.S. CLS. 2, 5, 22, 23, 29, 37, 38 AND 50). SN 75-979,924. PUB. 2-26-2002. FILED 8-13-1999.
- 2,570,753. **HOPE FOR THE HEART AND DESIGN**. HOPE FOR THE HEART, INC., MULTIPLE CLASS, (INT. CLS. 16 AND 41), (U.S. CLS. 2, 5, 22, 23, 29, 37, 38, 50, 100, 101 AND 107). SN 75-981,498. PUB. 2-26-2002. FILED 1-12-1999.
- 2,570,795. **POETS & WRITERS**. POETS & WRITERS, INC., (U.S. CLS. 2, 5, 22, 23, 29, 37, 38 AND 50). SN 76-031,124. PUB. 2-26-2002. FILED 4-20-2000.
- 2,570,827. **DESIGN MATTERS**. ONE VENTURES, INC., MULTIPLE CLASS, (INT. CLS. 16 AND 42), (U.S. CLS. 2, 5, 22, 23, 29, 37, 38, 50, 100 AND 101). SN 76-054,288. PUB. 2-26-2002. FILED 5-23-2000.
- 2,570,840 (*See Class 9 for this trademark*).
- 2,570,852. **SPOTTED DOG PRESS AND DESIGN**. SPOTTED DOG PRESS, INC., (U.S. CLS. 2, 5, 22, 23, 29, 37, 38 AND 50). SN 76-070,334. PUB. 8-28-2001. FILED 6-13-2000.
- 2,570,854. **NEWMUSIC**. CCM COMMUNICATIONS INC., (U.S. CLS. 2, 5, 22, 23, 29, 37, 38 AND 50). SN 76-070,881. PUB. 2-26-2002. FILED 6-15-2000.
- 2,570,864. **SUSHIGIRL**. MIXX ENTERTAINMENT, INC., (U.S. CLS. 2, 5, 22, 23, 29, 37, 38 AND 50). SN 76-074,396. PUB. 2-26-2002. FILED 6-21-2000.
- 2,570,886. **SING, READ & WRITE WITH BRITE**. BRITE MUSIC ENTER. INC., DBA BRITE MUSIC INC., (U.S. CLS. 2, 5, 22, 23, 29, 37, 38 AND 50). SN 76-080,506. PUB. 2-26-2002. FILED 6-29-2000.
- 2,570,914 (*See Class 9 for this trademark*).
- 2,570,915. **MAX & LUCY AND DESIGN**. MAX & LUCY, LLC, (U.S. CLS. 2, 5, 22, 23, 29, 37, 38 AND 50). SN 76-093,114. PUB. 2-26-2002. FILED 7-19-2000.
- 2,570,916. **MAX & LUCY**. MAX & LUCY, LLC, (U.S. CLS. 2, 5, 22, 23, 29, 37, 38 AND 50). SN 76-093,127. PUB. 2-26-2002. FILED 7-19-2000.
- 2,570,920. **OYSTER**. MOUNTAINTOP PUBLISHING, INC., (U.S. CLS. 2, 5, 22, 23, 29, 37, 38 AND 50). SN 76-093,964. PUB. 2-26-2002. FILED 7-21-2000.
- 2,570,922. **ECHOES SUNDAY SCHOOL SUPERINTENDENT'S HANDBOOK**. COOK COMMUNICATIONS INDUSTRIES, (U.S. CLS. 2, 5, 22, 23, 29, 37, 38 AND 50). SN 76-094,328. PUB. 2-26-2002. FILED 7-24-2000.
- 2,570,932 (*See Class 9 for this trademark*).
- 2,570,949. **PHOCUSWRIGHT**. PHOCUSWRIGHT, INC., (U.S. CLS. 2, 5, 22, 23, 29, 37, 38 AND 50). SN 76-104,356. PUB. 2-26-2002. FILED 8-7-2000.
- 2,570,957. **BOB VILA**. B.V.T.V., INC., (U.S. CLS. 2, 5, 22, 23, 29, 37, 38 AND 50). SN 76-110,410. PUB. 2-26-2002. FILED 8-17-2000.
- 2,570,958. **MIKE MULLIGAN AND HIS STEAM SHOVEL**. HOUGHTON MIFFLIN COMPANY, (U.S. CLS. 2, 5, 22, 23, 29, 37, 38 AND 50). SN 76-110,462. PUB. 2-26-2002. FILED 8-16-2000.
- 2,570,966. **EASY**. SAVAGE, BRIAN D., (U.S. CLS. 2, 5, 22, 23, 29, 37, 38 AND 50). SN 76-113,775. PUB. 6-12-2001. FILED 8-21-2000.
- 2,570,967. **CHEERIOS**. GENERAL MILLS, INC., MULTIPLE CLASS, (INT. CLS. 16 AND 28), (U.S. CLS. 2, 5, 22, 23, 29, 37, 38 AND 50). SN 76-114,946. PUB. 2-26-2002. FILED 8-22-2000.
- 2,570,976. **TASTE OF SOUL**. MOBLEY, DARRYL L., (U.S. CLS. 2, 5, 22, 23, 29, 37, 38 AND 50). SN 76-116,605. PUB. 2-26-2002. FILED 8-28-2000.
- 2,570,977. **SADDLEBACK VALLEY NEWS**. GOLDEN WEST PUBLISHING, INC., (U.S. CLS. 2, 5, 22, 23, 29, 37, 38 AND 50). SN 76-116,636. PUB. 2-26-2002. FILED 8-25-2000.
- 2,570,986. **BANK INVESTMENT MARKETING**. ME LICENSING CORPORATION, (U.S. CLS. 2, 5, 22, 23, 29, 37, 38 AND 50). SN 76-117,941. PUB. 2-26-2002. FILED 8-28-2000.
- 2,570,991. **DENTAL LEARNING SYSTEMS POSTGRADUATE DENTISTRY**. DENTAL LEARNING SYSTEMS CO., INC., (U.S. CLS. 2, 5, 22, 23, 29, 37, 38 AND 50). SN 76-119,176. PUB. 2-26-2002. FILED 8-29-2000.
- 2,570,992. **ULTIMA ONE**. PREMARK FEG L.L.C., (U.S. CLS. 2, 5, 22, 23, 29, 37, 38 AND 50). SN 76-119,502. PUB. 2-26-2002. FILED 8-30-2000.
- 2,571,014. **PLATINUM PROFILES**. ADAMS/HUNTER PUBLISHING, INC., (U.S. CLS. 2, 5, 22, 23, 29, 37, 38 AND 50). SN 76-125,814. PUB. 2-26-2002. FILED 9-8-2000.
- 2,571,015. **MISCELLANEOUS DESIGN**. MAJOR LEAGUE BASEBALL PLAYERS ALUMNI ASSOCIATION, MULTIPLE CLASS, (INT. CLS. 16, 18, 25, 41 AND 42), (U.S. CLS. 1, 2, 3, 5, 22, 23, 29, 37, 38, 39, 41, 50, 100, 101 AND 107). SN 76-125,923. PUB. 2-26-2002. FILED 9-7-2000.
- 2,571,018. **ITOI MARKETER**. MARKETING ONE-TO-ONE, INC., BY MERGER MARKETING ONE TO ONE, INC., (U.S. CLS. 2, 5, 22, 23, 29, 37, 38 AND 50). SN 76-126,674. PUB. 2-26-2002. FILED 9-12-2000.
- 2,571,025. **TRANSHIELD**. TRANSHIELD AS, (U.S. CLS. 2, 5, 22, 23, 29, 37, 38 AND 50). SN 76-130,129. PUB. 2-26-2002. FILED 9-18-2000.
- 2,571,027. **INLAND SEAS EDUCATION ASSOCIATION THE GREAT LAKES SCHOOLSHIP AND DESIGN**. INLAND SEAS EDUCATION ASSOCIATION, (U.S. CLS. 2, 5, 22, 23, 29, 37, 38 AND 50). SN 76-131,283. PUB. 2-26-2002. FILED 9-20-2000.
- 2,571,036. **ANNUITY SOLUTIONS**. ANNUITY SOLUTIONS, INC., (U.S. CLS. 2, 5, 22, 23, 29, 37, 38 AND 50). SN 76-134,441. PUB. 2-26-2002. FILED 9-25-2000.
- 2,571,038. **WE-SEW-IT.COM**. MICRO TEXTILE, INC., MULTIPLE CLASS, (INT. CLS. 16, 18 AND 25), (U.S. CLS. 1, 2, 3, 5, 22, 23, 29, 37, 38, 39, 41 AND 50). SN 76-135,197. PUB. 2-26-2002. FILED 9-25-2000.
- 2,571,051. **BLACK WIDOW**. MARVEL CHARACTERS, INC., (U.S. CLS. 2, 5, 22, 23, 29, 37, 38 AND 50). SN 76-140,621. PUB. 2-26-2002. FILED 10-3-2000.
- 2,571,054. **TUTOR TIME P.R.E.P.**. TUTOR TIME LEARNING SYSTEMS, INC., (U.S. CLS. 2, 5, 22, 23, 29, 37, 38 AND 50). SN 76-143,013. PUB. 2-26-2002. FILED 10-10-2000.
- 2,571,055. **MISCELLANEOUS DESIGN**. CONCORDIA UNIVERSITY, (U.S. CLS. 2, 5, 22, 23, 29, 37, 38 AND 50). SN 76-143,052. PUB. 2-26-2002. FILED 10-10-2000.

- 2,571,057. **ING INTERNATIONAL NETWORK OF GOLF AND DESIGN.** JAMISON GROUP, MULTIPLE CLASS, (INT. CLS. 16 AND 35), (U.S. CLS. 2, 5, 22, 23, 29, 37, 38, 50, 100, 101 AND 102). SN 76-143,132. PUB. 2-26-2002. FILED 10-10-2000.
- 2,571,079. **EMONITOR.** HANLEY-WOOD, LLC, (U.S. CLS. 2, 5, 22, 23, 29, 37, 38 AND 50). SN 76-153,765. PUB. 7-10-2001. FILED 10-25-2000.
- 2,571,083. **MISCELLANEOUS DESIGN.** TICHENOR, BRUCE H., DBA STORY WINERY, (U.S. CLS. 2, 5, 22, 23, 29, 37, 38 AND 50). SN 76-154,798. PUB. 2-26-2002. FILED 10-30-2000.
- 2,571,089. **CIGAR DOSSIER.** ARANGOLD CORPORATION, (U.S. CLS. 2, 5, 22, 23, 29, 37, 38 AND 50). SN 76-157,983. PUB. 2-26-2002. FILED 11-1-2000.
- 2,571,105. **ADAMS, HARKNESS & HILL THE EMERGING GROWTH INVESTMENT BANK.** ADAMS, HARKNESS & HILL, INC., MULTIPLE CLASS, (INT. CLS. 16, 35, 36 AND 41), (U.S. CLS. 2, 5, 22, 23, 29, 37, 38, 50, 100, 101, 102 AND 107). SN 76-164,981. PUB. 2-26-2002. FILED 11-14-2000.
- 2,571,112. **THE PRESBYTERIAN LAYMAN.** PRESBYTERIAN LAY COMMITTEE, INC., (U.S. CLS. 2, 5, 22, 23, 29, 37, 38 AND 50). SN 76-166,021. PUB. 2-26-2002. FILED 11-14-2000.
- 2,571,150 (*See Class 9 for this trademark.*).
- 2,571,152 (*See Class 9 for this trademark.*).
- 2,571,168. **EL PROFESOR.** RCP SERVICES, LLC, MULTIPLE CLASS, (INT. CLS. 16 AND 36), (U.S. CLS. 2, 5, 22, 23, 29, 37, 38, 50, 100, 101 AND 102). SN 76-189,898. PUB. 2-26-2002. FILED 1-8-2001.
- 2,571,181. **VANGUARD.** UNITED STATES NAVY, (U.S. CLS. 2, 5, 22, 23, 29, 37, 38 AND 50). SN 76-203,619. PUB. 2-26-2002. FILED 2-2-2001.
- 2,571,210. **WOMEN IN THE LIFE.** REID, SHEILA A., MULTIPLE CLASS, (INT. CLS. 16 AND 41), (U.S. CLS. 2, 5, 22, 23, 29, 37, 38, 50, 100, 101 AND 107). SN 76-222,242. PUB. 2-26-2002. FILED 3-7-2001.
- 2,571,216. **ON ASSIGNMENT.** NATIONAL GEOGRAPHIC SOCIETY, MULTIPLE CLASS, (INT. CLS. 16 AND 41), (U.S. CLS. 2, 5, 22, 23, 29, 37, 38, 50, 100, 101 AND 107). SN 76-224,365. PUB. 2-26-2002. FILED 3-14-2001.
- 2,571,218. **OUTER BANKS MAGAZINE.** ELI EDMUND CO., THE, (U.S. CLS. 2, 5, 22, 23, 29, 37, 38 AND 50). SN 76-224,411. PUB. 2-26-2002. FILED 3-15-2001.
- 2,571,234. **WATER GARDENING.** WATER GARDENERS, INC., THE, (U.S. CLS. 2, 5, 22, 23, 29, 37, 38 AND 50). SN 76-232,520. PUB. 2-26-2002. FILED 3-29-2001.
- 2,571,245. **HEADACHEX (STYLIZED).** DOWLING, WILLIAM P., (U.S. CLS. 2, 5, 22, 23, 29, 37, 38 AND 50). SN 76-237,211. PUB. 2-26-2002. FILED 4-9-2001.
- 2,571,246. **MUSIC 101.** FERGUSON, RONALD ANTONIO, (U.S. CLS. 2, 5, 22, 23, 29, 37, 38 AND 50). SN 76-238,148. PUB. 2-26-2002. FILED 4-10-2001.
- 2,571,247. **THE FEDERAL CREDIT UNION.** NATIONAL ASSOCIATION OF FEDERAL CREDIT UNIONS, (U.S. CLS. 2, 5, 22, 23, 29, 37, 38 AND 50). SN 76-238,788. PUB. 2-26-2002. FILED 4-10-2001.
- 2,571,248. **BRING BACK BAG.** ROPLAST INDUSTRIES, INC., (U.S. CLS. 2, 5, 22, 23, 29, 37, 38 AND 50). SN 76-238,791. PUB. 2-26-2002. FILED 4-10-2001.
- 2,571,279. **MISCELLANEOUS DESIGN.** ZORRO PRODUCTIONS, INC., (U.S. CLS. 2, 5, 22, 23, 29, 37, 38 AND 50). SN 76-248,944. PUB. 2-26-2002. FILED 5-1-2001.
- 2,571,322. **PERSHING INVESTMENT MANAGER SERVICES PRIMELEDGER.** DLJ LONG TERM INVESTMENT CORPORATION, (U.S. CLS. 2, 5, 22, 23, 29, 37, 38 AND 50). SN 76-269,169. PUB. 2-26-2002. FILED 6-8-2001.
- 2,571,334. **AZIEL INCISED STYLE.** AZIEL, BARBIE-DAE, (U.S. CLS. 2, 5, 22, 23, 29, 37, 38 AND 50). SN 76-273,936. PUB. 2-26-2002. FILED 6-19-2001.
- 2,571,336. **SING AND READ STORYBOOK AND DESIGN.** SCHOLASTIC INC., (U.S. CLS. 2, 5, 22, 23, 29, 37, 38 AND 50). SN 76-275,333. PUB. 2-26-2002. FILED 6-22-2001.
- 2,571,393. **GALLERYWRAP.** TARA MATERIALS, INC., (U.S. CLS. 2, 5, 22, 23, 29, 37, 38 AND 50). SN 76-305,347. PUB. 2-26-2002. FILED 8-23-2001.
- 2,571,407. **AGENDA.** INTERNATIONAL DATA GROUP, INC., (U.S. CLS. 2, 5, 22, 23, 29, 37, 38 AND 50). SN 76-310,385. PUB. 2-26-2002. FILED 9-7-2001.
- 2,571,410. **MISCELLANEOUS DESIGN.** BUFFALO BILLS, INC., MULTIPLE CLASS, (INT. CLS. 16, 25, 28 AND 41), (U.S. CLS. 2, 5, 22, 23, 29, 37, 38, 39, 50, 100, 101 AND 107). SN 76-311,534. PUB. 2-26-2002. FILED 9-10-2001.
- 2,571,414. **DEBENBROOK GRAPHICS.** SOPKO, JOHN, (U.S. CLS. 2, 5, 22, 23, 29, 37, 38 AND 50). SN 76-312,153. PUB. 2-26-2002. FILED 9-17-2001.
- 2,571,415. **ROYAL PAPER.** ROYAL PAPER CONVERTING, INC., (U.S. CLS. 2, 5, 22, 23, 29, 37, 38 AND 50). SN 76-312,187. PUB. 2-26-2002. FILED 9-7-2001.
- 2,571,429. **AMERICAN PROFILE.** PUBLISHING GROUP OF AMERICA, INC., (U.S. CLS. 2, 5, 22, 23, 29, 37, 38 AND 50). SN 76-313,673. PUB. 2-26-2002. FILED S.R. 9-17-2001; AM. P.R. 9-17-2001.
- 2,571,437. **S.C.R.U.B.** HOLMES, SUE E., (U.S. CLS. 2, 5, 22, 23, 29, 37, 38 AND 50). SN 76-315,209. PUB. 2-26-2002. FILED 9-19-2001.
- 2,571,532. **MISCELLANEOUS DESIGN.** PHOENIX PACKAGING, INC., (U.S. CLS. 2, 5, 22, 23, 29, 37, 38 AND 50). SN 78-034,455. PUB. 2-26-2002. FILED 11-9-2000.
- 2,571,542. **INCREDIBLE FEETS AND DESIGN.** HAINES, TERESA M., (U.S. CLS. 2, 5, 22, 23, 29, 37, 38 AND 50). SN 78-035,991. PUB. 2-26-2002. FILED 11-19-2000.
- 2,571,604. **TEKHNIKOS.** TEKHNIKOS SOLUTIONS, INC., (U.S. CLS. 2, 5, 22, 23, 29, 37, 38 AND 50). SN 78-054,670. PUB. 2-26-2002. FILED 3-23-2001.
- 2,571,630. **E-CADEMY OF TRADING.** WASENDORF & ASSOCIATES INC., MULTIPLE CLASS, (INT. CLS. 16 AND 41), (U.S. CLS. 2, 5, 22, 23, 29, 37, 38, 50, 100, 101 AND 107). SN 78-064,409. PUB. 2-26-2002. FILED 5-18-2001.
- 2,571,657. **STRATHMORE.** INTERNATIONAL PAPER COMPANY, (U.S. CLS. 2, 5, 22, 23, 29, 37, 38 AND 50). SN 78-075,655. PUB. 2-26-2002. FILED 7-25-2001.
- 2,571,662. **THERE'S MORE TO SEE IN A BILIBOTTOMS DIAPER... AND DESIGN.** BILIBOTTOMS, INC., (U.S. CLS. 2, 5, 22, 23, 29, 37, 38 AND 50). SN 78-076,446. PUB. 2-26-2002. FILED 7-30-2001.
-
- CLASS 17—RUBBER GOODS**
- 2,570,488. **Y HYDEX AND DESIGN.** YOKOHAMA HYDEX COMPANY, (U.S. CLS. 1, 5, 12, 13, 35 AND 50). SN 75-172,691. PUB. 2-22-2000. FILED 9-26-1996.
- 2,570,489. **Y HYDEX AND DESIGN.** YOKOHAMA HYDEX COMPANY, (U.S. CLS. 1, 5, 12, 13, 35 AND 50). SN 75-172,692. PUB. 1-25-2000. FILED 9-26-1996.
- 2,570,551. **ARMOR CRYSTAL.** NIPPON VALQUA INDUSTRIES, LTD., (U.S. CLS. 1, 5, 12, 13, 35 AND 50). SN 75-578,661. PUB. 2-26-2002. FILED 10-28-1998.
- 2,570,562 (*See Class 4 for this trademark.*).
- 2,570,954 (*See Class 3 for this trademark.*).
- 2,571,020. **GRAVITON.** BERGHAUS LIMITED, (U.S. CLS. 1, 5, 12, 13, 35 AND 50). SN 76-126,811. PUB. 2-26-2002. FILED 9-12-2000.
- 2,571,072. **NYTECH.** NMW, INC., (U.S. CLS. 1, 5, 12, 13, 35 AND 50). SN 76-149,702. PUB. 2-26-2002. FILED 10-19-2000.
- 2,571,251. **TRILON AR.** TRI-STAR PLASTICS CORP., (U.S. CLS. 1, 5, 12, 13, 35 AND 50). SN 76-240,912. PUB. 2-26-2002. FILED 4-16-2001.
- 2,571,272. **POLY-STRIP.** HOHMANN & BARNARD, INC., (U.S. CLS. 1, 5, 12, 13, 35 AND 50). SN 76-247,958. PUB. 2-26-2002. FILED 4-30-2001.
- 2,571,302 (*See Class 3 for this trademark.*).
-
- CLASS 18—LEATHER GOODS**
- 2,570,483. **LES FERRAILLEURS.** CUIRSCO DIFFUSION, MULTIPLE CLASS, (INT. CLS. 18 AND 25), (U.S. CLS. 1, 2, 3, 22, 39 AND 41). SN 74-707,993. PUB. 3-17-1998. FILED 7-31-1995.
- 2,570,490 (*See Class 3 for this trademark.*).
- 2,570,547 (*See Class 9 for this trademark.*).
- 2,570,598. **WELLINGTON HURRICANES AND DESIGN.** NEW ZEALAND RUGBY FOOTBALL UNION INC., MULTIPLE CLASS, (INT. CLS. 18, 25, 28 AND 41), (U.S. CLS. 1, 2, 3, 22,

- 23, 38, 39, 41, 50, 100, 101 AND 107). SN 75-696,504. PUB. 2-26-2002. FILED 5-3-1999.
- 2,570,638. **PODAKUS**. RATON SERVICOS DE CONSULTA-DORIA E MARKETING LDA., (U.S. CLS. 1, 2, 3, 22 AND 41). SN 75-782,604. PUB. 10-31-2000. FILED 8-23-1999.
- 2,570,677. **TOM COLLINS**. CUIRICO DIFFUSION, MULTIPLE CLASS, (INT. CLS. 18 AND 25), (U.S. CLS. 1, 2, 3, 22, 39 AND 41). SN 75-854,503. PUB. 2-20-2001. FILED 11-23-1999.
- 2,570,820. **AA CLUB AMERICAN AND DESIGN**. AMERICAN AIRLINES, INC., MULTIPLE CLASS, (INT. CLS. 18, 24, 25 AND 28), (U.S. CLS. 1, 2, 3, 22, 23, 38, 39, 41, 42 AND 50). SN 76-052,391. PUB. 2-26-2002. FILED 5-18-2000.
- 2,570,840 (*See Class 9 for this trademark*).
- 2,570,842. **MISCELLANEOUS DESIGN**. GENERAL MOTORS CORPORATION, (U.S. CLS. 1, 2, 3, 22 AND 41). SN 76-063,243. PUB. 2-26-2002. FILED 6-5-2000.
- 2,571,015 (*See Class 16 for this trademark*).
- 2,571,038 (*See Class 16 for this trademark*).
- 2,571,241. **MGM GRAND AND DESIGN**. METRO-GOLDWYN-MAYER LION CORP., (U.S. CLS. 1, 2, 3, 22 AND 41). SN 76-234,342. PUB. 2-26-2002. FILED 4-2-2001.
- 2,571,330. **OSPREY AND DESIGN**. OSPREY PACKS, INC., (U.S. CLS. 1, 2, 3, 22 AND 41). SN 76-272,861. PUB. 2-26-2002. FILED 6-18-2001.

CLASS 19—NON-METALLIC BUILDING MATERIALS

- 2,570,542. **SANTA FE BROWN**. WESTERN-MOBILE NEW MEXICO, INC., (U.S. CLS. 1, 12, 33 AND 50). SN 75-523,058. PUB. 9-11-2001. FILED 7-21-1998.
- 2,570,639. **MISCELLANEOUS DESIGN**. REITER, WERNER, MULTIPLE CLASS, (INT. CLS. 19 AND 20), (U.S. CLS. 1, 2, 12, 13, 22, 25, 32, 33 AND 50). SN 75-783,561. PUB. 2-26-2002. FILED 8-23-1999.
- 2,571,059. **FLOORNATURE**. IRIS CERAMICA - SOCIETA' PER AZIONI, (U.S. CLS. 1, 12, 33 AND 50). SN 76-144,591. PUB. 2-26-2002. FILED 10-10-2000.
- 2,571,222. **ARMORWEDGE**. LEE MASONRY PRODUCTS, LLC, (U.S. CLS. 1, 12, 33 AND 50). SN 76-225,765. PUB. 2-26-2002. FILED 3-16-2001.
- 2,571,238 (*See Class 6 for this trademark*).
- 2,571,520 (*See Class 12 for this trademark*).
- 2,571,683. **OMNIDIRECTIONAL FOOT**. WENGER CORPORATION, (U.S. CLS. 1, 12, 33 AND 50). SN 78-087,365. PUB. 2-26-2002. FILED 10-8-2001.

CLASS 20—FURNITURE AND ARTICLES NOT OTHERWISE CLASSIFIED

- 2,570,490 (*See Class 3 for this trademark*).
- 2,570,533 (*See Class 9 for this trademark*).
- 2,570,562 (*See Class 4 for this trademark*).
- 2,570,639 (*See Class 19 for this trademark*).
- 2,570,645 (*See Class 10 for this trademark*).
- 2,570,754 (*See Class 7 for this trademark*).
- 2,570,798. **BABY B'COMFY**. STAYNER, MARK, AND STAYNER, DEENA, (U.S. CLS. 2, 13, 22, 25, 32 AND 50). SN 76-035,930. PUB. 2-26-2002. FILED 4-28-2000.
- 2,570,806. **TOPPACK**. ROSE PLASTIC GMBH, (U.S. CLS. 2, 13, 22, 25, 32 AND 50). SN 76-042,967. PUB. 9-11-2001. FILED 5-8-2000.
- 2,570,954 (*See Class 3 for this trademark*).
- 2,570,983. **LEA INDUSTRIES**. LADD FURNITURE, INC., (U.S. CLS. 2, 13, 22, 25, 32 AND 50). SN 76-117,631. PUB. 2-26-2002. FILED 8-28-2000.
- 2,571,131. **FRAME & FORTUNE**. SOUPIOS, MEREDITH F., (U.S. CLS. 2, 13, 22, 25, 32 AND 50). SN 76-170,748. PUB. 2-26-2002. FILED 11-27-2000.
- 2,571,172. **JONATHAN TAYLOR (STYLIZED)**. LEADER'S HOLDING COMPANY, (U.S. CLS. 2, 13, 22, 25, 32 AND 50). SN 76-191,985. PUB. 2-26-2002. FILED 1-8-2001.
- 2,571,174. **MIRRORED REFLECTIONS AND DESIGN**. STRA-

- VINA OPERATING COMPANY, LLC, (U.S. CLS. 2, 13, 22, 25, 32 AND 50). SN 76-195,071. PUB. 2-26-2002. FILED 1-17-2001.
- 2,571,426. **SHOE BOX BEARS**. BOYDS COLLECTION, LTD, THE, (U.S. CLS. 2, 13, 22, 25, 32 AND 50). SN 76-313,647. PUB. 2-26-2002. FILED 9-18-2001.
- 2,571,451. **CUSTOM CRAFT**. RECOGNITION EXPERTS INC., MULTIPLE CLASS, (INT. CLS. 20, 40 AND 42), (U.S. CLS. 2, 13, 22, 25, 32, 50, 100, 101, 103 AND 106). SN 76-318,382. PUB. 2-26-2002. FILED 9-27-2001.
- 2,571,525. **LONG SWAMP STUDIOS AND DESIGN**. LONG SWAMP STUDIOS, LLC, (U.S. CLS. 2, 13, 22, 25, 32 AND 50). SN 78-032,264. PUB. 2-26-2002. FILED 10-25-2000.
- 2,571,650. **KRAVETFURNITURE**. KRAVET FABRICS, INC., (U.S. CLS. 2, 13, 22, 25, 32 AND 50). SN 78-073,007. PUB. 2-26-2002. FILED 7-9-2001.

CLASS 21—HOUSEWARES AND GLASS

- 2,570,490 (*See Class 3 for this trademark*).
- 2,570,594 (*See Class 8 for this trademark*).
- 2,570,706. **MISCELLANEOUS DESIGN**. SEAL-SPOUT CORPORATION, (U.S. CLS. 2, 13, 23, 29, 30, 33, 40 AND 50). SN 75-898,014. PUB. 2-26-2002. FILED 1-19-2000.
- 2,570,736 (*See Class 11 for this trademark*).
- 2,570,858. **DUSTSMART**. GUSTIN-KRAMER LIMITED, (U.S. CLS. 2, 13, 23, 29, 30, 33, 40 AND 50). SN 76-072,769. PUB. 2-26-2002. FILED 6-19-2000.
- 2,570,954 (*See Class 3 for this trademark*).
- 2,570,982 (*See Class 5 for this trademark*).
- 2,571,291. **TAKE A SHAKE BREAK**. FLAVOR BURST COMPANY, MULTIPLE CLASS, (INT. CLS. 21 AND 30), (U.S. CLS. 2, 13, 23, 29, 30, 33, 40, 46 AND 50). SN 76-257,101. PUB. 2-26-2002. FILED 5-15-2001.
- 2,571,362. **DANGER MEN DRINKING**. ANDE ROONEY INC., (U.S. CLS. 2, 13, 23, 29, 30, 33, 40 AND 50). SN 76-284,803. PUB. 2-26-2002. FILED 7-12-2001.
- 2,571,613. **GALLANT**. HOMETEK INTERNATIONAL GROUP CORP., (U.S. CLS. 2, 13, 23, 29, 30, 33, 40 AND 50). SN 78-056,365. PUB. 2-26-2002. FILED 4-2-2001.

CLASS 22—CORDAGE AND FIBERS

- 2,570,765. **BAG IT!**. LUMEN TWEAKS LIGHTING, INC., (U.S. CLS. 1, 2, 7, 19, 22, 42 AND 50). SN 76-011,533. PUB. 9-4-2001. FILED 3-27-2000.
- 2,570,773. **ELVES AT WORK**. OLD TIME POTTERY, INC., (U.S. CLS. 1, 2, 7, 19, 22, 42 AND 50). SN 76-017,354. PUB. 2-26-2002. FILED 4-4-2000.
- 2,570,774. **HAY STACKS**. OLD TIME POTTERY, INC., (U.S. CLS. 1, 2, 7, 19, 22, 42 AND 50). SN 76-017,359. PUB. 2-26-2002. FILED 4-4-2000.
- 2,571,365. **INTER WRAP AND DESIGN**. INTERWRAP INC., (U.S. CLS. 1, 2, 7, 19, 22, 42 AND 50). SN 76-286,412. PUB. 2-26-2002. FILED 7-10-2001.
- 2,571,413. **CROSS COUNTRY**. DELAWARE CAPITAL FORMATION, INC., (U.S. CLS. 1, 2, 7, 19, 22, 42 AND 50). SN 76-312,102. PUB. 2-26-2002. FILED 8-29-2001.

CLASS 24—FABRICS

- 2,570,490 (*See Class 3 for this trademark*).
- 2,570,820 (*See Class 18 for this trademark*).
- 2,570,836. **THE PEABODY (STYLIZED)**. PEABODY MANAGEMENT, INC., (U.S. CLS. 42 AND 50). SN 76-059,503. PUB. 2-26-2002. FILED 5-31-2000.
- 2,570,971. **AIRFOIL**. BERGHAUS LIMITED, MULTIPLE CLASS, (INT. CLS. 24 AND 25), (U.S. CLS. 22, 39, 42 AND 50). SN 76-115,697. PUB. 6-26-2001. FILED 8-23-2000.
- 2,571,066. **HOCKANUM**. VICTOR FORSTMANN, INC., (U.S. CLS. 42 AND 50). SN 76-147,277. PUB. 2-26-2002. FILED 10-

16-2000.
 2,571,306. **DUOTECH**. ASICS CORPORATION, (U.S. CLS. 42 AND 50). SN 76-262,491. PUB. 2-26-2002. FILED 5-25-2001.
 2,571,417. **SENSATIABLES**. GFD FABRICS, INC., (U.S. CLS. 42 AND 50). SN 76-312,252. PUB. 2-26-2002. FILED 9-12-2001.
 2,571,423. **MISCELLANEOUS DESIGN**. SUNBURY TEXTILE MILLS, INC., (U.S. CLS. 42 AND 50). SN 76-313,144. PUB. 2-26-2002. FILED 9-17-2001.
 2,571,517. **MANIFATTURA BORGOMANERI 1862 AND DESIGN**. MANIFATTURA DI FERNO S.R.L., (U.S. CLS. 42 AND 50). SN 78-029,699. PUB. 2-26-2002. FILED 10-9-2000.
 2,571,612. **DESLEE**. DESLEE, NAAMLOZE VENNOOTSCHAP, (U.S. CLS. 42 AND 50). SN 78-056,338. PUB. 2-26-2002. FILED 4-2-2001.

CLASS 25—CLOTHING

2,570,483 (*See Class 18 for this trademark*).
 2,570,490 (*See Class 3 for this trademark*).
 2,570,543. **GOLDEN BOY**. GOLDEN BOY ENTERPRISES, LLC. BY ASSIGNMENT OSCAR DE LA HOYA ENTERPRISES, INC., (U.S. CLS. 22 AND 39). SN 75-527,905. PUB. 10-16-2001. FILED 7-30-1998.
 2,570,547 (*See Class 9 for this trademark*).
 2,570,580. **DO HAP SOOL**. WORLD DO HAP SOOL ASSOCIATION, MULTIPLE CLASS, (INT. CLS. 25 AND 41), (U.S. CLS. 22, 39, 100, 101 AND 107). SN 75-644,191. PUB. 2-26-2002. FILED 2-17-1999.
 2,570,588. **AZALEIA BRASIL AND DESIGN**. CALCADOS AZALEIA S.A., (U.S. CLS. 22 AND 39). SN 75-671,086. PUB. 2-26-2002. FILED 3-29-1999.
 2,570,598 (*See Class 18 for this trademark*).
 2,570,615. **NEXT TO NOTHING**. C.S.F. CORP., (U.S. CLS. 22 AND 39). SN 75-740,654. PUB. 2-26-2002. FILED 6-30-1999.
 2,570,630. **YOBET.COM**. YOBET.COM, INC., (U.S. CLS. 22 AND 39). SN 75-774,968. PUB. 2-1-2000. FILED 8-13-1999.
 2,570,631. **YOBET.COM AND DESIGN**. YOBET.COM, INC., (U.S. CLS. 22 AND 39). SN 75-774,974. PUB. 2-22-2000. FILED 8-13-1999.
 2,570,640. **KORET**. KORET OF CALIFORNIA, INC., (U.S. CLS. 22 AND 39). SN 75-786,041. PUB. 2-26-2002. FILED 8-26-1999.
 2,570,646. **BOBUX**. BENNETT, CHRISTOPHER ROBERT, (U.S. CLS. 22 AND 39). SN 75-798,169. PUB. 2-26-2002. FILED 9-13-1999.
 2,570,677 (*See Class 18 for this trademark*).
 2,570,687. **HONEY POT**. HONEY POT, INC., (U.S. CLS. 22 AND 39). SN 75-866,058. PUB. 2-26-2002. FILED 12-7-1999.
 2,570,702. **PERMSOLE**. FALKE KG, (U.S. CLS. 22 AND 39). SN 75-882,681. PUB. 2-26-2002. FILED 12-28-1999.
 2,570,719. **THE WEBSITE FOR REAL MEN! (STYLIZED)**. STEWART, J JOSEPH, MULTIPLE CLASS, (INT. CLS. 25 AND 42), (U.S. CLS. 22, 39, 100 AND 101). SN 75-912,183. PUB. 2-26-2002. FILED 2-8-2000.
 2,570,721. **GOLDEN BEARS**. REGENTS OF THE UNIVERSITY OF CALIFORNIA, THE, (U.S. CLS. 22 AND 39). SN 75-916,595. PUB. 2-26-2002. FILED 2-11-2000.
 2,570,729. **WIL-LI-NETICS**. BLANKS, WILLIE R., MULTIPLE CLASS, (INT. CLS. 25 AND 41), (U.S. CLS. 22, 39, 100, 101 AND 107). SN 75-923,405. PUB. 2-26-2002. FILED 2-18-2000.
 2,570,792. **PRECIP**. MARMOT MOUNTAIN LTD., (U.S. CLS. 22 AND 39). SN 76-029,164. PUB. 2-26-2002. FILED 4-19-2000.
 2,570,793. **GBLAX GAIT BROTHERS LACROSSE AND DESIGN**. GAIT BROTHERS LACROSSE COMPANY, MULTIPLE CLASS, (INT. CLS. 25 AND 35), (U.S. CLS. 22, 39, 100, 101 AND 102). SN 76-029,918. PUB. 2-26-2002. FILED 4-20-2000.
 2,570,807. **HI-PERFORMANCE NICKEY CHICAGO HOT ROD PARTS AND DESIGN**. LITTLE DETROIT, INCORPORATED, (U.S. CLS. 22 AND 39). SN 76-044,331. PUB. 2-26-2002. FILED 5-9-2000.
 2,570,820 (*See Class 18 for this trademark*).
 2,570,838. **EXECUTONES**. SGARLATA, ROBERT E., MULTIPLE CLASS, (INT. CLS. 25 AND 41), (U.S. CLS. 22, 39, 100, 101 AND 107). SN 76-061,063. PUB. 2-26-2002. FILED 6-1-2000.
 2,570,867. **JUST TIGHTS AND DESIGN**. ROBERTS, KIMBERLY ANN, (U.S. CLS. 22 AND 39). SN 76-076,219. PUB. 2-26-2002. FILED 6-23-2000.
 2,570,902. **HARRISBURG MILE**. SALOMON SMITH BARNEY, MULTIPLE CLASS, (INT. CLS. 25 AND 36), (U.S. CLS. 22, 39, 100, 101 AND 102). SN 76-086,874. PUB. 2-26-2002. FILED 7-11-2000.
 2,570,917. **FRENCH LAUNDRY**. MERVYN'S BRANDS, INC., (U.S. CLS. 22 AND 39). SN 76-093,933. PUB. 5-22-2001. FILED 7-24-2000.
 2,570,950. **FEDO AND DESIGN**. JIANGSU SILK IMPORT & EXPORT GROUP CORPORATION, (U.S. CLS. 22 AND 39). SN 76-105,687. PUB. 2-26-2002. FILED 8-9-2000.
 2,570,971 (*See Class 24 for this trademark*).
 2,570,984. **DAMAGE WEAR AND DESIGN**. ADLER, JEFF, AND HINES, STEVE, (U.S. CLS. 22 AND 39). SN 76-117,721. PUB. 2-26-2002. FILED 8-28-2000.
 2,570,990. **R AND DESIGN**. PAOLINI, SALVATORE, AND BAMBARA, JOSEPH J., (U.S. CLS. 22 AND 39). SN 76-118,405. PUB. 2-26-2002. FILED 8-29-2000.
 2,571,015 (*See Class 16 for this trademark*).
 2,571,021. **TYE DYE FACTORY**. TYE-DYE FACTORY, INC., THE, (U.S. CLS. 22 AND 39). SN 76-127,659. PUB. 2-26-2002. FILED 9-13-2000.
 2,571,026. **LOUPILOU (STYLIZED)**. KULBER, CAROLE DEVOGLE, (U.S. CLS. 22 AND 39). SN 76-131,188. PUB. 2-26-2002. FILED 9-18-2000.
 2,571,028 (*See Class 14 for this trademark*).
 2,571,038 (*See Class 16 for this trademark*).
 2,571,042. **C AND DESIGN**. BOLD DISTRIBUTION, INC., MULTIPLE CLASS, (INT. CLS. 25 AND 28), (U.S. CLS. 22, 23, 38, 39 AND 50). SN 76-136,052. PUB. 2-26-2002. FILED 9-26-2000.
 2,571,060. **TEAM CHEER**. TEAM CHEER, INC., (U.S. CLS. 22 AND 39). SN 76-144,709. PUB. 2-26-2002. FILED 10-10-2000.
 2,571,065. **VERTEBRA SYSTEM**. MOTONATION, (U.S. CLS. 22 AND 39). SN 76-147,028. PUB. 2-26-2002. FILED 10-16-2000.
 2,571,081. **ESSENTIAL GEAR**. VITAL APPAREL GROUP, (U.S. CLS. 22 AND 39). SN 76-153,948. PUB. 2-26-2002. FILED 10-26-2000.
 2,571,084. **ROAD-MATE AND DESIGN**. ROAD MATE INTERNATIONAL LIMITED, (U.S. CLS. 22 AND 39). SN 76-155,728. PUB. 2-26-2002. FILED 10-27-2000.
 2,571,088. **ALTA RESA**. HARTZ & COMPANY, INC., (U.S. CLS. 22 AND 39). SN 76-157,417. PUB. 2-26-2002. FILED 11-1-2000.
 2,571,107. **XEEX (STYLIZED)**. LIMOS DI SCALCO VALENTINO & C. SNC, (U.S. CLS. 22 AND 39). SN 76-165,538. PUB. 9-25-2001. FILED 11-16-2000.
 2,571,119. **FEELING LOVELY**. AMITY HOSIERY CO., INC., (U.S. CLS. 22 AND 39). SN 76-167,898. PUB. 8-14-2001. FILED 11-17-2000.
 2,571,148. **COOKIES TO COLLEGE WWW.COOKIESTOCOLLEGE.COM AND DESIGN**. BATEMAN, BRENT A., MULTIPLE CLASS, (INT. CLS. 25, 30 AND 39), (U.S. CLS. 22, 39, 46, 100 AND 105). SN 76-177,915. PUB. 2-26-2002. FILED 12-11-2000.
 2,571,198. **OUTLET @ THE CREEK**. COLDWATER CREEK INC., (U.S. CLS. 22 AND 39). SN 76-216,329. PUB. 2-26-2002. FILED 2-23-2001.
 2,571,208. **A LITTLE OBSESSED WITH SHOES**. STUART WEITZMAN, INC., (U.S. CLS. 22 AND 39). SN 76-221,446. PUB. 2-26-2002. FILED 3-8-2001.
 2,571,226. **D:FUSE**. WOR INTERNATIONAL, INC., (U.S. CLS. 22 AND 39). SN 76-226,734. PUB. 9-4-2001. FILED 3-16-2001.
 2,571,231. **X N T X AND DESIGN**. ROOCHI TRADERS, INC., (U.S. CLS. 22 AND 39). SN 76-228,438. PUB. 9-4-2001. FILED 3-21-2001.
 2,571,235. **SMARTY TECHNOLOGY**. WEST, MICHAEL A., (U.S. CLS. 22 AND 39). SN 76-233,141. PUB. 2-26-2002. FILED 4-2-2001.
 2,571,259. **RIDERS**. H.D. LEE COMPANY, INC., THE, (U.S. CLS. 22 AND 39). SN 76-242,802. PUB. 2-26-2002. FILED 4-18-2001.
 2,571,260. **CURVY REVOLUTION**. SIZE APPEAL, INC., (U.S. CLS. 22 AND 39). SN 76-243,161. PUB. 2-26-2002. FILED 4-19-2001.

2,571,285 (*See Class 9 for this trademark*).
 2,571,292. **SCRUFFY DUFFYS**. EIGHTH AVE TAVERN, INC., (U.S. CLS. 22 AND 39). SN 76-258,340. PUB. 2-26-2002. FILED 5-17-2001.
 2,571,294. **SUPP-SOCKS**. KAYSER-ROTH CORPORATION, (U.S. CLS. 22 AND 39). SN 76-258,537. PUB. 2-26-2002. FILED 5-17-2001.
 2,571,305. **RONALD VAN DER KEMP**. VAN DER KEMP, RONALD, (U.S. CLS. 22 AND 39). SN 76-262,043. PUB. 2-26-2002. FILED 5-25-2001.
 2,571,314. **DRI-FIT**. NIKE, INC., MULTIPLE CLASS, (INT. CLS. 25 AND 28), (U.S. CLS. 22, 23, 38, 39 AND 50). SN 76-266,328. PUB. 2-26-2002. FILED 6-4-2001.
 2,571,325. **PGA WEST**. PROFESSIONAL GOLFERS' ASSOCIATION OF AMERICA, THE, MULTIPLE CLASS, (INT. CLS. 25, 28, 36 AND 41), (U.S. CLS. 22, 23, 38, 39, 50, 100, 101, 102 AND 107). SN 76-269,788. PUB. 2-26-2002. FILED 6-8-2001.
 2,571,331. **LIFE**. ANGELICA CORPORATION, (U.S. CLS. 22 AND 39). SN 76-272,870. PUB. 2-26-2002. FILED 6-18-2001.
 2,571,332. **MISCELLANEOUS DESIGN**. OPTION-NFA INC., MULTIPLE CLASS, (INT. CLS. 25 AND 28), (U.S. CLS. 22, 23, 38, 39 AND 50). SN 76-273,336. PUB. 2-26-2002. FILED 6-19-2001.
 2,571,343. **BATTLESTAR**. PECK, VICTOR H. JR., (U.S. CLS. 22 AND 39). SN 76-277,213. PUB. 2-26-2002. FILED 6-27-2001.
 2,571,350. **ADRENALINE JOE AND DESIGN**. ADRENALINE JOE AGGRESSIVE SPORTSWEAR, (U.S. CLS. 22 AND 39). SN 76-281,426. PUB. 2-26-2002. FILED 7-6-2001.
 2,571,351. **SOCA WEAR, INC.**, SOCA WEAR, INC., (U.S. CLS. 22 AND 39). SN 76-281,743. PUB. 2-26-2002. FILED 7-9-2001.
 2,571,382. **WALLS**. WALLS INDUSTRIES, INC., (U.S. CLS. 22 AND 39). SN 76-296,714. PUB. 2-26-2002. FILED 8-7-2001.
 2,571,401. **BABY YAK**. MAKALU, INC., (U.S. CLS. 22 AND 39). SN 76-308,469. PUB. 2-26-2002. FILED 8-31-2001.
 2,571,405. **CRUSTACEAN CELEBRATION**. CRAWFORD, DAVID, DBA MODEL TEES, (U.S. CLS. 22 AND 39). SN 76-309,629. PUB. 2-26-2002. FILED 9-5-2001.
 2,571,410 (*See Class 16 for this trademark*).
 2,571,416. **MOOSE CREEK**. JUNO OF CALIFORNIA, (U.S. CLS. 22 AND 39). SN 76-312,217. PUB. 2-26-2002. FILED 9-14-2001.
 2,571,465. **PNEUMA**. BENTZ, WILLIAM, (U.S. CLS. 22 AND 39). SN 76-320,798. PUB. 2-26-2002. FILED 10-4-2001.
 2,571,472. **JZR 77**. MEN'S PLACE INC., (U.S. CLS. 22 AND 39). SN 76-322,409. PUB. 2-26-2002. FILED 10-9-2001.
 2,571,480. **TOP BRASS**. LIBERTY UNIFORM MANUFACTURING CO., INC., (U.S. CLS. 22 AND 39). SN 76-325,231. PUB. 2-26-2002. FILED 10-15-2001.
 2,571,482. **CPC AND DESIGN**. CYPRESS POINT CLUB, MULTIPLE CLASS, (INT. CLS. 25 AND 41), (U.S. CLS. 22, 39, 100, 101 AND 107). SN 76-325,494. PUB. 2-26-2002. FILED 10-15-2001.
 2,571,490. **JFF (STYLIZED)**. NEVADA FEET, INC., (U.S. CLS. 22 AND 39). SN 76-328,232. PUB. 2-26-2002. FILED 10-22-2001.
 2,571,498. **THE HEMP SEED**. MARDELL, STEVEN DAVID, (U.S. CLS. 22 AND 39). SN 78-021,471. PUB. 2-26-2002. FILED 8-16-2000.
 2,571,547. **FLYING FISH BREWING CO. AND DESIGN**. FLYING FISH BREWING CO., LLC, MULTIPLE CLASS, (INT. CLS. 25 AND 32), (U.S. CLS. 22, 39, 45, 46 AND 48). SN 78-037,016. PUB. 2-26-2002. FILED 11-29-2000.
 2,571,560. **TO BE FASHION ACTION AND DESIGN**. RODRIGUEZ, MIGUEL ANGEL, (U.S. CLS. 22 AND 39). SN 78-040,305. PUB. 2-26-2002. FILED 12-21-2000.
 2,571,567. **SCOPE-REST AND DESIGN**. INGOLD, JAMES EDWARD, JR., (U.S. CLS. 22 AND 39). SN 78-043,138. PUB. 2-26-2002. FILED 1-14-2001.
 2,571,582. **COURTESY SLIPPERS (STYLIZED)**. INTERNATIONAL COMMERCE ONLINE NETWORK, LLC., (U.S. CLS. 22 AND 39). SN 78-047,071. PUB. 2-26-2002. FILED 2-7-2001.
 2,571,651. **OLDSTONE AND DESIGN**. GRUPPO CAVALLINO, INC., (U.S. CLS. 22 AND 39). SN 78-073,193. PUB. 2-26-2002. FILED 7-10-2001.
 2,571,664. **BREAKWATER AT ALL TIMES LIGHT, BUOYANT, & RELIABLE**. AND DESIGN. VIEWPOINT INTERNA-

TIONAL, INC., (U.S. CLS. 22 AND 39). SN 78-076,577. PUB. 2-26-2002. FILED 7-31-2001.
 2,571,665. **BREAKWATER AND DESIGN**. VIEWPOINT INTERNATIONAL, INC., (U.S. CLS. 22 AND 39). SN 78-076,589. PUB. 2-26-2002. FILED 7-31-2001.

CLASS 26—FANCY GOODS

2,570,754 (*See Class 7 for this trademark*).
 2,570,772. **ELVES AT WORK**. OLD TIME POTTERY, INC., (U.S. CLS. 37, 39, 40, 42 AND 50). SN 76-017,351. PUB. 2-26-2002. FILED 4-4-2000.
 2,570,823. **VELCRO**. VELCRO INDUSTRIES B.V., (U.S. CLS. 37, 39, 40, 42 AND 50). SN 76-053,402. PUB. 2-26-2002. FILED 5-19-2000.
 2,571,098. **SENSUAL COLLECTION AND DESIGN**. NU PERFECT, INC., (U.S. CLS. 37, 39, 40, 42 AND 50). SN 76-160,231. PUB. 2-26-2002. FILED 9-27-2000.
 2,571,359. **LION BUTTON**. L.G. LION & CO., INC., (U.S. CLS. 37, 39, 40, 42 AND 50). SN 76-284,013. PUB. 2-26-2002. FILED 7-9-2001.
 2,571,360. **CARIBE BUTTON**. L.G. LION & CO., INC., (U.S. CLS. 37, 39, 40, 42 AND 50). SN 76-284,014. PUB. 2-26-2002. FILED 7-9-2001.
 2,571,459. **YM. GRUNER + JAHR PRINTING & PUBLISHING CO.**, (U.S. CLS. 37, 39, 40, 42 AND 50). SN 76-319,972. PUB. 2-26-2002. FILED 10-1-2001.
 2,571,488 (*See Class 14 for this trademark*).

CLASS 27—FLOOR COVERINGS

2,570,490 (*See Class 3 for this trademark*).
 2,570,698. **REVIVE**. BEAULIEU GROUP, LLC, (U.S. CLS. 19, 20, 37, 42 AND 50). SN 75-877,552. PUB. 6-26-2001. FILED 12-22-1999.
 2,570,758. **ANSO CARESS**. HONEYWELL INTERNATIONAL INC., (U.S. CLS. 19, 20, 37, 42 AND 50). SN 76-002,993. PUB. 2-26-2002. FILED 3-17-2000.
 2,571,526. **MY WALL GRAPHICS AND DESIGN**. KARBACH HOLDINGS CORPORATION, (U.S. CLS. 19, 20, 37, 42 AND 50). SN 78-032,312. PUB. 2-26-2002. FILED 10-25-2000.

CLASS 28—TOYS AND SPORTING GOODS

2,570,490 (*See Class 3 for this trademark*).
 2,570,500. **MISCELLANEOUS DESIGN**. EBSCO INDUSTRIES, INC., (U.S. CLS. 22, 23, 38 AND 50). SN 75-273,739. PUB. 10-27-1998. FILED 4-14-1997.
 2,570,547 (*See Class 9 for this trademark*).
 2,570,598 (*See Class 18 for this trademark*).
 2,570,599 (*See Class 15 for this trademark*).
 2,570,605. **PILATES ALLEGRO**. BALANCED BODY, INC., (U.S. CLS. 22, 23, 38 AND 50). SN 75-721,390. PUB. 2-26-2002. FILED 6-2-1999.
 2,570,637. **FITAK'S PAPER MAGIC AND DESIGN**. PRINCIPIA ENTERPRISES CORPORATION, (U.S. CLS. 22, 23, 38 AND 50). SN 75-782,068. PUB. 8-7-2001. FILED 10-30-1999.
 2,570,651. **JP AUSTRALIA AND DESIGN**. POLAKOW, JASON NICHOLAS, (U.S. CLS. 22, 23, 38 AND 50). SN 75-806,466. PUB. 7-10-2001. FILED 9-22-1999.
 2,570,668. **MILOSPORT**. CRE MANAGEMENT, LC, DBA MILOSPORT, (U.S. CLS. 22, 23, 38 AND 50). SN 75-839,038. PUB. 2-26-2002. FILED 11-1-1999.
 2,570,691 (*See Class 12 for this trademark*).
 2,570,732. **WATER WIGGLIES**. PLAY VISIONS, INC., (U.S. CLS. 22, 23, 38 AND 50). SN 75-928,958. PUB. 2-26-2002. FILED 2-28-2000.
 2,570,815. **SNAP SHOT**. MERIT INDUSTRIES, INC., (U.S. CLS. 22, 23, 38 AND 50). SN 76-049,952. PUB. 2-26-2002. FILED 5-17-2000.
 2,570,820 (*See Class 18 for this trademark*).

2,570,825. **NYLINT REAL TOYS FOR REAL KIDS SINCE 1946 BRAND AND DESIGN.** NYLINT CORPORATION, (U.S. CLS. 22, 23, 38 AND 50). SN 76-054,075. PUB. 2-26-2002. FILED 5-23-2000.
 2,570,905 (*See Class 9 for this trademark.*)
 2,570,906 (*See Class 9 for this trademark.*)
 2,570,959. **MIKE MULLIGAN AND HIS STEAM SHOVEL.** HOUGHTON MIFFLIN COMPANY, (U.S. CLS. 22, 23, 38 AND 50). SN 76-110,558. PUB. 2-26-2002. FILED 8-16-2000.
 2,570,967 (*See Class 16 for this trademark.*)
 2,570,974. **HAMMER STRENGTH (STYLIZED).** BRUNSWICK CORPORATION, (U.S. CLS. 22, 23, 38 AND 50). SN 76-116,442. PUB. 2-26-2002. FILED 8-25-2000.
 2,570,989. **MYBOT (STYLIZED).** KIRKBI AG, (U.S. CLS. 22, 23, 38 AND 50). SN 76-118,229. PUB. 2-26-2002. FILED 8-28-2000.
 2,571,037. **TRIPLE TRICK.** HEEP TUNG MANUFACTORY, LTD., (U.S. CLS. 22, 23, 38 AND 50). SN 76-134,449. PUB. 2-26-2002. FILED 9-25-2000.
 2,571,042 (*See Class 25 for this trademark.*)
 2,571,097. **WOOPY AND DESIGN.** REDER, MARIA H., (U.S. CLS. 22, 23, 38 AND 50). SN 76-160,146. PUB. 2-26-2002. FILED 11-7-2000.
 2,571,103. **ROBERTO.** MATTEL, INC., (U.S. CLS. 22, 23, 38 AND 50). SN 76-164,561. PUB. 2-26-2002. FILED 11-13-2000.
 2,571,120. **KRAZY KANDY.** IDEOPLASTOS, INC., FORMERLY PASTIME INDUSTRIES, INC., (U.S. CLS. 22, 23, 38 AND 50). SN 76-168,549. PUB. 2-26-2002. FILED 11-20-2000.
 2,571,122. **P.J. SWOOZLE'S AND DESIGN.** IDEOPLASTOS, INC., FORMERLY PASTIME INDUSTRIES, INC., (U.S. CLS. 22, 23, 38 AND 50). SN 76-168,943. PUB. 2-26-2002. FILED 11-20-2000.
 2,571,158. **DEAD ON.** DEAD ON TOOLS L.L.C., (U.S. CLS. 22, 23, 38 AND 50). SN 76-181,939. PUB. 2-26-2002. FILED 12-16-2000.
 2,571,160. **CHIP THE HACKER'S HECKLER.** GLOBE CORPORATION LIMITED, (U.S. CLS. 22, 23, 38 AND 50). SN 76-184,414. PUB. 2-26-2002. FILED 12-20-2000.
 2,571,162. **GIGGLIN' RING.** JAKKS PACIFIC, INC., (U.S. CLS. 22, 23, 38 AND 50). SN 76-186,167. PUB. 2-26-2002. FILED 12-26-2000.
 2,571,182 (*See Class 14 for this trademark.*)
 2,571,229. **JAN MCLEAN DESIGNS.** MCLEAN, JAN, TA JAN MCLEAN ORIGINALS, (U.S. CLS. 22, 23, 38 AND 50). SN 76-227,067. PUB. 2-26-2002. FILED 3-16-2001.
 2,571,304. **GOOD STUFF AND DESIGN.** GOOD STUFF L.L.C., (U.S. CLS. 22, 23, 38 AND 50). SN 76-261,872. PUB. 2-26-2002. FILED 5-25-2001.
 2,571,314 (*See Class 25 for this trademark.*)
 2,571,325 (*See Class 25 for this trademark.*)
 2,571,332 (*See Class 25 for this trademark.*)
 2,571,399. **SOX & MARTIN.** SOX, RONNIE, (U.S. CLS. 22, 23, 38 AND 50). SN 76-308,039. PUB. 2-26-2002. FILED 9-4-2001.
 2,571,404. **S TOW ABLE.** SWIMWAYS CORP., (U.S. CLS. 22, 23, 38 AND 50). SN 76-309,177. PUB. 2-26-2002. FILED 9-5-2001.
 2,571,406. **HYDRODISC.** SICURELLA, CHRISTOPHER T., (U.S. CLS. 22, 23, 38 AND 50). SN 76-310,149. PUB. 2-26-2002. FILED 9-7-2001.
 2,571,410 (*See Class 16 for this trademark.*)
 2,571,418. **PRELUDE.** PRO GOLF OF AMERICA, INC., (U.S. CLS. 22, 23, 38 AND 50). SN 76-312,335. PUB. 2-26-2002. FILED 9-10-2001.
 2,571,446. **COZMO.** COZMO WHEEL COMPANY PTY LIMITED, (U.S. CLS. 22, 23, 38 AND 50). SN 76-316,915. PUB. 2-26-2002. FILED 9-25-2001.
 2,571,554. **MISCELLANEOUS DESIGN.** BOB'S SPACE RACERS, INC., (U.S. CLS. 22, 23, 38 AND 50). SN 78-038,472. PUB. 2-26-2002. FILED 12-8-2000.
 2,571,596. **BIG LOAD.** SMART INDUSTRIES CORPORATION, (U.S. CLS. 22, 23, 38 AND 50). SN 78-050,481. PUB. 2-26-2002. FILED 2-27-2001.
 2,571,636. **ODYSSEY AND DESIGN.** CALLAWAY GOLF COMPANY, (U.S. CLS. 22, 23, 38 AND 50). SN 78-069,987. PUB. 2-26-2002. FILED 6-19-2001.
 2,571,675. **PUTTERS FROM HEAVEN.** MCDONOUGH, ROBERT A., DBA I.C.C., (U.S. CLS. 22, 23, 38 AND 50). SN 78-

083,270. PUB. 2-26-2002. FILED 9-10-2001.
 2,571,681. **COIL THE SPRINGY THINGY!** KATURA INCORPORATED, (U.S. CLS. 22, 23, 38 AND 50). SN 78-085,271. PUB. 2-26-2002. FILED 9-24-2001.

CLASS 29—MEATS AND PROCESSED FOODS

2,570,490 (*See Class 3 for this trademark.*)
 2,570,616. **SAMSFISH AND DESIGN.** SAMSUNG CORPORATION, (U.S. CL. 46). SN 75-741,853. PUB. 9-4-2001. FILED 6-23-1999.
 2,570,644. **KUDU AND DESIGN.** KUDU COMPANY FOR FOOD & CATERING, (U.S. CL. 46). SN 75-796,022. PUB. 6-26-2001. FILED 9-10-1999.
 2,570,660. **KING HENRY'S AND DESIGN.** KING HENRY'S, INC., MULTIPLE CLASS, (INT. CLS. 29, 30 AND 31), (U.S. CLS. 1 AND 46). SN 75-821,249. PUB. 2-26-2002. FILED 10-12-1999.
 2,570,717. **ALCISA AND DESIGN.** ALCISA S.P.A., (U.S. CL. 46). SN 75-911,588. PUB. 11-20-2001. FILED 2-3-2000.
 2,570,973. **OX HEAD BRAND AND DESIGN.** TAI FOONG INTERNATIONAL LTD., (U.S. CL. 46). SN 76-116,220. PUB. 2-26-2002. FILED 8-24-2000.
 2,571,030. **SUKOBI.** NAKAMURA, MICHAEL TOSHIO, (U.S. CL. 46). SN 76-133,333. PUB. 2-26-2002. FILED 9-19-2000.
 2,571,039. **"OUR PRODUCTS MAKE THE DIFFERENCE" (STYLIZED).** CAPE MAY FOODS, INC., (U.S. CL. 46). SN 76-135,419. PUB. 2-26-2002. FILED 9-27-2000.
 2,571,136. **FARMER JOHN FAMILY OWNED SINCE 1931 AND DESIGN.** CLOUGHERTY PACKING COMPANY, (U.S. CL. 46). SN 76-171,928. PUB. 2-26-2002. FILED 11-28-2000.
 2,571,173. **MASSEY'S PIZZA.** PREMIER BROADCASTING COMPANY, INC., MULTIPLE CLASS, (INT. CLS. 29, 30 AND 42), (U.S. CLS. 46, 100 AND 101). SN 76-193,888. PUB. 2-26-2002. FILED 1-16-2001.
 2,571,243. **B (STYLIZED).** BLUECADIA AQUACULTURE INC., (U.S. CL. 46). SN 76-235,411. PUB. 2-26-2002. FILED 4-4-2001.
 2,571,506. **SPRINGBROOK FARMS.** SARAMAR, L.L.C., (U.S. CL. 46). SN 78-026,087. PUB. 2-26-2002. FILED 9-15-2000.
 2,571,509. **THIS CAN'T BE SOY!** GOODMANSON, DEBRA, (U.S. CL. 46). SN 78-026,836. PUB. 2-26-2002. FILED 9-20-2000.
 2,571,594. **MISCELLANEOUS DESIGN.** AVIKO USA, LLC, (U.S. CL. 46). SN 78-050,351. PUB. 2-26-2002. FILED 2-26-2001.
 2,571,629. **LODGE LEGENDS.** TIMBER LODGE STEAKHOUSE, INC., MULTIPLE CLASS, (INT. CLS. 29 AND 30), (U.S. CL. 46). SN 78-064,162. PUB. 2-26-2002. FILED 5-17-2001.

CLASS 30—STAPLE FOODS

2,570,490 (*See Class 3 for this trademark.*)
 2,570,491. **FAIRMOUNT BAGEL AND DESIGN.** FAIRMOUNT BAGEL BAKERY INC., MULTIPLE CLASS, (INT. CLS. 30 AND 35), (U.S. CLS. 46, 100, 101 AND 102). SN 75-203,775. PUB. 6-20-2000. FILED 11-25-1996.
 2,570,507. **CARIBBEAN SPRAY.** 329985 ONTARIO LIMITED, DBA KISKO PRODUCTS, MULTIPLE CLASS, (INT. CLS. 30 AND 32), (U.S. CLS. 45, 46 AND 48). SN 75-340,408. PUB. 5-1-2001. FILED 8-13-1997.
 2,570,510. **KORNSPITZ.** ALOIS AUGENDOPLER GESELLSCHAFT M.B.H., (U.S. CL. 46). SN 75-352,563. PUB. 6-29-1999. FILED 9-5-1997.
 2,570,521. **MISCELLANEOUS DESIGN.** UNCLE WAFFLES, LTD., MULTIPLE CLASS, (INT. CLS. 30 AND 42), (U.S. CLS. 46, 100 AND 101). SN 75-421,187. PUB. 2-20-2001. FILED 1-21-1998.
 2,570,546. **MISCELLANEOUS DESIGN.** CHEF AMERICA, INC., (U.S. CL. 46). SN 75-546,673. PUB. 5-4-1999. FILED 9-2-1998.

- 2,570,579. **SONRITOS**. MCLANE COMPANY, INC., (U.S. CL. 46). SN 75-639,925. PUB. 9-28-1999. FILED 2-12-1999.
- 2,570,592. **PACIFIC FLAVOR**. BTK INTERNATIONAL, INC., (U.S. CL. 46). SN 75-678,154. PUB. 2-26-2002. FILED 4-9-1999.
- 2,570,647. **OSKER'S**. OSKER'S, (U.S. CL. 46). SN 75-800,838. PUB. 11-6-2001. FILED 9-14-1999.
- 2,570,650. **MISCELLANEOUS DESIGN**. HOWDY JONGRO KIMBAP INTERNATIONAL, INC., MULTIPLE CLASS, (INT. CLS. 30 AND 42), (U.S. CLS. 46, 100 AND 101). SN 75-803,497. PUB. 2-26-2002. FILED 9-20-1999.
- 2,570,660 (*See Class 29 for this trademark*).
- 2,570,735. **SINAMAR**. HEINZ WEYERMANN ROSATMALZ-BIEBRAUEREI BAMBERG GESELLSCHAFT MIT BERSCHRANKTER HAFTUNG, BY CHANGE OF NAME HEINZ WEYERMANN GMBH FARBMALZBIERBRAUEREI, (U.S. CL. 46). SN 75-929,747. PUB. 2-26-2002. FILED 2-29-2000.
- 2,570,759. **ATLANTIC CITY TEA**. GRANICK ENTERPRISES, INC., (U.S. CL. 46). SN 76-003,620. PUB. 2-26-2002. FILED 3-17-2000.
- 2,570,881. **DARK DELUXE**. WORLD'S FINEST CHOCOLATE, INC., (U.S. CL. 46). SN 76-079,723. PUB. 2-26-2002. FILED 6-28-2000.
- 2,570,889. **3 BALLERINA**. TRUONG GIANG CORPORATION, (U.S. CL. 46). SN 76-081,514. PUB. 12-18-2001. FILED 6-29-2000.
- 2,570,927. **BRENDA'S BEST**. J&J SNACK FOODS CORP., (U.S. CL. 46). SN 76-096,613. PUB. 2-26-2002. FILED 7-26-2000.
- 2,570,943. **NEW YORK, TEXAS, CHEESECAKE**. EQUIPMAX, INC., (U.S. CL. 46). SN 76-102,731. PUB. 2-26-2002. FILED 8-4-2000.
- 2,570,972. **OX HEAD BRAND AND DESIGN**. TAI FOONG INTERNATIONAL LTD., (U.S. CL. 46). SN 76-116,219. PUB. 2-26-2002. FILED 8-24-2000.
- 2,570,995. **THE COMMON MARKET TRADING CO. AND DESIGN**. MCDONALD, GREG, (U.S. CL. 46). SN 76-119,952. PUB. 2-26-2002. FILED 8-29-2000.
- 2,571,071. **OATSCREME**. AMERICAN OATS, INC., (U.S. CL. 46). SN 76-149,087. PUB. 11-20-2001. FILED 10-18-2000.
- 2,571,095. **H&H MIDTOWN BAGELS EAST**. PV BAKERY INC., DBA H&H MIDTOWN BAGELS EAST, MULTIPLE CLASS, (INT. CLS. 30 AND 42), (U.S. CLS. 46, 100 AND 101). SN 76-160,027. PUB. 2-26-2002. FILED 11-6-2000.
- 2,571,148 (*See Class 25 for this trademark*).
- 2,571,173 (*See Class 29 for this trademark*).
- 2,571,227. **EMBLEM**. MENNEL MILLING COMPANY, THE, (U.S. CL. 46). SN 76-226,834. PUB. 2-26-2002. FILED 3-20-2001.
- 2,571,291 (*See Class 21 for this trademark*).
- 2,571,326 (*See Class 1 for this trademark*).
- 2,571,503. **THE GUYS WITH A PEEL**. GRANIX TEAM, INC., (U.S. CL. 46). SN 78-025,166. PUB. 2-26-2002. FILED 9-9-2000.
- 2,571,510. **INTERNATIONAL CLASSICS**. RALPHS GROCERY COMPANY, (U.S. CL. 46). SN 78-027,331. PUB. 2-26-2002. FILED 9-22-2000.
- 2,571,629 (*See Class 29 for this trademark*).
- 2,571,632. **MISCELLANEOUS DESIGN**. FERRARA PAN CANDY CO., INC., (U.S. CL. 46). SN 78-067,839. PUB. 2-26-2002. FILED 6-7-2001.
- 2,571,680. **MR. GREEN BEANS**. GOLDSTEIN, HOWARD, J., (U.S. CL. 46). SN 78-085,092. PUB. 2-26-2002. FILED 9-22-2001.

CLASS 31—NATURAL AGRICULTURAL PRODUCTS

- 2,570,660 (*See Class 29 for this trademark*).
- 2,570,750. **FUN BUNCH**. J & J RANCH PRODUCE, INC., (U.S. CLS. 1 AND 46). SN 75-955,883. PUB. 2-26-2002. FILED 3-10-2000.
- 2,571,195. **MISCELLANEOUS DESIGN**. CHEF'S GARDEN, INC., THE, MULTIPLE CLASS, (INT. CLS. 31, 35 AND 42), (U.S. CLS. 1, 46, 100, 101 AND 102). SN 76-214,862. PUB. 2-26-2002. FILED 2-23-2001.
- 2,571,207. **FELINE FANTASIA**. FOSTER & SMITH, INC., (U.S. CLS. 1 AND 46). SN 76-221,196. PUB. 2-26-2002. FILED 3-7-

- 2001.
- 2,571,656. **TOMBOY**. HI-TEK RATIONS, INC., (U.S. CLS. 1 AND 46). SN 78-075,654. PUB. 12-25-2001. FILED 7-25-2001.

CLASS 32—LIGHT BEVERAGES

- 2,570,507 (*See Class 30 for this trademark*).
- 2,570,508. **MISCELLANEOUS DESIGN**. KOPPARBERGS BRYGGERI AB, MULTIPLE CLASS, (INT. CLS. 32 AND 33), (U.S. CLS. 45, 46, 47, 48 AND 49). SN 75-349,544. PUB. 2-26-2002. FILED 8-29-1997.
- 2,570,883. **HOWLOWEEN**. ANHEUSER-BUSCH, INCORPORATED, (U.S. CLS. 45, 46 AND 48). SN 76-080,031. PUB. 12-4-2001. FILED 6-29-2000.
- 2,571,432. **BLACK JACK STOUT**. DUCLAW BREWERY, LLC, (U.S. CLS. 45, 46 AND 48). SN 76-314,730. PUB. 2-26-2002. FILED 9-20-2001.
- 2,571,433. **DEVIL'S MILK BARLEY WINE**. DUCLAW BREWERY, LLC, (U.S. CLS. 45, 46 AND 48). SN 76-314,731. PUB. 2-26-2002. FILED 9-20-2001.
- 2,571,434. **SAWTOOTH**. DUCLAW BREWERY, LLC, (U.S. CLS. 45, 46 AND 48). SN 76-314,732. PUB. 2-26-2002. FILED 9-20-2001.
- 2,571,435. **MAD BISHOP**. DUCLAW BREWERY, LLC, (U.S. CLS. 45, 46 AND 48). SN 76-314,960. PUB. 2-26-2002. FILED 9-20-2001.
- 2,571,438. **OLD HORIZONTAL**. VICTORY BREWING COMPANY, (U.S. CLS. 45, 46 AND 48). SN 76-316,112. PUB. 2-26-2002. FILED 9-24-2001.
- 2,571,439. **STORM KING**. VICTORY BREWING COMPANY, (U.S. CLS. 45, 46 AND 48). SN 76-316,113. PUB. 2-26-2002. FILED 9-24-2001.
- 2,571,440. **GOLDEN MONKEY**. VICTORY BREWING COMPANY, (U.S. CLS. 45, 46 AND 48). SN 76-316,115. PUB. 2-26-2002. FILED 9-24-2001.
- 2,571,442. **MISCELLANEOUS DESIGN**. SPOETZL BREWERY, INC., (U.S. CLS. 45, 46 AND 48). SN 76-316,239. PUB. 2-26-2002. FILED 9-24-2001.
- 2,571,547 (*See Class 25 for this trademark*).
- 2,571,622. **ELYSIAN BREWING COMPANY AND DESIGN**. ELYSIAN BREWING COMPANY, INC, (U.S. CLS. 45, 46 AND 48). SN 78-060,700. PUB. 2-26-2002. FILED 4-26-2001.

CLASS 33—WINES AND SPIRITS

- 2,570,508 (*See Class 32 for this trademark*).
- 2,570,634. **DB DOMAINE BOYAR AND DESIGN**. DOMAINE BOYAR AD, (U.S. CLS. 47 AND 49). SN 75-778,516. PUB. 9-12-2000. FILED 8-19-1999.
- 2,570,684. **RHEINPRINZ**. REH KENDERMANN GMBH WEINKELLEREI, (U.S. CLS. 47 AND 49). SN 75-864,637. PUB. 7-17-2001. FILED 12-6-1999.
- 2,570,718. **KRIS**. FRANZ HAAS S.R.L., (U.S. CLS. 47 AND 49). SN 75-911,950. PUB. 11-13-2001. FILED 2-8-2000.
- 2,570,731. **YALDARA**. CHATEAU YALDARA PTY LIMITED, (U.S. CLS. 47 AND 49). SN 75-928,603. PUB. 11-7-2000. FILED 2-28-2000.
- 2,570,780. **OASIS**. OASIS VINEYARD, INC., (U.S. CLS. 47 AND 49). SN 76-022,135. PUB. 2-26-2002. FILED 4-10-2000.
- 2,570,913. **GAUDIUM AND DESIGN**. UNION VITIVINICOLA, S.A. VINEDOS EN CENICERO, (U.S. CLS. 47 AND 49). SN 76-091,719. PUB. 2-26-2002. FILED 7-19-2000.
- 2,570,933. **MAPLE RIDGE**. AMERIVINE, INC., (U.S. CLS. 47 AND 49). SN 76-099,165. PUB. 2-26-2002. FILED 7-28-2000.
- 2,571,048. **HANA BAY**. HAWAIIAN RECTIFIERS, INC., (U.S. CLS. 47 AND 49). SN 76-139,703. PUB. 2-26-2002. FILED 10-3-2000.
- 2,571,077. **BONORLI**. GRUPPO ITALIANO VINI S.C.A.R.L., (U.S. CLS. 47 AND 49). SN 76-151,824. PUB. 2-26-2002. FILED 10-23-2000.
- 2,571,187. **LONGORIA**. LONGORIA, RICHARD, (U.S. CLS. 47 AND 49). SN 76-210,169. PUB. 2-26-2002. FILED 2-15-2001.

CLASS 34—SMOKERS' ARTICLES

- 2,570,586. **1968 C.A.O.1998 L'ANNIVERSAIRE**. C.A.O. INTERNATIONAL, INC., (U.S. CLS. 2, 8, 9 AND 17). SN 75-666,381. PUB. 8-28-2001. FILED 3-23-1999.
- 2,570,942. **ZA (STYLIZED)**. INDUSTRIA DE DISENO TEXTIL, S.A., AKA INDITEX, S.A., (U.S. CLS. 2, 8, 9 AND 17). SN 76-102,289. PUB. 2-26-2002. FILED 8-1-2000.
- 2,571,297. **CAVIFLEX**. BAUMGARTNER PAPIERS S.A., (U.S. CLS. 2, 8, 9 AND 17). SN 76-260,870. PUB. 2-26-2002. FILED 5-23-2001.
- 2,571,298. **CAVITEC**. BAUMGARTNER PAPIERS S.A., (U.S. CLS. 2, 8, 9 AND 17). SN 76-260,871. PUB. 2-26-2002. FILED 5-23-2001.

SERVICE MARKS
CLASS 35—ADVERTISING AND BUSINESS

- 2,570,486. **MISCELLANEOUS DESIGN**. BP AMOCO P.L.C., BY CHANGE OF NAME BRITISH PETROLEUM COMPANY P.L.C., THE, MULTIPLE CLASS, (INT. CLS. 35 AND 37), (U.S. CLS. 100, 101, 102, 103 AND 106). SN 75-026,517. PUB. 8-8-2000. FILED 12-1-1995.
- 2,570,491 (*See Class 30 for this trademark*).
- 2,570,494. **TIVOLI**. A/S KJOBENHAVNS SOMMER-TIVOLI, MULTIPLE CLASS, (INT. CLS. 35, 41 AND 42), (U.S. CLS. 100, 101, 102 AND 107). SN 75-232,696. PUB. 12-22-1998. FILED 1-28-1997.
- 2,570,501. **VISITORS CHOICE AWARDS**. WHERE INTERNATIONAL L.P., ASSIGNEE OF; ASSIGNEE OF; ASSIGNEE OF WHERE SOUTH CORPORATION, MULTIPLE CLASS, (INT. CLS. 35 AND 41), (U.S. CLS. 100, 101, 102 AND 107). SN 75-286,371. PUB. 10-23-2001. FILED 5-5-1997.
- 2,570,513. **COUNTRY GARDENS**. COUNTRY GARDENS, INC., MULTIPLE CLASS, (INT. CLS. 35 AND 42), (U.S. CLS. 100, 101 AND 102). SN 75-378,033. PUB. 2-26-2002. FILED 10-23-1997.
- 2,570,520. **YOUR HOME STYLE**. BEAULIEU CANADA COMPANY, BY CHANGE OF NAME; BY ASSIGNMENT PEERLESS CARPET CORPORATION, (U.S. CLS. 100, 101 AND 102). SN 75-417,465. PUB. 2-26-2002. FILED 1-13-1998.
- 2,570,533 (*See Class 9 for this trademark*).
- 2,570,538. **STOREFRONTS@FLEET AND DESIGN**. FLEET-BOSTON FINANCIAL CORPORATION, BY MERGER; BY CHANGE OF NAME FLEET FINANCIAL GROUP, INC., MULTIPLE CLASS, (INT. CLS. 35 AND 42), (U.S. CLS. 100, 101 AND 102). SN 75-506,340. PUB. 10-2-2001. FILED 6-22-1998.
- 2,570,540. **ENTERTECH**. INTERNATIONAL DATA GROUP, INC., (U.S. CLS. 100, 101 AND 102). SN 75-518,689. PUB. 7-25-2000. FILED 7-14-1998.
- 2,570,549. **ARTICLES**. HOMEMAKERS, THE, MULTIPLE CLASS, (INT. CLS. 35, 36 AND 42), (U.S. CLS. 100, 101 AND 102). SN 75-568,332. PUB. 2-26-2002. FILED 10-9-1998.
- 2,570,550. **COOKIE KUDOS**. MGW GROUP, INC., (U.S. CLS. 100, 101 AND 102). SN 75-571,483. PUB. 9-5-2000. FILED 10-19-1998.
- 2,570,552. **BOOLEAN.NET**. NET BOOLEAN INCORPORATED, (U.S. CLS. 100, 101 AND 102). SN 75-582,023. PUB. 2-26-2002. FILED 11-3-1998.
- 2,570,563. **QVF QUALITY VALUE FUN BIG DOGS AND DESIGN**. BIG DOG HOLDINGS, INC., (U.S. CLS. 100, 101 AND 102). SN 75-606,237. PUB. 2-6-2001. FILED 12-15-1998.
- 2,570,574. **KIDGENIUS**. KIDGENIUS COMPANY, THE, (U.S. CLS. 100, 101 AND 102). SN 75-613,074. PUB. 2-26-2002. FILED 12-29-1998.
- 2,570,575. **P3M AND DESIGN**. P3M, INC., (U.S. CLS. 100, 101 AND 102). SN 75-614,619. PUB. 5-23-2000. FILED 1-4-1999.
- 2,570,583. **WARPED SPORTZ**. APEX THERMOGRAPHERS INC., (U.S. CLS. 100, 101 AND 102). SN 75-659,866. PUB. 9-11-2001. FILED 3-17-1999.
- 2,570,585. **AUTOTOYS.COM**. SOUND CONCEPTIONS, INC., (U.S. CLS. 100, 101 AND 102). SN 75-664,180. PUB. 7-17-2001. FILED 3-19-1999.
- 2,570,596. **TECHNOHEDGE**. GESTION TECHNOCAP INC., MULTIPLE CLASS, (INT. CLS. 35 AND 36), (U.S. CLS. 100, 101 AND 102). SN 75-684,010. PUB. 9-4-2001. FILED 4-16-1999.
- 2,570,601. **HOMEID.COM**. LARRY LATHAM AUCTIONEERS, INC., (U.S. CLS. 100, 101 AND 102). SN 75-703,661. PUB. 6-19-2001. FILED 8-14-1998.
- 2,570,602. **PREMIER**. PREMIER FOODSERVICE DISTRIBUTORS OF AMERICA, INC., (U.S. CLS. 100, 101 AND 102). SN 75-707,939. PUB. 5-15-2001. FILED 5-18-1999.
- 2,570,604. **BAYAT (STYLIZED)**. BAT ACQUISITION, LLC, BY ASSIGNMENT BAY ADVANCED TECHNOLOGIES, INC., MULTIPLE CLASS, (INT. CLS. 35 AND 40), (U.S. CLS. 100, 101, 102, 103 AND 106). SN 75-719,176. PUB. 2-26-2002. FILED 6-1-1999.
- 2,570,612. **VQ VEN QUEST HOTEL GROUP AND DESIGN**. PACIFIC COAST REALTY SERVICES, INC., (U.S. CLS. 100, 101 AND 102). SN 75-738,192. PUB. 2-26-2002. FILED 6-28-1999.
- 2,570,614. **! AND DESIGN**. TURNER DUCKWORTH, LLC, MULTIPLE CLASS, (INT. CLS. 35 AND 42), (U.S. CLS. 100, 101 AND 102). SN 75-740,048. PUB. 2-26-2002. FILED 7-22-1999.
- 2,570,621. **THE PATHFINDER CONSULTING GROUP, LLC, AND DESIGN**. PATHFINDER CONSULTING GROUP, LLC, THE, (U.S. CLS. 100, 101 AND 102). SN 75-759,626. PUB. 10-16-2001. FILED 7-22-1999.
- 2,570,622. **VERISTORE**. VERIDA INTERNET CORP., MULTIPLE CLASS, (INT. CLS. 35, 36 AND 42), (U.S. CLS. 100, 101 AND 102). SN 75-761,963. PUB. 6-12-2001. FILED 7-27-1999.
- 2,570,623. **NHRA PROPERTIES**. NATIONAL HOT ROD ASSOCIATION (AKA NHRA), (U.S. CLS. 100, 101 AND 102). SN 75-764,516. PUB. 2-26-2002. FILED 7-30-1999.
- 2,570,652. **IDEA: ITERATIVE DEVELOPMENT, EVALUATION, AND ANALYSIS**. ANYWHEREYOUGO.COM, INC., BY MERGER; BY CHANGE OF NAME PEOPLE DESIGN TECHNOLOGY, LLC, (U.S. CLS. 100, 101 AND 102). SN 75-813,403. PUB. 2-26-2002. FILED 10-4-1999.
- 2,570,657. **CRC CENTRE DE RESOLUTION DES CONFLITS CONFLICT RESOLUTION CENTER**. TIMSIT, JEAN, MULTIPLE CLASS, (INT. CLS. 35, 41 AND 42), (U.S. CLS. 100, 101, 102 AND 107). SN 75-819,153. PUB. 11-21-2000. FILED 10-8-1999.
- 2,570,659. **ZIP FREIGHT**. RENTRAK CORPORATION, MULTIPLE CLASS, (INT. CLS. 35 AND 39), (U.S. CLS. 100, 101, 102 AND 105). SN 75-819,566. PUB. 6-12-2001. FILED 10-12-1999.
- 2,570,669. **MAILSORT**. CONSIGNIA PLC., BY ASSIGNMENT POST OFFICE, THE, MULTIPLE CLASS, (INT. CLS. 35 AND 39), (U.S. CLS. 100, 101, 102 AND 105). SN 75-839,283. PUB. 5-1-2001. FILED 11-3-1999.
- 2,570,672. **MISCELLANEOUS DESIGN**. RED DOOR ANTIQUES, INC., (U.S. CLS. 100, 101 AND 102). SN 75-844,048. PUB. 2-26-2002. FILED 11-9-1999.
- 2,570,689. **BIGBIDDER.COM**. LFC INTERNET TECHNOLOGIES, INC., MULTIPLE CLASS, (INT. CLS. 35 AND 36), (U.S. CLS. 100, 101 AND 102). SN 75-868,517. PUB. 2-26-2002. FILED 12-9-1999.
- 2,570,693 (*See Class 9 for this trademark*).
- 2,570,703. **INFOTURN**. PRESS, GANEY ASSOCIATES, INC., MULTIPLE CLASS, (INT. CLS. 35 AND 42), (U.S. CLS. 100, 101 AND 102). SN 75-887,586. PUB. 8-7-2001. FILED 1-5-2000.
- 2,570,707 (*See Class 9 for this trademark*).
- 2,570,708. **THANKQ**. QUALITY STORES SERVICES, INC., BY ASSIGNMENT QUALITY STORES, INC., (U.S. CLS. 100, 101 AND 102). SN 75-898,209. PUB. 2-26-2002. FILED 1-17-2000.
- 2,570,722. **FIZGIG**. FIZGIG PRODUCTIONS, LLC, MULTIPLE CLASS, (INT. CLS. 35 AND 42), (U.S. CLS. 100, 101 AND 102). SN 75-919,497. PUB. 2-26-2002. FILED 2-15-2000.
- 2,570,724. **WALONG**. WALONG MARKETING, INC., (U.S. CLS. 100, 101 AND 102). SN 75-920,685. PUB. 2-26-2002. FILED 2-15-2000.
- 2,570,725. **SOS SPECIAL OFFSITE SERVICES, INC. AND DESIGN**. SPECIAL OFFSITE SERVICES, INC., (U.S. CLS. 100, 101 AND 102). SN 75-920,701. PUB. 2-26-2002. FILED 2-16-2000.
- 2,570,726. **E3WORLD.COM WE BRING CERTAINTY TO**

- INTERNATIONAL TRADE AND DESIGN.** E3WORLD-COM, INC., (U.S. CLS. 100, 101 AND 102). SN 75-920,715. PUB. 2-26-2002. FILED 2-16-2000.
- 2,570,738. **TELECOMPETITION.** TELECOMPETITION, INC., (U.S. CLS. 100, 101 AND 102). SN 75-937,303. PUB. 2-26-2002. FILED 3-7-2000.
- 2,570,744. **LIFETOUCH.** LIFETOUCH INC., (U.S. CLS. 100, 101 AND 102). SN 75-939,434. PUB. 10-23-2001. FILED 3-9-2000.
- 2,570,749. **CHEETAH LEARNING.** CHEETAH LEARNING LLC, (U.S. CLS. 100, 101 AND 102). SN 75-950,153. PUB. 9-11-2001. FILED 2-28-2000.
- 2,570,755. **BAMFLEX.** BAMFLEX.COM, INC., (U.S. CLS. 100, 101 AND 102). SN 76-000,264. PUB. 2-26-2002. FILED 3-14-2000.
- 2,570,762. **WISH.COM.** WISH SOLUTIONS, BY CHANGE OF NAME GIFTLOGIC.COM, INC., (U.S. CLS. 100, 101 AND 102). SN 76-007,287. PUB. 2-26-2002. FILED 3-22-2000.
- 2,570,779. **YARDCONNECT.COM.** PHYSICAL MARKET, INC., (U.S. CLS. 100, 101 AND 102). SN 76-021,818. PUB. 2-26-2002. FILED 4-7-2000.
- 2,570,783. **GLOBAL MEDIA PARTNER.** EMOTION, INC., MULTIPLE CLASS, (INT. CLS. 35 AND 39), (U.S. CLS. 100, 101, 102 AND 105). SN 76-023,803. PUB. 2-26-2002. FILED 4-13-2000.
- 2,570,785. **C.E.O.SPA.** C.E.O.SPA, LLC, (U.S. CLS. 100, 101 AND 102). SN 76-024,687. PUB. 2-26-2002. FILED 4-13-2000.
- 2,570,790. **LATA (STYLIZED).** LOS ALAMOS TECHNICAL ASSOCIATES, INC., MULTIPLE CLASS, (INT. CLS. 35, 37, 40 AND 42), (U.S. CLS. 100, 101, 102, 103 AND 106). SN 76-028,265. PUB. 2-26-2002. FILED 4-10-2000.
- 2,570,793 (*See Class 25 for this trademark.*)
- 2,570,802. **LEADING THE RESEARCH REVOLUTION.** GREENFIELD ONLINE, INC., (U.S. CLS. 100, 101 AND 102). SN 76-039,788. PUB. 2-26-2002. FILED 5-2-2000.
- 2,570,804. **TAIYI PRINTING AND DESIGN.** TAIYI PRINTING ENTERPRISE CO., LTD., (U.S. CLS. 100, 101 AND 102). SN 76-040,431. PUB. 2-26-2002. FILED 5-5-2000.
- 2,570,805. **REDEFINING THE BUSINESS OF MEDICINE.** LOJON, LLC, MULTIPLE CLASS, (INT. CLS. 35, 36 AND 42), (U.S. CLS. 100, 101 AND 102). SN 76-041,153. PUB. 2-26-2002. FILED 5-4-2000.
- 2,570,808. **WALKING COUNTS.** URBAN, ROBERT T., BY ASSIGNMENT URBAN, ROBERT T., MULTIPLE CLASS, (INT. CLS. 35 AND 41), (U.S. CLS. 100, 101, 102 AND 107). SN 76-044,569. PUB. 2-26-2002. FILED 5-9-2000.
- 2,570,810. **M AND DESIGN.** MERLE WOOD & ASSOCIATES, INC., MULTIPLE CLASS, (INT. CLS. 35, 36, 39 AND 42), (U.S. CLS. 100, 101, 102 AND 105). SN 76-046,647. PUB. 2-26-2002. FILED 5-11-2000.
- 2,570,814. **DECISION QUALITY ASSOCIATION.** SMARTORG, INC., BY ASSIGNMENT; BY ASSIGNMENT NAVIGANT CONSULTING, INC., (U.S. CLS. 100, 101 AND 102). SN 76-048,749. PUB. 2-26-2002. FILED 5-15-2000.
- 2,570,837. **WORKMENS (STYLIZED).** WORKMENS OUTLET, (U.S. CLS. 100, 101 AND 102). SN 76-059,875. PUB. 2-26-2002. FILED 5-31-2000.
- 2,570,845. **OXIS RESEARCH.** OXIS HEALTH PRODUCTS, INC., MULTIPLE CLASS, (INT. CLS. 35 AND 42), (U.S. CLS. 100, 101 AND 102). SN 76-066,857. PUB. 2-26-2002. FILED 6-9-2000.
- 2,570,847. **SERVISTREAM.** NATIONAL DISPATCH CENTER, INC., THE, (U.S. CLS. 100, 101 AND 102). SN 76-067,331. PUB. 9-11-2001. FILED 6-9-2000.
- 2,570,859. **:+ :- := :! AND DESIGN.** EPINIONS, INC., (U.S. CLS. 100, 101 AND 102). SN 76-072,943. PUB. 2-26-2002. FILED 6-19-2000.
- 2,570,863. **MENTALWEB.** MENTALWEB, INC., (U.S. CLS. 100, 101 AND 102). SN 76-074,368. PUB. 2-26-2002. FILED 6-21-2000.
- 2,570,868. **BUZZGROUPS.** MASSACHUSETTS ELECTRONIC COMMERCE ASSOCIATION, INC., (U.S. CLS. 100, 101 AND 102). SN 76-076,339. PUB. 2-26-2002. FILED 6-22-2000.
- 2,570,872. **BUZZLIST.** MASSACHUSETTS ELECTRONIC COMMERCE ASSOCIATION, INC., (U.S. CLS. 100, 101 AND 102). SN 76-077,441. PUB. 2-26-2002. FILED 6-22-2000.
- 2,570,873. **BUZZUPDATES.** MASSACHUSETTS ELECTRONIC COMMERCE ASSOCIATION, INC., (U.S. CLS. 100, 101 AND 102). SN 76-077,549. PUB. 2-26-2002. FILED 6-22-2000.
- 2,570,880. **CONSUMER LINK AND DESIGN.** BATES ADVERTISING USA, INC., (U.S. CLS. 100, 101 AND 102). SN 76-079,533. PUB. 2-26-2002. FILED 6-28-2000.
- 2,570,896. **SIR SPEEDY MYDOCS.** SIR SPEEDY, INC., MULTIPLE CLASS, (INT. CLS. 35 AND 42), (U.S. CLS. 100, 101 AND 102). SN 76-082,939. PUB. 10-9-2001. FILED 7-6-2000.
- 2,570,904. **WESTSIDE PUBLIC RELATIONS.** HARRIS, JAMES T., (U.S. CLS. 100, 101 AND 102). SN 76-087,267. PUB. 2-26-2002. FILED 7-13-2000.
- 2,570,912. **PACKAGING, PRICING AND PERFORMANCE YOU CAN TRUST-GUARANTEED.** VERIPACK.COM, INC., (U.S. CLS. 100, 101 AND 102). SN 76-091,709. PUB. 2-26-2002. FILED 7-19-2000.
- 2,570,929. **SMART BAGS.** ABUGHOSH, MUSA, (U.S. CLS. 100, 101 AND 102). SN 76-097,031. PUB. 2-26-2002. FILED 7-27-2000.
- 2,570,930. **TRACE WAREHOUSING AND DESIGN.** HOLLAND AMERICAN WAFER COMPANY, MULTIPLE CLASS, (INT. CLS. 35 AND 39), (U.S. CLS. 100, 101, 102 AND 105). SN 76-097,361. PUB. 2-26-2002. FILED 7-26-2000.
- 2,570,931. **MM AND DESIGN.** METAL MANAGEMENT, INC., MULTIPLE CLASS, (INT. CLS. 35, 37, 39, 40 AND 42), (U.S. CLS. 100, 101, 102, 103, 105 AND 106). SN 76-097,624. PUB. 2-26-2002. FILED 7-27-2000.
- 2,570,935. **MILLER STOCKMAN.** CORRAL WEST RANCHWEAR, INC., (U.S. CLS. 100, 101 AND 102). SN 76-100,336. PUB. 2-26-2002. FILED 7-31-2000.
- 2,570,940. **NBMBAA EMPLOYMENT NETWORK.** NATIONAL BLACK MBA ASSOCIATION, INC., (U.S. CLS. 100, 101 AND 102). SN 76-101,981. PUB. 2-26-2002. FILED 7-31-2000.
- 2,570,952. **NSC NATIONAL SERVICE CENTER AND DESIGN.** NATIONAL SERVICE CENTER, INC., MULTIPLE CLASS, (INT. CLS. 35 AND 37), (U.S. CLS. 100, 101, 102, 103 AND 106). SN 76-106,184. PUB. 2-26-2002. FILED 8-10-2000.
- 2,570,960. **AUDIO EXPRESS.** FREIGHT SALES, INC., (U.S. CLS. 100, 101 AND 102). SN 76-110,592. PUB. 2-26-2002. FILED 8-17-2000.
- 2,570,963. **ALL THAT MATTERS AND DESIGN.** WETTLAUER, JEANNE, MULTIPLE CLASS, (INT. CLS. 35, 41 AND 42), (U.S. CLS. 100, 101, 102 AND 107). SN 76-112,789. PUB. 2-26-2002. FILED 8-21-2000.
- 2,570,970. **NATIONAL TOBACCO.** NATIONAL TOBACCO COMPANY, L.P., (U.S. CLS. 100, 101 AND 102). SN 76-115,467. PUB. 2-26-2002. FILED 8-24-2000.
- 2,570,975. **OBSOLETE.** OBSOLETE, INC., (U.S. CLS. 100, 101 AND 102). SN 76-116,515. PUB. 2-26-2002. FILED 8-24-2000.
- 2,570,979. **ARTIFICIAL WISDOM.** EUREKA! INSTITUTE, INC., (U.S. CLS. 100, 101 AND 102). SN 76-116,790. PUB. 2-26-2002. FILED 8-24-2000.
- 2,570,981. **BLUE CHIP ENGINEERED PRODUCTS.** BLUE CHIP FASTENERS, INC., (U.S. CLS. 100, 101 AND 102). SN 76-117,358. PUB. 9-18-2001. FILED 8-28-2000.
- 2,570,998. **SAFE LOCKER WORLD.** PIERCE SALES CO., INC., (U.S. CLS. 100, 101 AND 102). SN 76-121,889. PUB. 2-26-2002. FILED 9-6-2000.
- 2,570,999. **URBAN EASE AND DESIGN.** URBAN EASE, LLC, (U.S. CLS. 100, 101 AND 102). SN 76-122,971. PUB. 2-26-2002. FILED 9-6-2000.
- 2,571,001. **GLOBAL BOWL.** HIMES, HARRY C. J., (U.S. CLS. 100, 101 AND 102). SN 76-123,216. PUB. 2-26-2002. FILED S.R. 9-6-2000; AM. P.R. 11-20-2001.
- 2,571,003. **MISCELLANEOUS DESIGN.** MPW, INC., (U.S. CLS. 100, 101 AND 102). SN 76-123,480. PUB. 2-26-2002. FILED 9-6-2000.
- 2,571,007. **THE HARTFORD AND DESIGN.** HARTFORD FIRE INSURANCE COMPANY, (U.S. CLS. 100, 101 AND 102). SN 76-124,548. PUB. 2-26-2002. FILED 9-11-2000.
- 2,571,010. **HOUSE OF BLUES HOB.COM IT IS LIVE AND DESIGN.** HOUSE OF BLUES BRANDS CORP., (U.S. CLS. 100, 101 AND 102). SN 76-124,705. PUB. 2-26-2002. FILED 9-8-2000.
- 2,571,022. **E AND DESIGN.** ELEASERRETURNS.COM, (U.S. CLS. 100, 101 AND 102). SN 76-128,269. PUB. 2-26-2002. FILED 9-13-2000.
- 2,571,045. **ION CONSULTING.** UTILITIES INTERNA-

- TIONAL, INC., (U.S. CLS. 100, 101 AND 102). SN 76-138,098. PUB. 2-26-2002. FILED 9-28-2000.
- 2,571,049. **CAFEPRESS.COM**. CAFEPRESS.COM, (U.S. CLS. 100, 101 AND 102). SN 76-139,831. PUB. 2-26-2002. FILED 10-3-2000.
- 2,571,050. **MOTIVATION EXCELLENCE**. MOTIVATION EXCELLENCE, INC., (U.S. CLS. 100, 101 AND 102). SN 76-140,354. PUB. 2-26-2002. FILED 10-30-1999.
- 2,571,056. **H.C. NAHIGIAN & SONS**. H.C. NAHIGIAN & SONS, INC., (U.S. CLS. 100, 101 AND 102). SN 76-143,112. PUB. 2-26-2002. FILED 10-6-2000.
- 2,571,057 (*See Class 16 for this trademark*).
- 2,571,064. **360 INFO SPIN**. FOGDOG, INC., (U.S. CLS. 100, 101 AND 102). SN 76-146,171. PUB. 10-23-2001. FILED 10-16-2000.
- 2,571,067. **MISCELLANEOUS DESIGN**. GROUP 20, INC., (U.S. CLS. 100, 101 AND 102). SN 76-147,703. PUB. 2-26-2002. FILED 10-13-2000.
- 2,571,075. **AT HOME WITH THE AMERICAN DREAM**. COUNTRY PEDDLERS AND COMPANY OF AMERICA, INC., THE, (U.S. CLS. 100, 101 AND 102). SN 76-150,398. PUB. 2-26-2002. FILED 10-18-2000.
- 2,571,085. **WHERE FAMILY FUN IS STILL AFFORDABLE**. MIDWEST RECREATIONAL PRODUCTS INC., (U.S. CLS. 100, 101 AND 102). SN 76-155,764. PUB. 2-26-2002. FILED 10-30-2000.
- 2,571,090. **POWERED FOR BUSINESS**. MICRO WAREHOUSE, INC., (U.S. CLS. 100, 101 AND 102). SN 76-158,247. PUB. 2-26-2002. FILED 11-3-2000.
- 2,571,093. **R AND DESIGN**. SPORTSLINE.COM, INC., (U.S. CLS. 100, 101 AND 102). SN 76-159,054. PUB. 2-26-2002. FILED 11-3-2000.
- 2,571,105 (*See Class 16 for this trademark*).
- 2,571,110. **MAXIM STAFFING SOLUTIONS**. MAXIM HEALTHCARE SERVICES, INC., (U.S. CLS. 100, 101 AND 102). SN 76-165,873. PUB. 2-26-2002. FILED 11-15-2000.
- 2,571,124. **REWARDS SHAW'S SUPERMARKETS CARD (STYLIZED)**. SHAW'S SUPERMARKETS, INC., (U.S. CLS. 100, 101 AND 102). SN 76-169,164. PUB. 2-26-2002. FILED 11-21-2000.
- 2,571,127. **IDEAS THAT CLICK**. TM GROUP GRAPHIC SERVICES, INC., THE, (U.S. CLS. 100, 101 AND 102). SN 76-169,462. PUB. 7-3-2001. FILED 11-21-2000.
- 2,571,156. **XTREME DOCS**. PAYMENT, ELIZABETH, (U.S. CLS. 100, 101 AND 102). SN 76-180,239. PUB. 10-16-2001. FILED 12-14-2000.
- 2,571,157. **NATIONAL BOOKING AGENCY AND DESIGN**. MORGAN, JO DEE, (U.S. CLS. 100, 101 AND 102). SN 76-181,779. PUB. 2-26-2002. FILED 12-18-2000.
- 2,571,165. **KAHALA SPORTSWEAR**. LOCAL MOTION, INC., (U.S. CLS. 100, 101 AND 102). SN 76-188,323. PUB. 2-26-2002. FILED 12-29-2000.
- 2,571,166. **BIZAVINGS**. BIZAVINGS, INC., (U.S. CLS. 100, 101 AND 102). SN 76-188,853. PUB. 2-26-2002. FILED 1-2-2001.
- 2,571,170. **WCMA BUSINESS SIGNATURE REWARDS**. MERRILL LYNCH & CO., INC., (U.S. CLS. 100, 101 AND 102). SN 76-190,294. PUB. 2-26-2002. FILED 1-5-2001.
- 2,571,189. **SYNCHROWARE AND DESIGN**. MARIMARK CORPORATION, (U.S. CLS. 100, 101 AND 102). SN 76-210,547. PUB. 2-26-2002. FILED 2-14-2001.
- 2,571,195 (*See Class 31 for this trademark*).
- 2,571,197. **FINANCIAL PLACEMENTS AND DESIGN**. MRI/SALES CONSULTANTS OF LAKE OSWEGO, LLC, DBA FINANCIAL PLACEMENTS, (U.S. CLS. 100, 101 AND 102). SN 76-215,047. PUB. 2-26-2002. FILED 2-23-2001.
- 2,571,199. **EARLYCUT**. SCHROER, MICHAEL G., (U.S. CLS. 100, 101 AND 102). SN 76-216,644. PUB. 2-26-2002. FILED 2-26-2001.
- 2,571,201. **B BRANDJUICE CONSULTING AND DESIGN**. BRANDJUICE CONSULTING, INC., (U.S. CLS. 100, 101 AND 102). SN 76-217,512. PUB. 2-26-2002. FILED 2-28-2001.
- 2,571,211. **HONOR SCHOOLS INC. AND DESIGN**. HONOR PROPERTIES, LLC, (U.S. CLS. 100, 101 AND 102). SN 76-222,542. PUB. 2-26-2002. FILED 3-9-2001.
- 2,571,220. **NEVER UNDERESTIMATE THE POWER OF ACCURATE DATA**. ACXIOM CORPORATION, (U.S. CLS. 100, 101 AND 102). SN 76-224,854. PUB. 2-26-2002. FILED 3-15-2001.
- 2,571,232. **SACRAMENTO KINGS AND DESIGN**. SACRAMENTO KINGS LIMITED PARTNERSHIP, L.P., (U.S. CLS. 100, 101 AND 102). SN 76-229,742. PUB. 2-26-2002. FILED 3-26-2001.
- 2,571,244. **SOME THINGS CAN ONLY HAPPEN HERE**. CITY OF BEVERLY HILLS, THE, (U.S. CLS. 100, 101 AND 102). SN 76-237,075. PUB. 2-26-2002. FILED 4-6-2001.
- 2,571,253. **PERPETUAL EMOTION**. IRMA S. MANN, STRATEGIC MARKETING, INC., (U.S. CLS. 100, 101 AND 102). SN 76-240,968. PUB. 2-26-2002. FILED 4-16-2001.
- 2,571,278. **BUSINESS SHOWCASE**. TAYLOR CORPORATION, (U.S. CLS. 100, 101 AND 102). SN 76-248,781. PUB. 2-26-2002. FILED 4-30-2001.
- 2,571,280. **MISCELLANEOUS DESIGN**. COLDWATER CREEK INC., (U.S. CLS. 100, 101 AND 102). SN 76-250,031. PUB. 10-30-2001. FILED 5-2-2001.
- 2,571,282. **IST-RUN ADVANTAGE AND DESIGN**. RECOT, INC., (U.S. CLS. 100, 101 AND 102). SN 76-250,692. PUB. 2-26-2002. FILED 5-3-2001.
- 2,571,317. **GYM CLOSET**. PULL-BUOY, INC., (U.S. CLS. 100, 101 AND 102). SN 76-267,573. PUB. 2-26-2002. FILED 6-6-2001.
- 2,571,318. **JOE PICASSO'S POTTERY PAINTING STUDIO AND DESIGN**. JOE PICASSO'S, INC., MULTIPLE CLASS, (INT. CLS. 35 AND 41), (U.S. CLS. 100, 101, 102 AND 107). SN 76-268,467. PUB. 2-26-2002. FILED 6-7-2001.
- 2,571,328. **QEM**. INNOVATIVE EMERGENCY MANAGEMENT, INC., MULTIPLE CLASS, (INT. CLS. 35 AND 42), (U.S. CLS. 100, 101 AND 102). SN 76-271,919. PUB. 2-26-2002. FILED 6-15-2001.
- 2,571,335. **BPP BERGEN PREFERRED PROGRAM AND DESIGN**. BERGEN BRUNSWIG CORPORATION, (U.S. CLS. 100, 101 AND 102). SN 76-274,497. PUB. 2-26-2002. FILED 6-21-2001.
- 2,571,345. **MISCELLANEOUS DESIGN**. RHEINLAND-PALZ-SAAR INTERNATIONAL, LLC, MULTIPLE CLASS, (INT. CLS. 35 AND 42), (U.S. CLS. 100, 101 AND 102). SN 76-277,477. PUB. 2-26-2002. FILED 6-27-2001.
- 2,571,347. **ROCKETSTAFFING.COM**. JETBLADE VENTURES, INC., (U.S. CLS. 100, 101 AND 102). SN 76-278,100. PUB. 2-26-2002. FILED 6-29-2001.
- 2,571,348. **AUCTION PARADE**. WILLIAMS & WILLIAMS REAL ESTATE, (U.S. CLS. 100, 101 AND 102). SN 76-278,975. PUB. 2-26-2002. FILED 7-2-2001.
- 2,571,364. **LIFE, MADE EASIER**. QUICK CHEK FOOD STORES, (U.S. CLS. 100, 101 AND 102). SN 76-285,823. PUB. 2-26-2002. FILED 7-16-2001.
- 2,571,370. **PICTURE IT. BETTER DECISIONS. MORE PROFIT.** PRICEWATERHOUSECOOPERS LLP, (U.S. CLS. 100, 101 AND 102). SN 76-288,292. PUB. 2-26-2002. FILED 7-19-2001.
- 2,571,381. **PROFIT PLANTATION AND DESIGN**. PROFIT PLANTATION, INC., (U.S. CLS. 100, 101 AND 102). SN 76-293,821. PUB. 2-26-2002. FILED 8-2-2001.
- 2,571,389. **HR FUTURES**. MCELFRISH, STEVE, (U.S. CLS. 100, 101 AND 102). SN 76-302,251. PUB. 2-26-2002. FILED 8-21-2001.
- 2,571,397. **ACCOUNTONE (STYLIZED)**. CAREER GROUP, INC., (U.S. CLS. 100, 101 AND 102). SN 76-306,062. PUB. 2-26-2002. FILED 8-27-2001.
- 2,571,412. **MAXMEMORIES**. OMX, INC., (U.S. CLS. 100, 101 AND 102). SN 76-311,880. PUB. 2-26-2002. FILED 9-13-2001.
- 2,571,419. **THE SYSTEM WORKS. FOR YOU.** UNITED STATIONERS SUPPLY CO., (U.S. CLS. 100, 101 AND 102). SN 76-312,508. PUB. 2-26-2002. FILED 9-14-2001.
- 2,571,420. **MISCELLANEOUS DESIGN**. UNITED STATIONERS SUPPLY CO., (U.S. CLS. 100, 101 AND 102). SN 76-312,509. PUB. 2-26-2002. FILED 9-14-2001.
- 2,571,421. **IXP**. IXP CORP., (U.S. CLS. 100, 101 AND 102). SN 76-312,866. PUB. 2-26-2002. FILED 9-14-2001.
- 2,571,436. **A NEW ERA OF EFFICIENCY IN PHARMACEUTICAL SERVICES**. AMERISOURCE HERITAGE CORPORATION, (U.S. CLS. 100, 101 AND 102). SN 76-315,056. PUB. 2-26-2002. FILED 9-20-2001.
- 2,571,455. **FENCETECH**. AMERICAN FENCE ASSOCIATION, INC., (U.S. CLS. 100, 101 AND 102). SN 76-319,597. PUB. 2-26-2002. FILED 10-1-2001.
- 2,571,475. **OLDHORSES**. OLDHORSES.COM, INC., (U.S. CLS.

100, 101 AND 102). SN 76-323,763. PUB. 2-26-2002. FILED 10-10-2001.

2,571,484. **RAPIDPATH**. READEX, INC., (U.S. CLS. 100, 101 AND 102). SN 76-326,566. PUB. 2-26-2002. FILED 10-18-2001.

2,571,491. **YBP AND DESIGN**. YANKEE BOOK PEDDLER, INC., MULTIPLE CLASS, (INT. CLS. 35 AND 42), (U.S. CLS. 100, 101 AND 102). SN 76-328,437. PUB. 2-26-2002. FILED 10-19-2001.

2,571,497. **THE ULTIMATE BACKYARD NATURE STORE**. WILD BIRD CENTERS OF AMERICA, INC., (U.S. CLS. 100, 101 AND 102). SN 78-019,695. PUB. 2-26-2002. FILED 8-4-2000.

2,571,513. **BFT AND DESIGN**. BULLFROG TECHNOLOGIES, LLC, MULTIPLE CLASS, (INT. CLS. 35 AND 42), (U.S. CLS. 100, 101 AND 102). SN 78-028,339. PUB. 2-26-2002. FILED 9-29-2000.

2,571,515. **WESTHILL MARKETING SCIENCES**. WESTHILL PARTNERS, INC., (U.S. CLS. 100, 101 AND 102). SN 78-028,653. PUB. 2-26-2002. FILED 10-2-2000.

2,571,521. **SUPPLY NET AND DESIGN**. MOEN INCORPORATED, (U.S. CLS. 100, 101 AND 102). SN 78-030,956. PUB. 2-26-2002. FILED 10-17-2000.

2,571,529. **HEARTHSTONE COFFEES**. CALLIGAN, JOHN S., (U.S. CLS. 100, 101 AND 102). SN 78-032,854. PUB. 2-26-2002. FILED 10-30-2000.

2,571,531. **ENVENT ENERGY AND DESIGN**. ENVENT ENERGY, LLC, (U.S. CLS. 100, 101 AND 102). SN 78-033,986. PUB. 2-26-2002. FILED 11-6-2000.

2,571,538. **THINK CREATIVE**. M&M CREATIVE SERVICES, MULTIPLE CLASS, (INT. CLS. 35 AND 42), (U.S. CLS. 100, 101 AND 102). SN 78-035,513. PUB. 2-26-2002. FILED 11-16-2000.

2,571,539. **GOOD MORNING WICHITA**. WILKINS, JACK E., (U.S. CLS. 100, 101 AND 102). SN 78-035,546. PUB. 2-26-2002. FILED 11-16-2000.

2,571,546. **TAS THE ARCH SUPPORT.COM AND DESIGN**. THEARCHSUPPORT.COM, (U.S. CLS. 100, 101 AND 102). SN 78-036,524. PUB. 2-26-2002. FILED 11-25-2000.

2,571,555. **TIME VOYAGERS**. LAUVER, FRED J., (U.S. CLS. 100, 101 AND 102). SN 78-038,971. PUB. 2-26-2002. FILED 12-12-2000.

2,571,558 (*See Class 6 for this trademark*).

2,571,563. **1-800-GET-LENS**. CONTACT LENS DEPOT, INC., (U.S. CLS. 100, 101 AND 102). SN 78-041,741. PUB. 2-26-2002. FILED 1-4-2001.

2,571,568. **ART AIDS AFRICA AND DESIGN**. ART AIDS AFRICA, MULTIPLE CLASS, (INT. CLS. 35 AND 36), (U.S. CLS. 100, 101 AND 102). SN 78-043,435. PUB. 2-26-2002. FILED 1-16-2001.

2,571,571. **THERE'S NO BETTER WAY TO FIND IT**. TECHTRACER SYSTEMS, LLC, (U.S. CLS. 100, 101 AND 102). SN 78-044,697. PUB. 2-26-2002. FILED 1-24-2001.

2,571,574. **ULN**. UNITED LAWYERS NETWORK, INC., (U.S. CLS. 100, 101 AND 102). SN 78-045,251. PUB. 2-26-2002. FILED 1-26-2001.

2,571,583. **E-VISORS**. E-VISORS, INC., (U.S. CLS. 100, 101 AND 102). SN 78-048,140. PUB. 11-27-2001. FILED 2-13-2001.

2,571,606. **SUMMER IS JUST AROUND THE CORNER**. TRUSERV CORPORATION, (U.S. CLS. 100, 101 AND 102). SN 78-055,036. PUB. 2-26-2002. FILED 3-26-2001.

2,571,645. **INSTRACK**. FIRST GUARANTY COMPANIES, (U.S. CLS. 100, 101 AND 102). SN 78-071,817. PUB. 2-26-2002. FILED 6-29-2001.

2,571,655. **KICK BUTT. HAVE FUN.** LYERLY AGENCY, INC., (U.S. CLS. 100, 101 AND 102). SN 78-074,943. PUB. 2-26-2002. FILED 7-20-2001.

2,571,668. **THE SYNERGY CHANNEL AND DESIGN**. JACKSON, BARRY MARTIN, DBA THE SYNERGY CHANNEL, (U.S. CLS. 100, 101 AND 102). SN 78-078,690. PUB. 2-26-2002. FILED 8-10-2001.

2,571,672 (*See Class 9 for this trademark*).

2,571,673. **LIFT THE BAR**. MODERNISTA!, LTD., (U.S. CLS. 100, 101 AND 102). SN 78-082,709. PUB. 2-26-2002. FILED 9-5-2001.

CLASS 36—INSURANCE AND FINANCIAL

2,570,549 (*See Class 35 for this trademark*).

2,570,555. **SUPERPASS**. PETRO-CANADA, (U.S. CLS. 100, 101 AND 102). SN 75-587,450. PUB. 2-26-2002. FILED 11-12-1998.

2,570,556. **SUPERPASS AND DESIGN**. PETRO-CANADA, (U.S. CLS. 100, 101 AND 102). SN 75-587,452. PUB. 2-26-2002. FILED 11-12-1998.

2,570,596 (*See Class 35 for this trademark*).

2,570,613. **FCIB NACM**. FCIB-NACM. CORP., (U.S. CLS. 100, 101 AND 102). SN 75-738,351. PUB. 2-26-2002. FILED 6-28-1999.

2,570,622 (*See Class 35 for this trademark*).

2,570,633. **STAG PROTECTOR**. HARTFORD FIRE INSURANCE COMPANY, (U.S. CLS. 100, 101 AND 102). SN 75-776,786. PUB. 10-16-2001. FILED 8-16-1999.

2,570,636. **ALERION**. ATLANTIC MUTUAL INSURANCE COMPANY, (U.S. CLS. 100, 101 AND 102). SN 75-779,289. PUB. 2-26-2002. FILED 8-19-1999.

2,570,642. **THE DOT COMMON SENSE WAY**. FISHMAN, DEL., (U.S. CLS. 100, 101 AND 102). SN 75-791,690. PUB. 2-26-2002. FILED 9-3-1999.

2,570,643. **BUILDING PERMANENT RELATIONSHIPS**. L&N FEDERAL CREDIT UNION, (U.S. CLS. 100, 101 AND 102). SN 75-794,148. PUB. 3-7-2000. FILED 9-8-1999.

2,570,655. **BLUESTAR UNDERWRITERS, LLC AND DESIGN**. BLUESTAR UNDERWRITERS, LLC, (U.S. CLS. 100, 101 AND 102). SN 75-817,239. PUB. 5-16-2000. FILED 10-7-1999.

2,570,689 (*See Class 35 for this trademark*).

2,570,695. **WORLDSHARE**. WORLDSHARE, INC., MULTIPLE CLASS, (INT. CLS. 36, 38 AND 42), (U.S. CLS. 100, 101, 102 AND 104). SN 75-874,504. PUB. 2-26-2002. FILED 12-17-1999.

2,570,699. **TARGET**. BELL, LAWRENCE L., (U.S. CLS. 100, 101 AND 102). SN 75-877,605. PUB. 7-17-2001. FILED 12-14-1999.

2,570,730. **MILLENNIUM TECHNOLOGY VENTURES**. MILLENNIUM TECHNOLOGY VENTURES, L.P., (U.S. CLS. 100, 101 AND 102). SN 75-926,231. PUB. 10-9-2001. FILED 2-23-2000.

2,570,751. **ONECREDITSOURCE.COM**. ONECREDITSOURCE.COM, LLC, (U.S. CLS. 100, 101 AND 102). SN 75-955,973. PUB. 1-30-2001. FILED 3-10-2000.

2,570,763. **RESIDENT'S HOME BUYING SERVICES, INC. AND DESIGN**. RESIDENT'S HOME BUYING SERVICES, INC., (U.S. CLS. 100, 101 AND 102). SN 76-010,743. PUB. 2-26-2002. FILED 3-28-2000.

2,570,769. **TIBURON (STYLIZED)**. WATERMARK COMMUNITIES, INC., MULTIPLE CLASS, (INT. CLS. 36, 37, 41 AND 42), (U.S. CLS. 100, 101, 102, 103, 106 AND 107). SN 76-014,134. PUB. 9-18-2001. FILED 3-31-2000.

2,570,770. **TIBURON AND DESIGN**. WATERMARK COMMUNITIES, INC., MULTIPLE CLASS, (INT. CLS. 36, 37, 41 AND 42), (U.S. CLS. 100, 101, 102, 103, 106 AND 107). SN 76-014,136. PUB. 9-18-2001. FILED 3-31-2000.

2,570,775. **M MEDITERRA AND DESIGN**. LONG BAY PARTNERS, L.L.C., (U.S. CLS. 100, 101 AND 102). SN 76-019,778. PUB. 2-26-2002. FILED 4-7-2000.

2,570,787. **PASSPORT**. CNA FINANCIAL CORPORATION, (U.S. CLS. 100, 101 AND 102). SN 76-025,955. PUB. 2-26-2002. FILED 4-14-2000.

2,570,788. **BUY FOR FREE WITH NDB**. NATIONAL DISCOUNT BROKERS GROUP, INC., BY ASSIGNMENT NATIONAL DISCOUNT BROKERS, CORPORATION, (U.S. CLS. 100, 101 AND 102). SN 76-027,279. PUB. 2-26-2002. FILED 4-17-2000.

2,570,794. **"PERSISTENT PROFESSIONALS"**. DEBRA C. JAMES & STANLEY W. EPSTEIN, P. A., (U.S. CLS. 100, 101 AND 102). SN 76-030,417. PUB. 2-26-2002. FILED 4-21-2000.

2,570,796. **ROBIE PROPERTIES**. ROBIE PROPERTIES LLC, MULTIPLE CLASS, (INT. CLS. 36 AND 37), (U.S. CLS. 100, 101, 102, 103 AND 106). SN 76-032,146. PUB. 2-26-2002. FILED 4-21-2000.

2,570,797. **INSURING YOUR LIFESTYLE**. LONG & FOSTER COMPANIES, INC., (U.S. CLS. 100, 101 AND 102). SN 76-033,554. PUB. 2-26-2002. FILED 4-25-2000.

2,570,803. **FN F E A T H E R E D N E S T**. BHS HOLDINGS, LLC, (U.S. CLS. 100, 101 AND 102). SN 76-040,089. PUB. 2-26-2002. FILED 5-2-2000.

- 2,570,805 (*See Class 35 for this trademark.*)
 2,570,810 (*See Class 35 for this trademark.*)
 2,570,812. **BESTPRICEMORTGAGE.COM AND DESIGN.** GUARDIAN HOME FUNDING, INC., (U.S. CLS. 100, 101 AND 102). SN 76-047,712. PUB. 2-26-2002. FILED 5-15-2000.
 2,570,816. **WOW ANSWER GUIDE.** COMMERCE BANCORP, INC., (U.S. CLS. 100, 101 AND 102). SN 76-050,741. PUB. 2-26-2002. FILED 5-17-2000.
 2,570,830. **TO YOUR HEALTH.** HEALTH FOUNDATION OF GREATER INDIANAPOLIS, INC., THE, (U.S. CLS. 100, 101 AND 102). SN 76-057,688. PUB. 2-26-2002. FILED 5-26-2000.
 2,570,832. **FINPRO SOLUTIONS.** MARSH USA INC., (U.S. CLS. 100, 101 AND 102). SN 76-058,289. PUB. 2-26-2002. FILED 5-26-2000.
 2,570,839. **MAKE A CHILD SMILE AND DESIGN.** MAKE A CHILD SMILE, INC., (U.S. CLS. 100, 101 AND 102). SN 76-061,087. PUB. 2-26-2002. FILED 6-2-2000.
 2,570,898. **VIRTUAL FORMS.** QUICKQUOTE SYSTEMS, INC., (U.S. CLS. 100, 101 AND 102). SN 76-084,745. PUB. 2-26-2002. FILED 7-7-2000.
 2,570,902 (*See Class 25 for this trademark.*)
 2,570,946. **EURIBOR.** EURIBOR FEDERATION BANCAIRE EUROPEENNE, (U.S. CLS. 100, 101 AND 102). SN 76-104,059. PUB. 2-26-2002. FILED 8-7-2000.
 2,570,969. **TREK TRI-ISLAND AND DESIGN.** AMERICAN LUNG ASSOCIATION OF WASHINGTON, (U.S. CLS. 100, 101 AND 102). SN 76-115,353. PUB. 10-30-2001. FILED 8-24-2000.
 2,570,996. **MINISTRYFIRST.** BROTHERHOOD MUTUAL INSURANCE COMPANY, (U.S. CLS. 100, 101 AND 102). SN 76-120,529. PUB. 2-26-2002. FILED 8-29-2000.
 2,571,002. **PACADVANTAGE.** PACIFIC HEALTH ADVANTAGE, (U.S. CLS. 100, 101 AND 102). SN 76-123,228. PUB. 2-26-2002. FILED 9-6-2000.
 2,571,068. **LIPPER INTERMEDIATE INVESTMENT FUND.** LIPPER & COMPANY, INC., (U.S. CLS. 100, 101 AND 102). SN 76-148,761. PUB. 2-26-2002. FILED 10-17-2000.
 2,571,069. **LIPPER U.S. EQUITY FUND.** LIPPER & COMPANY, INC., (U.S. CLS. 100, 101 AND 102). SN 76-148,765. PUB. 2-26-2002. FILED 10-17-2000.
 2,571,073. **EQUITYLINE PLATINUM.** WELLS FARGO & COMPANY, (U.S. CLS. 100, 101 AND 102). SN 76-150,014. PUB. 2-26-2002. FILED 10-19-2000.
 2,571,101. **A2XONLINE.** ANN ARBOR ANNUITY EXCHANGE, INC., (U.S. CLS. 100, 101 AND 102). SN 76-161,721. PUB. 2-26-2002. FILED 11-8-2000.
 2,571,105 (*See Class 16 for this trademark.*)
 2,571,121. **NBP TRUCCROSSING.** NEWBRIDGE PARTNERS LLC, (U.S. CLS. 100, 101 AND 102). SN 76-168,789. PUB. 12-18-2001. FILED 11-22-2000.
 2,571,132. **PBHG FUNDS AND DESIGN.** PILGRIM BAXTER & ASSOCIATES, LTD., (U.S. CLS. 100, 101 AND 102). SN 76-171,309. PUB. 2-26-2002. FILED 11-27-2000.
 2,571,139. **J.C. TAYLOR.** J.C. TAYLOR ANTIQUE AUTOMOBILE AGENCY, INC., (U.S. CLS. 100, 101 AND 102). SN 76-173,801. PUB. 2-26-2002. FILED 12-1-2000.
 2,571,164. **DRIVER ASSIST.** COMPUNET CREDIT SERVICES, INC., (U.S. CLS. 100, 101 AND 102). SN 76-187,703. PUB. 2-26-2002. FILED 1-2-2001.
 2,571,168 (*See Class 16 for this trademark.*)
 2,571,171. **PROGROWTH PANDA PALS.** PROGRESSIVE GROWTH CORP., (U.S. CLS. 100, 101 AND 102). SN 76-190,736. PUB. 8-28-2001. FILED 1-3-2001.
 2,571,205. **THRIFTY CARE.** THRIFTY, INC., (U.S. CLS. 100, 101 AND 102). SN 76-219,611. PUB. 2-26-2002. FILED 3-6-2001.
 2,571,212. **MISCELLANEOUS DESIGN.** VILLAGE VENTURES, INC., (U.S. CLS. 100, 101 AND 102). SN 76-222,787. PUB. 2-26-2002. FILED 3-12-2001.
 2,571,223. **NEWEST MEZZANINE.** NEWEST MEZZANINE FUND LP, (U.S. CLS. 100, 101 AND 102). SN 76-226,374. PUB. 2-26-2002. FILED 3-19-2001.
 2,571,224. **TECH GUARD.** TECH GUARD, INC., (U.S. CLS. 100, 101 AND 102). SN 76-226,455. PUB. 2-26-2002. FILED 3-19-2001.
 2,571,225. **WESTERN FEDERAL CREDIT UNION GOLD AND DESIGN.** WESTERN FEDERAL CREDIT UNION, (U.S. CLS. 100, 101 AND 102). SN 76-226,691. PUB. 2-26-2002. FILED 3-19-2001.
 2,571,256. **WE SLEEP FASTER.** MIRANT CORPORATION, (U.S. CLS. 100, 101 AND 102). SN 76-241,902. PUB. 2-26-2002. FILED 4-17-2001.
 2,571,261. **RANDCONNECT.** RAND FINANCIAL SERVICES, INC., MULTIPLE CLASS, (INT. CLS. 36 AND 42), (U.S. CLS. 100, 101 AND 102). SN 76-243,469. PUB. 2-26-2002. FILED 4-20-2001.
 2,571,266. **CAMBRIDGE IN AMERICA.** CAMBRIDGE IN AMERICA, (U.S. CLS. 100, 101 AND 102). SN 76-244,684. PUB. 2-26-2002. FILED 4-23-2001.
 2,571,307. **BLUE CREW.** BLUE CROSS AND BLUE SHIELD ASSOCIATION, (U.S. CLS. 100, 101 AND 102). SN 76-262,755. PUB. 2-26-2002. FILED 5-25-2001.
 2,571,310. **SPACE WATCH.** CITYFEET.COM, INC., (U.S. CLS. 100, 101 AND 102). SN 76-264,824. PUB. 2-26-2002. FILED 6-1-2001.
 2,571,315. **NECA THE NATIONAL ENDOWMENT FOR THE CHRISTIAN ARTS IT'S MORE THAN JUST ART. IT'S A LIFESTYLE.** NATIONAL ENDOWMENT FOR THE CHRISTIAN ARTS, INC., THE, (U.S. CLS. 100, 101 AND 102). SN 76-266,489. PUB. 2-26-2002. FILED 6-5-2001.
 2,571,325 (*See Class 25 for this trademark.*)
 2,571,333. **BANKING UNUSUAL.** PEOPLES, INC., (U.S. CLS. 100, 101 AND 102). SN 76-273,435. PUB. 2-26-2002. FILED 6-19-2001.
 2,571,339. **FAIRLANE.** FORD MOTOR COMPANY, (U.S. CLS. 100, 101 AND 102). SN 76-276,251. PUB. 2-26-2002. FILED 6-23-2001.
 2,571,344. **FIRST UNION SECURITIES.** FIRST UNION CORPORATION, (U.S. CLS. 100, 101 AND 102). SN 76-277,329. PUB. 2-26-2002. FILED 6-25-2001.
 2,571,391. **FCIB.** FCIB-NACM CORPORATION, (U.S. CLS. 100, 101 AND 102). SN 76-303,610. PUB. 2-26-2002. FILED 8-23-2001.
 2,571,408. **EAGLEROCK.** EAGLEROCK CAPITAL MANAGEMENT, LLC, (U.S. CLS. 100, 101 AND 102). SN 76-310,685. PUB. 2-26-2002. FILED 9-7-2001.
 2,571,428. **C CITIZENS BANK AND DESIGN.** CITIZENS FINANCIAL GROUP, INC., (U.S. CLS. 100, 101 AND 102). SN 76-313,670. PUB. 2-26-2002. FILED 9-17-2001.
 2,571,431. **CONFIDENCE PLUS.** AFTERMARKET AUTO PARTS ALLIANCE, INC., (U.S. CLS. 100, 101 AND 102). SN 76-314,410. PUB. 2-26-2002. FILED 9-20-2001.
 2,571,443. **QUICK DECISION.** FIRST-CITIZENS BANK AND TRUST COMPANY OF SOUTH CAROLINA, (U.S. CLS. 100, 101 AND 102). SN 76-316,293. PUB. 2-26-2002. FILED 9-24-2001.
 2,571,452. **DIAMOND ADVANTAGE.** INTERNATIONAL TRUCK INTELLECTUAL PROPERTY COMPANY, LLC, (U.S. CLS. 100, 101 AND 102). SN 76-318,493. PUB. 2-26-2002. FILED 9-27-2001.
 2,571,514. **R.E.S.T.O.R.E..** REBUILDING EDUCATIONAL SYSTEMS THROUGH OUR RAISED EFFORTS, INC., DBA R.E.S.T.O.R.E., (U.S. CLS. 100, 101 AND 102). SN 78-028,416. PUB. 2-26-2002. FILED 9-30-2000.
 2,571,568 (*See Class 35 for this trademark.*)
 2,571,573. **ONECHOICE.** EDUCATIONAL CREDIT SERVICES COMPANY, (U.S. CLS. 100, 101 AND 102). SN 78-045,211. PUB. 2-26-2002. FILED 1-26-2001.
 2,571,595. **LOANISLAND.COM.** SUMMIT INVESTMENTS LOAN CORPORATION, (U.S. CLS. 100, 101 AND 102). SN 78-050,455. PUB. 2-26-2002. FILED 2-27-2001.
 2,571,598. **FOREIGNSURE.** INTERNATIONAL EDUCATIONAL EXCHANGE SERVICES, INC., (U.S. CLS. 100, 101 AND 102). SN 78-051,228. PUB. 2-26-2002. FILED 3-3-2001.
 2,571,605. **HANOVER PARK.** CROTIX, (U.S. CLS. 100, 101 AND 102). SN 78-054,885. PUB. 2-26-2002. FILED 3-25-2001.
 2,571,624. **POWER RANCH AND DESIGN.** SUNPOWER, LLC, (U.S. CLS. 100, 101 AND 102). SN 78-061,658. PUB. 2-26-2002. FILED 5-2-2001.
 2,571,638. **UMPQUA B.A.N.K AND DESIGN.** UMPQUA HOLDINGS CORPORATION, (U.S. CLS. 100, 101 AND 102). SN 78-070,810. PUB. 2-26-2002. FILED 6-25-2001.
 2,571,643. **GRADUATE EXPRESS.** AMERICAN EXPRESS COMPANY, (U.S. CLS. 100, 101 AND 102). SN 78-071,705. PUB. 2-26-2002. FILED 6-29-2001.

- 2,571,644. **HEALTH EXPRESS**. AMERICAN EXPRESS COMPANY, (U.S. CLS. 100, 101 AND 102). SN 78-071,713. PUB. 2-26-2002. FILED 6-29-2001.
- 2,571,649. **EASTWOOD AND DESIGN**. EASTWOOD INSURANCE SERVICES, INC., (U.S. CLS. 100, 101 AND 102). SN 78-072,509. PUB. 2-26-2002. FILED 7-5-2001.
- 2,571,663. **YOUR INSURANCE MAY HAVE SHIFTED DURING FLIGHT**. SPECIALTY RISK INTERNATIONAL, INC., (U.S. CLS. 100, 101 AND 102). SN 78-076,552. PUB. 2-26-2002. FILED 7-31-2001.
- 2,571,674. **Z (STYLIZED)**. GLOBAL TRADZ, INC., (U.S. CLS. 100, 101 AND 102). SN 78-082,859. PUB. 2-26-2002. FILED 9-6-2001.

CLASS 37—CONSTRUCTION AND REPAIR

- 2,570,486 (*See Class 35 for this trademark*).
- 2,570,517. **SOFTWISE (STYLIZED)**. SOFTWISE CONSULTING SERVICES, INC., MULTIPLE CLASS, (INT. CLS. 37 AND 42), (U.S. CLS. 100, 101, 103 AND 106). SN 75-398,362. PUB. 2-26-2002. FILED 12-1-1997.
- 2,570,527 (*See Class 9 for this trademark*).
- 2,570,665. **T K S. KABUSHIKI KAISHA TOKYO KIKAI SEISAKUSHO**, (U.S. CLS. 100, 103 AND 106). SN 75-827,145. PUB. 2-26-2002. FILED 10-19-1999.
- 2,570,690. **NORTHEAST GARAGE DOOR SYSTEMS LLC WE'LLHELP YOUR DOORS THROUGH THEIR UPS AND DOWNS**. NORTHEAST GARAGE DOOR SYSTEMS, LLC, (U.S. CLS. 100, 103 AND 106). SN 75-872,017. PUB. 2-26-2002. FILED 12-16-1999.
- 2,570,691 (*See Class 12 for this trademark*).
- 2,570,705. **NATIONAL URBAN TECHNOLOGY CENTER**. NATIONAL URBAN TECHNOLOGY CENTER, INC., THE, MULTIPLE CLASS, (INT. CLS. 37 AND 42), (U.S. CLS. 100, 101, 103 AND 106). SN 75-896,644. PUB. 2-26-2002. FILED 1-18-2000.
- 2,570,766. **MISCELLANEOUS DESIGN**. GIANSANTI, WILLARD R., (U.S. CLS. 100, 103 AND 106). SN 76-013,093. PUB. 2-26-2002. FILED 3-30-2000.
- 2,570,769 (*See Class 36 for this trademark*).
- 2,570,770 (*See Class 36 for this trademark*).
- 2,570,790 (*See Class 35 for this trademark*).
- 2,570,796 (*See Class 36 for this trademark*).
- 2,570,799. **SHINE COMPANY AND DESIGN**. SHINE COMPANY, INC., (U.S. CLS. 100, 103 AND 106). SN 76-036,056. PUB. 2-26-2002. FILED 4-27-2000.
- 2,570,853 (*See Class 7 for this trademark*).
- 2,570,899. **SPINCYCLE**. SPINCYCLE, LLC, BY ASSIGNMENT SPINCYCLE, INC., (U.S. CLS. 100, 103 AND 106). SN 76-085,599. PUB. 2-26-2002. FILED 7-7-2000.
- 2,570,900. **LOCATOR ONLINE**. JOHN HOLMES PUBLISHING COMPANY, (U.S. CLS. 100, 103 AND 106). SN 76-086,188. PUB. 2-26-2002. FILED 7-10-2000.
- 2,570,926. **GIVE YOUR FACILITY THE WORKS**. O.P.E.N. AMERICA, INC., (U.S. CLS. 100, 103 AND 106). SN 76-096,319. PUB. 2-26-2002. FILED 7-25-2000.
- 2,570,931 (*See Class 35 for this trademark*).
- 2,570,952 (*See Class 35 for this trademark*).
- 2,570,987. **PERFORMANCE EXCELLENCE IN DESIGN AND CRAFTSMANSHIP KITCHENS BATHS & CABINETRY SINCE 1974 AND DESIGN**. B. FORMAN CO., INC., MULTIPLE CLASS, (INT. CLS. 37 AND 42), (U.S. CLS. 100, 101, 103 AND 106). SN 76-117,963. PUB. 2-26-2002. FILED 8-28-2000.
- 2,570,993. **CREW WORKS**. CREW WORKS, INC., THE, (U.S. CLS. 100, 103 AND 106). SN 76-119,710. PUB. 2-26-2002. FILED 8-31-2000.
- 2,570,994. **THE CREW WORKS**. CREW WORKS, INC., THE, (U.S. CLS. 100, 103 AND 106). SN 76-119,711. PUB. 2-26-2002. FILED 8-31-2000.
- 2,570,997. **SUNGLO TELECOM AND DESIGN**. SUNGLO TELECOM, INC., (U.S. CLS. 100, 103 AND 106). SN 76-121,393. PUB. 12-11-2001. FILED 9-5-2000.
- 2,571,004. **PAINTERS FOR HIRE INC III VI IX XII AND DESIGN**. PAINTERS FOR HIRE INC., (U.S. CLS. 100, 103 AND 106). SN 76-123,933. PUB. 2-26-2002. FILED 9-8-2000.

- 2,571,034. **EMERGENCY RESTORATION SERVICES AND DESIGN**. EMERGENCY RESTORATION SERVICES, INC., (U.S. CLS. 100, 103 AND 106). SN 76-134,077. PUB. 2-26-2002. FILED 9-22-2000.
- 2,571,052. **ALLDATA**. ALLDATA LLC, (U.S. CLS. 100, 103 AND 106). SN 76-141,435. PUB. 2-26-2002. FILED 10-4-2000.
- 2,571,074. **CONCRETE SCIENCE CONSULTING CONCRETE ENGINEERS**. KAKADE, ASHOK M., MULTIPLE CLASS, (INT. CLS. 37 AND 42), (U.S. CLS. 100, 101, 103 AND 106). SN 76-150,070. PUB. 2-26-2002. FILED 10-20-2000.
- 2,571,102 (*See Class 9 for this trademark*).
- 2,571,270. **MISCELLANEOUS DESIGN**. WOODMASTERS, INC., (U.S. CLS. 100, 103 AND 106). SN 76-247,454. PUB. 2-26-2002. FILED 4-26-2001.
- 2,571,277. **310 MOTORING**. 310 MOTORING CORPORATION, (U.S. CLS. 100, 103 AND 106). SN 76-248,581. PUB. 2-26-2002. FILED 5-1-2001.
- 2,571,281. **RETROPLATE**. CURECRETE CHEMICAL CO., INC., (U.S. CLS. 100, 103 AND 106). SN 76-250,649. PUB. 2-26-2002. FILED 5-3-2001.
- 2,571,309. **INSTALLNET (STYLIZED)**. INSTALLNET INTERNATIONAL, INC., (U.S. CLS. 100, 103 AND 106). SN 76-264,770. PUB. 2-26-2002. FILED 5-31-2001.
- 2,571,311. **JET WORKS**. JET WORKS AVIATION, INC., (U.S. CLS. 100, 103 AND 106). SN 76-265,232. PUB. 2-26-2002. FILED 5-31-2001.
- 2,571,388. **APHRODITE**. NAXOS CLEANERS, INC., (U.S. CLS. 100, 103 AND 106). SN 76-302,082. PUB. 2-26-2002. FILED 8-20-2001.
- 2,571,392. **?Y-NOT?**. HOMETEX CORPORATION, (U.S. CLS. 100, 103 AND 106). SN 76-304,668. PUB. 2-26-2002. FILED 8-24-2001.
- 2,571,394. **?Y-NOT? AND DESIGN**. HOMETEX CORPORATION, (U.S. CLS. 100, 103 AND 106). SN 76-305,351. PUB. 2-26-2002. FILED 8-27-2001.
- 2,571,456. **ELECTRIC AVENUE**. CITYSCAPES, LLC, (U.S. CLS. 100, 103 AND 106). SN 76-319,621. PUB. 2-26-2002. FILED 10-1-2001.
- 2,571,511. **GOLFGUYS**. SCC GOLF PROPERTIES, LLC, (U.S. CLS. 100, 103 AND 106). SN 78-027,479. PUB. 2-26-2002. FILED 9-25-2000.
- 2,571,533 (*See Class 9 for this trademark*).
- 2,571,537. **GOT BOOM?**. ABLE EQUIPMENT RENTAL, INC., (U.S. CLS. 100, 103 AND 106). SN 78-035,502. PUB. 2-26-2002. FILED 11-16-2000.
- 2,571,550. **JONES FIRE PROTECTION AND DESIGN**. JONES FIRE PROTECTION, INC., (U.S. CLS. 100, 103 AND 106). SN 78-037,846. PUB. 2-26-2002. FILED 12-5-2000.
- 2,571,619. **S (STYLIZED)**. STOREFRONT SYSTEMS AND SERVICE CO., INC., (U.S. CLS. 100, 103 AND 106). SN 78-057,370. PUB. 2-26-2002. FILED 4-9-2001.
- 2,571,679. **FLOOD MASTERS**. SAN DIEGO FLOOD BUSTERS, INC., (U.S. CLS. 100, 103 AND 106). SN 78-085,087. PUB. 2-26-2002. FILED 9-22-2001.

CLASS 38—COMMUNICATION

- 2,570,506. **ARCPPOINT**. NTT COMMUNICATIONS KABUSHIKI KAISHA, DBA NTT COMMUNICATIONS CORPORATION, BY ASSIGNMENT NIPPON DENSHIN DENWA KABUSHIKI KAISHA, DBA NIPPON TELEGRAPH AND TELEPHONE CORPORATION, (U.S. CLS. 100, 101 AND 104). SN 75-340,069. PUB. 2-26-2002. FILED 8-13-1997.
- 2,570,527 (*See Class 9 for this trademark*).
- 2,570,530 (*See Class 9 for this trademark*).
- 2,570,533 (*See Class 9 for this trademark*).
- 2,570,534. **LEXCOM AND DESIGN**. LEXCOM, INC., (U.S. CLS. 100, 101 AND 104). SN 75-504,245. PUB. 2-26-2002. FILED 6-18-1998.
- 2,570,547 (*See Class 9 for this trademark*).
- 2,570,573. **MILLION DOLLAR DASH FOR CASH**. CHANCELLOR MEDIA CORPORATION OF MASSACHUSETTS, (U.S. CLS. 100, 101 AND 104). SN 75-612,089. PUB. 11-16-1999. FILED 12-24-1998.
- 2,570,593. **NEWPATH COMMUNICATIONS**. NEWPATH HOLDING, INC., BY ASSIGNMENT NEWPATH COMMU-

- NICATIONS, L.C., (U.S. CLS. 100, 101 AND 104). SN 75-679,268. PUB. 2-26-2002. FILED 10-30-1999.
- 2,570,610. **APPSERV**. IBILL TECHNOLOGIES, L.L.C., BY ASSIGNMENT APPSERV, INC., (U.S. CLS. 100, 101 AND 104). SN 75-735,972. PUB. 2-26-2002. FILED 6-24-1999.
- 2,570,679. **WEBASSIGN**. NORTH CAROLINA STATE UNIVERSITY, MULTIPLE CLASS, (INT. CLS. 38 AND 41), (U.S. CLS. 100, 101, 104 AND 107). SN 75-860,485. PUB. 2-26-2002. FILED 12-15-1999.
- 2,570,695 (*See Class 36 for this trademark*).
- 2,570,716. **PLINK LIGHT**. PEOPLELINK, INC., (U.S. CLS. 100, 101 AND 104). SN 75-906,674. PUB. 2-26-2002. FILED 1-31-2000.
- 2,570,771. **WEIGHTWATCHERS.COM**. WEIGHT WATCHERS INTERNATIONAL, INC., MULTIPLE CLASS, (INT. CLS. 38, 41 AND 42), (U.S. CLS. 100, 101, 104 AND 107). SN 76-017,221. PUB. 2-26-2002. FILED 4-4-2000.
- 2,570,776. **ERESMAS**. RETEVISION INTERACTIVA, S.A., MULTIPLE CLASS, (INT. CLS. 38 AND 42), (U.S. CLS. 100, 101 AND 104). SN 76-020,320. PUB. 2-26-2002. FILED 4-6-2000.
- 2,570,778. **BUSINESS TO DEVICE**. DEVICECAST, INC., (U.S. CLS. 100, 101 AND 104). SN 76-021,752. PUB. 2-26-2002. FILED 4-10-2000.
- 2,570,781. **GO.CC FREE WEB ADDRESSES AND DESIGN**. ENIC CORPORATION, (U.S. CLS. 100, 101 AND 104). SN 76-022,773. PUB. 2-26-2002. FILED 4-11-2000.
- 2,570,851. **POWERFLITE**. TELE-MEDIA CORPORATION OF DELAWARE, (U.S. CLS. 100, 101 AND 104). SN 76-070,107. PUB. 2-26-2002. FILED 6-5-2000.
- 2,570,866. **EWS EXTENDED WORKPLACE SOLUTIONS**. QWEST COMMUNICATIONS INTERNATIONAL INC, BY MERGER U S WEST, INC., (U.S. CLS. 100, 101 AND 104). SN 76-075,810. PUB. 2-26-2002. FILED 6-22-2000.
- 2,570,871. **BUZZTALK**. MASSACHUSETTS ELECTRONIC COMMERCE ASSOCIATION, INC., (U.S. CLS. 100, 101 AND 104). SN 76-077,440. PUB. 2-26-2002. FILED 6-22-2000.
- 2,570,911. **MISCELLANEOUS DESIGN**. TECHNOLOGY ADVANCEMENT GROUP, INC., (U.S. CLS. 100, 101 AND 104). SN 76-090,215. PUB. 2-26-2002. FILED 7-17-2000.
- 2,571,013. **NY ENET AND DESIGN**. NEW YORK STATE OFFICE FOR TECHNOLOGY, (U.S. CLS. 100, 101 AND 104). SN 76-125,636. PUB. 2-26-2002. FILED 9-11-2000.
- 2,571,080. **FU GINA AND DESIGN**. GTFM, INC., (U.S. CLS. 100, 101 AND 104). SN 76-153,791. PUB. 2-26-2002. FILED 10-21-2000.
- 2,571,125. **AFN COMMUNICATIONS AND DESIGN**. AFN COMMUNICATIONS, LLC, (U.S. CLS. 100, 101 AND 104). SN 76-169,186. PUB. 2-26-2002. FILED 11-21-2000.
- 2,571,145. **PEGASUS EXPRESS**. PEGASUS COMMUNICATIONS CORPORATION, (U.S. CLS. 100, 101 AND 104). SN 76-176,289. PUB. 2-26-2002. FILED 12-6-2000.
- 2,571,508. **NNN NOW NEWS NETWORK**. NOW CORPORATION, (U.S. CLS. 100, 101 AND 104). SN 78-026,802. PUB. 2-26-2002. FILED 9-20-2000.
- 2,571,533 (*See Class 9 for this trademark*).
- 2,571,558 (*See Class 6 for this trademark*).
- 2,571,614. **SPIDERDANCE AND DESIGN**. SPIDERDANCE, INC., MULTIPLE CLASS, (INT. CLS. 38 AND 41), (U.S. CLS. 100, 101, 104 AND 107). SN 78-056,402. PUB. 2-26-2002. FILED 4-2-2001.
- 2,571,659. **VPUT**. SEABRIDGE LTD., (U.S. CLS. 100, 101 AND 104). SN 78-075,822. PUB. 2-26-2002. FILED 7-26-2001.
- 2,570,533 (*See Class 9 for this trademark*).
- 2,570,536. **ORICA AND DESIGN**. ORICA AUSTRALIA PTY LTD, (U.S. CLS. 100 AND 105). SN 75-505,639. PUB. 9-4-2001. FILED 6-19-1998.
- 2,570,659 (*See Class 35 for this trademark*).
- 2,570,669 (*See Class 35 for this trademark*).
- 2,570,700. **ASCOT**. ASCOT CAR & UTE RENTALS AUSTRALIA PTY LTD., (U.S. CLS. 100 AND 105). SN 75-879,239. PUB. 2-26-2002. FILED 12-23-1999.
- 2,570,783 (*See Class 35 for this trademark*).
- 2,570,810 (*See Class 35 for this trademark*).
- 2,570,811. **COTTON**. COTTON MOVING AND STORAGE, INC., (U.S. CLS. 100 AND 105). SN 76-047,504. PUB. 4-10-2001. FILED 5-15-2000.
- 2,570,821. **THUNDERBIRD LODGE PRESERVATION SOCIETY**. THUNDERBIRD LODGE PRESERVATION SOCIETY, MULTIPLE CLASS, (INT. CLS. 39 AND 42), (U.S. CLS. 100, 101 AND 105). SN 76-052,562. PUB. 2-26-2002. FILED 5-19-2000.
- 2,570,901. **DEPENDABLE HAWAIIAN EXPRESS**. DHX, INC., (U.S. CLS. 100 AND 105). SN 76-086,848. PUB. 2-26-2002. FILED 7-11-2000.
- 2,570,930 (*See Class 35 for this trademark*).
- 2,570,931 (*See Class 35 for this trademark*).
- 2,570,937. **GROUP ADVANTAGE AND DESIGN**. VANTAGE GROUP INC., THE, (U.S. CLS. 100 AND 105). SN 76-101,053. PUB. 6-26-2001. FILED 8-2-2000.
- 2,571,113. **ST. MICHAELS HARBOUR INN & MARINA AND DESIGN**. HARBOURSIDE, INC., MULTIPLE CLASS, (INT. CLS. 39 AND 42), (U.S. CLS. 100, 101 AND 105). SN 76-166,424. PUB. 2-26-2002. FILED 11-16-2000.
- 2,571,133. **SOLUTIONS-II, INC. THE SAN ARCHITECTS END USER DEPARTMENTS MIDRA MAINFRAME CLIENT/SERVER AND DESIGN**. SOLUTIONS-II, INC., (U.S. CLS. 100 AND 105). SN 76-171,444. PUB. 2-26-2002. FILED 11-28-2000.
- 2,571,148 (*See Class 25 for this trademark*).
- 2,571,276. **310 MOTORING**. 310 MOTORING CORPORATION, (U.S. CLS. 100 AND 105). SN 76-248,579. PUB. 2-26-2002. FILED 5-1-2001.
- 2,571,357. **PLEASANT AUSTRALIA HOLIDAYS**. PLEASANT HOLIDAYS, LLC, (U.S. CLS. 100 AND 105). SN 76-283,671. PUB. 2-26-2002. FILED 7-13-2001.
- 2,571,358. **PLEASANT NEW ZEALAND HOLIDAYS**. PLEASANT HOLIDAYS, LLC, (U.S. CLS. 100 AND 105). SN 76-283,673. PUB. 2-26-2002. FILED 7-13-2001.
- 2,571,470. **MERCURY**. CELEBRITY CRUISES INC., (U.S. CLS. 100 AND 105). SN 76-322,323. PUB. 2-26-2002. FILED 10-5-2001.
- 2,571,588. **ON-TRACK**. IOWA DEPARTMENT OF TRANSPORTATION, (U.S. CLS. 100 AND 105). SN 78-049,748. PUB. 2-26-2002. FILED 2-22-2001.
- 2,571,628. **MONTI VAN LINES**. LA ROSA DEL MONTE EXPRESS INC., BY ASSIGNMENT MONTI VAN LINES, INC., (U.S. CLS. 100 AND 105). SN 78-064,109. PUB. 2-26-2002. FILED 5-17-2001.
- 2,571,631. **SEVEN SEAS NAVIGATOR**. RADISSON SEVEN SEAS CRUISES, INC., (U.S. CLS. 100 AND 105). SN 78-066,846. PUB. 2-26-2002. FILED 6-1-2001.
- 2,571,652. **ABF U-PACK MOVING**. ABF FREIGHT SYSTEM, INC., (U.S. CLS. 100 AND 105). SN 78-073,842. PUB. 2-26-2002. FILED 7-13-2001.
- 2,571,653. **CRUISE HOUSE REMEMBER THIS TOLL-FREE NO. 1-888-SEA-LEGS 732-5347 FOR A GREAT CRUISE RATE ! AND DESIGN**. FAMILLETTE, JOHN, (U.S. CLS. 100 AND 105). SN 78-073,950. PUB. 2-26-2002. FILED 7-14-2001.

CLASS 39—TRANSPORTATION AND STORAGE

- 2,570,509. **TRAX**. TRAX WORLD TRAVEL & TOURS, INC., (U.S. CLS. 100 AND 105). SN 75-351,097. PUB. 10-30-2001. FILED 9-3-1997.
- 2,570,518. **GRAND SLAM TENNIS TOURS INC. AND DESIGN**. GRAND SLAM TENNIS TOURS INC., (U.S. CLS. 100 AND 105). SN 75-404,635. PUB. 2-26-2002. FILED 12-12-1997.
- 2,570,524. **DUCK TOURS**. BOSTON DUCK TOURS, LIMITED PARTNERSHIP, (U.S. CLS. 100 AND 105). SN 75-428,927. PUB. 9-21-1999. FILED 2-4-1998.

CLASS 40—MATERIAL TREATMENT

- 2,570,537. **ORICA AND DESIGN**. ORICA AUSTRALIA PTY LTD, (U.S. CLS. 100, 103 AND 106). SN 75-505,640. PUB. 9-4-2001. FILED 6-19-1998.
- 2,570,604 (*See Class 35 for this trademark*).
- 2,570,670 (*See Class 6 for this trademark*).
- 2,570,728. **NEXUS**. NEXUS TECHNOLOGIES, MULTIPLE

CLASS. (INT. CLS. 40 AND 42), (U.S. CLS. 100, 101, 103 AND 106). SN 75-922,276. PUB. 6-5-2001. FILED 2-18-2000.
 2,570,790 (*See Class 35 for this trademark.*)
 2,570,931 (*See Class 35 for this trademark.*)
 2,571,029 (*See Class 9 for this trademark.*)
 2,571,340. **BIGSHOT CLUB**. NFP PHOTO, (U.S. CLS. 100, 103 AND 106). SN 76-276,291. PUB. 2-26-2002. FILED 6-25-2001.
 2,571,451 (*See Class 20 for this trademark.*)

CLASS 41—EDUCATION AND ENTERTAINMENT

- 2,570,485. **CHRISTIAN HERITAGE MINISTRIES**. MILLARD, CATHERINE, DBA CHRISTIAN HERITAGE TOURS, INC., (U.S. CLS. 100, 101 AND 107). SN 75-023,501. PUB. 4-1-1997. FILED 11-24-1995.
 2,570,490 (*See Class 3 for this trademark.*)
 2,570,494 (*See Class 35 for this trademark.*)
 2,570,501 (*See Class 35 for this trademark.*)
 2,570,502. **THE SUPERBOWL OF INDEXING**. INFORMATION MANAGEMENT NETWORK, INC., (U.S. CLS. 100, 101 AND 107). SN 75-304,838. PUB. 4-21-1998. FILED 6-6-1997.
 2,570,532. **SCAD BEES AND DESIGN**. SAVANNAH COLLEGE OF ART AND DESIGN, INC., (U.S. CLS. 100, 101 AND 107). SN 75-502,576. PUB. 12-28-1999. FILED 6-15-1998.
 2,570,533 (*See Class 9 for this trademark.*)
 2,570,547 (*See Class 9 for this trademark.*)
 2,570,576 (*See Class 10 for this trademark.*)
 2,570,580 (*See Class 25 for this trademark.*)
 2,570,582. **HANNAIAN**. HANNA, HARLINGTON L., JR., (U.S. CLS. 100, 101 AND 107). SN 75-647,651. PUB. 2-26-2002. FILED 3-3-1999.
 2,570,584. **MISCELLANEOUS DESIGN**. KITCHEN WHORE RECORDS, (U.S. CLS. 100, 101 AND 107). SN 75-660,693. PUB. 2-26-2002. FILED 3-15-1999.
 2,570,591 (*See Class 16 for this trademark.*)
 2,570,598 (*See Class 18 for this trademark.*)
 2,570,599 (*See Class 15 for this trademark.*)
 2,570,606. **FLAVA ZONE**. INNER CITY BROADCASTING CORPORATION, (U.S. CLS. 100, 101 AND 107). SN 75-722,087. PUB. 2-26-2002. FILED 6-4-1999.
 2,570,607. **JOY IN THE MORNING**. INNER CITY BROADCASTING CORPORATION, (U.S. CLS. 100, 101 AND 107). SN 75-722,088. PUB. 2-26-2002. FILED 6-4-1999.
 2,570,609. **DOODY'S**. MDLB ENTERPRISES, LLC., DBA DOODY PUBLISHING, MULTIPLE CLASS, (INT. CLS. 41 AND 42), (U.S. CLS. 100, 101 AND 107). SN 75-731,999. PUB. 2-26-2002. FILED 6-18-1999.
 2,570,620. **TRAILERVISION**. TRAILERVISION, INC., BY ASSIGNMENT NERENBERG, ALBERT, (U.S. CLS. 100, 101 AND 107). SN 75-758,766. PUB. 2-26-2002. FILED 7-23-1999.
 2,570,628 (*See Class 9 for this trademark.*)
 2,570,641 (*See Class 16 for this trademark.*)
 2,570,657 (*See Class 35 for this trademark.*)
 2,570,667. **ALVA LEARNING SYSTEMS**. ALVA LEARNING SYSTEMS, LLC., (U.S. CLS. 100, 101 AND 107). SN 75-836,645. PUB. 2-26-2002. FILED 11-1-1999.
 2,570,678. **HEAR ME & CO.**. HEAR ME & CO., MULTIPLE CLASS, (INT. CLS. 41 AND 42), (U.S. CLS. 100, 101 AND 107). SN 75-856,897. PUB. 2-26-2002. FILED 11-23-1999.
 2,570,679 (*See Class 38 for this trademark.*)
 2,570,680. **PSYCH TODAY (STYLIZED)**. SUSSEX PUBLISHERS, INC., (U.S. CLS. 100, 101 AND 107). SN 75-861,308. PUB. 2-26-2002. FILED 12-2-1999.
 2,570,697. **CARING FOR CREATION**. NORTH AMERICAN COALITION ON RELIGION AND ECOLOGY, (U.S. CLS. 100, 101 AND 107). SN 75-875,483. PUB. 2-26-2002. FILED 1-3-2000.
 2,570,720. **CLASSIC SOUL SUNDAY**. INNER CITY BROADCASTING CORPORATION OF BERKELEY, (U.S. CLS. 100, 101 AND 107). SN 75-914,292. PUB. 2-26-2002. FILED 2-8-2000.
 2,570,729 (*See Class 25 for this trademark.*)
 2,570,753 (*See Class 16 for this trademark.*)
 2,570,767. **COMPASS KIDS' CLUB**. MARRIOTT INTERNATIONAL, INC., (U.S. CLS. 100, 101 AND 107). SN 76-013,293. PUB. 2-26-2002. FILED 3-28-2000.
 2,570,769 (*See Class 36 for this trademark.*)
 2,570,770 (*See Class 36 for this trademark.*)
 2,570,771 (*See Class 38 for this trademark.*)
 2,570,784. **NATIONAL TRAINING RINKS POND HOCKEY LEAGUE 3 PHL 3 AND DESIGN**. NATIONAL TRAINING RINK CORP., (U.S. CLS. 100, 101 AND 107). SN 76-024,139. PUB. 2-6-2001. FILED 4-12-2000.
 2,570,808 (*See Class 35 for this trademark.*)
 2,570,819. **OPTIMUM BOOT CAMP**. VERELA, RAPHAEL, (U.S. CLS. 100, 101 AND 107). SN 76-051,932. PUB. 2-26-2002. FILED 5-17-2000.
 2,570,838 (*See Class 25 for this trademark.*)
 2,570,843. **SUMMER SANITARIUM TOUR**. METALLICA, (U.S. CLS. 100, 101 AND 107). SN 76-065,401. PUB. 2-26-2002. FILED 6-6-2000.
 2,570,855. **WHAT'S IN MY POCKET**. WIMP, LLC, (U.S. CLS. 100, 101 AND 107). SN 76-070,915. PUB. 2-26-2002. FILED 6-15-2000.
 2,570,862. **DIRT ROAD PRODUCTIONS**. DIRT ROAD PRODUCTIONS, INC., (U.S. CLS. 100, 101 AND 107). SN 76-073,678. PUB. 2-26-2002. FILED 6-19-2000.
 2,570,887. **STARTCAMP**. STARTECH EARLY VENTURES, LLC, BY CHANGE OF NAME STARTECH BUSINESS DEVELOPMENT, L.L.C., (U.S. CLS. 100, 101 AND 107). SN 76-081,240. PUB. 2-26-2002. FILED 6-30-2000.
 2,570,905 (*See Class 9 for this trademark.*)
 2,570,906 (*See Class 9 for this trademark.*)
 2,570,914 (*See Class 9 for this trademark.*)
 2,570,921. **OYSTER**. MOUNTAINTOP PUBLISHING, INC., (U.S. CLS. 100, 101 AND 107). SN 76-093,965. PUB. 2-26-2002. FILED 7-21-2000.
 2,570,925. **THE WORK**. BYRON KATIE, INC., (U.S. CLS. 100, 101 AND 107). SN 76-095,964. PUB. 2-26-2002. FILED 7-25-2000.
 2,570,928. **B BELLAGIO (STYLIZED)**. BELLAGIO, LLC., BY MERGER BELLAGIO, (U.S. CLS. 100, 101 AND 107). SN 76-096,893. PUB. 2-26-2002. FILED 7-26-2000.
 2,570,953. **KNOWLEDGEPHARM**. INTELICUS, L.C., (U.S. CLS. 100, 101 AND 107). SN 76-108,045. PUB. 2-26-2002. FILED 8-11-2000.
 2,570,955. **VIRTUAL ATHLETE**. GAMES MAGNET LIMITED, (U.S. CLS. 100, 101 AND 107). SN 76-108,829. PUB. 2-26-2002. FILED 8-14-2000.
 2,570,961. **THE FAMILY Y AND DESIGN**. FAMILY Y, THE, (U.S. CLS. 100, 101 AND 107). SN 76-110,593. PUB. 2-26-2002. FILED 8-17-2000.
 2,570,963 (*See Class 35 for this trademark.*)
 2,571,011. **HOUSE OF BLUES HOB.COM IT IS LIVE. AND DESIGN**. HOUSE OF BLUES BRANDS CORP., (U.S. CLS. 100, 101 AND 107). SN 76-125,397. PUB. 2-26-2002. FILED 9-8-2000.
 2,571,015 (*See Class 16 for this trademark.*)
 2,571,024. **NOBLE**. ELLERBE, SHELTON MAURICE, (U.S. CLS. 100, 101 AND 107). SN 76-129,817. PUB. 2-26-2002. FILED 9-15-2000.
 2,571,031. **LIFESKILLS AND DESIGN**. NATIONAL HEALTH PROMOTION ASSOCIATES, INC., (U.S. CLS. 100, 101 AND 107). SN 76-133,384. PUB. 2-26-2002. FILED 9-22-2000.
 2,571,082. **FISHERTRAINER**. FISHER SCIENTIFIC COMPANY L.L.C., (U.S. CLS. 100, 101 AND 107). SN 76-154,180. PUB. 2-26-2002. FILED 10-26-2000.
 2,571,094. **HOFFMAN SPORTS ASSOCIATION**. HOFFMAN PROMOTIONS, INC., (U.S. CLS. 100, 101 AND 107). SN 76-159,361. PUB. 2-26-2002. FILED 11-3-2000.
 2,571,104. **CMEWEB**. ME LICENSING CORPORATION, (U.S. CLS. 100, 101 AND 107). SN 76-164,775. PUB. 2-26-2002. FILED 11-14-2000.
 2,571,105 (*See Class 16 for this trademark.*)
 2,571,117. **DISC (STYLIZED)**. INSCAPE PUBLISHING, INC., (U.S. CLS. 100, 101 AND 107). SN 76-166,727. PUB. 2-26-2002. FILED 11-16-2000.
 2,571,118. **DROFFACE**. LUKAS, JOHN, (U.S. CLS. 100, 101 AND 107). SN 76-167,072. PUB. 2-26-2002. FILED 11-20-2000.
 2,571,123. **ROY'S RESTAURANTS GOLF CLASSIC EST. 1998 AND DESIGN**. HAWAIIAN PACIFIC RESTAURANT

- GROUP, INC., (U.S. CLS. 100, 101 AND 107). SN 76-168,966. PUB. 2-26-2002. FILED 11-20-2000.
- 2,571,126. **SHOP 'TIL YOU DROP AND DESIGN.** STONE STANLEY PRODUCTIONS, (U.S. CLS. 100, 101 AND 107). SN 76-169,277. PUB. 2-26-2002. FILED 11-21-2000.
- 2,571,144. **DAVE CUMMINGS.** CONNERS, DAVID C., (U.S. CLS. 100, 101 AND 107). SN 76-176,044. PUB. 2-26-2002. FILED 12-6-2000.
- 2,571,147. **DO IT.** JOSLIN DIABETES CENTER, INC., MULTIPLE CLASS, (INT. CLS. 41 AND 42), (U.S. CLS. 100, 101 AND 107). SN 76-177,657. PUB. 10-30-2001. FILED 12-7-2000.
- 2,571,163. **SPICE PLATINUM.** SPICE ENTERTAINMENT, INC., (U.S. CLS. 100, 101 AND 107). SN 76-187,076. PUB. 2-26-2002. FILED 12-28-2000.
- 2,571,167. **BLUE CEILING.** ERIC JUSTICE AND RENE COLLINS PARTNERSHIP, THE, (U.S. CLS. 100, 101 AND 107). SN 76-189,134. PUB. 2-26-2002. FILED 1-4-2001.
- 2,571,176. **GLADIATOR.** JAMDAT MOBILE INC., (U.S. CLS. 100, 101 AND 107). SN 76-196,995. PUB. 2-26-2002. FILED 1-19-2001.
- 2,571,204. **ALLISTER.** MURPHY, SCOTT, AND ROGNER, TIM, AND HAMADA, JOHN, AND ROSSI, DAVID, (U.S. CLS. 100, 101 AND 107). SN 76-219,095. PUB. 2-26-2002. FILED 3-2-2001.
- 2,571,206. **MAGIC WAREHOUSE.** PASSE, JAMES G., (U.S. CLS. 100, 101 AND 107). SN 76-220,645. PUB. 2-26-2002. FILED 3-7-2001.
- 2,571,210 (*See Class 16 for this trademark.*).
- 2,571,216 (*See Class 16 for this trademark.*).
- 2,571,221. **I-CAR INDUSTRY TRAINING ALLIANCE AND DESIGN.** INTER-INDUSTRY CONFERENCE ON AUTO COLLISION REPAIR, (U.S. CLS. 100, 101 AND 107). SN 76-225,603. PUB. 2-26-2002. FILED 3-19-2001.
- 2,571,230 (*See Class 9 for this trademark.*).
- 2,571,249. **READING IN GOOD TASTE.** CHOCOLATE RESEARCH & AMERICAN CULINARY HISTORY LIBRARY, LTD., (U.S. CLS. 100, 101 AND 107). SN 76-239,761. PUB. 2-26-2002. FILED 4-13-2001.
- 2,571,250. **READY TO GROW AND DESIGN.** MARYLAND PUBLIC BROADCASTING COMMISSION, (U.S. CLS. 100, 101 AND 107). SN 76-239,881. PUB. 2-26-2002. FILED 4-13-2001.
- 2,571,271. **PEACEBIKE.** PEACEBIKE, (U.S. CLS. 100, 101 AND 107). SN 76-247,561. PUB. 2-26-2002. FILED 4-27-2001.
- 2,571,285 (*See Class 9 for this trademark.*).
- 2,571,288. **ELDERSHARING.** MOSLEY, MELISSA M., (U.S. CLS. 100, 101 AND 107). SN 76-255,103. PUB. 2-26-2002. FILED 5-11-2001.
- 2,571,295. **SUPER SCIENTIFIC CIRCUS.** SUPER SCIENTIFIC CIRCUS, INC., (U.S. CLS. 100, 101 AND 107). SN 76-260,386. PUB. 2-26-2002. FILED 5-21-2001.
- 2,571,300. **WILDBIRD RECORDS.** WALL, WENDY, (U.S. CLS. 100, 101 AND 107). SN 76-261,122. PUB. 2-26-2002. FILED 5-23-2001.
- 2,571,313. **PINNACLE COACHING ASSOCIATES (STYLIZED).** PINNACLE COACHING ASSOCIATES, INC., (U.S. CLS. 100, 101 AND 107). SN 76-265,454. PUB. 2-26-2002. FILED 6-4-2001.
- 2,571,316. **RULE OF THE RECTANGLE.** K VALLEY ORTHOPEDICS, P.C., (U.S. CLS. 100, 101 AND 107). SN 76-267,487. PUB. 2-26-2002. FILED 6-7-2001.
- 2,571,318 (*See Class 35 for this trademark.*).
- 2,571,319. **COMEDY TONIGHT!** PRODUCING OPPORTUNITY AND PROSPERITY, INC., (U.S. CLS. 100, 101 AND 107). SN 76-268,575. PUB. 2-26-2002. FILED 6-8-2001.
- 2,571,320. **NIGHTWRITERS.** PHYLLIS G. THEROUX, DBA NIGHTWRITERS, INC., (U.S. CLS. 100, 101 AND 107). SN 76-268,716. PUB. 2-26-2002. FILED 6-6-2001.
- 2,571,325 (*See Class 25 for this trademark.*).
- 2,571,338. **T.R.U.S.T..** PISCITELLI, THOMAS J., (U.S. CLS. 100, 101 AND 107). SN 76-276,214. PUB. 2-26-2002. FILED 6-26-2001.
- 2,571,341. **DATAVOX.** DATAVOX BUSINESS COMMUNICATIONS, (U.S. CLS. 100, 101 AND 107). SN 76-276,453. PUB. 2-26-2002. FILED 6-25-2001.
- 2,571,346. **SCARED CHERRY.** ODETT, KIETH, (U.S. CLS. 100, 101 AND 107). SN 76-278,028. PUB. 2-26-2002. FILED 6-27-2001.
- 2,571,367. **OMC ON MISSION CELEBRATION AND DESIGN.** NORTH AMERICAN MISSION BOARD OF THE SOUTHERN BAPTIST CONVENTION, INC., THE, (U.S. CLS. 100, 101 AND 107). SN 76-286,550. PUB. 2-26-2002. FILED 7-10-2001.
- 2,571,369. **ETERNAL SPRING TAI CHI.** TAI CHI CHUAN CENTER INC., (U.S. CLS. 100, 101 AND 107). SN 76-287,706. PUB. 2-26-2002. FILED 7-20-2001.
- 2,571,373. **REBELLI ACHE AND DESIGN.** GFI HOLDINGS, INC., (U.S. CLS. 100, 101 AND 107). SN 76-290,562. PUB. 2-26-2002. FILED 7-27-2001.
- 2,571,374. **POWERED BY E REFERENCE DESK AND DESIGN.** EREFERENCEDESK, LLC, (U.S. CLS. 100, 101 AND 107). SN 76-291,450. PUB. 2-26-2002. FILED 7-27-2001.
- 2,571,390. **'BURGH BUSTERS.** PITTSBURGH DOWNTOWN PARTNERSHIP, THE, (U.S. CLS. 100, 101 AND 107). SN 76-302,648. PUB. 2-26-2002. FILED 8-21-2001.
- 2,571,410 (*See Class 16 for this trademark.*).
- 2,571,447. **BRIGHT SKY PRESS.** BREAKAWAY PUBLISHING, LTD., (U.S. CLS. 100, 101 AND 107). SN 76-317,033. PUB. 2-26-2002. FILED 9-25-2001.
- 2,571,482 (*See Class 25 for this trademark.*).
- 2,571,500. **MOBOD.** GARRABRANT, SCOTT J., (U.S. CLS. 100, 101 AND 107). SN 78-023,325. PUB. 2-26-2002. FILED 8-28-2000.
- 2,571,518. **PLAYSYS.COM.** PLAYSYS.COM, (U.S. CLS. 100, 101 AND 107). SN 78-030,402. PUB. 2-26-2002. FILED 10-12-2000.
- 2,571,519. **PLAYSYS.COM AND DESIGN.** PLAYSYS.COM, INC., (U.S. CLS. 100, 101 AND 107). SN 78-030,407. PUB. 2-26-2002. FILED 10-12-2000.
- 2,571,524. **SEED PLANTERS.** BLACK HAWK-GRUNDY MENTAL HEALTH CENTER, INC., (U.S. CLS. 100, 101 AND 107). SN 78-031,958. PUB. 2-26-2002. FILED 10-23-2000.
- 2,571,540. **BATTLE OF THE BARGES.** BOSTON'S FOURTH OF JULY, INC., (U.S. CLS. 100, 101 AND 107). SN 78-035,765. PUB. 2-26-2002. FILED 11-17-2000.
- 2,571,541. **OPEN FOR BUSINESS.** CARRIAGE TRADE PUBLICATIONS II, INC., DBA CARRIAGE TRADE PUBLIC RELATIONS, INC., (U.S. CLS. 100, 101 AND 107). SN 78-035,927. PUB. 2-26-2002. FILED 11-18-2000.
- 2,571,569. **TEMPTATION ISLAND.** FOX BROADCASTING COMPANY, (U.S. CLS. 100, 101 AND 107). SN 78-044,076. PUB. 2-26-2002. FILED 1-19-2001.
- 2,571,578. **MARCHAEROBICS.** CASTALDI, TINA, (U.S. CLS. 100, 101 AND 107). SN 78-045,967. PUB. 2-26-2002. FILED 1-31-2001.
- 2,571,591. **BENNY BLANCO.** BENSHP, JOHN, (U.S. CLS. 100, 101 AND 107). SN 78-049,839. PUB. 2-26-2002. FILED 2-22-2001.
- 2,571,592. **CAREER/LIFE PLANNING.** DARDEN, KAREN M., AND PARKINSON, GABRIELLE, (U.S. CLS. 100, 101 AND 107). SN 78-050,020. PUB. 2-26-2002. FILED 2-23-2001.
- 2,571,607. **THE JUNIOR AMERICA TALENT SHOW.** SMITH, LARRY, M., (U.S. CLS. 100, 101 AND 107). SN 78-055,040. PUB. 2-26-2002. FILED 3-26-2001.
- 2,571,614 (*See Class 38 for this trademark.*).
- 2,571,615. **MISCELLANEOUS DESIGN.** PROFESSIONAL GOLFERS' ASSOCIATION OF AMERICA, THE, (U.S. CLS. 100, 101 AND 107). SN 78-056,770. PUB. 2-26-2002. FILED 4-4-2001.
- 2,571,630 (*See Class 16 for this trademark.*).
- 2,571,637. **BIKE & BRUNCH AND DESIGN.** BIKE & BRUNCH, INC., (U.S. CLS. 100, 101 AND 107). SN 78-070,784. PUB. 2-26-2002. FILED 6-25-2001.
- 2,571,647. **SWAMP DRAGONS.** MSE SHREVEPORT, LLC, (U.S. CLS. 100, 101 AND 107). SN 78-072,259. PUB. 2-26-2002. FILED 7-3-2001.
- 2,571,661. **SACRED CENTERS.** JUDITH, ANODEA, (U.S. CLS. 100, 101 AND 107). SN 78-076,325. PUB. 2-26-2002. FILED 7-30-2001.
- 2,571,671. **MARK! MY WORDS.** EVANS, MARK, (U.S. CLS. 100, 101 AND 107). SN 78-081,930. PUB. 2-26-2002. FILED 8-30-2001.

CLASS 42—SCIENTIFIC, COMPUTER AND LEGAL SERVICES

- 2,570,484. **800 SPIRITS**. 800 SPIRITS, INC., (U.S. CLS. 100 AND 101). SN 75-012,852. PUB. 12-17-1996. FILED 10-31-1995.
- 2,570,494 (*See Class 35 for this trademark*).
- 2,570,505 (*See Class 9 for this trademark*).
- 2,570,513 (*See Class 35 for this trademark*).
- 2,570,517 (*See Class 37 for this trademark*).
- 2,570,521 (*See Class 30 for this trademark*).
- 2,570,530 (*See Class 9 for this trademark*).
- 2,570,533 (*See Class 9 for this trademark*).
- 2,570,538 (*See Class 35 for this trademark*).
- 2,570,545 (*See Class 9 for this trademark*).
- 2,570,548 (*See Class 9 for this trademark*).
- 2,570,549 (*See Class 35 for this trademark*).
- 2,570,553 (*See Class 1 for this trademark*).
- 2,570,558. **MIGUEL'S COCINA**. BRIGANTINE, THE, (U.S. CLS. 100 AND 101). SN 75-592,034. PUB. 2-26-2002. FILED 11-19-1998.
- 2,570,560. **RAPIDCHANNEL DELIVERY**. FOURTHCHANNEL, INC., (U.S. CLS. 100 AND 101). SN 75-598,616. PUB. 2-26-2002. FILED 12-3-1998.
- 2,570,589. **NUSIL**. NUSIL TECHNOLOGY, (U.S. CLS. 100 AND 101). SN 75-674,237. PUB. 2-26-2002. FILED 4-5-1999.
- 2,570,591 (*See Class 16 for this trademark*).
- 2,570,600. **LEXGEN.COM**. LEXICON GENETICS INCORPORATED, (U.S. CLS. 100 AND 101). SN 75-702,564. PUB. 8-22-2000. FILED 5-11-1999.
- 2,570,608. **THE MAIN INGREDIENT**. SAGE DINING SERVICES, INC., (U.S. CLS. 100 AND 101). SN 75-731,710. PUB. 2-26-2002. FILED 6-18-1999.
- 2,570,609 (*See Class 41 for this trademark*).
- 2,570,614 (*See Class 35 for this trademark*).
- 2,570,622 (*See Class 35 for this trademark*).
- 2,570,625. **E AND DESIGN**. EBRARY.COM, (U.S. CLS. 100 AND 101). SN 75-765,333. PUB. 2-26-2002. FILED 8-25-1999.
- 2,570,628 (*See Class 9 for this trademark*).
- 2,570,648. **STRATEGIC QUALITYCARE**. QUALITYLOGIC, INC., (U.S. CLS. 100 AND 101). SN 75-803,104. PUB. 5-22-2001. FILED 9-20-1999.
- 2,570,650 (*See Class 30 for this trademark*).
- 2,570,654. **EDR - ELECTRONIC DESIGN REVIEW**. DOHRING, RAHN, (U.S. CLS. 100 AND 101). SN 75-815,516. PUB. 2-27-2001. FILED 10-27-1999.
- 2,570,656. **QUE BUENO! MEXICAN GRILLE AND DESIGN**. MISSION YOGURT, INC., (U.S. CLS. 100 AND 101). SN 75-817,873. PUB. 2-26-2002. FILED 10-7-1999.
- 2,570,657 (*See Class 35 for this trademark*).
- 2,570,664. **RELAX AND RESTORE**. LINDAV USA, INC., (U.S. CLS. 100 AND 101). SN 75-825,784. PUB. 8-7-2001. FILED 10-18-1999.
- 2,570,671. **SL STAY LODGE EFFICIENCY STUDIOS AND DESIGN**. HERNDON PROPERTIES, L.L.C., (U.S. CLS. 100 AND 101). SN 75-843,744. PUB. 2-26-2002. FILED 11-9-1999.
- 2,570,673 (*See Class 9 for this trademark*).
- 2,570,678 (*See Class 41 for this trademark*).
- 2,570,695 (*See Class 36 for this trademark*).
- 2,570,703 (*See Class 35 for this trademark*).
- 2,570,705 (*See Class 37 for this trademark*).
- 2,570,707 (*See Class 9 for this trademark*).
- 2,570,709 (*See Class 9 for this trademark*).
- 2,570,714. **REAL TIME REAL ORGANIZED REAL SIMPLE**. NMXS.COM, INC., (U.S. CLS. 100 AND 101). SN 75-903,875. PUB. 2-26-2002. FILED 1-27-2000.
- 2,570,715. **EDGARNEWS**. FINANCIAL INSIGHT SYSTEMS, INC., (U.S. CLS. 100 AND 101). SN 75-904,304. PUB. 11-13-2001. FILED 1-27-2000.
- 2,570,719 (*See Class 25 for this trademark*).
- 2,570,722 (*See Class 35 for this trademark*).
- 2,570,727. **ACRYSHIELD**. BETZDEARBORN INC., (U.S. CLS. 100 AND 101). SN 75-922,231. PUB. 10-10-2000. FILED 2-18-2000.
- 2,570,728 (*See Class 40 for this trademark*).
- 2,570,734 (*See Class 1 for this trademark*).
- 2,570,737. **1-800-BABY-BOY**. KROHN, RABBI YEHOShUA, (U.S. CLS. 100 AND 101). SN 75-936,581. PUB. 2-26-2002. FILED 3-6-2000.
- 2,570,746. **AMIHEALTHY.COM**. QUALITYMETRIC INCORPORATED, (U.S. CLS. 100 AND 101). SN 75-941,196. PUB. 2-26-2002. FILED 3-10-2000.
- 2,570,760. **THE KNOWLEDGE BOX**. BB TECHNOLOGIES, INC., (U.S. CLS. 100 AND 101). SN 76-005,172. PUB. 6-5-2001. FILED 3-20-2000.
- 2,570,764 (*See Class 7 for this trademark*).
- 2,570,769 (*See Class 36 for this trademark*).
- 2,570,770 (*See Class 36 for this trademark*).
- 2,570,771 (*See Class 38 for this trademark*).
- 2,570,776 (*See Class 38 for this trademark*).
- 2,570,777. **ONLYLINK.COM AND DESIGN**. FIA OF ST. LOUIS, L.L.C., DBA FIRST INTERNET WORLDWIDE, (U.S. CLS. 100 AND 101). SN 76-021,690. PUB. 2-26-2002. FILED 4-10-2000.
- 2,570,782. **GLOBAL MEDIA PARTNER**. EMOTION, INC., (U.S. CLS. 100 AND 101). SN 76-023,802. PUB. 2-26-2002. FILED 4-13-2000.
- 2,570,789. **TOUCH-MAP**. TOUCH-MAP SYSTEMS, (U.S. CLS. 100 AND 101). SN 76-027,967. PUB. 2-26-2002. FILED 4-18-2000.
- 2,570,790 (*See Class 35 for this trademark*).
- 2,570,805 (*See Class 35 for this trademark*).
- 2,570,810 (*See Class 35 for this trademark*).
- 2,570,821 (*See Class 39 for this trademark*).
- 2,570,822. **LYDIA HOUSE**. RESCUE MISSION, INC., (U.S. CLS. 100 AND 101). SN 76-053,323. PUB. 2-26-2002. FILED 5-24-2000.
- 2,570,827 (*See Class 16 for this trademark*).
- 2,570,829. **CES N AND DESIGN**. CES INC., (U.S. CLS. 100 AND 101). SN 76-057,429. PUB. 2-26-2002. FILED 5-26-2000.
- 2,570,831. **DATING TODAY**. PHUTURECORP, INC., (U.S. CLS. 100 AND 101). SN 76-057,913. PUB. 2-26-2002. FILED 5-26-2000.
- 2,570,835. **S.A.F.E. SAFE ACTION FOR EMPLOYEES**. NEW ENGLAND LABORERS HEALTH & SAFETY FUND, (U.S. CLS. 100 AND 101). SN 76-059,286. PUB. 2-26-2002. FILED 5-30-2000.
- 2,570,845 (*See Class 35 for this trademark*).
- 2,570,849. **ERNIE**. ALERTS.COM, INC., (U.S. CLS. 100 AND 101). SN 76-067,964. PUB. 2-26-2002. FILED 6-12-2000.
- 2,570,853 (*See Class 7 for this trademark*).
- 2,570,856. **TEN PENH AND DESIGN**. PASSION FOOD TWO, LLC, (U.S. CLS. 100 AND 101). SN 76-071,020. PUB. 2-26-2002. FILED 6-15-2000.
- 2,570,865. **MERCY SHIPS**. MERCY SHIPS, (U.S. CLS. 100 AND 101). SN 76-075,599. PUB. 2-26-2002. FILED 6-22-2000.
- 2,570,870. **LEAD DATA TECHNOLOGIES, INC. AND DESIGN**. LEAD DATA TECHNOLOGIES, INC., (U.S. CLS. 100 AND 101). SN 76-076,921. PUB. 2-26-2002. FILED 6-21-2000.
- 2,570,874. **DENTAL RESOURCE ALLIANCE**. DENTAL RESOURCE ALLIANCE, INC., (U.S. CLS. 100 AND 101). SN 76-078,006. PUB. 2-26-2002. FILED 6-26-2000.
- 2,570,877. **TANISTRY**. TANISTRY, INC., (U.S. CLS. 100 AND 101). SN 76-078,539. PUB. 12-25-2001. FILED 6-27-2000.
- 2,570,878. **BUZZPAPERS**. MASSACHUSETTS ELECTRONIC COMMERCE ASSOCIATION, INC., (U.S. CLS. 100 AND 101). SN 76-078,616. PUB. 2-26-2002. FILED 6-22-2000.
- 2,570,879. **THIRD COAST MEDIA**. THIRD COAST MEDIA, LLC, (U.S. CLS. 100 AND 101). SN 76-079,277. PUB. 2-26-2002. FILED 6-27-2000.
- 2,570,882. **DIRECTLINC**. MANAGED HEALTH NETWORK, INC., (U.S. CLS. 100 AND 101). SN 76-079,962. PUB. 2-26-2002. FILED 6-28-2000.
- 2,570,888. **DBZAP**. COMPUTER SUPPORT SERVICES, INC., (U.S. CLS. 100 AND 101). SN 76-081,458. PUB. 2-26-2002. FILED 6-30-2000.
- 2,570,896 (*See Class 35 for this trademark*).
- 2,570,903. **WHY SUFFER?**. HEALTHCARE TECHNOLOGY SYSTEMS, INC., BY ASSIGNMENT HEALTHCARE TECHNOLOGY MARKETING, INC., (U.S. CLS. 100 AND 101). SN 76-087,058. PUB. 2-26-2002. FILED 7-11-2000.
- 2,570,908. **SOLUTIONS BUTZEL LONG A PROFESSIONAL CORPORATION AND DESIGN**. BUTZEL LONG, (U.S. CLS. 100 AND 101). SN 76-088,200. PUB. 2-26-2002. FILED 7-17-2000.
- 2,570,914 (*See Class 9 for this trademark*).
- 2,570,923. **DECK AMERICA**. DECK AMERICA, INC., (U.S.

- CLS. 100 AND 101). SN 76-095,436. PUB. 2-26-2002. FILED 7-25-2000.
- 2,570,924. **DECK AMERICA AND DESIGN**. DECK AMERICA, INC., (U.S. CLS. 100 AND 101). SN 76-095,448. PUB. 2-26-2002. FILED 7-25-2000.
- 2,570,931 (*See Class 35 for this trademark*).
- 2,570,934. **MUSEUM ADVOCACY TEAM**. AMERICAN ASSOCIATION OF MUSEUMS, (U.S. CLS. 100 AND 101). SN 76-100,164. PUB. 2-26-2002. FILED 8-1-2000.
- 2,570,939. **WISE EARS!**. NATIONAL INSTITUTE ON DEAFNESS AND OTHER COMMUNICATION DISORDERS, (U.S. CLS. 100 AND 101). SN 76-101,655. PUB. 2-26-2002. FILED 6-5-2000.
- 2,570,944. **MR. HAPPY SPOON**. FLAVORX, INC., (U.S. CLS. 100 AND 101). SN 76-103,138. PUB. 2-26-2002. FILED 8-7-2000.
- 2,570,963 (*See Class 35 for this trademark*).
- 2,570,965. **EL AND DESIGN**. SMITH HELMS MULLISS & MOORE, L.L.P., (U.S. CLS. 100 AND 101). SN 76-112,934. PUB. 2-26-2002. FILED 8-21-2000.
- 2,570,985. **VTP**. VIACORE, INC., (U.S. CLS. 100 AND 101). SN 76-117,779. PUB. 2-26-2002. FILED 8-28-2000.
- 2,570,987 (*See Class 37 for this trademark*).
- 2,571,006. **GOTTAHAVVA BIG H**. HIRE ENTERPRISES, INC., (U.S. CLS. 100 AND 101). SN 76-124,164. PUB. 2-26-2002. FILED 9-6-2000.
- 2,571,008 (*See Class 37 for this trademark*).
- 2,571,012. **OFT AND DESIGN**. NEW YORK STATE OFFICE FOR TECHNOLOGY, (U.S. CLS. 100 AND 101). SN 76-125,635. PUB. 2-26-2002. FILED 9-11-2000.
- 2,571,015 (*See Class 16 for this trademark*).
- 2,571,029 (*See Class 9 for this trademark*).
- 2,571,033. **TREEWELL**. APPLIED NATURAL SCIENCES, INC., (U.S. CLS. 100 AND 101). SN 76-133,953. PUB. 2-26-2002. FILED 9-22-2000.
- 2,571,035. **FC (STYLIZED)**. FUTURE COMMUNICATIONS GROUP, LTD. (U.S. CLS. 100 AND 101). SN 76-134,335. PUB. 2-26-2002. FILED 9-25-2000.
- 2,571,040. **HOGAR CREA INTERNACIONAL, INC.**. HOGAR CREA INTERNACIONAL, INC., (U.S. CLS. 100 AND 101). SN 76-135,641. PUB. 2-26-2002. FILED 9-26-2000.
- 2,571,046. **BE IMATRON CERTAIN AND DESIGN**. IMATRON, INC., (U.S. CLS. 100 AND 101). SN 76-138,679. PUB. 2-26-2002. FILED 10-2-2000.
- 2,571,058. **SEEIDEAS PRODUCT DEVELOPMENT AND DESIGN**. SEEIDEAS, INC., (U.S. CLS. 100 AND 101). SN 76-144,444. PUB. 2-26-2002. FILED 10-6-2000.
- 2,571,062. **FORTIFIED NETWORKS**. FORTIFIED NETWORKS, INC., (U.S. CLS. 100 AND 101). SN 76-145,451. PUB. 2-26-2002. FILED 10-13-2000.
- 2,571,074 (*See Class 37 for this trademark*).
- 2,571,076. **ARC AND DESIGN**. ALTERNATIVE RESOLUTION CENTERS, (U.S. CLS. 100 AND 101). SN 76-151,246. PUB. 2-26-2002. FILED 10-20-2000.
- 2,571,095 (*See Class 30 for this trademark*).
- 2,571,096. **THE SOLUTION MACHINE**. ENGINEERING.COM INCORPORATED, (U.S. CLS. 100 AND 101). SN 76-160,068. PUB. 2-26-2002. FILED 11-6-2000.
- 2,571,100. **DIG**. CNA FINANCIAL CORPORATION, (U.S. CLS. 100 AND 101). SN 76-160,945. PUB. 2-26-2002. FILED 11-7-2000.
- 2,571,102 (*See Class 9 for this trademark*).
- 2,571,109. **MAXIM HEALTH SYSTEMS**. MAXIM HEALTHCARE SERVICES, INC., (U.S. CLS. 100 AND 101). SN 76-165,856. PUB. 2-26-2002. FILED 11-15-2000.
- 2,571,113 (*See Class 39 for this trademark*).
- 2,571,130 (*See Class 9 for this trademark*).
- 2,571,143. **NIMS**. NIMS ASSOCIATES, INC., (U.S. CLS. 100 AND 101). SN 76-175,751. PUB. 2-26-2002. FILED 12-6-2000.
- 2,571,147 (*See Class 41 for this trademark*).
- 2,571,153. **EXTATICA**. EXTATICA, INC., (U.S. CLS. 100 AND 101). SN 76-179,330. PUB. 2-26-2002. FILED 12-11-2000.
- 2,571,159. **SCORE 2000**. BOARD OF TRUSTEES OF THE LELAND STANFORD JUNIOR UNIVERSITY, THE, (U.S. CLS. 100 AND 101). SN 76-183,314. PUB. 2-26-2002. FILED 12-18-2000.
- 2,571,169. **PORK ALERT**. VANCE PUBLISHING CORPORATION, (U.S. CLS. 100 AND 101). SN 76-190,226. PUB. 2-26-2002. FILED 1-5-2001.
- 2,571,173 (*See Class 29 for this trademark*).
- 2,571,179. **DOUBLETWIST.COM**. DOUBLETWIST, INC., (U.S. CLS. 100 AND 101). SN 76-199,559. PUB. 2-26-2002. FILED 1-23-2001.
- 2,571,180. **DOUBLETWIST**. DOUBLETWIST, INC., (U.S. CLS. 100 AND 101). SN 76-199,633. PUB. 2-26-2002. FILED 1-23-2001.
- 2,571,186. **VERMILLION MEDICAL CLINIC**. YANKTON MEDICAL CLINIC, PC, (U.S. CLS. 100 AND 101). SN 76-209,083. PUB. 2-26-2002. FILED 2-12-2001.
- 2,571,192. **CONNECTICUT SPINE AND PAIN CENTER AND DESIGN**. BRISTOL HOSPITAL, (U.S. CLS. 100 AND 101). SN 76-212,058. PUB. 8-14-2001. FILED 2-16-2001.
- 2,571,193. **WEBKOR INTERNATIONAL**. BOOTH, CYNTHIA ALLEN, (U.S. CLS. 100 AND 101). SN 76-213,258. PUB. 9-11-2001. FILED 2-22-2001.
- 2,571,195 (*See Class 31 for this trademark*).
- 2,571,200. **EXPLORE MINNESOTA 10,000 STEPS COUNT ONFEELING GREAT! OCT. 00 MN X1639794 HEALTHPARTNERS AND DESIGN**. HEALTHPARTNERS, INC., (U.S. CLS. 100 AND 101). SN 76-216,680. PUB. 2-26-2002. FILED 2-27-2001.
- 2,571,202. **CR AND DESIGN**. CONTINENTAL REPORTING SERVICE, INC., (U.S. CLS. 100 AND 101). SN 76-218,760. PUB. 2-26-2002. FILED 3-5-2001.
- 2,571,215. **LIFE NAVIGATOR AND DESIGN**. LIFE NAVIGATOR, INC., (U.S. CLS. 100 AND 101). SN 76-223,858. PUB. 8-14-2001. FILED 3-9-2001.
- 2,571,217. **SUPER Q (STYLIZED)**. EVERETT AND JONES BARBEQUE, INC., (U.S. CLS. 100 AND 101). SN 76-224,397. PUB. 2-26-2002. FILED 3-14-2001.
- 2,571,236. **MISCELLANEOUS DESIGN**. SUSHI DELI EXPRESS, INC., (U.S. CLS. 100 AND 101). SN 76-233,183. PUB. 2-26-2002. FILED 3-26-2001.
- 2,571,237. **JENMARCO, INC.**. JENMARCO, INC., (U.S. CLS. 100 AND 101). SN 76-233,332. PUB. 2-26-2002. FILED 4-2-2001.
- 2,571,240. **C CETRUS (STYLIZED)**. CETRUS, INC., (U.S. CLS. 100 AND 101). SN 76-233,796. PUB. 2-26-2002. FILED 4-2-2001.
- 2,571,242. **STREAMLINE**. U.S. CREATIVE, INC., (U.S. CLS. 100 AND 101). SN 76-234,456. PUB. 10-30-2001. FILED 4-2-2001.
- 2,571,252. **WE SPECIALIZE IN YOU**. WHEELING HOSPITAL, INC., (U.S. CLS. 100 AND 101). SN 76-240,965. PUB. 10-16-2001. FILED 4-16-2001.
- 2,571,257. **MAKING THE DIFFERENCE**. BRICKELL FINANCIAL SERVICES-MOTOR CLUB, INC., (U.S. CLS. 100 AND 101). SN 76-242,088. PUB. 2-26-2002. FILED 4-17-2001.
- 2,571,258. **GIBSON, DUNN & CRUTCHER**. GIBSON, DUNN & CRUTCHER LLP, (U.S. CLS. 100 AND 101). SN 76-242,770. PUB. 2-26-2002. FILED 4-17-2001.
- 2,571,261 (*See Class 36 for this trademark*).
- 2,571,263. **THE ART OF HEAVY LIFTING**. THOUGHTWORKS, INC., (U.S. CLS. 100 AND 101). SN 76-243,771. PUB. 2-26-2002. FILED 4-20-2001.
- 2,571,264. **IDA AND DESIGN**. INFECTIOUS DISEASES ASSOCIATE, P.C., (U.S. CLS. 100 AND 101). SN 76-244,221. PUB. 2-26-2002. FILED 4-23-2001.
- 2,571,265. **GREAT NORTHERN PIZZA KITCHEN**. D2 RESTAURANT SYSTEMS, LLC, (U.S. CLS. 100 AND 101). SN 76-244,507. PUB. 2-26-2002. FILED 4-23-2001.
- 2,571,290. **PACIFICA FOUNDATION**. PACIFICA FOUNDATION, (U.S. CLS. 100 AND 101). SN 76-256,785. PUB. 2-26-2002. FILED 5-15-2001.
- 2,571,293. **AURACLE AND DESIGN**. AURACLE SALON CORPORATION, (U.S. CLS. 100 AND 101). SN 76-258,531. PUB. 2-26-2002. FILED 5-17-2001.
- 2,571,301. **SCHOOLSERVER**. STARDATA TECHNOLOGIES, INC., (U.S. CLS. 100 AND 101). SN 76-261,335. PUB. 2-26-2002. FILED 5-22-2001.
- 2,571,308. **YOUR BP DEPARTMENT**. SUNTECH MEDICAL INSTRUMENTS, INC., (U.S. CLS. 100 AND 101). SN 76-263,885. PUB. 2-26-2002. FILED 5-29-2001.
- 2,571,312. **COME FLEA WITH ME**. KATE SHIFRIN STYLE CONSULTANTS, INC., (U.S. CLS. 100 AND 101). SN 76-265,440. PUB. 2-26-2002. FILED 6-1-2001.

- 2,571,327. **DERMATOLOGY FORUM LEAM ALONG SIDE OTHERS ASK AN MD A QUESTION NOW! DF AND DESIGN.** HEALTHCOMMUNITIES.COM, INC., (U.S. CLS. 100 AND 101). SN 76-271,848. PUB. 2-26-2002. FILED 6-14-2001.
- 2,571,328 (*See Class 35 for this trademark.*)
- 2,571,345 (*See Class 35 for this trademark.*)
- 2,571,368. **DALEEN.** DALEEN TECHNOLOGIES, INC., (U.S. CLS. 100 AND 101). SN 76-286,985. PUB. 2-26-2002. FILED 7-16-2001.
- 2,571,371. **EQUILATERAL TECHNOLOGIES AND DESIGN.** EQUILATERAL TECHNOLOGIES, INC., (U.S. CLS. 100 AND 101). SN 76-290,450. PUB. 2-26-2002. FILED 7-25-2001.
- 2,571,377. **PASTAZIOS PIZZA AND DESIGN.** PASTAZIOS PIZZA, INC., (U.S. CLS. 100 AND 101). SN 76-292,297. PUB. 2-26-2002. FILED 7-30-2001.
- 2,571,379. **CQ RECORD SCANNER.** CONGRESSIONAL QUARTERLY, INC., (U.S. CLS. 100 AND 101). SN 76-292,387. PUB. 2-26-2002. FILED 7-30-2001.
- 2,571,380. **AMERICAN ACADEMY OF NEUROLOGY AND DESIGN.** AMERICAN ACADEMY OF NEUROLOGY, THE, (U.S. CLS. 100 AND 101). SN 76-292,419. PUB. 2-26-2002. FILED 7-30-2001.
- 2,571,383. **CIMARRON STEAK HOUSE AND DESIGN.** CIMARRON STEAK HOUSES, INC., (U.S. CLS. 100 AND 101). SN 76-297,624. PUB. 2-26-2002. FILED 8-13-2001.
- 2,571,384. **CIMARRON STEAK HOUSE.** CIMARRON STEAK HOUSES, INC., (U.S. CLS. 100 AND 101). SN 76-297,650. PUB. 2-26-2002. FILED 8-13-2001.
- 2,571,385. **NETWORK SAFETY CONSULTANTS.** HORTON INSURANCE AGENCY, INC., (U.S. CLS. 100 AND 101). SN 76-299,729. PUB. 2-26-2002. FILED 8-15-2001.
- 2,571,398. **ANSWERSTEP.** ANSWERSPACE, INCORPORATED, (U.S. CLS. 100 AND 101). SN 76-307,410. PUB. 2-26-2002. FILED 8-30-2001.
- 2,571,409. **PORTRAITS OF KIDS BEING KIDS.** SADIE'S, LLC, (U.S. CLS. 100 AND 101). SN 76-310,770. PUB. 2-26-2002. FILED 9-10-2001.
- 2,571,411. **THE BRITISH BEER COMPANY MCMXCVII AND DESIGN.** PLYMOUTH PROPERTY LAND OWNER, LLC, (U.S. CLS. 100 AND 101). SN 76-311,800. PUB. 2-26-2002. FILED 9-17-2001.
- 2,571,451 (*See Class 20 for this trademark.*)
- 2,571,458. **YELLOWHOUSE.** YELLOWHOUSE, L.L.C., (U.S. CLS. 100 AND 101). SN 76-319,794. PUB. 2-26-2002. FILED 10-1-2001.
- 2,571,460. **OFFER THEM CHRIST.** FOUNDATION FOR EVANGELISM, THE, (U.S. CLS. 100 AND 101). SN 76-320,086. PUB. 2-26-2002. FILED 9-28-2001.
- 2,571,464. **TC RX AND DESIGN.** PHARMACY BUYING ASSOCIATION, INC., (U.S. CLS. 100 AND 101). SN 76-320,543. PUB. 2-26-2002. FILED 10-3-2001.
- 2,571,483. **XTO (STYLIZED).** XTO ENERGY INC., (U.S. CLS. 100 AND 101). SN 76-325,729. PUB. 2-26-2002. FILED 10-15-2001.
- 2,571,485. **MISCELLANEOUS DESIGN.** PACIFIC LAW GROUP LLP, (U.S. CLS. 100 AND 101). SN 76-326,639. PUB. 2-26-2002. FILED 10-16-2001.
- 2,571,486. **SEIZE THE POWER.** WINSTEAD SECHREST & MINICK P.C., (U.S. CLS. 100 AND 101). SN 76-326,642. PUB. 2-26-2002. FILED 10-16-2001.
- 2,571,487. **MR. RANCH.** PADILLA, JUAN, (U.S. CLS. 100 AND 101). SN 76-326,752. PUB. 2-26-2002. FILED 10-17-2001.
- 2,571,491 (*See Class 35 for this trademark.*)
- 2,571,492. **GLENDALE AZ AND DESIGN.** CITY OF GLENDALE, ARIZONA, (U.S. CLS. 100 AND 101). SN 78-009,431. PUB. 2-26-2002. FILED 5-23-2000.
- 2,571,493. **FUNDFLEX.** DOTCOM MARKETING, INC., (U.S. CLS. 100 AND 101). SN 78-013,533. PUB. 2-26-2002. FILED 6-20-2000.
- 2,571,499. **LUMINOUS (STYLIZED).** LUMINOUS CORPORATION, (U.S. CLS. 100 AND 101). SN 78-021,512. PUB. 2-26-2002. FILED 8-16-2000.
- 2,571,501. **HIGHEREDUCATION.COM.** AGENCY OF AMERICA, INC., (U.S. CLS. 100 AND 101). SN 78-023,404. PUB. 2-26-2002. FILED 8-29-2000.
- 2,571,502. **BEEMA.** BEEMA INCORPORATED, (U.S. CLS. 100 AND 101). SN 78-023,556. PUB. 2-26-2002. FILED 8-29-2000.
- 2,571,504. **SMARTCLUE.** ALASKA SUPPLY CHAIN INTEGRATORS, LLC, (U.S. CLS. 100 AND 101). SN 78-025,532. PUB. 2-26-2002. FILED 9-12-2000.
- 2,571,507. **SCIENTIA.** SCIENTIA, INC., (U.S. CLS. 100 AND 101). SN 78-026,494. PUB. 2-26-2002. FILED 9-18-2000.
- 2,571,513 (*See Class 35 for this trademark.*)
- 2,571,527. **ACURELEASE AND DESIGN.** BACON, DOROTHY, (U.S. CLS. 100 AND 101). SN 78-032,394. PUB. 2-26-2002. FILED 10-25-2000.
- 2,571,536. **WORLDWIDE HOMESTAY AND DESIGN.** WORLDWIDE HOMESTAY PTY LTD., (U.S. CLS. 100 AND 101). SN 78-035,096. PUB. 2-26-2002. FILED 11-14-2000.
- 2,571,538 (*See Class 35 for this trademark.*)
- 2,571,543. **LEGAL DOCUMENTS FOR LESS, INC.** LEGAL DOCUMENTS FOR LESS, INC., (U.S. CLS. 100 AND 101). SN 78-036,010. PUB. 2-26-2002. FILED 11-20-2000.
- 2,571,545. **MY EHS.** MY EHS MANAGER, INC., (U.S. CLS. 100 AND 101). SN 78-036,500. PUB. 2-26-2002. FILED 11-24-2000.
- 2,571,557. **WWW.OHMYGOODNESS.COM.** OHMY ENTERPRISES, INC., (U.S. CLS. 100 AND 101). SN 78-040,182. PUB. 2-26-2002. FILED 12-21-2000.
- 2,571,558 (*See Class 6 for this trademark.*)
- 2,571,559. **HUTCHISON & MASON PLLC AND DESIGN.** HUTCHISON & MASON PLLC, (U.S. CLS. 100 AND 101). SN 78-040,300. PUB. 2-26-2002. FILED 12-21-2000.
- 2,571,570. **FILEMYINFO.** NISUS HOLDINGS, INC., (U.S. CLS. 100 AND 101). SN 78-044,350. PUB. 2-26-2002. FILED 1-22-2001.
- 2,571,575. **BIGELOW AEROSPACE.** BIGELOW DEVELOPMENT AEROSPACE LIMITED LIABILITY COMPANY, (U.S. CLS. 100 AND 101). SN 78-045,581. PUB. 2-26-2002. FILED 1-30-2001.
- 2,571,576. **4MYHEART.** BERKELEY HEARTLAB, INC., (U.S. CLS. 100 AND 101). SN 78-045,681. PUB. 2-26-2002. FILED 1-30-2001.
- 2,571,580. **PUKA DOG HAWAIIAN STYLE HOT DOGS.** QUINETTE JR., RICHARD T., (U.S. CLS. 100 AND 101). SN 78-046,502. PUB. 2-26-2002. FILED 2-5-2001.
- 2,571,584. **TEXAS MEDICAL ASSOCIATION.** TEXAS MEDICAL ASSOCIATION, (U.S. CLS. 100 AND 101). SN 78-048,383. PUB. 2-26-2002. FILED 2-14-2001.
- 2,571,587. **MONTANA MINING COMPANY STEAKHOUSE & SALOON AND DESIGN.** BEYAZIAN, SERGIO, (U.S. CLS. 100 AND 101). SN 78-049,272. PUB. 2-26-2002. FILED 2-20-2001.
- 2,571,597. **MISCELLANEOUS DESIGN.** SPIREMEDIA, INC., (U.S. CLS. 100 AND 101). SN 78-051,088. PUB. 2-26-2002. FILED 3-2-2001.
- 2,571,600. **KAOZ.** KAOZ, (U.S. CLS. 100 AND 101). SN 78-052,479. PUB. 2-26-2002. FILED 3-11-2001.
- 2,571,601. **VM VISUAL MOTIVES (STYLIZED).** MORE, VICKY, (U.S. CLS. 100 AND 101). SN 78-053,639. PUB. 2-26-2002. FILED 3-16-2001.
- 2,571,610. **MISCELLANEOUS DESIGN.** ADESCOM INC., (U.S. CLS. 100 AND 101). SN 78-055,641. PUB. 2-26-2002. FILED 3-28-2001.
- 2,571,617. **WHOWARE.** WHOGLUE, INC., (U.S. CLS. 100 AND 101). SN 78-057,177. PUB. 2-26-2002. FILED 4-6-2001.
- 2,571,618. **ARDOR CONSULTING.** HANEKAMP, JAMES, (U.S. CLS. 100 AND 101). SN 78-057,185. PUB. 2-26-2002. FILED 4-6-2001.
- 2,571,635. **SOLATURE (STYLIZED).** SOLATURE, INC., (U.S. CLS. 100 AND 101). SN 78-069,934. PUB. 2-26-2002. FILED 6-19-2001.
- 2,571,640. **FIVE-0.** FIVE-0, (U.S. CLS. 100 AND 101). SN 78-070,909. PUB. 2-26-2002. FILED 6-25-2001.
- 2,571,648. **ELRO.** ELRO CORPORATION, (U.S. CLS. 100 AND 101). SN 78-072,272. PUB. 2-26-2002. FILED 7-3-2001.
- 2,571,660. **CYCLONE COWBOY.** FAIDLEY, WARREN E. JR., (U.S. CLS. 100 AND 101). SN 78-076,311. PUB. 2-26-2002. FILED 7-29-2001.
- 2,571,666. **TESTCHIP AND DESIGN.** TESTCHIP TECHNOLOGIES, INC., (U.S. CLS. 100 AND 101). SN 78-076,602. PUB. 2-26-2002. FILED 7-31-2001.
- 2,571,669. **CRABBY BILL'S.** LODER MANAGEMENT ASSOCIATES, L.L.C., (U.S. CLS. 100 AND 101). SN 78-079,549.

MAY 21, 2002

U.S. PATENT AND TRADEMARK OFFICE

TM 603

PUB. 2-26-2002. FILED 8-16-2001.

* * * * *

SECTION 2.—PRIOR UNITED STATES CLASSIFICATION

CERTIFICATION MARKS

CLASS B—SERVICES

2,570,559 (*See Class A for this trademark*).

CLASS A—GOODS

2,570,559. **FSC AND DESIGN**. FOREST STEWARDSHIP COUNCIL, A.C., MULTIPLE CLASS, (U.S. CLS: A AND B), SN 75-597,773. PUB. 6-27-2000. FILED 12-1-1998.

* * * * *

TRADEMARK REGISTRATIONS ISSUED UNDER SECTION 1(d)

The following marks have registered on the Principal Register pursuant to the intent-to-use provisions of Section 1(d) of the Trademark Act of 1946, as amended.

SECTION 1.— INTERNATIONAL CLASSIFICATION

The short titles associated below with the international class numbers are terms designed merely for quick identification and are not an official part of the international classification. The full names of international classes are given in section 6.1 of the trademark rules of practice.

The designation "U.S. Cl." appearing in this section refers to the U.S. class in effect prior to Sep. 1, 1973 rather than the international class which applies to applications filed on or after that date. For adoption of international classification see notice in the OFFICIAL GAZETTE of Jun. 26, 1973 (911 O.G. TM 210).

Application in more than one class

2,571,688. HONEYBERRY FARM, INC., KNOXVILLE, TN.
SN 75-000,205. PUB. 10-5-1999, FILED 10-2-1995.



CLASS 24—FABRICS

FOR CRIB LINENS, NAMELY, BLANKETS AND BURP CLOTHS (U.S. CLS. 42 AND 50).
FIRST USE 2-0-1995; IN COMMERCE 2-0-1995.

CLASS 25—CLOTHING

FOR INFANTS' CLOTHING, NAMELY, FOOTED SLEEPERS, ONESIES, PANTS, ROMPERS, HATS AND BOOTIES (U.S. CLS. 22 AND 39).
FIRST USE 0-0-1993; IN COMMERCE 0-0-1993.

NO CLAIM IS MADE TO THE EXCLUSIVE RIGHT TO USE "FARM", APART FROM THE MARK AS SHOWN.

CLASS 29—MEATS AND PROCESSED FOODS

FOR JAMS AND JELLIES (U.S. CL. 46).
FIRST USE 6-1-1995; IN COMMERCE 6-1-1995.

CLASS 30—STAPLE FOODS

FOR HONEY (U.S. CL. 46).
FIRST USE 4-1-1996; IN COMMERCE 4-1-1996.

2,571,696. BARNEY'S, INC., NEW YORK, NY. SN 75-273,941.
PUB. 10-27-1998, FILED 4-14-1997.

BARNEYS NEW YORK

OWNER OF U.S. REG. NOS. 162,003, 1,535,382, AND OTHERS.

NO CLAIM IS MADE TO THE EXCLUSIVE RIGHT TO USE "NEW YORK", APART FROM THE MARK AS SHOWN.

2,571,698. LARSEN, DONNA R., SAN DIEGO, CA. SN 75-307,933. PUB. 6-2-1998, FILED 6-12-1997.

SATVAH-DIVAH

CLASS 9—ELECTRICAL AND SCIENTIFIC APPARATUS

FOR A SERIES OF MUSICAL SOUND RECORDINGS (U.S. CLS. 21, 23, 26, 36 AND 38).
FIRST USE 7-3-1999; IN COMMERCE 7-3-1999.

CLASS 41—EDUCATION AND ENTERTAINMENT

FOR ENTERTAINMENT SERVICES, NAMELY, LIVE PERFORMANCES BY A MUSICAL BAND AND AUDIO, VISUAL AND VIDEO PRODUCTION AND MUSICAL COMPOSITION FOR OTHERS (U.S. CLS. 100, 101 AND 107).
FIRST USE 7-3-1999; IN COMMERCE 7-3-1999.

2,571,704. MDS INC., ETOBICOKE, ONTARIO, CANADA.
SN 75-343,790. PUB. 9-28-1999, FILED 8-20-1997.

MDS

CLASS 1—CHEMICALS

FOR RADIOISOTOPES FOR SCIENTIFIC OR RESEARCH USE (U.S. CLS. 1, 5, 6, 10, 26 AND 46).
FIRST USE 11-1-1996; IN COMMERCE 11-29-1996.

CLASS 5—PHARMACEUTICALS

FOR RADIOISOTOPES FOR MEDICAL DIAGNOSTIC USE, AND FOR MEDICAL THERAPEUTIC USE, RADIO-PHARMACEUTICALS FOR MEDICAL DIAGNOSTIC USE, AND FOR MEDICAL THERAPEUTIC USE (U.S. CLS. 6, 18, 44, 46, 51 AND 52).
FIRST USE 11-1-1996; IN COMMERCE 11-29-1996.

CLASS 9—ELECTRICAL AND SCIENTIFIC APPARATUS

FOR EQUIPMENT FOR THE PRODUCTION OF RADIOISOTOPES, NAMELY, GAS TARGET SYSTEMS HAVING A TARGET CHAMBER, A STORAGE VESSEL, AND AN ION EXCHANGE COLUMN, WHICH ALLOW THE BOMBARDMENT OF A TARGET MATERIAL WITH PROTON BEAMS TO PRODUCE RADIOISOTOPES, SOLID TARGET SYSTEMS HAVING A HOT CELL, TRANSFER LINE, AND TARGET STATION, WHICH ALLOW THE BOMBARDMENT OF TARGET MATERIAL WITH PROTON BEAMS TO PRODUCE RADIOISOTOPES, AND CYCLOTRONS; RADIATION PROCESSING EQUIPMENT, NAMELY, CYCLOTRON SYSTEMS UTILIZING ISOTOPE PROCESSING TECHNOLOGY WHEREBY TARGET MATERIALS ARE BOMBARDED WITH PROTON BEAMS TO PRODUCE CYCLOTRON PRODUCTS; INDUSTRIAL IRRADIATION EQUIPMENT, NAMELY, PRODUCTION IRRADIATORS, ASSOCIATED CONTROL CONSOLES, CONVEYOR SYSTEMS USED TO MOVE PRODUCT-FILLED TOTES IN AND OUT OF THE IRRADIATION CHAMBERS, SOURCE HOISTS, LOAD AND UNLOAD STATIONS, MONITORS AND CARRIERS, PALLETS AND TOTES, CONTAINERS FOR RADIATION EMITTING ENERGY SOURCES, SELF-CONTAINING IRRADIATORS FOR IRRADIATION OF SAMPLE MATERIALS, AND DOSIMETERS AND DOSIMETER SYSTEMS FOR MEASURING RADIATION DOSE; RADIATION EMITTING ENERGY SOURCES, NAMELY RADIOISOTOPES FOR NON-MEDICAL PURPOSES; COMPUTER HARDWARE, SOFTWARE AND MONITORS ALL USED TO MONITOR IRRADIATOR CONTROL FUNCTIONS AND ATTACHED PERIPHERALS; AND COMPUTER SOFTWARE AND ACCOMPANYING INSTRUCTION MANUALS SOLD AS A UNIT USED FOR PATIENT SPECIMEN ANALYSIS, RECORDING AND REPORTING (U.S. CLS. 21, 23, 26, 36 AND 38).
FIRST USE 11-1-1996; IN COMMERCE 11-29-1996.

CLASS 10—MEDICAL APPARATUS

FOR MEDICAL IRRADIATION EQUIPMENT, NAMELY, BLOOD IRRADIATORS FOR TREATMENT OF BLOOD AND BLOOD COMPONENTS, AND RADIOISOTOPES FOR USE OUTSIDE THE HUMAN BODY FOR MEDICAL DIAGNOSTIC AND MEDICAL THERAPEUTIC USES; AND LABORATORY EQUIPMENT, NAMELY ELECTRICAL AUTOMATED SORTING MACHINES USED TO SORT MEDICAL LABORATORY SPECIMENS (U.S. CLS. 26, 39 AND 44).
FIRST USE 11-1-1996; IN COMMERCE 11-29-1996.

CLASS 35—ADVERTISING AND BUSINESS

FOR WHOLESALE DISTRIBUTORSHIPS FEATURING MEDICAL LABORATORY EQUIPMENT, COMPUTER HARDWARE AND MONITORS AND ATTACHED PERIPHERALS, AND COMPUTER PROGRAMS, ALL USED FOR PATIENT SPECIMEN HANDLING AND ANALYSIS (U.S. CLS. 100, 101 AND 102).
FIRST USE 11-1-1996; IN COMMERCE 5-0-1999.

CLASS 37—CONSTRUCTION AND REPAIR

FOR INSTALLATION, MAINTENANCE AND REPAIR OF MEDICAL LABORATORY EQUIPMENT, AND OF COMPUTERS AND COMPUTER SYSTEMS USED AS PART OF MEDICAL LABORATORY EQUIPMENT FOR PATIENT SPECIMEN HANDLING AND ANALYSIS (U.S. CLS. 100, 103 AND 106).
FIRST USE 11-1-1996; IN COMMERCE 5-0-1999.

CLASS 42—SCIENTIFIC, COMPUTER AND LEGAL SERVICES

FOR INSTALLATION, MAINTENANCE AND UPDATING OF COMPUTER PROGRAMS USED FOR PATIENT SPECIMEN HANDLING AND ANALYSIS; PHARMACEUTICAL SERVICES, NAMELY, PROFESSIONAL CONSULTANCY AND CONSULTATION SERVICES IN THE FIELDS OF BIOTECHNOLOGY, BIOCHEMISTRY, PHARMACOLOGY AND MEDICINE; RESEARCH SERVICES IN THE FIELDS OF BIOTECHNOLOGY, BIOCHEMISTRY, PHARMACOLOGY AND MEDICINE (U.S. CLS. 100 AND 101).
FIRST USE 11-1-1996; IN COMMERCE 7-0-2001.

2,571,705. DISCOVERY COMMUNICATIONS, INC., DBA DISCOVERY CHANNEL, BETHESDA, MD. SN 75-348,647. PUB. 4-21-1998, FILED 8-28-1997.

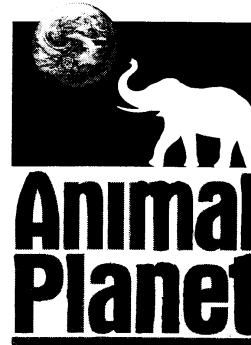

OWNER OF U.S. REG. NOS. 883,953, 2,093,741, AND OTHERS.

CLASS 9—ELECTRICAL AND SCIENTIFIC APPARATUS

FOR PRE-RECORDED VIDEO TAPES AND CASSETTES, COMPACT AND VIDEO DISKS, CD ROMS AND AUDIO-VISUAL RECORDINGS FOR HOME AND EDUCATIONAL USES ON TOPICS RELATING TO ANIMALS (U.S. CLS. 21, 23, 26, 36 AND 38).
FIRST USE 6-30-1998; IN COMMERCE 6-30-1998.

CLASS 16—PAPER GOODS AND PRINTED MATTER

FOR PENCILS, PENCIL CASES, PAPER STATIONERY PORTFOLIOS, NOTEBOOKS, BOOKS ON TOPICS RELATING TO THE APPLICANT'S TELEVISION PROGRAMMING OF THE SAME NAME, CALENDARS AND STICKERS (U.S. CLS. 2, 5, 22, 23, 29, 37, 38 AND 50).
FIRST USE 8-1-2000; IN COMMERCE 8-1-2000.

CLASS 18—LEATHER GOODS

FOR BACKPACKS (U.S. CLS. 1, 2, 3, 22 AND 41).
FIRST USE 8-1-2000; IN COMMERCE 8-1-2000.

CLASS 25—CLOTHING

FOR CLOTHING, NAMELY, T-SHIRTS, SWEAT-SHIRTS, TOPS AND JACKETS (U.S. CLS. 22 AND 39).
FIRST USE 1-1-1998; IN COMMERCE 1-1-1998.

2,571,721. KINGSTON-MIAMI TRADING CO., MIAMI, FL.
SN 75-409,377. PUB. 11-9-1999, FILED 12-22-1997.

MRS. CHRIS**CLASS 29—MEATS AND PROCESSED FOODS**

FOR JAMS, JELLIES, CANNED FRUITS, CANNED VEGETABLES, DRIED FRUIT, AND COCONUT MILK (U.S. CL. 46).
FIRST USE 1-0-1998; IN COMMERCE 1-0-1998.

CLASS 30—STAPLE FOODS

FOR SAUCES, SPICES, PROCESSED HERBS, PROCESSED EDIBLE ROOTS AND BREAKFAST CEREALS (U.S. CL. 46).
FIRST USE 1-0-1998; IN COMMERCE 1-0-1998.

CLASS 32—LIGHT BEVERAGES

FOR SOFT DRINKS AND FRUIT DRINKS (U.S. CLS. 45, 46 AND 48).
FIRST USE 1-0-1998; IN COMMERCE 1-0-1998.

2,571,706. XPARTICIPATION, INC., NAHANT, MA, BY ASSIGNMENT HEWITT, CARL E., NAHANT, MA. SN 75-357,714. PUB. 9-22-1998, FILED 9-16-1997.

PARTICIPATORY**CLASS 9—ELECTRICAL AND SCIENTIFIC APPARATUS**

FOR COMPUTER PROGRAMS AND USER DOCUMENTATION DISTRIBUTED THEREWITH FOR USE IN INFORMATION SYSTEMS MANAGEMENT (U.S. CLS. 21, 23, 26, 36 AND 38).
FIRST USE 12-5-2001; IN COMMERCE 12-5-2001.

CLASS 42—SCIENTIFIC, COMPUTER AND LEGAL SERVICES

FOR CONSULTING SERVICES IN THE FIELD OF COMPUTERS, COMPUTER PROGRAMS AND COMPUTER SYSTEMS (U.S. CLS. 100 AND 101).
FIRST USE 12-5-2001; IN COMMERCE 12-5-2001.

2,571,726. NIKE, INC., BEAVERTON, OR. SN 75-423,989.
PUB. 5-4-1999, FILED 1-27-1998.

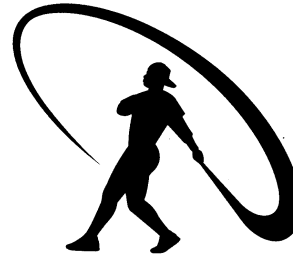

2,571,719. INNOVATIVE SPORTS MANAGEMENT, PACIFIC PALISADES, CA. SN 75-398,122. PUB. 10-24-2000, FILED 11-26-1997.



NO CLAIM IS MADE TO THE EXCLUSIVE RIGHT TO USE "CHALLENGE", APART FROM THE MARK AS SHOWN.

THE NAME "PETE NEWELL" IDENTIFIES A LIVING INDIVIDUAL WHOSE CONSENT IS OF RECORD.

CLASS 25—CLOTHING

FOR CLOTHING, NAMELY, SHIRTS, SWEATSHIRTS AND JACKETS, AND HEADGEAR, NAMELY, CAPS AND HATS (U.S. CLS. 22 AND 39).
FIRST USE 12-22-1997; IN COMMERCE 12-22-1997.

CLASS 41—EDUCATION AND ENTERTAINMENT

FOR ENTERTAINMENT, SPORTING AND CULTURAL ACTIVITIES, NAMELY AN ANNUAL COLLEGE BASKETBALL TOURNAMENT (U.S. CLS. 100, 101 AND 107).
FIRST USE 6-9-1997; IN COMMERCE 6-9-1997.

CLASS 18—LEATHER GOODS

FOR ALL-PURPOSE SPORTS BAGS (U.S. CLS. 1, 2, 3, 22 AND 41).
FIRST USE 9-15-2000; IN COMMERCE 9-15-2000.

CLASS 25—CLOTHING

FOR FOOTWEAR AND WRISTBANDS (U.S. CLS. 22 AND 39).
FIRST USE 12-23-1996; IN COMMERCE 12-23-1996.

CLASS 28—TOYS AND SPORTING GOODS

FOR BATTING GLOVES (U.S. CLS. 22, 23, 38 AND 50).
FIRST USE 9-18-2000; IN COMMERCE 9-18-2000.

2,571,732. FACILITY MERCHANDISING, INC., WOODLAND HILLS, CA. SN 75-436,963. PUB. 12-29-1998, FILED 2-19-1998.

EXCLUSIVE ARENA COLLECTION

NO CLAIM IS MADE TO THE EXCLUSIVE RIGHT TO

USE "COLLECTION", APART FROM THE MARK AS SHOWN.

2,571,740. LINDER, RONALD, NEW YORK, NY. SN 75-453,728. PUB. 6-1-1999, FILED 3-20-1998.

CLASS 6—METAL GOODS

FOR METAL KEY CHAINS (U.S. CLS. 2, 12, 13, 14, 23, 25 AND 50).
FIRST USE 1-0-1993; IN COMMERCE 5-0-1999.

CLASS 14—JEWELRY

FOR JEWELRY ORNAMENTAL PINS (U.S. CLS. 2, 27, 28 AND 50).
FIRST USE 1-0-1993; IN COMMERCE 5-0-1999.

2,571,738. PROCYTE CORPORATION, KIRKLAND, WA. SN 75-449,180. PUB. 11-10-1998, FILED 3-12-1998.

HUMACEUTICALS

CLASS 35—ADVERTISING AND BUSINESS

FOR PACKAGING AND PRIVATE LABELING OF SKIN CARE AND SKIN PROTECTION PRODUCTS, PHARMACEUTICALS, AND WOUND CARE PRODUCTS (U.S. CLS. 100, 101 AND 102).
FIRST USE 7-27-2001; IN COMMERCE 7-27-2001.

CLASS 40—MATERIAL TREATMENT

FOR CUSTOM MANUFACTURE OF SKIN CARE AND SKIN PROTECTION PRODUCTS, PHARMACEUTICALS, AND WOUND CARE PRODUCTS (U.S. CLS. 100, 103 AND 106).
FIRST USE 7-27-2001; IN COMMERCE 7-27-2001.

2,571,739. SHARING NETWORK, LLC, THE, SALT LAKE CITY, UT. SN 75-450,879. PUB. 11-3-1998, FILED 3-16-1998.

THE SHARING CARD

NO CLAIM IS MADE TO THE EXCLUSIVE RIGHT TO USE "CARD", APART FROM THE MARK AS SHOWN.

CLASS 16—PAPER GOODS AND PRINTED MATTER

FOR PREPAID TELEPHONE CALLING CARDS NOT MAGNETICALLY CODED (U.S. CLS. 2, 5, 22, 23, 29, 37, 38 AND 50).
FIRST USE 8-9-2001; IN COMMERCE 8-9-2001.

CLASS 36—INSURANCE AND FINANCIAL

FOR PREPAID TELEPHONE CALLING CARD SERVICES (U.S. CLS. 100, 101 AND 102).
FIRST USE 8-9-2001; IN COMMERCE 8-9-2001.

BIO ART

CLASS 3—COSMETICS AND CLEANING PREPARATIONS

FOR SKIN CARE PRODUCTS, NAMELY, BODY LOTION, EYE CREAM, SKIN CLEANSING LOTION, FACIAL CLEANSER, WRINKLE REMOVING SKIN CARE PREPARATIONS, SKIN REVITALIZING LOTION, SKIN REVITALIZING CREAMS AND SKIN REVITALIZING TONERS, SKIN PEELING LOTIONS AND FACIAL MASKS FOR SKIN PEELING (U.S. CLS. 1, 4, 6, 50, 51 AND 52).
FIRST USE 7-21-1999; IN COMMERCE 7-21-1999.

CLASS 5—PHARMACEUTICALS

FOR MEDICATED SKIN PREPARATIONS, NAMELY, HERBAL TEAS FOR MEDICINAL PURPOSES AND HERBAL SUPPLEMENTS (U.S. CLS. 6, 18, 44, 46, 51 AND 52).
FIRST USE 7-21-1999; IN COMMERCE 7-21-1999.

CLASS 42—SCIENTIFIC, COMPUTER AND LEGAL SERVICES

FOR COSMETIC SURGICAL SERVICES AND BEAUTY, SKIN AND HAIR SALON SERVICES, NAMELY; CHEMICAL PEELING OF THE SKIN; PERMANENT COSMETIC TATTOOING; COSMETIC ELECTROLYSIS; NUTRITIONAL CONSULTATION AND WEIGHT REDUCTION DIET PLANNING AND SUPERVISION (U.S. CLS. 100 AND 101).
FIRST USE 5-1-1999; IN COMMERCE 5-1-1999.

2,571,743. GRATEFUL DEAD PRODUCTIONS, NOVATO, CA. SN 75-461,043. PUB. 3-9-1999, FILED 4-2-1998.

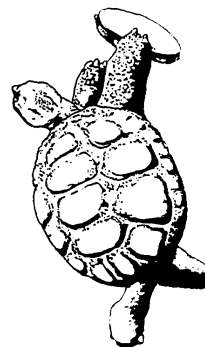

THE STIPPLING IS A FEATURE OF THE MARK.
SEC. 2(F).

CLASS 14—JEWELRY

FOR JEWELRY, NAMELY, BRACELETS, NECKLACES AND PINS OF PRECIOUS METAL (U.S. CLS. 2, 27, 28 AND 50).
FIRST USE 3-1-2001; IN COMMERCE 3-1-2001.

CLASS 16—PAPER GOODS AND PRINTED MATTER

FOR PAPER GOODS, NAMELY, BUMPERSTICKERS, DECALS, POSTERS AND STICKERS (U.S. CLS. 2, 5, 22, 23, 29, 37, 38 AND 50).

FIRST USE 11-1-1997; IN COMMERCE 11-1-1997.

CLASS 25—CLOTHING

FOR CLOTHING, NAMELY CAPS, HATS, SWEATSHIRTS AND T-SHIRTS (U.S. CLS. 22 AND 39).

FIRST USE 11-1-1997; IN COMMERCE 11-1-1997.

2,571,748. STORAGE TECHNOLOGY CORPORATION, LOUISVILLE, CO. SN 75-481,930. PUB. 8-22-2000, FILED 5-8-1998.

INFORMATION MADE POWERFUL**CLASS 9—ELECTRICAL AND SCIENTIFIC APPARATUS**

FOR COMPUTER HARDWARE; COMPUTER SOFTWARE FOR USE IN CONTROL, MANAGEMENT, MAINTENANCE AND OPERATION OF DATA STORAGE DEVICES, DATA COMMUNICATIONS DEVICES AND COMPUTER PERIPHERALS; COMPUTER SOFTWARE USED TO STORE, RETRIEVE, ACCESS, ARCHIVE, BUFFER, COMPRESS, CONSOLIDATE, COPY, DISTRIBUTE, ENCRYPT, INDEX, MIGRATE, MOVE, MULTIPLEX, RESTORE, SHARE, TRANSFER OR TRANSLATE DATA; COMPUTER SOFTWARE FOR USE IN MANAGEMENT OF DATA STORAGE; COMPUTER SOFTWARE FOR USE IN CONNECTING COMPUTERS, COMPUTER PERIPHERALS, DATA STORAGE DEVICES AND NETWORKS; COMPUTER SOFTWARE FOR USE IN CONTROL, MANAGEMENT, MAINTENANCE, MONITORING AND OPERATION OF COMPUTER NETWORKS, COMPUTER SOFTWARE FOR USE IN CONTROLLING ACCESS TO DATA AND NETWORKS; COMPUTER SOFTWARE FOR DETECTING AND RESPONDING TO UNAUTHORIZED NETWORK ACCESS; DATA STORAGE DEVICES, NAMELY AUTOMATED COMPUTER TAPE LIBRARIES, COMPUTER TAPE DRIVES, COMPUTER DISK DRIVES AND COMPUTER DISK SUBSYSTEMS; DATA STORAGE MEDIA, NAMELY BLANK COMPUTER TAPE CARTRIDGES AND BLANK MAGNETIC AND OPTICAL COMPUTER DISKS; DATA COMMUNICATION DEVICES, NAMELY SWITCHES, ROUTERS, MULTIPLEXERS, COMPRESSORS, INTERFACES AND GATEWAYS; COMPUTER PERIPHERALS (U.S. CLS. 21, 23, 26, 36 AND 38).

FIRST USE 3-0-1998; IN COMMERCE 3-0-1998.

CLASS 42—SCIENTIFIC, COMPUTER AND LEGAL SERVICES

FOR COMPUTER CONSULTATION; DESIGN AND ENGINEERING OF COMPUTER HARDWARE AND SOFTWARE FOR DATA STORAGE, DATA RETRIEVAL, DATA PROTECTION, NETWORKING, DATA COMMUNICATION, DATA AND NETWORK SECURITY AND DATA STORAGE MANAGEMENT FOR OTHERS; PROVIDING INFORMATION IN THE FIELDS OF COMPUTER HARDWARE AND SOFTWARE FOR DATA STORAGE, DATA RETRIEVAL, DATA PROTECTION, DATA AND NETWORK SECURITY, COMPUTER NETWORKS AND DATA STORAGE MANAGEMENT, VIA PUBLIC AND PRIVATE COMPUTER NETWORKS (U.S. CLS. 100 AND 101).

FIRST USE 3-0-1998; IN COMMERCE 3-0-1998.

2,571,745. TRINITY MARKETING, INC., SOUTHAMPTON, PA. SN 75-470,575. PUB. 2-22-2000, FILED 4-20-1998.

EXXTREME JOXX

2,571,754. ELIAS ARTS LTD., NEW YORK, NY. SN 75-497,784. PUB. 8-24-1999, FILED 6-8-1998.

EMOTIONAL CAPITAL**CLASS 16—PAPER GOODS AND PRINTED MATTER**

FOR TRADING CARDS (U.S. CLS. 2, 5, 22, 23, 29, 37, 38 AND 50).

FIRST USE 6-0-2001; IN COMMERCE 6-0-2001.

CLASS 28—TOYS AND SPORTING GOODS

FOR ACTION FIGURES, PLASTIC MOLDED TOY CARS, TOY CAR SETS, BATTERY OPERATED TOY VEHICLE RACING SETS, RADIO CONTROLLED TOY VEHICLE RACING SETS (U.S. CLS. 22, 23, 38 AND 50).

FIRST USE 10-0-1999; IN COMMERCE 10-0-1999.

CLASS 35—ADVERTISING AND BUSINESS

FOR BUSINESS MARKETING CONSULTING SERVICES, NAMELY, THE DEVELOPMENT AND IMPLEMENTATION OF CORPORATE IDENTITY PROGRAMS AND MARKETING PROGRAMS FOR OTHERS INVOLVING THE USE OF SOUND AND MUSIC (U.S. CLS. 100, 101 AND 102).

FIRST USE 7-0-2000; IN COMMERCE 7-0-2000.

CLASS 41—EDUCATION AND ENTERTAINMENT

FOR AUDIO PRODUCTION AND RECORDING OF MUSIC, SOUND AND SOUND EFFECTS FOR TELEVISION AND RADIO COMMERCIALS, PROMOTIONS, FILMS, THEATRICAL PRODUCTIONS, MULTIMEDIA PRODUCTIONS, VIDEO AND TELEVISION PROGRAMS (U.S. CLS. 100, 101 AND 107).

FIRST USE 7-0-2000; IN COMMERCE 7-0-2000.

CLASS 42—SCIENTIFIC, COMPUTER AND LEGAL SERVICES

FOR MUSIC COMPOSITION AND SOUND DESIGN SERVICES FOR OTHERS, NAMELY, WRITING AND ARRANGING MUSIC AND DESIGNING SOUNDS AND SOUND EFFECTS FOR TELEVISION AND RADIO COMMERCIAL, PROMOTIONS, FILMS, THEATRICAL PRODUCTIONS, MULTIMEDIA PRODUCTIONS, VIDEO AND TELEVISION PROGRAMS (U.S. CLS. 100 AND 101).

FIRST USE 7-0-2000; IN COMMERCE 7-0-2000.

CLASS 30—STAPLE FOODS

FOR SEASONED PICKLED GREEN MUSTARD, SOUR PICKLED GREEN MUSTARD, GREEN MUSTARD FLAVORED WITH PICKLED OLIVES AND MUSHROOMS, SWEET AND SOUR PLUM SAUCE, AND CHILI SAUCE IN PASTE FORM (U.S. CL. 46).

FIRST USE 0-0-1990; IN COMMERCE 0-0-1995.

2,571,756. LABORATOIRES SUISSES, PANAMA CITY, PANAMA. SN 75-501,426. PUB. 12-14-1999, FILED 6-11-1998.

2,571,755. LENG HENG AGRI FOODS CO., LTD., PATHUMTHANI 12120, THAILAND. SN 75-498,460. PUB. 11-2-1999, FILED 6-9-1998.



NO CLAIM IS MADE TO THE EXCLUSIVE RIGHT TO USE "TRADEMARK" AND "BRAND", APART FROM THE MARK AS SHOWN.

THE ASIAN CHARACTERS IN THE MARK TRANSLITERATE TO "LENG HENG" AND THIS MEANS "DRAGON PROSPERITY" IN ENGLISH.

THE TRANSLITERATION OF THE CHINESE CHARACTERS WHICH APPEAR IN THE CIRCLE DESIGN OF THE MARK IS "HENG LENG" WHICH MEANS "DRAGON PROSPERITY". THE TRANSLITERATION OF THE CHINESE CHARACTERS WHICH APPEARS ON THE RIGHT SIDE IN LARGER FORM IS "LENG" WHICH MEANS "DRAGON".

CLASS 29—MEATS AND PROCESSED FOODS

FOR SALTED LIMES, SWEETENED LIMES, SEASONED PICKLED GARLIC, SEASONED PICKLED RED AND WHITE GINGER, PICKLED SOY-BEAN GINGER, SALTED PLUMS, PROCESSED SWEET VEGETABLES, PRESERVED VEGETABLES, SWEET PICKLED RADISH, SWEET PICKLED RADISH WITH CHILI, PROCESSED SWEET VEGETABLES WITH CHILI, FERMENTED FISH, SALTED FISH, PRESERVED MANGO, DRIED COCONUT, AND MEAT (U.S. CL. 46).

FIRST USE 0-0-1990; IN COMMERCE 0-0-1995.

SKIN 2 FORTE

NO CLAIM IS MADE TO THE EXCLUSIVE RIGHT TO USE "SKIN", APART FROM THE MARK AS SHOWN.

CLASS 3—COSMETICS AND CLEANING PREPARATIONS

FOR SKIN CREAM AND SKIN CLEANSERS (U.S. CLS. 1, 4, 6, 50, 51 AND 52).

FIRST USE 1-31-1999; IN COMMERCE 1-31-1999.

CLASS 10—MEDICAL APPARATUS

FOR SILICON GEL SHEETING FOR THE TREATMENT OF SCARS (U.S. CLS. 26, 39 AND 44).

FIRST USE 1-31-1999; IN COMMERCE 1-31-1999.

2,571,764. NOVATOR AB, S-113 47 STOCKHOLM, SWEDEN. SN 75-534,457. PUB. 10-17-2000, FILED 8-11-1998.

TWINSPIN**CLASS 7—MACHINERY**

FOR COMPUTER CONTROLLED POWER OPERATED MULTI-AXIS SPINDLE MACHINES; MANUALLY OPERATED CUTTING TOOLS, NAMELY, MILLING MACHINES (U.S. CLS. 13, 19, 21, 23, 31, 34 AND 35).

FIRST USE 9-0-2000; IN COMMERCE 9-0-2000.

CLASS 8—HAND TOOLS

FOR MANUALLY OPERATED CUTTING TOOLS, NAMELY, GRINDERS, AND DRILLS (U.S. CLS. 23, 28 AND 44).

FIRST USE 9-0-2000; IN COMMERCE 9-0-2000.

2,571,765. HITEC ASA, N-4033 FORUS, NORWAY. SN 75-537,514. PUB. 9-19-2000, FILED 8-17-1998.

CYBERBASE

CLASS 9—ELECTRICAL AND SCIENTIFIC APPARATUS

FOR MULTIFUNCTIONAL OPERATION STATION COMPRISING AN OPERATOR CHAIR, INFORMATION DISPLAY UNITS, COMPUTERS, SIGNAL TRANSMITTERS, ALARMS, AND CONTROL DEVICES MANIPULATABLE BY AN OPERATOR TO CONTROL MACHINES, ENGINES OR MOTORS, ALL FOR INDUSTRIAL USES AND APPLICATIONS; MULTIFUNCTIONAL OPERATOR STATION COMPRISING AN OPERATOR CHAIR, INFORMATION DISPLAY UNITS, COMPUTERS, SIGNAL TRANSMITTERS, ALARMS, AND CONTROL DEVICES MANIPULATABLE BY AN OPERATOR FOR THE REMOTE CONTROL OF SIGNALS, INDUSTRIAL OPERATIONS, MARINE OPERATIONS, AND SUBSEA OPERATIONS, DATA PROCESSORS AND COMPUTERS FOR THE REMOTE CONTROL OF SIGNALS, INDUSTRIAL OPERATIONS, DRILLING OPERATIONS, MARINE OPERATIONS, AND SUBSEA OPERATIONS; COMPUTER PROGRAMS FOR THE REMOTE CONTROL OF SIGNALS, INDUSTRIAL OPERATIONS, DRILLING OPERATIONS, MARINE OPERATIONS, AND SUBSEA OPERATIONS, IN THE FIELDS OF MANUFACTURING, CONSTRUCTION, MINING, AND ENERGY PRODUCTION; TRAINERS AND SIMULATORS FOR MULTIFUNCTION OPERATOR STATIONS, NAMELY, ELECTRONIC COMPUTER MODELS FOR TRAINING IN AND SIMULATION OF THE OPERATION SUBSEA EQUIPMENT, DRILLING RIGS, MARINE VESSELS OPERATIONS AND MILITARY WEAPONS SYSTEMS; COMPUTER HARDWARE, NAMELY, MODEMS AND COMPUTER MONITORS, COMPUTER OPERATING PROGRAMS (U.S. CLS. 21, 23, 26, 36 AND 38).

FIRST USE 8-0-1994; IN COMMERCE 8-0-1997.

CLASS 16—PAPER GOODS AND PRINTED MATTER

FOR PRINTED MATTER, NAMELY, TRAINING AND OPERATING MANUALS, HANDBOOKS, AND TEACHING MATERIALS FOR MULTIFUNCTIONAL OPERATOR STATIONS, INTERACTIVE CONTROL UNITS, REMOTE CONTROL APPARATUS, AND APPARATUS FOR THE REMOTE CONTROL OF SIGNALS, INDUSTRIAL OPERATIONS, DRILLING OPERATIONS, MARINE OPERATIONS, AND SUBSEA OPERATIONS (U.S. CLS. 2, 5, 22, 23, 29, 37, 38 AND 50).

FIRST USE 8-0-1994; IN COMMERCE 8-0-1997.

2,571,773. FILTRATION GROUP INCORPORATED, JOLIET, IL, BY ASSIGNMENT ENVIRONMENTAL FILTER CORPORATION, SANTA ROSA, CA. SN 75-570,737. PUB. 12-7-1999, FILED 10-15-1998.

FILTERWORKS

CLASS 35—ADVERTISING AND BUSINESS

FOR RETAIL SERVICES BY DIRECT SOLICITATION BY SALES AGENTS IN THE FIELD OF RESIDENTIAL, COMMERCIAL AND INDUSTRIAL AIR FILTERS (U.S. CLS. 100, 101 AND 102).

FIRST USE 8-25-1999; IN COMMERCE 8-25-1999.

CLASS 37—CONSTRUCTION AND REPAIR

FOR AIR FILTER INSTALLATION AND MAINTENANCE SERVICES FOR RESIDENTIAL, COMMERCIAL, AND INDUSTRIAL USE (U.S. CLS. 100, 103 AND 106).

FIRST USE 9-0-1999; IN COMMERCE 9-0-1999.

2,571,776. CAPITAL DESIGN, INC., EAST PROVIDENCE, RI. SN 75-579,798. PUB. 1-11-2000, FILED 10-30-1998.

FREEMIUMS

CLASS 6—METAL GOODS

FOR COASTERS, PLANT TAGS, NON-MONETARY COMMEMORATIVE COINS, MONEY CLIPS, KEY TAGS, ALL MADE OF NON-PRECIOUS METAL (U.S. CLS. 2, 12, 13, 14, 23, 25 AND 50).

FIRST USE 5-1-2000; IN COMMERCE 5-1-2000.

CLASS 9—ELECTRICAL AND SCIENTIFIC APPARATUS

FOR DECORATIVE REFRIGERATOR MAGNETS (U.S. CLS. 21, 23, 26, 36 AND 38).

FIRST USE 5-1-2000; IN COMMERCE 5-1-2000.

CLASS 16—PAPER GOODS AND PRINTED MATTER

FOR STATIONERY AND PAPER GOODS, NAMELY, BOOKMARKS, LETTER OPENERS, DECALS, STENCILS, AND COASTERS MADE OF PAPER (U.S. CLS. 2, 5, 22, 23, 29, 37, 38 AND 50).

FIRST USE 5-1-2000; IN COMMERCE 5-1-2000.

CLASS 28—TOYS AND SPORTING GOODS

FOR CHRISTMAS TREE ORNAMENTS, DIVOT FIXERS AND BALL MARKERS FOR GOLFERS, JIGSAW PUZZLES (U.S. CLS. 22, 23, 38 AND 50).

FIRST USE 5-1-2000; IN COMMERCE 5-1-2000.

2,571,781. WORLD WIDE PET SUPPLY ASSOCIATION, INC., ARCADIA, CA. SN 75-591,618. PUB. 4-24-2001, FILED 11-19-1998.

TEACHER'S PET PROGRAM

NO CLAIM IS MADE TO THE EXCLUSIVE RIGHT TO USE "PROGRAM", APART FROM THE MARK AS SHOWN.

CLASS 36—INSURANCE AND FINANCIAL

FOR CHARITABLE FUND RAISING SERVICES, NAMELY, DONATING FUNDS TO CLASSROOMS TO OBTAIN ANIMALS, FISH, BIRDS, REPTILES AND/OR OTHER SPECIES, ANIMAL LIVING ENVIRONMENTS, AND PUBLICATIONS REGARDING ANIMAL CARE (U.S. CLS. 100, 101 AND 102).

FIRST USE 2-0-1998; IN COMMERCE 2-0-1998.

CLASS 42—SCIENTIFIC, COMPUTER AND LEGAL SERVICES

FOR ASSOCIATION SERVICES, NAMELY, PROMOTING THE INTERESTS OF THE PET AND PET-RELATED INDUSTRIES THROUGH THE DONATION OF ANIMALS, FISH, BIRDS, REPTILES AND/OR OTHER SPECIES, ANIMAL LIVING ENVIRONMENTS, AND PUBLICATIONS REGARDING ANIMAL CARE TO CLASSROOMS, AND THROUGH THE DISSEMINATION OF PRINTED MATERIALS AND INFORMATION OVER A GLOBAL COMPUTER NETWORK RELATING THERETO (U.S. CLS. 100 AND 101).

FIRST USE 2-0-1998; IN COMMERCE 2-0-1998.

2,571,783. DICK CLARK PRODUCTIONS, INC., BURBANK, CA. SN 75-596,617. PUB. 2-8-2000, FILED 11-27-1998.

**DICK CLARK
COMMUNICATIONS THE
EXPERIENCE IS
LEGENDARY**

OWNER OF U.S. REG. NOS. 1,322,628, 1,692,014, AND 1,984,016.

NO CLAIM IS MADE TO THE EXCLUSIVE RIGHT TO USE "COMMUNICATIONS", APART FROM THE MARK AS SHOWN.

DICK CLARK IDENTIFIES A LIVING INDIVIDUAL WHOSE CONSENT IS OF RECORD.

CLASS 41—EDUCATION AND ENTERTAINMENT

FOR ENTERTAINMENT SERVICES, NAMELY, PRODUCTION OF MOTION PICTURES, SLIDE SHOWS, LIGHT SHOWS, AUDIO AND VIDEO RECORDINGS, AND PREPARATION OF SPECIAL EFFECTS; PRODUCTION OF LIVE MUSICAL AND THEATRICAL PERFORMANCES; AND ENTERTAINMENT SERVICES IN THE NATURE OF PRODUCTION OF MOTION PICTURES, SLIDE SHOWS, LIGHT SHOWS, AUDIO AND VIDEO RECORDINGS, SPECIAL EFFECTS, AND LIVE MUSICAL AND THEATRICAL PERFORMANCES COMPRISING OR FEATURED AT CORPORATE PROMOTIONAL EVENTS AND SPORTS EVENTS (U.S. CLS. 100, 101 AND 107).

FIRST USE 1-0-1999; IN COMMERCE 1-0-1999.

CLASS 42—SCIENTIFIC, COMPUTER AND LEGAL SERVICES

FOR DESIGNING AND DECORATING CORPORATE PROMOTIONAL EXHIBITS FOR OTHERS AT CONVENTIONS, TRADE SHOWS, CORPORATE SPECIAL EVENTS AND MUSEUMS (U.S. CLS. 100 AND 101).

FIRST USE 1-0-1999; IN COMMERCE 1-0-1999.

2,571,786. SPRINGS INDUSTRIES, INC., FORT MILL, SC. SN 75-598,458. PUB. 9-14-1999, FILED 11-30-1998.



OWNER OF U.S. REG. NOS. 1,233,623, 2,074,133, AND OTHERS.

THE LINING SHOWN IN THE DRAWING APPEARS TO BE A FEATURE OF THE MARK AND NOT INTENDED TO INDICATE COLOR.

CLASS 6—METAL GOODS

FOR DRAPERY HARDWARE, NAMELY, METAL CURTAIN HOOKS (U.S. CLS. 2, 12, 13, 14, 23, 25 AND 50). FIRST USE 1-1-2000; IN COMMERCE 1-1-2000.

CLASS 20—FURNITURE AND ARTICLES NOT OTHERWISE CLASSIFIED

FOR DRAPERY HARDWARE, NAMELY, TRAVERSE RODS, CURTAIN RODS AND POLES; PILLOWS; WINDOW SHADES, WINDOW BLINDS, AND FINIALS (U.S. CLS. 2, 13, 22, 25, 32 AND 50). FIRST USE 1-1-2000; IN COMMERCE 1-1-2000.

CLASS 24—FABRICS

FOR TOWELS, WASHCLOTHS, SHOWER CURTAINS, TABLECLOTHS, ALL MADE OF FABRIC (U.S. CLS. 42 AND 50). FIRST USE 1-1-2000; IN COMMERCE 1-1-2000.

CLASS 27—FLOOR COVERINGS

FOR WALLPAPER BORDERS, BATH MATS, THROW RUGS (U.S. CLS. 19, 20, 37, 42 AND 50). FIRST USE 1-1-2000; IN COMMERCE 1-1-2000.

2,571,788. FRANKLIN MINT COMPANY, PHILADELPHIA, PA. SN 75-600,060. PUB. 10-26-1999, FILED 12-4-1998.



CLASS 21—HOUSEWARES AND GLASS

FOR SCULPTURES, SCULPTURE UNDER BELL JAR, ALL MADE OF COLD-CAST PORCELAIN, PORCELAIN OR CRYSTAL (U.S. CLS. 2, 13, 23, 29, 30, 33, 40 AND 50). FIRST USE 10-2-2000; IN COMMERCE 12-0-2000.

CLASS 28—TOYS AND SPORTING GOODS

FOR DOLLS, PLUSH FIGURES (U.S. CLS. 22, 23, 38 AND 50). FIRST USE 11-0-2001; IN COMMERCE 12-0-2001.

2,571,791. TELEVISION BROADCASTS LIMITED, KOW-
LOON, HONG KONG. SN 75-606,957. PUB. 9-5-2000,
FILED 12-17-1998.

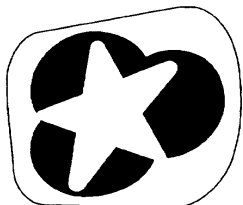

CLASS 16—PAPER GOODS AND PRINTED MATTER

FOR GOODS MADE FROM PAPER AND CARDBOARD, NAMELY, ADVERTISING BANNERS, STICKERS, POSTERS, POST CARDS, BOOKMARKS; PRINTED PUBLICATIONS, NAMELY BROCHURES, PAMPHLETS, AND GUIDES ALL IN THE FIELDS OF ENTERTAINMENT AND TELEVISION BROADCASTING; STATIONERY (U.S. CLS. 2, 5, 22, 23, 29, 37, 38 AND 50).
FIRST USE 12-7-1998; IN COMMERCE 10-1-2000.

CLASS 38—COMMUNICATION

FOR TELEVISION BROADCASTING; BROADCASTING AND TRANSMISSION OF CABLE TELEVISION PROGRAMS; AUDIO AND VIDEO BROADCASTING AND TRANSMISSION; BROADCASTING AND TRANSMISSION OF DIGITAL VIDEO AND AUDIO INFORMATION BY MEANS OF CABLE, WIRE, FIBER OR SATELLITE (U.S. CLS. 100, 101 AND 104).
FIRST USE 12-7-1998; IN COMMERCE 10-1-2000.

CLASS 41—EDUCATION AND ENTERTAINMENT

FOR PROVIDING ON-LINE INFORMATION IN THE FIELD OF ENTERTAINMENT (U.S. CLS. 100, 101 AND 107).
FIRST USE 12-7-1998; IN COMMERCE 10-1-2000.

2,571,795. NINE WEST DEVELOPMENT CORPORATION,
WHITE PLAINS, NY. SN 75-612,495. PUB. 4-4-2000,
FILED 12-28-1998.

NINE WEST

OWNER OF U.S. REG. NOS. 1,685,412, 2,133,086, AND OTHERS.

CLASS 1—CHEMICALS

FOR WATERPROOFING CHEMICAL COMPOUNDS FOR ARTICLES OF LEATHER (U.S. CLS. 1, 5, 6, 10, 26 AND 46).
FIRST USE 12-31-1996; IN COMMERCE 12-31-1996.

CLASS 3—COSMETICS AND CLEANING PREPARATIONS

FOR CLEANING SOLVENTS, LOTIONS AND CREAM FOR FOOTWEAR, AND SHOE AND BOOT POLISH (U.S. CLS. 1, 4, 6, 50, 51 AND 52).
FIRST USE 12-31-1996; IN COMMERCE 12-31-1996.

CLASS 21—HOUSEWARES AND GLASS

FOR SHOE BRUSHES AND POLISHING CLOTHS FOR APPLYING SOLVENTS TO BE USED AS A SCUFF REMOVER (U.S. CLS. 2, 13, 23, 29, 30, 33, 40 AND 50).
FIRST USE 12-31-1996; IN COMMERCE 12-31-1996.

2,571,803. J.A. STYERS, LLC, NORTHVILLE, MI. SN 75-623,964. PUB. 11-16-1999, FILED 1-20-1999.

EXPECT TO WIN

CLASS 25—CLOTHING

FOR CLOTHING, HAT, T-SHIRTS AND SWEATSHIRTS (U.S. CLS. 22 AND 39).
FIRST USE 9-15-2000; IN COMMERCE 9-15-2000.

CLASS 41—EDUCATION AND ENTERTAINMENT

FOR EDUCATIONAL SERVICES, NAMELY, PROVIDING MOTIVATIONAL SPEAKER AND CONDUCTING SEMINARS IN THE FIELD OF PERSONAL IMPROVEMENT (U.S. CLS. 100, 101 AND 107).
FIRST USE 10-1-2000; IN COMMERCE 10-1-2000.

2,571,805. VYSIS, INC., DOWNER GROVE, IL. SN 75-627,509.
PUB. 11-30-1999, FILED 1-26-1999.

AMPLIONC

CLASS 1—CHEMICALS

FOR DIAGNOSTIC KITS COMPOSED OF REAGENTS AND ANTIBODIES FOR SCIENTIFIC RESEARCH (U.S. CLS. 1, 5, 6, 10, 26 AND 46).
FIRST USE 12-0-1999; IN COMMERCE 12-0-1999.

CLASS 5—PHARMACEUTICALS

FOR DIAGNOSTIC KITS COMPOSED OF REAGENTS AND ANTIBODIES FOR CLINICAL MEDICAL LABORATORY USE (U.S. CLS. 6, 18, 44, 46, 51 AND 52).
FIRST USE 12-0-1999; IN COMMERCE 12-0-1999.

2,571,807. ADLER GROUP, INC., MIAMI, FL. SN 75-630,198.
PUB. 11-16-1999, FILED 1-29-1999.



NO CLAIM IS MADE TO THE EXCLUSIVE RIGHT TO USE "FLEX SPACE", APART FROM THE MARK AS SHOWN.

THE MARK IS LINED FOR THE COLORS LIGHT GREEN, DARK GREEN, BEIGE AND BROWN. THE SECOND "X" IN "FLEXX" CONTAINS STIPLING AND IS INTENDED TO BE THE COLOR GRAY.

CLASS 35—ADVERTISING AND BUSINESS

FOR MANAGEMENT OF WAREHOUSE SPACE (U.S. CLS. 100, 101 AND 102).
FIRST USE 10-26-2001; IN COMMERCE 10-26-2001.

CLASS 36—INSURANCE AND FINANCIAL

FOR REAL ESTATE MANAGEMENT, NAMELY, MANAGING REAL ESTATE IN THE FORM OF INDUSTRIAL, COMMERCIAL BUILDING AND OFFICE SPACE; LEASING AND RENTAL OF INDUSTRIAL, COMMERCIAL BUILDING AND OFFICE SPACE (U.S. CLS. 100, 101 AND 102).
FIRST USE 10-26-2001; IN COMMERCE 10-26-2001.

CLASS 39—TRANSPORTATION AND STORAGE

FOR LEASING AND RENTAL OF WAREHOUSE SPACE (U.S. CLS. 100 AND 105).
FIRST USE 10-26-2001; IN COMMERCE 10-26-2001.

2,571,809. ADLER GROUP, INC., MIAMI, FL. SN 75-631,535.
PUB. 11-16-1999, FILED 2-1-1999.



NO CLAIM IS MADE TO THE EXCLUSIVE RIGHT TO USE "FLEX SPACE", APART FROM THE MARK AS SHOWN.

THE MARK IS LINED FOR COLORS LIGHT GREEN, DARK GREEN, COBALT BLUE AND PERIWINKLE BLUE. THE SECOND "X" IN "FLEXX" CONTAINS STIPPLING AND IS INTENDED TO BE THE COLOR GRAY.

CLASS 35—ADVERTISING AND BUSINESS

FOR MANAGEMENT OF WAREHOUSE SPACE (U.S. CLS. 100, 101 AND 102).
FIRST USE 12-1-2001; IN COMMERCE 12-1-2001.

CLASS 36—INSURANCE AND FINANCIAL

FOR REAL ESTATE MANAGEMENT, NAMELY, MANAGING REAL ESTATE IN THE FORM OF INDUSTRIAL, COMMERCIAL BUILDING AND OFFICE SPACE; LEASING AND RENTAL OF INDUSTRIAL, COMMERCIAL BUILDING AND OFFICE SPACE (U.S. CLS. 100, 101 AND 102).
FIRST USE 12-1-2001; IN COMMERCE 12-1-2001.

CLASS 39—TRANSPORTATION AND STORAGE

FOR LEASING AND RENTAL OF WAREHOUSE SPACE (U.S. CLS. 100 AND 105).
FIRST USE 12-1-2001; IN COMMERCE 12-1-2001.

2,571,810. ADLER GROUP, INC., MIAMI, FL. SN 75-631,538.
PUB. 11-30-1999, FILED 2-1-1999.



NO CLAIM IS MADE TO THE EXCLUSIVE RIGHT TO USE "FLEX SPACE", APART FROM THE MARK AS SHOWN.

THE MARK IS LINED FOR COLORS LIGHT GREEN, DARK GREEN, COBALT BLUE AND PERIWINKLE BLUE. THE SECOND "X" IN "FLEXX" CONTAINS STIPPLING AND IS INTENDED TO BE THE COLOR GRAY.

CLASS 35—ADVERTISING AND BUSINESS

FOR MANAGEMENT OF WAREHOUSE SPACE (U.S. CLS. 100, 101 AND 102).
FIRST USE 10-13-2000; IN COMMERCE 10-13-2000.

CLASS 36—INSURANCE AND FINANCIAL

FOR REAL ESTATE MANAGEMENT, NAMELY, MANAGING REAL ESTATE IN THE FORM OF INDUSTRIAL, COMMERCIAL BUILDING AND OFFICE SPACE; LEASING AND RENTAL OF INDUSTRIAL, COMMERCIAL BUILDING AND OFFICE SPACE (U.S. CLS. 100, 101 AND 102).
FIRST USE 10-13-2000; IN COMMERCE 10-13-2000.

CLASS 39—TRANSPORTATION AND STORAGE

FOR LEASING AND RENTAL OF WAREHOUSE SPACE (U.S. CLS. 100 AND 105).
FIRST USE 10-13-2000; IN COMMERCE 10-13-2000.

2,571,820. TRIGON INSURANCE COMPANY, DBA TRIGON BLUE CROSS BLUE SHIELD, RICHMOND, VA. SN 75-655,302. PUB. 5-15-2001, FILED 3-8-1999.

QUALITY-IN-SIGHTS**CLASS 35—ADVERTISING AND BUSINESS**

FOR HEALTHCARE COST REVIEW AND CONTAINMENT; HEALTHCARE UTILIZATION AND REVIEW SERVICES (U.S. CLS. 100, 101 AND 102).
FIRST USE 2-23-1999; IN COMMERCE 2-23-1999.

CLASS 42—SCIENTIFIC, COMPUTER AND LEGAL SERVICES

FOR PROVIDING QUALITY ASSURANCE SERVICES IN THE FIELD OF HEALTHCARE (U.S. CLS. 100 AND 101).
FIRST USE 2-23-1999; IN COMMERCE 2-23-1999.

2,571,834. NET INSIGHT AB, S-117 43 STOCKHOLM, SWEDEN. SN 75-676,552. PUB. 4-17-2001, FILED 4-6-1999.

2,571,836. GRAY COMMUNICATIONS, INC., CHICAGO, IL. SN 75-686,167. PUB. 1-9-2001, FILED 4-19-1999.

JAM CENTRAL

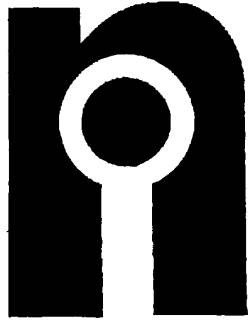

PRIORITY CLAIMED UNDER SEC. 44(D) ON SWEDEN APPLICATION NO. 98-0747, FILED 10-7-1998, REG. NO. 339736, DATED 8-25-2000, EXPIRES 8-25-2010.

THE MARK CONSISTS OF THE LETTERS "NI" IN STYLIZED FORM.

CLASS 9—ELECTRICAL AND SCIENTIFIC APPARATUS

FOR COMPUTERS, COMPUTER HARDWARE AND COMPUTER PERIPHERALS, NAMELY, SWITCHES, ACCESS DEVICES USED IN THE TELECOMMUNICATION NETWORKS, BRIDGES, ROUTERS, GATEWAYS, MULTIPLEXORS, ADD-DROP MULTIPLEXORS, DIGITAL CROSS-CONNECTS, HUBS, FIREWALLS COMPUTERS, FIBER OPTIC TERMINALS, REPEATERS, ROUTE SERVERS, COMPUTER INTERFACE (PCI) ADAPTER CIRCUIT BOARDS, NETWORK INTERFACE CIRCUIT BOARDS, NETWORK MANAGEMENT STATIONS, COMPRISING COMPUTER MONITORS, MICROPROCESSORS, AND APPLICATION SPECIFIC INTEGRATED CIRCUIT, MICROPROCESSORS, COMPUTER SOFTWARE FOR OPERATING ALL OF THE FOREGOING AND COMPUTER NETWORK MANAGEMENT SOFTWARE (U.S. CLS. 21, 23, 26, 36 AND 38).

FIRST USE 0-0-1998; IN COMMERCE 0-0-1998.

CLASS 37—CONSTRUCTION AND REPAIR

FOR INSTALLATION, MAINTENANCE AND REPAIR OF DATA AND TELECOMMUNICATION NETWORK EQUIPMENT, NOT BEING SOFTWARE (U.S. CLS. 100, 103 AND 106).

FIRST USE 0-0-1998; IN COMMERCE 0-0-1998.

CLASS 41—EDUCATION AND ENTERTAINMENT

FOR TRAINING IN THE USE AND OPERATION OF DATA AND TELECOMMUNICATIONS NETWORK EQUIPMENT, EDUCATION, NAMELY OFFERING SEMINARS AND LECTURES IN THE FIELD OF DATA AND TELECOMMUNICATIONS NETWORK EQUIPMENT (U.S. CLS. 100, 101 AND 107).

FIRST USE 0-0-1998; IN COMMERCE 0-0-1998.

CLASS 42—SCIENTIFIC, COMPUTER AND LEGAL SERVICES

FOR SOFTWARE INSTALLATION (U.S. CLS. 100 AND 101).

FIRST USE 0-0-1998; IN COMMERCE 0-0-1998.

CLASS 35—ADVERTISING AND BUSINESS

FOR RETAIL SERVICES, NAMELY MARKETING MUSICAL RECORDINGS, MUSICAL EQUIPMENT, MUSICAL INSTRUMENTS, AND SHEET MUSIC THROUGH MAIL-ORDER AND OVER THE INTERNET (U.S. CLS. 100, 101 AND 102).

FIRST USE 1-1-2000; IN COMMERCE 1-1-2000.

CLASS 38—COMMUNICATION

FOR RADIO AND INTERNET BROADCASTING OF MUSIC (U.S. CLS. 100, 101 AND 104).

FIRST USE 1-1-2000; IN COMMERCE 1-1-2000.

2,571,840. ASPEN GROVE, INC., MARLTON, NJ. SN 75-696,125. PUB. 5-29-2001, FILED 5-3-1999.

ASPEN GROVE

CLASS 9—ELECTRICAL AND SCIENTIFIC APPARATUS

FOR COMPUTER SOFTWARE IN THE FIELD OF PROFESSIONAL SERVICES WORKFLOW MANAGEMENT, THAT MAY BE DOWNLOADED FROM A GLOBAL COMPUTER NETWORK (U.S. CLS. 21, 23, 26, 36 AND 38).

FIRST USE 9-1-1998; IN COMMERCE 9-1-1998.

CLASS 42—SCIENTIFIC, COMPUTER AND LEGAL SERVICES

FOR PROVIDING TEMPORARY USE OF NON-DOWNLOADABLE SOFTWARE IN THE FIELD OF PROFESSIONAL SERVICES WORKFLOW MANAGEMENT; PROVIDING AN ON-LINE DATABASE IN THE FIELD OF PROFESSIONAL SERVICES WORKFLOW MANAGEMENT (U.S. CLS. 100 AND 101).

FIRST USE 9-1-1998; IN COMMERCE 9-1-1998.

2,571,841. UNITED SPORTS VENTURES, INC., NEW YORK, NY. SN 75-696,377. PUB. 3-6-2001, FILED 5-3-1999.

RIVER OTTERS

CLASS 9—ELECTRICAL AND SCIENTIFIC APPARATUS

FOR ORNAMENTAL MAGNETS, PROTECTIVE HELMETS FOR HOCKEY (U.S. CLS. 21, 23, 26, 36 AND 38).

FIRST USE 9-15-2001; IN COMMERCE 9-15-2001.

CLASS 14—JEWELRY

FOR JEWELRY, NAMELY EARRINGS AND PENDANTS (U.S. CLS. 2, 27, 28 AND 50).

FIRST USE 9-15-2001; IN COMMERCE 9-15-2001.

CLASS 16—PAPER GOODS AND PRINTED MATTER

FOR PAPER GOODS AND PRINTED MATTER, NAMELY, POSTERS, MAGAZINES ABOUT ICE HOCKEY FEATURING GAME PROGRAMS, BOOKS ABOUT ICE HOCKEY, BUMPER STICKERS, DECALS, BANNERS, PAPER FLAGS AND PENNANTS, PENS IN PENCILS (U.S. CLS. 2, 5, 22, 23, 29, 37, 38 AND 50).

FIRST USE 9-15-2001; IN COMMERCE 9-15-2001.

CLASS 21—HOUSEWARES AND GLASS

FOR MUGS AND BEVERAGE GLASSES (U.S. CLS. 2, 13, 23, 29, 30, 33, 40 AND 50).

FIRST USE 9-15-2001; IN COMMERCE 9-15-2001.

CLASS 28—TOYS AND SPORTING GOODS

FOR TOYS AND SPORTING GOODS, NAMELY HOCKEY STICKS, MINI HOCKEY STICKS, HOCKEY GOALS, PROTECTIVE GEAR, OTHER THAN HELMETS, HOCKEY PUCKS, HOCKEY MASKS, GOLF BALLS AND STUFFED TOY ANIMALS (U.S. CLS. 22, 23, 38 AND 50).

FIRST USE 9-15-2001; IN COMMERCE 9-15-2001.

2,571,854. HERMAN SURVIVORS INC., ARMONK, NY. SN 75-713,204. PUB. 9-12-2000, FILED 5-24-1999.



OWNER OF U.S. REG. NOS. 763,988, 1,745,870, AND OTHERS.

NO CLAIM IS MADE TO THE EXCLUSIVE RIGHT TO USE "SINCE 1879", APART FROM THE MARK AS SHOWN.

CLASS 18—LEATHER GOODS

FOR ALL PURPOSE ATHLETIC BAGS, ALL PURPOSE SPORT BAGS, BACKPACKS, DUFFEL BAGS, GYM BAGS, BOOK BAGS, GARMENT BAGS FOR TRAVEL, KNAPSACKS, OVERNIGHT BAGS AND CASES, TOTE BAGS, TRAVEL BAGS, TRAVELING BAGS AND WAIST PACKS (U.S. CLS. 1, 2, 3, 22 AND 41).

FIRST USE 1-1-1999; IN COMMERCE 1-1-1999.

CLASS 25—CLOTHING

FOR COATS, JACKETS, ANORAKS, PARKAS, FOOTWEAR, ATHLETIC FOOTWEAR, GLOVES, SKI GLOVES, GOLF SHIRTS, GOLF SHOES, GYM SHORTS, SHIRTS, POLO SHIRTS AND VESTS (U.S. CLS. 22 AND 39).

FIRST USE 1-1-1999; IN COMMERCE 1-1-1999.

2,571,846. GONZALEZ, GLORIA, LA JOLLA, CA. SN 75-701,374. PUB. 10-31-2000, FILED 5-10-1999.

EIGHT ELEMENTS WEST**CLASS 9—ELECTRICAL AND SCIENTIFIC APPARATUS**

FOR PRE-RECORDED, VIDEO-CASSETTES, AND CD DISKS, FEATURING MUSIC, FITNESS TRAINING, EXERCISE, AND HEALTH (U.S. CLS. 21, 23, 26, 36 AND 38).

FIRST USE 12-0-2000; IN COMMERCE 1-0-2001.

CLASS 16—PAPER GOODS AND PRINTED MATTER

FOR BOOKS FEATURING FITNESS TRAINING, EXERCISE, HEALTH, AND NUTRITION- (U.S. CLS. 2, 5, 22, 23, 29, 37, 38 AND 50).

FIRST USE 11-0-2001; IN COMMERCE 11-0-2001.

CLASS 41—EDUCATION AND ENTERTAINMENT

FOR WEIGHT TRAINING, FITNESS TRAINING, EXERCISE TRAINING; HEALTH, FITNESS, EXERCISE, AND NUTRITIONAL EDUCATION; YOGA INSTRUCTION, MARTIAL ARTS INSTRUCTION, SELF-AWARENESS EDUCATIONAL SERVICES, NAMELY, CONDUCTING CLASSES, SEMINARS, WORKSHOPS, AND RETREATS, AND HEALTH CLUB SERVICES (U.S. CLS. 100, 101 AND 107).

FIRST USE 6-0-1999; IN COMMERCE 6-0-2000.

2,571,858. ACCESS: GLOBAL, INCORPORATED, PLANO, TX. SN 75-716,701. PUB. 2-6-2001, FILED 5-28-1999.

DIRECTOR'S SELECT**CLASS 8—HAND TOOLS**

FOR SCISSORS (U.S. CLS. 23, 28 AND 44).

FIRST USE 9-7-1999; IN COMMERCE 9-7-1999.

CLASS 16—PAPER GOODS AND PRINTED MATTER

FOR OFFICE PRODUCTS, NAMELY, PAPER HOLE PUNCHES, STAPLES, PAPER STAPLERS, BINDER CLIPS, ADHESIVES FOR STATIONERY OR HOUSEHOLD PURPOSES, REPORT COVERS, PAPER CLIPS, SHEET PROTECTORS, THUMB TACKS, PUSH PINS, CLIP BOARDS, LETTER OPENERS, RUBBERBANDS (U.S. CLS. 2, 5, 22, 23, 29, 37, 38 AND 50).

FIRST USE 9-7-1999; IN COMMERCE 9-7-1999.

2,571,862. TRAVELBYUS.COM, INC., WHITE ROCK, B.C., CANADA. SN 75-724,528. PUB. 12-5-2000, FILED 6-9-1999.



NO CLAIM IS MADE TO THE EXCLUSIVE RIGHT TO USE "TRAVEL MADE EASY" AND ".COM", APART FROM THE MARK AS SHOWN.

CLASS 35—ADVERTISING AND BUSINESS

FOR COOPERATIVE ADVERTISING AND MARKETING IN THE FIELD OF TRAVEL; ADVERTISING AGENCIES, NAMELY, PROMOTING THE SERVICES OF THE TRAVEL INDUSTRY THROUGH THE DISTRIBUTION OF PRINTED AND AUDIO PROMOTIONAL MATERIALS OVER THE RADIO, TELEVISION AND GLOBAL COMPUTER NETWORK (U.S. CLS. 100, 101 AND 102).

FIRST USE 6-0-1999; IN COMMERCE 9-0-1999.

CLASS 39—TRANSPORTATION AND STORAGE

FOR TRAVEL AGENCY SERVICES, NAMELY MAKING RESERVATIONS AND BOOKINGS FOR TRANSPORTATION; ARRANGING TRAVEL TOURS; TRANSPORTATION OF PASSENGERS BY ROAD, RAIL, SEA AND AIR; TRAVEL INFORMATION SERVICES; TRAVEL AGENCY SERVICES, NAMELY OBTAINING TICKETS FOR TRAVEL (U.S. CLS. 100 AND 105).

FIRST USE 6-0-1999; IN COMMERCE 9-0-1999.

CLASS 42—SCIENTIFIC, COMPUTER AND LEGAL SERVICES

FOR TRAVEL AGENCY SERVICES, NAMELY MAKING RESERVATIONS AND BOOKINGS FOR LODGING; PROVIDING CONSULTATION IN THE FIELD OF TRAVEL (U.S. CLS. 100 AND 101).

FIRST USE 6-0-1999; IN COMMERCE 9-0-1999.

2,571,867. TECHNOLOGY EDUCATION NETWORK, INC., ARDSLEY, NY. SN 75-732,869. PUB. 5-15-2001, FILED 6-21-1999.

VIDEOMINING

CLASS 39—TRANSPORTATION AND STORAGE

FOR ELECTRONIC STORAGE AND ARCHIVING OF VIDEO CLIPS AND VIDEO MATERIALS OF OTHERS ON A COMPUTER SERVER ACCESSIBLE VIA GLOBAL COMPUTER NETWORK (U.S. CLS. 100 AND 105).

FIRST USE 9-0-1999; IN COMMERCE 9-0-1999.

CLASS 41—EDUCATION AND ENTERTAINMENT

FOR PROVIDING AN ONLINE COMPUTER DATABASE IN THE FIELD OF VIDEO CLIPS THAT ARE SEARCHABLE USING KEY WORDS AND OTHER FIELDS (U.S. CLS. 100, 101 AND 107).

FIRST USE 9-0-1999; IN COMMERCE 9-0-1999.

2,571,868. RETRO 1951, INC., RICHARDSON, TX. SN 75-732,978. PUB. 8-29-2000, FILED 6-21-1999.

TORNADO

CLASS 16—PAPER GOODS AND PRINTED MATTER

FOR LEATHER GOODS, NAMELY, PASSPORT CASES AND STATIONERY-TYPE PORTFOLIOS (U.S. CLS. 2, 5, 22, 23, 29, 37, 38 AND 50).

FIRST USE 5-20-2001; IN COMMERCE 5-20-2001.

CLASS 18—LEATHER GOODS

FOR LEATHER GOODS, NAMELY, BUSINESS CARD CASES, WALLETS, BRIEFCASE-TYPE PORTFOLIOS, KEY FOBBS, TOTE BAGS, SCHOOL BAGS, TRAVEL BAGS, BRIEFCASES, TOILETRY CASES SOLD EMPTY, LUGGAGE TAGS, WAIST PACKS AND DOCUMENT CASES (U.S. CLS. 1, 2, 3, 22 AND 41).

FIRST USE 5-20-2001; IN COMMERCE 5-20-2001.

2,571,870. PERSONAL CLIMATE CONTROL, INC., HOUSTON, TX, BY ASSIGNMENT LAVIN, EDWARD F., JR., HOUSTON, TX. SN 75-733,964. PUB. 11-14-2000, FILED 6-22-1999.

COOLBAND

CLASS 10—MEDICAL APPARATUS

FOR APPARATUS FOR ATTACHING COOLING WRIST PACKS FOR LOWERING BODY TEMPERATURE, FOR THERAPEUTIC USE (U.S. CLS. 26, 39 AND 44).

FIRST USE 5-15-2000; IN COMMERCE 5-15-2000.

CLASS 28—TOYS AND SPORTING GOODS

FOR SPORTING GOODS, NAMELY WRIST WRAPS AND HOUSINGS FOR COLD PACK INSERTS FOR USE IN LOWERING BODY TEMPERATURE DURING EXERCISE AND SPORTING EVENTS (U.S. CLS. 22, 23, 38 AND 50).

FIRST USE 5-15-2000; IN COMMERCE 5-15-2000.

2,571,875. ADWARE SYSTEMS, INC., LOUISVILLE, KY. SN 75-741,703. PUB. 9-19-2000, FILED 6-30-1999.

@DVAULT

OWNER OF U.S. REG. NO. 2,286,002.

CLASS 39—TRANSPORTATION AND STORAGE

FOR ELECTRONIC STORAGE OF MARKETING COMMUNICATIONS MATTER (U.S. CLS. 100 AND 105).

FIRST USE 7-0-2001; IN COMMERCE 7-0-2001.

CLASS 41—EDUCATION AND ENTERTAINMENT

FOR PROVIDING TRAINING IN THE FIELD OF COMPUTER SOFTWARE FOR USE IN MARKETING COMMUNICATIONS (U.S. CLS. 100, 101 AND 107).

FIRST USE 7-0-2001; IN COMMERCE 7-0-2001.

CLASS 42—SCIENTIFIC, COMPUTER AND LEGAL SERVICES

FOR COMPUTER SOFTWARE DESIGN FOR OTHERS (U.S. CLS. 100 AND 101).
FIRST USE 7-0-2001; IN COMMERCE 7-0-2001.

2,571,877. ALUMA ENTERPRISES INC., TORONTO ONTARIO M3H 5S8, CANADA. SN 75-747,027. PUB. 3-6-2001, FILED 7-9-1999.

AlumaSystems 

PRIORITY CLAIMED UNDER SEC. 44(D) ON CANADA APPLICATION NO. 1,001,643, FILED 1-11-1999.

CLASS 6—METAL GOODS

FOR CONCRETE SHORING, FORM SHORING AND SUPPORTING EQUIPMENT, NAMELY: METAL FORMS, FITTINGS, PARTS AND ACCESSORIES FOR CONCRETE FORMING EQUIPMENT AND APPARATUS, ALL OF METAL, NAMELY: BEAMS, GIRDERS, TRUSSES, STRINGERS, BRACES, EXTENSION LEGS, STRONGBACKS, STIFFBACKS, WALERS, STRONGBACK SHOES, TIE-BOLTS, CLAMPS, CASTERS, ROLLERS, BOLTS, NUTS, PINS, CLIPS, BRACING LUGS, SPLICES, TIE-PLATES, CHORD FILLERS, HANGARS, WALL JACKS, SAFETY BARRIERS, BRACE AND PLUMB BRACKETS, WALL PLUMBING DEVICES, CATWALKS, CATWALK BRACKETS, LEDGERS, KNEE BRACES, OUTRIGGERS, WALL FORMS, PAN FORMS, COLUMN FORMS, BEAM FORMS, SPANDREL FORMS, TUNNEL FORMS AND LIFTING SLINGS (U.S. CLS. 2, 12, 13, 14, 23, 25 AND 50).

FIRST USE 7-12-1999; IN COMMERCE 7-12-1999.

CLASS 37—CONSTRUCTION AND REPAIR

FOR LEASING CONSTRUCTION EQUIPMENT, LEASING CONCRETE FORMING EQUIPMENT AND APPARATUS FOR USE IN THE CONSTRUCTION INDUSTRY, NAMELY: LEASING CONCRETE SHORING, FORM SHORING AND SUPPORTING EQUIPMENT AND SCAFFOLDING SYSTEMS (U.S. CLS. 100, 103 AND 106).

FIRST USE 7-12-1999; IN COMMERCE 7-12-1999.

2,571,891. CYBERSHIELD INTERNATIONAL, INC., DALLAS, TX. SN 75-766,417. PUB. 2-6-2001, FILED 8-2-1999.

CYBERSHIELD

CLASS 40—MATERIAL TREATMENT

FOR APPLYING ELECTRICALLY CONDUCTIVE COATINGS TO OBJECTS IN ORDER TO FORM AN ELECTROMAGNETIC INTERFERENCE/RADIO FREQUENCY INTERFERENCE SHIELD (U.S. CLS. 100, 103 AND 106).

FIRST USE 8-0-1999; IN COMMERCE 4-0-2000.

CLASS 42—SCIENTIFIC, COMPUTER AND LEGAL SERVICES

FOR CUSTOM DESIGN, DESIGN AND TESTING FOR NEW PRODUCT DEVELOPMENT, AND PROJECT MANAGEMENT SERVICES IN THE FIELD OF PRODUCTS USING ELECTRICALLY CONDUCTIVE COATINGS; TECHNICAL CONSULTING SERVICES IN THE FIELD OF ELECTRICALLY CONDUCTIVE COATINGS (U.S. CLS. 100 AND 101).

FIRST USE 8-0-1999; IN COMMERCE 4-0-2000.

2,571,894. HEXCEL CORPORATION, DUBLIN, CA. SN 75-769,248. PUB. 12-12-2000, FILED 8-6-1999.

HEXWEB

CLASS 6—METAL GOODS

FOR METALLIC HONEYCOMB AND METALLIC SANDWICH PANELS (U.S. CLS. 2, 12, 13, 14, 23, 25 AND 50).

FIRST USE 7-26-2000; IN COMMERCE 7-26-2000.

CLASS 17—RUBBER GOODS

FOR COMPOSITE MATERIALS, NAMELY NON-METALLIC HONEYCOMB FOR USE IN THE MANUFACTURE OF AEROSPACE, SPACE AND DEFENSE, RECREATION, ARCHITECTURAL, TRANSPORTATION, MARINE, AND GENERAL INDUSTRIAL PRODUCTS (U.S. CLS. 1, 5, 12, 13, 35 AND 50).

FIRST USE 7-26-2000; IN COMMERCE 7-26-2000.

2,571,896. ZYWAVE, INC., MILWAUKEE, WI. SN 75-773,003. PUB. 2-22-2000, FILED 8-11-1999.

MYWAVE

CLASS 36—INSURANCE AND FINANCIAL

FOR PROVIDING INSURANCE INFORMATION OVER A GLOBAL COMPUTER NETWORK (U.S. CLS. 100, 101 AND 102).

FIRST USE 12-15-1999; IN COMMERCE 12-15-1999.

CLASS 42—SCIENTIFIC, COMPUTER AND LEGAL SERVICES

FOR WEB HOSTING SERVICES AND DESIGNING AND CREATING WEB PAGES FOR OTHERS (U.S. CLS. 100 AND 101).

FIRST USE 12-15-1999; IN COMMERCE 12-15-1999.

2,571,902. ARGONAUT SOFTWARE LIMITED, MIDDLESEX HA8 5XZ, ENGLAND. SN 75-786,457. PUB. 10-3-2000, FILED 8-27-1999.

RED DOG

CLASS 9—ELECTRICAL AND SCIENTIFIC APPARATUS

FOR MULTIMEDIA SOFTWARE RECORDED ON CD-ROM, DVD AND GD-ROM FOR PLAYING GAMES FOR ENTERTAINMENT; PRE-RECORDED AUDIOTAPES, VIDEOTAPES, AUDIO-CASSETTES, VIDEO-CASSETTES, AUDIO-CARTRIDGES AND VIDEO-CARTRIDGES, ALL FEATURING GAMES FOR ENTERTAINMENT; COMPUTER GAME CARTRIDGES; COMPUTER GAME SOFTWARE; COMPUTER GAME TAPES; COMPUTER GAME JOY STICKS; VIDEO GAMES CARTRIDGES (U.S. CLS. 21, 23, 26, 36 AND 38).

FIRST USE 10-31-2000; IN COMMERCE 10-31-2000.

CLASS 16—PAPER GOODS AND PRINTED MATTER

FOR BOOKS AND MAGAZINES RELATING TO GAMES AND TO CARTOON CHARACTERS AND SITUATIONS; GRAPHIC ART PRINTS, PICTURES, POSTERS, POSTCARDS, MOUNTED AND UNMOUNTED PHOTOGRAPHS, CALENDARS, DIARIES, GREETINGS CARDS, PLAYING-CARDS, WRAPPING-PAPER; PAPER BAGS AND SACKS FOR PACKAGING, PACKING-PAPER, PLASTICS MATERIALS IN FILM AND IN SHEET, ALL FOR WRAPPING; PLASTIC BAGS AND SACKS FOR PACKAGING; CARDBOARD BOXES AND PACKAGING CARTONS; STATIONERY; WRITING INSTRUMENTS; PAPERWEIGHTS; PRINTED PENCIL CASES; UNGRADUATED RULERS FOR USE IN DRAWING; DECALCOMANIAS; MAPS; PAPER BEER-MATS, PAPER TABLE MATS; PAPER TABLE-NAPKINS; PAPER TABLECLOTHS; HANDKERCHIEFS OF PAPER; MANUALS OF INSTRUCTION AND EXPLANATION IN THE FIELD OF VIDEO GAMES, DOCUMENT FILES; STICKERS; PRINTED WALL-CHARTS, COMIC STRIPS IN GENERAL FOR NEWSPAPERS OR MAGAZINES; COMIC BOOKS; HOLOGRAMS (U.S. CLS. 2, 5, 22, 23, 29, 37, 38 AND 50).

FIRST USE 10-31-2000; IN COMMERCE 10-31-2000.

2,571,903. SOMA BLUE, INC., AUGUSTA, GA. SN 75-792,286. PUB. 5-15-2001, FILED 9-3-1999.

SOMA BLUE

NO CLAIM IS MADE TO THE EXCLUSIVE RIGHT TO USE "SOMA", APART FROM THE MARK AS SHOWN.

CLASS 5—PHARMACEUTICALS

FOR GYNECOLOGY, UROLOGY, UROGYNECOLOGY, FERTILITY, THERAPEUTIC AND DIAGNOSTIC REAGENTS FOR CLINICAL, MEDICAL USE (U.S. CLS. 6, 18, 44, 46, 51 AND 52).

FIRST USE 9-0-1999; IN COMMERCE 12-0-1999.

CLASS 10—MEDICAL APPARATUS

FOR GYNECOLOGY, UROLOGY, UROGYNECOLOGY, FERTILITY, THERAPEUTIC AND DIAGNOSTIC DEVICES, NAMELY TENSION RINGS AND VACUUM THERAPY PUMPS (U.S. CLS. 26, 39 AND 44).

FIRST USE 9-0-1999; IN COMMERCE 12-0-1999.

2,571,908. HERM. SPRENGER GMBH & CO. KG, D-58644 ISERLOHN, FED REP GERMANY. SN 75-796,962. PUB. 12-19-2000, FILED 9-13-1999.

SPRENGER ULTRA

OWNER OF U.S. REG. NO. 1,550,721.

CLASS 6—METAL GOODS

FOR GOODS MADE OF COMMON METALS AND THEIR ALLOYS FOR HORSEBACK RIDING, NAMELY, STIRRUPS (U.S. CLS. 2, 12, 13, 14, 23, 25 AND 50).

FIRST USE 12-31-1999; IN COMMERCE 12-31-1999.

CLASS 18—LEATHER GOODS

FOR WHIPS; LEATHER HARNESS AND SADDLERY GOODS, NAMELY, HARNESS STRAPS, AND HARNESS FITTINGS, STIRRUPS, RIDING SADDLES, BITS FOR HORSES AND HALTERS FOR HORSES (U.S. CLS. 1, 2, 3, 22 AND 41).

FIRST USE 12-31-1999; IN COMMERCE 12-31-1999.

2,571,917. CLARUS CORPORATION, SUWANEE, GA. SN 75-812,485. PUB. 10-24-2000, FILED 9-30-1999.

ETOUR

CLASS 9—ELECTRICAL AND SCIENTIFIC APPARATUS

FOR COMPUTER SOFTWARE COMPONENTS, NAMELY AN END-USER APPLICATION PROVIDING TRAINING AND INSTRUCTION IN THE USE AND OPERATION OF COMPUTER SOFTWARE SOLD THEREWITH (U.S. CLS. 21, 23, 26, 36 AND 38).

FIRST USE 12-8-1999; IN COMMERCE 12-8-1999.

CLASS 41—EDUCATION AND ENTERTAINMENT

FOR COMPUTER EDUCATION TRAINING SERVICES (U.S. CLS. 100, 101 AND 107).

FIRST USE 12-8-1999; IN COMMERCE 12-8-1999.

2,571,918. THIELEN, JEFF, ST. PAUL, MN. SN 75-814,160. PUB. 5-29-2001, FILED 10-4-1999.

PEOPLEHISTORY

CLASS 35—ADVERTISING AND BUSINESS

FOR COMPUTERIZED ONLINE RETAIL SERVICES IN THE FIELD OF VIDEO RECORDINGS, MUSIC RECORDINGS, VOICE RECORDINGS, BOOKS, MAPS, CALENDARS, POSTERS, MUGS AND CUPS, KEY CHAINS, T-SHIRTS, HATS, PRINTS, PAINTINGS, AND SCULPTURES (U.S. CLS. 100, 101 AND 102).

FIRST USE 1-5-2002; IN COMMERCE 1-5-2002.

CLASS 42—SCIENTIFIC, COMPUTER AND LEGAL SERVICES

FOR PROVIDING INFORMATION IN THE FIELD OF BIOGRAPHIES AND HISTORY VIA A GLOBAL COMPUTER NETWORK (U.S. CLS. 100 AND 101).

FIRST USE 1-5-2002; IN COMMERCE 1-5-2002.

2,571,919. VANGUARD PIPING SYSTEMS, INC., MCPHERSON, KS. SN 75-816,392. PUB. 3-13-2001, FILED 10-5-1999.

CRIMPSERT

CLASS 6—METAL GOODS

FOR METAL ADAPTORS, CONNECTORS, COUPLINGS, CRIMP RINGS, ELBOWS AND TEES FOR USE IN CONNECTING PLASTIC PLUMBING LINES; METAL PIPE PLUGS (U.S. CLS. 2, 12, 13, 14, 23, 25 AND 50).

FIRST USE 7-12-1999; IN COMMERCE 7-12-1999.

CLASS 20—FURNITURE AND ARTICLES NOT OTHERWISE CLASSIFIED

FOR NON-METAL ADAPTORS, CONNECTORS, COUPLINGS, ELBOWS AND TEES FOR USE IN CONNECTING PLASTIC PLUMBING LINES; NON-METAL PIPE PLUGS (U.S. CLS. 2, 13, 22, 25, 32 AND 50).

FIRST USE 8-10-2000; IN COMMERCE 8-10-2000.

2,571,933. MARSHALL'S OF MA, INC., FRAMINGHAM, MA. SN 75-835,974. PUB. 7-11-2000, FILED 10-29-1999.

VIP EMAIL

NO CLAIM IS MADE TO THE EXCLUSIVE RIGHT TO USE "EMAIL", APART FROM THE MARK AS SHOWN.

CLASS 35—ADVERTISING AND BUSINESS

FOR RETAIL STORE SERVICES FEATURING CLOTHING, GIFTWARE, JEWELRY, STATIONERY, PICTURE FRAMES, HOME TEXTILE ARTICLES, HOME FURNISHINGS, TOYS AND GAMES AND PLAYTHINGS, PURSES, POCKETBOOKS, AND UMBRELLAS AND WITH ELECTRONIC NOTIFICATION OF STORE EVENTS (U.S. CLS. 100, 101 AND 102).

FIRST USE 11-30-1999; IN COMMERCE 11-30-1999.

CLASS 42—SCIENTIFIC, COMPUTER AND LEGAL SERVICES

FOR COMPUTER SERVICES, NAMELY PROVIDING AN ON-LINE NOTIFICATION OF EVENTS IN RETAIL STORES FEATURING THE FIELDS OF CLOTHING, FASHIONS, JEWELRY, TOYS AND GAMES AND PLAYTHINGS, PURSES, POCKETBOOKS, UMBRELLAS, HOME FURNISHINGS GIFTS, ARTS, MUSIC, ENTERTAINMENT, CULTURAL, SPORTING EVENTS, GIFTWARE, STATIONARY, PICTURE FRAMES, AND HOME TEXTILE ARTICLES (U.S. CLS. 100 AND 101).

FIRST USE 11-30-1999; IN COMMERCE 11-30-1999.

2,571,939. ATLANTIC RICHFIELD COMPANY, CHICAGO, IL. SN 75-842,768. PUB. 7-18-2000, FILED 11-8-1999.

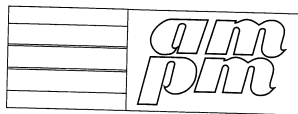

OWNER OF U.S. REG. NOS. 1,227,005, 2,295,250, AND OTHERS.
THE COLORS OF THE STRIPING DESIGN, LISTED IN

ORDER FROM TOP TO BOTTOM ARE: ORANGE, RED, PEARL GRAY, SILVER, PEARL GRAY, RED AND BLUE. THE ORANGE, RED, SILVER, AND BLUE BANDS ARE OF EQUAL SIZE WHILE THE PEARL GRAY BANDS ARE NARROW DIVIDERS.

THE MARK CONSISTS OF THE STYLIZED LETTERS "AM" AND "PM" ON A SILVER AND A HORIZONTAL COLORED STRIPING DESIGN. "AM" IS SHOWN IN GRADATIONS OF COLOR FROM ORANGE TO RED, AND "PM" IS SHOWN IN GRADATIONS OF COLOR FROM PURPLE TO BLUE.

CLASS 35—ADVERTISING AND BUSINESS

FOR CONVENIENCE STORE SERVICES (U.S. CLS. 100, 101 AND 102).

FIRST USE 6-10-1999; IN COMMERCE 6-10-1999.

CLASS 42—SCIENTIFIC, COMPUTER AND LEGAL SERVICES

FOR RESTAURANT SERVICES (U.S. CLS. 100 AND 101).

FIRST USE 6-10-1999; IN COMMERCE 6-10-1999.

2,571,942. CLUB LIBBY LU, LLC, CHICAGO, IL, BY ASSIGNMENT DROLET, MARY, CHICAGO, IL. SN 75-847,776. PUB. 12-26-2000, FILED 11-12-1999.

CLUB LIBBY LU

NO CLAIM IS MADE TO THE EXCLUSIVE RIGHT TO USE "CLUB", APART FROM THE MARK AS SHOWN.

THE MARK "LIBBY LU" DOES NOT REFER TO A PARTICULAR INDIVIDUAL.

CLASS 3—COSMETICS AND CLEANING PREPARATIONS

FOR COSMETICS, NAMELY, LIP STICK, NON-MEDICATED LIP GLOSS, NAMELY, LIP CREAM, LIP PROTECTOR, NON-MEDICATED LIP BALM, MAKE-UP AND FACE GLITTER; PERFUMES AND FRAGRANCES, NAMELY, EAU DE PERFUME AND EAU DE TOILETTE; SOAPS; SHAMPOOS; HAIR CONDITIONERS; BATH AND BODY ACCESSORIES, NAMELY, SHOWER GEL, BATH SALTS, BATH BUBBLES AND LOTIONS (U.S. CLS. 1, 4, 6, 50, 51 AND 52).

FIRST USE 8-16-2000; IN COMMERCE 8-16-2000.

CLASS 14—JEWELRY

FOR COSTUME JEWELRY AND ORNAMENTAL PINS (U.S. CLS. 2, 27, 28 AND 50).

FIRST USE 8-16-2000; IN COMMERCE 8-16-2000.

CLASS 18—LEATHER GOODS

FOR HAND BAGS, PURSES AND WALLETS (U.S. CLS. 1, 2, 3, 22 AND 41).

FIRST USE 8-16-2000; IN COMMERCE 8-16-2000.

CLASS 20—FURNITURE AND ARTICLES NOT OTHERWISE CLASSIFIED

FOR SLEEPING BAGS, DECORATIVE PILLOWS (U.S. CLS. 2, 13, 22, 25, 32 AND 50).

FIRST USE 8-16-2000; IN COMMERCE 8-16-2000.

CLASS 24—FABRICS

FOR BED LINENS (U.S. CLS. 42 AND 50).

FIRST USE 8-16-2000; IN COMMERCE 8-16-2000.

CLASS 25—CLOTHING

FOR CLOTHING, NAMELY, T-SHIRTS, SLEEPWEAR, UNDERWEAR AND CHILDREN'S HALLOWEEN AND MASQUERADE COSTUMES; AND FASHION ACCESSORIES, NAMELY HATS AND SCARVES (U.S. CLS. 22 AND 39).

FIRST USE 8-16-2000; IN COMMERCE 8-16-2000.

CLASS 26—FANCY GOODS

FOR HAIR ACCESSORIES, NAMELY CLIPS, PINS, HAIR BANDS, ORNAMENTAL COMBS AND BOWS (U.S. CLS. 37, 39, 40, 42 AND 50).

FIRST USE 8-16-2000; IN COMMERCE 8-16-2000.

2,571,946. ALGO VISION PLC, LONDON, ENGLAND. SN 75-852,051. PUB. 5-1-2001, FILED 11-18-1999.

PICTURES ON THE MOVE

NO CLAIM IS MADE TO THE EXCLUSIVE RIGHT TO USE "PICTURES", APART FROM THE MARK AS SHOWN.

CLASS 9—ELECTRICAL AND SCIENTIFIC APPARATUS

FOR COMPUTER HARDWARE AND COMPUTER SOFTWARE, NAMELY, COMPUTER HARDWARE AND SOFTWARE FOR THE COMMUNICATION OF PICTURES, VOICE, AND DATA VIA INTERNAL AND GLOBAL COMPUTER NETWORKS (U.S. CLS. 21, 23, 26, 36 AND 38).

FIRST USE 4-4-2000; IN COMMERCE 4-4-2000.

CLASS 38—COMMUNICATION

FOR ELECTRONIC TRANSMISSION OF PICTURES, VOICE, AND DATA VIA NETWORKS (U.S. CLS. 100, 101 AND 104).

FIRST USE 4-4-2000; IN COMMERCE 4-4-2000.

2,571,947. EBEL, BRANDON, SEATTLE, WA. SN 75-852,386. PUB. 4-3-2001, FILED 11-19-1999.

UPROK RECORDS

NO CLAIM IS MADE TO THE EXCLUSIVE RIGHT TO USE "RECORDS", APART FROM THE MARK AS SHOWN.

CLASS 9—ELECTRICAL AND SCIENTIFIC APPARATUS

FOR PHONOGRAPH RECORDS, AUDIO CASSETTES, COMPACT DISCS AND DIGITAL AUDIO TAPES, ALL FEATURING MUSIC; PRE-RECORDED MUSICAL VIDEO RECORDINGS (U.S. CLS. 21, 23, 26, 36 AND 38).

FIRST USE 12-1-1999; IN COMMERCE 2-1-2000.

CLASS 25—CLOTHING

FOR CLOTHING, NAMELY, SHIRTS, JACKETS, HATS, SOCKS, SHORTS, PANTS, SHOES, SWEATERS, SWEATSHIRTS (U.S. CLS. 22 AND 39).

FIRST USE 6-1-2001; IN COMMERCE 6-1-2001.

2,571,949. SHURFINE INTERNATIONAL, INC., NORTH-LAKE, IL. SN 75-853,411. PUB. 8-1-2000, FILED 11-19-1999.



OWNER OF U.S. REG. NOS. 1,405,162, 2,186,892, AND 2,284,434.

CLASS 21—HOUSEWARES AND GLASS

FOR PAPER AND PLASTIC CUPS, BOWLS AND PLATES (U.S. CLS. 2, 13, 23, 29, 30, 33, 40 AND 50).

FIRST USE 2-0-2000; IN COMMERCE 2-0-2000.

CLASS 29—MEATS AND PROCESSED FOODS

FOR FULL LINE OF RETAIL GROCERY, CONVENIENCE AND SUPERMARKET FOODS AND BEVERAGES, NAMELY, A FULL LINE OF DAIRY PRODUCTS, EXCLUDING ICE CREAM, ICE MILK, AND FROZEN YOGURT; A FULL LINE OF OILS; NONDAIRY WHIPPED TOPPINGS; FISH; UNFLAVORED AND UNSWEETENED GELATIN; INSTANT MILK, IMITATION CHEESE; INSTANT MASHED POTATO FLAKES; JAMS; JELLY; PROCESSED LEGUMES; PICKLED LEGUMES, MARGARINE; MEAT; PEANUT BUTTER; PICKLES; FRUIT-BASED PIE FILLING; PROCESSED OR CANNED PIMENTOS; POTATO CHIPS; POULTRY; PRESERVES; PROCESSED CANNED AND FROZEN FRUITS AND VEGETABLES; MILK-BASED, FRUIT-BASED, CHEESE, AND VEGETABLE-BASED SANDWICH SPREAD; SHORTENING; SOUP AND CHILI; TOMATO PASTE AND PUREE; DAIRY- AND VEGETABLE-BASED CHOCOLATE FOOD BEVERAGES (U.S. CL. 46).

FIRST USE 6-0-1999; IN COMMERCE 6-0-1999.

CLASS 30—STAPLE FOODS

FOR FULL LINE OF RETAIL GROCERY CONVENIENCE AND SUPERMARKET FOODS AND BEVERAGES, NAMELY, A FULL LINE OF COFFEE- AND COCOA-BASED GOODS; A FULL LINE OF CANDIES AND CONFECTIONS; A FULL LINE OF CONDIMENTS; A FULL LINE OF MIXES FOR MAKING BAKED GOODS; A FULL LINE OF PASTA; A FULL LINE OF SALT, SPICES AND SEASONINGS; A FULL LINE OF SALTY SNACKS; A FULL LINE OF SAUCES; HOT CHOCOLATE, CHOCOLATE POWDER, CHOCOLATE, CHOCOLATE SYRUP, CHOCOLATE TOPPING, CHOCOLATE FOOD BEVERAGES, EXCLUDING DAIRY OR VEGETABLE-BASED FOOD BEVERAGES; BAKING SODA; BREAKFAST CEREALS; CANDIED CAKE DECORATIONS; CHOCOLATE CHIPS; COCOA; COFFEE; COOKIES; CRACKERS; CUSTARD PIE FILLING; DRIED BARLEY; DRIED HERBS; FLAVORED SWEETENED GELATIN; FLAVORING EXTRACTS; FLOUR; FROSTING MIX; FROZEN PIZZA; GRAVY MIX; MARSHMALLOWS; MIXES COMPOSED PRIMARILY OF SEASONINGS, SPICES, AND DICED POTATO OR PASTA; POPPED POPCORN; RELISH; RICE; SHERBET; SUGAR; TABLE SYRUP; TEA; TOMATO SAUCE; VINEGAR; ICE CREAM, ICE MILK AND FROZEN YOGURT; MAYONNAISE; CHOCOLATE-BASED PIE FILLING (U.S. CL. 46).

FIRST USE 11-0-1999; IN COMMERCE 11-0-1999.

CLASS 31—NATURAL AGRICULTURAL PRODUCTS

FOR PET FOOD (U.S. CLS. 1 AND 46).

FIRST USE 8-0-1999; IN COMMERCE 8-0-1999.

CLASS 32—LIGHT BEVERAGES

FOR FULL LINE OF RETAIL GROCERY, CONVENIENCE AND SUPERMARKET FOODS AND BEVERAGES, NAMELY, BOTTLED WATER; FROZEN FRUIT JUICE CONCENTRATE; FRUIT AND VEGETABLE JUICES; MIXES FOR MAKING SOFT DRINKS, NON-ALCOHOLIC COCKTAIL MIXES; SOFT DRINKS (U.S. CLS. 45, 46 AND 48).

FIRST USE 8-0-1999; IN COMMERCE 8-0-1999.

2,571,951. SOLE S.P.A., I-33170 PORDENONE, ITALY. SN 75-859,166. PUB. 12-26-2000, FILED 11-29-1999.

THE ENGLISH TRANSLATION OF "SOLE" IS "SUN".

CLASS 7—MACHINERY

FOR ELECTRIC MOTORS, NAMELY UNIVERSAL MOTORS, ASYNCHRONOUS MOTORS, AND MOTOR PUMPS (U.S. CLS. 13, 19, 21, 23, 31, 34 AND 35).

FIRST USE 10-31-1999; IN COMMERCE 10-31-1999.

CLASS 9—ELECTRICAL AND SCIENTIFIC APPARATUS

FOR ELECTRONIC POWER DEVICES FOR THE CONTROL OF ELECTRIC MOTORS (U.S. CLS. 21, 23, 26, 36 AND 38).

FIRST USE 10-31-1999; IN COMMERCE 10-31-1999.

2,571,968. CHASING ARROWS, INC., ST. LOUIS, MO. SN 75-878,529. PUB. 1-16-2001, FILED 12-22-1999.

GREAT RIVERS ORGANICS

NO CLAIM IS MADE TO THE EXCLUSIVE RIGHT TO USE "ORGANICS", APART FROM THE MARK AS SHOWN.

CLASS 1—CHEMICALS

FOR FERTILIZER FOR DOMESTIC AND AGRICULTURAL USE, COMPOST, POTTING SOIL, POTTING SOIL BLENDS, PLANT FOOD, VERMICULITE, GROWING MEDIA FOR PLANTS, AND FERTILIZER PEAT (U.S. CLS. 1, 5, 6, 10, 26 AND 46).

FIRST USE 3-26-2001; IN COMMERCE 8-20-2001.

CLASS 31—NATURAL AGRICULTURAL PRODUCTS

FOR MULCH, TOP SOIL, TOP SOIL BLENDS, LIVING PLANTS, PEAT MOSS, FLOWER AND PLANT SEEDS (U.S. CLS. 1 AND 46).

FIRST USE 3-26-2001; IN COMMERCE 8-20-2001.

2,571,980. FELLOWS, TERRI, NEW YORK, NY. SN 75-888,941. PUB. 5-15-2001, FILED 1-7-2000.

T DESIGNS IN HAIR

NO CLAIM IS MADE TO THE EXCLUSIVE RIGHT TO USE "HAIR", APART FROM THE MARK AS SHOWN.

CLASS 35—ADVERTISING AND BUSINESS

FOR RETAIL SERVICES OFFERED THROUGH DEPARTMENT AND SPECIALTY STORES FEATURING HAIR ACCESSORIES (U.S. CLS. 100, 101 AND 102).

FIRST USE 8-6-1999; IN COMMERCE 4-27-2001.

CLASS 42—SCIENTIFIC, COMPUTER AND LEGAL SERVICES

FOR HAIR CARE AND DESIGN SERVICES, NAMELY, HAIR STYLING AND CONSULTATION (U.S. CLS. 100 AND 101).

FIRST USE 8-6-1999; IN COMMERCE 8-1-2001.

2,571,983. 4YOURSOU.COM, LLC, SANTA BARBARA, CA. SN 75-893,964. PUB. 4-24-2001, FILED 1-7-2000.

4YOURSOU.COM**CLASS 9—ELECTRICAL AND SCIENTIFIC APPARATUS**

FOR COMPUTER HARDWARE AND SOFTWARE THAT ENABLE ONLINE CREATION, PRINTING, DISTRIBUTION AND SALE OF GREETING CARDS, INVITATIONS, BUSINESS CARDS AND OTHER STATIONERY PRODUCTS (U.S. CLS. 21, 23, 26, 36 AND 38).

FIRST USE 10-1-1999; IN COMMERCE 9-2-2000.

CLASS 16—PAPER GOODS AND PRINTED MATTER

FOR PAPER AND PAPER ARTICLES NAMELY, GREETING CARDS, PRINTED INVITATIONS, BUSINESS CARDS AND STATIONERY (U.S. CLS. 2, 5, 22, 23, 29, 37, 38 AND 50).

FIRST USE 10-1-1999; IN COMMERCE 9-1-2000.

CLASS 35—ADVERTISING AND BUSINESS

FOR WHOLESALE DISTRIBUTORSHIP SERVICES, WHOLESALE STORE SERVICES, RETAIL STORE SERVICES, ON-LINE RETAIL STORE SERVICES AND ON-LINE ORDERING SERVICES, ALL FEATURING GREETING CARDS, PRINTED INVITATIONS, BUSINESS CARDS AND OTHER STATIONERY PRODUCTS (U.S. CLS. 100, 101 AND 102).

FIRST USE 10-1-1999; IN COMMERCE 9-1-2000.

CLASS 42—SCIENTIFIC, COMPUTER AND LEGAL SERVICES

FOR ON-LINE CUSTOM DESIGN OF GREETING CARDS, PRINTED INVITATIONS, BUSINESS CARDS AND STATIONERY FOR OTHERS; PRINTING OF GREETING CARDS, PRINTED INVITATIONS, BUSINESS CARDS AND STATIONERY FOR OTHERS (U.S. CLS. 100 AND 101).

FIRST USE 10-1-1999; IN COMMERCE 9-1-2000.

2,571,987. JENERIC/PENTRON INCORPORATED, WALLINGFORD, CT. SN 75-898,318. PUB. 4-24-2001, FILED 1-18-2000.

2,571,996. BENDEL, FRANK, 21379 BOLTERSEN, FED REP GERMANY. SN 75-906,421. PUB. 2-20-2001, FILED 1-31-2000.

GALVANOKOR

CLASS 5—PHARMACEUTICALS

FOR ALLOYS OF PRECIOUS METALS FOR DENTAL PURPOSES (U.S. CLS. 6, 18, 44, 46, 51 AND 52).
FIRST USE 3-12-2000; IN COMMERCE 3-12-2000.

CLASS 7—MACHINERY

FOR MACHINE PARTS, NAMELY, ELECTRIC FORMING DEVICES FOR USE WITH A MACHINE, NAMELY, A DENTAL APPARATUS USED TO ELECTRONICALLY DEPOSIT PRECIOUS METALS ONTO A PREFORMED SHAPE TO FORM A METALLIC DENTAL RESTORATION OR UNDERSTRUCTURE (U.S. CLS. 13, 19, 21, 23, 31, 34 AND 35).
FIRST USE 3-12-2000; IN COMMERCE 3-12-2000.

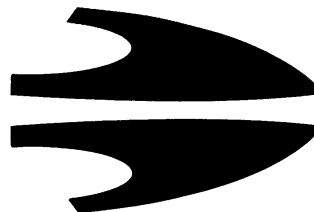

THE STIPPLING SHOWN IN THE DRAWING IS A FEATURE OF THE MARK AND IS NOT INTENDED TO INDICATE COLOR.

CLASS 6—METAL GOODS

FOR METAL ANGLE BRACKETS, METAL SCREWS (U.S. CLS. 2, 12, 13, 14, 23, 25 AND 50).
FIRST USE 1-0-2000; IN COMMERCE 1-0-2000.

CLASS 7—MACHINERY

FOR DRILL CHUCKS FOR POWER DRILLS, POWER DRILL BITS, ELECTRIC HAMMERS; MACHINE TOOLS, NAMELY MANUAL DRILLING MACHINES, POWER TOOLS, NAMELY RASPS, HOISTS; ELECTRIC KNIVES, INDUSTRIAL MACHINE PRESSES, ELECTRIC JACKHAMMERS, PRINTING PRESS ROLLERS, HYDRAULIC JACKS FOR AUTOMOBILES; MACHINE TOOL PARTS, NAMELY TOOL HOLDERS, MACHINE PARTS, NAMELY PRESSURE CYLINDERS; POWER OPERATED SPRAY GUNS, POWER OPERATED TOWER PLIERS, WINCHES, CUTTING MACHINES FOR CUTTING METAL AND WOOD (U.S. CLS. 13, 19, 21, 23, 31, 34 AND 35).
FIRST USE 1-0-2000; IN COMMERCE 1-0-2000.

CLASS 8—HAND TOOLS

FOR HAND OPERATED DRILL INSERTS; HAND TOOL, NAMELY DRILLS, DRILL MOUNTS, HAND OPERATED DRILL RATCHETS, THREAD DRILLS, SCREW TAPS, BORING BITS FOR HAND DRILLS, DRILL RODS, CRANK BRACES FOR DRILLING, SCREW DRILLS, FILES, MILLING CUTTERS, RETAINING CLAMPS, SCREW TAPS, HAMMERS, CHISELS, RIVETING HAMMERS, PIPE CUTTERS, DRILLING HAMMERS, BLOW TORCHES, HAND SAWS, HAND OPERATED SHEARS, BLADES FOR HAND OPERATED SHEARS, SCREW DRIVERS, METAL VICES AND HAND OPERATED JACKS FOR AUTOMOBILES (U.S. CLS. 23, 28 AND 44).
FIRST USE 1-0-2000; IN COMMERCE 1-0-2000.

2,571,989. CHASING ARROWS, INC., ST. LOUIS, MO. SN 75-899,410. PUB. 1-16-2001, FILED 1-19-2000.



NO CLAIM IS MADE TO THE EXCLUSIVE RIGHT TO USE "ORGANICS", APART FROM THE MARK AS SHOWN.

CLASS 1—CHEMICALS

FOR FERTILIZER FOR DOMESTIC AND AGRICULTURAL USE, COMPOST, POTTING SOIL, POTTING SOIL BLENDS, PLANT FOOD, VERMICULITE, GROWING MEDIA FOR PLANTS, AND FERTILIZER PEAT (U.S. CLS. 1, 5, 6, 10, 26 AND 46).
FIRST USE 3-26-2001; IN COMMERCE 8-20-2001.

CLASS 31—NATURAL AGRICULTURAL PRODUCTS

FOR MULCH, TOP SOIL, TOP SOIL BLENDS, LIVING PLANTS, PEAT MOSS, FLOWER AND PLANTS SEEDS (U.S. CLS. 1 AND 46).
FIRST USE 3-26-2001; IN COMMERCE 8-20-2001.

2,572,003. IGATE HOLDING CORPORATION, WILMINGTON, DE, BY MERGER; BY CHANGE OF NAME MASTECH TRADEMARK CORPORATION, WILMINGTON, DE. SN 75-916,744. PUB. 11-28-2000, FILED 2-11-2000.

IGATE CAPITAL

NO CLAIM IS MADE TO THE EXCLUSIVE RIGHT TO USE "CAPITAL", APART FROM THE MARK AS SHOWN.

CLASS 35—ADVERTISING AND BUSINESS

FOR BUSINESS MANAGEMENT RENDERED TO INFORMATION, TECHNOLOGY AND ELECTRONIC COMMERCE RELATED COMPANIES (U.S. CLS. 100, 101 AND 102).

FIRST USE 2-15-2000; IN COMMERCE 3-7-2000.

CLASS 36—INSURANCE AND FINANCIAL

FOR FINANCIAL INVESTMENT IN THE FIELD OF INFORMATION, TECHNOLOGY AND ELECTRONIC COMMERCE RELATED COMPANIES; FINANCIAL INVESTMENT FOR THE ACQUISITION AND CREATION OF INFORMATION, TECHNOLOGY AND ELECTRONIC COMMERCE RELATED COMPANIES (U.S. CLS. 100, 101 AND 102).

FIRST USE 2-15-2000; IN COMMERCE 3-7-2000.

2,572,006. MICROMONITORS, INC., BEND, OR. SN 75-919,350. PUB. 5-1-2001, FILED 2-15-2000.

SERVERON**CLASS 9—ELECTRICAL AND SCIENTIFIC APPARATUS**

FOR INSTRUMENTS USED IN THE POWER GENERATION AND TRANSMISSION INDUSTRY FOR MONITORING, MEASURING, ANALYZING AND REPORTING GASSES, NAMELY GAS CHROMATOGRAPHS AND GAS EXTRACTION FILTERS FOR USE THEREWITH AND COMPUTER SOFTWARE FOR ENABLING THE USE OF SUCH INSTRUMENTS (U.S. CLS. 21, 23, 26, 36 AND 38).

FIRST USE 5-0-2001; IN COMMERCE 5-0-2001.

CLASS 42—SCIENTIFIC, COMPUTER AND LEGAL SERVICES

FOR CONSULTING SERVICES IN THE FIELD OF MONITORING, MEASURING, ANALYZING, AND REPORTING GASSES (U.S. CLS. 100 AND 101).

FIRST USE 5-0-2001; IN COMMERCE 5-0-2001.

2,572,015. SOFTWARE ARCHITECTS, INC., GLEN BURNIE, MD. SN 75-930,834. PUB. 7-17-2001, FILED 3-2-2000.

TIDAL TECHNOLOGIES

NO CLAIM IS MADE TO THE EXCLUSIVE RIGHT TO USE "TECHNOLOGIES", APART FROM THE MARK AS SHOWN.

CLASS 41—EDUCATION AND ENTERTAINMENT

FOR COMPUTER EDUCATION TRAINING SERVICES IN THE INFORMATION TECHNOLOGY FIELD (U.S. CLS. 100, 101 AND 107).

FIRST USE 5-21-2000; IN COMMERCE 5-21-2000.

CLASS 42—SCIENTIFIC, COMPUTER AND LEGAL SERVICES

FOR INFORMATION TECHNOLOGY SERVICES COMPRISING CONSULTING, CUSTOMIZED COMPUTER SOFTWARE DESIGN AND DEVELOPMENT SERVICES, AND COMPUTER NETWORK ADMINISTRATION SERVICES FOR OTHERS (U.S. CLS. 100 AND 101).

FIRST USE 5-21-2000; IN COMMERCE 5-21-2000.

2,572,023. SAUER-DANFOSS INC., AMES, IA, BY CHANGE OF NAME SAUER INC., AMES, IA. SN 75-943,130. PUB. 5-8-2001, FILED 3-14-2000.

WHAT REALLY MATTERS IS INSIDE**CLASS 7—MACHINERY**

FOR HYDRAULIC PUMPS FOR BOATS AND FOR LAND VEHICLES; HYDRAULIC MOTORS FOR BOATS; BENT-AXIS VARIABLE DISPLACEMENT MOTORS FOR BOATS; HYDRAULIC TRANSMISSIONS COMPRISING A HYDRAULIC PUMP AND HYDRAULIC MOTORS; GEAR PUMP FOR USE IN BOATS; FAN DRIVES FOR USE IN LAND VEHICLES (U.S. CLS. 13, 19, 21, 23, 31, 34 AND 35).

FIRST USE 5-31-2000; IN COMMERCE 5-31-2000.

CLASS 9—ELECTRICAL AND SCIENTIFIC APPARATUS

FOR ELECTRICAL AND ELECTRONIC CONTROLS COMPRISING ELECTROHYDRAULIC VALVES, ELECTRICAL ACTUATORS, ELECTRICAL SENSORS, AND PARTS THEREOF, ALL OF THE FOREGOING BEING FOR THE CONTROL OF HYDRAULIC TRANSMISSIONS, HYDRAULIC POWER SUPPLIES FOR STATIONARY USE AND MOTOR VEHICLES AND THEIR WORKING IMPLEMENTS; MICROPROCESSOR BASED CONTROLLERS COMPRISED OF SENSOR/TRANSDUCER AND ELECTRICAL ACTUATOR INPUTS, ELECTROHYDRAULIC VALVE, OPERATOR PANEL DISPLAY, CONTROLLER AREA NETWORK AND RS232 PORT OUTPUTS (U.S. CLS. 21, 23, 26, 36 AND 38).

FIRST USE 5-31-2000; IN COMMERCE 5-31-2000.

CLASS 12—VEHICLES

FOR HYDRAULIC MOTORS FOR LAND VEHICLE ENGINES; BENT-AXIS VARIABLE DISPLACEMENT MOTORS FOR LAND VEHICLE ENGINES; HYDROSTATIC TRANSMISSIONS FOR LAND VEHICLE ENGINES; HYDRAULIC TRANSMISSIONS COMPRISING A HYDRAULIC PUMP AND HYDRAULIC MOTORS, HYDRAULIC AND MECHANICAL CONTROLS THEREFOR FOR USE IN LAND VEHICLES. GEAR DRIVES FOR USE IN LAND VEHICLES; GEAR PUMP FOR USE IN LAND VEHICLES; GEAR BOXES FOR USE WITH HYDRAULIC AND HYDROSTATIC TRANSMISSIONS AND PARTS THEREFOR FOR USE WITH LAND VEHICLES (U.S. CLS. 19, 21, 23, 31, 35 AND 44).

FIRST USE 5-31-2000; IN COMMERCE 5-31-2000.

2,572,030. L. KEE & CO., INC., SOUTH SAN FRANCISCO, CA. SN 75-980,524. PUB. 9-19-2000, FILED 12-23-1999.

SIMPLY HANDMADE

NO CLAIM IS MADE TO THE EXCLUSIVE RIGHT TO USE "HANDMADE", APART FROM THE MARK AS SHOWN.

CLASS 20—FURNITURE AND ARTICLES NOT OTHERWISE CLASSIFIED

FOR HANDMADE PRODUCTS, NAMELY, DECORATIVE PILLOWS, CHAIR PADS (U.S. CLS. 2, 13, 22, 25, 32 AND 50).

FIRST USE 3-1-2000; IN COMMERCE 3-1-2000.

CLASS 24—FABRICS

FOR HANDMADE PRODUCTS, NAMELY, QUILTS, DUVET COVERS, COMFORTERS, BED SPREADS, SHAMS, PILLOW CASES, BED DUST RUFFLES, FABRIC SHOWER CURTAINS, POTHOLDERS/OVEN MITTS, KITCHEN TOWELS, BATH TOWELS, FLAT SHEETS FOR BEDS, TABLE LINEN, NAMELY, FABRIC TABLE TOPPERS, FABRIC TABLECLOTHS, FABRIC TABLE RUNNERS, FABRIC NAPKINS, FABRIC DOILIES, FABRIC PLACE MATS, WINDOW TREATMENTS, NAMELY, FABRIC VALANCES, SWAGS, CURTAIN PANELS, TIE-BACKS AND TIERS, THROW BLANKETS (U.S. CLS. 42 AND 50).

FIRST USE 3-1-2000; IN COMMERCE 3-1-2000.

CLASS 42—SCIENTIFIC, COMPUTER AND LEGAL SERVICES

FOR PROVIDING INFORMATION VIA A GLOBAL COMMUNICATIONS NETWORK CONCERNING SCIENCE AND TECHNOLOGY; MAINTAINING A WEB SITE FOR OTHERS IN THE FIELD OF SCIENCE AND TECHNOLOGY; PROMOTING THE INTERESTS OF SCIENCE MUSEUMS BY PROMOTING PUBLIC AWARENESS AND EDUCATION IN THE FIELDS OF SCIENCE AND TECHNOLOGY (U.S. CLS. 100 AND 101).

FIRST USE 3-15-2000; IN COMMERCE 3-15-2000.

2,572,034. MUNCHKIN, INC., VAN NUYS, CA. SN 75-981,837. PUB. 4-24-2001, FILED 7-31-2000.

SMALL PACKAGES**CLASS 10—MEDICAL APPARATUS**

FOR BABY BOTTLES AND NIPPLES FOR BABY BOTTLES (U.S. CLS. 26, 39 AND 44).

FIRST USE 2-0-2001; IN COMMERCE 2-0-2001.

CLASS 21—HOUSEWARES AND GLASS

FOR CUPS, BOWLS, HAIRBRUSHES, AND COMBS (U.S. CLS. 2, 13, 23, 29, 30, 33, 40 AND 50).

FIRST USE 2-0-2001; IN COMMERCE 2-0-2001.

CLASS 26—FANCY GOODS

FOR HAIR ORNAMENTS (U.S. CLS. 37, 39, 40, 42 AND 50).

FIRST USE 2-0-2001; IN COMMERCE 2-0-2001.

2,572,038. NEW YORK HALL OF SCIENCE, FLUSHING MEADOWS CORONA PARK, NY. SN 75-982,036. PUB. 4-17-2001, FILED 11-30-1999.

TRYSIENCE**CLASS 38—COMMUNICATION**

FOR PROVIDING AN ON-LINE ELECTRONIC INTERACTIVE BULLETIN BOARD FOR TRANSMISSION OF MESSAGES AMONG COMPUTER USERS CONCERNING THE EDUCATIONAL PROGRAMS AND ACTIVITIES OF SCIENCE MUSEUMS AND SCIENCE CENTERS (U.S. CLS. 100, 101 AND 104).

FIRST USE 3-15-2000; IN COMMERCE 3-15-2000.

CLASS 41—EDUCATION AND ENTERTAINMENT

FOR EDUCATION AND ENTERTAINMENT SERVICES, NAMELY PROVIDING A WEB SITE FEATURING EDUCATIONAL GAMES AND ACTIVITIES; PROVIDING A WEB SITE FEATURING INFORMATION REGARDING THE RESOURCES AVAILABLE AT SCIENCE AND TECHNOLOGY MUSEUMS (U.S. CLS. 100, 101 AND 107).

FIRST USE 3-15-2000; IN COMMERCE 3-15-2000.

2,572,042. DEB SBS INC., STANLEY, NC. SN 76-003,819. PUB. 3-20-2001, FILED 3-20-2000.

SKINCARE'S BEST SOLUTION**CLASS 3—COSMETICS AND CLEANING PREPARATIONS**

FOR SKIN CARE PREPARATIONS, NAMELY, SKIN CLEANSERS, LOTION SOAPS, LIQUID SOAPS, GEL SOAPS, HAND CLEANING CREAMS, HAND CLEANING GELS, ANTI-BACTERIAL SOAPS, FOAM SOAPS, ALL-OVER BODY SOAPS, HAND CREAMS, SUNSCREENS AND BARRIER CREAMS IN THE NATURE OF SUN-BLOCKS; HEAVY DUTY HAND CLEANSERS PRIMARILY FOR THE INDUSTRIAL AND AUTOMOTIVE AFTER MARKETS; LIQUID, LOTION, CREAM AND GEL PREPARATIONS FOR USE WITH WASHROOM DISPENSERS, NAMELY, HAND, FACE AND BODY SOAPS AND HAND PROTECTION CREAMS TO PROTECT FROM OIL AND GRIME; DISPOSABLE WIPES IMPREGNATED WITH SKIN CLEANSERS FOR CLEANING THE HANDS (U.S. CLS. 1, 4, 6, 50, 51 AND 52).

FIRST USE 11-0-1999; IN COMMERCE 11-0-1999.

CLASS 5—PHARMACEUTICALS

FOR ALL-PURPOSE DISINFECTANT PREPARATIONS FOR WORKPLACE HYGIENE; BACTERICIDAL PREPARATIONS FOR APPLICATION TO THE SKIN, NAMELY, SKIN SANITIZERS; TOPICAL ALCOHOLIC GEL FOR SKIN HYGIENE PURPOSES; MEDICATED SKIN CLEANSERS FOR USE IN MEDICAL AREAS; SKIN SANITIZERS FOR MEDICAL HYGIENE PURPOSES; MEDICATED SKIN CREAM (U.S. CLS. 6, 18, 44, 46, 51 AND 52).

FIRST USE 11-0-1999; IN COMMERCE 11-0-1999.

CLASS 21—HOUSEWARES AND GLASS

FOR DISPENSERS FOR PRODUCTS IN LIQUID, PASTE, OR GEL FORM, NAMELY, SOAP DISPENSERS, HAND CLEANSER DISPENSERS, AND SKIN CREAM DISPENSERS (U.S. CLS. 2, 13, 23, 29, 30, 33, 40 AND 50).

FIRST USE 11-0-1999; IN COMMERCE 11-0-1999.

2,572,061. PATERNO, JOSEPH, STATE COLLEGE, PA. SN 76-031,496. PUB. 5-15-2001, FILED 4-21-2000.

COACHPATERNO.COM

THE MARK IDENTIFIES A PARTICULAR LIVING INDIVIDUAL WHOSE CONSENT IS OF RECORD.

CLASS 35—ADVERTISING AND BUSINESS

FOR COMPUTER SERVICES, NAMELY PROVIDING SEARCHABLE DATABASES FEATURING DIRECTORIES AND INDICES FOR SPORTS, ATHLETICS AND COACHING INFORMATION, PROVIDING AN ON-LINE SEARCHABLE ORDERING GUIDE AND SERVICE FOR LOCATING, ORGANIZING AND PRESENTING GOODS AND SERVICES OF OTHER ON-LINE VENDORS (U.S. CLS. 100, 101 AND 102).

FIRST USE 7-0-2000; IN COMMERCE 7-0-2000.

CLASS 38—COMMUNICATION

FOR PROVIDING ON-LINE EXCHANGE OF INFORMATION AND CONVERSATION REGARDING A WIDE VARIETY OF TOPICS BY ON-LINE WEB SITE VISITORS WHO HAVE SIMILAR INTERESTS IN THE FIELDS OF COACHING, ATHLETICS AND SPORTS, PROVIDING MULTIPLE USER ACCESS TO A GLOBAL COMMUNICATIONS NETWORK (U.S. CLS. 100, 101 AND 104).

FIRST USE 7-0-2000; IN COMMERCE 7-0-2000.

CLASS 37—CONSTRUCTION AND REPAIR

FOR REAL ESTATE SERVICES; NAMELY, COMMERCIAL DEVELOPMENT OF WIRED PROPERTIES, DATA CENTERS AND RELATED PROPERTIES (U.S. CLS. 100, 103 AND 106).

FIRST USE 5-15-2001; IN COMMERCE 5-15-2001.

CLASS 38—COMMUNICATION

FOR PROVIDING MULTIPLE-USER ACCESS TO AND REGULATED BANDWIDTH FOR A GLOBAL COMPUTER INFORMATION NETWORK; PROVIDING NETWORK CONNECTIONS FOR OBTAINING DATA ON PRIVATE, PUBLIC, SECURE, AND OPEN LOCAL, REGIONAL, AND GLOBAL COMPUTER NETWORKS; AND ELECTRONIC DATA INTERCHANGE SERVICES (U.S. CLS. 100, 101 AND 104).

FIRST USE 5-15-2001; IN COMMERCE 5-15-2001.

CLASS 42—SCIENTIFIC, COMPUTER AND LEGAL SERVICES

FOR HOSTING WEBSITES AND WEBPAGES ON A GLOBAL COMPUTER NETWORK; COMPUTER NETWORK SOFTWARE MAINTENANCE SERVICES (U.S. CLS. 100 AND 101).

FIRST USE 5-15-2001; IN COMMERCE 5-15-2001.

2,572,090. HIPBONE, INC., SAN CARLOS, CA, BY CHANGE OF NAME HIPBONE SOFTWARE, INC., SAN CARLOS, CA. SN 76-067,934. PUB. 4-24-2001, FILED 6-12-2000.

PUTTING PEOPLE BACK TOGETHER

CLASS 9—ELECTRICAL AND SCIENTIFIC APPARATUS

FOR COMPUTER SOFTWARE, NAMELY COMPUTER SOFTWARE FOR NAVIGATING, BROWSING AND FACILITATING VISUAL INTERACTION ON A GLOBAL COMPUTER NETWORK AND FOR FACILITATING AND MANAGING TELEPHONE COMMUNICATIONS DESIGNED TO INTERACT WITH COMMUNICATIONS OVER A GLOBAL COMPUTER NETWORK (U.S. CLS. 21, 23, 26, 36 AND 38).

FIRST USE 9-0-2001; IN COMMERCE 9-0-2001.

2,572,143. NETWORKD ALLIANCE, LLC, LOUISVILLE, KY. SN 76-136,162. PUB. 9-18-2001, FILED 9-27-2000.

ATM MARKETPLACE.COM @ THE CENTER OF THE ATM UNIVERSE

NO CLAIM IS MADE TO THE EXCLUSIVE RIGHT TO USE "ATMMARKETPLACE.COM" AND "ATM", APART FROM THE MARK AS SHOWN.

CLASS 42—SCIENTIFIC, COMPUTER AND LEGAL SERVICES

FOR COMPUTER-RELATED ASP SERVICES IN THE NATURE OF A CO-BROWSING SERVICE THAT FACILITATES REAL-TIME, WEB-BASED INTERACTION AMONG WEB USERS TO ALLOW THEM TO JOINTLY OPERATE AND UPDATE WEB-BASED APPLICATIONS AND TO NAVIGATE ACROSS UNIFORM RESOURCE LOCATORS WHILE SIMULTANEOUSLY COMMUNICATING USING TEXT CHAT, VOICE OVER IP OR TELEPHONE CALL BACK (U.S. CLS. 100 AND 101).

FIRST USE 12-0-2000; IN COMMERCE 12-0-2000.

CLASS 35—ADVERTISING AND BUSINESS

FOR ON-LINE RETAIL STORE SERVICES FOR THE AUTOMATED TELLER MACHINE INDUSTRY FEATURING AUTOMATED TELLER MACHINES; PROMOTING THE GOODS AND SERVICES OF OTHERS IN THE AUTOMATED TELLER MACHINE INDUSTRY BY PROVIDING HYPERTEXT LINKS TO THE WEB SITES OF OTHERS; PROVIDING BUSINESS RESEARCH FOR THE AUTOMATED TELLER MACHINE INDUSTRY VIA AN ON-LINE ELECTRONIC COMMUNICATIONS NETWORK; DISSEMINATION OF ADVERTISING FOR OTHERS IN THE AUTOMATED TELLER MACHINE INDUSTRY VIA AN ON-LINE ELECTRONIC COMMUNICATIONS NETWORK (U.S. CLS. 100, 101 AND 102).

FIRST USE 9-0-2000; IN COMMERCE 9-0-2000.

2,572,097. HILLWOOD DEVELOPMENT CORPORATION, DBA HILLWOOD VENTURES, DALLAS, TX. SN 76-071,798. PUB. 5-1-2001, FILED 6-16-2000.

TERASPACE NETWORKS

NO CLAIM IS MADE TO THE EXCLUSIVE RIGHT TO USE "NETWORKS", APART FROM THE MARK AS SHOWN.

CLASS 38—COMMUNICATION

FOR PROVIDING ON-LINE ELECTRONIC BULLETIN BOARDS FOR TRANSMISSION OF MESSAGES AMONG COMPUTER USERS IN THE AUTOMATED TELLER MACHINE INDUSTRY CONCERNING AUTOMATED TELLER MACHINES (U.S. CLS. 100, 101 AND 104).

FIRST USE 9-0-2000; IN COMMERCE 9-0-2000.

2,572,153. AMERICAN COLLEGE OF NURSE-MIDWIVES INC., WASHINGTON, DC. SN 76-160,275. PUB. 8-28-2001, FILED 11-3-2000.

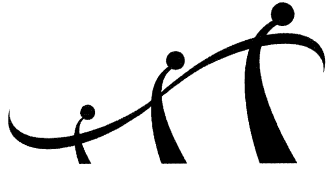

CLASS 41—EDUCATION AND ENTERTAINMENT

FOR EDUCATIONAL SERVICES, NAMELY, PROVIDING EDUCATIONAL MATERIALS, CONDUCTING COURSES, CONFERENCES, PRESENTATIONS, AND TESTING FOR NURSE-MIDWIVES IN THE FIELD OF NURSE MIDWIFERY AS PART OF AN ACCREDITATION PROGRAM FOR MIDWIFERY SCHOOLS (U.S. CLS. 100, 101 AND 107).

FIRST USE 12-1-2000; IN COMMERCE 12-1-2000.

CLASS 42—SCIENTIFIC, COMPUTER AND LEGAL SERVICES

FOR ASSOCIATION SERVICES, NAMELY, PROMOTING THE INTERESTS OF NURSE MIDWIVES (U.S. CLS. 100 AND 101).

FIRST USE 12-1-2000; IN COMMERCE 12-1-2000.

2,572,157. BREAD FOR THE CITY, INC., WASHINGTON, DC. SN 76-174,599. PUB. 8-28-2001, FILED 12-4-2000.



THE MARK IS COMPRISED IN PART OF A DESIGN OF PEOPLE ENCLOSED BY ENCIRCLING ARMS.

CLASS 36—INSURANCE AND FINANCIAL

FOR CHARITABLE FUNDRAISING SERVICES (U.S. CLS. 100, 101 AND 102).

FIRST USE 10-1-2000; IN COMMERCE 10-1-2000.

CLASS 42—SCIENTIFIC, COMPUTER AND LEGAL SERVICES

FOR CHARITABLE SERVICES, NAMELY, PROVIDING FOOD, CLOTHING, MEDICAL, LEGAL AND SOCIAL SERVICES (U.S. CLS. 100 AND 101).

FIRST USE 10-1-2000; IN COMMERCE 10-1-2000.

2,572,169. T. BAIRD MCILVAIN COMPANY, KING OF PRUSSIA, PA. SN 76-187,087. PUB. 7-31-2001, FILED 12-27-2000.

TBM HARDWOODS, INC.

NO CLAIM IS MADE TO THE EXCLUSIVE RIGHT TO USE "HARDWOODS, INC.", APART FROM THE MARK AS SHOWN.

CLASS 19—NON-METALLIC BUILDING MATERIALS

FOR LUMBER AND MILLWORK EXCLUSIVE OF CABINETS (U.S. CLS. 1, 12, 33 AND 50).

FIRST USE 2-5-2001; IN COMMERCE 2-5-2001.

CLASS 35—ADVERTISING AND BUSINESS

FOR WHOLESALE DISTRIBUTORSHIPS FEATURING LUMBER AND MILLWORK (U.S. CLS. 100, 101 AND 102).

FIRST USE 2-5-2001; IN COMMERCE 2-5-2001.

2,572,192. WORKFORCE SOLUTIONS, INC., SALT LAKE CITY, UT. SN 78-004,164. PUB. 4-17-2001, FILED 4-14-2000.

ADVANTIUS

CLASS 35—ADVERTISING AND BUSINESS

FOR HUMAN RESOURCES SERVICES FOR THIRD PARTY EMPLOYERS, NAMELY, HUMAN RESOURCES ADMINISTRATION, PAYROLL PROCESSING SERVICES; AND BUSINESS CONSULTATION IN THE FIELD OF HUMAN RESOURCES (U.S. CLS. 100, 101 AND 102).

FIRST USE 9-0-2000; IN COMMERCE 9-0-2000.

CLASS 36—INSURANCE AND FINANCIAL

FOR DEVELOPMENT AND ADMINISTRATION OF EMPLOYEE BENEFIT PLANS AND PROGRAMS FOR THIRD PARTY EMPLOYERS, AND BUSINESS CONSULTATION IN THE FIELD OF EMPLOYEE BENEFIT PLANS (U.S. CLS. 100, 101 AND 102).

FIRST USE 9-0-2000; IN COMMERCE 9-0-2000.

CLASS 41—EDUCATION AND ENTERTAINMENT

FOR EDUCATIONAL SERVICES, NAMELY, CONDUCTING PROFESSIONAL SEMINARS AND TRAINING COURSES FOR MANAGERS AND EMPLOYEES IN THE FIELD OF EMPLOYMENT LAW, HUMAN RESOURCES AND EMPLOYEE BENEFITS, AND DISTRIBUTION OF COURSE MATERIALS IN CONNECTION THEREWITH (U.S. CLS. 100, 101 AND 107).

FIRST USE 9-0-2000; IN COMMERCE 9-0-2000.

2,572,194. BENNETT, LEIGH, VAN NUYS, CA. SN 78-007,655.
PUB. 3-13-2001, FILED 5-11-2000.

2,572,203. CLEAN AMERICA, INC., BREA, CA. SN 78-
024,768. PUB. 9-4-2001, FILED 9-7-2000.

VEGASWIRE

CLASS 41—EDUCATION AND ENTERTAINMENT

FOR PROVIDING A WEBSITE ON A GLOBAL COMPUTER NETWORK FEATURING SPORTS AND SPORTS STATISTICS (U.S. CLS. 100, 101 AND 107).

FIRST USE 9-1-2000; IN COMMERCE 9-1-2000.

CLASS 42—SCIENTIFIC, COMPUTER AND LEGAL SERVICES

FOR PROVIDING A WEBSITE ON A GLOBAL COMPUTER NETWORK FEATURING NEWS STATISTICS (U.S. CLS. 100 AND 101).

FIRST USE 9-1-2000; IN COMMERCE 9-1-2000.



CLASS 7—MACHINERY

FOR WIRE, AND GRAPHITE BLANKS, USED AS CONSUMABLE METAL CUTTING PARTS FOR AN ELECTRON DISCHARGE METAL CUTTING MACHINE; MACHINE TOOLS AND TOOLING, NAMELY, DRILL BITS, ROLLERS, AND BEARINGS, TO BE USED WITH AN ELECTRON DISCHARGE METAL CUTTING MACHINE (U.S. CLS. 13, 19, 21, 23, 31, 34 AND 35).

FIRST USE 10-31-2000; IN COMMERCE 10-31-2000.

CLASS 9—ELECTRICAL AND SCIENTIFIC APPARATUS

FOR WIRE USED IN ELECTRON DISCHARGE CUTTING MACHINES (U.S. CLS. 21, 23, 26, 36 AND 38).

FIRST USE 10-16-2000; IN COMMERCE 10-16-2000.

CLASS 17—RUBBER GOODS

FOR RESERVOIR FOR WATER USED IN ELECTRON WIRE CUTTING (U.S. CLS. 1, 5, 12, 13, 35 AND 50).

FIRST USE 10-31-2000; IN COMMERCE 10-31-2000.

2,572,201. MESS ENTERPRISES, SAN FRANCISCO, CA. SN
78-023,371. PUB. 9-4-2001, FILED 8-29-2000.

MESS.com

2,572,204. CRABTREE & EVELYN, LTD., WOODSTOCK, CT.
SN 78-026,971. PUB. 8-7-2001, FILED 9-21-2000.

CAYMAN WINDS

CLASS 41—EDUCATION AND ENTERTAINMENT

FOR PROVIDING INFORMATION IN THE FIELD OF ENTERTAINMENT SERVICES, NAMELY, ART AND MUSIC VIA A GLOBAL COMPUTER NETWORK (U.S. CLS. 100, 101 AND 107).

FIRST USE 12-10-1996; IN COMMERCE 12-10-1999.

CLASS 42—SCIENTIFIC, COMPUTER AND LEGAL SERVICES

FOR COMPUTER SERVICES, NAMELY, DESIGNING, CREATING AND IMPLEMENTING NETWORK WEB PAGES AND WEB SITES FOR OTHERS (U.S. CLS. 100 AND 101).

FIRST USE 12-10-1996; IN COMMERCE 12-10-1999.

CLASS 3—COSMETICS AND CLEANING PREPARATIONS

FOR EAU DE TOILETTE, SKIN CLEANSING LOTION, SKIN MOISTURIZING LOTION, BATH OIL, BATH SALTS, SKIN SOAP, POTPOURRI, SCENTED ESSENTIAL OILS FOR ADDING FRAGRANCE TO ROOMS AND FOR APPLICATION TO POTPOURRI, TO TEXTILE FABRICS AND TO OTHER HOUSEHOLD SURFACES (U.S. CLS. 1, 4, 6, 50, 51 AND 52).

FIRST USE 3-26-2001; IN COMMERCE 3-26-2001.

CLASS 4—LUBRICANTS AND FUELS

FOR SCENTED CANDLES (U.S. CLS. 1, 6 AND 15).

FIRST USE 3-26-2001; IN COMMERCE 3-26-2001.

CLASS 16—PAPER GOODS AND PRINTED MATTER

FOR SCENTED PAPER DRAWER LINERS (U.S. CLS. 2, 5, 22, 23, 29, 37, 38 AND 50).

FIRST USE 11-1-2001; IN COMMERCE 11-1-2001.

MAY 21, 2002

U.S. PATENT AND TRADEMARK OFFICE

TM 629

2,572,226. KAVAZEN INC., BERKELEY, CA. SN 78-059,132.
PUB. 10-9-2001, FILED 4-18-2001.

RELAXING EXPERIENCES

CLASS 5—PHARMACEUTICALS

FOR NUTRITIONAL SUPPLEMENTS (U.S. CLS. 6, 18,
44, 46, 51 AND 52).
FIRST USE 7-10-2001; IN COMMERCE 7-10-2001.

CLASS 32—LIGHT BEVERAGES

FOR MINERAL WATERS AND AERATED WATERS
AND OTHER NON-ALCOHOLIC BEVERAGES,
NAMELY, FLAVORED WATERS AND FRUIT DRINKS;
CONCENTRATES, SYRUPS OR POWDERS USED IN
THE PREPARATION OF NON-ALCOHOLIC BEV-
ERAGES (U.S. CLS. 45, 46 AND 48).
FIRST USE 7-10-2001; IN COMMERCE 7-10-2001.

* * * * *

SECTION 2.— INTERNATIONAL CLASSIFICATION

The short titles associated below with the international class numbers are terms designed merely for quick identification and are not an official part of the international classification. The full names of international classes are given in section 6.1 of the trademark rules of practice.

The designation "U.S. Cl." appearing in this section refers to the U.S. class in effect prior to Sep. 1, 1973 rather than the international class which applies to applications filed on or after that date. For adoption of international classification see notice in the OFFICIAL GAZETTE of Jun. 26, 1973 (911 O.G. TM 210).

Application in one class

CLASS 1—CHEMICALS

2,571,815. AOC, LLC, COLLIERVILLE, TN. SN 75-649,565.
PUB. 1-30-2001, FILED 3-1-1999.

PULTRU

FOR UNPROCESSED MEDIUM TO HIGH REACTIVITY ARTIFICIAL POLYESTER RESINS FOR USE IN THE MANUFACTURE OF PLASTICS UTILIZING HIGH SPEED CONTINUOUS MOLDING AND SPECIFIED CROSS SECTIONAL PROFILING (U.S. CLS. 1, 5, 6, 10, 26 AND 46).
FIRST USE 10-28-1998; IN COMMERCE 10-28-1998.

2,571,893. H.B. FULLER LICENSING & FINANCING, INC., SAINT PAUL, MN. SN 75-768,436. PUB. 3-28-2000, FILED 8-5-1999.

FULLBACK

OWNER OF U.S. REG. NO. 964,939.
FOR LOW APPLICATION TEMPERATURE HOTMELT ADHESIVE THAT IS USED FOR BACK LINING HARD COVER BOOKS (U.S. CLS. 1, 5, 6, 10, 26 AND 46).
FIRST USE 5-1-2001; IN COMMERCE 5-1-2001.

2,572,052. IMERYS PIGMENTS, INC., ROSWELL, GA. SN 76-017,795. PUB. 1-30-2001, FILED 4-5-2000.

ASTRA-COTE

FOR KAOLIN CLAY FOR USE IN THE FILLING AND COATING OF PAPER AND PAPERBOARD PRODUCTS (U.S. CLS. 1, 5, 6, 10, 26 AND 46).
FIRST USE 10-2-2000; IN COMMERCE 10-2-2000.

CLASS 1—(Continued).

2,572,150. STRATAGENE, LA JOLLA, CA. SN 76-150,525.
PUB. 8-7-2001, FILED 10-18-2000.

GENEMORPH

FOR MUTAGENESIS KITS CONSISTING PRIMARILY OF LABORATORY REAGENT FOR SCIENTIFIC AND RESEARCH USE; LABORATORY REAGENTS FOR SCIENTIFIC AND RESEARCH USE (U.S. CLS. 1, 5, 6, 10, 26 AND 46).
FIRST USE 10-0-2000; IN COMMERCE 10-0-2000.

CLASS 2—PAINTS

2,571,848. PPG INDUSTRIES OHIO, INC., CLEVELAND, OH. SN 75-701,863. PUB. 2-6-2001, FILED 5-10-1999.

ICRON

FOR FULL LINE OF PAINTS SOLD TO ORIGINAL EQUIPMENT MANUFACTURERS FOR FACTORY APPLICATION ON A WIDE VARIETY OF METAL OR PLASTIC GOODS (U.S. CLS. 6, 11 AND 16).
FIRST USE 2-2-2000; IN COMMERCE 2-2-2000.

2,571,878. ENGELHARD CORPORATION, ISELIN, NJ. SN 75-747,784. PUB. 9-26-2000, FILED 6-29-1999.

DIGITEX

FOR KAOLIN CLAY-BASED PIGMENTS FOR USE IN COATING AND FILLING PAPER AND PAPER-BOARD PRODUCTS, AND FOR USE AS A FILLER IN THE MANUFACTURE OF RUBBER AND PLASTIC ARTICLES IN THE RUBBER AND PLASTICS MANUFACTURING INDUSTRIES (U.S. CLS. 6, 11 AND 16).
FIRST USE 12-4-1998; IN COMMERCE 12-4-1998.

CLASS 2—(Continued).

2,571,888. CERTAINTED CORPORATION, VALLEY FORGE, PA. SN 75-765,154. PUB. 2-6-2001, FILED 8-24-1999.

FIBERTECT

FOR ACRYLIC LATEX SEALANT AND COATING AGENT USED AS A PAINT PRIMER IN THE PROTECTION AND COLORING OF FIBER CEMENT SIDING PRODUCTS, IN RESIDENTIAL AND COMMERCIAL CONSTRUCTION, EXCLUDING USE IN SWIMMING POOLS (U.S. CLS. 6, 11 AND 16).

FIRST USE 5-1-2000; IN COMMERCE 5-1-2000.

CLASS 3—(Continued).

2,571,744. W STERNOFF LLC, BELLEVUE, WA. SN 75-467,737. PUB. 7-24-2001, FILED 4-14-1998.

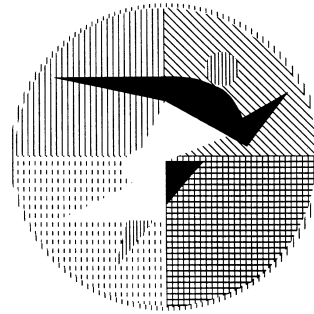
**CLASS 3—COSMETICS AND CLEANING PREPARATIONS**

2,571,725. GTFM, INC., NEW YORK, NY. SN 75-418,054. PUB. 10-6-1998, FILED 1-14-1998.

FUBU

OWNER OF U.S. REG. NOS. 1,910,169, 2,069,058, AND OTHERS.

FOR TOILET SOAP, BATH SALTS, BUBBLE BATH, PERFUME, TOILET WATER, COLOGNE, LIPSTICKS, NAIL POLISHES, MAKE-UP CREAMS, CLEANSING MILK, BODY AND FACE POWDERS, SKIN CLEANSING LOTIONS AND CREAMS, EYE-LINER, AFTER SHAVE LOTION, SHAVING SOAP, DEODORANTS, HAIR LOTIONS, AND TALCUM POWDER (U.S. CLS. 1, 4, 6, 50, 51 AND 52).

FIRST USE 11-0-1999; IN COMMERCE 11-0-1999.

THE DRAWING IS LINED FOR THE COLORS RED, GREEN, PURPLE, AND GOLD.

THE MARK CONSISTS OF A STYLIZED RUNNING FIGURE WITH A RED HEAD, BLACK ARMS AND SHOULDERS, WHITE TORSO, WHITE RIGHT LEG, BLACK LEFT KNEE, AND RED LEFT FOOT, WITHIN A RED-RIMMED CIRCLE DIVIDED INTO FOUR QUADRANTS; THE UPPER LEFT QUADRANT IS RED, THE UPPER RIGHT QUADRANT IS GREEN, THE LOWER LEFT QUADRANT IS PURPLE, AND THE LOWER RIGHT QUADRANT IS GOLD.

FOR COSMETICS, NAMELY, NON-MEDICATED SKIN BALM (U.S. CLS. 1, 4, 6, 50, 51 AND 52).

FIRST USE 6-30-1998; IN COMMERCE 6-30-1998.

2,571,770. LORIS AZZARO B.V., 7336 AZ APELDOORN, NETHERLANDS. SN 75-557,244. PUB. 4-25-2000, FILED 9-23-1998.

AZZURA AZZARO

2,571,728. HOY, GENE, MIO, MI. SN 75-426,427. PUB. 11-10-1998, FILED 1-30-1998.

VITA-GLO

FOR SKIN CREAM (U.S. CLS. 1, 4, 6, 50, 51 AND 52). FIRST USE 10-1-2001; IN COMMERCE 10-1-2001.

THE NAME IN THE MARK DOES NOT IDENTIFY A LIVING INDIVIDUAL.

FOR PERFUME, TOILET WATER, PERFUME WATER, EAU DE COLOGNE, PERFUME EXTRACTS, ESSENTIAL OILS FOR PERSONAL USE, COSMETIC PRODUCTS FOR THE FACE AND BODY, NAMELY, SKIN LOTIONS FOR COSMETIC USE, SKIN CREAM, EYE CREAM, HAND CREAM, NIGHT CREAM, BODY LOTION, FACIAL MAKE-UP AND EYE MAKE-UP; COSMETIC BODY POWDERS, PERFUMED TALCUM POWDER, COSMETIC PREPARATIONS FOR THE BATH, NAMELY, BUBBLE BATH, BATH ESSENCES, AND BATH FOAMS; BATH SALTS, SOAPS, NAMELY, HAND SOAPS, BATH SOAPS, TOILET SOAPS, SKIN SOAPS, SHAVING SOAPS; DEODORANTS FOR PERSONAL USE (U.S. CLS. 1, 4, 6, 50, 51 AND 52).

FIRST USE 5-29-2000; IN COMMERCE 9-15-2000.

CLASS 3—(Continued).

2,571,845. COSMAIR CREATIVE, INC., NEW YORK, NY. SN 75-701,175. PUB. 1-25-2000, FILED 5-6-1999.

DOUBLE BLONDE

NO CLAIM IS MADE TO THE EXCLUSIVE RIGHT TO USE "BLONDES", APART FROM THE MARK AS SHOWN. FOR HAIR CARE PRODUCTS, NAMELY, HAIR COLOR (U.S. CLS. 1, 4, 6, 50, 51 AND 52).
FIRST USE 5-0-2001; IN COMMERCE 5-0-2001.

2,571,963. L'OREAL USA, INC., NEW YORK, NY, BY ASSIGNMENT AMETHYST INVESTMENT GROUP, INC., CHICAGO, IL. SN 75-873,606. PUB. 10-10-2000, FILED 12-16-1999.

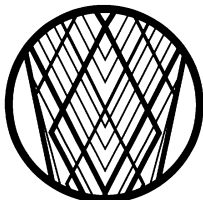

THE LINING SHOWN IS A FEATURE OF THE MARK AND DOES NOT INDICATE COLOR.
FOR HAIR CARE PREPARATIONS (U.S. CLS. 1, 4, 6, 50, 51 AND 52).
FIRST USE 4-26-2000; IN COMMERCE 4-26-2000.

2,571,997. PHYSICIAN'S CHOICE OF ARIZONA, INC., SCOTTSDALE, AZ. SN 75-908,588. PUB. 6-5-2001, FILED 2-2-2000.

SENSI PEEL

NO CLAIM IS MADE TO THE EXCLUSIVE RIGHT TO USE "PEEL", APART FROM THE MARK AS SHOWN. FOR NON-MEDICATED SKIN CARE PRODUCTS, NAMELY, PEELING SOLUTIONS, EXFOLIATING SOLUTIONS, LIGHTENING SOLUTIONS, AND CREAMS AND LOTIONS FOR WRINKLES AND SKIN TEXTURE (U.S. CLS. 1, 4, 6, 50, 51 AND 52).
FIRST USE 3-31-2000; IN COMMERCE 3-31-2000.

2,572,082. L'OREAL USA CREATIVE, INC., NEW YORK, NY. SN 76-057,096. PUB. 10-23-2001, FILED 5-23-2000.

OUTSHINE

FOR HAIR STYLING PREPARATIONS (U.S. CLS. 1, 4, 6, 50, 51 AND 52).
FIRST USE 5-0-2001; IN COMMERCE 5-0-2001.

CLASS 3—(Continued).

2,572,149. NOODE', LLC, NEW YORK, NY, BY CHANGE OF NAME 972 DEAD SEA SPA, L.L.C., GREAT NECK, NY. SN 76-148,663. PUB. 7-17-2001, FILED 10-17-2000.



NO CLAIM IS MADE TO THE EXCLUSIVE RIGHT TO USE "SKINCARE", APART FROM THE MARK AS SHOWN. FOR COSMETICS AND SKIN CARE PRODUCTS - FACE WASHES, FACIAL SCRUBS, NON-MEDICATED SKIN CARE PREPARATIONS, FACIAL MOISTURIZERS, FACE AND BODY SOLUTIONS, FACE PEELS, BODY MOISTURIZERS, MASSAGE OILS, BODY WASHES, BODY SCRUBS AND HAIR CONDITIONERS (U.S. CLS. 1, 4, 6, 50, 51 AND 52).
FIRST USE 1-0-2001; IN COMMERCE 1-0-2001.

2,572,179. RUHOF CORPORATION, THE, MINEOLA, NY. SN 76-203,983. PUB. 8-14-2001, FILED 2-2-2001.

WE CLEAN THE FECES AND SAVE THE SPECIES

FOR CLEANING SOLUTIONS FOR SURGICAL INSTRUMENTS (U.S. CLS. 1, 4, 6, 50, 51 AND 52).
FIRST USE 3-10-2001; IN COMMERCE 3-10-2001.

CLASS 4—LUBRICANTS AND FUELS

2,571,850. EXXON MOBIL CORPORATION, IRVING, TX. SN 75-706,629. PUB. 10-24-2000, FILED 5-17-1999.

EXXTRANS

FOR TRANSMISSION AND POWER DRIVE LUBRICANTS FOR USE IN HEAVY-DUTY EQUIPMENT (U.S. CLS. 1, 6 AND 15).
FIRST USE 2-7-2000; IN COMMERCE 2-7-2000.

CLASS 5—PHARMACEUTICALS

2,571,757. VIVALAC INC., BROOKEVILLE, MD. SN 75-507,791. PUB. 1-11-2000, FILED 6-24-1998.

VIVALAC

FOR MILK-DERIVED PREPARATIONS FOR USE AS A DIETARY SUPPLEMENT AND MILK-DERIVED TOPICAL GEL FOR MEDICAL AND THERAPEUTIC USE (U.S. CLS. 6, 18, 44, 46, 51 AND 52).
FIRST USE 3-29-2001; IN COMMERCE 3-29-2001.

CLASS 5—(Continued).

2,571,766. JOHNSON & JOHNSON, NEW BRUNSWICK, NJ.
SN 75-541,702. PUB. 4-25-2000, FILED 8-24-1998.

OPTISOY

FOR SOY SOLD AS AN INTREGAL COMPONENT OF
VITAMINS AND OTHER NUTRITIONAL SUPPLE-
MENTS FOR HUMAN CONSUMPTION (U.S. CLS. 6, 18,
44, 46, 51 AND 52).

FIRST USE 5-21-1999; IN COMMERCE 5-21-1999.

2,571,797. N.V.E., INC., NEWTON, NJ. SN 75-615,005. PUB. 11-
2-1999, FILED 12-31-1998.

YELLOW JACKET

FOR NUTRITIONAL AND DIETARY SUPPLEMENTS
(U.S. CLS. 6, 18, 44, 46, 51 AND 52).

FIRST USE 8-1-1998; IN COMMERCE 8-1-1998.

2,571,801. EXTREME NUTRITIONALS, LLC, MOORES-
VILLE, NC. SN 75-621,452. PUB. 4-10-2001, FILED 1-19-1999.



FOR NUTRITIONAL SUPPLEMENTS (U.S. CLS. 6, 18,
44, 46, 51 AND 52).

FIRST USE 3-0-1999; IN COMMERCE 3-0-1999.

2,571,802. C.B. FLEET INVESTMENT CORPORATION, WIL-
MINGTON, DE. SN 75-623,403. PUB. 11-16-1999, FILED 1-
20-1999.

FOSFOSODA

FOR SOLUTIONS USED AS A LAXATIVE AND
PURGATIVE AND FOR THE TREATMENT OF CON-
STIPATION AND GASTROINTESTINAL DISTUR-
BANCES (U.S. CLS. 6, 18, 44, 46, 51 AND 52).

FIRST USE 1-0-1997; IN COMMERCE 1-0-1997.

CLASS 5—(Continued).

2,571,847. E'OLA INTERNATIONAL, ST. GEORGE, UT. SN
75-701,816. PUB. 6-12-2001, FILED 5-10-1999.

NUTRASCI

FOR DIETARY SUPPLEMENTS (U.S. CLS. 6, 18, 44, 46,
51 AND 52).

FIRST USE 6-16-1999; IN COMMERCE 6-16-1999.

2,571,884. MAHARISHI AYUR-VED PRODUCTS INTERNA-
TIONAL, INC, COLORADO SPRINGS, CO. SN 75-759,584.
PUB. 2-1-2000, FILED 7-26-1999.

ALLER SKIN

OWNER OF U.S. REG. NO. 2,103,476.
NO CLAIM IS MADE TO THE EXCLUSIVE RIGHT TO
USE "SKIN", APART FROM THE MARK AS SHOWN.

FOR HERBAL DIETARY SUPPLEMENT (U.S. CLS. 6,
18, 44, 46, 51 AND 52).

FIRST USE 8-1-2000; IN COMMERCE 8-1-2000.

2,571,913. BIOTEST LABORATORIES, LLC, COLORADO
SPRINGS, CO. SN 75-805,854. PUB. 1-16-2001, FILED 9-22-
1999.

METABOLIC DRIVE

NO CLAIM IS MADE TO THE EXCLUSIVE RIGHT TO
USE "METABOLIC", APART FROM THE MARK AS
SHOWN.

FOR NUTRITIONAL SUPPLEMENTS (U.S. CLS. 6, 18,
44, 46, 51 AND 52).

FIRST USE 9-24-1999; IN COMMERCE 9-24-1999.

2,571,954. LIPHA, 69008 LYON, FRANCE. SN 75-864,717. PUB.
12-26-2000, FILED 12-6-1999.

GLUCOPHAGE XR

OWNER OF U.S. REG. NO. 1,652,866.
NO CLAIM IS MADE TO THE EXCLUSIVE RIGHT TO
USE XR, APART FROM THE MARK AS SHOWN.

FOR PHARMACEUTICAL PREPARATIONS FOR THE
PREVENTION AND TREATMENT OF DIABETES AND
COMPLICATIONS THEREOF (U.S. CLS. 6, 18, 44, 46, 51
AND 52).

FIRST USE 11-0-2000; IN COMMERCE 11-0-2000.

CLASS 5—(Continued).

2,571,957. HTZ INVESTMENT CORP., WILMINGTON, DE. SN 75-867,628. PUB. 10-17-2000, FILED 12-9-1999.

HARTZ ADVANCED CARE BRAND

NO CLAIM IS MADE TO THE EXCLUSIVE RIGHT TO USE "BRAND", APART FROM THE MARK AS SHOWN.

FOR FLEA AND TICK ERADICATION PRODUCT IN CAPSULE FORM TO BE INGESTED BY DOGS (U.S. CLS. 6, 18, 44, 46, 51 AND 52).

FIRST USE 2-1-2001; IN COMMERCE 2-1-2001.

2,572,014. ANALYTICAL RESEARCH LABORATORIES, EDMOND, OK. SN 75-930,615. PUB. 1-16-2001, FILED 2-28-2000.

COMBONEB

FOR PHARMACEUTICALS, NAMELY MEDICATION FOR TREATING CHRONIC OBSTRUCTIVE PULMONARY DISEASE (U.S. CLS. 6, 18, 44, 46, 51 AND 52).

FIRST USE 3-0-2000; IN COMMERCE 3-0-2000.

2,572,024. HTZ INVESTMENT CORP., WILMINGTON, DE. SN 75-943,785. PUB. 8-28-2001, FILED 3-14-2000.

HARTZ ADVANCED CARE BRAND

OWNER OF U.S. REG. NOS. 843,089, 2,347,431, AND OTHERS.

NO CLAIM IS MADE TO THE EXCLUSIVE RIGHT TO USE "BRAND", APART FROM THE MARK AS SHOWN.

FOR FLEA AND TICK ERADICATION PRODUCT IN CAPSULE FORM TO BE INGESTED BY DOGS; FLEA AND TICK TOPICAL ERADICATION PRODUCT; FLEA AND TICK DROPS FOR CATS; FLEA AND TICK DROPS FOR DOGS; VITAMINS FOR CATS AND DOGS; WORMERS FOR CATS AND DOGS (U.S. CLS. 6, 18, 44, 46, 51 AND 52).

FIRST USE 2-1-2001; IN COMMERCE 2-1-2001.

2,572,025. HTZ INVESTMENT CORP., WILMINGTON, DE. SN 75-943,786. PUB. 10-9-2001, FILED 3-14-2000.

HARTZ ADVANCED CARE

OWNER OF U.S. REG. NOS. 843,089, 2,347,431, AND OTHERS.

FOR FLEA AND TICK ERADICATION PRODUCT IN CAPSULE FORM TO BE INGESTED BY DOGS; FLEA AND TICK TOPICAL ERADICATION PRODUCT; FLEA AND TICK DROPS FOR CATS; FLEA AND TICK DROPS FOR DOGS; VITAMINS FOR CATS AND DOGS; WORMERS FOR CATS AND DOGS (U.S. CLS. 6, 18, 44, 46, 51 AND 52).

FIRST USE 2-1-2001; IN COMMERCE 2-1-2001.

CLASS 5—(Continued).

2,572,039. DENTSPLY INTERNATIONAL INC., YORK, PA. SN 76-001,539. PUB. 10-31-2000, FILED 3-16-2000.

PUMICIDE

FOR DENTAL POLISHING ABRASIVE FOR USE BY DENTAL PROFESSIONALS (U.S. CLS. 6, 18, 44, 46, 51 AND 52).

FIRST USE 10-18-2000; IN COMMERCE 10-18-2000.

2,572,074. NBTY, INC., BOHEMIA, NY. SN 76-044,617. PUB. 4-10-2001, FILED 5-10-2000.

NUTRA-GAR

FOR NUTRITIONAL SUPPLEMENTS (U.S. CLS. 6, 18, 44, 46, 51 AND 52).

FIRST USE 5-1-2000; IN COMMERCE 5-1-2000.

2,572,075. NBTY, INC., BOHEMIA, NY. SN 76-044,618. PUB. 3-27-2001, FILED 5-10-2000.



THE MARK CONSISTS OF A CLOVE OF GARLIC, THE WORDS "NURTA GAR" AGAINST A DARK RECTANGULAR BACKGROUND, AND TWO ROWS OF DARK CIRCLES THAT APPEAR BELOW THE RECTANGLE.

FOR NUTRITIONAL SUPPLEMENTS (U.S. CLS. 6, 18, 44, 46, 51 AND 52).

FIRST USE 5-1-2000; IN COMMERCE 5-1-2000.

2,572,079. EASY WAY INTERNATIONAL, INC., INDIANAPOLIS, IN. SN 76-052,869. PUB. 4-10-2001, FILED 5-22-2000.

ULTIMATE DESIRE

FOR NUTRITIONAL SUPPLEMENTS, NAMELY APHRODISIAC CAPSULES (U.S. CLS. 6, 18, 44, 46, 51 AND 52).

FIRST USE 6-0-2000; IN COMMERCE 6-0-2000.

CLASS 5—(Continued).

2,572,106. MCLAUGHLIN GORMLEY KING COMPANY, MINNEAPOLIS, MN. SN 76-081,017. PUB. 4-3-2001, FILED 6-29-2000.

PYGANIC

FOR INSECTICIDES FOR AGRICULTURAL, INDUSTRIAL, INSTITUTIONAL, COMMERCIAL, RESIDENTIAL, HOUSEHOLD, AND VETERINARY USE (U.S. CLS. 6, 18, 44, 46, 51 AND 52).

FIRST USE 3-1-2001; IN COMMERCE 3-1-2001.

2,572,167. BETAEXPRESS, INC., ENDICOTT, NY. SN 76-185,728. PUB. 8-21-2001, FILED 12-26-2000.

BETA EXPRESS

FOR DIETARY SUPPLEMENTS AND FOOD SUPPLEMENTS FOR THE IMMUNE SYSTEM (U.S. CLS. 6, 18, 44, 46, 51 AND 52).

FIRST USE 5-0-1998; IN COMMERCE 6-0-1999.

2,572,195. MIN, PETER DAEKIE, LAKE FOREST, CA. SN 78-011,080. PUB. 6-26-2001, FILED 6-2-2000.

W - INSTINCT

FOR DIETARY SUPPLEMENT FOR WOMEN (U.S. CLS. 6, 18, 44, 46, 51 AND 52).

FIRST USE 3-19-2000; IN COMMERCE 3-19-2000.

2,572,212. BAYER CORPORATION, PITTSBURGH, PA. SN 78-037,322. PUB. 7-31-2001, FILED 12-1-2000.

TAKE IT FOR PAIN. TAKE IT FOR LIFE.

FOR ANALGESICS (U.S. CLS. 6, 18, 44, 46, 51 AND 52).

FIRST USE 6-1-2001; IN COMMERCE 6-1-2001.

2,572,231. AGRO DISTRIBUTION, LLC, ARDEN HILLS, MN. SN 78-060,271. PUB. 9-18-2001, FILED 4-25-2001.

BRASH

FOR HERBICIDES TO LIMIT REGROWTH FOR AGRICULTURAL AND DOMESTIC USE (U.S. CLS. 6, 18, 44, 46, 51 AND 52).

FIRST USE 2-1-1999; IN COMMERCE 2-1-1999.

CLASS 5—(Continued).

2,572,232. LONGEVITY CENTER OF U.S.A., INC, MIAMI, FL. SN 78-063,022. PUB. 10-2-2001, FILED 5-10-2001.



FOR FOOD SUPPLEMENTS (U.S. CLS. 6, 18, 44, 46, 51 AND 52).

FIRST USE 5-10-2001; IN COMMERCE 5-10-2001.

CLASS 6—METAL GOODS

2,571,799. IPPOLITO, PETER M., DBA CGG DESIGNS, AUSTIN, TX. SN 75-617,973. PUB. 1-25-2000, FILED 1-14-1999.

UNICLIP

FOR METAL COMBINATION CREDIT CARD HOLDER AND MONEY CLIP (U.S. CLS. 2, 12, 13, 14, 23, 25 AND 50).

FIRST USE 9-1-1999; IN COMMERCE 1-14-2000.

2,571,948. T&S BRASS AND BRONZE WORKS, INC., TRAVELERS REST, SC. SN 75-852,412. PUB. 2-6-2001, FILED 11-18-1999.

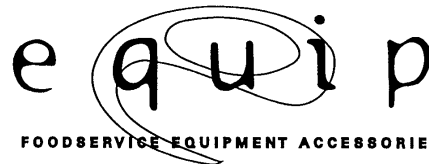

NO CLAIM IS MADE TO THE EXCLUSIVE RIGHT TO USE "EQUIP FOODSERVICE EQUIPMENT ACCESSORIES", APART FROM THE MARK AS SHOWN.

FOR METAL COMPONENT PIECES FOR THE FOODSERVICE INDUSTRY, NAMELY, BULLET FEET, CASTERS, DRAWER SLIDES, HINGES, PULLS AND GREASE FILTERS, USED IN THE FABRICATING PROCESS FOR STAINLESS STEEL TABLES AND OTHER EQUIPMENT (U.S. CLS. 2, 12, 13, 14, 23, 25 AND 50).

FIRST USE 5-0-2000; IN COMMERCE 5-0-2000.

CLASS 6—(Continued).

2,571,973. CAMPBELLSVILLE INDUSTRIES, INC., CAMPBELLSVILLE, KY. SN 75-885,606. PUB. 9-26-2000, FILED 1-3-2000.

THE STEEPLE PEOPLE

FOR ARCHITECTURAL METAL PRODUCTS, NAMELY, STEEPLES, CUPOLAS, TOWERS, CROSSES, COLUMNS, SIGNS, CORNICES, LOUVERS AND BALUSTRADES (U.S. CLS. 2, 12, 13, 14, 23, 25 AND 50).
FIRST USE 6-29-2001; IN COMMERCE 6-29-2001.

CLASS 6—(Continued).

2,572,020. SIMPSON STRONG-TIE COMPANY, INC., DUBLIN, CA. SN 75-942,114. PUB. 3-27-2001, FILED 3-13-2000.

STRONG IS OUR MIDDLE NAME

FOR COLORED METAL SHELVING BRACKETS FOR RESIDENTIAL, COMMERCIAL AND INDUSTRIAL USE (U.S. CLS. 2, 12, 13, 14, 23, 25 AND 50).
FIRST USE 8-10-2001; IN COMMERCE 8-10-2001.

2,572,005. NEW PROCESS STEEL, L.P., HOUSTON, TX. SN 75-917,289. PUB. 5-22-2001, FILED 2-12-2000.

 NEW PROCESS STEEL

OWNER OF U.S. REG. NOS. 2,158,809 AND 2,270,153.
NO CLAIM IS MADE TO THE EXCLUSIVE RIGHT TO USE "NEW PROCESS STEEL", APART FROM THE MARK AS SHOWN.

FOR STEEL MANIPULATED BY SLITTING, LEVELING, BLANKING, COILING AND STAMPED PARTS FOR MANUFACTURED GOODS MADE FROM STEEL PRODUCTS (U.S. CLS. 2, 12, 13, 14, 23, 25 AND 50).
FIRST USE 2-11-2000; IN COMMERCE 2-11-2000.

2,572,018. FORD FASTENERS, INC., HACKENSACK, NJ. SN 75-931,583. PUB. 12-26-2000, FILED 2-29-2000.



FOR METAL FASTENERS, NAMELY NUTS, SCREWS, BOLTS AND WASHERS (U.S. CLS. 2, 12, 13, 14, 23, 25 AND 50).
FIRST USE 1-4-2001; IN COMMERCE 1-4-2001.

2,572,120. NATIONAL COUPLING COMPANY, INC., STAFFORD, TX. SN 76-094,776. PUB. 10-23-2001, FILED 7-24-2000.

SLIM-LINE

FOR MANUALLY OPERATED QUICK RELEASE COUPLING VALVES MADE OF METAL FOR USE IN CONNECTING FLUID LINES USED IN THE EXPLORATION OF OIL AND GAS (U.S. CLS. 2, 12, 13, 14, 23, 25 AND 50).
FIRST USE 8-0-2001; IN COMMERCE 8-0-2001.

2,572,121. REYNOLDS METALS COMPANY, RICHMOND, VA. SN 76-098,638. PUB. 5-22-2001, FILED 7-28-2000.

DAZZLE

FOR ALUMINUM FOIL SHEETS AND ROLLS (U.S. CLS. 2, 12, 13, 14, 23, 25 AND 50).
FIRST USE 10-23-2000; IN COMMERCE 10-23-2000.

2,572,127. EAGLE ENGINEERING AEROSPACE CO., LTD., TOKYO, JAPAN. SN 76-107,440. PUB. 6-5-2001, FILED 8-11-2000.

ACTIFLEX

FOR METAL GASKETS FOR INDUSTRIAL USE AND FOR LAND VEHICLES (U.S. CLS. 2, 12, 13, 14, 23, 25 AND 50).
FIRST USE 9-1-2000; IN COMMERCE 9-1-2000.

CLASS 6—(Continued).

2,572,184. SOLAR GROUP, INC., BUFFALO, NY. SN 76-223,432. PUB. 9-25-2001, FILED 3-12-2001.

D'élégance

THE ENGLISH TRANSLATION OF THE FRENCH WORDING "D'ELEGANCE" IS "OF ELEGANCE".

FOR HORIZONTAL STYLE MAILBOXES COMPOSED PREDOMINANTLY OF METAL, VERTICAL STYLE MAILBOXES COMPOSED PREDOMINANTLY OF METAL, AND METAL CITY MAILBOXES (U.S. CLS. 2, 12, 13, 14, 23, 25 AND 50).

FIRST USE 9-3-2001; IN COMMERCE 9-3-2001.

CLASS 6—(Continued).

2,572,217. MAY, DONALD R., SUN LAKES, AZ. SN 78-041,852. PUB. 8-21-2001, FILED 1-5-2001.



NO CLAIM IS MADE TO THE EXCLUSIVE RIGHT TO USE "STEEL PIERS", APART FROM THE MARK AS SHOWN.

FOR METAL FOUNDATION PILINGS USED TO UNDERPIN THE FOUNDATIONS OF RESIDENCES AND COMMERCIAL STRUCTURES (U.S. CLS. 2, 12, 13, 14, 23, 25 AND 50).

FIRST USE 5-1-2001; IN COMMERCE 5-1-2001.

CLASS 7—MACHINERY

2,571,730. BEAMCO, MOUNTAIN VIEW, CA. SN 75-430,386. PUB. 3-30-1999, FILED 2-6-1998.

PRESCRIPTION AIR

FOR BUILT-IN STATIONARY CENTRALIZED VACUUM CLEANING SYSTEMS AND NON-STATIONARY PORTABLE INDUSTRIAL AND COMMERCIAL VACUUM CLEANERS COMPRISED OF MOTORS, MOTOR HOUSINGS, FILTER/COLLECTOR HOUSINGS, FILTER CARTRIDGES FOR STANDARD HEPA (HIGH EFFICIENCY PARTICULATE AIR) AND ULPA (ULTRA LOW PARTICULATE AIR) FILTRATION, DISPOSABLE FILTER ELEMENTS, CLEANING HOSES AND CLEANING TOOLS AND PARTS THEREFOR FOR ALL OF THE AFORESAID GOODS (U.S. CLS. 13, 19, 21, 23, 31, 34 AND 35).

FIRST USE 12-21-2001; IN COMMERCE 12-21-2001.

2,572,211. INTERNATIONAL SWEETS INC, PHOENIX, AZ. SN 78-035,098. PUB. 9-11-2001, FILED 11-14-2000.

ICRÉME

2,571,751. GATES CORPORATION, THE, DENVER, CO. SN 75-493,098. PUB. 5-11-1999, FILED 5-29-1998.

POWERPAINT

THE MARK IS PRESENTED WITHOUT ANY SPECIAL FORM.

FOR METAL GAS CYLINDERS FOR INDUSTRIAL AND COMMERCIAL MACHINES FOR MAKING SODA WATER, CREAM, AND WHIPPED CREAM, AND PARTS THEREFOR (U.S. CLS. 2, 12, 13, 14, 23, 25 AND 50).

FIRST USE 3-14-2001; IN COMMERCE 5-27-2001.

FOR TOOTHED POWER TRANSMISSION BELTS FOR USE WITH INDUSTRIAL MACHINERY, NAMELY, CONVEYORS (U.S. CLS. 13, 19, 21, 23, 31, 34 AND 35).

FIRST USE 8-0-2001; IN COMMERCE 8-0-2001.

CLASS 7—(Continued).

2,571,767. BRECONCHERRY LIMITED, LEDBURY, HEREFORDSHIRE, HR8 2DH, ENGLAND. SN 75-544,870. PUB. 7-31-2001, FILED 8-28-1998.

CLIP-DISC

PRIORITY CLAIMED UNDER SEC. 44(D) ON ERPN CMNTY TM OFC APPLICATION NO. 807131, FILED 4-16-1998.

FOR MACHINES USED IN INDUSTRY FOR CLEANING AND WASHING TANKS, IN PARTICULAR THE INSIDE SURFACES AND INTERNAL FITTINGS OF PROCESS AND STORAGE TANKS AND PARTS THEREFORE (U.S. CLS. 13, 19, 21, 23, 31, 34 AND 35).

FIRST USE 0-0-1986; IN COMMERCE 0-0-1986.

2,571,772. TILIA INTERNATIONAL, INC., TAI KOK TSAI, KOWLOON, HONG KONG. SN 75-568,601. PUB. 3-20-2001, FILED 10-13-1998.

BAGVAC

FOR VACUUM PACKAGING MACHINES FOR DOMESTIC USE, AND PARTS THEREFOR (U.S. CLS. 13, 19, 21, 23, 31, 34 AND 35).

FIRST USE 4-30-1999; IN COMMERCE 4-30-1999.

2,571,774. GLOBAL GRAPHICS S.A., 54340 POMPEY, FRANCE. SN 75-576,611. PUB. 9-5-2000, FILED 10-27-1998.

GLOBAL GRAPHICS

NO CLAIM IS MADE TO THE EXCLUSIVE RIGHT TO USE "GRAPHICS", APART FROM THE MARK AS SHOWN.

FOR POWER OPERATED PRE-PRESS EQUIPMENT FOR THE PRINTING AND PACKAGING INDUSTRY, NAMELY, MACHINERY WHICH EXPOSES AND PROCESSES PHOTOPOLYMER MATERIAL USED IN FLEXOGRAPHIC PRINTING (U.S. CLS. 13, 19, 21, 23, 31, 34 AND 35).

FIRST USE 1-1-1998; IN COMMERCE 1-1-1998.

2,571,785. XEROX CORPORATION, STAMFORD, CT. SN 75-598,195. PUB. 5-8-2001, FILED 12-2-1998.

X-TREME FILLING

FOR SPECIALIZED EQUIPMENT USED IN THE MANUFACTURE OF TONER CARTRIDGES, NAMELY ELECTROMAGNETIC VALVES AND COMPRESSION NOZZLES (U.S. CLS. 13, 19, 21, 23, 31, 34 AND 35).

FIRST USE 12-1-2001; IN COMMERCE 12-1-2001.

CLASS 7—(Continued).

2,571,814. FRES-CO SYSTEM USA, INC., TELFORD, PA. SN 75-638,475. PUB. 11-9-1999, FILED 2-12-1999.

CORNER SEAL

FOR MACHINERY FOR MAKING FLEXIBLE PACKAGES (U.S. CLS. 13, 19, 21, 23, 31, 34 AND 35).

FIRST USE 9-16-2001; IN COMMERCE 9-16-2001.

2,571,885. VOITH SULZER PAPIERTECHNIK PATENT GMBH, D-89522 HEIDENHEIM, FED REP GERMANY. SN 75-761,560. PUB. 3-28-2000, FILED 7-27-1999.

MASTERJET

FOR MACHINES FOR THE MANUFACTURE AND TREATMENT OF PAPER AND PARTS THEREFOR (U.S. CLS. 13, 19, 21, 23, 31, 34 AND 35).

FIRST USE 2-1-2000; IN COMMERCE 2-1-2000.

2,571,900. INTERCLEAN EQUIPMENT, INC., ANN ARBOR, MI. SN 75-780,489. PUB. 5-16-2000, FILED 9-16-1999.



THE MARK CONSISTS OF STYLIZED "I" ON A SPHERE. FOR DRIVE THROUGH WASHING MACHINE FOR VEHICLES, NAMELY, TRAINS, TRUCKS, BUSES, AND AUTOMOBILES (U.S. CLS. 13, 19, 21, 23, 31, 34 AND 35).

FIRST USE 8-8-2000; IN COMMERCE 8-8-2000.

2,571,907. UNITED STATES FILTER CORPORATION, PALM DESERT, CA. SN 75-795,648. PUB. 4-18-2000, FILED 9-8-1999.

SUPER V TUMBLAST

NO CLAIM IS MADE TO THE EXCLUSIVE RIGHT TO USE "SUPER", APART FROM THE MARK AS SHOWN.

FOR BLAST CLEANING MACHINE (U.S. CLS. 13, 19, 21, 23, 31, 34 AND 35).

FIRST USE 12-6-1997; IN COMMERCE 12-6-1997.

CLASS 7—(Continued).

2,572,016. BUEHLER LTD., LAKE BLUFF, IL. SN 75-931,217.
PUB. 12-19-2000, FILED 2-28-2000.

BUEHLERHERCULES

OWNER OF U.S. REG. NOS. 1,120,290, 1,707,289, AND OTHERS.

FOR POWER OPERATED GRINDING DISKS FOR THE FINE GRINDING AND ROUGH POLISHING OF METALLURGICAL SAMPLES (U.S. CLS. 13, 19, 21, 23, 31, 34 AND 35).

FIRST USE 11-1-1999; IN COMMERCE 11-1-1999.

2,572,041. ORION PACKAGING SYSTEMS, INC., MEMPHIS, TN. SN 76-003,697. PUB. 1-2-2001, FILED 3-18-2000.

S-SENSE

FOR PACKAGING MACHINES, NAMELY, STRETCH WRAPPING MACHINES FOR WRAPPING BUNDLED PRODUCTS FOR SHIPPING PURPOSES (U.S. CLS. 13, 19, 21, 23, 31, 34 AND 35).

FIRST USE 1-1-2000; IN COMMERCE 2-23-2000.

2,572,044. BLOUNT, INC., PORTLAND, OR. SN 76-007,542. PUB. 3-6-2001, FILED 3-24-2000.

SPEEDHOOK

FOR POWER OPERATED CONCRETE CUTTING SYSTEM FOR USE WITH A CUTTING CHAINSAW COMPOSED OF A HOOK RAIL AND A MOUNTING PLATE WITH AN AXLE (U.S. CLS. 13, 19, 21, 23, 31, 34 AND 35).

FIRST USE 3-9-2000; IN COMMERCE 3-9-2000.

2,572,067. WESTLAND GUMMIWERKE GMBH, D-49324 MELLE- WESTERHAUSEN, FED REP GERMANY. SN 76-036,319. PUB. 1-23-2001, FILED 4-27-2000.



FOR RUBBER COATED ROLLERS AS PARTS OF MACHINES; SHAPED PARTS MADE OF RUBBER AND RUBBER METAL COMPOSITES AS PARTS OF MACHINES (U.S. CLS. 13, 19, 21, 23, 31, 34 AND 35).

FIRST USE 3-0-1988; IN COMMERCE 7-0-1996.

CLASS 7—(Continued).

2,572,101. INGERSOLL-RAND COMPANY, WOODCLIFF LAKE, NJ. SN 76-074,569. PUB. 4-17-2001, FILED 6-21-2000.

GARAGE MATE

NO CLAIM IS MADE TO THE EXCLUSIVE RIGHT TO USE "GARAGE", APART FROM THE MARK AS SHOWN.

FOR AIR COMPRESSORS (U.S. CLS. 13, 19, 21, 23, 31, 34 AND 35).

FIRST USE 3-23-2000; IN COMMERCE 3-23-2000.

2,572,154. SHUTTLELIFT, INC., STURGEON BAY, WI. SN 76-162,779. PUB. 8-7-2001, FILED 11-9-2000.

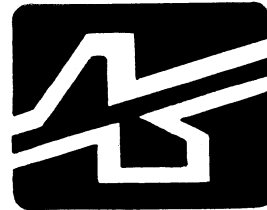

THE MARK CONSISTS OF A STYLIZED LEVER AND FULCRUM DESIGN.

FOR VEHICLE-MOUNTED POLE HANDLING AND POLE HOLDING MACHINES (U.S. CLS. 13, 19, 21, 23, 31, 34 AND 35).

FIRST USE 3-31-2001; IN COMMERCE 3-31-2001.

2,572,176. JASON INCORPORATED, CONOVER, NC. SN 76-197,913. PUB. 8-14-2001, FILED 1-22-2001.

MAGNA-FLEX

FOR POWER DRIVEN ROTARY BUFFS (U.S. CLS. 13, 19, 21, 23, 31, 34 AND 35).

FIRST USE 7-6-2001; IN COMMERCE 7-6-2001.

2,572,177. ORII & MEC CORPORATION, KAWAGUCHI-SHI, SAITAMA, JAPAN. SN 76-200,167. PUB. 8-14-2001, FILED 1-26-2001.

MEC

FOR METAL COILING MACHINES (U.S. CLS. 13, 19, 21, 23, 31, 34 AND 35).

FIRST USE 5-25-1995; IN COMMERCE 5-25-1995.

CLASS 7—(Continued).

2,572,180. BERTRAND, ROBERT, BATON ROUGE, LA. SN 76-205,645. PUB. 9-4-2001, FILED 2-6-2001.

LATHEMASTER

FOR MACHINE TOOLS, NAMELY, LATHES AND COMPONENT PARTS THEREFOR; AND MACHINE TOOL ACCESSORIES, NAMELY, TOOL HOLDERS (U.S. CLS. 13, 19, 21, 23, 31, 34 AND 35).

FIRST USE 8-1-2001; IN COMMERCE 8-1-2001.

2,572,182. REBEL INDUSTRIES LLC, PINCKNEY, MI. SN 76-216,122. PUB. 8-14-2001, FILED 2-26-2001.

ROGUE

FOR POWER OPERATED SAWS (U.S. CLS. 13, 19, 21, 23, 31, 34 AND 35).

FIRST USE 12-7-2001; IN COMMERCE 12-7-2001.

CLASS 8—HAND TOOLS

2,572,108. WILTON TOOL COMPANY, LLC, PALATINE, IL, BY CHANGE OF NAME WILTON CORPORATION, PALATINE, IL. SN 76-083,481. PUB. 8-21-2001, FILED 7-6-2000.

SAW BUDDY

NO CLAIM IS MADE TO THE EXCLUSIVE RIGHT TO USE "SAW", APART FROM THE MARK AS SHOWN, FOR CARPENTER'S CLAMPS TO BE USED WITH SAWS (U.S. CLS. 23, 28 AND 44).

FIRST USE 7-6-2000; IN COMMERCE 8-0-2000.

2,572,111. ICC INNOVATIVE CONCEPTS CORPORATION, TORRINGTON, CT. SN 76-086,895. PUB. 3-27-2001, FILED 7-11-2000.

HOOKPRO

FOR MULTIPURPOSE HAND TOOLS, NAMELY, A COMBINATION SOCKET DRIVER, SCREWDRIVER, AND HOOK DRIVER (U.S. CLS. 23, 28 AND 44).

FIRST USE 6-15-2000; IN COMMERCE 9-24-2001.

2,572,141. CALTOMIC CORPORATION, GARDENA, CA. SN 76-131,003. PUB. 5-22-2001, FILED 9-19-2000.

CALTOMIC

FOR HAND TOOLS AND INSTRUMENTS NAMELY RAZORS AND RAZOR BLADES (U.S. CLS. 23, 28 AND 44).

FIRST USE 1-0-2001; IN COMMERCE 1-0-2001.

CLASS 9—ELECTRICAL AND SCIENTIFIC APPARATUS

2,571,689. STARFISH SOFTWARE, INC., SCOTTS VALLEY, CA. SN 75-038,607. PUB. 8-12-1997, FILED 12-28-1995.

WEBWATCH

FOR COMPUTER SOFTWARE FOR USE IN STORING, MANAGING AND TRANSFERRING HOUSEHOLD, FAMILY, BUSINESS OR PERSONAL INFORMATION; SOFTWARE FOR SCHEDULING AND CALENDARING; SOFTWARE FOR COMMUNICATIONS, NAMELY, E-MAIL, VOICE MAIL AND VOICE MESSAGING, AND FOR AND FAX PROCESSING; SOFTWARE FOR PROVIDING REMOTE ACCESS TO COMPUTERS, COMPUTER NETWORKS AND DATABASES; SOFTWARE FOR DATABASE ACCESS, MANAGEMENT, IMPLEMENTATION, UTILIZATION AND REPORTING; ORGANIZER SOFTWARE PROVIDING COMBINATIONS OF THE FOREGOING FEATURES IN ONE PROGRAM WITH A COMMON INTERFACE; SOFTWARE FOR MONITORING, AUTHORIZING, CONTROLLING AND TRACKING ACCESS TO COMPUTER NETWORKS; COMPUTER SOFTWARE FOR DEVELOPING OTHER APPLICATIONS SOFTWARE; VISUAL DEVELOPMENT SOFTWARE TOOLS FOR DEVELOPING OTHER SOFTWARE; USER INTERFACE SOFTWARE FOR ACCESSING WIDE AREA COMPUTER NETWORKS; SOFTWARE DEVELOPMENT TOOLS AND UTILITY PROGRAMS FOR USE IN CONNECTION WITH WIDE AREA COMPUTER NETWORKS; AND FOR GENERAL PURPOSE PROGRAMMING TOOLS AND UTILITIES; AND INSTRUCTIONAL MANUALS DISTRIBUTED THEREWITH (U.S. CLS. 21, 23, 26, 36 AND 38).

FIRST USE 11-6-2000; IN COMMERCE 11-6-2000.

2,571,693. SUNTEX INTERNATIONAL, INC., EASTON, PA. SN 75-186,785. PUB. 2-3-1998, FILED 10-24-1996.

JUMPING LEVELS

OWNER OF U.S. REG. NO. 1,958,809.

FOR COMPUTER SOFTWARE, NAMELY, EDUCATIONAL SOFTWARE FOR IMPROVING MATH SKILLS (U.S. CLS. 21, 23, 26, 36 AND 38).

FIRST USE 2-15-2001; IN COMMERCE 2-15-2001.

2,571,697. XULU ENTERTAINMENT INC., SAN JOSE, CA. SN 75-304,736. PUB. 8-18-1998, FILED 6-6-1997.

XULU

FOR MULTI-MEDIA AND VIRTUAL REALITY SOFTWARE IN THE FIELDS OF ACCOUNTING; ADVERTISING; ARCHITECTURE; ANIMAL TRAINING; AMUSEMENT PARKS; ART; DESIGN; ASTROLOGY; AUDIO BROADCASTING, RECORDING AND PRODUCTION; ANTHROPOLOGY; BOOKKEEPING; BUSINESS TECHNIQUES; BUNGEE JUMPING; BIOLOGY; CHEMISTRY; COMPUTERS; COMPUTER PROGRAMMING; COMPUTER SOFTWARE DESIGN; CINEMATOGRAPHY; COOKING; CONSTRUCTION; DATA PROCESSING; DENTISTRY; DESIGN; ECONOMICS; EDUCATION; ENTERTAINMENT; ENGINEERING; EXPLORATION; EXCAVATION; FARMING; FINANCING; FILM PRODUCTION, DEVELOPING AND PROCESSING; FLIGHT SIMULATION; GAMES; GEOLOGY; GARDENING; GRAPHIC DESIGN; HEALTH CARE; HISTORY; HORTICULTURE; HOTEL MANAGEMENT; INDUSTRIAL DESIGN; LANDSCAPE DESIGN; MEDICINE; MATHEMATICS; MERCHANDISING; ME-

CLASS 9—(Continued).

CHANICS; MANAGEMENT; MILITARY TRAINING; MINING; MOUNTAIN CLIMBING; MUSIC; NUTRITION; OPTOMETRY; PAINTING; PHYSICS; PRINTING; PSYCHOLOGY; PHYSICAL THERAPY; PARACHUTING; PHOTOGRAPHY; PUBLISHING; RADIO AND TELEVISION BROADCASTING, PROGRAMMING, PRODUCTION AND COMMUNICATION; REAL ESTATE; RACECAR DRIVING; SKIING; SURFING; SCUBA DIVING; SURGERY; SALES; STATISTICS; SCIENCE; SOFTWARE DESIGN; SOUND RECORDINGS; SPORTS; SURVEYING; TECHNOLOGY; TAILORING; TELEMAR- KETING; TOURISM; TEACHING; TRAVEL; VIDEO BROADCASTING; WATER SPORTS; COMPUTER AND VIDEO GAME SOFTWARE; COMPUTER AND VIDEO GAME HARDWARE INCLUDING WIRELESS HEAD- SETS, PERSONAL DIGITAL ASSISTANTS, COMPUTERS, INPUT DEVICES, GRAPHIC DISPLAYS, FLAT PANEL DEVICES, GOGGLES AND ELECTRONIC GLASSES, ELECTRONIC GLOVES, VIDEO CAMERAS, JOYSTICKS, ELECTRONIC WHITEBOARDS; GLOBAL COMMUNI- CATIONS NETWORK GAMES AND DOWNLOADABLE COMPUTER GAME PROGRAMS (U.S. CLS. 21, 23, 26, 36 AND 38).

FIRST USE 11-9-2001; IN COMMERCE 11-9-2001.

2,571,699. KISTLER-MORSE CORPORATION, BOTHELL, WA. SN 75-315,762. PUB. 9-1-1998, FILED 6-27-1997.

SENTRY

FOR WEIGHT AND LEVEL MEASUREMENT SYS- TEM, COMPRISING ELECTRONIC SIGNAL PROCES- SING UNIT AND TRANSDUCERS, FOR USE IN INDUSTRIAL WEIGHT AND LEVEL MEASUREMENTS (U.S. CLS. 21, 23, 26, 36 AND 38).

FIRST USE 6-27-1997; IN COMMERCE 6-27-1997.

2,571,700. KCTS TELEVISION, SEATTLE, WA. SN 75-318,275. PUB. 11-17-1998, FILED 7-2-1997.

INTRIS

FOR PRE-RECORDED VIDEOTAPES, AUDIO TAPES, LASER-READABLE DISCS, MULTIMEDIA FOR- MATTED DISCS, AND COMPUTER SOFTWARE FEAT- URING TELEVISION AND OTHER AUDIO-VISUAL OR AUDIO PROGRAMMING OR INTERACTIVE WORKS OF AN ENTERTAINMENT, CULTURAL OR EDUCA- TIONAL NATURE, NAMELY, NEWS, BIOGRAPHIES, PUBLIC AND COMMUNITY AFFAIRS, GOVERNMENT AND POLITICS, GEOGRAPHY AND TRAVEL, ECO- NOMICS AND FINANCE, RELIGION, SCIENCE AND TECHNOLOGY, HISTORY, LITERATURE, ART, MUSIC, PERFORMING ARTS, SOUNDTRACKS, HOBBIES, SPORTS, PRE-SCHOOL, PRIMARY, SECONDARY, AND GRADUATE-LEVEL SCHOOL SUPPLEMENTARY MA- TERIAL, AND ADULT LEARNING AND LITERACY TRAINING MATERIAL; COMPUTER GAME PRO- GRAMS, COMPUTER GAME SOFTWARE, COMPUTER GAME TAPES, COMPUTER GAME CARTRIDGES, COM- PUTEER GAME CASSETTES, COMPUTER GAME DISCS, COMPUTER GAME EQUIPMENT CONTAINING MEM- ORY DEVICES, NAMELY, DISCS (U.S. CLS. 21, 23, 26, 36 AND 38).

FIRST USE 10-0-1998; IN COMMERCE 10-0-1998.

CLASS 9—(Continued).

2,571,701. XULU ENTERTAINMENT INC., SAN JOSE, CA. SN 75-321,800. PUB. 8-18-1998, FILED 7-8-1997.

XULU ADVENTURERS' CLUB

NO CLAIM IS MADE TO THE EXCLUSIVE RIGHT TO USE "CLUB", APART FROM THE MARK AS SHOWN.

FOR MULTI-MEDIA AND VIRTUAL REALITY SOFT- WARE IN THE FIELDS OF ACCOUNTING; ADVERTIS- ING; ARCHITECTURE; ANIMAL TRAINING; AMUSEMENT PARKS; ART; DESIGN; ASTROLOGY; AUDIO BROADCASTING, RECORDING AND PRODU- CTION; ANTHROPOLOGY; BOOKKEEPING; BUSINESS TECHNIQUES; BUNGEE JUMPING; BIOLOGY; CHEM- ISTRY; COMPUTERS; COMPUTER PROGRAMMING; COMPUTER SOFTWARE DESIGN; CINEMATOGRA- PHY; COOKING; CONSTRUCTION; DATA PROCES- SING; DENTISTRY; DESIGN; ECONOMICS; EDUCATION; ENTERTAINMENT; ENGINEERING; EX- PLORATION; EXCAVATION; FARMING; FINANCING; FILM PRODUCTION, DEVELOPING AND PROCES- SING; FLIGHT SIMULATION; GAMES; GEOLOGY; GARDENING; GRAPHIC DESIGN; HEALTH CARE; HISTORY; HORTICULTURE; HOTEL MANAGEMENT; INDUSTRIAL DESIGN; LANDSCAPE DESIGN; MEDI- CINE; MATHEMATICS; MERCHANDISING; ME- CHANICS; MANAGEMENT; MILITARY TRAINING; MINING; MOUNTAIN CLIMBING; MUSIC; NUTRI- TION; OPTOMETRY; PAINTING; PHYSICS; PRINTING; PSYCHOLOGY; PHYSICAL THERAPY; PARACHUTING; PHOTOGRAPHY; PUBLISHING; RADIO AND TELEVI- SION BROADCASTING, PROGRAMMING, PRODU- CTION AND COMMUNICATION; REAL ESTATE; RACECAR DRIVING; SKIING; SURFING; SCUBA DIV- ING; SURGERY; SALES; STATISTICS; SCIENCE; SOFT- WARE DESIGN; SOUND RECORDINGS; SPORTS; SURVEYING; TECHNOLOGY; TAILORING; TELEMAR- KETING; TOURISM; TEACHING; TRAVEL; VIDEO BROADCASTING; WATER SPORTS; COMPUTER AND VIDEO GAME SOFTWARE; COMPUTER AND VIDEO GAME HARDWARE INCLUDING WIRELESS HEAD- SETS, PERSONAL DIGITAL ASSISTANTS, COMPUTERS, INPUT DEVICES, GRAPHIC DISPLAYS, FLAT PANEL DEVICES, GOGGLES AND ELECTRONIC GLASSES, ELECTRONIC GLOVES, VIDEO CAMERAS, JOYSTICKS, ELECTRONIC WHITEBOARDS; GLOBAL COMMUNI- CATIONS NETWORK GAMES AND DOWNLOADABLE COMPUTER GAME PROGRAMS (U.S. CLS. 21, 23, 26, 36 AND 38).

FIRST USE 11-9-2001; IN COMMERCE 11-9-2001.

2,571,708. UNIVERSAL DISTRIBUTING OF NEVADA, INC., LAS VEGAS, NV. SN 75-370,965. PUB. 9-22-1998, FILED 10- 9-1997.

TRIPLE FORTUNE

FOR GAMING MACHINES, NAMELY SLOT MA- CHINES WITH OR WITHOUT A VIDEO OUTPUT (U.S. CLS. 21, 23, 26, 36 AND 38).

FIRST USE 10-0-1997; IN COMMERCE 2-0-1998.

CLASS 9—(Continued).

2,571,711. KAY, LARRY, LOS GATOS, CA, ASSIGNEE OF; BY ASSIGNMENT TOONSMITHS, INC., LOS GATOS, CA. SN 75-372,721. PUB. 9-29-1998, FILED 10-14-1997.



OWNER OF U.S. REG. NO. 1,886,421. THE STIPPLING IS A FEATURE OF THE MARK AND DOES NOT INDICATE COLOR. FOR INTERACTIVE COMPUTER GAME SOFTWARE PROGRAMS (U.S. CLS. 21, 23, 26, 36 AND 38). FIRST USE 12-14-2001; IN COMMERCE 12-14-2001.

2,571,712. HORNBAKER, JEFFREY, MONTCLAIR, CA. SN 75-376,685. PUB. 9-15-1998, FILED 10-21-1997.

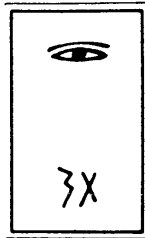

THIRD EYE

FOR SUNGLASSES (U.S. CLS. 21, 23, 26, 36 AND 38). FIRST USE 12-5-2001; IN COMMERCE 12-6-2001.

2,571,715. PEAKCARE, LLC, ENGLEWOOD, CO. SN 75-387,898. PUB. 6-22-1999, FILED 11-10-1997.



FOR PRE-RECORDED VIDEOTAPES IN THE FIELD OF PHYSICAL THERAPY AND REHABILITATION (U.S. CLS. 21, 23, 26, 36 AND 38). FIRST USE 1-1-1997; IN COMMERCE 1-1-1998.

CLASS 9—(Continued).

2,571,716. INTERTRUST TECHNOLOGIES CORPORATION, SANTA CLARA, CA. SN 75-393,411. PUB. 10-6-1998, FILED 11-20-1997.

INTERRIGHTS

FOR COMPUTER HARDWARE AND/OR COMPUTER SOFTWARE FOR SECURE EVENT MANAGEMENT IN THE FIELDS OF ELECTRONIC DISTRIBUTION, RIGHTS PROTECTION AND MANAGEMENT OF DIGITAL INFORMATION, NAMELY, SOFTWARE AND/OR HARDWARE FOR ELECTRONICALLY DISTRIBUTING, ADMINISTRATING, SECURING, DIGITAL WATER-MARKING AND/OR AUDITING USAGE OF DIGITAL INFORMATION AND/OR CREATING CRYPTOGRAPHIC CONTAINERS (U.S. CLS. 21, 23, 26, 36 AND 38).

FIRST USE 9-30-2000; IN COMMERCE 9-30-2000.

2,571,722. CTI2 LTD., HERZLIYA PITUACH 46733, ISRAEL. SN 75-414,879. PUB. 5-30-2000, FILED 1-7-1998.

W.W.OFFICE

FOR COMPUTER HARDWARE AND COMPUTER SOFTWARE THAT PROVIDES MAILBOX CAPABILITIES FOR RECEIPT OF VOICE MAIL, FAX MAIL, AND E-MAIL WITH USER ACCESS AND RETRIEVAL OF MESSAGES VIA TELEPHONE, PERSONAL COMPUTER, OR FAX MACHINE (U.S. CLS. 21, 23, 26, 36 AND 38). FIRST USE 3-0-1998; IN COMMERCE 6-8-2000.

2,571,733. RED CHIP COMPANY LTD., TORTOLA, BR. VIRGIN ISLANDS. SN 75-440,017. PUB. 9-21-1999, FILED 2-25-1998.

ULTRAROC

FOR ELECTRIC AND DIGITAL SOUND EQUIPMENT FOR HOME AND PROFESSIONAL USE, NAMELY, GUITAR AMPLIFIERS, AND LOUDSPEAKERS (U.S. CLS. 21, 23, 26, 36 AND 38). FIRST USE 6-20-2001; IN COMMERCE 8-6-2001.

2,571,735. RED CHIP COMPANY LTD., TORTOLA, BR. VIRGIN ISLANDS. SN 75-446,119. PUB. 10-5-1999, FILED 3-6-1998.

VIRTUBE

FOR ELECTRONIC AND DIGITAL SOUND EQUIPMENT FOR HOME AND PROFESSIONAL USE, NAMELY, ELECTRONIC CIRCUITRY USED AS A COMPONENT IN APPARATUS FOR RECORDING, TRANSMITTING AND REPRODUCING AUDIO (U.S. CLS. 21, 23, 26, 36 AND 38). FIRST USE 11-13-2000; IN COMMERCE 11-13-2000.

CLASS 9—(Continued).

2,571,746. SUR-GARD SECURITY SYSTEMS LTD., DOWNSVIEW, ONTARIO, CANADA. SN 75-479,094. PUB. 2-1-2000, FILED 5-4-1998.

SKYROUTE

OWNER OF CANADA REG. NO. TMA514423, DATED 8-13-1999, EXPIRES 8-13-2014.

FOR RADIO TRANSMITTERS, RF TRANSMITTERS USING CELLULAR TELEPHONE TECHNOLOGY TO TRANSMIT DATA (U.S. CLS. 21, 23, 26, 36 AND 38).
FIRST USE 4-30-1998; IN COMMERCE 6-4-1998.

2,571,752. BUCKEYE CABLEVISION, INC., TOLEDO, OH. SN 75-495,101. PUB. 12-19-2000, FILED 6-3-1998.



NO CLAIM IS MADE TO THE EXCLUSIVE RIGHT TO USE "CABLE SYSTEM CONROLLER II", APART FROM THE MARK AS SHOWN.

FOR PROGRAMMABLE REMOTE TRANSMITTER AND RECEIVER FOR OPERATING A TELEVISION RECEIVER (U.S. CLS. 21, 23, 26, 36 AND 38).
FIRST USE 4-0-1997; IN COMMERCE 4-0-1997.

2,571,753. BKL TECHNOLOGIES INC., BROWNSVILLE, TX. SN 75-496,768. PUB. 1-11-2000, FILED 6-5-1998.

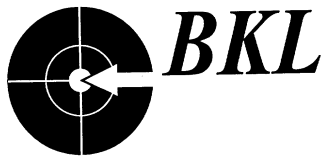

FOR TELESCOPIC FIREARM SIGHTS (U.S. CLS. 21, 23, 26, 36 AND 38).
FIRST USE 7-1-1998; IN COMMERCE 7-1-1998.

2,571,762. M.I.N.D. INSTITUTE, IRVINE, CA. SN 75-525,302. PUB. 8-22-2000, FILED 7-24-1998.

**CLASS 9—(Continued).**

NO CLAIM IS MADE TO THE EXCLUSIVE RIGHT TO USE "SPATIAL-TEMPORAL ANIMATION REASONING", APART FROM THE MARK AS SHOWN.

FOR COMPUTER SOFTWARE AND GAMES FOR TEACHING MATH AND SCIENCE CONCEPTS (U.S. CLS. 21, 23, 26, 36 AND 38).

FIRST USE 6-0-1998; IN COMMERCE 6-0-2001.

2,571,768. TMS, INC., DBA TMSSEQUOIA, STILLWATER, OK. SN 75-547,641. PUB. 4-17-2001, FILED 9-3-1998.

PRIZM

FOR COMPUTER SOFTWARE FOR IMAGE DISPLAY, MANIPULATION, AND PRINTING FROM COMPRESSED DOCUMENTS RECEIVED OVER GLOBAL OR ENTERPRISE NETWORKS (U.S. CLS. 21, 23, 26, 36 AND 38).

FIRST USE 7-0-1997; IN COMMERCE 7-0-1997.

2,571,790. RIVERDEEP INTERACTIVE LEARNING LIMITED, DUBLIN, IRELAND. BY ASSIGNMENT; BY ASSIGNMENT EDMARK CORPORATION, REDMOND, WA. SN 75-606,235. PUB. 10-26-1999, FILED 12-15-1998.

FRIPPLETOWN

FOR EDUCATIONAL COMPUTER SOFTWARE FOR CHILDREN IN THE FIELDS OF CRITICAL THINKING, CREATIVITY, LOGIC, MEMORY AND PROBLEM SOLVING, AND USER MANUALS SOLD AS A UNIT THEREWITH (U.S. CLS. 21, 23, 26, 36 AND 38).

FIRST USE 2-0-1999; IN COMMERCE 2-0-1999.

2,571,792. MEDIA GROUP, STAMFORD, CT. SN 75-608,735. PUB. 4-24-2001, FILED 12-18-1998.

WEATHERMAN ALERT

NO CLAIM IS MADE TO THE EXCLUSIVE RIGHT TO USE "WEATHERMAN", APART FROM THE MARK AS SHOWN.

FOR RADIOS THAT ARE PRESET TO WEATHER CHANNEL FREQUENCIES (U.S. CLS. 21, 23, 26, 36 AND 38).

FIRST USE 12-0-1998; IN COMMERCE 12-0-1998.

CLASS 9—(Continued).

2,571,798. WIRELESS LINK CORPORATION, MILPITAS, CA. SN 75-615,274. PUB. 10-5-1999, FILED 1-4-1999.

ASSETVISION

FOR COMPUTER SOFTWARE AND HARDWARE FOR THE TRACKING OF MOBILE PROPERTY, THROUGH CELLULAR VOICE AND DATA GLOBAL POSITIONING (GPS) SYSTEMS; COMPUTER SOFTWARE AND HARDWARE FOR THE MANAGEMENT AND REPORTING CONCERNING THE CONDITION OF TANGIBLE PROPERTY, INCLUDING VEHICLES (U.S. CLS. 21, 23, 26, 36 AND 38).

FIRST USE 8-10-1998; IN COMMERCE 10-20-1998.

2,571,800. GEER GROUP, INC., THE, CHARLOTTE, NC. SN 75-620,814. PUB. 10-17-2000, FILED 1-11-1999.

ENFOMANIAC

FOR INFORMATIONAL MULTIMEDIA SOFTWARE IN THE FIELD OF BUSINESS MARKETING AND COMPANY PRODUCT AND SERVICES INFORMATION (U.S. CLS. 21, 23, 26, 36 AND 38).

FIRST USE 9-1-2001; IN COMMERCE 9-1-2001.

2,571,806. ENGINEERED DATA PRODUCTS, INC., BROOMFIELD, CO. SN 75-629,433. PUB. 10-31-2000, FILED 1-28-1999.

QUICK.A.FFIX

FOR APPARATUS, NAMELY, A LABEL ATTACHER FOR THE AUTOMATIC APPLICATION OF PRE-PRINTED FILE FOLDER LABELS ON TO FILE FOLDERS (U.S. CLS. 21, 23, 26, 36 AND 38).

FIRST USE 10-0-2000; IN COMMERCE 10-0-2000.

2,571,808. VISION ENGINEERING LIMITED, WOKING, SURREY GU23 7ER, ENGLAND. SN 75-630,747. PUB. 5-2-2000, FILED 2-3-1999.

ISIS

FOR EYEPIECE ADD-ONS FOR MICROSCOPES THAT ARE SOLD TO PROFESSIONAL LEVEL CUSTOMERS OF MICROSCOPES IN MEDICAL RESEARCH, RESEARCH LABORATORY AND INDUSTRIAL SETTINGS (U.S. CLS. 21, 23, 26, 36 AND 38).

FIRST USE 9-0-2000; IN COMMERCE 9-0-2000.

CLASS 9—(Continued).

2,571,813. IMAGEMAX, INC., CONSHOHOCKEN, PA. SN 75-637,982. PUB. 10-3-2000, FILED 2-5-1999.



NO CLAIM IS MADE TO THE EXCLUSIVE RIGHT TO USE "WEB", APART FROM THE MARK AS SHOWN.

FOR COMPUTER SOFTWARE TO BE USED WITH A BROWSER FOR FACILITATING THE RETRIEVAL AND TRANSFER OF DOCUMENTS ACROSS LOCAL AND GLOBAL COMPUTER NETWORKS (U.S. CLS. 21, 23, 26, 36 AND 38).

FIRST USE 5-1-1998; IN COMMERCE 8-4-1999.

2,571,817. FOVEON, INC., SANTA CLARA, CA. SN 75-650,464. PUB. 1-11-2000, FILED 3-1-1999.



FOR ELECTRONIC CAMERAS AND IMAGING SYSTEMS COMPRISED OF COMPUTERS AND IMAGING SOFTWARE FOR CAPTURING, EDITING AND PRINTING IMAGES (U.S. CLS. 21, 23, 26, 36 AND 38).

FIRST USE 7-1-1999; IN COMMERCE 7-1-1999.

CLASS 9—(Continued).

2,571,819. DDC DATA DEVICE CORPORATION, BOHEMIA, NY. SN 75-654,653. PUB. 9-12-2000, FILED 3-5-1999.



OWNER OF U.S. REG. NOS. 830,114, 1,179,898, AND OTHERS.

NO CLAIM IS MADE TO THE EXCLUSIVE RIGHT TO USE "DATA DEVICE CORPORATION", APART FROM THE MARK AS SHOWN.

FOR ELECTRONIC COMPONENTS AND CIRCUITS IN THE DATA CONVERSION FIELD, NAMELY SYNCHRO TO DIGITAL CONVERTERS, HYBRID SYNCHRO AND RESOLVER CONVERTERS, RESOLVER TO DIGITAL CONVERTERS, DIGITAL TO RESOLVER CONVERTERS, DIGITAL TO SYNCHRO CONVERTERS, HYBRID THICK FILM DATA CONVERTERS, SAMPLE AND HOLD AMPLIFIERS, TRACK AND HOLD AMPLIFIERS, SAMPLE AND HOLD CIRCUITS, CIRCUIT OVERVOLTAGE DETECTORS, MULTIPLEXERS, SOLID STATE CONTROL ELECTRICAL TRANSFORMERS, SOLID STATE CONTROL DIFFERENTIAL TRANSMITTERS, ANGLE INDICATORS, POWER SUPPLIES, SOCKETS AND CONNECTORS, TRACK AND HOLD CIRCUITS, PROGRAMMABLE LINE DRIVERS, SOLID STATE REMOTE ELECTRICAL POWER CONTROLLERS, ELECTRONIC DEPTH INDICATORS, SHAFT ENCODER ANGLE INDICATORS, SYNCHRO/RESOLVER ANGLE INDICATORS, SYNCHRO/RESOLVER ANGLE SIMULATORS, AND SHAFT ANGLE ENCODERS, MIL-STD-1553 AND STANAG-3838 DATABUSSES, FIBER CHANNEL DATA BUSSES UTILIZING BOTH COPPER AND FIBER OPTICS, AIR-COOLED AND CONDUCTION COOLED ELECTRONIC PRINTED VME CIRCUIT BOARDS, SOLID STATE POWER CONTROLLERS (SSP) AND REMOTE POWER CONTROLLERS (RPC), SOLID-STATE ELECTRONIC HYBRID CIRCUITS MADE UP OF TWO OR MORE DIFFERENT MONOLITHIC INTEGRATED CIRCUITS, SOLID STATE ELECTRONIC CIRCUIT MODULES IMMersed IN A POTTING MATERIAL TO FORM A SOLID BLOCK, PCMCIA ELECTRONIC CIRCUITS FOR INSERTION INTO A PORT OF A PERSONAL COMPUTER TO UPLOAD OR DOWNLOAD DATA, ELECTRONIC SOLID-STATE ENCODER INTERFACE CIRCUITS, SOLID-STATE ELECTRONIC POSITION SENSOR INTERFACE CIRCUITS, SOLID-STATE CIRCUITS FOR INTERFACING ELECTRONIC HARDWARE IN AN AIRCRAFT TO A DATA BUS, ELECTRONIC DATA BUS ANALYZERS FOR LOCATING AND IDENTIFYING PROBLEMS IN A DATA BUS, ELECTRONIC DATA LOADERS FOR LOADING DATA INTO AN AIRCRAFT, ELECTRONIC MULTIPLEXERS FOR COMBINING DATA FROM A LARGE NUMBER OF INPUTS INTO ONE OUTPUT, DC-DC CONVERTERS FOR CONVERTING A DC INPUT OF A GIVEN LEVEL INTO A DC OUTPUT OF A DIFFERENT GIVEN LEVEL, ELECTRONIC MOTOR DRIVE MODULES FOR CONTROLLING MOTORS AND COMPOSED OF DISCRETE INTEGRATED CIRCUITS INTEGRATED TOGETHER INTO ONE SOLID SUBSTRATE BLOCK (U.S. CLS. 21, 23, 26, 36 AND 38).

FIRST USE 5-18-1999; IN COMMERCE 5-18-1999.

CLASS 9—(Continued).

2,571,823. INTERACTIVE TRAINING, INC., BALTIMORE, MD. SN 75-660,223. PUB. 6-27-2000, FILED 3-17-1999.

SCANS2000

FOR COMPUTER PROGRAMS FOR USE IN INSTRUCTING STUDENTS IN THE DEVELOPMENT OF WORKPLACE SKILLS FOR USE BY EDUCATIONAL INSTITUTIONS AND OTHER PROVIDERS OF WORKFORCE DEVELOPMENT PROGRAMS IN THE AREA OF WORKFORCE SKILLS AND CAREER DEVELOPMENT TOGETHER WITH INSTRUCTIONAL USER MANUALS (U.S. CLS. 21, 23, 26, 36 AND 38).

FIRST USE 1-1-2001; IN COMMERCE 1-1-2001.

2,571,829. CATAPULT COMMUNICATIONS CORPORATION, MOUNTAIN VIEW, CA. SN 75-670,809. PUB. 9-19-2000, FILED 3-29-1999.

DCT2000

FOR TELECOMMUNICATIONS TEST PLATFORM THAT OPERATES ON A PCI-BUS WORKSTATION, ALLOWING EXPANSION WITH MULTIPLE INTERFACE CARDS, AND COMPRISED OF ENCODERS, DECODERS, AND STATEMACHINES THAT IMPLEMENT INTERNATIONAL TELECOMMUNICATIONS PROTOCOLS AND VARIANTS THEREBY ALLOWING THE USER TO CREATE A NUMBER OF TELECOMMUNICATION TEST APPLICATIONS (U.S. CLS. 21, 23, 26, 36 AND 38).

FIRST USE 11-15-1999; IN COMMERCE 11-15-1999.

2,571,830. CHAMBERLAND, EUGENE G., BRANDON, VT. SN 75-671,219. PUB. 7-18-2000, FILED 3-29-1999.

ORDINARY JOE

FOR PRE-RECORDED VIDEO CASSETTE TAPES FEATURING INFORMATIONAL AND EDUCATIONAL SUBJECT MATTER ON A VARIETY SUBJECTS, NAMELY, HUNTING, FISHING, SIGHTSEEING AND COOKING (U.S. CLS. 21, 23, 26, 36 AND 38).

FIRST USE 9-20-2001; IN COMMERCE 9-22-2001.

CLASS 9—(Continued).

2,571,832. PCT INTERNATIONAL, INC., GILBERT, AZ, BY ASSIGNMENT PHOENIX COMMUNICATION TECHNOLOGIES INTERNATIONAL, GILBERT, AZ. SN 75-675,590. PUB. 5-9-2000, FILED 4-29-1999.

The drop solution

NO CLAIM IS MADE TO THE EXCLUSIVE RIGHT TO USE "DROP", APART FROM THE MARK AS SHOWN.

FOR ELECTRONIC PRODUCTS FOR THE TELECOMMUNICATIONS INDUSTRY, NAMELY, COAXIAL CABLE CONNECTORS AND ADAPTERS; COMMUNITY ANTENNA TELEVISION, CATV, SPLITTERS AND TAPS; CATV DISTRIBUTION AMPLIFIERS; FIBER OPTIC TRANSMITTERS AND RECEIVERS; AND SATELLITE SPLITTERS, TAPS, AND MULTI-SWITCHES (U.S. CLS. 21, 23, 26, 36 AND 38).

FIRST USE 5-0-1999; IN COMMERCE 5-0-1999.

2,571,833. FANTASTIC CORPORATION, THE, CH-6928 LUGANO-MANNO, SWITZERLAND, BY ASSIGNMENT; BY ASSIGNMENT STARBURST COMMUNICATIONS CORP., CONCORD, MA. SN 75-675,901. PUB. 8-1-2000, FILED 4-6-1999.

AUTOCAST

FOR SOFTWARE DEVELOPER TOOLKITS FOR USE IN PRODUCING SOFTWARE APPLICATIONS IN THE AREA OF DATA TRANSFER (U.S. CLS. 21, 23, 26, 36 AND 38).

FIRST USE 0-0-1995; IN COMMERCE 0-0-1995.

2,571,837. HONEYWELL INTERNATIONAL INC., MORRISTOWN, NJ. SN 75-688,580. PUB. 10-31-2000, FILED 4-21-1999.

POWERTRAK

FOR ELECTRONIC CONTROLLER AND SOFTWARE FOR MONITORING VOLTAGE, CURRENT AND TEMPERATURE OF BATTERIES (U.S. CLS. 21, 23, 26, 36 AND 38).

FIRST USE 6-30-1999; IN COMMERCE 6-30-1999.

2,571,839. ADVANCED DATA SOLUTIONS, INC., HOUSTON, TX. SN 75-692,925. PUB. 8-8-2000, FILED 4-28-1999.

REBEL

FOR COMPUTER HARDWARE, COMPUTER SOFTWARE AND INSTRUCTIONAL MATERIALS ASSOCIATED THEREWITH AS A UNIT FOR USE IN GEOPHYSICAL APPLICATIONS (U.S. CLS. 21, 23, 26, 36 AND 38).

FIRST USE 6-23-2000; IN COMMERCE 6-23-2000.

CLASS 9—(Continued).

2,571,842. CLEARMARK, INC., SYRACUSE, NY. SN 75-698,963. PUB. 7-18-2000, FILED 5-6-1999.

CLEARMARK

FOR GENERAL PURPOSE DATABASE MANAGEMENT SOFTWARE; COMPUTER SOFTWARE FOR DESIGNING AND MAINTAINING WEBSITES; AND BUSINESS MANAGEMENT COMPUTER SOFTWARE FOR DEADLINE TRACKING, PROJECT MANAGEMENT AND INTRA-OFFICE COMMUNICATIONS FOR USE IN A VARIETY OF BUSINESS ENVIRONMENTS (U.S. CLS. 21, 23, 26, 36 AND 38).

FIRST USE 4-6-1998; IN COMMERCE 9-19-1999.

2,571,852. DELAWARE CAPITAL FORMATION, INC., WILMINGTON, DE. SN 75-711,658. PUB. 2-15-2000, FILED 5-21-1999.

BANTAM

FOR ELECTRICAL TEST PROBES USED IN THE AUTOMATIC FAULT TESTING OF CIRCUIT BOARDS AND INTEGRATED CIRCUITS (U.S. CLS. 21, 23, 26, 36 AND 38).

FIRST USE 8-15-2001; IN COMMERCE 8-15-2001.

2,571,855. NORTHERN STAR INDUSTRIES, INC., IRON MOUNTAIN, MI, BY CHANGE OF NAME M.J. ELECTRIC, INC., IRON MOUNTAIN, MI. SN 75-713,898. PUB. 12-12-2000, FILED 5-25-1999.

SMARTTOUCH

FOR ELECTRONIC CONTROLS FOR VEHICLE MOUNTED SNOW PLOWS (U.S. CLS. 21, 23, 26, 36 AND 38).

FIRST USE 11-12-2001; IN COMMERCE 11-12-2001.

2,571,869. DANA INNOVATIONS, SAN CLEMENTE, CA. SN 75-733,239. PUB. 5-1-2001, FILED 6-21-1999.

SONANCE SYMPHONY

OWNER OF U.S. REG. NOS. 1,429,672, 2,409,228, AND OTHERS.

SEC. 2(F).

FOR IN-WALL AUDIO SPEAKERS AND IN-CEILING AUDIO SPEAKERS (U.S. CLS. 21, 23, 26, 36 AND 38).

FIRST USE 9-7-1999; IN COMMERCE 9-7-1999.

CLASS 9—(Continued).

2,571,880. 911 EMERGENCY PRODUCTS, INC., ST. CLOUD, MN. SN 75-753,561. PUB. 5-2-2000, FILED 7-19-1999.



NO CLAIM IS MADE TO THE EXCLUSIVE RIGHT TO USE "911", APART FROM THE MARK AS SHOWN. FOR ELECTRIC EMERGENCY WARNING LIGHTS (U.S. CLS. 21, 23, 26, 36 AND 38). FIRST USE 6-0-1999; IN COMMERCE 6-0-1999.

2,571,882. ADAPTEC, INC., MILPITAS, CA. SN 75-754,791. PUB. 4-18-2000, FILED 7-12-1999.

TAKE TWO

FOR COMPUTER PROGRAM FOR COMPUTER BACKUP AND DISASTER RECOVERY PURPOSES AND USER MANUALS SOLD AS A UNIT THEREWITH (U.S. CLS. 21, 23, 26, 36 AND 38). FIRST USE 8-1-1999; IN COMMERCE 9-1-1999.

2,571,892. CANON KABUSHIKI KAISHA, TOKYO, JAPAN. SN 75-767,062. PUB. 3-28-2000, FILED 8-3-1999.

FILMGET

FOR DRIVER SOFTWARE FOR SCANNERS (U.S. CLS. 21, 23, 26, 36 AND 38). FIRST USE 4-0-1999; IN COMMERCE 5-0-1999.

2,571,915. 911 EMERGENCY PRODUCTS, INC., ST. CLOUD, MN. SN 75-810,838. PUB. 8-22-2000, FILED 9-29-1999.



NO CLAIM IS MADE TO THE EXCLUSIVE RIGHT TO USE "TRAFFIC DIRECTOR", APART FROM THE MARK AS SHOWN. FOR ELECTRIC EMERGENCY WARNING LIGHTS (U.S. CLS. 21, 23, 26, 36 AND 38). FIRST USE 6-0-1999; IN COMMERCE 6-0-1999.

CLASS 9—(Continued).

2,571,916. PRO-CAD SOFTWARE, LTD., CALGARY, ALBERTA, CANADA. SN 75-811,164. PUB. 4-10-2001, FILED 9-29-1999.

3DSMART

FOR COMPUTER SOFTWARE FOR COMPUTER-ASSISTED DESIGN AND DRAFTING, AND INSTRUCTIONAL MANUALS USED AND SOLD AS A UNIT THEREWITH; COMPUTER SOFTWARE FOR TWO AND THREE-DIMENSIONAL COMPUTER-ASSISTED DESIGN, DRAFTING, AND MODELING; COMPUTER SOFTWARE FOR COMPUTER-ASSISTED DESIGN, ANIMATION, GRAPHICS, SCHEMATICS AND MODELING; COMPUTER SOFTWARE FOR DESIGNING ELECTRICAL SCHEMATICS AND LAYOUTS, PIPING AND INSTRUMENTATION DIAGRAMS, ISOMETRIC DRAWINGS, AND PIPING PLANS AND ELEVATIONS; COMPUTER SOFTWARE FOR TECHNICAL DATA, WORKFLOW, AND MATERIAL MANAGEMENT IN THE FIELD OF ENGINEERING DESIGN AND DRAFTING (U.S. CLS. 21, 23, 26, 36 AND 38). FIRST USE 2-7-2001; IN COMMERCE 2-7-2001.

2,571,925. LILLY SOFTWARE ASSOCIATES, INC., HAMPTON, NH. SN 75-823,783. PUB. 4-17-2001, FILED 10-15-1999.

VISUAL FRONT OFFICE

NO CLAIM IS MADE TO THE EXCLUSIVE RIGHT TO USE "FRONT OFFICE", APART FROM THE MARK AS SHOWN. FOR COMPUTER SOFTWARE USED BY MANUFACTURING AND DISTRIBUTING BUSINESSES TO TRACK AND MANAGE CUSTOMERS AND PROSPECTIVE CUSTOMERS, ESTIMATES, QUOTES, CONTRACTS, ORDERS, WORK ORDERS, SERVICE CALLS, SERVICE OPERATIONS, AND OTHER CUSTOMER SERVICE DEMANDS (U.S. CLS. 21, 23, 26, 36 AND 38). FIRST USE 6-0-2000; IN COMMERCE 6-0-2000.

2,571,930. MIDWAY HOME ENTERTAINMENT INC., CHICAGO, IL. SN 75-831,303. PUB. 4-25-2000, FILED 10-25-1999.

ARCTIC THUNDER

FOR COMPUTER AND VIDEO GAME PROGRAMS IN THE FORM OF CARTRIDGES, DISCS, CD ROMS, CASSETTES AND TAPES (U.S. CLS. 21, 23, 26, 36 AND 38). FIRST USE 9-18-2001; IN COMMERCE 9-18-2001.

CLASS 9—(Continued).

2,571,937. RED HAT, INC., DURHAM, NC. SN 75-842,106.
PUB. 4-24-2001, FILED 11-6-1999.

EL/IX

FOR COMPUTER SOFTWARE FOR USE IN COMPUTER PROGRAMMING TO ENABLE EMBEDDED SOFTWARE AND DEVICES TO INTERFACE WITH OTHER SOFTWARE, INCLUDING OPERATING SYSTEM SOFTWARE AND APPLICATIONS SOFTWARE (U.S. CLS. 21, 23, 26, 36 AND 38).

FIRST USE 9-0-1999; IN COMMERCE 9-0-1999.

2,571,943. BACOU USA SAFETY, INC., SMITHFIELD, RI. SN 75-849,441. PUB. 7-18-2000, FILED 11-16-1999.

SHARP-SHOOTER

FOR SAFETY EYEWEAR, NAMELY, SPECTACLES, EYEGASS FRAMES, AND LENSES THEREFOR (U.S. CLS. 21, 23, 26, 36 AND 38).

FIRST USE 1-8-2000; IN COMMERCE 1-8-2000.

2,571,952. TRIALTRAC, INC., W. HOLLYWOOD, CA. SN 75-860,187. PUB. 8-15-2000, FILED 12-13-1999.

TRIALWORKS

FOR COMPUTER SOFTWARE PROVIDING PROJECT TRACKING, REPORTING, FINANCIAL MANAGEMENT AND DOCUMENT MANAGEMENT FUNCTIONS IN THE FIELD OF PHARMACEUTICAL, BIOTECHNICAL AND CLINICAL RESEARCH (U.S. CLS. 21, 23, 26, 36 AND 38).

FIRST USE 1-3-2000; IN COMMERCE 1-18-2000.

2,571,971. BOSE CORPORATION, FRAMINGHAM, MA. SN 75-882,120. PUB. 9-5-2000, FILED 12-28-1999.

DIGITAL WITH A DIFFERENCE

FOR SOUND SYSTEM, NAMELY, LOUDSPEAKER SYSTEM, POWER AMPLIFIER AND AT LEAST ONE OF A RADIO TUNER, CD PLAYER AND TAPE PLAYER, AND COMPONENTS THEREOF (U.S. CLS. 21, 23, 26, 36 AND 38).

FIRST USE 12-0-2001; IN COMMERCE 12-0-2001.

CLASS 9—(Continued).

2,571,976. STEVIES, INC., LONG ISLAND CITY, NY. SN 75-885,686. PUB. 4-17-2001, FILED 1-4-2000.



FOR EYEWEAR; NAMELY, EYEGASSES, SUNGLASSES, EYEGASS AND SUNGLASS CASES (U.S. CLS. 21, 23, 26, 36 AND 38).

FIRST USE 7-0-2000; IN COMMERCE 7-0-2000.

2,571,981. SCHOOLBENCH.COM, LLC, CHEVY CHASE, MD. SN 75-890,421. PUB. 8-29-2000, FILED 1-10-2000.

SCHOOLBENCH

FOR COMPUTER DATABASE MANAGEMENT SOFTWARE FOR USE BY EDUCATIONAL INSTITUTIONS IN THE AREAS OF THE ADMINISTRATIVE OFFICE, ADMISSIONS AND ACADEMIC RECORDS, FINANCIAL DEVELOPMENT THROUGH TUITION, CAMPAIGNS AND AUCTIONS, DOCUMENT RETRIEVAL, LIBRARY ADMINISTRATION, EVENT MANAGER, AND CONFERENCE SCHEDULING (U.S. CLS. 21, 23, 26, 36 AND 38).

FIRST USE 1-20-2000; IN COMMERCE 1-20-2000.

2,571,986. IDENTIX INCORPORATED, LOS GATOS, CA. SN 75-895,939. PUB. 1-30-2001, FILED 1-12-2000.

BIOTOUCH

FOR FINGER PRINT READERS (U.S. CLS. 21, 23, 26, 36 AND 38).

FIRST USE 6-30-2000; IN COMMERCE 6-30-2000.

2,571,988. INDIAN HEAD INDUSTRIES, CHARLOTTE, NC. SN 75-898,513. PUB. 5-22-2001, FILED 1-19-2000.

E-STROKE

FOR MONITORING SYSTEM FOR VEHICLE BRAKE ACTUATORS COMPOSED PRIMARILY OF SLEEVES, SENSORS, SWITCHES AND DISPLAY (U.S. CLS. 21, 23, 26, 36 AND 38).

FIRST USE 6-4-2001; IN COMMERCE 6-4-2001.

CLASS 9—(Continued).

2,571,991. MIMNAUGH, GARY, LAKE OSWEGO, OR. SN 75-900,837. PUB. 10-24-2000, FILED 1-21-2000.

GO DOOR

NO CLAIM IS MADE TO THE EXCLUSIVE RIGHT TO USE "DOOR", APART FROM THE MARK AS SHOWN.
FOR ELECTRONICALLY POWERED DOOR-OPENING AND CLOSING UNITS (U.S. CLS. 21, 23, 26, 36 AND 38).
FIRST USE 1-14-2002; IN COMMERCE 1-14-2002.

2,571,992. J.W. HARRIS CO., INC., MASON, OH. SN 75-902,798. PUB. 11-7-2000, FILED 1-25-2000.

AUTOSHADE

FOR LENS FOR WELDERS' HOODS AND GOGGLES (U.S. CLS. 21, 23, 26, 36 AND 38).
FIRST USE 11-7-2001; IN COMMERCE 11-7-2001.

2,571,994. DYNAMIC TECHNOLOGIES, INC., DBA OCEAN SYSTEMS, BURTONSVILLE, MD. SN 75-905,111. PUB. 10-17-2000, FILED 1-21-2000.

DPLEX

FOR COMPUTER SOFTWARE USED TO DE-MULTI-PLEX, DE-MUX OR DE-SEQUENCE MULTIPLEXED VIDEO (U.S. CLS. 21, 23, 26, 36 AND 38).
FIRST USE 9-1-1999; IN COMMERCE 9-1-1999.

2,572,000. OVERMAN, KATHLEEN, J., NORFOLK, VA. SN 75-910,557. PUB. 10-24-2000, FILED 1-29-2000.

EARTH'SREMEDY

FOR HOMEOPATHY COMPUTER SOFTWARE FOR USE IN PROVIDING INFORMATION ABOUT HOMEOPATHIC REMEDIES (U.S. CLS. 21, 23, 26, 36 AND 38).
FIRST USE 12-1-1999; IN COMMERCE 4-1-2000.

CLASS 9—(Continued).

2,572,002. MOLECULARWARE, INC., CAMBRIDGE, MA. SN 75-914,752. PUB. 5-15-2001, FILED 2-10-2000.

DIGITALGENOME

FOR COMPUTER SOFTWARE FOR MEDICAL DIAGNOSIS AND SCIENTIFIC RESEARCH, NAMELY, FOR USE IN PROCESSING DATA FROM BIOLOGICAL MEASUREMENT INSTRUMENTS AND FOR USE IN CREATING AND INTERPRETING DATABASES OF MEDICAL AND SCIENTIFIC DATA; COMPUTER-READABLE STORAGE MEDIA CONTAINING COMPUTER SOFTWARE FOR USE IN PROCESSING DATA FROM BIOLOGICAL MEASUREMENT INSTRUMENTS, AND FOR USE IN CREATING AND INTERPRETING DATABASES OF MEDICAL AND SCIENTIFIC RESEARCH DATA (U.S. CLS. 21, 23, 26, 36 AND 38).
FIRST USE 2-0-1999; IN COMMERCE 1-0-2000.

2,572,004. ACCO WORLD CORPORATION, LINCOLNSHIRE, IL. SN 75-916,968. PUB. 6-5-2001, FILED 2-10-2000.

ASTROPACK

FOR CARRYING CASES FOR COMPUTERS AND COMPUTER ACCESSORIES (U.S. CLS. 21, 23, 26, 36 AND 38).
FIRST USE 5-1-2000; IN COMMERCE 5-1-2000.

2,572,019. PERKINELMER INSTRUMENTS LLC, NORWALK, CT. SN 75-939,470. PUB. 10-24-2000, FILED 3-9-2000.

TOTALCHROM

FOR COMPUTER SOFTWARE FOR DATA ACQUISITION, FOR USE WITH CHROMATOGRAPHY INSTRUMENTS (U.S. CLS. 21, 23, 26, 36 AND 38).
FIRST USE 2-28-2001; IN COMMERCE 2-28-2001.

2,572,022. AVID TECHNOLOGY, INC., TEWKSBURY, MA. SN 75-942,397. PUB. 8-7-2001, FILED 3-13-2000.

XSI

FOR COMPUTER PROGRAMS AND DATA FORMATS FOR THE DEVELOPMENT AND DELIVERY OF COMPUTER GRAPHICS, LINEAR AND INTERACTIVE ANIMATION AND SIMULATION FOR USE IN CREATING, EDITING, AND FINISHING MEDIA PROJECTS FOR FILMS, BROADCASTS AND GAMES PRODUCTION (U.S. CLS. 21, 23, 26, 36 AND 38).
FIRST USE 5-30-2000; IN COMMERCE 5-30-2000.

CLASS 9—(Continued).

2,572,029. PLANALYTICS, INC., WAYNE, PA, BY CHANGE OF NAME STRATEGIC WEATHER SERVICES, INC., WAYNE, PA. SN 75-979,018. PUB. 5-1-2001, FILED 6-25-1999.

PLANALYTICS

FOR COMPUTER SOFTWARE FOR USE IN DATABASE MANAGEMENT, PLANNING AND REPLENISHMENT CONCERNING WEATHER IMPACT AND OTHER EXTERNAL VARIABLES ON CONSUMER DEMANDS (U.S. CLS. 21, 23, 26, 36 AND 38).

FIRST USE 8-18-1999; IN COMMERCE 8-18-1999.

2,572,033. DISCOVERY COMMUNICATIONS, INC., DBA THE DISCOVERY CHANNEL, BETHESDA, MD. SN 75-981,823. PUB. 6-30-1998, FILED 6-6-1996.

INVENTION

OWNER OF U.S. REG. NO. 1,814,104.
FOR PRE-RECORDED AUDIO AND VIDEO CASSETTES, READ ONLY MEMORY COMPACT DISC (CD-ROMS), FEATURING TOPICS REGARDING NEW TECHNOLOGIES AND DISCOVERIES; COMPUTER SOFTWARE GAMES; VIDEO GAME DISKS AND CARTRIDGES (U.S. CLS. 21, 23, 26, 36 AND 38).

FIRST USE 12-31-1990; IN COMMERCE 12-31-1990.

2,572,036. GEODIGM CORPORATION, CHANHASSEN, MN, BY CHANGE OF NAME HULTGREN, BRUCE, VICTORIA, MN. SN 75-981,862. PUB. 8-31-1999, FILED 3-11-1997.

E-MODEL

FOR COMPUTER SOFTWARE FOR USE IN CONJUNCTION WITH ELECTRONIC SCANNING DEVICES FOR MANIPULATING, STORING AND TRANSMITTING IMAGES AND IMAGE DATA; ALL FOR USE IN THE MEDICAL, BIOMEDICAL AND DENTAL FIELDS (U.S. CLS. 21, 23, 26, 36 AND 38).

FIRST USE 1-29-2001; IN COMMERCE 4-1-2001.

2,572,055. SIGNET SCIENTIFIC COMPANY, EL MONTE, CA. SN 76-020,262. PUB. 11-21-2000, FILED 4-5-2000.

PROCESSPRO

FOR ELECTRICAL INSTRUMENTS - NAMELY, MONITORS AND CONTROLLERS FOR PH/ORP SENSORS; MONITORS AND CONTROLLERS FOR FLUID CONDUCTIVITY SENSORS; MONITORS AND CONTROLLERS FOR TEMPERATURE SENSORS; MONITORS AND CONTROLLERS FOR PRESSURE SENSORS; MONITORS, CONTROLLERS AND ACCUMULATORS FOR LIQUID FLOW SENSORS; MONITORS, CONTROLLERS AND ACCUMULATORS FOR GAS FLOW SENSORS; AND MONITORS AND CONTROLLERS FOR LIQUID LEVEL SENSORS (U.S. CLS. 21, 23, 26, 36 AND 38).

FIRST USE 10-10-2001; IN COMMERCE 10-10-2001.

CLASS 9—(Continued).

2,572,065. TELICA, INC., MARLBORO, MA. SN 76-035,087. PUB. 5-1-2001, FILED 4-20-2000.



FOR TELECOMMUNICATIONS EQUIPMENT, NAMELY, LINE INTERFACING CARDS, TRUNK INTERFACE CARDS AND ELECTRONIC SWITCHES (U.S. CLS. 21, 23, 26, 36 AND 38).

FIRST USE 5-0-1999; IN COMMERCE 5-0-1999.

2,572,066. TELICA, INC., MARLBORO, MA. SN 76-035,088. PUB. 8-28-2001, FILED 4-20-2000.



FOR TELECOMMUNICATIONS EQUIPMENT, NAMELY, LINE INTERFACING CARDS, TRUNK INTERFACE CARDS AND ELECTRONIC SWITCHES (U.S. CLS. 21, 23, 26, 36 AND 38).

FIRST USE 1-0-1999; IN COMMERCE 1-0-1999.

2,572,068. PRI AUTOMATION, INC., BILLERICA, MA. SN 76-038,220. PUB. 4-24-2001, FILED 5-2-2000.

GUARDIAN

FOR STORAGE VAULT FOR CONTAINING SEMICONDUCTOR RETICLES (U.S. CLS. 21, 23, 26, 36 AND 38).

FIRST USE 7-10-2000; IN COMMERCE 7-10-2000.

CLASS 9—(Continued).

2,572,069. AKAMBA CORPORATION, LOS GATOS, CA. SN 76-038,558. PUB. 5-29-2001, FILED 4-27-2000.



FOR COMPUTER HARDWARE AND SOFTWARE TO INCREASE THE CAPACITY OF WEB SERVERS (U.S. CLS. 21, 23, 26, 36 AND 38).
FIRST USE 7-3-2001; IN COMMERCE 7-3-2001.

2,572,078. DELAWARE CAPITAL FORMATION, INC., WILMINGTON, DE. SN 76-051,263. PUB. 6-12-2001, FILED 5-18-2000.

GLOBAL HYDRAULIC SYSTEMS

NO CLAIM IS MADE TO THE EXCLUSIVE RIGHT TO USE "HYDRAULIC SYSTEMS", APART FROM THE MARK AS SHOWN.

FOR ELECTRIC POWER PACK FOR USE WITH HYDRAULICALLY OPERATED AUTOMOTIVE LIFTS (U.S. CLS. 21, 23, 26, 36 AND 38).
FIRST USE 10-1-2001; IN COMMERCE 10-1-2001.

2,572,080. SCIENTIFIC TECHNOLOGIES INCORPORATED, FREMONT, CA. SN 76-053,691. PUB. 10-9-2001, FILED 5-22-2000.

QUADSAFE

FOR SAFETY LIGHT CURTAINS AND CONTROL MODULES FOR CONTROLLING SAFETY LIGHT CURTAINS, BOTH USE IN PROTECTING WORKERS FROM INJURY AROUND AND DURING THE OPERATION OF MANUALLY OPERATED MACHINES, NAMELY PUNCH PRESSES, WELDING EQUIPMENT, DRILL PRESSES, FORGING MACHINES, DIE CUTTERS, METAL CASTING MACHINES, METAL TUBE AND PLATE BENDING MACHINES, GRINDING MACHINES, LATHES, AND CUTTING, SAWING AND CHOPPING MACHINES, AND EXCLUDING MACHINES FOR THE AUTOMATIC ASSEMBLY OF ELECTRICAL COMPONENTS (U.S. CLS. 21, 23, 26, 36 AND 38).
FIRST USE 6-13-2000; IN COMMERCE 6-13-2000.

CLASS 9—(Continued).

2,572,084. BALANCE SPECIALTIES, INC., CHICAGO, IL. SN 76-060,450. PUB. 2-27-2001, FILED 5-31-2000.

IF IT SPINS, WE BALANCE IT!

FOR MACHINES FOR BALANCING TIRES AND ROTORS (U.S. CLS. 21, 23, 26, 36 AND 38).
FIRST USE 8-0-2000; IN COMMERCE 8-0-2000.

2,572,085. OLY HOLIGAN, L.P., DALLAS, TX. SN 76-062,115. PUB. 3-27-2001, FILED 6-2-2000.

MH2BUILD

FOR COMPUTER SOFTWARE THAT INTEGRATES AND AUTOMATES RESIDENTIAL HOME CONSTRUCTION WORKFLOW SCHEDULES AND PURCHASE ORDER PROCESSING FOR CONSTRUCTION MATERIALS VIA A GLOBAL COMPUTER NETWORK (U.S. CLS. 21, 23, 26, 36 AND 38).
FIRST USE 2-9-2001; IN COMMERCE 2-9-2001.

2,572,091. KAZOO3D PLC, SHEFFIELD S10 2LJ, UNITED KINGDOM. SN 76-068,727. PUB. 4-17-2001, FILED 6-12-2000.

KAZOOPICTURE

FOR COMPUTER GRAPHICS PROGRAMS USED IN TWO AND THREE DIMENSIONAL MODELING, AND IN CREATING, EDITING AND MANIPULATING COMPUTER GRAPHICS MODELS (U.S. CLS. 21, 23, 26, 36 AND 38).
FIRST USE 10-0-2000; IN COMMERCE 10-0-2000.

2,572,092. PENN. MICHAEL, LOS ANGELES, CA. SN 76-069,602. PUB. 4-17-2001, FILED 6-14-2000.

MIMEOGRAPH RECORDS

NO CLAIM IS MADE TO THE EXCLUSIVE RIGHT TO USE "RECORDS", APART FROM THE MARK AS SHOWN.
FOR MUSICAL SOUND RECORDINGS (U.S. CLS. 21, 23, 26, 36 AND 38).
FIRST USE 3-1-2000; IN COMMERCE 3-1-2000.

CLASS 9—(Continued).

2,572,094. FRIEDRICH LUTZE GMBH + CO., D-71384 WEINSTADT, FED REP GERMANY. SN 76-070,497. PUB. 4-17-2001, FILED 6-14-2000.

CABLEFIX

FOR CLAMPING FLANGES FOR ELECTRICAL CABLES (U.S. CLS. 21, 23, 26, 36 AND 38).
FIRST USE 12-0-2000; IN COMMERCE 12-0-2000.

2,572,100. ALDI INC., BATAVIA, IL. SN 76-073,548. PUB. 5-15-2001, FILED 6-19-2000.

TEVION

FOR ELECTRONIC APPARATI, NAMELY, AMPLIFIERS, AUDIO RECEIVERS, STEREO TUNERS, TELEVISION SETS, VIDEO CASSETTE RECORDERS AND PLAYERS, RADIOS AND DIGITAL VIDEO DISC PLAYERS (U.S. CLS. 21, 23, 26, 36 AND 38).
FIRST USE 8-31-2000; IN COMMERCE 8-31-2000.

2,572,105. DOUGLAS, CHRISTOPHER J., CULVER CITY, CA. SN 76-078,482. PUB. 4-10-2001, FILED 6-27-2000.

CONCRETE GROOVES

FOR COMPACT DISCS FEATURING ELECTRONIC MUSIC (U.S. CLS. 21, 23, 26, 36 AND 38).
FIRST USE 9-1-2001; IN COMMERCE 9-1-2001.

2,572,117. WIRELESS VALLEY COMMUNICATIONS, INC., BLACKSBURG, VA. SN 76-092,195. PUB. 6-19-2001, FILED 7-19-2000.

SITESPY

OWNER OF U.S. REG. NO. 2,360,957.
FOR COMPUTER HARDWARE AND SOFTWARE FOR THE DISPLAY AND MEASUREMENT OF NETWORK PERFORMANCE PARAMETERS (U.S. CLS. 21, 23, 26, 36 AND 38).
FIRST USE 12-14-2000; IN COMMERCE 12-14-2000.

2,572,125. ILLUMINATION POLYMER TECHNOLOGIES, INC., NAPERVILLE, IL. SN 76-105,009. PUB. 5-1-2001, FILED 8-8-2000.

BATONBRITE

FOR HAND HELD SIGNAL LIGHTS (U.S. CLS. 21, 23, 26, 36 AND 38).
FIRST USE 4-30-2001; IN COMMERCE 4-30-2001.

CLASS 9—(Continued).

2,572,132. UBI SOFT, INC., SAN FRANCISCO, CA. SN 76-114,645. PUB. 7-24-2001, FILED 8-22-2000.

RAYMAN 2 REVOLUTION

FOR ELECTRONIC GAMES, NAMELY, SOFTWARE GAMES RECORDED ON CD-ROM AND DIGITAL VIDEO DISCS FOR COMPUTERS; SOFTWARE GAMES RECORDED ON CD-ROM, DIGITAL VIDEO DISCS, AND CARTRIDGES FOR CONSOLE AND INDIVIDUAL, PORTABLE GAMING SYSTEMS; DOWNLOADABLE GAME SOFTWARE; GAME SOFTWARE FOR USE WITH MOBILE TELEPHONES AND PERSONAL DIGITAL ASSISTANTS (U.S. CLS. 21, 23, 26, 36 AND 38).
FIRST USE 1-31-2001; IN COMMERCE 1-31-2001.

2,572,147. PE CORPORATION, FOSTER CITY, CA. SN 76-143,321. PUB. 6-12-2001, FILED 10-5-2000.

SEQUENCEPRO

FOR COMPUTER SOFTWARE USED IN THE FIELD OF NUCLEIC ACID SEQUENCING, ANALYSIS, AND SYNTHESIS, GENETIC ANALYSIS, POLYMERASE CHAIN REACTION (PCR), PROTEIN AND PEPTIDE SYNTHESIS, GENOMICS, AND LIFE SCIENCE RESEARCH (U.S. CLS. 21, 23, 26, 36 AND 38).
FIRST USE 9-17-2000; IN COMMERCE 9-17-2000.

2,572,158. WILSON, JOHN C., GREENVILLE, PA. AND PISULA, GEORGE, JOHNSTOWN, PA. SN 76-178,574. PUB. 8-7-2001, FILED 12-7-2000.

EASY DARICALC

FOR COMPUTER SOFTWARE FOR USE AS A SPREADSHEET THAT CALCULATES A BALANCED DAIRY FORMULA USING A SIMULTANEOUS EQUATION TO ACHIEVE THE BALANCE (U.S. CLS. 21, 23, 26, 36 AND 38).
FIRST USE 9-29-2000; IN COMMERCE 10-18-2000.

2,572,160. AUTODESK, INC., SAN RAFAEL, CA. SN 76-181,355. PUB. 8-14-2001, FILED 12-14-2000.

GMAX

FOR COMPUTER SOFTWARE, NAMELY UTILITIES AND MODULES FOR CREATING, EDITING, ENHANCING AND AUTHORIZING GAMES AND GAME-RELATED PROGRAMS (U.S. CLS. 21, 23, 26, 36 AND 38).
FIRST USE 10-3-2001; IN COMMERCE 10-3-2001.

CLASS 9—(Continued).

2,572,178. EVEREADY BATTERY COMPANY, INC., ST. LOUIS, MO. SN 76-200,683. PUB. 9-4-2001, FILED 1-26-2001.

RESEAL-A-PACK

FOR BATTERIES (U.S. CLS. 21, 23, 26, 36 AND 38).
FIRST USE 5-4-2001; IN COMMERCE 5-4-2001.

2,572,187. RAINDANCE COMMUNICATIONS, INC., LOUISVILLE, CO. BY CHANGE OF NAME EVOKE COMMUNICATIONS, INC., LOUISVILLE, CO. SN 76-255,126. PUB. 9-11-2001, FILED 5-10-2001.

RAINDANCE

FOR COMPUTER SOFTWARE FOR USE IN THE FIELD OF COMMUNICATIONS, NAMELY FACILITATING REAL-TIME INTERACTION, COMMUNICATION, SHARING OF COMPUTER APPLICATIONS, INFORMATION AND WEB-BROWSING WITH MULTIPLE COMPUTER AND WIRELESS ELECTRONICS USERS THROUGH TRANSMISSION OF AUDIO, VIDEO AND DATA VIA COMPUTER TERMINALS AND WIRELESS MEDIA ALL OVER A GLOBAL COMPUTER NETWORK (U.S. CLS. 21, 23, 26, 36 AND 38).
FIRST USE 5-15-2001; IN COMMERCE 9-13-2001.

2,572,193. SUNBELT SOFTWARE SOLUTIONS, INC., CHATTANOOGA, TN. SN 78-006,965. PUB. 6-12-2001, FILED 5-5-2000.

TBIS

FOR COMPUTER SOFTWARE USED IN THE COLLECTION, PROCESSING, ANALYSIS, AND REPORTING OF BUSINESS RELATED INFORMATION VIA STAND ALONE OR INTERACTION WITH A GLOBAL COMPUTING NETWORK, NAMELY, ACCOUNTING AND TAX PREPARATION, HUMAN RESOURCE MANAGEMENT, ASSET MANAGEMENT, TIME AND BILLING SERVICES, COST ESTIMATING, PROJECT MANAGEMENT, CREDIT REPORTING, PAYROLL DATA COLLECTION AND PROCESSING, WORD AND DOCUMENT PROCESSING, SPREADSHEET APPLICATION, DESKTOP PUBLISHING, PRESENTATION OF GRAPHICS AND THE GRAPHICAL DISPLAY OF DATA, DATABASE APPLICATION DEVELOPMENT, DATA STORAGE AND RETRIEVAL, SYSTEMS SECURITY AND CONTROL, REPORT GENERATORS AND DATA INQUIRY AND INSTRUCTION MANUALS SOLD AS A UNIT THEREWITH (U.S. CLS. 21, 23, 26, 36 AND 38).
FIRST USE 11-15-2001; IN COMMERCE 11-15-2001.

CLASS 9—(Continued).

2,572,198. MILLER, MICHAEL J., VALLEY STREAM, NY. SN 78-022,597. PUB. 5-1-2001, FILED 8-23-2000.



FOR COMPUTER SOFTWARE, NAMELY, PROGRAMS AND COMPONENTS USED BY OTHER PROGRAMS FOR DISPLAYING GRAPHICAL ANIMATIONS AND TEXT INFORMATION ON THE COMPUTER SCREEN, WHILE MONITORING AND REPORTING THE TIMING AND STATUS OF SPECIFIED OPERATIONS IN THE BACKGROUND (U.S. CLS. 21, 23, 26, 36 AND 38).
FIRST USE 9-15-2000; IN COMMERCE 12-27-2001.

CLASS 10—MEDICAL APPARATUS

2,571,718. BARAZZOTTO, ZOT, DBA TETON TECHNOLOGY, XENIA, OH. SN 75-396,252. PUB. 11-17-1998, FILED 11-25-1997.

TETON TECHNOLOGY LTD

NO CLAIM IS MADE TO THE EXCLUSIVE RIGHT TO USE "TECHNOLOGY LTD", APART FROM THE MARK AS SHOWN.
FOR HEARING AIDS (U.S. CLS. 26, 39 AND 44).
FIRST USE 5-22-2001; IN COMMERCE 5-22-2001.

2,571,737. BRANFORD COMPANIES, INC., THE, SUMMERVILLE, SC. SN 75-448,573. PUB. 3-2-1999, FILED 3-11-1998.

THORSKAN

FOR RADIATION-SHIELDING GARMENTS, DRAPES AND CURTAINS FOR USE IN CONJUNCTION WITH X-RAY PROCEDURES (U.S. CLS. 26, 39 AND 44).
FIRST USE 7-16-2001; IN COMMERCE 7-16-2001.

2,571,759. TIARA MEDICAL SYSTEMS, INC., OAK FOREST, IL. SN 75-520,362. PUB. 3-7-2000, FILED 7-16-1998.

COOLCAP

FOR RESPIRATORY HEALTH CARE PRODUCTS NAMELY MULTI-COLORED HEADGEAR WHICH ATTACHES TO RESPIRATORY MASKS, FOR MEDICAL USE (U.S. CLS. 26, 39 AND 44).
FIRST USE 11-0-1998; IN COMMERCE 11-0-1998.

CLASS 10—(Continued).

2,571,777. TIARA MEDICAL SYSTEMS, INC., OAK FOREST, IL. SN 75-579,879. PUB. 1-16-2001, FILED 10-30-1998.

TIARA

FOR RESPIRATORY MASKS FOR MEDICAL USE; CHIN STRAPS, MASK CAPS, FACE MASKS ALL USED AS COMPONENTS PARTS OF RESPIRATORY MASKS FOR MEDICAL USE; CONTINUOUS POSITIVE AIRWAY PRESSURE (CPAP) RESPIRATORY THERAPY SYSTEMS PARTS, NAMELY, TUBING AND FILTERS FOR MEDICAL USE; OXYGEN CONNECTORS FOR USE WITH OXYGEN CONCENTRATORS AND OXYGEN VENTILATORS FOR MEDICAL USE; OXYGEN ENRICHMENT ATTACHMENTS FOR USE WITH OXYGEN CONCENTRATORS AND OXYGEN VENTILATORS FOR MEDICAL USE; OXYGEN "Y" ADAPTERS FOR USE WITH OXYGEN CONCENTRATORS AND OXYGEN VENTILATORS FOR MEDICAL USE; OXYGEN CONCENTRATOR FILTERS FOR USE WITH OXYGEN CONCENTRATORS FOR MEDICAL USE; NEBULIZER FILTERS FOR USE WITH NEBULIZERS FOR MEDICAL USE; BACTERIA FILTERS FOR USE WITH CONTINUOUS POSITIVE AIRWAY PRESSURE (CPAP) UNITS CONCENTRATORS, VENTILATORS, NEBULIZERS FOR MEDICAL USE; HEPA FILTERS FOR USE WITH CONCENTRATORS, VENTILATORS, NEBULIZERS AND CPAP UNITS FOR MEDICAL USE; AND VENTILATOR FILTERS FOR USE WITH MEDICAL VENTILATORS (U.S. CLS. 26, 39 AND 44).

FIRST USE 0-0-1994; IN COMMERCE 0-0-1994.

2,571,796. IHEAR SYSTEMS, DANVILLE, CA. SN 75-614,308. PUB. 7-25-2000, FILED 12-31-1998.

iHEAR

FOR MEDICAL DEVICES, NAMELY, HEARING AIDS, IN-THE-CANAL AND/OR COMPLETELY-IN-THE-CANAL WEARABLE TRANSDUCERS FOR CONVERTING AUDIO SIGNALS TO AUDIBLE VIBRATIONS TO ENHANCE HEARING OF THE WEARER (U.S. CLS. 26, 39 AND 44).

FIRST USE 5-9-2001; IN COMMERCE 5-9-2001.

2,571,804. SIEMIENIEC, JANICE L., PLAINFIELD, IL. SN 75-626,938. PUB. 11-23-1999, FILED 8-17-1998.

CRITTER COLLAR

FOR STETHOSCOPE COVERS (U.S. CLS. 26, 39 AND 44).

FIRST USE 1-5-2001; IN COMMERCE 1-5-2001.

CLASS 10—(Continued).

2,571,861. CYTOLOGIX CORPORATION, CAMBRIDGE, MA. SN 75-721,709. PUB. 10-31-2000, FILED 6-2-1999.

CONSISTENTLY UNIQUE

FOR INSTRUMENTS AND APPARATUS FOR MEDICAL DIAGNOSTIC PURPOSES, NAMELY, FOR CELLULAR ANALYSIS OF TISSUE SAMPLES, NAMELY, INSTRUMENTS FOR AUTOMATING THE STAINING OF TISSUE SAMPLES MOUNTED ON MICROSCOPE SLIDES (U.S. CLS. 26, 39 AND 44).

FIRST USE 12-4-2001; IN COMMERCE 12-4-2001.

2,571,927. INSTRUMENTARIUM SURGICAL CORP, INC., TERREBONNE QUEBEC, CANADA. SN 75-825,003. PUB. 1-23-2001, FILED 11-4-1999.

HAND STABLE

NO CLAIM IS MADE TO THE EXCLUSIVE RIGHT TO USE "HAND", APART FROM THE MARK AS SHOWN.

FOR SURGICAL INSTRUMENTS; NAMELY, FORCEPS, SCISSORS, RETRACTORS, AND CRIMPERS USED IN SINUS, EAR, NOSE AND THROAT SURGERY, WHICH ALLOW OPERATION OF THE INSTRUMENT WHILE RESTING THE LOWER PORTION OF THE SURGEON'S HAND ON THE PATIENT OR TABLE (U.S. CLS. 26, 39 AND 44).

FIRST USE 10-1-1999; IN COMMERCE 10-1-1999.

2,571,984. NIX COMPANY LTD., BUNKYO-KU, TOKYO, JAPAN. SN 75-894,609. PUB. 1-30-2001, FILED 1-11-2000.

ID-TAB

FOR BITE-BLOCK FOR USE IN THE FIELD OF DENTAL X-RAY (U.S. CLS. 26, 39 AND 44).

FIRST USE 11-1-1990; IN COMMERCE 4-15-1993.

2,572,046. CHASE MEDICAL, LP, RICHARDSON, TX. SN 76-008,815. PUB. 1-30-2001, FILED 3-24-2000.

EPRETRACT

FOR MEDICAL DEVICES, NAMELY A HEART STABILIZER FOR USE IN THE FIELD OF CARDIAC SURGERY (U.S. CLS. 26, 39 AND 44).

FIRST USE 5-1-2001; IN COMMERCE 5-1-2001.

2,572,057. QUANTUM BIOENGINEERING, INC., PLANTATION, FL. SN 76-028,295. PUB. 3-27-2001, FILED 4-18-2000.

PROSTHOINTEGRATION

FOR DENTAL PRODUCTS, NAMELY DENTAL IMPLANT'S AND ABUTMENTS (U.S. CLS. 26, 39 AND 44).

FIRST USE 10-26-2000; IN COMMERCE 10-26-2000.

CLASS 10—(Continued).

2,572,088. KERAVISION, INC., FREMONT, CA. SN 76-064,661. PUB. 4-3-2001, FILED 6-7-2000.



FOR CORNEAL IMPLANTS AND INSTRUMENTS FOR IMPLANTING CORNEAL IMPLANTS (U.S. CLS. 26, 39 AND 44).
FIRST USE 4-15-1999; IN COMMERCE 4-15-1999.

2,572,142. DERROYAL INDUSTRIES, INC., POWELL, TN. SN 76-134,752. PUB. 6-5-2001, FILED 9-25-2000.

ULTRALIGN

FOR MEDICAL DEVICES, NAMELY, SPINAL ORTHOSIS (U.S. CLS. 26, 39 AND 44).
FIRST USE 11-0-2000; IN COMMERCE 11-0-2000.

2,572,202. G.W. HEALTHCARE, INC., OAKLAND, FL. SN 78-024,573. PUB. 5-8-2001, FILED 9-6-2000.

PEACOCK

FOR CONDOMS (U.S. CLS. 26, 39 AND 44).
FIRST USE 9-6-2000; IN COMMERCE 10-30-2000.

2,572,233. COLONIAL SURGICAL SUPPLY, INC., LOS ANGELES, CA. SN 78-068,293. PUB. 10-16-2001, FILED 6-9-2001.

PURE GRIP

FOR GLOVES FOR MEDICAL USE (U.S. CLS. 26, 39 AND 44).
FIRST USE 12-15-2001; IN COMMERCE 12-15-2001.

2,572,235. IBI SYNERGY, INC., FREMONT, CA. SN 78-074,091. PUB. 10-30-2001, FILED 7-16-2001.

TRUST

FOR LATEX CONDOMS AND LATEX DENTAL DAM (U.S. CLS. 26, 39 AND 44).
FIRST USE 8-1-2001; IN COMMERCE 1-25-2002.

CLASS 11—ENVIRONMENTAL CONTROL APPARATUS

2,571,707. KVAERNER PROCESS SYSTEMS AS, BILLINGSTAD, NORWAY. SN 75-366,408. PUB. 3-6-2001, FILED 10-1-1997.

G-SEP

FOR SYSTEMS FOR THE SEPARATION AND TREATMENT OF LIQUIDS, GASES AND SOLIDS, NAMELY, CYCLONE SEPARATORS; COMPONENT PARTS, FITTINGS AND ACCESSORIES FOR THE AFORESAID GOODS, NAMELY, HYDRO-CYCLONE TUBES, DIVIDER PLATES AND PRESSURE VESSELS (U.S. CLS. 13, 21, 23, 31 AND 34).
FIRST USE 11-19-1999; IN COMMERCE 11-19-1999.

2,571,741. WAL-MART STORES, INC., BENTONVILLE, AR. SN 75-454,740. PUB. 11-17-1998, FILED 3-23-1998.

MEMBERS MARK

FOR ACETYLENE BURNERS, ACETYLENE FLARES, AIR CONDITIONERS, AIR CONDITIONING UNITS, AIR FILTERS FOR AIR CONDITIONING UNITS, AIR FILTERS FOR DOMESTIC USE, AIR FILTERS FOR INDUSTRIAL INSTALLATIONS, AIR PURIFYING UNITS FOR COMMERCIAL, DOMESTIC, INDUSTRIAL USE, AQUARIUM HEATERS, AQUARIUM LIGHTS, AUTOCLAVES, BARBECUE GRILLS, BATHTUB ENCLOSURES, BATHTUBS, BICYCLE LIGHTS, BIDETS, CERAMIC PLATES SOLD AS PARTS OF OVENS AND STOVES, CHANDELIERS, CLEAN ROOMS, CHIMNEYS FOR OIL LAMPS, CLOTHES DRYERS, COFFEE ROASTING OVENS, COMMERCIAL COOKING OVENS, COMBUSTION CHAMBERS, COOLANT RECOVERY SYSTEMS, COMPRISING RESERVOIRS, PUMPS, FILTERS, CLEANERS, DEHUMIDIFIERS, DESALINATION UNITS, DESICCATING UNITS FOR PRODUCING DRIED FRUITS, DISPENSING UNITS FOR ROOM DEODORANTS, DISTILLING UNITS, DRINKING FOUNTAINS, DRIPPER IRRIGATION SYSTEMS, COMPRISED OF VALVES, FILTERS AND REGULATORS, ELECTRIC FIREPLACE INSERTS, COMPRISED OF ANDIRONS, ARTIFICIAL LOGS AND ARTIFICIAL EMBERS, ELECTRIC LIGHTS FOR CHRISTMAS TREES, EVAPORATIVE AIR COOLING UNITS FOR DOMESTIC USE, FACIAL SAUNAS, FAUCETS, FILAMENTS FOR ELECTRIC LAMPS, FILTERS, HEATERS AND PUMPS SOLD IN COMBINATION FOR USE IN SWIMMING POOLS OR HOT TUBS, FIREPLACE INSERTS IN THE NATURE OF HEAT EXCHANGERS, SOLID FUEL BURNERS, STOVES, FIREPLACES, FLARES, FLASHLIGHTS, FLUORESCENT LIGHTING TUBES, FREEZERS, FURNACE BOILERS, FURNACES, GAS FIREPLACE INSERTS, COMPRISED OF ANDIRONS, ARTIFICIAL LOGS AND ARTIFICIAL EMBERS, GAS LAMPS, GAS RANGES, GAS SCRUBBERS, GAS STOVES, GLASS PLATES SOLD AS PARTS OF STOVES, HEADLIGHTS FOR VEHICLES, HEAT EXCHANGERS, HEAT GUNS, HEAT PUMPS, HOOD FOR RANGES, HOT TUBS, HOT WATER BOTTLES, HOT WATER TANKS, HUMIDIFIERS, HYDRANTS, ICE CUBE MAKING MACHINES, ICE MAKING MACHINES, ICE SKATING RINKS, INCINERATORS, IRRIGATION SPRINKLERS, LAWN SPRINKLER SYSTEMS COMPRISING PUMPS, VALVES AND FILTERS, KEROSENE HEATERS, KILNS, Klieg LIGHTS, LAMP REFLECTORS, LAMP SHADES, LAMPS, LAVATORIES, LIGHTS FOR VEHICLES, MICROWAVE OVENS FOR COOKING, NUCLEAR POWER PLANTS, NUCLEAR REACTORS, OIL LAMPS, OIL LANTERNS, OIL PURIFYING INSTALLATIONS, OVEN GAS IGNITERS, OVEN VENTILATOR HOODS, PEN LIGHTS, PLUMBING FITTINGS, NAMELY BIBBS, COCKS, TRAPS, VALVES, PLUMBING SUPPLIES, NAMELY SINK STRAINERS, PUMPS, FILTERS AND HEATERS SOLD IN COMBINATION FOR USE IN SWIMMING POOLS AND HOT TUBS, RANGE HOODS, REFRAC-

CLASS 11—(Continued).

TORY FURNACES, REFRIGERATED BEVERAGE DISPENSING UNITS, REFRIGERATED MERCHANDISE DISPLAY CASES, REFRIGERATED SHIPPING CONTAINERS, REFRIGERATORS, SAUNAS, SEARCHLIGHTS, SEPARATORS FOR THE CLEANING AND PURIFICATION OF AIR, SEPARATORS FOR THE CLEANING AND PURIFICATION OF GASES, SEWAGE DISPOSAL PLANTS, SEWAGE TREATMENT PLANTS, SHOWER ENCLOSURES, SHOWERHEADS, SHOWERS, SINKS, SOLAR COLLECTORS, SOLAR HEATING PANELS, SPAS IN THE NATURE OF HEATED POOLS, STEAM GENERATORS, STEAM VALVES, STERILIZERS NOT FOR MEDICAL PURPOSES, STRAINERS FOR WATER LINES, SUN LAMPS, SWIMMING POOL CHLORINATING UNITS, SWIMMING POOL WATER CLEANING AND FILTERING UNITS, TOILET SEATS, TOILET TANK BALLS, TOILETS, VEHICLE HEADLIGHTS, VENTILATING FANS FOR COMMERCIAL OR INDUSTRIAL USE, VENTILATING LOUVERS, WARMING PANS, WASTE WATER PURIFICATION UNITS, WATER CLOSETS, WATER CONDITIONING UNITS, WATER COOLERS, WATER DISTILLATION UNITS, WATER FILTERING UNITS FOR DOMESTIC, COMMERCIAL, OR INDUSTRIAL USE, WATER FILTERING UNITS FOR PRODUCING POTABLE WATER FOR DOMESTIC USE, WATER FOUNTAINS, WATER HEATERS FOR DOMESTIC, COMMERCIAL, OR INDUSTRIAL USE, WATER PURIFICATION UNITS, WATER PURIFYING UNITS, FOR POTABLE WATER FOR DOMESTIC, COMMERCIAL, OR INDUSTRIAL USE, WATER SOFTENING UNITS, WHIRLPOOL BATHS, WHIRLPOOL JETS, WHIRLPOOLS, WOOD BURNING STOVES (U.S. CLS. 13, 21, 23, 31 AND 34).

FIRST USE 8-30-2000; IN COMMERCE 8-30-2000.

2,571,749. VIRTUAL RAIN, INC., PLEASANTON, CA. BY ASSIGNMENT KEARBY, MIKE, VISTA, CA. SN 75-487,426. PUB. 7-27-1999, FILED 5-18-1998.

M-PAC

FOR IMPACT SPRINKLERS FOR LANDSCAPE IRRIGATION USE IN THE NATURE OF SPRINKLERS THAT CHANGE DIRECTION OF ROTATION ON IMPACT WITH A PREDETERMINED OBJECT (U.S. CLS. 13, 21, 23, 31 AND 34).

FIRST USE 10-5-1999; IN COMMERCE 10-5-1999.

2,571,872. ZOELLER COMPANY, LOUISVILLE, KY. SN 75-736,808. PUB. 4-18-2000, FILED 6-25-1999.

TRI-CHECK

FOR PLUMBING VALVE SYSTEM, NAMELY A CHECK VALVE, BALL VALVE AND UNION, ALL SOLD AS A UNIT (U.S. CLS. 13, 21, 23, 31 AND 34).

FIRST USE 11-0-1999; IN COMMERCE 11-0-1999.

CLASS 11—(Continued).

2,572,050. NISSEI INDUSTRY CO., LTD., SHIZUOKA 424-0055, JAPAN. SN 76-016,715. PUB. 5-22-2001, FILED 4-4-2000.

B1POLARG

FOR ELECTRIC LAMPS AND LIGHTING FIXTURES; PARTS AND ACCESSORIES FOR MOTOR VEHICLES, MOTORCYCLES, AND BICYCLES, NAMELY LAMP BULBS AND LAMP ASSEMBLIES (U.S. CLS. 13, 21, 23, 31 AND 34).

FIRST USE 12-12-2001; IN COMMERCE 12-12-2001.

2,572,056. L & S ENTERPRISES, INC., LEXINGTON, KY. SN 76-024,395. PUB. 9-25-2001, FILED 4-5-2000.

RV SANI-CON

NO CLAIM IS MADE TO THE EXCLUSIVE RIGHT TO USE "RV", APART FROM THE MARK AS SHOWN.

FOR PUMPS WITH AN INSERT HOSE WITH VALVE FOR USE IN DISPOSING OF WATER AND WASTE WATER FROM RECREATIONAL VEHICLES AND ACCESSORIES THEREFOR, NAMELY, TRANSFER-GRINDERS, ON-OFF SWITCHES WIRING AND DISCHARGE HOSES (U.S. CLS. 13, 21, 23, 31 AND 34).

FIRST USE 9-10-1999; IN COMMERCE 9-10-1999.

2,572,165. HUNTER FAN COMPANY, MEMPHIS, TN. SN 76-185,219. PUB. 8-14-2001, FILED 12-21-2000.

LA COSTA FAN

NO CLAIM IS MADE TO THE EXCLUSIVE RIGHT TO USE "FAN", APART FROM THE MARK AS SHOWN.

THE ENGLISH TRANSLATION OF "LA COSTA" IS "THE COAST".

FOR CEILING FANS (U.S. CLS. 13, 21, 23, 31 AND 34).

FIRST USE 3-30-2001; IN COMMERCE 3-30-2001.

2,572,166. HUNTER FAN COMPANY, MEMPHIS, TN. SN 76-185,221. PUB. 8-14-2001, FILED 12-21-2000.

LA PAZ FAN

NO CLAIM IS MADE TO THE EXCLUSIVE RIGHT TO USE "FAN", APART FROM THE MARK AS SHOWN.

THE ENGLISH TRANSLATION OF "LA PAZ" IS "THE PEACE".

FOR CEILING FANS (U.S. CLS. 13, 21, 23, 31 AND 34).

FIRST USE 4-6-2001; IN COMMERCE 4-6-2001.

CLASS 11—(Continued).

2,572,168. WATER PIK, INC., NEWPORT BEACH, CA. SN 76-186,869. PUB. 8-14-2001, FILED 12-28-2000.

NEW VISIONS

FOR SHOWERHEADS (U.S. CLS. 13, 21, 23, 31 AND 34).
FIRST USE 8-29-2001; IN COMMERCE 8-29-2001.

2,572,170. JOSE JULIO JORDAO, LDA, 4802 GUIMARAES CODEX, PORTUGAL. SN 76-187,524. PUB. 6-26-2001, FILED 12-27-2000.

JORDÃO COOLING SYSTEMS

NO CLAIM IS MADE TO THE EXCLUSIVE RIGHT TO USE "COOLING SYSTEMS", APART FROM THE MARK AS SHOWN.

FOR REFRIGERATORS, AIR CONDITIONERS, AND ELECTRICAL HEATING UNITS (U.S. CLS. 13, 21, 23, 31 AND 34).

FIRST USE 10-4-2001; IN COMMERCE 10-4-2001.

2,572,174. HYDRO-THERMAL CORPORATION, WAUKESHA, WI. SN 76-194,591. PUB. 8-7-2001, FILED 1-12-2001.

HYDROHELIX

FOR HEAT EXCHANGERS (U.S. CLS. 13, 21, 23, 31 AND 34).

FIRST USE 6-29-2001; IN COMMERCE 6-29-2001.

2,572,186. EVEREADY BATTERY COMPANY, INC., ST. LOUIS, MO. SN 76-246,387. PUB. 8-28-2001, FILED 4-25-2001.

ENERGIZER OUTFITTER

OWNER OF U.S. REG. NOS. 1,177,083, 2,044,427, AND OTHERS.

FOR LANTERNS (U.S. CLS. 13, 21, 23, 31 AND 34).
FIRST USE 6-25-2001; IN COMMERCE 6-25-2001.

2,572,188. SALTON, INC., MOUNT PROSPECT, IL. SN 76-267,547. PUB. 10-2-2001, FILED 6-6-2001.

COLORXCHANGE

FOR LIGHTING APPARATUS, NAMELY, DECORATIVE ELECTRIC LAMPS (U.S. CLS. 13, 21, 23, 31 AND 34).

FIRST USE 10-21-2001; IN COMMERCE 10-21-2001.

CLASS 11—(Continued).

2,572,189. MOHON INTERNATIONAL, INC., PARIS, TN. SN 76-277,180. PUB. 10-2-2001, FILED 6-26-2001.

LABSHIELD

FOR FUME HOODS (U.S. CLS. 13, 21, 23, 31 AND 34).
FIRST USE 7-0-2001; IN COMMERCE 8-0-2001.

2,572,196. WHIRLPOOL PROPERTIES, INC., BENTON HARBOR, MI. SN 78-011,832. PUB. 6-26-2001, FILED 6-8-2000.

DUO SYSTEM

OWNER OF U.S. REG. NO. 1,832,110.
NO CLAIM IS MADE TO THE EXCLUSIVE RIGHT TO USE "SYSTEM", APART FROM THE MARK AS SHOWN.

FOR APPLIANCES FOR DOMESTIC USE; NAMELY, ELECTRIC AND GAS COOKING RANGES, OVENS, AND COOKTOPS; EXHAUST HOODS FOR USE WITH ALL THE ABOVE (U.S. CLS. 13, 21, 23, 31 AND 34).

FIRST USE 7-31-2001; IN COMMERCE 7-31-2001.

CLASS 12—VEHICLES

2,571,835. TOYOTA JIDOSHA KABUSHIKI KAISHA, TA TOYOTA MOTOR CORPORATION, TOYOTA-SHI, AICHI 471, JAPAN. SN 75-677,644. PUB. 12-28-1999, FILED 4-7-1999.

EPIC X22

OWNER OF U.S. REG. NO. 2,263,707.
FOR BOATS AND STRUCTURAL PARTS THEREOF (U.S. CLS. 19, 21, 23, 31, 35 AND 44).
FIRST USE 1-19-1999; IN COMMERCE 1-19-1999.

2,571,859. HONDA GIKEN KOGYO KABUSHIKI KAISHA, TA HONDA MOTOR CO., LTD., MINATO-KU, TOKYO, JAPAN. SN 75-719,157. PUB. 5-15-2001, FILED 6-1-1999.

INSIGHT

FOR LAND VEHICLES, NAMELY AUTOMOBILES AND STRUCTURAL PARTS THEREOF (U.S. CLS. 19, 21, 23, 31, 35 AND 44).

FIRST USE 12-0-1999; IN COMMERCE 12-0-1999.

CLASS 12—(Continued).

2,571,985. RIVENDELL BICYCLE WORKS, INC., WALNUT CREEK, CA. SN 75-895,677. PUB. 5-29-2001, FILED 1-12-2000.

ATLANTIS

FOR BICYCLES AND STRUCTURAL PARTS THEREFOR; BICYCLE FRAMES (U.S. CLS. 19, 21, 23, 31, 35 AND 44).

FIRST USE 10-19-2000; IN COMMERCE 10-20-2000.

2,572,026. GRIMALDI, CATHERINE HELEN, KANEOHE, HI. SN 75-945,078. PUB. 1-2-2001, FILED 2-23-2000.

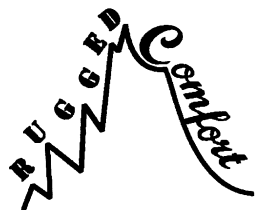

THE MARK CONSISTS IN PART OF A STYLIZED DEPICTION OF A MOUNTAIN.

FOR REMOVABLE INSULATING HEADLINERS FOR LAND VEHICLES WITH NON-PERMANENT TOPS AND ROOFS (U.S. CLS. 19, 21, 23, 31, 35 AND 44).

FIRST USE 4-6-1998; IN COMMERCE 11-6-2000.

2,572,130. MTD PRODUCTS INC, CLEVELAND, OH. SN 76-113,431. PUB. 5-15-2001, FILED 8-21-2000.

TURFGRIP

FOR TIRES FOR LAWN MOWERS, RIDING MOWERS, AND WALK-BEHIND MOWERS (U.S. CLS. 19, 21, 23, 31, 35 AND 44).

FIRST USE 8-0-2001; IN COMMERCE 8-0-2001.

2,572,183. MAZZCO, INC., EUGENE, OR. SN 76-221,480. PUB. 8-28-2001, FILED 3-9-2001.

TENTRAX

FOR RECREATION VEHICLES, NAMELY, TENT TRAILERS, TRAVEL TRAILERS, AND CAMPING TRAILERS (U.S. CLS. 19, 21, 23, 31, 35 AND 44).

FIRST USE 8-25-2001; IN COMMERCE 12-18-2001.

CLASS 13—FIREARMS**CLASS 13—(Continued).**

2,571,825. SPRINGFIELD FIREWORKS, INC., BLUFFTON, OH. SN 75-661,584. PUB. 4-25-2000, FILED 3-15-1999.

CHIEF LONE EAGLE

THE NAME "CHIEF LONE EAGLE" IN THE MARK IDENTIFIES A LIVING INDIVIDUAL WHOSE CONSENT IS OF RECORD.

FOR FIREWORKS (U.S. CLS. 2 AND 9).

FIRST USE 12-1-1999; IN COMMERCE 12-1-1999.

2,571,826. SPRINGFIELD FIREWORKS, INC., BLUFFTON, OH. SN 75-661,585. PUB. 4-25-2000, FILED 3-15-1999.



THE NAME "CHIEF LONE EAGLE" AND THE LIKENESS (OR, "PORTRAIT") IN THE MARK IDENTIFIES A LIVING INDIVIDUAL WHOSE CONSENT IS OF RECORD.

FOR FIREWORKS (U.S. CLS. 2 AND 9).

FIRST USE 12-1-1999; IN COMMERCE 12-1-1999.

CLASS 13—(Continued).

2,571,965. GUILLOT, JOHN C. III, KILN, MS. SN 75-875,406.
PUB. 1-30-2001, FILED 1-3-2000.

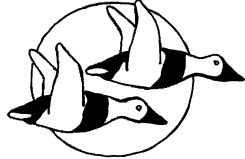
CANVASBACK**Fowl Weather Gear**

THE MARK CONSISTS OF TWO DUCKS WITH MOROON HEADS, BLACK BODIES, & WHITE WINGS, FLYING BEFORE A PALE BLUE MOON.

FOR GUN CASES, GUN BAGS, CARTRIDGE BELTS, GUN SHELL BAGS, GUN SHELL BANDOLIERS, GUN CARRIAGES, GUN SHEATHS, CARTRIDGE SHOT POUCHES, GUN SHELL HOLDERS, GUN CHOKE HOLDERS, GUN SHOTSHELL APRONS, SHOULDER SHOOTING HARNESES, AND GUNSTOCK RECOIL PADS (U.S. CLS. 2 AND 9).

FIRST USE 1-3-2000; IN COMMERCE 1-3-2000.

2,572,162. B.J. ALAN COMPANY, YOUNGSTOWN, OH. SN 76-183,568. PUB. 7-10-2001, FILED 12-19-2000.

MAJESTIC RAINBOW

FOR FIREWORKS (U.S. CLS. 2 AND 9).
FIRST USE 5-8-2001; IN COMMERCE 5-8-2001.

2,572,163. B.J. ALAN COMPANY, YOUNGSTOWN, OH. SN 76-183,570. PUB. 7-10-2001, FILED 12-19-2000.

HURON RAIN

FOR FIREWORKS (U.S. CLS. 2 AND 9).
FIRST USE 5-28-2001; IN COMMERCE 5-28-2001.

CLASS 14—JEWELRY**CLASS 14—(Continued).**

2,571,975. STEVIES, INC., LONG ISLAND CITY, NY. SN 75-885,685. PUB. 4-24-2001, FILED 1-4-2000.



FOR JEWELRY; NAMELY, RINGS, NECKLACES, EARRINGS, BRACELETS, CUFF LINKS AND PENDANTS (U.S. CLS. 2, 27, 28 AND 50).

FIRST USE 7-0-2000; IN COMMERCE 7-0-2000.

2,572,077. MOVADO LLC, WILMINGTON, DE, BY CHANGE OF NAME MOVADO CORPORATION, WILMINGTON, DE. SN 76-051,227. PUB. 1-16-2001, FILED 5-18-2000.

PORTICO

FOR WATCHES (U.S. CLS. 2, 27, 28 AND 50).
FIRST USE 12-0-2000; IN COMMERCE 12-0-2000.

2,572,123. QVC, INC., WEST CHESTER, PA. SN 76-100,685. PUB. 5-8-2001, FILED 8-1-2000.

SILK FIT

NO CLAIM IS MADE TO THE EXCLUSIVE RIGHT TO USE "FIT", APART FROM THE MARK AS SHOWN.
FOR JEWELRY (U.S. CLS. 2, 27, 28 AND 50).
FIRST USE 7-30-2000; IN COMMERCE 7-30-2000.

2,572,214. MEDALLIC ART COMPANY LTD., DAYTON, NV. SN 78-039,328. PUB. 9-11-2001, FILED 12-14-2000.

SportsMint

FOR GOLD, SILVER AND BRONZE COINS AND MEDALS (U.S. CLS. 2, 27, 28 AND 50).
FIRST USE 1-24-2001; IN COMMERCE 1-24-2001.

CLASS 15—MUSICAL INSTRUMENTS

CLASS 15—(Continued).

2,572,070. EVANS MANUFACTURING, LLC, FARMINGDALE, NY. SN 76-041,252. PUB. 2-20-2001, FILED 5-4-2000.



FOR ACCESSORIES FOR MUSICAL INSTRUMENTS, NAMELY, GUITAR STRAPS, CABLES, PEG WINDERS, HUMIDIFIERS AND STRINGS (U.S. CLS. 2, 21 AND 36). FIRST USE 9-1-1999; IN COMMERCE 9-1-1999.

2,572,156. YAMAHA CORPORATION, HAMAMATSU-SHI, SHIZUOKA, JAPAN. SN 76-166,751. PUB. 6-26-2001, FILED 11-16-2000.

MOTIF

FOR MUSICAL INSTRUMENTS, NAMELY, ELECTRONIC KEYED INSTRUMENTS, MUSIC SYNTHESIZERS (U.S. CLS. 2, 21 AND 36).

FIRST USE 6-4-2001; IN COMMERCE 6-4-2001.

CLASS 16—PAPER GOODS AND PRINTED MATTER

2,571,782. MENDLOWITZ WEITSEN, LLP, CPAS, EAST BRUNSWICK, NJ. SN 75-593,381. PUB. 11-2-1999, FILED 11-23-1998.

YOURPORT

FOR BOOKLETS FEATURING FINANCIAL INFORMATION FOR BUSINESS OWNERS (U.S. CLS. 2, 5, 22, 23, 29, 37, 38 AND 50).

FIRST USE 6-22-1999; IN COMMERCE 6-22-1999.

2,571,824. INTERACTIVE TRAINING, INC., BALTIMORE, MD. SN 75-660,224. PUB. 7-18-2000, FILED 3-17-1999.

SCANS2000

FOR WORKBOOKS AND PRINTED INSTRUCTIONAL MATERIALS IN THE FIELD OF WORKFORCE SKILLS AND CAREER DEVELOPMENT FOR USE IN CONNECTION WITH COMPUTER LEARNING PROGRAMS (U.S. CLS. 2, 5, 22, 23, 29, 37, 38 AND 50).

FIRST USE 1-1-2001; IN COMMERCE 1-1-2001.

CLASS 16—(Continued).

2,571,909. NEW ENGLAND ART PUBLISHERS, INC., NORTH ABINGTON, MA. SN 75-799,011. PUB. 4-25-2000, FILED 9-14-1999.

EVERLASTING LOVE COLLECTION

NO CLAIM IS MADE TO THE EXCLUSIVE RIGHT TO USE "COLLECTION", APART FROM THE MARK AS SHOWN.

FOR PRINTED WEDDING INVITATIONS, PAPER IDENTIFICATION TAGS, NOTE CARDS, PLACE CARDS AND PAPER NAPKINS (U.S. CLS. 2, 5, 22, 23, 29, 37, 38 AND 50).

FIRST USE 1-8-2000; IN COMMERCE 1-8-2000.

2,571,921. MAYBE IT'S TIME, INC., GOLDEN VALLEY, MN. SN 75-818,795. PUB. 1-23-2001, FILED 10-8-1999.

MAYBE

FOR PAPER PRODUCTS, NAMELY, SOCIAL STATIONERY, NOTE SHEETS, AND SCHOOL SUPPLIES IN THE NATURE OF NOTEBOOKS AND BLANK JOURNALS (U.S. CLS. 2, 5, 22, 23, 29, 37, 38 AND 50).

FIRST USE 6-15-2001; IN COMMERCE 6-15-2001.

2,572,011. ALGER ASSOCIATES, INC., NEW YORK, NY. SN 75-926,153. PUB. 11-7-2000, FILED 2-24-2000.



THE DESIGN MARK CONSISTS OF A STYLIZED REPRESENTATION OF A CAPITAL LETTER "A".

FOR PRINTED MATERIALS, NAMELY, NEWSLETTERS AND REPORTS FEATURING FINANCIAL INVESTMENT ANALYSIS, INVESTMENT ADVICE AND FINANCIAL NEWS; AND WORKBOOKS, WORKSHEETS, BROCHURES, FOR USE IN TEACHING SALES TECHNIQUES TO SALES PERSONNEL (U.S. CLS. 2, 5, 22, 23, 29, 37, 38 AND 50).

FIRST USE 8-24-2001; IN COMMERCE 8-24-2001.

CLASS 16—(Continued).

2,572,099. WALTON & POST, INC., MIAMI, FL. SN 76-073,533.
PUB. 3-27-2001, FILED 6-19-2000.

JUNIOR

OWNER OF U.S. REG. NO. 2,400,588.
FOR DISPOSABLE DIAPERS (U.S. CLS. 2, 5, 22, 23, 29,
37, 38 AND 50).
FIRST USE 8-3-2001; IN COMMERCE 8-14-2001.

2,572,102. PRINTING FOR SYSTEMS, INC., MADISON, CT.
SN 76-074,741. PUB. 3-20-2001, FILED 6-21-2000.

PSicard

THE DRAWING IS LINED FOR THE COLOR(S) RED AND
BLUE.
FOR PRINTED MATERIALS, NAMELY IDENTIFICA-
TION CARDS (U.S. CLS. 2, 5, 22, 23, 29, 37, 38 AND 50).
FIRST USE 5-1-2000; IN COMMERCE 5-1-2000.

2,572,103. SHIRLEY & BARNETT HELZBERG FOUNDA-
TION, KANSAS CITY, MO. SN 76-077,418. PUB. 3-20-2001,
FILED 6-23-2000.



OWNER OF U.S. REG. NOS. 852,718, 1,195,267, AND
OTHERS.
FOR BOOKS ON A WIDE VARIETY OF TOPICS (U.S.
CLS. 2, 5, 22, 23, 29, 37, 38 AND 50).
FIRST USE 1-5-2001; IN COMMERCE 1-5-2001.

CLASS 16—(Continued).

2,572,119. COLLINS, TITUS, CHICAGO, IL. SN 76-094,478.
PUB. 4-24-2001, FILED 7-24-2000.

GRASS SNATCHER

NO CLAIM IS MADE TO THE EXCLUSIVE RIGHT TO
USE "GRASS", APART FROM THE MARK AS SHOWN.
FOR TRASH BAGS, NAMELY, DISPOSABLE RECEIV-
ING BAGS FOR LAWN MOWERS (U.S. CLS. 2, 5, 22, 23,
29, 37, 38 AND 50).
FIRST USE 12-12-2000; IN COMMERCE 8-25-2001.

2,572,137. FLEER/SKYBOX INTERNATIONAL LP, MT.
LAUREL, NJ. SN 76-124,611. PUB. 5-15-2001, FILED 9-7-
2000.

CROWNS OF GOLD

FOR TRADING CARDS (U.S. CLS. 2, 5, 22, 23, 29, 37, 38
AND 50).
FIRST USE 1-0-2001; IN COMMERCE 1-0-2001.

2,572,146. ADAMA, INC., PORT ORANGE, FL. SN 76-140,581.
PUB. 6-12-2001, FILED 10-3-2000.

ADAMA, INC.

NO CLAIM IS MADE TO THE EXCLUSIVE RIGHT TO
USE "INC.", APART FROM THE MARK AS SHOWN.
FOR BOOKS, BOOKLETS, ARTICLES, AND NEWS-
LETTERS IN THE FIELD OF HEALTH, FITNESS,
NUTRITION, AND MEDICINE (U.S. CLS. 2, 5, 22, 23,
29, 37, 38 AND 50).
FIRST USE 12-23-2000; IN COMMERCE 12-23-2000.

2,572,171. CROSSGENERATION COMICS, INC., OLDSMAR,
FL. SN 76-192,385. PUB. 8-28-2001, FILED 1-10-2001.

SOJOURN

FOR PRINTED MATERIALS AND PUBLICATIONS,
NAMELY COMIC BOOKS, COMIC MAGAZINES AND
PRINTED STORIES IN ILLUSTRATED FORM FEAT-
URED IN BOOKS AND MAGAZINES (U.S. CLS. 2, 5,
22, 23, 29, 37, 38 AND 50).
FIRST USE 4-25-2001; IN COMMERCE 4-25-2001.

CLASS 16—(Continued).

2,572,190. LAINE, DEBRA, CLOQUET, MN. AND LAINE, BURTON, CLOQUET, MN. SN 78-000,482. PUB. 3-13-2001, FILED 3-22-2000.



NO CLAIM IS MADE TO THE EXCLUSIVE RIGHT TO USE "LEADERSHIP", APART FROM THE MARK AS SHOWN.

FOR PRINTED MATERIALS NAMELY, BOOKS AND TRAINING MANUALS USED TO DEVELOP LEADERSHIP SKILLS FOR CHILDREN AND TEENAGERS (U.S. CLS. 2, 5, 22, 23, 29, 37, 38 AND 50).
FIRST USE 5-15-1999; IN COMMERCE 1-22-2000.

CLASS 16—(Continued).

2,572,227. LOPKER, JOHN KEVIN, BEVERLY HILLS, CA. SN 78-059,542. PUB. 9-25-2001, FILED 4-20-2001.

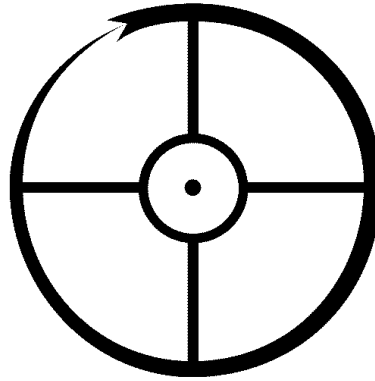

FOR PRINTED MATERIALS, NAMELY, BOOKS, TRAINING GUIDES, MANUALS, FLASH CARDS, PLAYING CARDS, BROCHURES, WORKBOOKS, PAMPHLETS, AND BOOKLETS IN THE FIELD OF PERSONALITY AND PSYCHOLOGICAL TYPE (U.S. CLS. 2, 5, 22, 23, 29, 37, 38 AND 50).
FIRST USE 5-28-2001; IN COMMERCE 6-30-2001.

2,572,228. LOPKER, JOHN KEVIN, BEVERLY HILLS, CA. SN 78-059,547. PUB. 10-2-2001, FILED 4-20-2001.

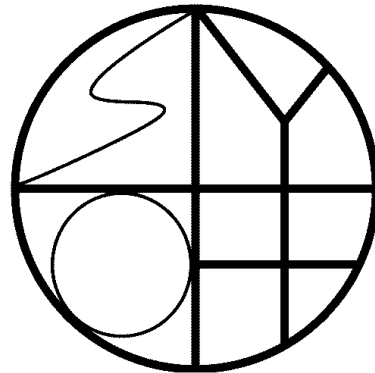

FOR PRINTED MATERIALS, NAMELY, BOOKS, TRAINING GUIDES, MANUALS, FLASH CARDS, PLAYING CARDS, BROCHURES, WORKBOOKS, PAMPHLETS, AND BOOKLETS IN THE FIELD OF PERSONALITY AND PSYCHOLOGICAL TYPE (U.S. CLS. 2, 5, 22, 23, 29, 37, 38 AND 50).
FIRST USE 5-30-2001; IN COMMERCE 5-30-2001.

2,572,213. BROWNSTONE PUBLISHERS, INC., NEW YORK, NY. SN 78-039,006. PUB. 9-11-2001, FILED 12-12-2000.

MANAGED CARE CONTRACTING AND REIMBURSEMENT ADVISOR

NO CLAIM IS MADE TO THE EXCLUSIVE RIGHT TO USE "MANAGED CARE CONTRACTING AND REIMBURSEMENT", APART FROM THE MARK AS SHOWN.

FOR PERIODIC PUBLICATIONS, NAMELY, NEWSLETTERS IN THE FIELD OF THE RELATIONSHIP BETWEEN HOSPITALS, HEALTH SYSTEMS, PHYSICIAN HOSPITAL ORGANIZATIONS, INDEPENDENT PHYSICIAN ASSOCIATIONS, AND MANAGEMENT SERVICES ORGANIZATIONS ON THE ONE HAND AND HEALTH MAINTENANCE ORGANIZATIONS, PREFERRED PROVIDER ORGANIZATIONS, SELF-INSURED EMPLOYERS AND GOVERNMENT AGENCIES ON THE OTHER HAND (U.S. CLS. 2, 5, 22, 23, 29, 37, 38 AND 50).
FIRST USE 2-0-2001; IN COMMERCE 2-0-2001.

CLASS 17—RUBBER GOODS

CLASS 17—(Continued).

2,571,717. NORTON PERFORMANCE PLASTICS CORPORATION, WAYNE, NJ. SN 75-395,083. PUB. 10-27-1998, FILED 11-24-1997.

NORSLIDE

FOR POLYTETRAFLUOROETHYLENE (PTFE) TUBING USED AS ANTI-FRICTION TUBING IN MECHANICAL CONTROL CABLE ASSEMBLIES (U.S. CLS. 1, 5, 12, 13, 35 AND 50).

FIRST USE 5-28-2001; IN COMMERCE 5-28-2001.

2,572,229. GENERAL ELECTRIC COMPANY, SCHENECTADY, NY. SN 78-060,083. PUB. 9-11-2001, FILED 4-24-2001.

SPACE INVADER

FOR CAULKING AND CAULKING COMPOUND; GENERAL PURPOSE SILICONE RUBBER SEALANT; SEALANTS FOR BUILDINGS; RUBBER SEALANT FOR CAULKING AND ADHESIVE PURPOSES (U.S. CLS. 1, 5, 12, 13, 35 AND 50).

FIRST USE 8-31-2001; IN COMMERCE 8-31-2001.

CLASS 18—LEATHER GOODS

2,571,714. HOLLAND & HOLLAND LIMITED, NEW YORK, NY. SN 75-386,005. PUB. 8-3-1999, FILED 11-6-1997.

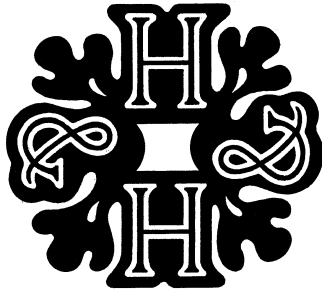

FOR HANDBAGS, TRUNKS (LUGGAGE), SUITCASES, ARTICLES OF LUGGAGE, DOCUMENT CASES, WALLETS, PURSES, ANIMAL GAME BAGS AND HUNTERS' GAME BAGS, WHIPS, HARNESSES AND SADDLERY; UMBRELLAS, PARASOLS AND WALKING STICKS; ANIMAL SKINS AND HIDES (U.S. CLS. 1, 2, 3, 22 AND 41).

FIRST USE 9-0-1998; IN COMMERCE 9-0-1998.

2,571,821. AIRWAY INDUSTRIES, INC., ELLWOOD CITY, PA. SN 75-656,086. PUB. 11-30-1999, FILED 3-8-1999.

SERENITY

FOR LUGGAGE (U.S. CLS. 1, 2, 3, 22 AND 41).
FIRST USE 8-20-2001; IN COMMERCE 8-20-2001.

CLASS 18—(Continued).

2,571,899. HUMPHREYS INC., CHICAGO, IL. SN 75-778,379. PUB. 4-4-2000, FILED 8-17-1999.

ADDITIONS

FOR SMALL LEATHER GOODS, NAMELY, WALLETS (U.S. CLS. 1, 2, 3, 22 AND 41).

FIRST USE 10-1-2001; IN COMMERCE 10-1-2001.

2,571,974. STEVIES, INC., LONG ISLAND CITY, NY. SN 75-885,684. PUB. 4-17-2001, FILED 1-4-2000.



FOR BAGS; NAMELY, HANDBAGS, SHOULDER BAGS, TOTE BAGS, WALLETS AND BACK PACKS (U.S. CLS. 1, 2, 3, 22 AND 41).

FIRST USE 7-0-2000; IN COMMERCE 7-0-2000.

CLASS 19—NON-METALLIC BUILDING MATERIALS

2,571,736. INDUSTRIAL RECYCLING SYSTEMS CORPORATION, VICTORIA, B.C., CANADA. SN 75-446,714. PUB. 10-31-2000, FILED 3-9-1998.

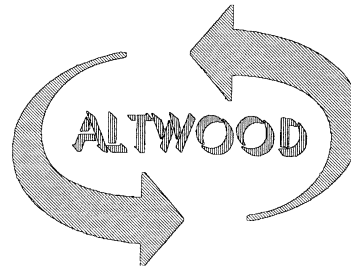

PRIORITY CLAIMED UNDER SEC. 44(D) ON CANADA APPLICATION NO. 855672, FILED 9-10-1997, REG. NO. 514102, DATED 8-9-1999, EXPIRES 8-9-2014.

THE DRAWING IS LINED FOR THE COLOR(S) BRICK RED AND FOREST GREEN.

FOR DIMENSIONAL LUMBER COMPRISED OF RECYCLED PLASTIC (U.S. CLS. 1, 12, 33 AND 50).

FIRST USE 10-14-2001; IN COMMERCE 11-23-2001.

CLASS 19—(Continued).

2,571,860. HEROKEE MANUFACTURING, INC., SOUTH ST. PAUL, MN, BY CHANGE OF NAME SCHUMACHER'S, INCORPORATED, DBA CHEROKEE MANUFACTURING, SOUTH ST. PAUL, MN. SN 75-720,703. PUB. 3-27-2001, FILED 6-3-1999.

CHEROKEE

FOR GEOTEXTILES, NAMELY, PERMEABLE FABRIC AND SHEETING FOR NURSERY, GREENHOUSE AND LANDSCAPING APPLICATIONS (U.S. CLS. 1, 12, 33 AND 50).

FIRST USE 11-15-1985; IN COMMERCE 11-15-1985.

2,571,935. AFFILIATED RESOURCES, INC., PORTLAND, OR. SN 75-839,860. PUB. 2-6-2001, FILED 11-3-1999.

AQUA PLY

FOR PLYWOOD (U.S. CLS. 1, 12, 33 AND 50).
FIRST USE 3-14-1997; IN COMMERCE 4-16-1999.

2,571,936. AFFILIATED RESOURCES, INC., PORTLAND, OR. SN 75-839,861. PUB. 2-6-2001, FILED 11-3-1999.

AQUA PLY PLUS

FOR PLYWOOD (U.S. CLS. 1, 12, 33 AND 50).
FIRST USE 3-14-1997; IN COMMERCE 3-12-1999.

2,571,998. UNIVERSAL AGGREGATES, LLC, PITTSBURGH, PA. SN 75-908,670. PUB. 5-22-2001, FILED 2-3-2000.

UNIVERSAL AGGREGATES

NO CLAIM IS MADE TO THE EXCLUSIVE RIGHT TO USE "AGGREGATES", APART FROM THE MARK AS SHOWN.

FOR PAVERS, PAVEMENT TILE, PAVING BLOCKS, PAVING STONES, PAVING TILES, ARCHITECTURAL BLOCKS, ARCHITECTURAL BRICKS AND ARCHITECTURAL AGGREGATE (U.S. CLS. 1, 12, 33 AND 50).

FIRST USE 10-31-2001; IN COMMERCE 10-31-2001.

2,572,110. WEYERHAEUSER COMPANY, FEDERAL WAY, WA, BY ASSIGNMENT TRUS JOIST MACMILLAN, BOISE, ID. SN 76-084,678. PUB. 4-17-2001, FILED 7-6-2000.

E-RIM

FOR STRUCTURAL WOOD PRODUCTS; NAMELY STRUCTURAL TRUSSES, JOISTS, HEADERS, BEAMS AND COLUMNS (U.S. CLS. 1, 12, 33 AND 50).
FIRST USE 5-22-2001; IN COMMERCE 5-22-2001.

CLASS 20—FURNITURE AND ARTICLES NOT OTHERWISE CLASSIFIED

2,571,729. SLONIM, MELISSA N., SAN DIEGO, CA. SN 75-428,073. PUB. 10-26-1999, FILED 2-3-1998.

BOTTLE BUDDY

NO CLAIM IS MADE TO THE EXCLUSIVE RIGHT TO USE "BOTTLE", APART FROM THE MARK AS SHOWN.

FOR CARRIER FOR A WATER BOTTLE WHICH CAN ATTACH BOTH TO A BELT AND TO A BICYCLE (U.S. CLS. 2, 13, 22, 25, 32 AND 50).

FIRST USE 9-13-1998; IN COMMERCE 9-13-1998.

2,571,760. TRISTAR PRODUCTS, INC., PARSIPPANY, NJ. SN 75-522,196. PUB. 5-8-2001, FILED 7-18-1998.

HOOK N HANG

SEC. 2(F).
FOR CLOTHING HANGERS (U.S. CLS. 2, 13, 22, 25, 32 AND 50).
FIRST USE 12-31-1998; IN COMMERCE 12-31-1998.

2,571,780. SPACESAVER CORPORATION, FORT ATKINSON, WI. SN 75-590,366. PUB. 10-5-1999, FILED 11-17-1998.

QUICKSPACE

FOR FURNITURE, NAMELY, MOBILE FILES, STORAGE AND SHELVING UNITS, AND PARTS AND ACCESSORIES SOLD AS A UNIT THEREWITH, NAMELY, KICK PLATES LABEL HOLDERS, SLIDING SHELVES AND FILE DIVIDERS, COMPONENTS FOR ASSEMBLING FILE DIVIDERS, NAMELY, SLIDE BRACKETS, CROSS BRACKETS, SLOTTED BACK BRACKETS AND SLOTTED OR PLAIN CENTER STOP BRACKETS; BIN DIVIDERS; COMPONENTS FOR ASSEMBLING BINS, NAMELY, BIN FRONTS, BIN BACKS AND CARD HOLDERS; COMPUTER REEL HANGERS; COMPUTER REEL RACKS; COMPONENTS FOR ASSEMBLING COMPUTER REEL HANGERS, NAMELY, HANGER BARS AND HORIZONTAL HANGERS; CAN RACKS, BACK PANELS, BACK PANEL HOLDERS, SUSPENDED POCKETS, DOORS, DRAWERS, RECEDING DOORS, SHELVES AND ANTI-TIP DEVICES, NAMELY, COUNTER-WEIGHTS (U.S. CLS. 2, 13, 22, 25, 32 AND 50).

FIRST USE 10-9-2000; IN COMMERCE 10-9-2000.

2,571,961. JEWELL, JIM, DURHAM, NH. SN 75-870,503. PUB. 5-8-2001, FILED 12-26-1999.

DOORYARD

FOR WOODEN LAWN ORNAMENTS, NAMELY, WILD LIFE CARVINGS, WIND TOYS, WHIRLY-GIGS AND WOODEN PEOPLE (U.S. CLS. 2, 13, 22, 25, 32 AND 50).

FIRST USE 4-1-2000; IN COMMERCE 4-1-2000.

CLASS 20—(Continued).

2,571,978. COURIER COOL LIMITED, SPEEN, UNITED KINGDOM. SN 75-886,404. PUB. 4-17-2001, FILED 1-5-2000.

COURIER-COOL SOFTBOX

NO CLAIM IS MADE TO THE EXCLUSIVE RIGHT TO USE "SOFTBOX", APART FROM THE MARK AS SHOWN. FOR CONTAINERS NOT OF METAL FOR COMMERCIAL USE, EXCLUDING TOOL BAGS SOLD EMPTY (U.S. CLS. 2, 13, 22, 25, 32 AND 50).

FIRST USE 1-0-2000; IN COMMERCE 1-0-2000.

2,572,007. DOREL JUVENILE GROUP, INC., CANTON, MA, BY MERGER COSCO, INC., COLUMBUS, IN. SN 75-922,398. PUB. 10-17-2000, FILED 2-22-2000.

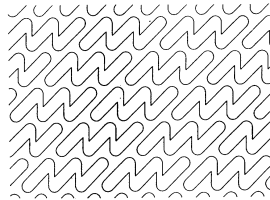

THE MARK CONSISTS OF A TREAD DESIGN APPLIED TO APPLICANT'S GOODS.

FOR FURNITURE, INCLUDING STEP STOOLS (U.S. CLS. 2, 13, 22, 25, 32 AND 50).

FIRST USE 6-0-2000; IN COMMERCE 8-0-2000.

2,572,161. WEST COAST INDUSTRIES, INC., SAN FRANCISCO, CA. SN 76-181,367. PUB. 7-17-2001, FILED 12-14-2000.

FURNISHING POSSIBILITIES

FOR FURNITURE (U.S. CLS. 2, 13, 22, 25, 32 AND 50). FIRST USE 6-1-2001; IN COMMERCE 6-1-2001.

CLASS 21—HOUSEWARES AND GLASS

2,571,761. BREDDERMAN, THEODORE A., DBA DEL DESIGNS, DELMAR, NY. SN 75-524,109. PUB. 11-16-1999, FILED 7-23-1998.

DUFFEL MUFF

NO CLAIM IS MADE TO THE EXCLUSIVE RIGHT TO USE "DUFFEL", APART FROM THE MARK AS SHOWN.

FOR FLEXIBLE INSULATING FABRIC BAG FOR CARRYING CONTAINERS OF FOOD SO THAT THEY REMAIN HOT OR COLD AS IS APPROPRIATE (U.S. CLS. 2, 13, 23, 29, 30, 33, 40 AND 50).

FIRST USE 11-20-1999; IN COMMERCE 2-12-2001.

CLASS 21—(Continued).

2,571,787. GOINS, JERRY EDWIN, BYRON, GA. SN 75-598,759. PUB. 11-2-1999, FILED 11-19-1998.

WISH BALLS

FOR NOVELTY GIFT ITEMS, NAMELY A KIT CONTAINING A VARIETY OF SMALL BOTTLES THAT ARE HUNG ON A RACK, THE CONTENTS OF THE BOTTLES USED TO MAKE WISHES (U.S. CLS. 2, 13, 23, 29, 30, 33, 40 AND 50).

FIRST USE 12-0-2000; IN COMMERCE 12-0-2000.

2,571,844. JOYCE CHEN, INC., BILLERICA, MA. SN 75-699,876. PUB. 9-11-2001, FILED 5-5-1999.

FRENCH PANTRY

FOR CAST IRON BAKEWARE, NAMELY, DUTCH-OVENS, SAUCEPANS, SKILLETS, AND BAKING DISHES; CERAMIC BAKERS; COOKIE MOLDS, AND BAKEWARE (U.S. CLS. 2, 13, 23, 29, 30, 33, 40 AND 50).

FIRST USE 7-1-1999; IN COMMERCE 7-1-1999.

2,571,881. DYNACCO, INC., MONROE, WA. SN 75-754,465. PUB. 4-11-2000, FILED 7-12-1999.

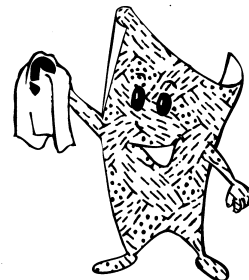

FOR TOWELS IMPREGNATED WITH A CLEANING SOLUTION (U.S. CLS. 2, 13, 23, 29, 30, 33, 40 AND 50). FIRST USE 7-19-1999; IN COMMERCE 7-19-1999.

CLASS 21—(Continued).

2,572,035. HEARST COMMUNICATIONS, INC., NEW YORK, NY. SN 75-981,852. PUB. 9-12-2000, FILED 4-21-1999.



OWNER OF U.S. REG. NOS. 1,801,927, 1,991,826, AND OTHERS.

FOR BAKEWARE, NAMELY, ALUMINUM, NON STICK (U.S. CLS. 2, 13, 23, 29, 30, 33, 40 AND 50).

FIRST USE 9-0-2001; IN COMMERCE 9-0-2001.

2,572,118. BALDWIN HARDWARE CORPORATION, READING, PA. SN 76-092,211. PUB. 5-29-2001, FILED 7-20-2000.

CARNIVALE SPIRAL

THE ENGLISH TRANSLATION OF "CARNIVALE" IS "CARNIVAL".

FOR BATHROOM ACCESSORIES, NAMELY, TOWEL BARS, TOWEL RINGS, TOILET TISSUE HOLDERS, AND TOOTHBRUSH-TUMBLER HOLDERS (U.S. CLS. 2, 13, 23, 29, 30, 33, 40 AND 50).

FIRST USE 11-7-2000; IN COMMERCE 11-7-2000.

2,572,225. EUSTACHE, DOMINIQUE R., SEILLANS, FRANCE. SN 78-055,814. PUB. 10-16-2001, FILED 3-29-2001.



FOR INSULATED THERMAL CONTAINERS AND TOTE BAGS FOR FOOD, BEVERAGES, CHEMICALS, VACCINES, MEDICINES AND TEMPERATURE-SENSITIVE LIVING CREATURES (U.S. CLS. 2, 13, 23, 29, 30, 33, 40 AND 50).

FIRST USE 10-1-1999; IN COMMERCE 9-1-2001.

CLASS 24—FABRICS**CLASS 24—(Continued).**

2,571,905. SARA LEE CORPORATION, WINSTON-SALEM, NC. SN 75-794,469. PUB. 3-14-2000, FILED 9-8-1999.



OWNER OF U.S. REG. NOS. 155,702, 2,246,201, AND OTHERS.

NO CLAIM IS MADE TO THE EXCLUSIVE RIGHT TO USE "FOR THE HOME", APART FROM THE MARK AS SHOWN.

FOR BEDSHEETS, PILLOWCASES, COMFORTERS, BEDSPREADS, DUST RUFFLES, PILLOW SHAMS, TOWELS, SHOWER CURTAINS, FABRIC BATH MATS, SHOWER CURTAIN LINERS (U.S. CLS. 42 AND 50).

FIRST USE 4-5-2000; IN COMMERCE 4-5-2000.

2,571,912. DAN RIVER INC., DANVILLE, VA. SN 75-805,837. PUB. 4-3-2001, FILED 9-22-1999.

BED-IN-A-BAG DECOR

NO CLAIM IS MADE TO THE EXCLUSIVE RIGHT TO USE "BED-IN-A-BAG", APART FROM THE MARK AS SHOWN.

FOR BED SHEETS, PILLOWCASES, COMFORTERS AND PILLOW SHAMS; CURTAINS AND FABRIC VALANCES (U.S. CLS. 42 AND 50).

FIRST USE 11-29-1999; IN COMMERCE 11-29-1999.

CLASS 25—CLOTHING

2,571,687. REBA MCENTIRE, A U.S. CITIZEN, AS TRUSTEE OF THE SMITH TRUST, NASHVILLE, TN. SN 74-716,820. PUB. 3-17-1998, FILED 8-17-1995.

REBA MCENTIRE

OWNER OF U.S. REG. NO. 1,966,072. "REBA MCENTIRE" IDENTIFIES A LIVING INDIVIDUAL WHOSE CONSENT IS OF RECORD.

FOR CLOTHING, NAMELY, T-SHIRTS, SWEAT SHIRTS, SHORTS, SWEAT PANTS, NIGHT SHIRTS, SWEATERS, SATIN JACKETS, DENIM JACKETS, BATHROBES, LEATHER JACKETS, RAIN PONCHOS, SOCKS; BASEBALL CAPS; SOCKS; FOOTWEAR; HEADWEAR (U.S. CLS. 22 AND 39).

FIRST USE 9-29-1999; IN COMMERCE 9-29-1999.

CLASS 25—(Continued).

2,571,709. XULU ENTERTAINMENT INC., SAN JOSE, CA. SN 75-372,280. PUB. 8-18-1998, FILED 10-14-1997.

XULU ENTERTAINMENT

FOR CLOTHING, NAMELY, T-SHIRTS, SWEATSHIRTS, SWEATERS, POLO SHIRTS, ATHLETIC UNIFORMS, JACKETS, COATS, HATS, CAPS, SUN VISORS, SHORTS, PANTS, JEANS, SKIRTS, DRESSES, LINGERIE, UNDERWEAR, BEACHWEAR, BATHING SUITS, RAINWEAR, PAJAMAS, ROBES, TIES, BELTS, SCARVES, GLOVES, MITTENS, SOCKS, HOSIERY, SHOES, ATHLETIC FOOTWEAR, AND COSTUMES AND MASKS SOLD IN CONNECTION THEREWITH (U.S. CLS. 22 AND 39).

FIRST USE 10-18-2001; IN COMMERCE 10-19-2001.

2,571,720. SANDALWOOD APPAREL CORP., NEW YORK, NY. SN 75-401,393. PUB. 10-19-1999, FILED 12-8-1997.

MOUNTAIN CLUB

FOR MEN AND BOYS APPAREL, NAMELY, TROUSERS, SHIRTS, UNDERWEAR, SOCKS, SWEATERS, JACKETS, COATS, SUITS, SHORTS, ATHLETIC APPAREL, NAMELY, WIND SUITS, COVERALLS, AND OVERALLS (U.S. CLS. 22 AND 39).

FIRST USE 0-0-1997; IN COMMERCE 0-0-1997.

2,571,734. INDUSTRIA DE MEIAS SCALINA LTDA., SAO PAULO, BRAZIL. SN 75-440,416. PUB. 5-1-2001, FILED 2-25-1998.

TRIFIL

FOR CLOTHING, NAMELY, SOCKS, PANTYHOSE, PANTIES, STOCKINGS (U.S. CLS. 22 AND 39).

FIRST USE 7-3-1969; IN COMMERCE 3-4-2000.

2,571,742. NEWSTED, JASON, SAN FRANCISCO, CA. SN 75-457,458. PUB. 10-27-1998, FILED 3-26-1998.

CHOPHOUSE

FOR CLOTHING, NAMELY, T-SHIRTS, BASEBALL CAPS, AND HATS (U.S. CLS. 22 AND 39).

FIRST USE 1-7-2002; IN COMMERCE 1-7-2002.

CLASS 25—(Continued).

2,571,816. LANDRY'S TRADEMARK, INC., WILMINGTON, DE. SN 75-650,339. PUB. 4-3-2001, FILED 2-26-1999.

KEMAH BOARDWALK

OWNER OF U.S. REG. NOS. 1,838,922, 1,890,299, AND 1,972,218.

NO CLAIM IS MADE TO THE EXCLUSIVE RIGHT TO USE "KEMAH", APART FROM THE MARK AS SHOWN.

FOR CLOTHING, NAMELY, T-SHIRTS, SHORTS, HATS, SOCKS, TIES, JACKETS AND COATS (U.S. CLS. 22 AND 39).

FIRST USE 1-0-1998; IN COMMERCE 1-0-1998.

2,571,827. BALLETT MAKERS, INC., TOTOWA, NJ. SN 75-663,727. PUB. 11-30-1999, FILED 3-19-1999.

TOE TO TOP

FOR TIGHTS AND LEGGINGS (U.S. CLS. 22 AND 39).

FIRST USE 4-15-2000; IN COMMERCE 4-15-2000.

2,571,865. BILL BLASS INTERNATIONAL LLC, NEW YORK, NY, BY ASSIGNMENT BILL BLASS, LTD., NEW YORK, NY. SN 75-728,589. PUB. 1-25-2000, FILED 6-15-1999.

BLASSPORT

OWNER OF U.S. REG. NO. 1,018,060.

FOR CLOTHING, NAMELY, COATS AND BELTS (U.S. CLS. 22 AND 39).

FIRST USE 9-1-2001; IN COMMERCE 9-1-2001.

2,571,879. HARMONY GOLD USA, INC., LOS ANGELES, CA. SN 75-750,692. PUB. 2-29-2000, FILED 7-14-1999.

MACROSS

FOR SOCKS, FOOTWEAR, SHIRTS, SWEATSHIRTS, PAJAMAS, WARM-UP SUITS, COATS, SHORTS, GYM SHORTS DRESSES, CLOTHING BELTS, BANDANNAS, SWEATERS, GLOVES, EAR MUFFS, NECKWEAR, SKI WEAR, SLACKS, SUN VISORS, SUSPENDERS, TURTLE-NECKS VESTS HEADWEAR BATHROBES, BEACHWEAR (U.S. CLS. 22 AND 39).

FIRST USE 9-30-2001; IN COMMERCE 9-30-2001.

CLASS 25—(Continued).

2,571,906. CALIFORNIA IMPRINTED APPAREL, INC., VISTA, CA. SN 75-794,539. PUB. 7-31-2001, FILED 9-8-1999.



THE MARK CONSISTS OF THE STYLIZED LETTERS "CIA".

FOR T-SHIRTS, HATS, FOOTWEAR, SNEAKERS, SHORTS, PANTS, SHIRTS, SWIMSUITS (U.S. CLS. 22 AND 39).

FIRST USE 6-0-1999; IN COMMERCE 6-0-1999.

2,571,926. COTTAGE CRAFTS, INC., NEW YORK, NY. SN 75-824,118. PUB. 5-9-2000, FILED 10-15-1999.

FIRST VISION

FOR WOMEN'S CLOTHING, NAMELY DRESSES AND TOPS (U.S. CLS. 22 AND 39).

FIRST USE 6-0-2001; IN COMMERCE 6-0-2001.

2,571,959. ORLANDO MAGIC, LTD., ORLANDO, FL. SN 75-868,573. PUB. 3-27-2001, FILED 12-8-1999.



OWNER OF U.S. REG. NOS. 1,523,570, 1,985,838, AND OTHERS.

SEC. 2(F) AS TO "ORLANDO".

FOR CLOTHING, NAMELY, HOSIERY, FOOTWEAR, T-SHIRTS, SWEATSHIRTS, SWEATPANTS, PANTS, TANK TOPS, JERSEYS, SHORTS, PAJAMAS, SPORT SHIRTS, RUGBY SHIRTS, SWEATERS, BELTS, TIES, NIGHTSHIRTS, HATS, WARM-UP SUITS, JACKETS, PARKAS, COATS, CLOTH BIBS, HEAD BANDS, WRIST BANDS, APRONS, BOXER SHORTS, SLACKS, CAPS, EAR MUFFS, GLOVES, WOVEN AND KNIT SHIRTS (U.S. CLS. 22 AND 39).

FIRST USE 6-27-2000; IN COMMERCE 6-27-2000.

CLASS 25—(Continued).

2,571,990. BABIARZ, DAVE, TUCSON, AZ. SN 75-900,363. PUB. 9-5-2000, FILED 1-19-2000.

THE LUMBERYARD

FOR MEN'S, WOMEN'S AND CHILDREN'S CLOTHING, NAMELY, FLEECE TOPS AND BOTTOMS, CAPS, HEADWEAR, T-SHIRTS, SWEATSHIRTS, SHORTS, TANK TOPS, SWEATERS, PANTS, JACKETS, TURTLENECKS, JUMPSUITS, GOLF SHIRTS, JERSEYS, WRISTBANDS, WARM UP SUITS, SWIMWEAR, WIND RESISTANT JACKETS, RAINCOATS, PARKAS, PONCHOS, GLOVES, TIES, SUSPENDERS, CLOTH BIBS, SLEEPWEAR, NAMELY, ROBES, NIGHT SHIRTS AND PAJAMAS, GLOVES, MITTENS, HATS AND CAPS, SCARVES, APRONS, HEADBANDS, EAR MUFFS, HEAD WRAPS, SKI MASKS, AND UNDERWEAR; FOOTWEAR, NAMELY, BOOTS, SNEAKERS AND ATHLETIC SHOES (U.S. CLS. 22 AND 39).

FIRST USE 3-18-2001; IN COMMERCE 3-18-2001.

2,572,009. SAMSUNG AMERICA, INC., RIDGEFIELD PARK, NJ. SN 75-926,029. PUB. 9-5-2000, FILED 2-23-2000.

ASTRAGOLF

OWNER OF U.S. REG. NO. 1,521,904.
FOR CLOTHING NAMELY, COATS, JACKETS, PANTS, SHORTS, SHIRTS, VESTS, SKIRTS, AND SWEATERS (U.S. CLS. 22 AND 39).

FIRST USE 11-5-2001; IN COMMERCE 11-5-2001.

2,572,040. SHOLK, JEFFREY CLAY, LEUCADIA, CA. SN 76-003,469. PUB. 11-21-2000, FILED 3-18-2000.

RAINBOW BEACH

NO CLAIM IS MADE TO THE EXCLUSIVE RIGHT TO USE "BEACH", APART FROM THE MARK AS SHOWN.

FOR CLOTHING FOR CHILDREN, NAMELY, SWEATSHIRTS, PANTS, SHORTS, SHIRTS, T-SHIRTS; HEADWEAR, NAMELY, HATS (U.S. CLS. 22 AND 39).

FIRST USE 1-5-2002; IN COMMERCE 1-5-2002.

CLASS 25—(Continued).

2,572,048. TOZZI, DONNA, BOCA RATON, FL. SN 76-015,946. PUB. 1-30-2001, FILED 4-3-2000.

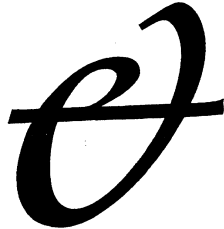

FOR SHOES FOR MEN AND WOMEN (U.S. CLS. 22 AND 39).
FIRST USE 5-13-2001; IN COMMERCE 5-13-2001.

CLASS 25—(Continued).

2,572,095. TERRAMAR SPORTS WORLDWIDE, LTD., PORT CHESTER, NY. SN 76-070,619. PUB. 4-24-2001, FILED 6-19-2000.

THERMAWOOL EC2 QWIK-DRI

OWNER OF U.S. REG. NOS. 1,268,645, 1,954,131, AND OTHERS.

NO CLAIM IS MADE TO THE EXCLUSIVE RIGHT TO USE "QUICK-DRY", APART FROM THE MARK AS SHOWN.

FOR CLOTHING MADE WHOLLY OR PARTIALLY OF WOOL, NAMELY, UNDERWEAR, SWEATERS, DRESSES, SHIRTS, JACKETS, BLOUSES, PANTS, HIKING SHORTS, SOCKS, GLOVES, HATS, HEADBANDS, WARM-UP SUITS, RUNNING OR JOGGING SUITS, AND COATS (U.S. CLS. 22 AND 39).
FIRST USE 9-0-2000; IN COMMERCE 9-0-2000.

2,572,049. WUNDIES ENTERPRISES, INC., NEW YORK, NY. SN 76-016,519. PUB. 2-13-2001, FILED 4-3-2000.

GIRL TALK

FOR GIRL'S SLEEPWEAR AND LOUNGEWEAR EXCLUDING T-SHIRTS; PANTIES, BRAS, BRA AND PANTY SETS, CAMISOLES, AND TEE SHIRTS FOR GIRLS (U.S. CLS. 22 AND 39).
FIRST USE 2-1-2000; IN COMMERCE 2-1-2001.

2,572,112. BLAUER MANUFACTURING COMPANY, INC., BOSTON, MA. SN 76-090,059. PUB. 3-27-2001, FILED 7-17-2000.

SUPERSHELL

FOR CLOTHING, NAMELY, JACKETS, COATS, AND PANTS (U.S. CLS. 22 AND 39).
FIRST USE 1-29-2001; IN COMMERCE 1-29-2001.

2,572,054. FAITHLINE DESIGN, INC., COLUMBIA, PA. SN 76-019,611. PUB. 12-5-2000, FILED 4-6-2000.

FAITHLINE DESIGN

NO CLAIM IS MADE TO THE EXCLUSIVE RIGHT TO USE "DESIGN", APART FROM THE MARK AS SHOWN.

FOR CLOTHING, NAMELY, OVERALLS, PANTS, SHIRTS, TOPS, SKIRTS, SHORTS, SWEATSHIRTS, JACKETS, ROBES, COATS, HALLOWEEN COSTUMES, GLOVES AND MITTENS, SLIPPERS, HATS, CAPS, VISORS, WRIST BANDS, HEAD BANDS, SOCKS, SCARVES, HEADWEAR, FOOTWEAR, NECKWEAR, SLEEPWEAR, AND SWIM WEAR (U.S. CLS. 22 AND 39).
FIRST USE 7-3-2000; IN COMMERCE 7-3-2000.

2,572,115. K-SWISS INC., WESTLAKE VILLAGE, CA. SN 76-091,298. PUB. 4-24-2001, FILED 7-8-2000.



OWNER OF U.S. REG. NOS. 86,662, 2,269,296, AND OTHERS.

FOR SHOES, PANTS, SHIRTS, T-SHIRTS, WARM-UP PANTS, WARM-UP JACKETS, SHORTS, VESTS, SKIRTS, SOCKS AND CAPS (U.S. CLS. 22 AND 39).
FIRST USE 11-15-2000; IN COMMERCE 11-15-2000.

CLASS 25—(Continued).

2,572,129. DASHAMERICA, INC., BROOMFIELD, CO. SN 76-112,554. PUB. 5-15-2001, FILED 8-18-2000.



FOR FOOTWEAR (U.S. CLS. 22 AND 39).
FIRST USE 10-16-2001; IN COMMERCE 10-16-2001.

2,572,208. OCHOA, JAVIER, ZAPOPAN, MEXICO. SN 78-033,662. PUB. 7-17-2001, FILED 11-3-2000.



FOR SANDALS, SHOES FOR MEN AND WOMEN (U.S. CLS. 22 AND 39).
FIRST USE 2-14-1994; IN COMMERCE 3-18-2001.

2,572,220. MDS GEAR, INC., SAN PEDRO, CA. SN 78-048,591. PUB. 9-25-2001, FILED 2-15-2001.

MBM GEAR

NO CLAIM IS MADE TO THE EXCLUSIVE RIGHT TO USE "GEAR", APART FROM THE MARK AS SHOWN.
FOR MEN'S, WOMEN'S AND CHILDREN'S CLOTHING, NAMELY JACKETS, PANTS, SHIRTS, SHORTS AND SHOES (U.S. CLS. 22 AND 39).
FIRST USE 11-8-2001; IN COMMERCE 11-8-2001.

CLASS 26—FANCY GOODS**CLASS 26—(Continued).**

2,571,979. STEVIES, INC., LONG ISLAND CITY, NY. SN 75-888,273. PUB. 4-17-2001, FILED 1-6-2000.



FOR HAIR ORNAMENTS; NAMELY, BARRETTES, HAIR BOWS, HAIR BUCKLES, HAIR PINS, HAIR RIBBONS, HAIR BANDS AND PONYTAIL HOLDERS (U.S. CLS. 37, 39, 40, 42 AND 50).
FIRST USE 7-0-2000; IN COMMERCE 7-0-2000.

2,572,175. RENE OF PARIS, INC., VAN NUYS, CA. SN 76-195,717. PUB. 9-11-2001, FILED 1-19-2001.

AMORE

THE ENGLISH TRANSLATION OF "AMORE" IS "LOVE."
FOR WIGS AND HAIRPIECES (U.S. CLS. 37, 39, 40, 42 AND 50).
FIRST USE 2-1-2001; IN COMMERCE 2-1-2001.

CLASS 27—FLOOR COVERINGS

2,572,155. BREWSTER WALLCOVERING COMPANY, RANDOLPH, MA. SN 76-164,857. PUB. 6-19-2001, FILED 11-14-2000.

CAN YOU IMAGINE?

FOR WALLCOVERINGS MADE OF PAPER, VINYL OR CLOTH (U.S. CLS. 19, 20, 37, 42 AND 50).
FIRST USE 2-0-2001; IN COMMERCE 2-0-2001.

2,572,159. TRANSPORT GRAPHICS, INC., MERRILLVILLE, IN. SN 76-178,896. PUB. 7-3-2001, FILED 12-11-2000.



FOR REUSABLE VINYL WALL IMAGES USING A RESTICKABLE ADHESIVE (U.S. CLS. 19, 20, 37, 42 AND 50).
FIRST USE 2-13-2001; IN COMMERCE 2-13-2001.

CLASS 28—TOYS AND SPORTING GOODS

2,571,694. CINCINNATI BENGALS, INC., CINCINNATI, OH.
SN 75-239,931. PUB. 7-28-1998, FILED 2-11-1997.



FOR GOLF SPORTING GOODS USED TO PROMOTE THE REGISTRANT'S PROFESSIONAL FOOTBALL TEAM, NAMELY, GOLF BALLS, GOLF BAGS, GOLF CLUBS, AND GOLF CLUB COVERS; AND BOWLING BALLS, BOWLING BAGS, FOOTBALLS, EXERCISE EQUIPMENT, NAMELY, STATIONERY EXERCISE BICYCLES, BAR BELLS AND FREE WEIGHTS (U.S. CLS. 22, 23, 38 AND 50).
FIRST USE 4-15-2000; IN COMMERCE 4-15-2000.

2,571,695. CINCINNATI BENGALS, INC., CINCINNATI, OH.
SN 75-245,219. PUB. 7-21-1998, FILED 2-21-1997.



FOR GOLF SPORTING GOODS USED TO PROMOTE THE REGISTRANT'S PROFESSIONAL FOOTBALL TEAM, NAMELY, GOLF BALLS, GOLF BAGS, GOLF CLUBS, AND GOLF CLUB COVERS; AND BOWLING BALLS, BOWLING BAGS, FOOTBALLS (U.S. CLS. 22, 23, 38 AND 50).
FIRST USE 4-15-2000; IN COMMERCE 4-15-2000.

CLASS 28—(Continued).

2,571,713. FERRARI, PHILIP F., MEDINAH, IL. SN 75-377,004. PUB. 6-15-1999, FILED 10-21-1997.



FOR BASKETBALL TRAINING GAME FOR PERFECTING THE ARC OF A BASKETBALL AS IT TRAVELS TO THE BASKETBALL HOOP, NAMELY, A VERTICALLY ORIENTED RING POSITIONED AT A PREDETERMINED HEIGHT AND DISTANCE IN FRONT OF AND AWAY FROM THE BASKETBALL HOOP THROUGH WHICH THE PLAYER THROWS THE BASKETBALL INTO THE HOOP (U.S. CLS. 22, 23, 38 AND 50).
FIRST USE 2-1-1998; IN COMMERCE 2-1-1998.

2,571,747. HARVEY ENTERTAINMENT, INC., NEW YORK, NY, BY ASSIGNMENT HARVEY COMICS, INC., LOS ANGELES, CA. SN 75-481,657. PUB. 12-22-1998, FILED 5-8-1998.

WENDY THE WITCH

FOR TOYS, GAMES AND SPORTING ARTICLES, NAMELY, ACTION FIGURES MADE OF PLASTIC INCLUDING CARRYING CASES; BALLOONS; BATHTUB TOYS; BABY RATTLES; BABY MULTIPLE ACTIVITY TOYS; TOY BUILDING BLOCKS; BOARD GAMES; CARD GAMES; PLAY COSMETICS FOR CHILDREN; COSTUME MASKS; MINIATURE DIE CAST VEHICLES; TOY AIRPLANES AND HELICOPTERS; REMOTE CONTROL AND RADIO CONTROLLED VEHICLES; FLYING DISKS; MODEL CRAFT KITS; INFLATABLE AND SOFT VINYL FIGURES; DOLLS; DOLL CLOTHING AND ACCESSORIES; DOLL CARRYING CASES; FIGURES MADE OF POLYVINYL COATING, RESIN, FLOCK AND VINYL; JIGSAW PUZZLES; KITES; MARBLES; PLAYTENTS FOR CHILDREN TO BE USED INDOORS; PLUSH TOYS; CLOTH TOYS; PUPPETS; RIDE-ON TOYS; TRAIN SETS; PLAY SHAVING KITS; SKATEBOARDS; ROLLER SKATES; TOY BANKS; WATER SQUIRTING TOYS; TOY PISTOLS; TARGET SETS; MODELING DOUGH AND TOY PUTTY; CHRISTMAS TREE ORNAMENTS; PARTY FAVORS IN THE NATURE OF SMALL TOYS; ARCADE STYLE PINBALL GAMES; COIN-OPERATED VIDEO ARCADE GAMES; COIN-OPERATED PINBALL MACHINES; HANDHELD UNITS FOR PLAYING ELECTRONIC GAMES; ARCADE GAMES; ROLE PLAYING GAMES; TENNIS RACKETS; HOCKEY STICKS; BASKETBALLS; BASEBALL BATS; SPORTS BAGS, NAMELY, BAGS FOR TENNIS RACKETS, HOCKEY STICKS, BASKETBALLS, AND BASEBALL BATS (U.S. CLS. 22, 23, 38 AND 50).
FIRST USE 4-1-2001; IN COMMERCE 4-1-2001.

CLASS 28—(Continued).

2,571,886. DESERT TROON LIMITED, L.L.C., SCOTTSDALE, AZ. SN 75-762,159. PUB. 2-15-2000, FILED 7-27-1999.

TORREON GOLF CLUB

NO CLAIM IS MADE TO THE EXCLUSIVE RIGHT TO USE "GOLF CLUB", APART FROM THE MARK AS SHOWN.

THE ENGLISH TRANSLATION OF "TORREON" IS LARGE FORTIFIED TOWER.

FOR GOLF SPORTING GOODS AND EQUIPMENT, NAMELY GOLF BALLS, GOLF BALL TEES, GOLF BALL MARKERS, HEAD COVERS FOR GOLF CLUBS, GOLF PUTTER COVERS, GOLF GLOVES, GOLF BAG IDENTIFICATION TAGS, GOLF BAGS, AND DIVOT REPAIR TOOLS (U.S. CLS. 22, 23, 38 AND 50).

FIRST USE 8-31-1999; IN COMMERCE 8-31-1999.

2,571,958. DSI TOYS, INC., HOUSTON, TX. SN 75-868,315. PUB. 8-29-2000, FILED 12-9-1999.

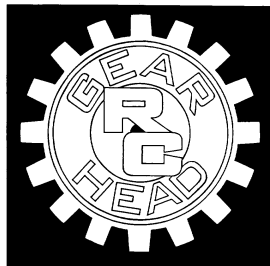

NO CLAIM IS MADE TO THE EXCLUSIVE RIGHT TO USE "RC", APART FROM THE MARK AS SHOWN.

FOR TOYS, NAMELY, REMOTE CONTROLLED AND INFRARED CONTROLLED VEHICLES (U.S. CLS. 22, 23, 38 AND 50).

FIRST USE 6-9-2000; IN COMMERCE 6-9-2000.

2,571,964. VERONICA CUSTOM DOLLS, INC., HUNTINGTON, NY. SN 75-873,778. PUB. 9-12-2000, FILED 12-15-1999.

GRAMMIE MOLLY

FOR DOLLS (U.S. CLS. 22, 23, 38 AND 50).
FIRST USE 12-26-2001; IN COMMERCE 12-26-2001.

2,571,966. THOS FLOATS, LLC, ATLANTA, GA. SN 75-878,073. PUB. 1-16-2001, FILED 12-21-1999.

FISH-FLY

FOR FISHING EQUIPMENT, NAMELY, FISHING FLOATS, SINKERS, AND ARTIFICIAL LURES AND BAIT (U.S. CLS. 22, 23, 38 AND 50).

FIRST USE 1-21-2000; IN COMMERCE 1-21-2000.

CLASS 28—(Continued).

2,571,967. TRIUMPH DESIGNS LIMITED, DERBYSHIRE DE 12 7JP, UNITED KINGDOM. SN 75-878,199. PUB. 6-5-2001, FILED 12-22-1999.

TRIUMPH

FOR TOY MODEL MOTORCYCLES AND RELATED ACCESSORIES SOLD AS A UNIT; TOY MOTORCYCLES (U.S. CLS. 22, 23, 38 AND 50).

FIRST USE 5-31-2000; IN COMMERCE 5-31-2001.

2,572,021. KIRKBI AG, CH-6340, BAAR, SWITZERLAND. SN 75-942,265. PUB. 4-24-2001, FILED 3-13-2000.

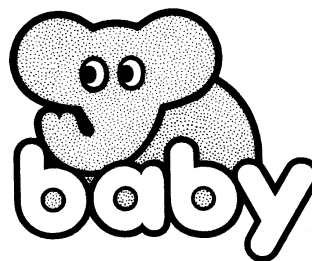

OWNER OF U.S. REG. NO. 2,207,242.
NO CLAIM IS MADE TO THE EXCLUSIVE RIGHT TO USE "BABY", APART FROM THE MARK AS SHOWN.

THE STIPPLING IS FOR SHADING PURPOSES ONLY AND DOES NOT INDICATE COLOR.

FOR CONSTRUCTION TOYS; TOY VEHICLES; PLAY FIGURES; INFANT'S RATTLES; STACKING TOYS; WHEELED PUSH TOYS; INFANT TOYS; BABY OR CHILDREN'S MULTIPLE ACTIVITY TOYS; TOY BUILDING BLOCKS; RIDE-ON TOYS; TOY BOXES; PLUSH TOYS (U.S. CLS. 22, 23, 38 AND 50).

FIRST USE 0-0-2000; IN COMMERCE 0-0-2000.

2,572,045. MARS, INCORPORATED, MCLEAN, VA. SN 76-008,726. PUB. 10-24-2000, FILED 3-24-2000.



OWNER OF U.S. REG. NOS. 396,914, 1,774,366, AND OTHERS.

FOR TOYS, NAMELY, A BAG CONTAINING PLUSH BEAN BAGS (U.S. CLS. 22, 23, 38 AND 50).

FIRST USE 2-1-2000; IN COMMERCE 2-1-2000.

CLASS 28—(Continued).

2,572,131. CABELA'S INCORPORATED, SIDNEY, NE. SN 76-113,685. PUB. 6-12-2001, FILED 8-21-2000.

VIVID

FOR FISHING RODS, REELS, LINE AND LURES (U.S. CLS. 22, 23, 38 AND 50).
FIRST USE 1-8-2001; IN COMMERCE 1-8-2001.

2,572,136. MERIT INDUSTRIES, INC., BENSALEM, PA. SN 76-121,717. PUB. 5-22-2001, FILED 8-31-2000.

BOXXI

FOR COIN OPERATED VIDEO OUTPUT GAME MACHINES (U.S. CLS. 22, 23, 38 AND 50).
FIRST USE 9-25-2000; IN COMMERCE 9-25-2000.

2,572,191. MATTEL, INC., EL SEGUNDO, CA. SN 78-004,152. PUB. 11-21-2000, FILED 4-14-2000.

X-CAVATOR

FOR TOY ACTION FIGURES AND ACCESSORIES THEREFOR (U.S. CLS. 22, 23, 38 AND 50).
FIRST USE 12-0-2000; IN COMMERCE 12-0-2000.

2,572,207. MATTEL, INC., EL SEGUNDO, CA. SN 78-030,782. PUB. 6-5-2001, FILED 10-16-2000.

GRAND ENTRANCE

OWNER OF U.S. REG. NO. 2,246,377.
FOR DOLLS, DOLL CLOTHING AND DOLL ACCESSORIES (U.S. CLS. 22, 23, 38 AND 50).
FIRST USE 2-1-2001; IN COMMERCE 2-1-2001.

2,572,224. HERGET, PATRICK R., WALLINGFORD, CT. SN 78-053,673. PUB. 10-9-2001, FILED 3-17-2001.

KNIGHT TERROR GAMES

NO CLAIM IS MADE TO THE EXCLUSIVE RIGHT TO USE "GAMES", APART FROM THE MARK AS SHOWN.
FOR TOY SOLDIERS AND MINIATURE GAMING PIECES USED FOR BOARD GAMES (U.S. CLS. 22, 23, 38 AND 50).
FIRST USE 1-10-2002; IN COMMERCE 1-10-2002.

CLASS 28—(Continued).

2,572,230. CALLAWAY GOLF COMPANY, CARLSBAD, CA. SN 78-060,269. PUB. 9-11-2001, FILED 4-25-2001.

HX

FOR GOLF BALLS, GOLF CLUBS, GOLF CLUB HEAD COVERS AND GOLF BAGS (U.S. CLS. 22, 23, 38 AND 50).
FIRST USE 9-24-2001; IN COMMERCE 9-24-2001.

2,572,234. SPALDING SPORTS WORLDWIDE, INC., CHICOPPEE, MA. SN 78-068,845. PUB. 10-2-2001, FILED 6-13-2001.

XL 3000

FOR GOLF BALLS (U.S. CLS. 22, 23, 38 AND 50).
FIRST USE 9-24-2001; IN COMMERCE 9-24-2001.

CLASS 29—MEATS AND PROCESSED FOODS

2,571,890. APPLIED SOLUTIONS, INC., CARLSBAD, CA. SN 75-765,693. PUB. 6-6-2000, FILED 8-2-1999.

IOWA MEADOWS

NO CLAIM IS MADE TO THE EXCLUSIVE RIGHT TO USE "IOWA", APART FROM THE MARK AS SHOWN.
FOR BEEF (U.S. CL. 46).
FIRST USE 1-18-2000; IN COMMERCE 1-18-2000.

2,571,970. STATE FISH COMPANY, INC., SAN PEDRO, CA. SN 75-881,131. PUB. 8-8-2000, FILED 12-27-1999.

STATE FISH BLUE FIN

OWNER OF U.S. REG. NOS. 1,945,418 AND 2,309,487.
NO CLAIM IS MADE TO THE EXCLUSIVE RIGHT TO USE "FISH BLUE FIN", APART FROM THE MARK AS SHOWN.
FOR SEAFOOD AND FROZEN FISH (U.S. CL. 46).
FIRST USE 2-17-2000; IN COMMERCE 2-17-2000.

2,571,977. ALIMENTITALIA, SRL, 38014 GARDOLO TN, ITALY. SN 75-886,245. PUB. 11-14-2000, FILED 1-3-2000.

SOLE MEDITERRANEO

THE ENGLISH TRANSLATION OF THE WORDS "SOLE MEDITERRANEO" IS "MEDITERRANEAN SUN".
FOR EDIBLE OILS, NAMELY, OLIVE OILS, AND INFUSED OILS (U.S. CL. 46).
FIRST USE 11-26-2001; IN COMMERCE 11-26-2001.

CLASS 29—(Continued).

2,572,031. WAL-MART STORES, INC., BENTONVILLE, AR, ASSIGNEE OF LOBLAWS INC., TORONTO, ONTARIO M4T 2S7, CANADA. SN 75-981,511. PUB. 12-30-1997, FILED 3-12-1993.



SEC. 2(F).
FOR PROCESSED FISH AND POULTRY; PROCESSED EDIBLE SEEDS; AND SOUPS AND SOUP MIXES (U.S. CL. 46).
FIRST USE 3-8-2000; IN COMMERCE 3-8-2000.

2,572,083. DISNEY ENTERPRISES, INC., BURBANK, CA. SN 76-057,178. PUB. 1-23-2001, FILED 5-25-2000.



FOR FRUIT BASED SNACK FOOD (U.S. CL. 46).
FIRST USE 6-15-2001; IN COMMERCE 6-15-2001.

CLASS 30—STAPLE FOODS

2,571,723. REEVIVE, INC., RYDAL, PA. SN 75-417,173. PUB. 7-6-1999, FILED 1-13-1998.

BERMUDA BEACH COLONY

FOR BEVERAGES, NAMELY, ICED TEAS (U.S. CL. 46).
FIRST USE 12-21-2000; IN COMMERCE 12-21-2000.

2,571,778. SNAK KING CORP., CITY OF INDUSTRY, CA. SN 75-582,780. PUB. 10-10-2000, FILED 11-4-1998.

KING OF SNACKS

OWNER OF U.S. REG. NO. 1,849,986.

CLASS 30—(Continued).

NO CLAIM IS MADE TO THE EXCLUSIVE RIGHT TO USE "SNACKS", APART FROM THE MARK AS SHOWN.

FOR COOKIES; CANDIES EXCLUDING MINTS AND PEPPERMINTS; POPPED POPCORN; PUFFED CORN SNACKS; CORN CHIPS; WHEAT BASED SNACK CHIPS; CHEESE-FLAVORED PUFFED CORN, RICE, POTATO, WHEAT AND VARIOUS COMBINATION-GRAIN SNACKS; SEASONED PUFFED CORN, RICE, POTATO, WHEAT AND VARIOUS COMBINATION-GRAIN SNACKS; UNSEASONED PUFFED CORN, RICE, POTATO, WHEAT AND VARIOUS COMBINATION-GRAIN SNACKS; PUFFED RICE SNACKS; AND SNACK MIXES CONSISTING PRIMARILY OF CRACKERS, PRETZELS, CHIPS AND OTHER PUFFED SNACKS (U.S. CL. 46).
FIRST USE 4-0-1999; IN COMMERCE 4-0-1999.

2,571,789. INVERSIONE CHURRO MANIA C.A., PUERTO LA CRUZ, EDO. ANZOATEGUI, VENEZUELA. SN 75-605,360. PUB. 2-1-2000, FILED 12-4-1998.



NO CLAIM IS MADE TO THE EXCLUSIVE RIGHT TO USE "CHURRO", APART FROM THE MARK AS SHOWN.
FOR SNACK FOOD, NAMELY, CHURROS WITH VARIOUS TOPPING (U.S. CL. 46).
FIRST USE 3-10-1997; IN COMMERCE 4-11-2001.

2,571,897. FIRMENICH INCORPORATED, PLAINSBORO, NJ. SN 75-774,266. PUB. 6-20-2000, FILED 8-13-1999.



THE LINING IS A FEATURE OF THE MARK AND DOES NOT INDICATE COLOR.
FOR NON-NUTRITIONAL NATURAL OR SYNTHETIC FOOD ADDITIVES FOR ENHANCING FLAVORS AND AROMAS OF FOODS AND BEVERAGES (U.S. CL. 46).
FIRST USE 6-2-2000; IN COMMERCE 6-2-2000.

2,571,938. SUN VALLEY RICE CO., LLC, THE, DUNNIGAN, CA. SN 75-842,498. PUB. 11-21-2000, FILED 11-6-1999.

GOLDEN SUN

FOR RICE (U.S. CL. 46).
FIRST USE 9-30-2000; IN COMMERCE 9-30-2000.

CLASS 30—(Continued).

2,572,062. SAN YEH HONG KONG FOOD INC., S. EL MONTE, CA. SN 76-033,071. PUB. 5-29-2001, FILED 4-25-2000.



THE STIPLING SHOWN THE DRAWING IS A FEATURE OF THE MARK AND NOT INTENDED TO INDICATE COLOR.

"THE TRANSLITERATION OF THE FOREIGN (CHINESE) CHARACTERS IS "SAN YEH GOBULI BOA". THE ENGLISH TRANSLATION OF THE WORDING IS "GOBULI BUNS BY SAN YEH"

FOR BUNS (U.S. CL. 46).

FIRST USE 8-21-2001; IN COMMERCE 8-21-2001.

CLASS 31—NATURAL AGRICULTURAL PRODUCTS

2,571,901. MARSHALL FARMS USA, INC., NORTH ROSE, NY. SN 75-781,950. PUB. 9-12-2000, FILED 8-23-1999.

MARSHALL BEAGLE

NO CLAIM IS MADE TO THE EXCLUSIVE RIGHT TO USE "BEAGLE". APART FROM THE MARK AS SHOWN.

FOR LIVE BEAGLES (U.S. CLS. 1 AND 46).

FIRST USE 0-0-1976; IN COMMERCE 0-0-1976.

2,572,096. ROD MCLELLAN CO., SAN MATEO, CA. SN 76-071,269. PUB. 4-17-2001, FILED 6-16-2000.

GARDEN GUARDIAN

FOR MULCHES FOR USE IN GARDENS (U.S. CLS. 1 AND 46).

FIRST USE 1-19-2001; IN COMMERCE 9-8-2001.

CLASS 32—LIGHT BEVERAGES

2,571,690. WORLD TRIATHLON CORPORATION, TARPON SPRINGS, FL. SN 75-096,126. PUB. 4-28-1998, FILED 4-29-1996.

IRONMAN TRIATHLON

OWNER OF U.S. REG. NOS. 1,226,245, 1,353,313, AND 1,705,114.

FOR NON-CARBONATED SOFT DRINKS, NAMELY BOTTLED WATER (U.S. CLS. 45, 46 AND 48).

FIRST USE 10-0-1999; IN COMMERCE 10-0-1999.

CLASS 32—(Continued).

2,571,838. SLEEMAN BREWERIES LTD., GUELPH, ONTARIO N1H 6H9, CANADA. SN 75-692,070. PUB. 7-11-2000, FILED 4-26-1999.



OWNER OF U.S. REG. NO. 1,809,459.

NO CLAIM IS MADE TO THE EXCLUSIVE RIGHT TO USE "BREWERY EST. 1834" OR THE REPRESENTATION OF THE BOTTLE, APART FROM THE MARK AS SHOWN.

THE MARK CONSISTS OF THE REPRESENTATION OF A BEER BOTTLE WITH A LABEL AROUND THE TOP OF THE NECK, AND WITH THE CENTER OF THE BOTTLE SHOWING THE WORDS "SLEEMAN BREWERY EST. 1834" AND THE DESIGN OF A BEAVER IN THE CENTER OF A MAPLE LEAF.

FOR BREWED ALCOHOLIC BEVERAGES, NAMELY, BEER AND ALE (U.S. CLS. 45, 46 AND 48).

FIRST USE 4-7-2001; IN COMMERCE 4-7-2001.

CLASS 33—WINES AND SPIRITS

2,571,910. ROBERT MONDAVI WINERY, NAPA, CA. SN 75-799,635. PUB. 3-28-2000, FILED 9-15-1999.



"ROBERT MONDAVI", A LIVING INDIVIDUAL. MR. MONDAVI'S CONSENT TO REGISTRATION ACCOMPANIES THIS APPLICATION.

FOR WINE (U.S. CLS. 47 AND 49).

FIRST USE 8-0-1999; IN COMMERCE 8-0-1999.

CLASS 33—(Continued).

2,572,051. JACK DANIEL'S PROPERTIES, INC., SAN RAFAEL, CA. SN 76-017,011. PUB. 1-9-2001, FILED 4-3-2000.

JACK LIVES HERE

FOR ALCOHOLIC BEVERAGES, NAMELY DISTILLED SPIRITS (U.S. CLS. 47 AND 49).
FIRST USE 5-31-2000; IN COMMERCE 5-31-2000.

2,572,223. TABLAS CREEK VINEYARD, PASO ROBLES, CA. SN 78-053,487. PUB. 9-18-2001, FILED 3-16-2001.

ANTITHESIS

FOR WINE (U.S. CLS. 47 AND 49).
FIRST USE 1-1-2001; IN COMMERCE 1-8-2001.

CLASS 34—SMOKERS' ARTICLES

2,571,691. CONSOLIDATED CIGAR CORPORATION, FT. LAUDERDALE, FL. SN 75-142,788. PUB. 7-1-1997, FILED 7-31-1996.



NO CLAIM IS MADE TO THE EXCLUSIVE RIGHT TO USE "HAVANA" AND "SWEETS" AND THE DESIGN OF ISLANDS WHICH COMPOSE CUBA, APART FROM THE MARK AS SHOWN.

THE MARK CONSISTS OF THE WORDS "HAVANA" AND "SWEETS" AND A DESIGN WHICH INCLUDES A FRAME, THE OUTLINE OF THE ISLANDS WHICH FORM CUBA, MERIDIAN LINES, AND AN ENCIRCLED STAR.

FOR CIGARS, LITTLE CIGARS, PIPE TOBACCO, ROLL-YOUR-OWN CIGARETTE TOBACCO, AND SMOKELESS TOBACCO ALL CONTAINING TOBACCO GROWN FROM CUBAN TOBACCO SEEDS (U.S. CLS. 2, 8, 9 AND 17).
FIRST USE 9-17-1998; IN COMMERCE 9-17-1998.

CLASS 34—(Continued).

2,571,843. GARNER, ROBBY D., CLINTON, MD. SN 75-699,107. PUB. 1-4-2000, FILED 5-6-1999.

BOZAK

FOR TOBACCO ROLLING PRODUCTS, NAMELY, TOBACCO SHEETS FOR ROLLING INDIVIDUAL TOBACCO PRODUCTS (U.S. CLS. 2, 8, 9 AND 17).
FIRST USE 3-26-2001; IN COMMERCE 3-26-2001.

2,572,047. POGOSIYAN, SEMEN AMAYAKOVICH, YEREVAN, ARMENIA. SN 76-013,627. PUB. 1-30-2001, FILED 3-29-2000.

CIGARONNE

FOR CIGARETTES (U.S. CLS. 2, 8, 9 AND 17).
FIRST USE 4-27-2001; IN COMMERCE 6-1-2001.

SERVICE MARKS**CLASS 35—ADVERTISING AND BUSINESS**

2,571,710. BRIGHTHOUSE, LLC, ATLANTA, GA. BY ASSIGNMENT GGT U.S.A./SOUTH, INC., DBA BRIGHTHOUSE, ATLANTA, GA. SN 75-372,527. PUB. 11-10-1998, FILED 10-14-1997.

PLANE DELICIOUS

FOR RETAIL FOOD OUTLETS FEATURING FOODS AND BEVERAGES (U.S. CLS. 100, 101 AND 102).
FIRST USE 10-0-2000; IN COMMERCE 9-4-2001.

2,571,724. AMERICAN CENTER FOR WINE, FOOD AND THE ARTS, THE, NAPA, CA. SN 75-417,550. PUB. 9-28-1999, FILED 1-13-1998.



FOR RETAIL GIFT STORES (U.S. CLS. 100, 101 AND 102).
FIRST USE 11-18-2001; IN COMMERCE 11-18-2001.

CLASS 35—(Continued).

2,571,771. WEBB PARTNERSHIP, THE, WARWICKSHIRE CV8 1BP, UNITED KINGDOM. SN 75-558,942. PUB. 10-31-2000, FILED 9-25-1998.

The P R · I · © · E Approach

PRIORITY CLAIMED UNDER SEC. 44(D) ON UNITED KINGDOM APPLICATION NO. 2168245, FILED 6-2-1998, REG. NO. 2168245, DATED 2-6-1998, EXPIRES 2-6-2008.
FOR BUSINESS MANAGEMENT CONSULTATION (U.S. CLS. 100, 101 AND 102).
FIRST USE 10-0-1999; IN COMMERCE 10-0-1999.

2,571,818. MATCHCRAFT, INC., MALIBU, CA. SN 75-652,139. PUB. 6-27-2000, FILED 3-2-1999.

MATCHCRAFT

FOR BUSINESS CONSULTATION SERVICES, NAMELY, ASSISTING BUSINESSES AND CONSUMERS IN LOCATING AND IDENTIFYING POTENTIAL MARKETS, PRODUCTS, AND SERVICES OVER A GLOBAL COMPUTER NETWORK AND PROVIDING EVALUATIVE FEEDBACK AND RATINGS OF SELLERS' GOODS AND SERVICES, BUYERS' AND SELLERS' PERFORMANCE, DELIVERY AND OVERALL TRADING EXPERIENCE IN CONNECTION THEREWITH (U.S. CLS. 100, 101 AND 102).
FIRST USE 5-0-1999; IN COMMERCE 12-0-1999.

2,571,831. DUQUESNE LIGHT COMPANY, PITTSBURGH, PA. SN 75-671,558. PUB. 8-22-2000, FILED 3-31-1999.

ELECTRIWEB

FOR PROVIDING A WEBSITE OVER A GLOBAL COMPUTER NETWORK FEATURING PUBLIC UTILITY INFORMATION IN THE NATURE OF CUSTOMER BILLING, USAGE, PAYMENT, AND ACCOUNT INFORMATION (U.S. CLS. 100, 101 AND 102).
FIRST USE 4-16-1999; IN COMMERCE 4-16-1999.

CLASS 35—(Continued).

2,571,851. CREATIVE CONCEPTS OF CHARLOTTE, INC., CHARLOTTE, NC. SN 75-711,088. PUB. 10-17-2000, FILED 5-20-1999.

FORE
THE LINKS

FOR RETAIL STORE SERVICES FEATURING CLOTHING, SPORTING GOODS AND NOVELTY ITEMS (U.S. CLS. 100, 101 AND 102).
FIRST USE 7-1-1999; IN COMMERCE 9-28-1999.

2,571,853. 3KWORLD, LLC, DENVER, CO. SN 75-711,785. PUB. 8-22-2000, FILED 5-21-1999.

3KWORLD

FOR MARKETING AND ADVERTISING SERVICES, NAMELY ELECTRONIC BILLBOARD ADVERTISING FOR OTHERS AND CREATION AND DISSEMINATION OF ADVERTISING FOR OTHERS VIA AN ON-LINE ELECTRONIC COMMUNICATION NETWORK (U.S. CLS. 100, 101 AND 102).
FIRST USE 7-1-1999; IN COMMERCE 7-1-1999.

2,571,864. STORE ROOM - THIRD AVENUE, L.P., THE, FT. LAUDERDALE, FL. SN 75-727,416. PUB. 4-10-2001, FILED 6-11-1999.

THE  STORE ROOM

FOR RETAIL STORE AND MAIL ORDER CATALOG SERVICES FEATURING PACKING AND SHIPPING MATERIALS AND CONTAINERS (U.S. CLS. 100, 101 AND 102).
FIRST USE 8-1-1999; IN COMMERCE 8-1-1999.

CLASS 35—(Continued).

2,571,923. LEWIS, JEFFREY Q., MONTECITO, CA. AND MARTEN, MARCUS, MONTECITO, CA. SN 75-821,810. PUB. 6-20-2000, FILED 10-12-1999.

WAL-MED.COM

FOR ONLINE RETAIL STORE SERVICES FEATURING MEDICAL SUPPLIES, NAMELY, WALKERS, WHEELCHAIRS, CANES, SURGICAL GLOVES, DIABETIC SUPPLIES, NAMELY, SYRINGES, INSULIN, ALCOHOL SWIPES, AND OTHER RELATED MERCHANDISE (U.S. CLS. 100, 101 AND 102).
FIRST USE 8-28-2001; IN COMMERCE 8-28-2001.

2,571,929. NUCLEAR MANAGEMENT COMPANY, LLC, MILWAUKEE, WI. SN 75-830,800. PUB. 2-20-2001, FILED 10-25-1999.

NMC

FOR OPERATION OF BUSINESSES FOR OTHERS, NAMELY, OPERATION OF NUCLEAR POWER PLANTS FOR OTHERS (U.S. CLS. 100, 101 AND 102).
FIRST USE 1-21-2000; IN COMMERCE 1-21-2000.

2,571,932. NUCLEAR MANAGEMENT COMPANY, LLC, MILWAUKEE, WI. SN 75-835,665. PUB. 2-20-2001, FILED 10-28-1999.



FOR OPERATION OF BUSINESSES FOR OTHERS, NAMELY, OPERATION OF NUCLEAR POWER PLANTS FOR OTHERS (U.S. CLS. 100, 101 AND 102).
FIRST USE 1-21-2000; IN COMMERCE 1-21-2000.

CLASS 35—(Continued).

2,571,941. FLUOR CORPORATION, ALISO VIEJO, CA. SN 75-846,597. PUB. 12-5-2000, FILED 11-12-1999.



OWNER OF U.S. REG. NO. 591,442.
NO CLAIM IS MADE TO THE EXCLUSIVE RIGHT TO USE "SERVICES", APART FROM THE MARK AS SHOWN.
FOR BUSINESS MANAGEMENT AND CONSULTATION, NAMELY ADMINISTRATIVE AND SUPPORT SERVICES IN THE MANAGEMENT OF BUSINESS AFFAIRS AND FUNCTIONS (U.S. CLS. 100, 101 AND 102).
FIRST USE 10-15-1999; IN COMMERCE 10-15-1999.

2,571,945. GUITAR AXIS INC., SEATTLE, WA. SN 75-851,733. PUB. 5-1-2001, FILED 11-17-1999.

GUITAR AXIS

NO CLAIM IS MADE TO THE EXCLUSIVE RIGHT TO USE "GUITAR", APART FROM THE MARK AS SHOWN.
FOR ON-LINE RETAIL STORE SERVICES IN THE FIELDS OF MUSICAL INSTRUMENTS AND ACCESSORIES THEREFOR, AND PRINTED PUBLICATIONS AND AUDIO AND VISUAL RECORDINGS RELATING TO MUSIC EDUCATION (U.S. CLS. 100, 101 AND 102).
FIRST USE 4-3-2000; IN COMMERCE 4-3-2000.

2,571,962. CONTRACTOR MARKETPLACE, INC., LOUISVILLE, KY. SN 75-873,134. PUB. 1-16-2001, FILED 12-16-1999.

CONTRACTORS HEAVEN

NO CLAIM IS MADE TO THE EXCLUSIVE RIGHT TO USE "CONTRACTORS", APART FROM THE MARK AS SHOWN.
FOR RETAIL STORE SERVICES, FEATURING CONSTRUCTION EQUIPMENT AND PARTS THEREFOR SOLD ON-LINE AND THROUGH MAIL ORDER (U.S. CLS. 100, 101 AND 102).
FIRST USE 12-0-2000; IN COMMERCE 12-0-2000.

CLASS 35—(Continued).

2,571,969. TOOLEY, JEROME A., OCEANSIDE, CA. SN 75-880,817. PUB. 6-12-2001, FILED 12-27-1999.

THE EVOLUTION OF CELLULAR

NO CLAIM IS MADE TO THE EXCLUSIVE RIGHT TO USE "CELLULAR", APART FROM THE MARK AS SHOWN.

FOR RETAIL STORE SERVICES OF TELECOMMUNICATION EQUIPMENT NAMELY DIGITAL WIRELESS CELLULAR TELEPHONES AND ACCESSORIES (U.S. CLS. 100, 101 AND 102).

FIRST USE 12-10-1998; IN COMMERCE 12-10-1998.

2,571,972. CHARLES & COLVARD, LTD., MORRISVILLE, NC. BY CHANGE OF NAME C3, INC., DBA CHARLES & COLVARD, MORRISVILLE, NC. SN 75-884,781. PUB. 10-10-2000, FILED 12-30-1999.

GIOIELLI MOISS

THE ENGLISH TRANSLATION OF "GIOIELLI" IS "JEWELS".

FOR RETAIL JEWELRY AND FASHION ACCESSORY STORE SERVICES (U.S. CLS. 100, 101 AND 102).

FIRST USE 5-0-1999; IN COMMERCE 5-0-1999.

2,571,982. COMMUNICATION SOCIETY LLC, CARY, IL. SN 75-890,972. PUB. 12-26-2000, FILED 1-6-2000.

GIRGIT

THE ENGLISH TRANSLATION OF THE WORD "GIRGIT" IN THE MARK IS "CHAMELEON" IN HINDU.

FOR DISSEMINATION OF MARKETING AND ADVERTISING INFORMATION FOR OTHERS (U.S. CLS. 100, 101 AND 102).

FIRST USE 11-16-2000; IN COMMERCE 11-16-2000.

2,572,012. PARKER MARKETING RESEARCH, INC., MILFORD, OH. SN 75-928,515. PUB. 4-3-2001, FILED 2-25-2000.

EQUATOR

FOR MARKETING RESEARCH SERVICES (U.S. CLS. 100, 101 AND 102).

FIRST USE 5-10-2000; IN COMMERCE 5-10-2000.

CLASS 35—(Continued).

2,572,017. IMAGICAST, INC., BURLINGAME, CA. SN 75-931,254. PUB. 10-3-2000, FILED 2-29-2000.

IMAGICASTWORKS

FOR PLACING ADVERTISEMENTS FOR OTHERS IN THE RETAIL INDUSTRY; COOPERATIVE ADVERTISING AND MARKETING FOR THE RETAIL INDUSTRY; MARKET ANALYSIS FOR THE RETAIL INDUSTRY; PROMOTING THE SALE OF GOODS AND SERVICES OF OTHERS THROUGH THE USE OF POINT-OF-SALE INTERACTIVE MULTIMEDIA DISPLAY UNITS (U.S. CLS. 100, 101 AND 102).

FIRST USE 2-16-1999; IN COMMERCE 2-26-2000.

2,572,126. EPNEUMATICS, INC., SANTA FE SPRINGS, CA. SN 76-105,623. PUB. 5-8-2001, FILED 8-9-2000.

EZPNEUMATICS

FOR ONLINE RETAILING IN THE FIELD OF INDUSTRIAL PNEUMATIC EQUIPMENT (U.S. CLS. 100, 101 AND 102).

FIRST USE 6-0-2001; IN COMMERCE 6-0-2001.

2,572,133. IMPACT IDEALSOLUTIONS, INC., DENVER, CO. SN 76-118,000. PUB. 6-12-2001, FILED 8-29-2000.

E-TERIORS

FOR PROVIDING AN ELECTRONIC BASED PRODUCT CATALOG OF FURNITURE FOR THE INTERIOR DESIGN INDUSTRY AND PROVIDING AN INTEGRATED ORDER COMMUNICATIONS NETWORK TO PLACE ORDERS FOR FURNITURE AND TO DETERMINE ORDER STATUS FOR INTERIOR DESIGNERS, FURNITURE SHOWROOMS AND FURNITURE MANUFACTURERS, ALL VIA A WORLDWIDE GLOBAL COMPUTER INFORMATION NETWORK (U.S. CLS. 100, 101 AND 102).

FIRST USE 1-1-2001; IN COMMERCE 1-1-2001.

2,572,148. DIVERSIFIED INNOVATIONS, HADDONFIELD, NJ. SN 76-146,992. PUB. 7-31-2001, FILED 10-16-2000.

MOUNTAIN CHALET

FOR MAIL ORDER CATALOG SERVICES FEATURING GIFTS AND NOVELTIES (U.S. CLS. 100, 101 AND 102).

FIRST USE 10-1-1998; IN COMMERCE 10-1-1998.

CLASS 35—(Continued).

2,572,197. VISA U.S.A. INC., FOSTER CITY, CA. SN 78-019,208. PUB. 3-20-2001, FILED 8-1-2000.

YOU'VE GOT WHAT IT TAKES

FOR PROMOTING THE SALE OF THE GOODS AND SERVICES OF OTHERS BY PROVIDING DISCOUNTS AND INCENTIVES IN THE NATURE OF SWEEPSTAKES, DISCOUNTS, REBATES, VALUE ADDED OFFERS OR THE DISTRIBUTION OF PREMIUMS OR COUPONS, FOR THOSE USING PAYMENT CARDS TO PAY FOR SUCH SALES (U.S. CLS. 100, 101 AND 102).

FIRST USE 10-1-2000; IN COMMERCE 10-1-2000.

2,572,216. INTERNET HEADQUARTERS, INC., ROCHESTER, NY. SN 78-041,366. PUB. 8-7-2001, FILED 1-2-2001.

SILICON FALLS

FOR PROMOTING ECONOMIC DEVELOPMENT IN THE WESTERN REGION OF THE STATE OF NEW YORK, COUNTRY OF USA; PROMOTING BUSINESS AND TOURISM IN THE CITIES OF ROCHESTER, BUFFALO, AND NIAGARA FALLS, NEW YORK; AND ADVERTISING SERVICES IN THE NATURE OF PROVIDING LINKS TO THE CONTENT WEB ADVERTISING OF OTHERS (U.S. CLS. 100, 101 AND 102).

FIRST USE 3-1-2000; IN COMMERCE 3-1-2000.

2,572,218. FLEXMOMS.COM, INC., MILL VALLEY, CA. SN 78-041,927. PUB. 8-7-2001, FILED 1-5-2001.

FLEXMOMS.COM

FOR JOB PLACEMENT SERVICES AND INFORMATION PROVIDED VIA A GLOBAL COMPUTER NETWORK, NAMELY, PROVIDING INFORMATION ON ALL ASPECT OF OBTAINING EMPLOYMENT AND LISTING OF EMPLOYMENT OPPORTUNITIES VIA THE GLOBAL COMPUTER NETWORK (U.S. CLS. 100, 101 AND 102).

FIRST USE 1-1-2001; IN COMMERCE 7-1-2001.

CLASS 36—INSURANCE AND FINANCIAL

2,571,769. PRINCIPAL FINANCIAL GROUP, INC., DES MOINES, IA. SN 75-553,582. PUB. 3-13-2001, FILED 9-15-1998.

TRUSTAR

FOR FINANCIAL SERVICES, NAMELY, PENSION PLAN CONSULTING AND ADMINISTRATION SERVICES, 401(K) PLAN CONSULTING AND ADMINISTRATION SERVICES, AND PROFIT SHARING PLAN CONSULTING AND ADMINISTRATION SERVICES (U.S. CLS. 100, 101 AND 102).

FIRST USE 1-0-1999; IN COMMERCE 1-0-1999.

CLASS 36—(Continued).

2,571,775. WASHINGTON MUTUAL, INC., SEATTLE, WA. SN 75-576,854. PUB. 1-25-2000, FILED 10-23-1998.



OWNER OF U.S. REG. NO. 1,214,303.
NO CLAIM IS MADE TO THE EXCLUSIVE RIGHT TO USE "BUSINESS BANK" OR "A DIVISION OF", APART FROM THE MARK AS SHOWN.

SEC. 2(F) AS TO WASHINGTON MUTUAL.
FOR BANKING SERVICES; MORTGAGE AND CONSUMER LENDING SERVICES; AND PHILANTHROPIC SERVICES CONCERNING MONETARY DONATIONS (U.S. CLS. 100, 101 AND 102).

FIRST USE 11-28-1998; IN COMMERCE 11-28-1998.

2,571,871. FEDERAL NATIONAL MORTGAGE ASSOCIATION, DBA FANNIE MAE, WASHINGTON, DC. SN 75-736,640. PUB. 1-25-2000, FILED 6-24-1999.

DEAL FACTORY

FOR FINANCIAL SERVICES, NAMELY, ANALYSIS OF POOLS OF LOANS; COMPUTERIZED CREDIT SCORING AND VALUATION OF LOAN PORTFOLIOS; MORTGAGE LOAN AND FINANCING SERVICES, NAMELY, FACILITATING THE SALE OF SINGLE-FAMILY RESIDENTIAL MORTGAGES BY OTHERS; PROVISION OF FINANCIAL INFORMATION AND INFORMATION ON MORTGAGES OVER A GLOBAL COMMUNICATIONS NETWORK; COMPUTER SERVICES, NAMELY, PROVIDING SECURE ONLINE ACCESS TO AND TRANSMISSION OF FILES AND DATA IN THE FIELD OF FINANCE AND LENDING (U.S. CLS. 100, 101 AND 102).

FIRST USE 12-17-1999; IN COMMERCE 12-17-1999.

2,571,874. CITICORP, NEW YORK, NY. SN 75-740,646. PUB. 6-27-2000, FILED 6-30-1999.

CLICK CITI

FOR FINANCIAL SERVICES, NAMELY, BANKING, CREDIT CARD SERVICES, AND LINES OF CREDIT; FACILITATING SECURE FINANCIAL TRANSACTIONS THROUGH ELECTRONIC COMMERCE, NAMELY, ELECTRONIC FUNDS TRANSFERS, ELECTRONIC CASH AND ELECTRONIC CREDIT CARD TRANSACTIONS, ELECTRONIC BILL PAYMENT, AND ELECTRONIC DEBIT TRANSACTIONS, ALL OFFERED BY MEANS OF A GLOBAL COMPUTER INFORMATION NETWORK; ONLINE INTERACTIVE NEWS AND INFORMATION IN THE BANKING AND FINANCIAL INDUSTRIES PROVIDED BY MEANS OF A GLOBAL COMPUTER NETWORK (U.S. CLS. 100, 101 AND 102).

FIRST USE 10-19-1999; IN COMMERCE 10-19-1999.

CLASS 36—(Continued).

2,571,920. OH COMPANY, THE, LOS ANGELES, CA. SN 75-817,981. PUB. 6-13-2000, FILED 10-7-1999.



NO CLAIM IS MADE TO THE EXCLUSIVE RIGHT TO USE "CO", APART FROM THE MARK AS SHOWN.
FOR PROVIDING AN ON-LINE COMPUTER DATABASE IN THE FIELD OF REAL ESTATE DEVELOPMENT SERVICES (U.S. CLS. 100, 101 AND 102).
FIRST USE 3-19-2001; IN COMMERCE 3-19-2001.

2,571,922. REVAL.COM, INC., NEW YORK, NY. SN 75-821,375. PUB. 8-1-2000, FILED 10-12-1999.

REVAL

FOR FINANCIAL PORTFOLIO MANAGEMENT PROVIDED OVER A GLOBAL COMPUTER NETWORK (U.S. CLS. 100, 101 AND 102).
FIRST USE 7-0-2000; IN COMMERCE 7-0-2000.

CLASS 36—(Continued).

2,571,928. GENERATIONS FINANCIAL ADVISORS, INC., SALISBURY, MD. SN 75-828,379. PUB. 8-29-2000, FILED 10-20-1999.

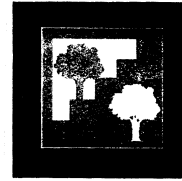

GENERATIONS
FINANCIAL
ADVISORS

NO CLAIM IS MADE TO THE EXCLUSIVE RIGHT TO USE "FINANCIAL ADVISORS", APART FROM THE MARK AS SHOWN.

FOR COMPREHENSIVE INVESTMENT AND CAPITAL MANAGEMENT SERVICES, NAMELY ESTATE PLANNING, RETIREMENT PLANNING, TAX PLANNING AND ASSET MANAGEMENT (U.S. CLS. 100, 101 AND 102).

FIRST USE 10-26-2000; IN COMMERCE 10-26-2000.

2,571,953. INDIANA MEMBERS CREDIT UNION, INDIANAPOLIS, IN. SN 75-863,266. PUB. 4-17-2001, FILED 12-6-1999.

THE POWER OF MEMBER BANKING

FOR FINANCIAL SERVICES, NAMELY, BANKING AND CREDIT UNION SERVICES (U.S. CLS. 100, 101 AND 102).

FIRST USE 11-30-1999; IN COMMERCE 11-29-2001.

2,571,993. AMERICAN STOCK EXCHANGE, LLC, NEW YORK, NY. SN 75-903,655. PUB. 8-29-2000, FILED 1-26-2000.

EQPRIORITY

FOR SECURITIES EXCHANGE SERVICES, NAMELY, PROVIDING A MARKET FOR THE TRADING OF EQUITY SECURITIES AND DERIVATIVE INSTRUMENTS; PROVIDING FINANCIAL INFORMATION ABOUT SECURITIES AND CORPORATIONS ISSUING SECURITIES; COMPILING AND DISSEMINATING TRADE AND QUOTE, INDEX VALUE, AND OTHER MARKET INFORMATION (U.S. CLS. 100, 101 AND 102).
FIRST USE 9-18-2000; IN COMMERCE 9-18-2000.

CLASS 36—(Continued).

2,572,008. MHA INSURANCE COMPANY, LANSING, MI. SN 75-925,757. PUB. 1-23-2001, FILED 2-22-2000.

MHA FINANCIAL

NO CLAIM IS MADE TO THE EXCLUSIVE RIGHT TO USE "FINANCIAL", APART FROM THE MARK AS SHOWN.

FOR INSURANCE AGENCIES IN THE FIELDS OF PROFESSIONAL AND GENERAL LIABILITY INSURANCE FOR HEALTH CARE PROVIDERS; INSURANCE CONSULTATION (U.S. CLS. 100, 101 AND 102).

FIRST USE 4-12-2000; IN COMMERCE 4-12-2000.

CLASS 36—(Continued).

2,572,072. LML PAYMENT SYSTEMS CORP., DALLAS, TX. SN 76-043,292. PUB. 9-25-2001, FILED 5-5-2000.

LML PAYMENT SYSTEMS

2,572,027. NEW WIRELESS SERVICES, INC., WOBURN, MA. SN 75-945,092. PUB. 6-12-2001, FILED 2-23-2000.

WIRELESS WALLET

NO CLAIM IS MADE TO THE EXCLUSIVE RIGHT TO USE "WIRELESS", APART FROM THE MARK AS SHOWN.

FOR BANKING SERVICES VIA WIRELESS TELECOMMUNICATIONS DEVICES AND THE INTERNET (U.S. CLS. 100, 101 AND 102).

FIRST USE 2-26-2001; IN COMMERCE 9-1-2001.

2,572,043. E-NICIAL VENTURES ADVISORS LLC, NEW YORK, NY. BY CHANGE OF NAME CONEXION CAPITAL ADVISORS LLC, NEW YORK, NY. SN 76-006,815. PUB. 2-6-2001, FILED 3-22-2000.

E-NICIAL

FOR FINANCIAL CONSULTING SERVICES, INVESTMENT MANAGEMENT SERVICES, FINANCIAL CLEARINGHOUSE SERVICES; INVESTMENT TRUST SERVICES FOR HOLDING COMPANIES; BROKERAGE SERVICES RELATING TO STOCKS, BONDS AND REAL ESTATE; MUTUAL FUND SERVICES; HEDGE FUND SERVICES; FINANCIAL ANALYSIS; BANKING SERVICES; INVESTMENT SERVICES FOR OTHERS; FIDUCIARY REPRESENTATIVE; FINANCIAL MANAGEMENT (U.S. CLS. 100, 101 AND 102).

FIRST USE 1-0-2000; IN COMMERCE 4-14-2000.

2,572,058. CLASSNOTES INC., SACRAMENTO, CA. SN 76-028,634. PUB. 6-5-2001, FILED 4-18-2000.

ZAP APP

NO CLAIM IS MADE TO THE EXCLUSIVE RIGHT TO USE "APP", APART FROM THE MARK AS SHOWN.

FOR FINANCIAL SERVICES, NAMELY MONEY LENDING (U.S. CLS. 100, 101 AND 102).

FIRST USE 6-0-2000; IN COMMERCE 6-0-2000.

NO CLAIM IS MADE TO THE EXCLUSIVE RIGHT TO USE "PAYMENT SYSTEMS", APART FROM THE MARK AS SHOWN.

FOR CHECK VERIFICATION, CREDIT RECOVERY AND COLLECTION SERVICES, CHECK AUTHORIZATION SERVICES; CHECK ACCEPTANCE SERVICES; CHECK GUARANTEE SERVICES; PAYMENT PROCESSING, NAMELY, ELECTRONIC PROCESSING OF CHECK, CREDIT, CREDIT CARD AND DEBIT CARD PAYMENT TRANSACTIONS, AND AUTOMATIC PAYMENT DEDUCTION SERVICES FOR CUSTOMERS; FINANCIAL RISK MANAGEMENT SERVICES; PROCESSING RECURRENT PAYMENTS AND AUTOMATICALLY DEDUCTING SUCH PAYMENTS FROM BANK ACCOUNTS FOR CUSTOMERS; FRAUD CONTROL SERVICES IN THE NATURE OF CORRECTING BANK INFORMATION ON CHECKS PRESENTED FOR PAYMENT; CHECK CHARGE SERVICES BY TELEPHONE AND OVER THE INTERNET, NAMELY, ELECTRONIC AND TELEPHONIC ACCEPTANCE, AUTHORIZATION AND PROCESSING OF CHECK TRANSACTIONS, AND ELECTRONIC CHECK CONVERSION RENDERED TO RETAIL ESTABLISHMENTS AT THE POINT OF SALE OR POINT OF PURCHASE, WHOLESALERS, THIRD PARTY PROVIDERS OF CHECK AUTHORIZATION AND LOCKBOX AND BILL REMITTANCE PROVIDERS; AND RELATED FRAUD SCREENING SERVICES, NAMELY, VERIFICATION OF PAYMENT REQUESTS AND FUNDS SUFFICIENCY, AND FRAUD AND RISK MANAGEMENT SERVICES, NAMELY POINT OF SALE OR POINT OF PURCHASE INTERNET-BASED AND TELEPHONIC DETECTION OF CHECK FRAUD AND INFORMATION COMPARISON AND IDENTITY MANIPULATION SEARCHING; AND FINANCIAL TRANSACTION PROCESSING SERVICES, NAMELY, ELECTRONIC FUNDS TRANSFER, ELECTRONIC BENEFITS TRANSFER, PROCESSING EMPLOYEE DISCOUNT AND LOYALTY PROGRAM TRANSACTIONS FOR OTHERS; COLLECTION AGENCY SERVICES; ELECTRONIC CHECK REPRESENTMENT SERVICES, NAMELY, ELECTRONIC RE-SUBMISSION TO FINANCIAL INSTITUTION ON WHICH CHECK HAS BEEN DRAWN FOR PAYMENT OF A CHECK WHICH PREVIOUSLY HAS BEEN DISHONORED DUE TO INSUFFICIENT FUNDS IN PAYOR'S ACCOUNT; AND ELECTRONIC CHECK PROCESSING SERVICES CONDUCTED OVER THE INTERNET (U.S. CLS. 100, 101 AND 102).

FIRST USE 4-30-2000; IN COMMERCE 4-30-2000.

CLASS 36—(Continued).

2,572,073. LML PAYMENT SYSTEMS CORP., DALLAS, TX, BY ASSIGNMENT, BY CHANGE OF NAME; BY CHANGE OF NAME LML PAYMENT SYSTEMS, INC., VANCOUVER, BRITISH COLUMBIA V6E 4G1, CANADA. SN 76-043,294. PUB. 9-4-2001, FILED 5-5-2000.



FOR CHECK VERIFICATION, CREDIT RECOVERY AND COLLECTION SERVICES, CHECK AUTHORIZATION SERVICES; CHECK ACCEPTANCE SERVICES; CHECK GUARANTEE SERVICES; PAYMENT PROCESSING, NAMELY, ELECTRONIC PROCESSING OF CHECK, CREDIT, CREDIT CARD AND DEBIT CARD PAYMENT TRANSACTIONS, AND AUTOMATIC PAYMENT DEDUCTION SERVICES FOR CUSTOMERS; FINANCIAL RISK MANAGEMENT SERVICES; PROCESSING RECURRENT PAYMENTS AND AUTOMATICALLY DEDUCTING SUCH PAYMENTS FROM BANK ACCOUNTS FOR CUSTOMERS; FRAUD CONTROL SERVICES IN THE NATURE OF CORRECTING BANK INFORMATION ON CHECKS PRESENTED FOR PAYMENT; CHECK CHARGE SERVICES BY TELEPHONE AND OVER THE INTERNET; NAMELY, ELECTRONIC AND TELEPHONIC ACCEPTANCE, AUTHORIZATION AND PROCESSING OF CHECK TRANSACTIONS, AND ELECTRONIC CHECK CONVERSION RENDERED TO RETAIL ESTABLISHMENTS AT THE POINT OF SALE OR POINT OF PURCHASE, WHOLESALE, THIRD PARTY PROVIDERS OF CHECK AUTHORIZATION AND LOCKBOX AND BILL REMITTANCE PROVIDERS; AND RELATED FRAUD SCREENING SERVICES, NAMELY VERIFICATION OF PAYMENT REQUESTS AND FUNDS SUFFICIENCY, AND FRAUD AND RISK MANAGEMENT SERVICES, NAMELY, POINT OF SALE OR POINT OF PURCHASE INTERNET-BASED AND TELEPHONIC DETECTION OF CHECK FRAUD AND INFORMATION COMPARISON AND IDENTITY MANIPULATION SEARCHING; AND FINANCIAL TRANSACTION PROCESSING SERVICES, NAMELY, ELECTRONIC FUNDS TRANSFER, ELECTRONIC BENEFITS TRANSFER, PROCESSING EMPLOYEE DISCOUNT AND LOYALTY PROGRAM TRANSACTIONS FOR OTHERS; COLLECTION AGENCY SERVICES; ELECTRONIC CHECK REPRESENTMENT SERVICES, NAMELY ELECTRONIC SUBMISSION TO FINANCIAL INSTITUTION ON WHICH CHECK HAS BEEN DRAWN FOR PAYMENT OF A CHECK WHICH PREVIOUSLY HAS BEEN DISHONORED DUE TO INSUFFICIENT FUNDS IN PAYOR'S ACCOUNT; AND ELECTRONIC CHECK PROCESSING SERVICES CONDUCTED OVER THE INTERNET (U.S. CLS. 100, 101 AND 102).

FIRST USE 4-30-2000; IN COMMERCE 4-30-2000.

2,572,076. CIBC NATIONAL BANK, MAITLAND, FL. SN 76-046,073. PUB. 4-3-2001, FILED 5-11-2000.

FRESH BANKING DELIVERED DAILY

FOR BANKING SERVICES (U.S. CLS. 100, 101 AND 102).
FIRST USE 6-1-2000; IN COMMERCE 6-1-2000.

CLASS 36—(Continued).

2,572,104. LAFAIVE, DOUGLAS L., WEST HARTFORD, CT. SN 76-077,952. PUB. 5-22-2001, FILED 6-28-2000.

ADVOCATES FOR THE INSURED WWW.CLAIMSHELP.COM

NO CLAIM IS MADE TO THE EXCLUSIVE RIGHT TO USE "ADVOCATES FOR THE INSURED", APART FROM THE MARK AS SHOWN.

FOR CLAIMS ADJUSTMENT IN THE FIELD OF INSURANCE SERVICES OF PUBLIC ADJUSTING OFFERED TO THE INSURED FOR A FEE (U.S. CLS. 100, 101 AND 102).

FIRST USE 6-1-1994; IN COMMERCE 6-1-1996.

2,572,116. MANUFACTURERS LIFE INSURANCE COMPANY OF NORTH AMERICA, THE, BOSTON, MA. SN 76-091,414. PUB. 5-22-2001, FILED 7-18-2000.

SECURE PRINCIPAL PROGRAM

NO CLAIM IS MADE TO THE EXCLUSIVE RIGHT TO USE "PROGRAM", APART FROM THE MARK AS SHOWN. FOR LIFE INSURANCE SERVICES, NAMELY, ADMINISTERING FIXED AND VARIABLE ANNUITIES (U.S. CLS. 100, 101 AND 102).

FIRST USE 9-1-2001; IN COMMERCE 9-1-2001.

2,572,122. TRICORP FEDERAL CREDIT UNION, WESTBROOK, ME. SN 76-100,480. PUB. 5-22-2001, FILED 8-1-2000.

INROADS

FOR FINANCIAL SERVICES PROVIDING CREDIT UNIONS WITH ACCOUNT INFORMATION AND ELECTRONIC TRANSACTIONS VIA A GLOBAL COMPUTER NETWORK (U.S. CLS. 100, 101 AND 102).

FIRST USE 5-1-2001; IN COMMERCE 5-1-2001.

2,572,124. AT&T CORP., NEW YORK, NY. SN 76-103,756. PUB. 5-1-2001, FILED 8-4-2000.

THREE NINE ALL THE TIME

FOR TELECOMMUNICATIONS CALLING CARD SERVICES (U.S. CLS. 100, 101 AND 102).
FIRST USE 3-31-2001; IN COMMERCE 3-31-2001.

CLASS 36—(Continued).

2,572,140. WELLS FARGO & COMPANY, MINNEAPOLIS, MN. SN 76-130,824. PUB. 6-12-2001, FILED 9-19-2000.

PICTURE IT

FOR CREDIT CARD SERVICES (U.S. CLS. 100, 101 AND 102).
FIRST USE 10-17-2000; IN COMMERCE 10-17-2000.

2,572,151. LEGACY CAPITAL GROUP CALIFORNIA, LOS ALTOS, CA. SN 76-157,010. PUB. 6-26-2001, FILED 10-30-2000.

SAFE BASE

FOR FINANCIAL SERVICES, NAMELY, CONSULTATION SERVICES TO BUSINESSES AND INDIVIDUALS FOR FINANCIAL AND INVESTMENT PLANNING, ESTATE PLANNING, FINANCIAL AND INVESTMENT MANAGEMENT SERVICES (U.S. CLS. 100, 101 AND 102).
FIRST USE 1-1-1999; IN COMMERCE 1-1-1999.

2,572,173. TRISTAR PROTECTION PLAN INC., MASON, OH. SN 76-194,430. PUB. 8-14-2001, FILED 1-16-2001.

TRISTAR PROTECTION PLAN

NO CLAIM IS MADE TO THE EXCLUSIVE RIGHT TO USE "PROTECTION PLAN", APART FROM THE MARK AS SHOWN.

FOR INSURANCE SERVICES, NAMELY EXTENDED WARRANTY CONTRACTS FOR AUTOMOBILES (U.S. CLS. 100, 101 AND 102).
FIRST USE 8-27-2001; IN COMMERCE 8-27-2001.

CLASS 37—CONSTRUCTION AND REPAIR

2,571,793. MIAMI-DADE EXPRESSWAY AUTHORITY, MIAMI, FL. SN 75-610,818. PUB. 5-30-2000, FILED 12-22-1998.

MDX

FOR MANAGEMENT AND SUPERVISION OF THE CONSTRUCTION AND MAINTENANCE OF ROADS AND TOLLED LIMITED ACCESS EXPRESSWAYS (U.S. CLS. 100, 103 AND 106).
FIRST USE 2-0-1999; IN COMMERCE 2-0-1999.

CLASS 37—(Continued).

2,571,794. MIAMI-DADE EXPRESSWAY AUTHORITY, MIAMI, FL. SN 75-610,823. PUB. 5-30-2000, FILED 12-22-1998.



FOR PROVIDING INFORMATION ABOUT EXPRESSWAY CONSTRUCTION AND EXPRESSWAY MAINTENANCE VIA A GLOBAL COMPUTER NETWORK (U.S. CLS. 100, 103 AND 106).
FIRST USE 2-0-1999; IN COMMERCE 2-0-1999.

2,572,001. PARTEK FOREST AB, S-904 04 UMEA, SWEDEN. SN 75-912,143. PUB. 12-26-2000, FILED 2-7-2000.

PROACT

FOR MAINTENANCE AND REPAIR OF MACHINES USED IN FORESTRY (U.S. CLS. 100, 103 AND 106).
FIRST USE 10-1-2000; IN COMMERCE 10-1-2000.

2,572,064. SPINNER, LAURA, FOREST HILLS, NY. SN 76-033,857. PUB. 4-10-2001, FILED 4-25-2000.

WRITING ON THE WALL

FOR INTERIOR MURAL PAINTING SERVICES (U.S. CLS. 100, 103 AND 106).
FIRST USE 8-0-2000; IN COMMERCE 8-0-2000.

2,572,098. AUTONATION HOLDING CORP., FORT LAUDERDALE, FL. BY ASSIGNMENT AUTONATION, INC., FORT LAUDERDALE, FL. SN 76-071,820. PUB. 4-3-2001, FILED 6-16-2000.

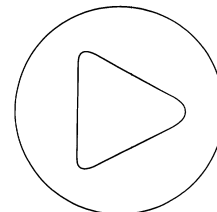

FOR AUTOMOBILE REPAIR AND MAINTENANCE SERVICES (U.S. CLS. 100, 103 AND 106).
FIRST USE 7-0-2000; IN COMMERCE 7-0-2000.

CLASS 38—COMMUNICATION

2,571,758. BELLSOUTH INTELLECTUAL PROPERTY CORPORATION, WILMINGTON, DE. SN 75-510,658. PUB. 5-9-2000, FILED 6-29-1998.

CALL WIZARD

NO CLAIM IS MADE TO THE EXCLUSIVE RIGHT TO USE "CALL", APART FROM THE MARK AS SHOWN. FOR TELEPHONE COMMUNICATIONS SERVICES (U.S. CLS. 100, 101 AND 104).
FIRST USE 10-1-1998; IN COMMERCE 10-1-1998.

2,571,889. WORLDBYNET.COM, INC., HOUSTON, TX. SN 75-765,257. PUB. 3-21-2000, FILED 8-25-1999.

WORLDBYNET.COM

FOR PROVIDING MULTIPLE-USER ACCESS TO A GLOBAL COMPUTER INFORMATION NETWORK OF ON-LINE RETAILERS ORGANIZED BY COUNTRY OF ORIGIN (U.S. CLS. 100, 101 AND 104).
FIRST USE 8-20-1999; IN COMMERCE 8-20-1999.

2,571,995. CASCADE BROADCASTING GROUP, L.L.C., BOISE, ID. SN 75-905,689. PUB. 12-26-2000, FILED 1-28-2000.

CASCADE BROADCASTING GROUP

NO CLAIM IS MADE TO THE EXCLUSIVE RIGHT TO USE "BROADCASTING GROUP", APART FROM THE MARK AS SHOWN. FOR TELEVISION BROADCASTING SERVICES (U.S. CLS. 100, 101 AND 104).
FIRST USE 1-1-2001; IN COMMERCE 1-1-2001.

2,572,087. PUBLIC BROADCASTING SERVICE, ALEXANDRIA, VA. SN 76-063,828. PUB. 4-17-2001, FILED 6-6-2000.

STAY CURIOUS

FOR TELEVISION BROADCASTING, SATELLITE TRANSMISSION SERVICES, CABLE TELEVISION BROADCASTING AND CABLE TELEVISION TRANSMISSION SERVICES (U.S. CLS. 100, 101 AND 104).
FIRST USE 7-31-2000; IN COMMERCE 7-31-2000.

CLASS 38—(Continued).

2,572,139. CITIZENS COMMUNICATIONS COMPANY, STANFORD, CT. BY ASSIGNMENT GLOBAL CROSSING NORTH AMERICA, INC., ROCHESTER, NY. SN 76-127,888. PUB. 6-5-2001, FILED 9-15-2000.

VERSALINE

FOR TELECOMMUNICATIONS SERVICES, NAMELY, LOCAL TELEPHONE SERVICES AND VOICE MESSAGING SERVICES (U.S. CLS. 100, 101 AND 104).
FIRST USE 7-0-2000; IN COMMERCE 7-0-2000.

2,572,205. CH1 COMMUNICATIONS INC., NEW YORK, NY. SN 78-029,605. PUB. 7-3-2001, FILED 10-7-2000.

REACH THE WORLD THROUGH US

FOR VIDEO, AUDIO AND DATA NARROWCASTING SERVICES (U.S. CLS. 100, 101 AND 104).
FIRST USE 9-1-2000; IN COMMERCE 11-1-2000.

2,572,210. SHOWTIME NETWORKS INC., NEW YORK, NY. SN 78-034,274. PUB. 6-5-2001, FILED 11-8-2000.

SHOWTIME NEXT

OWNER OF U.S. REG. NOS. 1,075,211, 2,180,434, AND OTHERS. FOR TELECOMMUNICATION SERVICES, NAMELY, CABLE, CABLE RADIO AND SATELLITE TRANSMISSION SERVICES RENDERED THROUGH THE MEDIUMS OF TELEVISION, CABLE TELEVISION AND SATELLITE DELIVERED SYSTEMS IN THE HIGH-DEFINITION FORMAT (U.S. CLS. 100, 101 AND 104).
FIRST USE 3-1-2001; IN COMMERCE 3-1-2001.

2,572,219. AT&T CORP., NEW YORK, NY. SN 78-046,892. PUB. 9-11-2001, FILED 2-6-2001.

AT&T VIEW-N-PAY

OWNER OF U.S. REG. NOS. 1,293,305, 1,296,936, AND 1,298,084. FOR TELECOMMUNICATIONS SERVICES, NAMELY, THE ELECTRONIC TRANSMISSION OF VOICE, DATA, VIDEO, FACSIMILE AND INFORMATION (U.S. CLS. 100, 101 AND 104).
FIRST USE 8-0-2001; IN COMMERCE 8-0-2001.

CLASS 38—(Continued).

2,572,221. SHOWTIME NETWORKS INC., NEW YORK, NY. SN 78-053,473. PUB. 9-18-2001, FILED 3-16-2001.

ONSCREEN. ONLINE. ON THE STREET.

FOR TELECOMMUNICATION SERVICES, NAMELY, CABLE, CABLE RADIO AND SATELLITE TRANSMISSION SERVICES RENDERED THROUGH THE MEDIUMS OF TELEVISION, CABLE TELEVISION AND SATELLITE DELIVERED SYSTEMS IN THE HIGH-DEFINITION FORMAT (U.S. CLS. 100, 101 AND 104).
FIRST USE 3-1-2001; IN COMMERCE 3-1-2001.

CLASS 39—TRANSPORTATION AND STORAGE

2,571,883. AERONET, INC., IRVINE, CA. SN 75-756,222. PUB. 12-19-2000, FILED 7-21-1999.

AERONET.COM

OWNER OF U.S. REG. NO. 1,589,363.
FOR AIRFREIGHT FORWARDING SERVICES, COURIER SERVICES, AND AIRPLANE CHARTERING SERVICES (U.S. CLS. 100 AND 105).
FIRST USE 7-16-1996; IN COMMERCE 7-16-1996.

2,571,931. FULFILLMENT PLUS, INC, WALTHAM, MA. SN 75-833,656. PUB. 2-27-2001, FILED 10-28-1999.

ADDING THE HUMAN TOUCH TO .COM

FOR WAREHOUSE STORAGE OF TELECOMMUNICATIONS EQUIPMENT; PACKAGING TELECOMMUNICATIONS EQUIPMENT FOR TRANSPORTATION; SHIPMENT OF TELECOMMUNICATIONS EQUIPMENT VIA GROUND AND AIR TRANSPORTATION (U.S. CLS. 100 AND 105).
FIRST USE 11-15-1999; IN COMMERCE 11-15-1999.

CLASS 39—(Continued).

2,571,944. LEANLOGISTICS, INC., HOLLAND, MI, BY MERGER LEANLOGISTICS.COM, HOLLAND, MI. SN 75-849,931. PUB. 10-24-2000, FILED 11-16-1999.

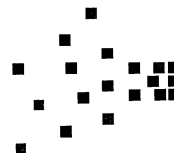

FOR TRANSPORTATION SERVICES, NAMELY, SUPPLY CHAIN MANAGEMENT FOR BUYING AND SELLING FREIGHT TRANSPORTATION SERVICES VIA THE GLOBAL COMPUTER NETWORK (U.S. CLS. 100 AND 105).
FIRST USE 8-0-1999; IN COMMERCE 8-0-1999.

2,572,028. SILVERSEA CRUISES LTD., FORT LAUDERDALE, FL. SN 75-950,575. PUB. 11-14-2000, FILED 3-1-2000.

SILVER WHISPER

FOR CRUISE SHIP SERVICES (U.S. CLS. 100 AND 105).
FIRST USE 9-24-2001; IN COMMERCE 9-24-2001.

2,572,109. LEANLOGISTICS, INC., HOLLAND, MI, BY MERGER LEANLOGISTICS.COM, HOLLAND, MI. SN 76-084,039. PUB. 5-8-2001, FILED 7-5-2000.

LEANXCHANGE

FOR TRANSPORTATION SERVICES, NAMELY, SUPPLY CHAIN MANAGEMENT FOR BUYING AND SELLING FREIGHT TRANSPORTATION SERVICES VIA THE GLOBAL COMPUTER NETWORK (U.S. CLS. 100 AND 105).
FIRST USE 2-0-2001; IN COMMERCE 2-0-2001.

CLASS 40—MATERIAL TREATMENT

2,571,702. NIETO, EDUARDO, LOS ANGELES, CA. SN 75-330,770. PUB. 11-3-1998, FILED 7-25-1997.

DIGITAL XPOSURE

NO CLAIM IS MADE TO THE EXCLUSIVE RIGHT TO USE "DIGITAL", APART FROM THE MARK AS SHOWN.
FOR PROVIDING CUSTOM EDITING AND MANIPULATION OF PHOTOGRAPHS ON THE GLOBAL COMPUTER NETWORK (U.S. CLS. 100, 103 AND 106).
FIRST USE 7-25-2000; IN COMMERCE 7-0-2001.

CLASS 40—(Continued).

2,571,849. PROTECTIVE COATINGS TECHNOLOGY, INC., BLAINE, MN. SN 75-702,920. PUB. 1-23-2001, FILED 5-11-1999.

PCT PROTECTIVE COATINGS TECHNOLOGY, INC.

NO CLAIM IS MADE TO THE EXCLUSIVE RIGHT TO USE "PROTECTIVE COATINGS TECHNOLOGY, INC.", APART FROM THE MARK AS SHOWN.

FOR MANUFACTURING PROTECTIVE COATINGS TO THE ORDER OR SPECIFICATION OF OTHERS, NAMELY, FORMULATING PROTECTIVE COATINGS FOR USE ON CONCRETE, CONCRETE MASONRY STRUCTURES, STONE, BRICK VENEER, AND ARCHITECTURAL AND STRUCTURAL SURFACES (U.S. CLS. 100, 103 AND 106).

FIRST USE 6-4-1999; IN COMMERCE 6-4-1999.

CLASS 41—EDUCATION AND ENTERTAINMENT

2,571,692. ODYSSEY HOLDINGS, L.L.C., NEW YORK, NY. SN 75-179,386. PUB. 3-3-1998, FILED 10-4-1996.

ODYSSEY NETWORK

NO CLAIM IS MADE TO THE EXCLUSIVE RIGHT TO USE "NETWORK", APART FROM THE MARK AS SHOWN. FOR TELEVISION PROGRAM PRODUCTION AND DISTRIBUTION SERVICES (U.S. CLS. 100, 101 AND 107). FIRST USE 4-6-1999; IN COMMERCE 4-6-1999.

2,571,703. INVENTURE, INC., OMAHA, NE. SN 75-333,611. PUB. 6-16-1998, FILED 7-31-1997.

HOTSTOX

FOR ENTERTAINMENT SERVICES, NAMELY, PROVIDING ON-LINE AND INTERACTIVE COMPUTER GAMES RELATED TO THE FIELD OF STOCK MARKET AND INVESTING (U.S. CLS. 100, 101 AND 107). FIRST USE 3-9-2000; IN COMMERCE 3-9-2000.

2,571,727. WEIDER PUBLICATIONS, INC., WOODLAND HILLS, CA. SN 75-425,509. PUB. 10-26-1999, FILED 1-29-1998.

REAL GIRL SIGHTINGS

NO CLAIM IS MADE TO THE EXCLUSIVE RIGHT TO USE "GIRL", APART FROM THE MARK AS SHOWN.

FOR RADIO PROGRAMMING FEATURING RADIO CONTESTS WHICH REQUEST LISTENERS TO SPOT GIRLS AT WORK WHO ARE NOT PRETENTIOUS AND AWARDS PRIZES IN CONNECTION THEREWITH (U.S. CLS. 100, 101 AND 107).

FIRST USE 8-0-1998; IN COMMERCE 8-0-1998.

CLASS 41—(Continued).

2,571,750. CAREER SYSTEMS INTERNATIONAL INC., SCRANTON, PA. SN 75-489,827. PUB. 1-4-2000, FILED 5-20-1998.

CAREER WIRED

NO CLAIM IS MADE TO THE EXCLUSIVE RIGHT TO USE "CAREER", APART FROM THE MARK AS SHOWN. FOR EDUCATIONAL SERVICES, NAMELY, CONDUCTING SEMINARS ON CAREER DEVELOPMENT (U.S. CLS. 100, 101 AND 107).

FIRST USE 5-0-1998; IN COMMERCE 5-0-1998.

2,571,784. KALAMAZOO AVIATION HISTORY MUSEUM, THE, KALAMAZOO, MI. SN 75-596,840. PUB. 11-30-1999, FILED 11-30-1998.

LEGACY OF FLIGHT

NO CLAIM IS MADE TO THE EXCLUSIVE RIGHT TO USE "FLIGHT", APART FROM THE MARK AS SHOWN.

FOR EDUCATIONAL SERVICES, NAMELY, CONDUCTING LECTURES, SEMINARS, WORKSHOPS AND CLASSES IN THE FIELD OF AVIATION AND DISTRIBUTING COURSE MATERIALS IN CONNECTION THEREWITH; ENTERTAINMENT SERVICES IN THE NATURE OF FLIGHT SIMULATION (U.S. CLS. 100, 101 AND 107).

FIRST USE 8-20-2001; IN COMMERCE 8-20-2001.

2,571,811. EDRAMA LEARNING, INC., MONTEREY, CA. SN 75-633,625. PUB. 12-14-1999, FILED 2-3-1999.

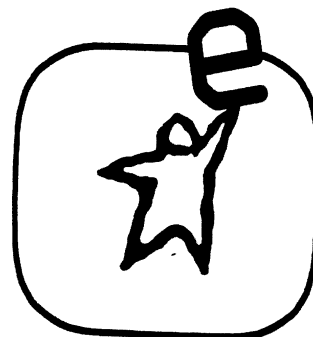

THE MARK CONSISTS OF AN INDIVIDUAL WITH THE LEFT ARM RAISE UPWARD POINTING TO A LETTER "E". FOR EDUCATIONAL SERVICES, NAMELY, CONDUCTING CORPORATE TRAINING CLASSES, SEMINARS, CONFERENCES AND WORKSHOPS IN THE FIELD OF HUMAN RELATIONS AND MANAGEMENT (U.S. CLS. 100, 101 AND 107).

FIRST USE 6-21-2001; IN COMMERCE 8-17-2001.

CLASS 41—(Continued).

2,571,812. DISCOVERY COMMUNICATIONS, INC., BETHESDA, MD. SN 75-634,526. PUB. 12-28-1999, FILED 2-4-1999.

SENSATIONAL CITIES

NO CLAIM IS MADE TO THE EXCLUSIVE RIGHT TO USE "CITIES", APART FROM THE MARK AS SHOWN.

FOR ENTERTAINMENT SERVICES IN THE NATURE OF AN ON-GOING TELEVISION PROGRAM FEATURING CULTURE, HISTORY, LANDMARKS AND PEOPLE OF DIFFERENT CITIES ALL OVER THE WORLD (U.S. CLS. 100, 101 AND 107).

FIRST USE 4-30-2000; IN COMMERCE 4-30-2000.

2,571,828. HANNAH, SCOTT WILLIAM, DBA REDLINE STUDIOS, SAN CLEMENTE, CA. SN 75-665,726. PUB. 1-11-2000, FILED 3-22-1999.

REDLINE STUDIOS

A POST AND VISUAL EFFECTS COMPANY

NO CLAIM IS MADE TO THE EXCLUSIVE RIGHT TO USE "STUDIOS" AND "A POST AND VISUAL EFFECTS COMPANY", APART FROM THE MARK AS SHOWN.

FOR VIDEOTAPE AND MOTION PICTURE FILM PRODUCTION AND POST PRODUCTION SERVICES (U.S. CLS. 100, 101 AND 107).

FIRST USE 2-16-1999; IN COMMERCE 2-16-1999.

2,571,857. NIIT (USA), INC., ATLANTA, GA. SN 75-716,662. PUB. 5-1-2001, FILED 5-28-1999.

PLAN-IT

FOR COMPUTER SOFTWARE TRAINING CONSULTING SERVICES, NAMELY, A TRAINING SERVICE WHICH DEVELOPS A COMPREHENSIVE TRAINING PLAN IN LINE WITH AN ORGANIZATION'S INFORMATION TECHNOLOGY AND HUMAN RESOURCES PLANS (U.S. CLS. 100, 101 AND 107).

FIRST USE 8-0-2001; IN COMMERCE 8-0-2001.

CLASS 41—(Continued).

2,571,887. AMERICAN MOVIE CLASSICS COMPANY, BETH-PAGE, NY. SN 75-763,174. PUB. 4-17-2001, FILED 7-29-1999.

AMC EFX

OWNER OF U.S. REG. NOS. 1,804,799 AND 2,324,204. NO CLAIM IS MADE TO THE EXCLUSIVE RIGHT TO USE "EFFECTS", APART FROM THE MARK AS SHOWN.

FOR ENTERTAINMENT SERVICES, NAMELY TELEVISION PROGRAMMING FEATURING A MOTION PICTURE CONTAINING SPECIAL EFFECTS AND A TELEVISION SERIES AND INTERSTITIAL PROGRAMMING DISCUSSING SPECIAL EFFECTS, AND PROVIDING NEWS AND INFORMATION IN THE FIELD OF ENTERTAINMENT BY MEANS OF A GLOBAL COMPUTER NETWORK (U.S. CLS. 100, 101 AND 107).

FIRST USE 1-0-2001; IN COMMERCE 1-0-2001.

2,571,904. TURTLETAUB, MARC, FAIR OAKS, CA. SN 75-793,532. PUB. 5-2-2000, FILED 9-7-1999.

DEEP RIVER

FOR TELEVISION AND FILM PRODUCTION (U.S. CLS. 100, 101 AND 107).

FIRST USE 1-0-2001; IN COMMERCE 1-0-2001.

2,571,911. WARSHAW, JEREMY, NEW YORK, NY. AND ROGERS-BAUGNON, MEG, NEW YORK, NY. SN 75-803,799. PUB. 4-11-2000, FILED 9-17-1999.

GIVE A DAMN

FOR VIDEO AND FILM PRODUCTION SERVICES (U.S. CLS. 100, 101 AND 107).

FIRST USE 9-21-2000; IN COMMERCE 9-21-2000.

2,571,934. METROPOLIS STUDIOS LTD., LONDON W4 1SY, ENGLAND. SN 75-838,336. PUB. 4-17-2001, FILED 11-2-1999.



M E T R O P O L I S

FOR RECORDING STUDIO SERVICES; AUDIO AND VIDEO RECORDING SERVICES; SOUND RECORDING STUDIO SERVICES; RENTAL OF DVD RECORDING AND SOUND RECORDING EQUIPMENT; RENTAL OF STUDIO FACILITIES; AND DVD RECORDING AND DVD EDITING (U.S. CLS. 100, 101 AND 107).

FIRST USE 7-0-1999; IN COMMERCE 7-0-1999.

CLASS 41—(Continued).

2,571,940. ROUSE, LAWRENCE J., DBA LAWRENCE ROUSE KUNG-FU SAN SOO CENTER FOR SELF-DEFENSE, VAN NUYS, CA. SN 75-844,679. PUB. 7-18-2000, FILED 11-9-1999.



NO CLAIM IS MADE TO THE EXCLUSIVE RIGHT TO USE "KUNG-FU SAN SOO" AND "CENTER FOR SELF-DEFENSE", APART FROM THE MARK AS SHOWN.

LAWRENCE J. ROUSE HEREBY CONSENTS TO THE USE OF HIS NAME WITH RESPECT TO THE SERVICES COVERED BY THIS SERVICE MARK APPLICATION.

THE TRANSLITERATION OF THE CHINESE CHARACTERS APPEARING ON THE LEFT HAND SIDE OF THE DESIGN MARK ARE "KUNG FU SAN SOO." THE TRANSLITERATION OF THE CHINESE CHARACTERS APPEARING ON THE RIGHT HAND SIDE OF THE DESIGN MARK ARE "TSOI LI HOI FUT HUNG." "TSOI LI HOI FUT HUNG" ARE THE CHINESE NAMES OF FOUR (4) FAMILIES AND "FUT" REPRESENTS THE MONASTERY.

FOR EDUCATIONAL SERVICES, NAMELY, CONDUCTING CLASSES IN THE FIELD OF MARTIAL ARTS INSTRUCTION, TRAINING AND SELF-DEFENSE (U.S. CLS. 100, 101 AND 107).

FIRST USE 11-15-1999; IN COMMERCE 11-15-1999.

CLASS 41—(Continued).

2,571,956. MARINE INSTITUTE IN ORANGE COUNTY, DBA OCEAN INSTITUTE, DANA POINT, CA. SN 75-866,950. PUB. 9-12-2000, FILED 12-9-1999.



NO CLAIM IS MADE TO THE EXCLUSIVE RIGHT TO USE "OCEAN INSTITUTE", APART FROM THE MARK AS SHOWN.

FOR PROMOTING SPORTS COMPETITIONS AND SPORTING EVENTS OF OTHERS, NAMELY, PROMOTING BOWLING EVENTS, AND PROMOTING AWARENESS OF THE IMPORTANCE OF FOOTWORK IN BOWLING AND RELATED FUNDAMENTALS OF BOWLING, THROUGH TELEVISION ADVERTISEMENT AND VIDEOS (U.S. CLS. 100, 101 AND 107).

FIRST USE 1-0-2000; IN COMMERCE 11-12-1999.

2,571,999. HYDE SCHOOL, BATH, ME. SN 75-908,948. PUB. 7-24-2001, FILED 2-3-2000.

HYDE
Education Character Family

2,571,955. FASSINO, ROBERT J., HUDSON, WI. SN 75-865,305. PUB. 8-29-2000, FILED 12-18-1999.

FIRE & LIGHT

FOR MOTION PICTURE FILM PRODUCTION AND VIDEO TAPE PRODUCTION (U.S. CLS. 100, 101 AND 107).

FIRST USE 1-1-2000; IN COMMERCE 1-1-2000.

NO CLAIM IS MADE TO THE EXCLUSIVE RIGHT TO USE "EDUCATION", APART FROM THE MARK AS SHOWN.

FOR EDUCATIONAL SERVICES, NAMELY PROVIDING COURSES OF INSTRUCTION AT THE SECONDARY (HIGH SCHOOL) LEVEL; PROVIDING WORKSHOPS AND COURSES OF INSTRUCTION IN THE FIELD OF PARENTING; PROVIDING WORKSHOPS AND COURSES OF INSTRUCTION IN THE FIELD OF TEACHER TRAINING; PROVIDING WILDERNESS EDUCATION PROGRAMS; AND DISTRIBUTING COURSE MATERIALS IN CONNECTION THEREWITH IN THE FIELDS OF SECONDARY (HIGH SCHOOL) LEVEL EDUCATION, PARENTING, TEACHER TRAINING AND WILDERNESS EDUCATION (U.S. CLS. 100, 101 AND 107).

FIRST USE 6-26-2000; IN COMMERCE 6-26-2000.

CLASS 41—(Continued).

2,572,013. TBC, INC., RENTON, WA. SN 75-930,519. PUB. 5-1-2001, FILED 2-15-2000.

CRABCAM

FOR ENTERTAINMENT SERVICES, NAMELY, PROVIDING A CONTINUOUS LIVE UNDERWATER SHOW FEATURING CRABS IN THEIR NATURAL ENVIRONMENT VIA AN UNDERWATER SHOW FEATURING CRABS IN THEIR NATURAL ENVIRONMENT VIA AN UNDERWATER CAMERA MOUNTED ON THE OCEAN FLOOR, A CABLE TELEVISION LINK, AND A CONVERTER ALLOWING THE VIDEO SIGNAL TO TRAVEL OVER THE INTERNET (U.S. CLS. 100, 101 AND 107).
FIRST USE 2-15-2000; IN COMMERCE 1-1-2002.

2,572,032. NUNEZ, BRIAN, FT. LAUDERDALE, FL. SN 75-981,727. PUB. 2-8-2000, FILED 6-17-1999.

DJ SLIM

NO CLAIM IS MADE TO THE EXCLUSIVE RIGHT TO USE "DJ", APART FROM THE MARK AS SHOWN.
FOR ENTERTAINMENT SERVICES IN THE NATURE OF DISC JOCKEY SERVICES FEATURING PRE-RECORDED MUSIC; AND SOUND RECORDING AND PRODUCTION SERVICES (U.S. CLS. 100, 101 AND 107).
FIRST USE 8-27-1998; IN COMMERCE 8-27-1998.

2,572,037. EISAI INC., TEANECK, NJ. SN 75-981,878. PUB. 8-22-2000, FILED 7-9-1999.



Three for the Management of Alzheimer's Disease
The Clinician, Patient, and Caregiver Alliance

OWNER OF U.S. REG. NO. 2,347,262.
FOR EDUCATIONAL SERVICES, NAMELY, CONDUCTING COURSE INSTRUCTION AND DISTRIBUTING PRINTED EDUCATIONAL MATERIALS THEREWITH, IN THE FIELD OF DIAGNOSIS, TREATMENT AND MANAGEMENT OF ALZHEIMER'S DISEASE AND DEMENTIA (U.S. CLS. 100, 101 AND 107).
FIRST USE 2-0-1997; IN COMMERCE 9-0-1998.

CLASS 41—(Continued).

2,572,053. STOCKMAN, SHAWN, NEW YORK, NY. SN 76-018,759. PUB. 11-21-2000, FILED 4-5-2000.

TRI-ESS

FOR PRODUCTION AND DEVELOPMENT SERVICES IN THE MOTION PICTURE, TELEVISION AND MUSIC INDUSTRIES (U.S. CLS. 100, 101 AND 107).
FIRST USE 11-18-2000; IN COMMERCE 11-18-2000.

2,572,060. ARSENEAU, WILLIAM F. JR., POMPAÑO BEACH, FL. SN 76-031,028. PUB. 5-8-2001, FILED 4-21-2000.

THE ARSONAL BAND

NO CLAIM IS MADE TO THE EXCLUSIVE RIGHT TO USE "BAND", APART FROM THE MARK AS SHOWN.
FOR ENTERTAINMENT, NAMELY LIVE PERFORMANCE BY A MUSICAL BAND; AUDIO PRODUCTION AND RECORDING OF MUSIC (U.S. CLS. 100, 101 AND 107).
FIRST USE 11-18-2001; IN COMMERCE 11-18-2001.

2,572,081. BABSON COLLEGE, WELLESLEY, MA. SN 76-053,732. PUB. 4-17-2001, FILED 5-22-2000.

BABSON MOMENT

OWNER OF U.S. REG. NOS. 2,114,519, 2,114,521, AND OTHERS.
FOR EDUCATIONAL AND ENTERTAINMENT SERVICES, NAMELY CONDUCTING COURSE WORK, SEMINARS AND WORK SHOPS LEADING TO UNDERGRADUATE AND GRADUATE DEGREES, CONDUCTING A NON-MATRICULATING EXECUTIVE TRAINING PROGRAM, AND ARRANGING AND CONDUCTING A RANGE OF COLLEGE ATHLETIC COMPETITIONS AND SPORTING EVENTS (U.S. CLS. 100, 101 AND 107).
FIRST USE 8-21-2000; IN COMMERCE 8-21-2000.

2,572,086. PUBLIC BROADCASTING SERVICE, ALEXANDRIA, VA. SN 76-063,827. PUB. 4-17-2001, FILED 6-6-2000.

STAY CURIOUS

FOR CULTURAL, EDUCATIONAL AND ENTERTAINMENT TELEVISION PROGRAMMING SERVICES, NAMELY, TELEVISION PROGRAMS FEATURING A WIDE RANGE OF CULTURAL, EDUCATIONAL AND ENTERTAINMENT TOPICS; AND PROVIDING INFORMATION ON A WIDE RANGE OF CULTURAL, EDUCATIONAL AND ENTERTAINMENT TOPICS BY MEANS OF A GLOBAL COMPUTER NETWORK (U.S. CLS. 100, 101 AND 107).
FIRST USE 7-31-2000; IN COMMERCE 7-31-2000.

CLASS 41—(Continued).

2,572,113. LINCOLN HOCKEY LLC, WASHINGTON, DC. SN 76-090,402. PUB. 5-8-2001, FILED 7-17-2000.

STREETCAPS

FOR ORGANIZING AND ADMINISTERING COMMUNITY BASED STREET HOCKEY PROGRAMS AND COMPETITIONS FOR YOUTH (U.S. CLS. 100, 101 AND 107).

FIRST USE 10-29-2001; IN COMMERCE 10-29-2001.

2,572,128. LOUISIANA CASINO CRUISES, INC., BATON ROUGE, LA. SN 76-108,274. PUB. 5-15-2001, FILED 8-10-2000.

GOT FUN FEVER

FOR CASINO SERVICES (U.S. CLS. 100, 101 AND 107). FIRST USE 9-0-2000; IN COMMERCE 9-0-2000.

2,572,134. CARTOON NETWORK LP, LLLP, THE, ATLANTA, GA. SN 76-119,194. PUB. 5-29-2001, FILED 8-30-2000.

TIME SQUAD

FOR ENTERTAINMENT AND EDUCATION SERVICES IN THE NATURE OF A CONTINUING PROGRAM SERIES AND MOTION PICTURE FILMS DIRECTED TOWARD CHILDREN AND YOUNG ADULTS, PROVIDED THROUGH CABLE TELEVISION, BROADCAST TELEVISION, BROADCAST RADIO AND THE GLOBAL COMPUTER INFORMATION NETWORK (U.S. CLS. 100, 101 AND 107).

FIRST USE 6-8-2001; IN COMMERCE 6-8-2001.

2,572,135. ARXX BUILDING PRODUCTS, INC., COBOURG, ONTARIO, CANADA. SN 76-120,742. PUB. 6-5-2001, FILED 8-31-2000.



FOR TRAINING SERVICES, NAMELY, TRAINING BUILDERS IN THE USE OF INSULATED CONCRETE WALL FORM SYSTEMS AND THEIR APPLICATION TO SPECIFIC CONSTRUCTION PROJECTS (U.S. CLS. 100, 101 AND 107).

FIRST USE 11-27-2000; IN COMMERCE 11-27-2000.

CLASS 41—(Continued).

2,572,138. CHRISTIAN UNIVERSITY GLOBALNET, ENGLEWOOD, CO. SN 76-125,467. PUB. 6-12-2001, FILED 9-8-2000.

GLOBALNET CAMPUS

FOR EDUCATIONAL SERVICES, NAMELY PROVIDING DISTRIBUTED-LEARNING COURSES AND TRAINING IN THE FIELDS OF THE LIBERAL ARTS AND PROFESSIONAL STUDIES AT THE PERSONAL ENRICHMENT EDUCATION LEVEL, EXCLUDING SALES MOTIVATION AND MULTI-LEVEL MARKETING, OFFERED ON AN ONLINE GLOBAL COMMUNICATIONS NETWORK; PROVIDING A WEB SITE THAT OFFERS INFORMATION IN THE FIELD OF EDUCATION (U.S. CLS. 100, 101 AND 107).

FIRST USE 11-15-2000; IN COMMERCE 11-15-2000.

2,572,144. CAMPUS ASSOCIATES, WOODBURY, NY. SN 76-136,267. PUB. 9-4-2001, FILED 9-27-2000.

NATHAN HALE INN & CONFERENCE CENTER

NO CLAIM IS MADE TO THE EXCLUSIVE RIGHT TO USE "INN AND CONFERENCE CENTER", APART FROM THE MARK AS SHOWN.

FOR SERVICES OF PROVIDING AND MANAGING FACILITIES FOR CONFERENCES AND CONVENTIONS (U.S. CLS. 100, 101 AND 107).

FIRST USE 10-15-2001; IN COMMERCE 10-15-2001.

2,572,145. CAMPUS ASSOCIATES, NEW YORK, VA. SN 76-136,689. PUB. 9-11-2001, FILED 9-27-2000.



NO CLAIM IS MADE TO THE EXCLUSIVE RIGHT TO USE "INN AND CONFERENCE CENTER", APART FROM THE MARK AS SHOWN.

FOR SERVICES OF PROVIDING AND MANAGING FACILITIES FOR CONFERENCES AND CONVENTIONS (U.S. CLS. 100, 101 AND 107).

FIRST USE 10-15-2001; IN COMMERCE 10-15-2001.

CLASS 41—(Continued).

2,572,164. XM SATELLITE RADIO INC., WASHINGTON, DC.
SN 76-183,814. PUB. 9-18-2001, FILED 12-21-2000.

BEYOND JAZZ

NO CLAIM IS MADE TO THE EXCLUSIVE RIGHT TO USE "JAZZ", APART FROM THE MARK AS SHOWN.

FOR ENTERTAINMENT SERVICES, NAMELY, PROVIDING AUDIO PROGRAMS FEATURING MUSIC, SPORTS, TALK, NEWS AND DATA VIA SATELLITE AND VIA THE INTERNET (U.S. CLS. 100, 101 AND 107).
FIRST USE 9-25-2001; IN COMMERCE 9-25-2001.

2,572,172. LEA, ROSEMARY L., BIG BEAR LAKE, CA. SN 76-192,569. PUB. 9-4-2001, FILED 1-11-2001.



FOR ENTERTAINMENT SERVICES IN THE NATURE OF AN ONGOING TELEVISION SERIES IN THE FIELD OF COOKING WITH CHOCOLATE (U.S. CLS. 100, 101 AND 107).

FIRST USE 1-2-2001; IN COMMERCE 1-2-2001.

2,572,185. XM SATELLITE RADIO INC., WASHINGTON, DC.
SN 76-241,581. PUB. 9-18-2001, FILED 4-17-2001.

XMLM

FOR ENTERTAINMENT SERVICES, NAMELY, PROVIDING AUDIO PROGRAMS FEATURING MUSIC, SPORTS, TALK, NEWS AND DATA VIA SATELLITE AND VIA A GLOBAL COMMUNICATION NETWORK (U.S. CLS. 100, 101 AND 107).
FIRST USE 9-25-2001; IN COMMERCE 9-25-2001.

CLASS 41—(Continued).

2,572,199. MONTANA GRAIN GROWERS ASSOCIATION, GREAT FALLS, MT. SN 78-022,660. PUB. 7-17-2001, FILED 8-23-2000.



OWNER OF U.S. REG. NO. 2,351,665.

NO CLAIM IS MADE TO THE EXCLUSIVE RIGHT TO USE "MARKETMANAGER", APART FROM THE MARK AS SHOWN.

THE LINING SHOWN IN THE DRAWING IS A FEATURE OF THE MARK AND IS NOT INTENDED TO INDICATE COLOR.

FOR ARRANGING AND CONDUCTING COMMODITY EDUCATIONAL PROGRAMS FOR FARMERS (U.S. CLS. 100, 101 AND 107).

FIRST USE 3-15-1999; IN COMMERCE 6-15-1999.

2,572,209. SHOWTIME NETWORKS INC., NEW YORK, NY.
SN 78-034,273. PUB. 6-5-2001, FILED 11-8-2000.

SHOWTIME NEXT

OWNER OF U.S. REG. NOS. 1,075,211, 2,180,434, AND OTHERS.

FOR ENTERTAINMENT SERVICES, NAMELY, PRODUCTION AND DISTRIBUTION OF MOTION PICTURES, COMEDY, MUSICAL AND DRAMATIC SERIES, DOCUMENTARIES, SPORTING EVENTS BY MEANS OF AND FOR CABLE TELEVISION, SATELLITE-DELIVERED AND TELEVISION BROADCASTING (U.S. CLS. 100, 101 AND 107).

FIRST USE 3-1-2001; IN COMMERCE 3-1-2001.

2,572,215. BRAZLEY, ALVIN LORENZO, BLUE ISLAND, IL.
SN 78-041,042. PUB. 9-11-2001, FILED 12-29-2000.

LO-BOY

FOR MUSIC PUBLISHING (U.S. CLS. 100, 101 AND 107).

FIRST USE 0-0-1997; IN COMMERCE 0-0-1999.

2,572,222. SHOWTIME NETWORKS INC., NEW YORK, NY.
SN 78-053,474. PUB. 9-18-2001, FILED 3-16-2001.

ONSCREEN. ONLINE. ON THE STREET.

FOR ENTERTAINMENT SERVICES, NAMELY, PRODUCTION AND DISTRIBUTION OF MOTION PICTURES, COMEDY, MUSICAL AND DRAMATIC SERIES, DOCUMENTARIES, SPORTING EVENTS BY MEANS OF AND FOR CABLE TELEVISION, SATELLITE-DELIVERED AND TELEVISION BROADCASTING (U.S. CLS. 100, 101 AND 107).

FIRST USE 3-1-2001; IN COMMERCE 3-1-2001.

CLASS 42—SCIENTIFIC, COMPUTER AND LEGAL SERVICES

2,571,731. ASSOCIATION FOR SUPERVISION AND CURRICULUM DEVELOPMENT, ALEXANDRIA, VA. SN 75-436,836. PUB. 10-5-1999, FILED 2-19-1998.

UNDERSTANDING BY DESIGN

FOR COMPUTER SERVICES IN THE NATURE OF PROVIDING MULTIPLE-USER ACCESS TO A GLOBAL COMPUTER INFORMATION NETWORK FOR THE TRANSFER AND DISSEMINATION OF A WIDE RANGE OF INFORMATION IN THE FIELD OF EDUCATION AND CURRICULUM DEVELOPMENT AND TO PROVIDE REAL-TIME ACCESS THROUGH A CHATLINE (U.S. CLS. 100 AND 101).

FIRST USE 5-0-1999; IN COMMERCE 5-0-1999.

2,571,763. IOP PUBLISHING LIMITED, BRISTOL BS1 6BE, UNITED KINGDOM. SN 75-532,643. PUB. 9-12-2000, FILED 8-7-1998.

STACKS

FOR COMPUTER SERVICES, NAMELY, PROVISION, IN COMPUTER READABLE FORM, OF BIBLIOGRAPHIC INFORMATION RELATING TO PUBLICATIONS IN THE FIELDS OF SCIENCE AND ENGINEERING, AND PROVIDING ON-LINE WEB SITE LINKS IN CONNECTION THEREWITH (U.S. CLS. 100 AND 101).

FIRST USE 3-10-1999; IN COMMERCE 3-10-1999.

CLASS 42—(Continued).

2,571,779. O-SUNG KNY CO., LTD., KYUNGKI-DO, REPUBLIC OF KOREA. SN 75-587,292. PUB. 2-1-2000, FILED 11-12-1998.



NO CLAIM IS MADE TO THE EXCLUSIVE RIGHT TO USE "RESTAURANT", APART FROM THE MARK AS SHOWN.

THE KOREAN CHARACTERS IN THE MARK TRANSLITERATE AS "MORANGAK". THE ENGLISH TRANSLATION OF "MORANGAK" IS "PEONY HOUSE".

FOR BAR SERVICES, SNACK BAR SERVICES, COCKTAIL LOUNGE BUFFET SERVICES, CABARET SERVICES, CAFETERIA SERVICES, DELICATESSEN SERVICES, RESTAURANTS FEATURING HOME DELIVERY, CATERING SERVICES, CARRY-OUT RESTAURANT SERVICES, SOCIAL CLUB SERVICES, NIGHT CLUB SERVICES, CONTRACT FOOD SERVICES, FOOD PREPARATION SERVICES, RESTAURANT SERVICES, SELF SERVICE RESTAURANT SERVICES, AND PROVIDING BANQUET AND SOCIAL FUNCTION FACILITIES FOR SPECIAL OCCASIONS (U.S. CLS. 100 AND 101).

FIRST USE 5-0-1999; IN COMMERCE 5-0-1999.

2,571,856. GLOBAL EDVENTURES, LLP, COLUMBIA, MD. SN 75-715,265. PUB. 1-4-2000, FILED 6-21-1999.

GLOBAL EDVENTURES

FOR TECHNICAL CONSULTATION AND RESEARCH IN THE FIELD OF EDUCATION (U.S. CLS. 100 AND 101).

FIRST USE 1-14-2000; IN COMMERCE 1-14-2000.

2,571,863. BRAINHEAD.COM, SOUTHPORT, CT. BY ASSIGNMENT BRAVE NEW KITCHEN, INC., BIRMINGHAM, MI. SN 75-725,382. PUB. 12-14-1999, FILED 7-6-1999.

THE IDEA PORTAL

NO CLAIM IS MADE TO THE EXCLUSIVE RIGHT TO USE "PORTAL", APART FROM THE MARK AS SHOWN.

FOR COMPUTER SERVICES, NAMELY, PROVIDING SEARCH ENGINES FOR OBTAINING DATA ON A GLOBAL COMPUTER NETWORK (U.S. CLS. 100 AND 101).

FIRST USE 3-1-2000; IN COMMERCE 3-1-2000.

CLASS 42—(Continued).

2,571,866. EASYCO L.L.C., GLENOLDEN, PA, BY ASSIGNMENT REPTON DATA, INC., SPRINGFIELD, PA. SN 75-729,233. PUB. 12-12-2000, FILED 6-1-1999.

EASYCO

FOR COMPUTER TIME-SHARING SERVICES AND COMPUTER SOFTWARE DESIGN FOR OTHERS (U.S. CLS. 100 AND 101).

FIRST USE 9-1-2000; IN COMMERCE 9-1-2000.

CLASS 42—(Continued).

2,571,898. INTERIOR SPACE, INC., ST. LOUIS, MO. SN 75-777,438. PUB. 4-18-2000, FILED 8-17-1999.

ARCTURIS

FOR ARCHITECTURAL SERVICES, INTERIOR PLANNING AND DESIGN SERVICES AND FACILITIES PLANNING SERVICES (U.S. CLS. 100 AND 101).

FIRST USE 9-15-1999; IN COMMERCE 9-15-1999.

2,571,873. TCBY ENTERPRISES, INC., SALT LAKE CITY, UT. SN 75-738,632. PUB. 5-2-2000, FILED 6-28-1999.

Something Special for Everyone!

FOR RESTAURANT SERVICES, (ICE CREAM, FROZEN YOGURT, SORBET) (U.S. CLS. 100 AND 101).

FIRST USE 8-17-2000; IN COMMERCE 8-17-2000.

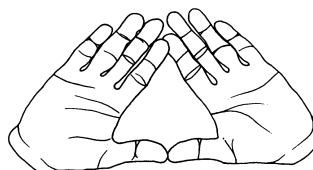

2,571,914. FATBOY FILMS, LLC, DBA TRIANGLE IMAGES, RENO, NV. SN 75-808,876. PUB. 10-10-2000, FILED 9-27-1999.

FOR STILL PHOTOGRAPHY SERVICES (U.S. CLS. 100 AND 101).

FIRST USE 11-0-2000; IN COMMERCE 11-0-2000.

2,571,876. FOSTER PEPPER & SHEFELMAN PLLC, SEATTLE, WA. SN 75-744,131. PUB. 1-23-2001, FILED 7-6-1999.

TECHNOLOGY SOLUTIONS

NO CLAIM IS MADE TO THE EXCLUSIVE RIGHT TO USE "TECHNOLOGY", APART FROM THE MARK AS SHOWN.

FOR LEGAL SERVICES AND ADVICE; PROVIDING AN ONLINE COMPUTER DATABASE IN THE FIELD OF LAW VIA GLOBAL COMPUTER NETWORKS, WIDE AREA NETWORKS AND LOCAL AREA NETWORKS (U.S. CLS. 100 AND 101).

FIRST USE 11-0-1999; IN COMMERCE 11-0-1999.

2,571,924. GREAT PYRAMID, L.L.C., VIRGINIA BEACH, VA. SN 75-822,592. PUB. 2-27-2001, FILED 10-13-1999.

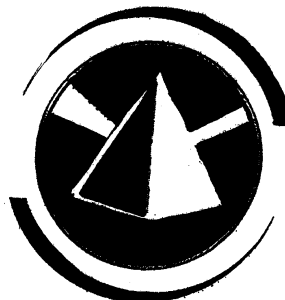

2,571,895. GOBUYBUY, INC., MEMPHIS, TN. SN 75-772,647. PUB. 2-29-2000, FILED 8-10-1999.

GOBUYBUY

FOR PROVIDING ON A GLOBAL COMPUTER NETWORK A DIRECTORY FOR LOCATING WEBSITES SELLING DESIRED MERCHANDISE (U.S. CLS. 100 AND 101).

FIRST USE 11-19-2001; IN COMMERCE 11-19-2001.

FOR CONSULTING SERVICES IN THE FIELD OF EDUCATIONAL TESTING, RENDERED BY ELECTRONIC MEANS (U.S. CLS. 100 AND 101).

FIRST USE 1-1-2000; IN COMMERCE 1-1-2000.

CLASS 42—(Continued).

2,571,950. BURRELL, DEBRA S., BIRMINGHAM, AL. SN 75-855,154. PUB. 7-25-2000, FILED 12-9-1999.

ARTECHULATE

FOR WEBSITE DESIGN AND DEVELOPMENT FOR OTHERS (U.S. CLS. 100 AND 101).
FIRST USE 6-1-2001; IN COMMERCE 6-1-2001.

2,571,960. WORDALONE NETWORK, MAHTOMEDI, MN. SN 75-870,114. PUB. 5-8-2001, FILED 12-22-1999.

WORDALONE

FOR ASSOCIATION SERVICES, NAMELY, PROMOTING RELIGIOUS UNITY AMONG CHRISTIANS (U.S. CLS. 100 AND 101).
FIRST USE 2-16-2000; IN COMMERCE 2-16-2000.

2,572,010. SISTINA SOFTWARE, INC., MINNEAPOLIS, MN. SN 75-926,088. PUB. 8-28-2001, FILED 2-23-2000.

SISTINA

FOR TECHNICAL SUPPORT SERVICES, NAMELY, TROUBLESHOOTING OF COMPUTER HARDWARE AND SOFTWARE PROBLEMS VIA TELEPHONE, E-MAIL, REMOTE MONITORING, AND IN PERSON; PROVIDING COMPUTER CONSULTING SERVICES FOR OTHERS; PROVIDING COMPUTER AND NETWORK SYSTEMS INTEGRATION SERVICES FOR OTHERS (U.S. CLS. 100 AND 101).
FIRST USE 8-0-1997; IN COMMERCE 5-0-2000.

2,572,059. HEALTH INDUSTRY MANUFACTURERS ASSOCIATION, WASHINGTON, DC. SN 76-030,462. PUB. 2-13-2001, FILED 4-20-2000.

**BRINGING INNOVATION TO
PATIENT CARE
WORLDWIDE**

FOR ASSOCIATION SERVICES, NAMELY PROMOTING THE INTERESTS OF HEALTH INDUSTRY MANUFACTURERS (U.S. CLS. 100 AND 101).
FIRST USE 6-21-2000; IN COMMERCE 6-21-2000.

CLASS 42—(Continued).

2,572,063. MATRIX.NET, INC., AUSTIN, TX, BY ASSIGNMENT MATRIX INFORMATION AND DIRECTORY SERVICES, INC., AUSTIN, TX. SN 76-033,607. PUB. 8-7-2001, FILED 4-25-2000.

**MATRIX INFORMATION
AND DIRECTORY SERVICES,
INC.**

NO CLAIM IS MADE TO THE EXCLUSIVE RIGHT TO USE "INFORMATION AND DIRECTORY SERVICES, INC.", APART FROM THE MARK AS SHOWN.

FOR MONITORING COMPUTER NETWORKS OF OTHERS, NAMELY, MONITORING AND REPORTING VARIOUS NETWORK METRICS REGARDING THE PERFORMANCE, SIZES, SPEEDS, TOPOLOGY, USERS, AND DEMOGRAPHICS OF COMPUTERS CONNECTED TO A GLOBAL INFORMATION SYSTEM LINKED BY A COMMON PROTOCOL (U.S. CLS. 100 AND 101).
FIRST USE 9-30-1994; IN COMMERCE 9-30-1994.

2,572,071. FORD MOTOR COMPANY, DEARBORN, MI. SN 76-042,171. PUB. 1-16-2001, FILED 5-5-2000.

COVISINT

FOR CONSULTING, ENGINEERING, AND DESIGN FOR OTHERS IN THE FIELD OF MOTOR VEHICLES (U.S. CLS. 100 AND 101).
FIRST USE 5-17-2000; IN COMMERCE 5-17-2000.

2,572,093. SMITH, CHARLOTTE A., WAUWATOSA, WI. SN 76-070,326. PUB. 3-13-2001, FILED 6-14-2000.

PHARMECOLOGY

FOR CONSULTING SERVICES IN THE FIELD OF WASTE MANAGEMENT (U.S. CLS. 100 AND 101).
FIRST USE 12-1-2000; IN COMMERCE 12-1-2000.

2,572,107. FLAGSTONE HOSPITALITY MANAGEMENT, LLC, MEMPHIS, TN, BY ASSIGNMENT WHARF MANAGEMENT COMPANY, MEMPHIS, TN. SN 76-083,042. PUB. 4-17-2001, FILED 7-5-2000.

**FLAGSTONE HOSPITALITY
MANAGEMENT**

NO CLAIM IS MADE TO THE EXCLUSIVE RIGHT TO USE "HOSPITALITY MANAGEMENT", APART FROM THE MARK AS SHOWN.

FOR HOTEL SERVICES (U.S. CLS. 100 AND 101).
FIRST USE 11-0-2000; IN COMMERCE 1-0-2001.

CLASS 42—(Continued).

2,572,114. LARAGH, JOHN H., GOLF, FL. SN 76-091,156. PUB. 4-17-2001, FILED 7-18-2000.

THE LARAGH METHOD

NO CLAIM IS MADE TO THE EXCLUSIVE RIGHT TO USE "METHOD", APART FROM THE MARK AS SHOWN. FOR MEDICAL COUNSELING SERVICES FOR TREATING HYPERTENSION AND RELATED DISORDERS, NAMELY, HEART ATTACK, HEART FAILURE, KIDNEY FAILURE AND STROKE (U.S. CLS. 100 AND 101).

FIRST USE 5-19-2001; IN COMMERCE 5-19-2001.

2,572,152. GASPAROVIC, TONY, DIAMOND BAR, CA. SN 76-157,751. PUB. 10-2-2001, FILED 11-1-2000.

METRACOM

FOR COMPUTER SERVICES, HOSTING THE WEB SITES OF OTHERS ON A COMPUTER SERVER FOR A GLOBAL COMPUTER NETWORK; COMPUTER SOFTWARE DESIGN FOR OTHERS (U.S. CLS. 100 AND 101).
FIRST USE 10-1-2000; IN COMMERCE 5-14-2001.

2,572,181. GUIDECOMM SYSTEMS, INC., CHANTILLY, VA. SN 76-210,403. PUB. 8-14-2001, FILED 2-15-2001.

IMAGINE EVERYTHING WORKING

FOR COMPUTER CONSULTING SERVICES RELATING TO NETWORK SYSTEMS INTEGRATION AND OPERATIONAL, BUSINESS AND E-COMMERCE SUPPORT SYSTEMS; CUSTOM DEVELOPMENT OF SOFTWARE FOR OTHERS; TECHNICAL SUPPORT SERVICES, NAMELY, NETWORK MONITORING AND TROUBLESHOOTING OF SOFTWARE AND HARDWARE PROBLEMS VIA PHONE, E-MAIL, REMOTE INTERNET ACCESS AND ON SITE CONSULTATION; CONSULTING SERVICES, NAMELY, ASSESSING THE OPERATIONAL, BUSINESS AND E-COMMERCE SUPPORT SYSTEMS OF COMPANIES IN THE COMMUNICATIONS FIELD; PROVIDING TEMPORARY USE OF NON-DOWNLOADABLE SOFTWARE FOR NETWORK SYSTEMS INTEGRATION AND OPERATIONAL, BUSINESS AND E-COMMERCE SUPPORT SYSTEMS; HOSTING THE WEB SITES OF OTHERS ON A COMPUTER SERVER (U.S. CLS. 100 AND 101).

FIRST USE 2-12-2001; IN COMMERCE 2-12-2001.

CLASS 42—(Continued).

2,572,200. FAIRFIELD INDUSTRIES INCORPORATED, SUGAR LAND, TX. SN 78-023,334. PUB. 4-24-2001, FILED 8-28-2000.

CRACK-IDENT

FOR PROVIDING SERVICES IN THE FIELD OF EXPLORATION OF OIL AND GAS, NAMELY GEOPHYSICAL SURVEYS, DATA ACQUISITION AND ANALYSIS (U.S. CLS. 100 AND 101).

FIRST USE 1-4-2002; IN COMMERCE 1-4-2002.

2,572,206. DIGITAL HAIKU, WEST HOLLYWOOD, CA. SN 78-029,627. PUB. 10-30-2001, FILED 10-7-2000.



NO CLAIM IS MADE TO THE EXCLUSIVE RIGHT TO USE "DIGITAL", APART FROM THE MARK AS SHOWN.

THE MARK CONSISTS OF THE WORDS "DIGITAL" AND "HAIKU" IN WHITE LETTERS IN A BLACK SEMI-RECTANGLE WITH A RED LETTER "I" THAT SERVES AS THE SECOND AND FIRST "I" IN THE WORDS "DIGITAL" AND "HAIKU" RESPECTIVELY.

FOR COMPUTER SERVICES, NAMELY, CREATING AND MAINTAINING WEB SITES FOR OTHERS (U.S. CLS. 100 AND 101).

FIRST USE 8-1-2000; IN COMMERCE 8-7-2000.

* * * * *

SUPPLEMENTAL REGISTER

These registrations are not subject to opposition.

SECTION 1.— INTERNATIONAL CLASSIFICATION

The short titles associated below with the international class numbers are terms designed merely for quick identification and are not an official part of the international classification. The full names of international classes are given in section 6.1 of the trademark rules of practice.

The designation "U.S. Cl." appearing in this section refers to the U.S. class in effect prior to Sep. 1, 1973 rather than the international class which applies to applications filed on or after that date. For adoption of international classification see notice in the OFFICIAL GAZETTE of Jun. 26, 1973 (911 O.G. TM 210).

Application in more than one class

2,572,242. TREAT ENTERTAINMENT, INC., FLORENCE, AL. SN 75-567,419. FILED P.R. 10-9-1998; AM. S.R. 9-10-2001.

2,572,255. TRF SYSTEMS, INC., CORAL SPRINGS, FL. SN 75-778,971. FILED P.R. 8-19-1999; AM. S.R. 7-9-2001.

BABY SCRUBS

CLASS 21—HOUSEWARES AND GLASS

FOR BATH SPONGES, WASHCLOTHS DESIGNED FOR EXFOLIATING (U.S. CLS. 2, 13, 23, 29, 30, 33, 40 AND 50).

FIRST USE 8-31-1998; IN COMMERCE 8-31-1998.

CLASS 24—FABRICS

FOR WASHCLOTHS (U.S. CLS. 42 AND 50).
FIRST USE 8-31-1998; IN COMMERCE 8-31-1998.

2,572,248. LENDER'S SERVICE, INC., CORAOPOLIS, PA. SN 75-715,617. FILED P.R. 5-27-1999; AM. S.R. 1-14-2002.

TOTAL BUSINESS SOLUTION

CLASS 36—INSURANCE AND FINANCIAL

FOR PROVIDING REAL ESTATE APPRAISAL AND CLOSING SERVICES; FOR THE MORTGAGE AND LENDING INDUSTRY (U.S. CLS. 100, 101 AND 102).

FIRST USE 1-0-1998; IN COMMERCE 3-0-1998.

CLASS 42—SCIENTIFIC, COMPUTER AND LEGAL SERVICES

FOR TITLE SEARCHING, FOR THE MORTGAGE AND LENDING INDUSTRY (U.S. CLS. 100 AND 101).
FIRST USE 1-0-1998; IN COMMERCE 3-0-1998.

VISUALTOUR

CLASS 9—ELECTRICAL AND SCIENTIFIC APPARATUS

FOR COMPUTER SOFTWARE THAT ALLOWS USERS TO CREATE SLIDE SHOWS OF IMAGES OR PHOTOGRAPHS (U.S. CLS. 21, 23, 26, 36 AND 38).

FIRST USE 5-8-1998; IN COMMERCE 5-8-1998.

CLASS 42—SCIENTIFIC, COMPUTER AND LEGAL SERVICES

FOR PROVIDING IMAGE BASED PICTORIAL TOURS VIA THE GLOBAL COMPUTER NETWORK OF PLACES AND THINGS, FEATURING VISUAL IMAGES, VOICE, AND TEXT (U.S. CLS. 100 AND 101).

FIRST USE 5-8-1998; IN COMMERCE 5-8-1998.

2,572,259. BOARD OF REGENTS, THE UNIVERSITY OF TEXAS SYSTEM, AUSTIN, TX. SN 75-796,215. FILED P.R. 9-8-1999; AM. S.R. 1-22-2002.

MACK PACK

CLASS 24—FABRICS

FOR TOWELS (U.S. CLS. 42 AND 50).
FIRST USE 9-5-1998; IN COMMERCE 9-5-1998.

CLASS 25—CLOTHING

FOR CLOTHING, NAMELY, T-SHIRTS, SWEAT-SHIRTS, SHORTS, AND CAPS (U.S. CLS. 22 AND 39).
FIRST USE 9-5-1998; IN COMMERCE 9-5-1998.

2,572,262. ISKY, INC., COLUMBIA, MD, BY CHANGE OF NAME SKY ALLAND RESEARCH, COLUMBIA, MD. SN 75-825,715. FILED P.R. 10-18-1999; AM. S.R. 7-2-2001.

REAL-TIME CUSTOMER CARE

CLASS 35—ADVERTISING AND BUSINESS

FOR BUSINESS MARKETING CONSULTING SERVICES PERTAINING TO CUSTOMER RELATIONSHIP MANAGEMENT FOR OTHERS; BUSINESS MARKETING CONSULTING SERVICES, NAMELY, DATABASE MARKETING; TELEMARKETING SERVICES; TELESERVICING FOR OTHERS, NAMELY, INITIATING, RECEIVING AND RESPONDING TO TELEPHONE AND TELEFACSIMILE COMMUNICATIONS AND INQUIRIES TO AND FROM CUSTOMERS OF OTHER BUSINESSES; PROMOTING THE GOODS AND SERVICES OF OTHERS VIA DIRECT MAIL AND TELEPHONE; PROMOTING THE GOODS AND SERVICES OF OTHERS VIA AN ONLINE ELECTRONIC COMMUNICATIONS NETWORK BY PROVIDING INFORMATION FOR THEIR CUSTOMERS; CONDUCTING PRIMARY AND SECONDARY BUSINESS RESEARCH; OPERATING AND MANAGING TELEPHONE CALL CENTERS; CUSTOMER SERVICE FULFILLMENT SERVICES FOR OTHERS, NAMELY, RESPONDING TO AND CONFIRMING AND FILLING CUSTOMER ORDERS FOR OTHERS (U.S. CLS. 100, 101 AND 102).

FIRST USE 11-1-1999; IN COMMERCE 11-1-1999.

CLASS 41—EDUCATION AND ENTERTAINMENT

FOR TRAINING AND EDUCATIONAL INSTRUCTION IN THE FIELDS OF TELEMARKETING AND TELESERVICING (U.S. CLS. 100, 101 AND 107).

FIRST USE 11-1-1999; IN COMMERCE 11-1-1999.

2,572,265. TOLMA S.A., PARIS, FRANCE. SN 75-836,361. FILED P.R. 10-30-1999; AM. S.R. 8-13-2001.

TV2PC

OWNER OF FRANCE REG. NO. 98751838, DATED 10-29-1998, EXPIRES 10-29-2008.

CLASS 9—ELECTRICAL AND SCIENTIFIC APPARATUS

FOR ELECTRONIC APPARATUS FOR RECEIVING, RECORDING, STORAGE, PROCESSING, AND TRANSMISSION OF MESSAGES WITH MULTIMEDIA CONTENT OVER LOCAL, WIDE-AREA, AND GLOBAL COMPUTER NETWORKS; BLANK MAGNETIC COMPUTER TAPES AND OPTICAL DISCS FOR STORAGE OF DATA; COMPUTERS; COMPUTER ENCODERS AND DECODERS FOR INFORMATION PROCESSING; COMPUTER SOFTWARE FOR RECEIVING, RECORDING, STORAGE, PROCESSING, AND TRANSMISSION OF MESSAGES WITH MULTIMEDIA CONTENT OVER LOCAL, WIDE-AREA, AND GLOBAL COMPUTER NETWORKS; COMPUTER SOFTWARE FOR RECEIVING, PROCESSING, MANAGING, AND DISPLAYING MESSAGES WITH MULTIMEDIA CONTENT RECEIVED OVER LOCAL, WIDE-AREA, AND GLOBAL COMPUTER NETWORKS; COMPACT DISCS FOR STORING COMPUTER SOFTWARE FOR RECEIVING, RECORDING, STORAGE, PROCESSING, AND TRANSMISSION OF MESSAGES WITH MULTIMEDIA CONTENT OVER LOCAL, WIDE-AREA, AND GLOBAL COMPUTER NETWORKS; COMPACT DISCS FOR RECEIVING, PROCESSING, MANAGING, AND DISPLAYING MESSAGES WITH MULTIMEDIA CONTENT RECEIVED OVER LOCAL, WIDE-AREA, AND GLOBAL COMPUTER NETWORKS; COMPUTER SOFTWARE FOR PROCESSING AND ANALYSIS OF INFORMATION DEALING WITH TRANSMISSION OF MESSAGES WITH MULTIMEDIA CONTENT OVER DIGITAL NETWORKS (U.S. CLS. 21, 23, 26, 36 AND 38).

CLASS 37—CONSTRUCTION AND REPAIR

FOR INSTALLATION, REPAIR AND MAINTENANCE OF ELECTRONIC EQUIPMENT, COMPUTERS AND COMPUTER PERIPHERALS (U.S. CLS. 100, 103 AND 106).

CLASS 38—COMMUNICATION

FOR TELECOMMUNICATIONS SERVICES, NAMELY, LOCAL AND LONG DISTANCE TRANSMISSION OF AUDIO MATERIAL, VIDEO MATERIAL, DATA, GRAPHICS, AND COMPUTER APPLICATIONS BY MEANS OF TELEPHONE, WIRELESS, AND COMPUTER NETWORKS; DELIVERY OF MESSAGES BY ELECTRONIC TRANSMISSION; PROVIDING MULTIPLE USER ACCESS TO LOCAL, WIDE-AREA, AND GLOBAL COMPUTER INFORMATION NETWORKS (U.S. CLS. 100, 101 AND 104).

CLASS 42—SCIENTIFIC, COMPUTER AND LEGAL SERVICES

FOR CUSTOM DESIGN OF COMPUTER SOFTWARE AND COMPUTER HARDWARE IN THE FIELD OF MEDIA STUDIES; COMPUTER SOFTWARE MAINTENANCE AND UPDATING SERVICES; COMPUTER PROGRAMMING SERVICES; TECHNICAL CONSULTATION AND RESEARCH IN THE FIELD OF SOFTWARE DESIGN; COMPUTER CONSULTING SERVICES IN THE DESIGN AND IMPLEMENTATION OF COMPUTER HARDWARE AND SOFTWARE NETWORKS; PROVIDING TECHNICAL ADVICE ON THE DESIGN AND IMPLEMENTATION OF COMPUTER HARDWARE AND SOFTWARE NETWORKS; HOSTING THE WEB SITES OF OTHERS ON A COMPUTER SERVER FOR LOCAL, WIDE-AREA, AND GLOBAL COMPUTER NETWORKS; DESIGNING AND IMPLEMENTING WEB SITES FOR OTHERS (U.S. CLS. 100 AND 101).

2,572,268. KINGSTON-MIAMI TRADING CO., MIAMI, FL. SN 75-848,435. FILED P.R. 11-15-1999; AM. S.R. 2-16-2001.

TRINIDAD BEST

NO CLAIM IS MADE TO THE EXCLUSIVE RIGHT TO USE "TRINIDAD", APART FROM THE MARK AS SHOWN.

CLASS 29—MEATS AND PROCESSED FOODS

FOR JAMS, JELLIES, CANNED FRUITS, CANNED VEGETABLES, DRIED FRUIT, COCONUT MILK AND PROCESSED EDIBLE ROOTS (U.S. CL. 46).
FIRST USE 11-0-2000; IN COMMERCE 11-0-2000.

CLASS 30—STAPLE FOODS

FOR SAUCES, SPICES, PROCESSED HERBS AND BREAKFAST CEREALS (U.S. CL. 46).
FIRST USE 11-0-2000; IN COMMERCE 11-0-2000.

2,572,271. RISKMETRICS GROUP, NEW YORK, NY. SN 75-855,357. FILED P.R. 12-10-1999; AM. S.R. 10-17-2001.

RISKGRADE

CLASS 36—INSURANCE AND FINANCIAL

FOR PORTFOLIO MANAGEMENT SERVICES, NAMELY, QUANTIFYING THE LIKELIHOOD OF GAIN OR LOSS IN EXPECTED RETURNS ASSOCIATED WITH VARIOUS FINANCIAL ASSETS AND PROVIDING INVESTORS AND FINANCIAL ADVISORS WITH AN ASSESSMENT AS TO SAID LIKELIHOOD OF GAIN OR LOSS IN EXPECTED RETURNS VIA A GLOBAL COMPUTER NETWORK AND WIRELESS COMMUNICATIONS (U.S. CLS. 100, 101 AND 102).
FIRST USE 5-23-2000; IN COMMERCE 5-23-2000.

CLASS 42—SCIENTIFIC, COMPUTER AND LEGAL SERVICES

FOR SERVICE PROVIDER, NAMELY HOSTING AND DELIVERING SOFTWARE APPLICATIONS THAT ALLOW USERS TO QUANTIFY THE LIKELIHOOD OF GAIN OR LOSS IN EXPECTED RETURNS ASSOCIATED WITH VARIOUS FINANCIAL ASSETS AND TO OBTAIN AN ASSESSMENT AS TO SAID LIKELIHOOD OF GAIN OR LOSS IN EXPECTED RETURNS (U.S. CLS. 100 AND 101).
FIRST USE 5-23-2000; IN COMMERCE 5-23-2000.

2,572,286. TRADE2EUROPE, INC., WESTLAKE VILLAGE, CA. SN 75-906,731. FILED P.R. 1-31-2000; AM. S.R. 1-2-2001.

TRADE2EUROPE

CLASS 35—ADVERTISING AND BUSINESS

FOR ON-LINE SERVICE PROVIDING BUSINESS CONSULTATION AND ORDER FULFILLMENT SERVICES FOR OTHERS BY PROVIDING A STREAM-LINED SUPPLY CHAIN PROCESS (U.S. CLS. 100, 101 AND 102).
FIRST USE 9-1-1999; IN COMMERCE 9-1-1999.

CLASS 39—TRANSPORTATION AND STORAGE

FOR PROVIDING A STREAMLINED SUPPLY CHAIN PROCESS, NAMELY, PROVIDING TRANSPORTATION CONSULTATION IN THE AREA OF FREIGHT WAREHOUSING AND FREIGHT FORWARDING AND FACILITATING CARGO SHIPMENTS VIA LAND AIR AND SEA FOR OTHERS (U.S. CLS. 100 AND 105).
FIRST USE 9-1-1999; IN COMMERCE 9-1-1999.

2,572,288. ELLIANCE, INC., PITTSBURGH, PA, BY CHANGE OF NAME RESEARCH ACCESS, INC., PITTSBURGH, PA. SN 75-917,655. FILED P.R. 2-10-2000; AM. S.R. 12-10-2001.

THE AGENCY EPARTNER

NO CLAIM IS MADE TO THE EXCLUSIVE RIGHT TO USE "AGENCY", APART FROM THE MARK AS SHOWN.

CLASS 35—ADVERTISING AND BUSINESS

FOR ADVERTISING AGENCY SERVICES (U.S. CLS. 100, 101 AND 102).
FIRST USE 12-3-1998; IN COMMERCE 12-3-1998.

CLASS 42—SCIENTIFIC, COMPUTER AND LEGAL SERVICES

FOR COMPUTER SOFTWARE DESIGN FOR OTHERS; COMPUTER SERVICES, NAMELY, DESIGNING AND IMPLEMENTING WEB SITES FOR OTHERS AND HOSTING THE WEB SITES OF OTHERS ON A COMPUTER SERVER FOR A GLOBAL COMPUTER NETWORK (U.S. CLS. 100 AND 101).
FIRST USE 12-3-1998; IN COMMERCE 12-3-1998.

2,572,298. INTERNET FLORIST ASSOCIATION, INC., ST. PAUL, MN. SN 75-979,834. FILED P.R. 3-18-1996; AM. S.R. 3-1-1999.

**VIRTUAL FLOWER
BOUQUET**

NO CLAIM IS MADE TO THE EXCLUSIVE RIGHT TO USE "FLOWER BOUQUET", APART FROM THE MARK AS SHOWN.

CLASS 35—ADVERTISING AND BUSINESS

FOR RETAIL STORE SERVICES FEATURING FRESH FLOWERS, CUT FLOWER ARRANGEMENTS, AND ARTIFICIAL FLOWERS, BLOOMING AND GREEN PLANTS, AND BALLOONS, GIFTS, AND NOVELTY ITEMS (U.S. CLS. 100, 101 AND 102).
FIRST USE 7-19-1996; IN COMMERCE 7-19-1996.

CLASS 39—TRANSPORTATION AND STORAGE

FOR DELIVERY OF GIFTS AND FLOWERS WITH SELECTED ITEMS REGARDING A PARTICULAR OCCASION OR THEME (U.S. CLS. 100 AND 105).
FIRST USE 7-19-1996; IN COMMERCE 7-19-1996.

2,572,319. CAP-TECH PRODUCTS, INC., HARTFORD, CT. SN 76-083,870. FILED P.R. 7-6-2000; AM. S.R. 4-30-2001.

DIRECT REFLECT

CLASS 19—NON-METALLIC BUILDING MATERIALS

FOR REFLECTIVE SIGNALING DEVICES, NAMELY NON-MECHANICAL, NON-ELECTRONIC SIGNS NOT OF METAL, USED FOR DIRECTING TRAFFIC (U.S. CLS. 1, 12, 33 AND 50).

FIRST USE 9-12-2000; IN COMMERCE 9-12-2000.

CLASS 25—CLOTHING

FOR LIGHT-REFLECTIVE GARMENTS, NAMELY, JACKETS AND PANTS (U.S. CLS. 22 AND 39).

FIRST USE 9-12-2000; IN COMMERCE 9-12-2000.

2,572,320. EPSTEIN, DARREN L., FT. LAUDERDALE, FL. SN 76-087,595. FILED P.R. 7-13-2000; AM. S.R. 6-13-2001.

P-EYE

CLASS 35—ADVERTISING AND BUSINESS

FOR BUSINESS INVESTIGATIVE SERVICES (U.S. CLS. 100, 101 AND 102).

FIRST USE 11-21-2001; IN COMMERCE 11-21-2001.

CLASS 42—SCIENTIFIC, COMPUTER AND LEGAL SERVICES

FOR PRIVATE INVESTIGATIVE SERVICES (U.S. CLS. 100 AND 101).

FIRST USE 11-21-2001; IN COMMERCE 11-21-2001.

2,572,327. CMP MEDIA LLC, MANHASSET, NY, BY ASSIGNMENT CMP MEDIA INC., MANHASSET, NY. SN 76-112,095. FILED P.R. 8-18-2000; AM. S.R. 8-13-2001.

THE ULTIMATE PC

CLASS 35—ADVERTISING AND BUSINESS

FOR PRODUCT DEMONSTRATIONS ON THE CREATION, INSTALLATION, CUSTOMIZATION, AND USE OF COMPUTER SYSTEMS (U.S. CLS. 100, 101 AND 102).

FIRST USE 6-1-1998; IN COMMERCE 6-1-1998.

CLASS 41—EDUCATION AND ENTERTAINMENT

FOR EDUCATIONAL SERVICES, NAMELY, EDUCATIONAL DEMONSTRATIONS ON THE CREATION, INSTALLATION, CUSTOMIZATION, AND USE OF COMPUTER SYSTEMS (U.S. CLS. 100, 101 AND 107).

FIRST USE 6-1-1998; IN COMMERCE 6-1-1998.

2,572,333. FLUENT BABY, INC., PALO ALTO, CA. SN 76-136,954. FILED P.R. 9-22-2000; AM. S.R. 1-18-2002.

BABY PORTUGUESE

CLASS 9—ELECTRICAL AND SCIENTIFIC APPARATUS

FOR COMPUTER SOFTWARE FOR USE IN FACILITATING THE DEVELOPMENT OF FOREIGN LANGUAGE CAPABILITIES OF BABIES, INFANTS AND TODDLERS; PRE-RECORDED MULTIMEDIA VIDEO TAPES, COMPACT DISKS, CD-ROMS AND DVDS FEATURING ENTERTAINMENT AND INSTRUCTION FOR DEVELOP THE FOREIGN LANGUAGE CAPABILITIES OF BABIES, INFANTS AND TODDLERS (U.S. CLS. 21, 23, 26, 36 AND 38).

FIRST USE 9-6-2001; IN COMMERCE 9-6-2001.

CLASS 16—PAPER GOODS AND PRINTED MATTER

FOR BOOKS AND PRINTED MATTER, NAMELY, FLASH CARDS, WORKBOOKS, POSTERS AND PRINTED INSTRUCTIONAL, EDUCATIONAL AND TEACHING MATERIALS TO DEVELOP THE FOREIGN LANGUAGE CAPABILITIES OF BABIES, INFANTS AND TODDLERS (U.S. CLS. 2, 5, 22, 23, 29, 37, 38 AND 50).

FIRST USE 9-6-2001; IN COMMERCE 9-6-2001.

CLASS 28—TOYS AND SPORTING GOODS

FOR DOLLS AND DOLL ACCESSORIES; GAMES AND PLAYTHINGS, NAMELY A CARD GAME IN THE NATURE OF A MEMORY GAME TO DEVELOP THE FOREIGN LANGUAGE CAPABILITIES OF BABIES, INFANTS AND TODDLERS (U.S. CLS. 22, 23, 38 AND 50).

FIRST USE 9-6-2001; IN COMMERCE 9-6-2001.

CLASS 41—EDUCATION AND ENTERTAINMENT

FOR PROVIDING EDUCATIONAL INFORMATION IN THE FIELD OF LANGUAGES AND LANGUAGE INSTRUCTION FOR BABIES, INFANTS AND TODDLERS OVER THE INTERNET (U.S. CLS. 100, 101 AND 107).

FIRST USE 8-27-2001; IN COMMERCE 8-27-2001.

2,572,339. HOWARD, PAUL S., FELTON, CA. SN 76-154,653. FILED P.R. 10-27-2000; AM. S.R. 10-29-2001.

LAS VEGAS STRIP SHOW

NO CLAIM IS MADE TO THE EXCLUSIVE RIGHT TO USE "SHOW", APART FROM THE MARK AS SHOWN.

CLASS 9—ELECTRICAL AND SCIENTIFIC APPARATUS

FOR PRE-RECORDED VIDEO CASSETTES FEATURING LAS VEGAS STRIP HOTELS, CASINOS, SHOWS, RESTAURANTS, ATTRACTIONS AND PEOPLE THAT VISIT THE LAS VEGAS STRIP (U.S. CLS. 21, 23, 26, 36 AND 38).

FIRST USE 7-0-1997; IN COMMERCE 7-0-1997.

CLASS 41—EDUCATION AND ENTERTAINMENT

FOR ONGOING TELEVISION PROGRAM FEATURING LAS VEGAS STRIP HOTELS, CASINOS, SHOWS, RESTAURANTS, ATTRACTIONS AND PEOPLE THAT VISIT THE LAS VEGAS STRIP (U.S. CLS. 100, 101 AND 107).

FIRST USE 12-0-2000; IN COMMERCE 12-0-2000.

2,572,361. STARZ ENCORE GROUP LLC, ENGLEWOOD, CO. SN 76-195,509. FILED P.R. 1-17-2001; AM. S.R. 10-18-2001.

#1 IN NEW HIT MOVIES**CLASS 38—COMMUNICATION**

FOR CABLE AND SATELLITE TELEVISION BROADCASTING (U.S. CLS. 100, 101 AND 104).

FIRST USE 3-12-2001; IN COMMERCE 3-12-2001.

CLASS 41—EDUCATION AND ENTERTAINMENT

FOR ENTERTAINMENT SERVICES IN THE NATURE OF CABLE AND SATELLITE TELEVISION PROGRAMMING (U.S. CLS. 100, 101 AND 107).

FIRST USE 3-12-2001; IN COMMERCE 3-12-2001.

2,572,372. PRINCIPAL FINANCIAL GROUP, INC., DES MOINES, IA. SN 76-217,797. FILED P.R. 2-28-2001; AM. S.R. 10-1-2001.

EMPLOYER FINANCIAL RESOURCE PROGRAM**CLASS 36—INSURANCE AND FINANCIAL**

FOR FINANCIAL PLANNING, MANAGEMENT, ANALYSIS AND CONSULTATION SERVICES (U.S. CLS. 100, 101 AND 102).

FIRST USE 3-1-1999; IN COMMERCE 3-1-1999.

CLASS 41—EDUCATION AND ENTERTAINMENT

FOR EDUCATIONAL SERVICES, NAMELY, CONDUCTING WORKSHOPS IN THE FIELDS OF FINANCIAL PLANNING, MANAGEMENT, ANALYSIS AND INVESTMENT (U.S. CLS. 100, 101 AND 107).

FIRST USE 3-1-1999; IN COMMERCE 3-1-1999.

2,572,382. PRO SPORTS & ENTERTAINMENT, INC., SANTA BARBARA, CA. SN 76-231,685. FILED P.R. 3-27-2001; AM. S.R. 8-29-2001.

LONG BEACH MARATHON

NO CLAIM IS MADE TO THE EXCLUSIVE RIGHT TO USE "MARATHON", APART FROM THE MARK AS SHOWN.

CLASS 25—CLOTHING

FOR CLOTHING, NAMELY T-SHIRTS AND RUNNING SHIRTS (U.S. CLS. 22 AND 39).

FIRST USE 11-14-1999; IN COMMERCE 11-14-1999.

CLASS 41—EDUCATION AND ENTERTAINMENT

FOR ENTERTAINMENT SERVICES, NAMELY FOOT RACES (U.S. CLS. 100, 101 AND 107).

FIRST USE 11-14-1999; IN COMMERCE 11-14-1999.

2,572,389. LEVITAN, YEGIDIS & GOLDSTEIN, LLP, MIDDLETOWN, NY. SN 76-251,570. FILED P.R. 5-4-2001; AM. S.R. 11-30-2001.

NEW YORK SPEAKERS BUREAU

NO CLAIM IS MADE TO THE EXCLUSIVE RIGHT TO USE "SPEAKERS BUREAU", APART FROM THE MARK AS SHOWN.

CLASS 35—ADVERTISING AND BUSINESS

FOR SPEAKER BUREAU SERVICES, NAMELY, ACTING AS AGENTS FOR INDIVIDUALS IN NEGOTIATING ENGAGEMENTS FOR THEIR SERVICES AS KEYNOTE SPEAKERS (U.S. CLS. 100, 101 AND 102).

FIRST USE 5-2-2001; IN COMMERCE 5-2-2001.

CLASS 41—EDUCATION AND ENTERTAINMENT

FOR PROVIDING EDUCATIONAL AND ENTERTAINMENT SERVICES, NAMELY, ARRANGING FOR SPEAKERS, LECTURERS, CELEBRITIES, AND TRAINING PERSONNEL IN A WIDE ARRAY OF EDUCATIONAL, ENTERTAINING AND MOTIVATIONAL SUBJECTS FOR CORPORATE AND TRADE MEETINGS, CONFERENCES, CONVENTIONS, BANQUETS, AND TRAINING AND EDUCATIONAL PROGRAMS AND FUNCTIONS (U.S. CLS. 100, 101 AND 107).

FIRST USE 5-2-2001; IN COMMERCE 5-2-2001.

2,572,400. NATIONAL EMPLOYEE RIGHTS INSTITUTE, SAN FRANCISCO, CA. SN 76-299,835. FILED P.R. 8-15-2001; AM. S.R. 2-26-2002.

WORKPLACE FAIRNESS**CLASS 16—PAPER GOODS AND PRINTED MATTER**

FOR PRINTED MATTER, NAMELY BOOKS AND BROCHURES RELATED TO EMPLOYMENT INFORMATION (U.S. CLS. 2, 5, 22, 23, 29, 37, 38 AND 50).

FIRST USE 3-27-2001; IN COMMERCE 3-27-2001.

CLASS 35—ADVERTISING AND BUSINESS

FOR EMPLOYMENT COUNSELING SERVICES; AND PROVIDING INFORMATION VIA THE INTERNET ON THE SUBJECT OF EMPLOYMENT COUNSELING (U.S. CLS. 100, 101 AND 102).
FIRST USE 3-27-2001; IN COMMERCE 3-27-2001.

CLASS 41—EDUCATION AND ENTERTAINMENT

FOR PHYSICAL FITNESS INSTRUCTION AND TRAINING AND ON-LINE PHYSICAL FITNESS INSTRUCTION AND TRAINING; ENTERTAINMENT IN THE NATURE OF ONGOING TELEVISION PROGRAMS IN THE FIELD OF PHYSICAL FITNESS INSTRUCTION; EDUCATIONAL SERVICES, NAMELY, CONDUCTING SEMINARS AND CLASSES IN THE FIELD OF PHYSICAL FITNESS INSTRUCTION (U.S. CLS. 100, 101 AND 107).
FIRST USE 5-1-2000; IN COMMERCE 5-1-2000.

2,572,406. JORGE MAURER FITNESS, INC., BEVERLY HILLS, CA. SN 78-010,209. FILED P.R. 5-26-2000; AM. S.R. 2-22-2002.

2,572,418. ENGINEERED PRODUCTS & SERVICES, INC., BROOKFIELD, WI. SN 78-067,262. FILED P.R. 6-4-2001; AM. S.R. 1-18-2002.

8 MINUTES IN THE MORNING

MASKING SOLUTIONS

NO CLAIM IS MADE TO THE EXCLUSIVE RIGHT TO USE "MASKING", APART FROM THE MARK AS SHOWN.

CLASS 9—ELECTRICAL AND SCIENTIFIC APPARATUS

FOR SERIES OF PRERECORDED AUDIO CASSETTES, COMPACT DISKS, VIDEO CASSETTES, AND DIGITAL VIDEO DISKS FEATURING PHYSICAL FITNESS INSTRUCTION (U.S. CLS. 21, 23, 26, 36 AND 38).
FIRST USE 5-1-2000; IN COMMERCE 5-1-2000.

CLASS 17—RUBBER GOODS

FOR MASKING PRODUCTS FOR USE IN THE PAINTING AND COATING INDUSTRIES, NAMELY, CUSTOM PRE-CUT MASKING TAPE, CUSTOM-MOLDED RUBBER CAPS AND PLUGS TO MASK HOLES, AND EXTRUDED RUBBER TUBING USED TO PROTECT CYLINDRICAL SURFACES, ALL FOR HIGH-TEMPERATURE POWDER COATING, E-COATING, PLATING, ANODIZING, AND SPRAY-PAINTING (U.S. CLS. 1, 5, 12, 13, 35 AND 50).
FIRST USE 9-1-1998; IN COMMERCE 9-1-1998.

CLASS 16—PAPER GOODS AND PRINTED MATTER

FOR PUBLICATIONS, NAMELY, BOOKS, MAGAZINES, SYNDICATED NEWSPAPER ARTICLES, NEWSLETTERS, AND PAMPHLETS FEATURING PHYSICAL FITNESS INSTRUCTION (U.S. CLS. 2, 5, 22, 23, 29, 37, 38 AND 50).
FIRST USE 5-1-2000; IN COMMERCE 5-1-2000.

CLASS 42—SCIENTIFIC, COMPUTER AND LEGAL SERVICES

FOR ENGINEERING OF MASKING PRODUCTS FOR USE IN THE PAINTING AND COATING INDUSTRIES, NAMELY, CUSTOM PRE-CUT MASKING TAPE, CUSTOM-MOLDED RUBBER CAPS AND PLUGS TO MASK HOLES, AND EXTRUDED RUBBER TUBING USED TO PROTECT CYLINDRICAL SURFACES, ALL FOR HIGH-TEMPERATURE POWDER COATING, E-COATING, PLATING, ANODIZING, AND SPRAY-PAINTING (U.S. CLS. 100 AND 101).
FIRST USE 9-1-1998; IN COMMERCE 9-1-1998.

* * * * *

SECTION 2.— INTERNATIONAL CLASSIFICATION

The short titles associated below with the international class numbers are terms designed merely for quick identification and are not an official part of the international classification. The full names of international classes are given in section 6.1 of the trademark rules of practice.

The designation "U.S. Cl." appearing in this section refers to the U.S. class in effect prior to Sep. 1, 1973 rather than the international class which applies to applications filed on or after that date. For adoption of international classification see notice in the OFFICIAL GAZETTE of Jun. 26, 1973 (911 O.G. TM 210).

Application in one class

CLASS 1—CHEMICALS

2,572,365. NATURAL LIGHT, PARSIPPANY, NJ. SN 76-202,910. FILED P.R. 1-31-2001; AM. S.R. 7-18-2001.

NATURAL LIGHT

FOR CHEMICALS FOR MANUFACTURING USE, NAMELY, SODA ASH (U.S. CLS. 1, 5, 6, 10, 26 AND 46). FIRST USE 12-4-2000; IN COMMERCE 12-11-2000.

CLASS 3—COSMETICS AND CLEANING PREPARATIONS

2,572,239. ROSEN, STEVEN R., FORT LAUDERDALE, FL, BY ASSIGNMENT ROSEN, STEVEN R., FORT LAUDERDALE, FL. SN 75-407,034. FILED P.R. 12-17-1997; AM. S.R. 11-30-2001.

WATERPROOF

FOR ANTI-PERSPIRANT AND DEODORANT (U.S. CLS. 1, 4, 6, 50, 51 AND 52). FIRST USE 3-15-2001; IN COMMERCE 3-15-2001.

2,572,279. MICROBEST, INC., BOCA RATON, FL. SN 75-886,664. FILED P.R. 1-3-2000; AM. S.R. 9-14-2001.

FLOORWASH

FOR BIOLOGICALLY BASED COMMERCIAL AND INDUSTRIAL ALL-PURPOSE CLEANING PREPARATIONS FOR USE ON HARD SURFACES (U.S. CLS. 1, 4, 6, 50, 51 AND 52). FIRST USE 6-1-1998; IN COMMERCE 6-1-1998.

CLASS 3—(Continued).

2,572,303. HENKEL KGAA, DUESSELDORF, FED REP GERMANY. SN 76-015,061. FILED P.R. 3-31-2000; AM. S.R. 1-7-2002.

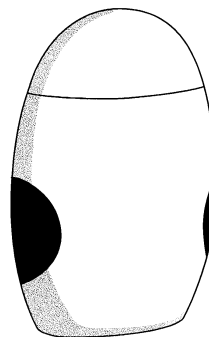

OWNER OF FED REP GERMANY REG. NO. 39905271, DATED 2-24-2000, EXPIRES 2-28-2009.

THE STIPPLING ON THE DRAWING SERVES TO INDICATE THE CURVE OF THE CONTAINER AS A FEATURE OF THE MARK.

THE MARK CONSISTS OF A THREE-DIMENSIONAL CONFIGURATION OF AN OVAL SHAPE CONTAINER, WITH ROUNDED SIDES AND TOP AND A FLAT BOTTOM, HAVING OVAL BUTTONS OF CONTRASTING COLOR ON TWO OPPOSING SIDES.

FOR PERSONAL DEODORANTS (U.S. CLS. 1, 4, 6, 50, 51 AND 52).

2,572,354. SUPERIOR CARPET CARE, INC., LITTLETON, CO. SN 76-184,510. FILED P.R. 12-22-2000; AM. S.R. 10-16-2001.

SuperiorClean

FOR CARPET CLEANING PREPARATIONS (U.S. CLS. 1, 4, 6, 50, 51 AND 52). FIRST USE 11-1-2000; IN COMMERCE 11-1-2000.

CLASS 3—(Continued).

2,572,387. FOREVER NEW INTERNATIONAL, INC., SIOUX FALLS, SD. SN 76-249,940. FILED P.R. 5-2-2001; AM. S.R. 10-29-2001.

THE STAIN REMEDY

FOR CLEANING PREPARATIONS FOR FABRICS (U.S. CLS. 1, 4, 6, 50, 51 AND 52).

FIRST USE 4-25-2001; IN COMMERCE 4-25-2001.

CLASS 4—LUBRICANTS AND FUELS

2,572,317. PACIFICA, INC., PORTLAND, OR. SN 76-079,313. FILED P.R. 6-27-2000; AM. S.R. 4-9-2001.

MEXICAN COCOA

FOR CANDLES (U.S. CLS. 1, 6 AND 15).
FIRST USE 7-15-2000; IN COMMERCE 7-15-2000.

CLASS 5—PHARMACEUTICALS

2,572,264. BAYER CORPORATION, PITTSBURGH, PA. SN 75-829,268. FILED P.R. 10-22-1999; AM. S.R. 6-29-2001.

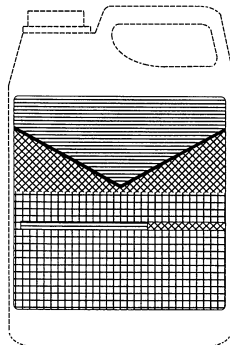

THE MARK CONSISTS OF THE COLORS BLUE, ORANGE AND YELLOW AS APPLIED TO THE LABEL FOR THE CONTAINER FOR THE GOODS. THE AREA LINED FOR THE COLOR ORANGE FADES INTO THE AREA COLORED YELLOW. THE DOTTED OUTLINE OF THE CONTAINER IS INTENDED TO SHOW THE POSITION OF THE MARK AND IS NOT A PART OF THE MARK. THE DRAWING IS LINED FOR THE COLORS BLUE, ORANGE AND YELLOW.

FOR FUNGICIDES, HERBICIDES, INSECTICIDES AND PESTICIDES FOR DOMESTIC AND HORTICULTURAL USE (U.S. CLS. 6, 18, 44, 46, 51 AND 52).

FIRST USE 1-1-2000; IN COMMERCE 1-1-2000.

CLASS 6—METAL GOODS**CLASS 6—(Continued).**

2,572,378. ATI PROPERTIES, INC., GARDENA, CA. SN 76-225,026. FILED P.R. 3-15-2001; AM. S.R. 11-29-2001.

SUPERTOUGH

FOR SPECIALTY METALS AND ALLOYS, NAMELY, STAINLESS STEELS, AND NICKEL, COBALT AND TITANIUM ALLOYS, IN MILL PRODUCT FORMS, NAMELY, INGOTS, BILLETS, BARS, RODS, WIRE, PLATES, SHEETS, STRIPS, FOIL, HOT ROLLED SHAPES AND FORGINGS (U.S. CLS. 2, 12, 13, 14, 23, 25 AND 50).
FIRST USE 11-3-1998; IN COMMERCE 11-3-1998.

2,572,386. MICRO FASTENERS INC., FLEMINGTON, NJ. SN 76-248,362. FILED P.R. 4-30-2001; AM. S.R. 1-15-2002.

MICRO FASTENERS

NO CLAIM IS MADE TO THE EXCLUSIVE RIGHT TO USE "FASTENERS", APART FROM THE MARK AS SHOWN.

FOR METAL FASTENERS, NAMELY SCREWS, NUTS AND WASHERS (U.S. CLS. 2, 12, 13, 14, 23, 25 AND 50).
FIRST USE 11-1-1990; IN COMMERCE 1-1-1991.

CLASS 7—MACHINERY

2,572,249. MTD PRODUCTS INC, CLEVELAND, OH. SN 75-722,018. FILED P.R. 6-4-1999; AM. S.R. 6-25-2001.

SUPREME MULCH SYSTEM

NO CLAIM IS MADE TO THE EXCLUSIVE RIGHT TO USE "MULCH SYSTEM", APART FROM THE MARK AS SHOWN.

FOR MULCHING LAWN MOWER BLADES AND LAWN MOWER DECK SOLD AS AN INTEGRAL COMPONENT OF LAWN MOWERS (U.S. CLS. 13, 19, 21, 23, 31, 34 AND 35).

FIRST USE 7-0-2000; IN COMMERCE 7-0-2000.

2,572,312. DOUGLAS MANUFACTURING COMPANY, PELL CITY, AL. SN 76-061,388. FILED P.R. 6-1-2000; AM. S.R. 9-6-2001.

REPLACEABLE WING LAGGING

NO CLAIM IS MADE TO THE EXCLUSIVE RIGHT TO USE "LAGGING", APART FROM THE MARK AS SHOWN.

FOR METAL BACKED, RUBBER COATED LAGGING FOR WING PULLEYS (U.S. CLS. 13, 19, 21, 23, 31, 34 AND 35).

FIRST USE 6-0-1983; IN COMMERCE 6-0-1983.

CLASS 7—(Continued).

2,572,349. SCHUMANN, LAVERNE E., BLUE GRASS, IA. SN 76-173,035. FILED P.R. 11-29-2000; AM. S.R. 11-12-2001.

DYNAMIC PERFORMANCE

NO CLAIM IS MADE TO THE EXCLUSIVE RIGHT TO USE "PERFORMANCE", APART FROM THE MARK AS SHOWN.

FOR PISTON RINGS (U.S. CLS. 13, 19, 21, 23, 31, 34 AND 35).

FIRST USE 11-30-2000; IN COMMERCE 11-30-2000.

2,572,358. KTX CO., LTD., KONAN-SHI, AICHI-KEN, 483-8111, JAPAN. SN 76-188,321. FILED P.R. 12-29-2000; AM. S.R. 10-11-2001.

POROUS NICKEL

FOR TOOLING FOR MOLDING PLASTICS WHICH CAN BE USED AS THE MAIN BODY OF A MOLD FOR ANY OF A VARIETY OF MOLDING OPERATIONS SUCH AS VACUUM OR VACUUM PRESSURE FORMING, BLOW MOLDING, STAMPING, ROLL FORMING, INJECTION OR REACTIVE INJECTION MOLDING OR COMPRESSION MOLDING, OR FOR A VARIETY OF OTHER PURPOSES (U.S. CLS. 13, 19, 21, 23, 31, 34 AND 35).

FIRST USE 11-21-1998; IN COMMERCE 5-19-1999.

CLASS 9—ELECTRICAL AND SCIENTIFIC APPARATUS

2,572,254. MEXICANA DE ELECTROMECHANICOS, S.A. DE C.V., C.P. 45010 ZAPOPAN, JALISCO, MEXICO. SN 77-77,403. FILED P.R. 8-17-1999; AM. S.R. 3-1-2001.

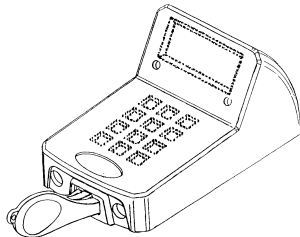

THE MARK CONSISTS OF THE CONFIGURATION OF A DATA ENTRY TERMINAL FOR A GAMING MACHINE. THE DOTTED LINES SHOW THE PLACEMENT OF DATA ENTRY AND OUTPUT UNITS WHICH ARE NOT CLAIMED AS PART OF THE MARK.

FOR GAMING MACHINES, NAMELY, GAME STATIONS COMPRISED OF AUTOMATIC GAME UNITS, KEY RECEPTACLES AND DEBIT KEYS (U.S. CLS. 21, 23, 26, 36 AND 38).

FIRST USE 4-30-1999; IN COMMERCE 4-30-1999.

CLASS 9—(Continued).

2,572,256. PROJECTOOLS.COM, INC., BELLVILLE, TX, BY ASSIGNMENT A.G. MORGAN & ASSOCIATES, HOUSTON, TX. SN 75-783,991. FILED P.R. 8-24-1999; AM. S.R. 10-22-2001.

PROJECTOOLS

FOR COMPUTER SOFTWARE FOR MANAGEMENT OF ENGINEERING AND CONSTRUCTION RELATING TO CAPITAL PROJECTS AND MANUALS SOLD TOGETHER AS A UNIT (U.S. CLS. 21, 23, 26, 36 AND 38).

FIRST USE 7-15-1999; IN COMMERCE 7-15-1999.

2,572,263. SOFTSOLUTIONS, INC., ROANOKE, VA. SN 75-829,118. FILED P.R. 10-22-1999; AM. S.R. 1-29-2001.

FACTORYANALYZER

FOR BUSINESS DATABASE SOFTWARE PRODUCT, NAMELY A DECISION SUPPORT SYSTEM FOR MONITORING REAL-TIME PRODUCTIVITY METRICS AND PERTAINING TO OPERATIONAL PROBLEMS AND SOLUTIONS (U.S. CLS. 21, 23, 26, 36 AND 38).

FIRST USE 5-10-1999; IN COMMERCE 5-10-1999.

2,572,270. PRI ASSOCIATES, INC., DURHAM, NC. SN 75-854,470. FILED P.R. 11-22-1999; AM. S.R. 7-25-2001.

PAYSTAT

FOR COMPUTER SOFTWARE TO EVALUATE FACTORS THAT MAY AFFECT COMPENSATION, NAMELY, SALARY, SENIORITY, TIME-IN-GRADE, JOB TITLE, SEX, AGE, RACE, REGULAR EXEMPT STATUS OR NON-EXEMPT STATUS, WAGE TYPE SUCH AS HOURLY, WEEKLY, BIWEEKLY, MONTHLY, ANNUALLY, DEPARTMENT, PERFORMANCE EVALUATION RATING, EDUCATIONAL ATTAINMENT AND DEGREE, EDUCATIONAL INSTITUTIONS ATTENDED, EQUAL EMPLOYMENT OPPORTUNITY STATUS, AND YEARS OF RELEVANT WORK EXPERIENCE, AND TO EVALUATE POTENTIAL DISCRIMINATION IN COMPENSATION OR DISPARATE IMPACT OF COMPENSATION PRACTICES (U.S. CLS. 21, 23, 26, 36 AND 38).

FIRST USE 8-0-2000; IN COMMERCE 8-0-2000.

2,572,276. YOUCENTRIC, INC., CHARLOTTE, NC. SN 75-863,305. FILED P.R. 12-3-1999; AM. S.R. 11-3-2000.

RXWEB

FOR COMPUTER SOFTWARE FOR USE WITHIN THE HEALTHCARE AND PHARMACEUTICAL INDUSTRIES FOR TRACKING AND MAINTAINING BUSINESS SALES, MARKETING, FINANCIAL RECORDS AND OTHER CUSTOMER RELATIONSHIP INFORMATION; AND COMPUTER E-COMMERCE SOFTWARE TO ALLOW USERS TO PERFORM ELECTRONIC BUSINESS TRANSACTIONS VIA THE INTERNET; AND INSTRUCTIONAL MANUALS SOLD AS A UNIT THEREWITH (U.S. CLS. 21, 23, 26, 36 AND 38).

FIRST USE 3-1-2000; IN COMMERCE 3-1-2000.

CLASS 9—(Continued).

2,572,277. SAES GETTERS S.P.A., MILANO, ITALY. SN 75-869,754. FILED P.R. 12-14-1999; AM. S.R. 10-5-2001.

WAFERGETTER

PRIORITY CLAIMED UNDER SEC. 44(D) ON ERPN CMNTY TM OFC APPLICATION NO. 1388453, FILED 11-18-1999, REG. NO. 1388453, DATED 1-18-2001, EXPIRES 11-18-2009.

FOR GETTERS, GETTER ASSEMBLIES AND PARTS THEREFOR (U.S. CLS. 21, 23, 26, 36 AND 38).

2,572,281. MODULAR MINING SYSTEMS, INC., TUCSON, AZ. SN 75-891,290. FILED P.R. 1-7-2000; AM. S.R. 11-16-2001.

MODULAR

FOR ELECTRONIC CONTROL SYSTEMS FOR USE IN MANAGING OPEN PIT AND UNDERGROUND MINING OPERATIONS, COMPRISING A CENTRAL DIGITAL COMPUTER, CIRCUIT BOARDS, POWER SUPPLIES, PROCESSORS AND ELECTRONIC FIELD DISPLAY PANELS ASSOCIATED WITH TRUCKS, SHOVELS, CRUSHERS, AND RELATED MINING EQUIPMENT USED WITHIN A MINE FOR RECEIVING AND DISPLAYING INFORMATION REMOTE FROM SAID DIGITAL COMPUTER, ASSOCIATED SOFTWARE, MODEMS, AND RADIO TRANSCEIVERS FOR LINKING SAID ELECTRONIC FIELD PANELS TO SAID DIGITAL COMPUTER, ELECTRONIC CIRCUIT BOARDS, ELECTRONIC POWER SUPPLIES AND AUTONOMOUS VEHICLE CONTROLS BASED ON GLOBAL POSITIONING SYSTEM (U.S. CLS. 21, 23, 26, 36 AND 38).

FIRST USE 7-8-1999; IN COMMERCE 7-8-1999.

2,572,311. LEEN & ASSOCIATES, INC., BELLEVUE, WA. SN 76-060,620. FILED P.R. 5-26-2000; AM. S.R. 11-20-2001.

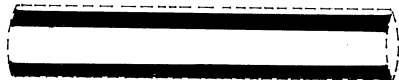

THE MARK CONSISTS OF THREE BLACK LONGITUDINAL LINES EVENLY SPACED APART OVER A LIME GREEN BASE. THE DOTTED LINES ARE NOT A PART OF THE MARK AND ONLY USED TO INDICATE THE OUTLINE OF THE POWER CORD.

FOR ELECTRIC POWER CORDS USED WITH WORK LIGHTS (U.S. CLS. 21, 23, 26, 36 AND 38).

FIRST USE 2-15-1999; IN COMMERCE 2-15-1999.

CLASS 9—(Continued).

2,572,314. OPERATING TAX SYSTEMS, LLC, STOW, OH, BY ASSIGNMENT OPERATING TAX SPECIALISTS, INC., PEMBROKE PINES, FL. SN 76-073,076. FILED P.R. 6-19-2000; AM. S.R. 6-12-2001.

ROADTAX

FOR TRUCK OPERATING TAXES ACCOUNTING AND TAX RETURN PREPARATION COMPUTER SOFTWARE (U.S. CLS. 21, 23, 26, 36 AND 38).

FIRST USE 10-1-1995; IN COMMERCE 10-1-1995.

2,572,332. CONFERENCE TECHNOLOGY GROUP LLC, PLAINVILLE, CT. SN 76-133,002. FILED P.R. 9-21-2000; AM. S.R. 9-14-2001.

FULLSOUND

FOR AUDIO CONFERENCING HARDWARE: MICROPHONES AND AUDIO SPEAKERS; MICROPHONE AND AUDIO SPEAKER CONTROL UNITS, NAMELY AMPLIFIERS AND PRE-AMPLIFIERS AND POWER SUPPLIES (U.S. CLS. 21, 23, 26, 36 AND 38).

FIRST USE 9-1-2001; IN COMMERCE 9-1-2001.

2,572,347. ENTREPRENEUR MEDIA, INC., IRVINE, CA. SN 76-168,636. FILED P.R. 11-20-2000; AM. S.R. 12-26-2001.

HOMEOFFICEMAG

FOR DOWNLOADABLE ELECTRONIC PUBLICATIONS IN THE NATURE OF BOOKS, MAGAZINES, REPORTS AND MANUALS IN THE FIELD OF STARTING AND OPERATING SMALL BUSINESSES (U.S. CLS. 21, 23, 26, 36 AND 38).

FIRST USE 4-7-1998; IN COMMERCE 4-7-1998.

2,572,355. COGNEX CORPORATION, NATICK, MA. SN 76-186,371. FILED P.R. 12-26-2000; AM. S.R. 10-24-2001.

BGAI

FOR MACHINE VISION SYSTEMS CONSISTING OF COMPUTER HARDWARE AND SOFTWARE USED FOR ANALYSIS IN MANUFACTURING AND INDUSTRIAL AUTOMATION, NAMELY, FOR THE INSPECTION OF INTEGRATED CIRCUIT DEVICES (U.S. CLS. 21, 23, 26, 36 AND 38).

FIRST USE 1-15-2000; IN COMMERCE 1-15-2000.

CLASS 9—(Continued).

2,572,356. COGNEX CORPORATION, NATICK, MA. SN 76-186,425. FILED P.R. 12-26-2000; AM. S.R. 10-24-2001.

SMD4

FOR MACHINE VISION SYSTEMS CONSISTING OF COMPUTER HARDWARE AND SOFTWARE USED FOR ANALYSIS IN MANUFACTURING AND INDUSTRIAL AUTOMATION, NAMELY, FOR THE GUIDING AND PLACEMENT OF SURFACE MOUNT DEVICES IN THE SEMICONDUCTOR INDUSTRY (U.S. CLS. 21, 23, 26, 36 AND 38).

FIRST USE 3-1-2000; IN COMMERCE 3-1-2000.

2,572,374. NIELSEN MEDIA RESEARCH, INC., NEW YORK, NY. SN 76-220,598. FILED P.R. 3-6-2001; AM. S.R. 11-21-2001.

AD*BROWSER

FOR ELECTRONIC DATABASE IN THE ADVERTISING AND MARKET RESEARCH FIELDS, RECORDED ON COMPUTER MEDIA (U.S. CLS. 21, 23, 26, 36 AND 38).

FIRST USE 12-14-2000; IN COMMERCE 12-14-2000.

2,572,391. WHITWORTH, S. RICHARD, CARMEL, CA. SN 76-256,441. FILED P.R. 5-14-2001; AM. S.R. 12-3-2001.

BORROWARE

FOR LOAN APPLICATION COMPUTER SOFTWARE FOR USE ON OR OFF LINE (U.S. CLS. 21, 23, 26, 36 AND 38).

FIRST USE 4-9-2001; IN COMMERCE 4-9-2001.

2,572,407. SILICON BRIDGE, INC., FREMONT, CA. SN 78-013,583. FILED P.R. 6-20-2000; AM. S.R. 10-31-2001.

SILICON BRIDGE

FOR INTEGRATED CIRCUITS, NAMELY TRANSMITTERS, RECEIVERS, TRANSCEIVERS, CONTROLLERS, DRIVERS, A/D CONVERTERS, D/A CONVERTERS, INTEGRATED FILTERS, INTEGRATED RF DEVICES, AND PLLS FOR USE IN THE FIELD OF DIGITAL AND ANALOG COMMUNICATIONS, NETWORKING, COMPUTER PERIPHERALS AND COMPONENTS (U.S. CLS. 21, 23, 26, 36 AND 38).

FIRST USE 7-1-1998; IN COMMERCE 7-1-1998.

CLASS 9—(Continued).

2,572,412. XEROX CORPORATION, STAMFORD, CT. SN 78-044,035. FILED P.R. 1-19-2001; AM. S.R. 1-7-2002.

DOCUMENT APPLIANCE

FOR COMPUTER SERVERS, COMPUTER SOFTWARE, NAMELY SOFTWARE THAT CONTROLS AND ADMINISTERS INFORMATION FOR USE IN INFORMATION MANAGEMENT AND NETWORK MANAGEMENT (U.S. CLS. 21, 23, 26, 36 AND 38).

FIRST USE 5-1-2001; IN COMMERCE 5-1-2001.

2,572,414. DANCEMASTERS DISC JOCKEY ENTERTAINERS, LLC, OSSINING, NY. SN 78-050,571. FILED P.R. 2-28-2001; AM. S.R. 1-10-2002.

DJ MANAGER

FOR COMPUTER SOFTWARE FOR USE IN MANAGING INFORMATION ABOUT MUSIC LIBRARIES, SONG REQUESTS, EQUIPMENT INVENTORY, CLIENTS, VENDORS, EVENTS, ACCOUNTING INFORMATION, PACKAGES, PRICE PLANS, AND OTHER RELATED INFORMATION MANAGEMENT TASKS FOR USE IN THE FIELD OF THE DISC JOCKEY BUSINESS (U.S. CLS. 21, 23, 26, 36 AND 38).

FIRST USE 10-27-2001; IN COMMERCE 10-27-2001.

CLASS 11—ENVIRONMENTAL CONTROL APPARATUS

2,572,237. INFRARED DYNAMICS, INC., COSTA MESA, CA. SN 75-333,031. FILED P.R. 7-30-1997; AM. S.R. 8-13-2001.

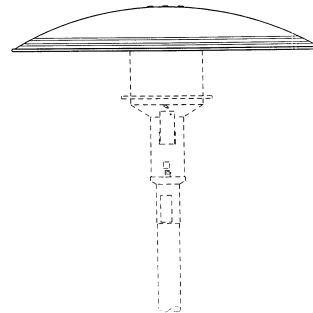

THE LINING ON THE REFLECTOR IS A DESIGN FEATURE OF THE MARK AND IS NOT INTENDED TO SHOW COLOR.

THE MARK CONSISTS OF A CONFIGURATION OF A REFLECTOR FOR A HEAT LAMP. THE DOTTED LINES IN THE DRAWING ARE NOT A FEATURE OF THE MARK BUT INSTEAD SHOW THE POSITION OF THE MARK ON THE GOODS.

FOR HEATERS, NAMELY, HEAT LAMPS, FOR NON-MEDICAL USE (U.S. CLS. 13, 21, 23, 31 AND 34).

FIRST USE 12-0-1963; IN COMMERCE 12-0-1963.

CLASS 11—(Continued).

2,572,321. EVEREADY BATTERY COMPANY, INC., ST. LOUIS, MO. SN 76-091,944. FILED P.R. 7-19-2000; AM. S.R. 11-6-2001.

LIZARD LIGHT

NO CLAIM IS MADE TO THE EXCLUSIVE RIGHT TO USE "LIGHT", APART FROM THE MARK AS SHOWN. FOR FLASHLIGHTS (U.S. CLS. 13, 21, 23, 31 AND 34). FIRST USE 7-26-2000; IN COMMERCE 7-26-2000.

2,572,359. SPENCER GIFTS, INC., EGG HARBOR TOWNSHIP, NJ. SN 76-191,366. FILED P.R. 1-8-2001; AM. S.R. 1-14-2002.

DAISY

FOR LAMPS (U.S. CLS. 13, 21, 23, 31 AND 34). FIRST USE 12-14-2000; IN COMMERCE 12-14-2000.

2,572,399. TECHNICAL CONCEPTS LP, MUNDELEIN, IL. SN 76-295,877. FILED P.R. 8-6-2001; AM. S.R. 12-7-2001.

AUTO FAUCET

NO CLAIM IS MADE TO THE EXCLUSIVE RIGHT TO USE "FAUCET", APART FROM THE MARK AS SHOWN. FOR FAUCETS AND CONNECTING PARTS THEREFOR THAT OPERATE IN RELATION TO THE PROXIMITY OF THE USER (U.S. CLS. 13, 21, 23, 31 AND 34). FIRST USE 9-0-1999; IN COMMERCE 9-0-1999.

CLASS 12—VEHICLES

2,572,379. PANKL AEROSPACE SYSTEMS, CERRITOS, CA. SN 76-225,863. FILED P.R. 3-19-2001; AM. S.R. 10-1-2001.

L. A. ENTERPRISES

NO CLAIM IS MADE TO THE EXCLUSIVE RIGHT TO USE "ENTERPRISES", APART FROM THE MARK AS SHOWN. FOR AUTOMOTIVE ENGINE COMPONENTS FOR THE RACING INDUSTRY, NAMELY, CRANKSHAFTS AND CONNECTING RODS (U.S. CLS. 19, 21, 23, 31, 35 AND 44). FIRST USE 5-1-1998; IN COMMERCE 5-1-1998.

CLASS 13—FIREARMS**CLASS 13—(Continued).**

2,572,243. PHALANX CORPORATION, BOCA RATON, FL. SN 75-578,833. FILED P.R. 10-28-1998; AM. S.R. 1-31-2002.

**WORLD'S FIRST
AUTOMATIC LOADING
HOLSTER**

NO CLAIM IS MADE TO THE EXCLUSIVE RIGHT TO USE "AUTOMATIC LOADING HOLSTER", APART FROM THE MARK AS SHOWN. FOR HOLSTERS (U.S. CLS. 2 AND 9). FIRST USE 4-0-1998; IN COMMERCE 4-0-1998.

CLASS 15—MUSICAL INSTRUMENTS

2,572,383. STELLAR INTERNATIONAL MUSIC CORP., FULLERTON, CA. SN 76-233,161. FILED P.R. 4-2-2001; AM. S.R. 11-12-2001.

ROSSETTI

FOR MUSICAL INSTRUMENTS, ACCORDIONS, FLUTES, TRUMPETS, SAXOPHONES, VIOLINS, GUITARS, TROMBONES, CLARINETS, FRENCH HORNS, ALTO HORNS, AND BARITONE HORNS (U.S. CLS. 2, 21 AND 36). FIRST USE 10-19-2000; IN COMMERCE 10-19-2000.

2,572,408. TASOVA, TASH, LILBURN, GA. SN 78-025,720. FILED P.R. 9-13-2000; AM. S.R. 9-13-2001.

**BOSPHORUS %100
HANDMADE TURKISH
CYMBALS**

NO CLAIM IS MADE TO THE EXCLUSIVE RIGHT TO USE "%100 HANDMADE TURKISH CYMBALS", APART FROM THE MARK AS SHOWN. FOR MUSICAL INSTRUMENTS, NAMELY, CYMBALS (U.S. CLS. 2, 21 AND 36). FIRST USE 7-1-1997; IN COMMERCE 7-1-1997.

**CLASS 16—PAPER GOODS AND PRINTED
MATTER**

2,572,251. JEPPESEN SANDERSON, INC., ENGLEWOOD, CO. SN 75-727,621. FILED P.R. 6-14-1999; AM. S.R. 6-7-2000.

BRIEFING STRIP

FOR PRINTED MATTER, NAMELY, APPROACH CHART FEATURING AVIATION FLIGHT INFORMATION (U.S. CLS. 2, 5, 22, 23, 29, 37, 38 AND 50). FIRST USE 4-7-1995; IN COMMERCE 4-7-1995.

CLASS 16—(Continued).

2,572,272. HOULIHAN, LOKEY, HOWARD & ZUKIN, INC., LOS ANGELES, CA. SN 75-856,990. FILED P.R. 11-24-1999; AM. S.R. 6-20-2001.

PACIFIC NORTHWEST MARKET UPDATE

FOR PERIODIC PUBLICATIONS, NAMELY, JOURNALS IN THE FIELDS OF INVESTMENTS AND VALUATION OF BUSINESSES (U.S. CLS. 2, 5, 22, 23, 29, 37, 38 AND 50).

FIRST USE 1-1-1999; IN COMMERCE 1-1-1999.

2,572,274. COMPASS MARKETING, INC., MINNEAPOLIS, MN. SN 75-858,853. FILED P.R. 11-29-1999; AM. S.R. 7-23-2001.

PARENT CLUB

FOR EDUCATIONAL BOOKS IN THE FIELD OF CHILDREN'S EDUCATION, CHILDREN'S MENTAL HEALTH, PHYSICAL HEALTH, AND OVERALL WELL-BEING (U.S. CLS. 2, 5, 22, 23, 29, 37, 38 AND 50).

FIRST USE 3-0-2000; IN COMMERCE 3-0-2000.

2,572,284. INTERTEC PUBLISHING CORPORATION, OVERLAND PARK, KS. SN 75-900,746. FILED P.R. 1-21-2000; AM. S.R. 3-27-2001.

PERSONAL STUDIO BUYER'S GUIDE

NO CLAIM IS MADE TO THE EXCLUSIVE RIGHT TO USE "BUYER'S GUIDE", APART FROM THE MARK AS SHOWN.

FOR MAGAZINES IN THE FIELD OF PRODUCTS USED FOR MUSIC PRODUCTION AND RECORDING (U.S. CLS. 2, 5, 22, 23, 29, 37, 38 AND 50).

FIRST USE 4-0-1997; IN COMMERCE 4-0-1997.

2,572,299. CONSUMERS UNION OF UNITED STATES, INC., YONKERS, NY. SN 75-981,369. FILED P.R. 3-1-2001; AM. S.R. 10-18-2001.

**CLASS 16—(Continued).**

OWNER OF U.S. REG. NO. 2,258,693.

THE DRAWING CONTAINS STIPPLING WHICH IS USED TO INDICATE THE SHADING IN THE MARK.

FOR MAGAZINE AND BOOK SECTIONS ABOUT TESTING, EVALUATING AND RATING USED CARS (U.S. CLS. 2, 5, 22, 23, 29, 37, 38 AND 50).

FIRST USE 8-0-1997; IN COMMERCE 8-0-1997.

2,572,309. LEARNING MEDIA LIMITED, WELLINGTON, NEW ZEALAND. SN 76-056,413. FILED P.R. 5-22-2000; AM. S.R. 4-16-2001.

FIRST STORIES

FOR PRINTED MATTER, NAMELY A SERIES OF CHILDREN'S FICTION BOOKS AND A SERIES OF CHILDREN'S NON-FICTION BOOKS ON THE TOPIC OF MATHEMATICS, SCIENCE, SOCIAL STUDIES, HEALTH, ART, TECHNOLOGY AND PHYSICAL WELL-BEING; AND PRINTED TEACHING MATERIALS, NAMELY EDUCATIONAL CHARTS AND TEACHER RESOURCE BOOKS IN THE FIELDS OF MATHEMATICS, SCIENCE, SOCIAL STUDIES, HEALTH, ART, TECHNOLOGY AND PHYSICAL WELL-BEING (U.S. CLS. 2, 5, 22, 23, 29, 37, 38 AND 50).

FIRST USE 6-0-2000; IN COMMERCE 6-0-2000.

2,572,348. NATIONAL ASSOCIATION OF DEMOLITION CONTRACTORS, INC., DOYLESTOWN, PA. SN 76-169,696. FILED P.R. 11-22-2000; AM. S.R. 7-10-2001.

DEMOLITION

FOR TRADE JOURNAL DIRECTED TO DEMOLITION CONTRACTORS (U.S. CLS. 2, 5, 22, 23, 29, 37, 38 AND 50).

FIRST USE 1-1-1997; IN COMMERCE 1-1-1997.

2,572,376. UNIVERSITY OF NORTH TEXAS, DENTON, TX. SN 76-220,873. FILED P.R. 3-8-2001; AM. S.R. 1-17-2002.

BUSINESS@NORTHTEXAS

FOR MAGAZINE FEATURING INFORMATION ABOUT THE UNIVERSITY OF NORTH TEXAS COLLEGE OF BUSINESS ADMINISTRATION (U.S. CLS. 2, 5, 22, 23, 29, 37, 38 AND 50).

FIRST USE 12-10-1999; IN COMMERCE 3-1-2000.

2,572,405. WILD HARE, L.L.P., THE, TROY, MI. SN 76-339,102. FILED P.R. 11-16-2001; AM. S.R. 3-6-2002.

BUNNY TRACKS

FOR BOX WITH STENCILS CONTAINING A POWDER FOR MANUALLY DEPOSITING IMAGES ONTO FLOORS (U.S. CLS. 2, 5, 22, 23, 29, 37, 38 AND 50).

FIRST USE 8-3-2001; IN COMMERCE 8-3-2001.

CLASS 16—(Continued).

2,572,415. HEDSTROM CORPORATION, MT. PROSPECT, IL. SN 78-055,294. FILED P.R. 3-27-2001; AM. S.R. 1-11-2002.

3-D STICK-UPS

OWNER OF U.S. REG. NOS. 1,634,015, 1,981,785, AND 2,028,017.

FOR ADHESIVE DECALS (U.S. CLS. 2, 5, 22, 23, 29, 37, 38 AND 50).

FIRST USE 2-0-2001; IN COMMERCE 2-0-2001.

CLASS 19—NON-METALLIC BUILDING MATERIALS

2,572,247. TRUSTILE DOORS, INC., DENVER, CO. SN 75-663,698. FILED P.R. 3-17-1999; AM. S.R. 12-10-2001.

THE WEDGE

FOR NON-METAL DOOR EDGE STRENGTHENING PROTECTORS FOR USE IN THE MANUFACTURE OF DOORS, AND SOLD EXCLUSIVELY TO DOOR MANUFACTURERS, WHOLESALE DOOR DEALERS, AND CONSTRUCTION CONTRACTORS (U.S. CLS. 1, 12, 33 AND 50).

FIRST USE 1-1-1999; IN COMMERCE 1-15-1999.

2,572,250. STONETREE, LLC, SALT LAKE CITY, UT. SN 75-724,024. FILED P.R. 6-8-1999; AM. S.R. 4-6-2001.

STONEWELL

FOR WINDOW WELLS (U.S. CLS. 1, 12, 33 AND 50).
FIRST USE 6-0-1999; IN COMMERCE 6-0-1999.

CLASS 20—FURNITURE AND ARTICLES NOT OTHERWISE CLASSIFIED

2,572,291. SKB CORPORATION, ORANGE, CA. SN 75-930,894. FILED P.R. 2-28-2000; AM. S.R. 2-8-2001.

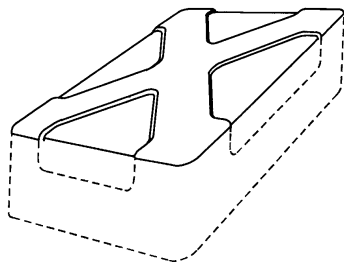

FOR NON-METAL CONTAINERS FOR THE STORAGE AND TRANSPORTATION OF GOODS AND EQUIPMENT (U.S. CLS. 2, 13, 22, 25, 32 AND 50).
FIRST USE 8-3-1999; IN COMMERCE 8-3-1999.

CLASS 20—(Continued).

2,572,388. 3-D MARKETING, INC., HARTLAND, WI. SN 76-250,974. FILED P.R. 5-2-2001; AM. S.R. 9-24-2001.

SPORT SEAT

FOR COMBINATION SEAT CUSHION AND DRINK TRAY (U.S. CLS. 2, 13, 22, 25, 32 AND 50).

FIRST USE 7-18-2001; IN COMMERCE 7-18-2001.

2,572,416. TWENTY-TWO, INC., BIRMINGHAM, MI. SN 78-058,395. FILED P.R. 4-13-2001; AM. S.R. 11-29-2001.

BUILD YOUR OWN FURNITURE SYSTEMS

FOR FURNITURE, NAMELY, BEDROOM FURNITURE, COMPUTER FURNITURE, CABINETS, DRAFTING TABLES, FURNITURE FRAMES, DOORS FOR FURNITURE, LAWN FURNITURE, LIVING ROOM FURNITURE, OFFICE FURNITURE, OUTDOOR FURNITURE (U.S. CLS. 2, 13, 22, 25, 32 AND 50).

FIRST USE 4-13-2001; IN COMMERCE 4-13-2001.

CLASS 21—HOUSEWARES AND GLASS

2,572,371. SOTHMAN, DONALD J., MENOMONEE FALLS, WI. SN 76-216,911. FILED P.R. 2-27-2001; AM. S.R. 11-14-2001.

POPCORN FORK

NO CLAIM IS MADE TO THE EXCLUSIVE RIGHT TO USE "FORK", APART FROM THE MARK AS SHOWN.

FOR HOUSEHOLD UTENSILS, NAMELY, TONG-LIKE EATING UTENSILS (U.S. CLS. 2, 13, 23, 29, 30, 33, 40 AND 50).

FIRST USE 4-0-1991; IN COMMERCE 4-0-1991.

CLASS 25—CLOTHING

2,572,244. DEJA BLEU, LLC, NEW YORK, NY. SN 75-580,492. FILED P.R. 10-29-1998; AM. S.R. 9-1-2000.

ORIGINAL THREADS

FOR CLOTHING, NAMELY SKIRTS, TOPS, AND BOTTOMS (U.S. CLS. 22 AND 39).
FIRST USE 8-1-1998; IN COMMERCE 9-1-1998.

CLASS 25—(Continued).

2,572,246. WEIN, MARC, COS COB, CT. AND WEIN, MARGARET R., COS COB, CT. SN 75-659,166. FILED P.R. 3-12-1999; AM. S.R. 11-30-2000.

BOXER BOXER

NO CLAIM IS MADE TO THE EXCLUSIVE RIGHT TO USE "BOXER", APART FROM THE MARK AS SHOWN.

FOR CLOTHING, NAMELY, PANTS, UNDERWEAR, JEANS, WARM-UP SUITS, SWEATSUITS, SOCKS, HATS, AND SHIRTS (U.S. CLS. 22 AND 39).

FIRST USE 6-0-1999; IN COMMERCE 6-0-1999.

2,572,289. KAYSER-ROTH CORPORATION, GREENSBORO, NC. SN 75-917,675. FILED P.R. 2-14-2000; AM. S.R. 9-26-2001.

TRANSPARENT CONTROL

FOR PANTYHOSE AND TIGHTS (U.S. CLS. 22 AND 39).

FIRST USE 7-28-2000; IN COMMERCE 7-28-2000.

2,572,293. EBEJER, BRIAN, NEW YORK, NY. AND EBEJER, ERIKH, NEW YORK, NY. SN 75-934,152. FILED P.R. 2-22-2000; AM. S.R. 6-25-2001.

EVERYTHING SUCKS

FOR CLOTHING, NAMELY, SWEATSHIRTS, T-SHIRTS, JERSEYS, TANKS TOPS, HATS, CAPS AND FOOTWEAR (U.S. CLS. 22 AND 39).

FIRST USE 8-8-1998; IN COMMERCE 11-10-1998.

2,572,330. GLORIA VANDERBILT TRADEMARK B.V., 1101 CR AMSTERDAM-Z.O., NETHERLANDS. SN 76-126,193. FILED P.R. 9-12-2000; AM. S.R. 2-12-2002.

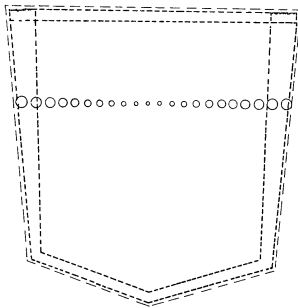

THE MARK CONSISTS OF MOTIF OF GRADUATING DOTS WHICH ARE LARGER ON THE LEFT AND RIGHT SIDES OF THE MARK AND BECOME PROGRESSIVELY SMALLER TOWARD THE CENTER OF THE MARK. THE BROKEN LINES REPRESENT BOTH THE STITCHING ON THE POCKET AND THE PERIMETER OF THE POCKET, TO

CLASS 25—(Continued).

WHICH THE POCKET AND THE PERIMETER OF THE POCKET, TO WHICH THE APPLICANT MAKES NO CLAIM AND WHICH SERVE ONLY TO INDICATE THE POSITION OF THE MARK ON THE POCKET.

FOR WOMEN'S AND CHILDREN'S PANTS, JEANS, SHORTS, SKIRTS AND OVERALLS (U.S. CLS. 22 AND 39).

FIRST USE 12-1-2000; IN COMMERCE 12-1-2000.

2,572,335. FUZZY MANGO, INC., BOKEELIA, FL. SN 76-137,860. FILED P.R. 9-29-2000; AM. S.R. 9-24-2001.

BOKEELIA BAY

FOR WOMEN'S SPORTSWEAR, NAMELY TOPS, SHIRTS, SHORTS, PANTS, SKIRTS AND DRESSES (U.S. CLS. 22 AND 39).

FIRST USE 12-31-2000; IN COMMERCE 12-31-2000.

2,572,337. ANGER, JULIE E., DBA POET GIFTS, LIVONIA, MI. SN 76-141,152. FILED P.R. 10-5-2000; AM. S.R. 9-26-2001.

POETRY RULES!

FOR CLOTHING, NAMELY, POLO AND GOLF SHIRTS, TANK TOPS, T-SHIRTS, CARDIGANS, SWEAT SHIRTS AND SWEAT PANTS, PAJAMAS AND NIGHT GOWNS, VISORS, TIES, HATS AND CAPS (U.S. CLS. 22 AND 39).

FIRST USE 7-21-2000; IN COMMERCE 7-28-2000.

2,572,363. HENDERSON AQUATICS, INC., MILLVILLE, NJ. SN 76-197,765. FILED P.R. 1-22-2001; AM. S.R. 7-23-2001.

HYPERSTRETCH

FOR ELASTOMERIC MATERIAL SOLD AS A COMPONENT OF WATERSPORTS APPAREL, NAMELY, WETSUITS AND HOODS (U.S. CLS. 22 AND 39).

FIRST USE 11-20-2000; IN COMMERCE 11-20-2000.

2,572,369. CHARTER CAPITAL, INC, PLAINFIELD, IN. SN 76-209,464. FILED P.R. 2-14-2001; AM. S.R. 10-15-2001.

GOD'S TEAM

FOR CLOTHING; NAMELY, SHIRTS, PANTS, JACKETS, FOOTWEAR; NAMELY, SHOES, SOCKS, HEADGEAR; NAMELY, CAPS, HATS AND CLOTH BABY BIBS (U.S. CLS. 22 AND 39).

FIRST USE 5-11-2000; IN COMMERCE 5-11-2000.

CLASS 25—(Continued).

2,572,397. TCPIP, INC., WILMINGTON, DE. SN 76-288,006. FILED 7-21-2001.

TINY TANK

NO CLAIM IS MADE TO THE EXCLUSIVE RIGHT TO USE "TANK", APART FROM THE MARK AS SHOWN. FOR INFANTS' AND CHILDREN'S ROMPERS, SWEATSHIRTS, SWEATPANTS, SWEATSHIRTS, JACKETS, CAPS, AND SWEATERS (U.S. CLS. 22 AND 39). FIRST USE 7-1-2001; IN COMMERCE 7-1-2001.

CLASS 27—FLOOR COVERINGS

2,572,366. BETTER SLEEP, INC., BERKELEY HEIGHTS, NJ. SN 76-205,159. FILED P.R. 2-5-2001; AM. S.R. 10-29-2001.

BUBBLE MAT

NO CLAIM IS MADE TO THE EXCLUSIVE RIGHT TO USE "MAT", APART FROM THE MARK AS SHOWN. FOR PLASTIC MATS FOR BATHROOM TUBS (U.S. CLS. 19, 20, 37, 42 AND 50). FIRST USE 3-22-2000; IN COMMERCE 3-22-2000.

CLASS 28—TOYS AND SPORTING GOODS

2,572,241. THARP, DANIAL, NORTH FORT MYERS, FL. SN 75-540,741. FILED P.R. 8-21-1998; AM. S.R. 7-30-2001.

THE BEST HOOK IN THE WORLD

NO CLAIM IS MADE TO THE EXCLUSIVE RIGHT TO USE "HOOK", APART FROM THE MARK AS SHOWN. FOR SPORTS EQUIPMENT, NAMELY, FISHING HOOKS WITH MULTIPLE BARBS (U.S. CLS. 22, 23, 38 AND 50). FIRST USE 5-0-1998; IN COMMERCE 10-0-1999.

2,572,342. AUSTIN, MICHAEL W., POINT PLEASANT, WV. SN 76-157,065. FILED P.R. 11-1-2000; AM. S.R. 1-22-2002.

MOTHMAN

THE NAME "MOTHMAN" DOES NOT REFER TO A LIVING INDIVIDUAL BUT IS THE NAME OF A FICTITIOUS CHARACTER. FOR PLUSH TOYS (U.S. CLS. 22, 23, 38 AND 50). FIRST USE 1-5-2002; IN COMMERCE 1-11-2002.

CLASS 28—(Continued).

2,572,353. COFFEEN, ERIC L., DBA COFE PRODUCTS, SAN DIEGO, CA. SN 76-177,989. FILED P.R. 12-8-2000; AM. S.R. 11-13-2001.

FREE SPOOLER

FOR FISHING REEL ACCESSORIES; NAMELY, SPOOLS (U.S. CLS. 22, 23, 38 AND 50). FIRST USE 6-1-1996; IN COMMERCE 10-5-1996.

CLASS 29—MEATS AND PROCESSED FOODS

2,572,236. JONMOR INVESTMENTS, INC., WILMINGTON, DE, BY ASSIGNMENT JOHN MORRELL & CO., CINCINNATI, OH. SN 75-243,239. FILED P.R. 2-18-1997; AM. S.R. 8-8-2001.

GREAT FOR GRILLING

FOR PROCESSED MEATS, EXCLUDING POULTRY (U.S. CL. 46). FIRST USE 5-1-1994; IN COMMERCE 5-1-1994.

2,572,368. CAROLINA SOY PRODUCTS, INC., WARSAW, NC. SN 76-209,069. FILED P.R. 2-12-2001; AM. S.R. 11-26-2001.

CAROLINA SOY

NO CLAIM IS MADE TO THE EXCLUSIVE RIGHT TO USE "SOY", APART FROM THE MARK AS SHOWN. FOR VEGETABLE OIL (U.S. CL. 46). FIRST USE 11-21-2001; IN COMMERCE 11-21-2001.

CLASS 30—STAPLE FOODS

2,572,328. UMEYA RICE CAKE COMPANY, LOS ANGELES, CA. SN 76-112,361. FILED P.R. 8-18-2000; AM. S.R. 6-25-2001.

SOY NUGGETS

NO CLAIM IS MADE TO THE EXCLUSIVE RIGHT TO USE "SOY", APART FROM THE MARK AS SHOWN. FOR TOASTED SNACK FOODS CONSISTING PRIMARILY OF SOY FLOUR, SOY BEANS, AND OTHER GRAIN BASED FLOURS (U.S. CL. 46). FIRST USE 5-1-2000; IN COMMERCE 5-1-2000.

CLASS 30—(Continued).

2,572,364. PHILADELPHIA CHEWING GUM CORPORATION, HAVERTOWN, PA. SN 76-200,950. FILED P.R. 1-26-2001; AM. S.R. 7-30-2001.

EASTER BASKET EGGS

OWNER OF U.S. REG. NOS. 1,148,090, 2,179,633, AND OTHERS.

NO CLAIM IS MADE TO THE EXCLUSIVE RIGHT TO USE "EGGS", APART FROM THE MARK AS SHOWN. FOR CHEWING GUM AND CANDY (U.S. CL. 46). FIRST USE 1-19-2001; IN COMMERCE 1-19-2001.

2,572,410. NABISCO BRANDS COMPANY, WILMINGTON, DE. SN 78-039,333. FILED P.R. 12-14-2000; AM. S.R. 11-19-2001.

**AMERICA'S FAVORITE
COOKIE**

OWNER OF U.S. REG. NO. 2,149,887. FOR COOKIES (U.S. CL. 46). FIRST USE 2-1-1998; IN COMMERCE 2-1-1998.

CLASS 31—NATURAL AGRICULTURAL PRODUCTS

2,572,413. RALSTON PURINA COMPANY, ST. LOUIS, MO. SN 78-047,818. FILED P.R. 2-12-2001; AM. S.R. 1-7-2002.

**HEALTHY MORSELS
FORMULA**

FOR PET FOOD (U.S. CLS. 1 AND 46). FIRST USE 4-0-2001; IN COMMERCE 4-0-2001.

CLASS 32—LIGHT BEVERAGES

2,572,393. QUIKTRIP WEST, INC., WICHITA, KS. SN 76-268,778. FILED P.R. 6-5-2001; AM. S.R. 9-4-2001.

FOUNTAIN MIXER

FOR CARBONATED SYRUP COMBINED FOR MAKING SOFT DRINKS AND DISPENSED FROM A MACHINE (U.S. CLS. 45, 46 AND 48). FIRST USE 4-1-2001; IN COMMERCE 4-1-2001.

CLASS 33—WINES AND SPIRITS**CLASS 33—(Continued).**

2,572,370. FRANCESCO AZIENDA AGRICOLA SPADAFORA, 1-90144 PALERMO, ITALY. SN 76-212,646. FILED P.R. 2-20-2001; AM. S.R. 11-19-2001.

SPADAFORA

FOR WINES (U.S. CLS. 47 AND 49). FIRST USE 6-0-2000; IN COMMERCE 6-0-2000.

2,572,394. DIZOGLIO, FRANK P. III, JAMESTOWN, RI. SN 76-272,169. FILED P.R. 6-15-2001; AM. S.R. 2-19-2002.

DELVECCHIO

FOR ALCOHOLIC BEVERAGES, NAMELY, WINE (U.S. CLS. 47 AND 49). FIRST USE 10-1-2000; IN COMMERCE 10-1-2000.

SERVICE MARKS**CLASS 35—ADVERTISING AND BUSINESS**

2,572,260. INTERPUBLIC GROUP OF COMPANIES, INC., THE, NEW YORK, NY, BY ASSIGNMENT TRUE NORTH COMMUNICATIONS INC., CHICAGO, IL. SN 75-802,047. FILED P.R. 9-17-1999; AM. S.R. 5-14-2001.

RELATIONSHIP MONITOR

FOR MARKETING RESEARCH SERVICES (U.S. CLS. 100, 101 AND 102). FIRST USE 7-20-1999; IN COMMERCE 7-20-1999.

2,572,266. CAMPUSCAREERCENTER.COM, INC., CAMBRIDGE, MA. SN 75-836,604. FILED P.R. 11-1-1999; AM. S.R. 10-2-2000.

**GLOBAL CAMPUS
RECRUITING NETWORK**

NO CLAIM IS MADE TO THE EXCLUSIVE RIGHT TO USE "GLOBAL RECRUITING NETWORK", APART FROM THE MARK AS SHOWN.

FOR PERSONNEL RECRUITMENT SERVICES FOR EMPLOYERS AND JOB AND INTERNSHIP PLACEMENT SERVICES FOR STUDENTS DELIVERED BY MEANS OF A GLOBAL COMPUTER NETWORK (U.S. CLS. 100, 101 AND 102). FIRST USE 2-0-1999; IN COMMERCE 3-15-1999.

CLASS 35—(Continued).

2,572,269. ISKY, INC., COLUMBIA, MD, BY CHANGE OF NAME SKY ALLAND RESEARCH, INC., COLUMBIA, MD. SN 75-848,711. FILED P.R. 11-15-1999; AM. S.R. 7-17-2001.

THE CUSTOMER LOYALTY MANAGEMENT COMPANY

NO CLAIM IS MADE TO THE EXCLUSIVE RIGHT TO USE "COMPANY", APART FROM THE MARK AS SHOWN. FOR BUSINESS MARKETING CONSULTING SERVICES PERTAINING TO CUSTOMER RELATIONSHIP MANAGEMENT FOR OTHERS; BUSINESS MARKETING CONSULTING SERVICES, NAMELY, DATABASE MARKETING; TELEMARKETING SERVICES; TELE-SERVICING FOR OTHERS, NAMELY, INITIATING, RECEIVING AND RESPONDING TO TELEPHONE AND TELEFACSIMILE COMMUNICATIONS AND INQUIRIES TO AND FROM CUSTOMERS OF OTHER BUSINESSES; PROMOTING THE GOODS AND SERVICES OF OTHERS VIA DIRECT MAIL AND TELEPHONE; PROMOTING THE GOODS AND SERVICES OF OTHERS VIA AN ON-LINE ELECTRONIC COMMUNICATIONS NETWORK BY PROVIDING INFORMATION FOR THEIR CUSTOMERS; CONDUCTING PRIMARY AND SECONDARY BUSINESS RESEARCH; OPERATING AND MANAGING TELEPHONE CALL CENTERS; CUSTOMER SERVICE FULFILLMENT SERVICES FOR OTHERS, NAMELY, RESPONDING TO AND CONFIRMING AND FILLING CUSTOMER ORDERS FOR OTHERS (U.S. CLS. 100, 101 AND 102).

FIRST USE 11-1-1999; IN COMMERCE 11-1-1999.

2,572,273. FIFN, INC., SEAL BEACH, CA. SN 75-857,984. FILED P.R. 11-16-1999; AM. S.R. 10-4-2001.

SMARTENGINE

FOR PREPARING AND PLACING ADVERTISING FOR OTHERS; BUSINESS CONSULTATION; BUSINESS INFORMATION IN THE FIELD OF BUYING AND SELLING PERSONAL PROPERTY; BUSINESS INVESTIGATIONS; BUSINESS MANAGEMENT PLANNING; BUSINESS RESEARCH; DEVELOPING PROMOTIONAL CAMPAIGNS FOR BUSINESSES; MARKET ANALYSIS; MARKET RESEARCH; PREPARING MAILING LISTS; PROFIT SURVEYS AND ANALYSIS; RETAIL STORE SERVICES FEATURING CLOTHING, PAPER GOODS, BOOKS, GENERAL CONSUMER MERCHANDISE, TOYS, DIGITAL PLAYERS, TAX PREPARATION FORMS, STICKERS, CELEBRITY MEMORABILIA, AND COMPUTER SOFTWARE (U.S. CLS. 100, 101 AND 102).

FIRST USE 11-15-1999; IN COMMERCE 11-15-1999.

2,572,290. VIRTUAL COUNTRIES, INC., SEATTLE, WA. SN 75-918,366. FILED P.R. 2-11-2000; AM. S.R. 10-4-2001.

E-GERMANY.COM

FOR BUSINESS ADVERTISING, NAMELY, PLACING ADVERTISEMENTS AND PROMOTIONAL DISPLAYS OF ANOTHER PARTY ON A PORTION OF THE SERVICE PROVIDER'S INTERNET WEB SITE RENTED BY THAT OTHER PARTY (U.S. CLS. 100, 101 AND 102).

FIRST USE 3-31-2000; IN COMMERCE 3-31-2000.

CLASS 35—(Continued).

2,572,292. W-I-LINK.COM INC., RICHMOND, VA. SN 75-930,994. FILED P.R. 2-29-2000; AM. S.R. 10-9-2001.

LINKING INVESTORS WITH COMPANIES AND FUNDS

FOR DISTRIBUTION OF PROSPECTUSES, ANNUAL REPORTS, MUTUAL FUND INFORMATION, AND OTHER FINANCIAL LITERATURE OF OTHERS; BUSINESS INFORMATION SERVICES IN THE FIELD OF INVESTOR AND SHAREHOLDER RELATIONS AND COMMUNICATIONS; AND PROXY SOLICITATION SERVICES (U.S. CLS. 100, 101 AND 102).

FIRST USE 10-1-1999; IN COMMERCE 10-1-1999.

2,572,300. WINTER PARK RECREATIONAL ASSOCIATION, WINTER PARK, CO. SN 76-003,102. FILED P.R. 3-17-2000; AM. S.R. 3-5-2001.

THE VILLAGE AT WINTER PARK

OWNER OF U.S. REG. NOS. 961,726, 1,401,619, AND 2,000,722.

FOR BUSINESS MARKETING CONSULTING SERVICES AS THEY RELATE TO RETAIL RECREATIONAL AND RESORT COMPLEXES; DISSEMINATION OF ADVERTISING MATTER FOR OTHERS; AND PROMOTING THE SALE OF GOODS AND SERVICES OF OTHERS THROUGH THE DISTRIBUTION OF PRINTED MATERIAL (U.S. CLS. 100, 101 AND 102).

FIRST USE 7-25-1999; IN COMMERCE 7-25-1999.

2,572,306. PLANET EARTH FOUNDATION, SEATTLE, WA. SN 76-032,617. FILED P.R. 4-24-2000; AM. S.R. 9-4-2001.

MEDIA PLUGS

FOR PUBLIC RELATIONS AND ADVERTISING SERVICES, NAMELY, CREATION OF TRADEMARKS AND LOGOS FOR PRODUCT AND SERVICE IDENTIFICATION (U.S. CLS. 100, 101 AND 102).

FIRST USE 12-20-1999; IN COMMERCE 12-20-1999.

2,572,307. DELAWARE CORPORATIONS LLC, WILMINGTON, DE. SN 76-044,708. FILED P.R. 5-9-2000; AM. S.R. 1-24-2001.

DELAWARE CORPORATIONS

NO CLAIM IS MADE TO THE EXCLUSIVE RIGHT TO USE "CORPORATIONS", APART FROM THE MARK AS SHOWN.

FOR BUSINESS SERVICES, NAMELY, FACILITATING THE FORMATION OF AND MAINTENANCE OF DELAWARE CORPORATIONS AND LIMITED LIABILITY COMPANIES FOR OTHERS (U.S. CLS. 100, 101 AND 102).

FIRST USE 11-15-1996; IN COMMERCE 5-22-1998.

CLASS 35—(Continued).

2,572,308. PM CO. L.L.C., CINCINNATI, OH. SN 76-048,706. FILED P.R. 5-12-2000; AM. S.R. 4-9-2001.

U.S. MEDIA SUPPLY

NO CLAIM IS MADE TO THE EXCLUSIVE RIGHT TO USE "MEDIA SUPPLY", APART FROM THE MARK AS SHOWN.

FOR WHOLESALE DISTRIBUTORSHIPS FEATURING OFFICE AND BUSINESS EQUIPMENT CONSUMABLES, NAMELY, PRINTER PAPERS, FILMS, INKS AND RIBBONS (U.S. CLS. 100, 101 AND 102).

FIRST USE 6-0-2000; IN COMMERCE 6-0-2000.

2,572,313. DIAMONDSALE.COM, ORLANDO, FL. SN 76-064,138. FILED P.R. 6-6-2000; AM. S.R. 8-6-2001.

DIAMONDSALE.COM

FOR EXCHANGE SERVICES, NAMELY BARTERING OF GOODS FOR OTHERS VIA A GLOBAL COMPUTER NETWORK, MAIL, COURIER, TELEPHONE AND FACSIMILE; COMPUTERIZED ON-LINE ORDERING SERVICES IN THE FIELD OF JEWELRY; WHOLESALE DISTRIBUTORSHIPS FEATURING JEWELRY; ON-LINE RETAIL STORE SERVICES FEATURING JEWELRY; AUCTIONERRING SERVICES BY MEANS OF A GLOBAL COMPUTER NETWORK, MAIL, COURIER, TELEPHONE AND FACSIMILE (U.S. CLS. 100, 101 AND 102).

FIRST USE 1-0-1997; IN COMMERCE 1-0-1997.

2,572,323. FOUR STAR MARKETING, INC., LINCOLNWOOD, IL. SN 76-098,187. FILED P.R. 7-27-2000; AM. S.R. 8-6-2001.

CONVENTIONBAGS.COM

FOR ON-LINE RETAIL STORE SERVICES FEATURING BRIEF BAGS, DESK FOLDERS, PADFOLIOS, AND TOTE BAGS OVER A GLOBAL COMPUTER NETWORK (U.S. CLS. 100, 101 AND 102).

FIRST USE 11-1-2001; IN COMMERCE 11-1-2001.

2,572,329. 4MOST ENTERPRISES, LLC, PARSIPPANY, NJ. SN 76-114,489. FILED P.R. 8-23-2000; AM. S.R. 8-27-2001.

JOBS4POLICE.COM

FOR PROVIDING INFORMATION IN THE FIELD OF LAW ENFORCEMENT PERSONNEL RECRUITMENT AND ASSOCIATED RECRUITMENT MATERIALS, NAMELY, JOB APPLICATION AND INTERVIEW GUIDANCE VIA A GLOBAL COMPUTER NETWORK (U.S. CLS. 100, 101 AND 102).

FIRST USE 3-3-1999; IN COMMERCE 3-3-1999.

CLASS 35—(Continued).

2,572,336. DRIVERS4HIRE.COM, LLC, COTTAGE GROVE, MN. SN 76-138,929. FILED P.R. 10-2-2000; AM. S.R. 10-9-2001.

DRIVERS4HIRE.COM

FOR EMPLOYMENT SERVICES, NAMELY, TEMPORARY EMPLOYMENT PLACEMENT SERVICES FOR TRUCK DRIVERS AND PROSPECTIVE TRUCK DRIVERS AND PROVIDING EMPLOYMENT RELATED INFORMATION FOR TRUCK DRIVERS (U.S. CLS. 100, 101 AND 102).

FIRST USE 3-1-2000; IN COMMERCE 3-1-2000.

2,572,338. TEXAS OFF ROAD PERFORMANCE, SPRING, TX. SN 76-144,197. FILED P.R. 10-11-2000; AM. S.R. 9-17-2001.

WWW.TEXASOFFROAD.COM

FOR RETAIL AND WHOLESALE STORE SERVICES IN THE FIELD OF TRUCKS AND TRUCK PARTS VIA THE GLOBAL COMMUNICATION NETWORK (U.S. CLS. 100, 101 AND 102).

FIRST USE 11-0-1998; IN COMMERCE 11-0-1998.

2,572,344. COLLECTIONINDUSTRY.COM, LLC, BETHESDA, MD. SN 76-161,343. FILED P.R. 11-8-2000; AM. S.R. 11-5-2001.

COLLECTIONINDUSTRY.COM

FOR BUSINESS INFORMATION SERVICES IN AND FOR THE DEBT COLLECTION INDUSTRY, NAMELY, PROVIDING NEWS UPDATES, EVENT AND INFORMATIONAL POSTINGS, EMPLOYMENT INFORMATION, AND CONTACT WITH VENDORS, ASSOCIATIONS, AND OTHERS IN THE INDUSTRY (U.S. CLS. 100, 101 AND 102).

FIRST USE 10-0-1999; IN COMMERCE 10-0-1999.

2,572,380. PA RESOURCES CORP., DUNMORE, PA. SN 76-228,215. FILED P.R. 3-21-2001; AM. S.R. 10-17-2001.

NATIONAL HOMEOWNER RESOURCES

FOR BUSINESS MANAGEMENT AND MARKETING CONSULTATION IN THE HOME IMPROVEMENT INDUSTRY (U.S. CLS. 100, 101 AND 102).

FIRST USE 3-0-1998; IN COMMERCE 3-0-1998.

CLASS 35—(Continued).

2,572,402. DECISION ANALYST, INC., ARLINGTON, TX. SN 76-329,418. FILED P.R. 10-16-2001; AM. S.R. 1-4-2002.

EXECUTIVE ADVISORY BOARD

NO CLAIM IS MADE TO THE EXCLUSIVE RIGHT TO USE "BOARD", APART FROM THE MARK AS SHOWN.

FOR PROVISION OF MARKETING RESEARCH AND OPINION SURVEY SERVICES BY A PANEL OF EXECUTIVES VIA THE INTERNET (U.S. CLS. 100, 101 AND 102). FIRST USE 7-6-2000; IN COMMERCE 7-6-2000.

2,572,403. DECISION ANALYST, INC., ARLINGTON, TX. SN 76-329,420. FILED P.R. 10-16-2001; AM. S.R. 1-4-2002.

PHYSICIANS ADVISORY COUNCIL

NO CLAIM IS MADE TO THE EXCLUSIVE RIGHT TO USE "COUNCIL", APART FROM THE MARK AS SHOWN.

FOR PROVISION OF MARKETING RESEARCH AND OPINION SURVEY SERVICES BY A PANEL OF PHYSICIANS VIA THE INTERNET (U.S. CLS. 100, 101 AND 102).

FIRST USE 10-23-1999; IN COMMERCE 10-23-1999.

2,572,404. DECISION ANALYST, INC., ARLINGTON, TX. SN 76-329,421. FILED P.R. 10-16-2001; AM. S.R. 1-17-2002.

TECHNOLOGY ADVISORY BOARD

NO CLAIM IS MADE TO THE EXCLUSIVE RIGHT TO USE "BOARD", APART FROM THE MARK AS SHOWN.

FOR CONDUCTING MARKETING RESEARCH VIA THE INTERNET (U.S. CLS. 100, 101 AND 102).

FIRST USE 4-27-1999; IN COMMERCE 4-27-1999.

2,572,409. RESOLUTION TECHNOLOGY MANAGEMENT, INC., SARATOGA SPRINGS, NY. SN 78-038,181. FILED P.R. 12-7-2000; AM. S.R. 8-28-2001.

LICENSEDPRO

FOR COMPUTER SERVICES, NAMELY, PROVIDING ON-LINE DIRECTORY AND MATCHING SERVICES THAT PROVIDES LISTING OF PROFESSIONAL SERVICE PROVIDER SUCH AS LAWYERS, DOCTORS, AND ENGINEERS (U.S. CLS. 100, 101 AND 102).

FIRST USE 2-1-2001; IN COMMERCE 2-1-2001.

CLASS 35—(Continued).

2,572,419. HOLDER PHILIP T., MORRISVILLE, PA. SN 78-069,337. FILED P.R. 6-15-2001; AM. S.R. 12-19-2001.

INSTITUTE OF HYPNOSIS SCIENCES

FOR RETAIL STORE SERVICES, FEATURING HOME STUDY COURSES, VIDEO TAPES, AND TRAINING PROGRAMS RELATED TO HYPNOSIS, HYPNOTHERAPY AND OTHER INTEGRATIVE HEALTH AND WELLNESS METHODS (U.S. CLS. 100, 101 AND 102). FIRST USE 10-8-2000; IN COMMERCE 10-8-2000.

CLASS 36—INSURANCE AND FINANCIAL

2,572,238. MBNA AMERICA BANK, NATIONAL ASSOCIATION, NEWARK, DE. SN 75-362,391. FILED P.R. 9-24-1997; AM. S.R. 8-24-2001.

TITANIUM CARD

NO CLAIM IS MADE TO THE EXCLUSIVE RIGHT TO USE "CARD", APART FROM THE MARK AS SHOWN.

FOR BANKING AND CREDIT CARD SERVICES OFFERED TO PERSONS HAVING AN INTEREST IN GOLF (U.S. CLS. 100, 101 AND 102).

FIRST USE 8-0-1997; IN COMMERCE 8-0-1997.

2,572,257. CAPITAL ONE FINANCIAL CORPORATION, FALLS CHURCH, VA. SN 75-791,729. FILED P.R. 8-25-1999; AM. S.R. 1-5-2001.

ENTREPRENEUR CARD

NO CLAIM IS MADE TO THE EXCLUSIVE RIGHT TO USE "CARD", APART FROM THE MARK AS SHOWN.

FOR FINANCIAL SERVICES, NAMELY CREDIT CARD SERVICES (U.S. CLS. 100, 101 AND 102).

FIRST USE 12-8-2000; IN COMMERCE 12-8-2000.

CLASS 36—(Continued).

2,572,275. REAL ESTATE CHANNEL CORPORATION, ALTAMONTE SPRINGS, FL. SN 75-862,861. FILED P.R. 12-3-1999; AM. S.R. 4-9-2001.

REAL ESTATE CHANNEL

NO CLAIM IS MADE TO THE EXCLUSIVE RIGHT TO USE "REAL ESTATE", APART FROM THE MARK AS SHOWN.

FOR REAL ESTATE SERVICES, NAMELY, PROVIDING INFORMATION TO BUYERS AND SELLERS OF REAL ESTATE, IN THE FIELDS OF HOME LISTINGS, HOW TO SET AND NEGOTIATE PRICES, PREPARING AND SHOWING A HOME FOR SALE, MORTGAGE LENDERS, THE CLOSING PROCESS, APPRAISAL SERVICES, AND ALL INFORMATION, CONTENT, SERVICES, BROADCASTING, PROGRAMMING AND OTHER COMMERCIAL TRANSACTIONS RELATING TO THE REAL ESTATE INDUSTRY WHICH ARE AVAILABLE VIA VARIOUS MEDIA SUCH AS THE INTERNET, TELEPHONE SYSTEMS, CABLE TELEVISION SYSTEMS OR WIRELESS BROADCASTING SYSTEMS (U.S. CLS. 100, 101 AND 102).

FIRST USE 11-15-1999; IN COMMERCE 11-15-1999.

2,572,282. GREAT AMERICAN INSURANCE COMPANY, CINCINNATI, OH. SN 75-892,733. FILED P.R. 1-10-2000; AM. S.R. 1-28-2002.

GreatQuote

FOR PROVIDING TAILORED INSURANCE RATE QUOTES OVER A GLOBAL COMPUTER NETWORK (U.S. CLS. 100, 101 AND 102).

FIRST USE 12-24-1999; IN COMMERCE 12-24-1999.

2,572,283. REGENTS OF THE UNIVERSITY OF CALIFORNIA, THE, OAKLAND, CA. SN 75-898,008. FILED P.R. 1-19-2000; AM. S.R. 11-15-2001.

E-CONOMY PROJECT

FOR FUND RAISING FOR NON-PROFIT EDUCATIONAL SERVICES AND RESEARCH IN THE FIELD OF ECONOMICS (U.S. CLS. 100, 101 AND 102).

FIRST USE 3-8-1999; IN COMMERCE 3-8-1999.

CLASS 36—(Continued).

2,572,287. AURORA LOAN SERVICES INC., AURORA, CO. SN 75-914,369. FILED P.R. 2-9-2000; AM. S.R. 1-25-2002.

BROKER FUNDING SOLUTIONS

FOR ORIGINATION, PROCESSING, CLOSING AND ADMINISTRATION OF MORTGAGE LOANS (U.S. CLS. 100, 101 AND 102).

FIRST USE 4-1-1999; IN COMMERCE 4-1-1999.

2,572,295. DYNAMIC CAPITAL MANAGEMENT, INC., ANCHORAGE, AK. SN 75-938,685. FILED P.R. 3-8-2000; AM. S.R. 9-21-2001.

DYNAMIC TAX OPTIMIZER

FOR PROVIDING INVESTMENT STRATEGY AND PLANNING AND FINANCIAL ADVICE, VIA A GLOBAL COMPUTER NETWORK AND OTHER ELECTRONIC MEANS, TO INCREASE PERSONAL WEALTH (U.S. CLS. 100, 101 AND 102).

FIRST USE 8-13-2001; IN COMMERCE 8-13-2001.

2,572,301. UNION BANK OF CALIFORNIA, N.A., SAN FRANCISCO, CA. SN 76-003,815. FILED P.R. 3-20-2000; AM. S.R. 2-15-2001.

CLIENT FINANCIAL SERVICES

NO CLAIM IS MADE TO THE EXCLUSIVE RIGHT TO USE "FINANCIAL SERVICES", APART FROM THE MARK AS SHOWN.

FOR LOAN FINANCING, LOAN UNDERWRITING, LOAN PROCESSING FOR OTHERS, LOAN SERVICING FOR OTHERS, INSTALLMENT LOANS, HOME EQUITY LOANS, TEMPORARY LOANS (U.S. CLS. 100, 101 AND 102).

FIRST USE 3-0-1995; IN COMMERCE 3-0-1995.

2,572,315. WISE, STEPHEN, KENT, WA. SN 76-076,565. FILED P.R. 6-23-2000; AM. S.R. 7-16-2001.

ERENTALHOMES.COM

FOR PROVIDING REAL ESTATE INFORMATION ONLINE VIA A GLOBAL COMPUTER NETWORK FEATURING INFORMATION ON RENTAL PROPERTY AND PROPERTY MANAGEMENT (U.S. CLS. 100, 101 AND 102).

FIRST USE 4-28-2000; IN COMMERCE 4-28-2000.

CLASS 36—(Continued).

2,572,325. FORTRESS FINANCIAL SECURITIES CORP., TEMECULA, CA. SN 76-102,316. FILED P.R. 8-2-2000; AM. S.R. 8-13-2001.



NO CLAIM IS MADE TO THE EXCLUSIVE RIGHT TO USE "401(K)", APART FROM THE MARK AS SHOWN.

THE STIPPLING IS A FEATURE OF THE MARK AND DOES NOT INDICATE COLOR.

FOR FINANCIAL SERVICES, NAMELY, PROVIDING AND ADMINISTERING RETIREMENT SAVINGS ACCOUNTS AND SELF-DIRECTING BROKERAGE ACCOUNTS, ASSET ALLOCATION TOOLS, LOAN SERVICES, AND ACCOUNT STATEMENTS, TO RETIREMENT PLAN PROVIDERS, SPONSORS, AND PARTICIPANTS, FINANCIAL ANALYSIS AND CONSULTING SERVICES; FUND INVESTMENT SERVICES; FUND INVESTMENT CONSULTING; INVESTMENT TRUST AND ADMINISTRATION SERVICES, PROVIDING RETIREMENT PLANNING AND TRACKING OF INVESTMENTS MUTUAL FUNDS AND INDIVIDUAL SECURITIES BY MEANS OF GLOBAL COMPUTER NETWORK (U.S. CLS. 100, 101 AND 102).
FIRST USE 7-0-2000; IN COMMERCE 7-0-2000.

2,572,331. HATCHER ENTERPRISES, LLC, BEDFORD, TX. SN 76-131,534. FILED P.R. 9-15-2000; AM. S.R. 4-2-2001.

THE DIVERSIFICATION STRATEGY

FOR FINANCIAL PLANNING AND INVESTMENT CONSULTING SERVICES (U.S. CLS. 100, 101 AND 102).
FIRST USE 3-19-2001; IN COMMERCE 3-19-2001.

2,572,346. BANKRATE, INC., NORTH PALM BEACH, FL. SN 76-164,647. FILED P.R. 11-14-2000; AM. S.R. 11-7-2001.

BANKRATE

OWNER OF U.S. REG. NOS. 2,411,942 AND 2,413,258.
FOR FINANCIAL SERVICES IN THE NATURE OF PROVIDING FINANCIAL INFORMATION THROUGH A GLOBAL COMPUTER NETWORK, NAMELY, FINANCIAL, CAREER, AND INSURANCE ADVICE, LENDER AND TAX INFORMATION, AND FINANCIAL TOOLS (U.S. CLS. 100, 101 AND 102).
FIRST USE 8-0-1998; IN COMMERCE 8-0-1998.

CLASS 36—(Continued).

2,572,401. EMPOWERED BENEFITS, LLC, CHARLOTTE, NC. SN 76-300,413. FILED 8-17-2001.

YOUR BENEFITS MARKETPLACE

FOR ADMINISTRATION OF EMPLOYEE BENEFIT PLANS VIA THE INTERNET (U.S. CLS. 100, 101 AND 102).

FIRST USE 2-1-2001; IN COMMERCE 2-1-2001.

2,572,411. RELOCATION EXCHANGE CORP., THE, SPRINGFIELD, NJ. SN 78-039,375. FILED P.R. 12-14-2000; AM. S.R. 11-23-2001.

THE LEADER IN WORLDWIDE CORPORATE HOUSING

FOR TEMPORARY FURNISHED APARTMENT RENTALS (U.S. CLS. 100, 101 AND 102).

FIRST USE 11-0-2000; IN COMMERCE 12-13-2000.

CLASS 37—CONSTRUCTION AND REPAIR

2,572,360. SERVICES UNLIMITED, INC., WHITE CLOUD, MI. SN 76-194,496. FILED P.R. 1-16-2001; AM. S.R. 10-5-2001.

SEMIAUTOMATIC

FOR INDUSTRIAL LUBRICATION SERVICES (U.S. CLS. 100, 103 AND 106).

FIRST USE 12-31-1997; IN COMMERCE 12-31-2000.

2,572,398. UNIVERSAL SOLUTIONS INTERNATIONAL, INC., WINSTON-SALEM, NC. SN 76-290,343. FILED P.R. 7-26-2001; AM. S.R. 2-4-2002.

SAMPLE SOLUTIONS

FOR PROCESSING AND DISPOSITION OF PHARMACEUTICAL MANUFACTURERS REPRESENTATIVE'S SAMPLES WHICH ARE DAMAGED, RECALLED AND/OR OUT OF DATE (U.S. CLS. 100, 103 AND 106).

FIRST USE 11-0-2001; IN COMMERCE 11-0-2001.

CLASS 38—COMMUNICATION

CLASS 38—(Continued).

2,572,245. TRANZ-SEND BROADCASTING NETWORK, SAN FRANCISCO, CA. SN 75-598,656. FILED P.R. 12-3-1998; AM. S.R. 8-31-2000.

TRANZMOVIE

FOR BROADCASTING SERVICES, NAMELY, FILE BROADCASTING OF VIDEO DATA VIA A GLOBAL INFORMATION NETWORK (U.S. CLS. 100, 101 AND 104).

FIRST USE 4-20-2000; IN COMMERCE 4-20-2000.

2,572,258. SLAMBOOK.COM, LLC, NEW ORLEANS, LA. SN 75-795,778. FILED P.R. 9-10-1999; AM. S.R. 10-29-2001.

SLAMBOOK

FOR PROVIDING AN ON-LINE FORUM WHEREBY A SUBSCRIBER IS ALLOWED TO FORMULATE HIS OR HER OWN QUESTIONS TO BE ANSWERED BY OTHER SUBSCRIBERS WITHIN THE FORUM PRESENTED BY THE APPLICANT FOR THE PURPOSE OF AMASSING A COLLECTION OF ANSWERS PERSONAL TO THE SUBSCRIBER (U.S. CLS. 100, 101 AND 104).

FIRST USE 8-11-1998; IN COMMERCE 8-11-1998.

2,572,278. MEMPHIS NETWORKX, LLC, MEMPHIS, TN. SN 75-873,249. FILED P.R. 12-17-1999; AM. S.R. 7-31-2001.

NO CLAIM IS MADE TO THE EXCLUSIVE RIGHT TO USE "NETWORKS", APART FROM THE MARK AS SHOWN.

THE STIPPLING SHOWN IN THE DRAWING IS A FEATURE OF THE MARK AND IS NOT INTENDED TO INDICATE COLOR.

FOR TELECOMMUNICATION SERVICES, NAMELY THE TRANSMISSION OF VOICE, VIDEO AND DATA BY MEANS OF TELEPHONE, FACSIMILE, CABLE, AND SATELLITE (U.S. CLS. 100, 101 AND 104).

FIRST USE 6-12-2001; IN COMMERCE 6-12-2001.

2,572,285. ABS FAX TECHNOLOGIES, INC., HOUSTON, TX. SN 75-904,488. FILED P.R. 1-28-2000; AM. S.R. 9-27-2001.

FAXFROMTHEWEB.COM

FOR FACSIMILE TRANSMISSION SERVICES (U.S. CLS. 100, 101 AND 104).

FIRST USE 9-22-2000; IN COMMERCE 9-22-2000.

CLASS 38—(Continued).

2,572,310. RAPID 2-WAY, INC., MEDINA, OH. SN 76-058,967. FILED P.R. 5-30-2000; AM. S.R. 8-2-2001.

RAPID 2 WAY

FOR RENTAL OF PORTABLE, HAND-HELD VOICE COMMUNICATION DEVICES FOR PROFESSIONALS IN THE FIELDS OF SECURITY, NATURAL RESOURCE DRILLING AND EMERGENCY MEDICINE (U.S. CLS. 100, 101 AND 104).

FIRST USE 8-1-1999; IN COMMERCE 8-1-1999.

CLASS 39—TRANSPORTATION AND STORAGE

2,572,261. UNITED AIR LINES, INC., CHICAGO, IL. SN 75-824,943. FILED P.R. 10-18-1999; AM. S.R. 10-16-2000.

GIVE MILES

FOR AIR TRANSPORTATION SERVICES FEATURING A FREQUENT FLYERS BONUS PROGRAM (U.S. CLS. 100 AND 105).

FIRST USE 10-0-1999; IN COMMERCE 10-0-1999.

2,572,296. OVERREAD.COM, INC., PLEASANTON, CA. SN 75-943,910. FILED P.R. 3-14-2000; AM. S.R. 11-29-2001.

IMAGE WAREHOUSE

FOR PROVISION OF ELECTRONIC DATA STORAGE FOR MEDICAL IMAGES (U.S. CLS. 100 AND 105).

FIRST USE 9-0-1999; IN COMMERCE 9-0-1999.

2,572,422. PENSKE TRUCK LEASING CO., L.P., READING, PA. SN 78-086,923. FILED P.R. 10-4-2001; AM. S.R. 2-12-2002.

RENTAL EXPRESS

NO CLAIM IS MADE TO THE EXCLUSIVE RIGHT TO USE "RENTAL", APART FROM THE MARK AS SHOWN. FOR TRUCK RENTAL SERVICES (U.S. CLS. 100 AND 105).

FIRST USE 12-31-1995; IN COMMERCE 12-31-1995.

CLASS 40—MATERIAL TREATMENT

CLASS 40—(Continued).

2,572,267. POSTER.COM, INC., FORT LEE, NJ. SN 75-836,736. FILED P.R. 11-1-1999; AM. S.R. 7-31-2001.

POSTER.COM

FOR DIGITAL IMAGING SERVICES; ELECTRONIC IMAGING, ALTERATION, DIGITIZING, REPRODUCTION AND/OR RETOUCHING OF PHOTOGRAPHIC IMAGES, ARTWORK, PAINTINGS, DISPLAYS, SIGNS, AND DOCUMENTS (U.S. CLS. 100, 103 AND 106).
FIRST USE 1-1-2000; IN COMMERCE 4-1-2000.

2,572,345. BALCOM CHEMICALS, INC., DBA MPOWER 3, GREELEY, CO. SN 76-164,411. FILED P.R. 11-14-2000; AM. S.R. 10-2-2001.

SOILVIEW

FOR DIGITAL IMAGING SERVICES, NAMELY, CAPTURING AN IMAGE USING AIRBORNE IMAGING SYSTEMS OF SOIL ZONES OF DEFINED AREAS (U.S. CLS. 100, 103 AND 106).
FIRST USE 10-2-2001; IN COMMERCE 10-2-2001.

CLASS 41—EDUCATION AND ENTERTAINMENT

2,572,240. C.R. EKERN & COMPANY, PHOENIX, AZ. SN 75-504,583. FILED P.R. 6-18-1998; AM. S.R. 4-6-2001.

**CONSULTATIVE
BROKERAGE**

FOR EDUCATIONAL SERVICES, NAMELY CONDUCTING SEMINARS AND WORKSHOPS IN THE FIELD OF INSURANCE AGENTS' ADVISORY SKILLS AND METHODS (U.S. CLS. 100, 101 AND 107).
FIRST USE 2-1-1998; IN COMMERCE 2-1-1998.

2,572,252. SYLVAN LEARNING SYSTEMS, INC., BALTIMORE, MD. SN 75-731,574. FILED P.R. 6-16-1999; AM. S.R. 1-11-2002.

**ADVANCED YOUTH
SCHOLAR PROGRAM**

NO CLAIM IS MADE TO THE EXCLUSIVE RIGHT TO USE "PROGRAM", APART FROM THE MARK AS SHOWN.
FOR EDUCATIONAL SERVICES, NAMELY, PERSONALIZED INSTRUCTION FOR ACADEMICALLY ADVANCED STUDENTS IN THE FIELDS OF WRITING AND MATHEMATICS OFFERED THROUGH INTERACTIVE MEDIA (U.S. CLS. 100, 101 AND 107).
FIRST USE 1-0-1999; IN COMMERCE 1-0-1999.

CLASS 41—(Continued).

2,572,280. DONAHOE & PUROHIT, INC., CHICAGO, IL. SN 75-887,204. FILED P.R. 1-4-2000; AM. S.R. 8-30-2001.

MEDICAL VIEWPOINTS

FOR EDUCATIONAL SERVICES, NAMELY CONDUCTING SEMINARS AND WORKSHOPS IN THE FIELD OF CURRENT MEDICAL ISSUES (U.S. CLS. 100, 101 AND 107).
FIRST USE 1-1-1999; IN COMMERCE 1-1-1999.

2,572,302. PENNSYLVANIA HISTORICAL AND MUSEUM COMMISSION, HARRISBURG, PA. SN 76-004,303. FILED P.R. 3-20-2000; AM. S.R. 11-7-2001.

**PENNSYLVANIA
FOUNDER'S AWARD**

NO CLAIM IS MADE TO THE EXCLUSIVE RIGHT TO USE "FOUNDER'S AWARD", APART FROM THE MARK AS SHOWN.

FOR EDUCATIONAL SERVICES, NAMELY PROVIDING INCENTIVE TO INDIVIDUALS WHO DEMONSTRATE EXCELLENCE AND LIFE-LONG LEADERSHIP IN THE FIELD OF GOVERNMENT, EDUCATION, RELIGION, PHILANTHROPY, BUSINESS OR CULTURAL ORGANIZATIONS THROUGH THE ISSUANCE OF AWARDS (U.S. CLS. 100, 101 AND 107).
FIRST USE 3-9-1998; IN COMMERCE 3-9-1998.

2,572,318. GLASS, MICHAEL ALAN, BERKELEY, CA. SN 76-083,548. FILED P.R. 6-6-2000; AM. S.R. 10-23-2001.

KIDS' CARPENTRY

NO CLAIM IS MADE TO THE EXCLUSIVE RIGHT TO USE "CARPENTRY", APART FROM THE MARK AS SHOWN.

FOR EDUCATIONAL SERVICES, NAMELY, CONDUCTING WORKSHOPS THAT TEACH THE SAFE-USE OF WOODWORKING, MATH, AND RELATED SKILLS, NAMELY, TEAMWORK, RESPECT, COOPERATION, AND PATIENCE (U.S. CLS. 100, 101 AND 107).
FIRST USE 5-22-2000; IN COMMERCE 6-10-1999.

2,572,326. CHUNG, JAE BOCK, MADISON, WI. SN 76-109,129. FILED P.R. 8-14-2000; AM. S.R. 3-6-2001.

**NATIONAL TAE KWON DO
ASSOCIATION**

NO CLAIM IS MADE TO THE EXCLUSIVE RIGHT TO USE "TAE KWON DO ASSOCIATION", APART FROM THE MARK AS SHOWN.

FOR EDUCATIONAL SERVICES, NAMELY CONDUCTING COURSES AND SEMINARS IN THE FIELD OF MARTIAL ARTS (U.S. CLS. 100, 101 AND 107).
FIRST USE 1-1-1999; IN COMMERCE 1-1-1999.

CLASS 41—(Continued).

2,572,334. GOLF WELL AND BETTER, INC., AURORA, CO. SN 76-137,332. FILED P.R. 9-27-2000; AM. S.R. 8-27-2001.

THE GOLF INDOORS METHOD

FOR PROVIDING TRAINING, LESSONS, COURSES OF INSTRUCTION AND PARTIES IN THE FIELD OF GOLF AND DISSEMINATING VIDEOS AND PRINTED MATERIALS IN CONNECTION THEREWITH (U.S. CLS. 100, 101 AND 107).

FIRST USE 1-30-2001; IN COMMERCE 1-30-2001.

2,572,340. FAZZARI, VALENTINO, DBA FESTIVAL CATALINA COMPANY, STUDIO CITY, CA. SN 76-154,724. FILED P.R. 10-25-2000; AM. S.R. 10-3-2001.

FESTIVAL CATALINA

NO CLAIM IS MADE TO THE EXCLUSIVE RIGHT TO USE "FESTIVAL", APART FROM THE MARK AS SHOWN.

FOR ENTERTAINMENT SERVICES, NAMELY, AN ANNUAL CULTURAL FESTIVAL WHICH FEATURES LIVE PERFORMANCES BY LATIN MUSICIANS AND AWARD PRESENTATIONS TO DEMONSTRATE EXCELLENCE IN THE FIELD OF LATIN MUSIC (U.S. CLS. 100, 101 AND 107).

FIRST USE 11-1-1997; IN COMMERCE 11-1-1997.

2,572,352. BROWN RAYSMAN MILLSTEIN FELDER & STEINER LLP, NEW YORK, NY. SN 76-177,123. FILED P.R. 12-7-2000; AM. S.R. 8-24-2001.

THE TECHNOLAW CENTER

FOR EDUCATIONAL SERVICES, NAMELY, PROVIDING INSTRUCTIONS, CLASSES, AND COURSES ON TECHNOLOGY AND LEGAL ISSUES FOR OTHERS (U.S. CLS. 100, 101 AND 107).

FIRST USE 6-0-2001; IN COMMERCE 6-0-2001.

2,572,357. HOWARD BRINTON SEMINARS, INC., BOULDER, CO. SN 76-188,112. FILED P.R. 1-2-2001; AM. S.R. 12-17-2001.

THE ULTIMATE REAL ESTATE SALES RAMP-UP BOOK

NO CLAIM IS MADE TO THE EXCLUSIVE RIGHT TO USE "REAL ESTATE SALES" AND "BOOK", APART FROM THE MARK AS SHOWN.

FOR CONDUCTING REAL ESTATE TRAINING PROGRAMS AND EDUCATIONAL SERVICES, NAMELY, CONDUCTING CLASSES AND SEMINARS FOR REAL ESTATE BROKERS, MANAGERS, AND AGENTS IN THE FIELD OF REAL ESTATE SALES AND DISTRIBUTING COURSE MATERIALS RELATED THERETO (U.S. CLS. 100, 101 AND 107).

FIRST USE 9-1-2000; IN COMMERCE 9-1-2000.

CLASS 41—(Continued).

2,572,367. ZODIAC GROUP, INC., THE, BOCA RATON, FL. SN 76-207,323. FILED P.R. 2-9-2001; AM. S.R. 7-16-2001.

YELLOW PAGES PSYCHIC NETWORK

OWNER OF U.S. REG. NOS. 2,122,526, 2,143,681, AND 2,341,986.

NO CLAIM IS MADE TO THE EXCLUSIVE RIGHT TO USE "PSYCHIC NETWORK", APART FROM THE MARK AS SHOWN.

FOR ENTERTAINMENT SERVICES, NAMELY, PROVIDING PSYCHIC FORECASTING FOR OTHERS (U.S. CLS. 100, 101 AND 107).

FIRST USE 0-0-1994; IN COMMERCE 0-0-1994.

2,572,373. UNIVERSITY OF MIAMI, CORAL GABLES, FL. SN 76-218,493. FILED P.R. 3-1-2001; AM. S.R. 1-23-2002.

CENTER FOR SUSTAINABLE FISHERIES

NO CLAIM IS MADE TO THE EXCLUSIVE RIGHT TO USE "CENTER", APART FROM THE MARK AS SHOWN, FOR EDUCATIONAL RESEARCH IN THE FIELD OF MARINE SCIENCE (U.S. CLS. 100, 101 AND 107).

FIRST USE 1-17-2000; IN COMMERCE 1-17-2000.

2,572,375. BERMUDA DEPARTMENT OF TOURISM, HAMILTON HM 12, BERMUDA. SN 76-220,760. FILED P.R. 3-6-2001; AM. S.R. 12-6-2001.

BERMUDA JAZZ FESTIVAL

NO CLAIM IS MADE TO THE EXCLUSIVE RIGHT TO USE "JAZZ FESTIVAL", APART FROM THE MARK AS SHOWN.

FOR ENTERTAINMENT SERVICES IN THE NATURE OF ORGANIZING AND CONDUCTING MUSIC-RELATED EVENTS, NAMELY, LIVE CONCERTS AND FESTIVALS (U.S. CLS. 100, 101 AND 107).

FIRST USE 10-0-1998; IN COMMERCE 10-0-1998.

CLASS 41—(Continued).

2,572,385. AMERICAN INSTITUTE OF BANKING OF GREATER NEW YORK, THE, NEW YORK, NY. SN 76-246,289. FILED P.R. 4-26-2001; AM. S.R. 12-3-2001.

THE GLOBAL INSTITUTE OF FINANCE AND BANKING

FOR EDUCATIONAL SERVICES, NAMELY, PROVIDING SEMINARS, COURSES, IN THE FIELDS OF FINANCE AND BANKING COVERING THE TOPICS OF BANK OPERATIONS AND SUPERVISION, BANKING AND SECURITIES LAW, INTERNATIONAL BANKING, PERSONAL FINANCE SERVICES, COMMERCIAL FINANCIAL SERVICES, THE SECURITIES INDUSTRY, REAL ESTATE, INSURANCE, SALES AND CUSTOMER RELATIONS, FINANCIAL AND SECURITIES REGULATIONS, AND DISTRIBUTING COURSE MATERIALS IN CONNECTION THEREWITH (U.S. CLS. 100, 101 AND 107).

FIRST USE 9-1-2001; IN COMMERCE 9-1-2001.

2,572,390. ALLAN, SUSAN, STUDIO CITY, CA. SN 76-256,288. FILED P.R. 5-14-2001; AM. S.R. 10-28-2001.

THE DIVORCE FORUM

FOR EDUCATIONAL SERVICES NAMELY CONDUCTING DIVORCE SEMINARS (U.S. CLS. 100, 101 AND 107).

FIRST USE 3-2-2001; IN COMMERCE 3-2-2001.

2,572,396. MARGARET MITCHELL MUSEUM, INC., THE, ATLANTA, GA. SN 76-286,213. FILED P.R. 7-17-2001; AM. S.R. 12-12-2001.

THE CENTER FOR SOUTHERN LITERATURE

NO CLAIM IS MADE TO THE EXCLUSIVE RIGHT TO USE "CENTER", APART FROM THE MARK AS SHOWN.

FOR EDUCATIONAL SERVICES, NAMELY ARRANGING AND CONDUCTING EDUCATIONAL CONFERENCES (U.S. CLS. 100, 101 AND 107).

FIRST USE 5-1-2001; IN COMMERCE 5-1-2001.

2,572,421. ELECTRONIC INDUSTRIES FOUNDATION, ARLINGTON, VA. SN 78-083,158. FILED P.R. 9-7-2001; AM. S.R. 1-22-2002.

PROJECT HOMEPAGE

NO CLAIM IS MADE TO THE EXCLUSIVE RIGHT TO USE "PROJECT", APART FROM THE MARK AS SHOWN.

FOR EDUCATIONAL SERVICES, NAMELY, PROVIDING INTERNET-BASED SCIENCE COURSES THROUGH COLLABORATIVE RESEARCH PROJECTS FOR K-12 STUDENTS (U.S. CLS. 100, 101 AND 107).

FIRST USE 1-22-1999; IN COMMERCE 3-1-1999.

CLASS 42—SCIENTIFIC, COMPUTER AND LEGAL SERVICES

2,572,253. EMARKMONITOR INC., BOISE, ID. SN 75-770,249. FILED P.R. 8-31-1999; AM. S.R. 10-22-2001.

EBANNERMONITOR

FOR ONLINE COMPUTER SERVICES IN THE NATURE OF PROVIDING A SEARCH ENGINE FOR SEARCHING AND RETRIEVING INFORMATION, SITES, DATA AND OTHER RESOURCES AVAILABLE ON A GLOBAL COMPUTER NETWORK (U.S. CLS. 100 AND 101).

FIRST USE 11-1-1999, STATEMENTS MAY JEOPARDIZE THE VALIDITY OF THE APPLICATION OR ANY RESULTING REGISTRATION, DECLARES THAT HE/SHE IS PROPERLY AUTHORIZED TO EXECUTE THIS APPLICATION ON BEHALF OF THE; IN COMMERCE 11-1-1999, STATEMENTS MAY JEOPARDIZE THE VALIDITY OF THE APPLICATION OR ANY RESULTING REGISTRATION, DECLARES THAT HE/SHE IS PROPERLY AUTHORIZED TO EXECUTE THIS APPLICATION ON BEHALF OF THE.

2,572,294. FLATBREAD COMPANY, INC., AMESBURY, MA. SN 75-934,995. FILED P.R. 3-3-2000; AM. S.R. 6-21-2001.

FLATBREAD COMPANY

NO CLAIM IS MADE TO THE EXCLUSIVE RIGHT TO USE "COMPANY", APART FROM THE MARK AS SHOWN. FOR RESTAURANT SERVICES, NAMELY BAR AND CARRYOUT (U.S. CLS. 100 AND 101).

FIRST USE 6-25-1998; IN COMMERCE 6-25-1998.

2,572,297. INFRASTRUCTURE DEFENSE, INC., ALEXANDRIA, VA. SN 75-950,156. FILED P.R. 2-28-2000; AM. S.R. 12-11-2001.

IALERT

FOR COMPUTER NETWORK SECURITY SERVICES, NAMELY, PROVIDING ONLINE SECURITY ALERTS OF UNAUTHORIZED ACCESS AND SECURITY THREATS TO ELECTRONIC INFORMATION AND COMMUNICATIONS NETWORKS (U.S. CLS. 100 AND 101).

FIRST USE 6-15-1999; IN COMMERCE 7-15-1999.

CLASS 42—(Continued).

2,572,304. WILD WELL CONTROL, INC., SPRING, TX. SN 76-031,488. FILED P.R. 4-21-2000; AM. S.R. 11-20-2001.



NO CLAIM IS MADE TO THE EXCLUSIVE RIGHT TO USE "INC.", APART FROM THE MARK AS SHOWN.

THE MARK CONSISTS OF A DRAWING OF PART OF THE HEAD OF A MAN WEARING A HARD HAT NEXT TO AN OIL OR GAS WELL AND A CLOUD OF SMOKE AND THE STYLIZED LETTERS WILD WELL CONTROL INC.

FOR OIL FIELD SERVICES, NAMELY EMERGENCY FIREFIGHTING OF OIL AND GAS WELLS, STORAGE WELLS OR MARINE FIRES, BLOWOUT CONTROL OF WELL FIRES, RELIEF WELL DESIGN AND PLANNING SERVICES, AUTOMATED DELUGE SYSTEM DESIGN SERVICES, PLANNING FOR CONTINGENCY EMERGENCY WELL CONTROL RESPONSES (U.S. CLS. 100 AND 101).

FIRST USE 5-1-1992; IN COMMERCE 5-1-1992.

2,572,316. EMC VENTURES, INC., WILMINGTON, NC. SN 76-077,385. FILED P.R. 6-26-2000; AM. S.R. 3-5-2002.

GUMBO YA YA

FOR RESTAURANT SERVICES FEATURING CAJUN-STYLE ENTREES FOR BOTH ON-PREMISES AND CARRY-OUT CONSUMPTION (U.S. CLS. 100 AND 101).

FIRST USE 5-27-1999; IN COMMERCE 5-27-1999.

2,572,322. KAHN-GAUTHIER LAW GROUP, L.L.C., METAIRIE, LA. BY ASSIGNMENT KAHN LAW GROUP (A PROFESSIONAL LAW CORPORATION), METAIRIE, LA. SN 76-092,993. FILED P.R. 7-20-2000; AM. S.R. 9-28-2001.

CLASSACTIONAMERICA

FOR LEGAL SERVICES, NAMELY PROVIDING LEGAL SERVICES WHICH CATER TO MEMBERS, OR POTENTIAL MEMBERS, OF CONSUMER CLASS, OR OTHER MULTI-PLAINTIFF, ACTIONS; INFORMATION SERVICES, NAMELY PROVIDING INFORMATION BY MEANS OF A GLOBAL COMPUTER NETWORK IN THE FIELD OF LEGAL INFORMATION WHICH EATERS TO MEMBERS, OR POTENTIAL MEMBERS, OF CONSUMER CLASS, OR OTHER MULTI-PLAINTIFF, ACTIONS, NAMELY INFORMATION ON ONE OR MORE LEGAL PROCEEDINGS INVOLVING CLASS, OR OTHER MULTI-PLAINTIFF, ACTIONS (U.S. CLS. 100 AND 101).

FIRST USE 12-1-2000; IN COMMERCE 12-1-2000.

CLASS 42—(Continued).

2,572,324. GENERAL SERVICES ADMINISTRATION, WASHINGTON, DC. SN 76-100,758. FILED P.R. 7-28-2000; AM. S.R. 4-6-2001.

FEDERAL LEARNING TECHNOLOGY PROGRAM

NO CLAIM IS MADE TO THE EXCLUSIVE RIGHT TO USE "PROGRAM", APART FROM THE MARK AS SHOWN.

FOR INFORMATION TECHNOLOGY CONSULTING SERVICES FOR FEDERAL AGENCIES IN THE FIELD OF TECHNOLOGY ENHANCED LEARNING OR TRAINING (U.S. CLS. 100 AND 101).

FIRST USE 1-24-2000; IN COMMERCE 1-24-2000.

2,572,341. EDWARD LEWIS TOBINICK, M.D., A MEDICAL CORPORATION, LOS ANGELES, CA. SN 76-156,158. FILED P.R. 10-30-2000; AM. S.R. 11-1-2001.

INSTITUTE FOR NEUROLOGICAL RESEARCH

NO CLAIM IS MADE TO THE EXCLUSIVE RIGHT TO USE "INSTITUTE", APART FROM THE MARK AS SHOWN.

FOR MEDICAL TREATMENT AND RESEARCH SERVICES (U.S. CLS. 100 AND 101).

FIRST USE 10-30-2000; IN COMMERCE 10-30-2000.

2,572,343. FOCUS ON THE FAMILY, COLORADO SPRINGS, CO. SN 76-160,170. FILED P.R. 11-6-2000; AM. S.R. 1-18-2002.

FAMILY.ORG

FOR PROVIDING A WEBSITE ON THE INTERNET FEATURING INFORMATION IN THE FIELDS OF MARRIAGE, RELIGION AND CHILD REARING FROM A CHRISTIAN POINT OF VIEW (U.S. CLS. 100 AND 101).

FIRST USE 1-29-2000; IN COMMERCE 1-29-2000.

2,572,350. EYERIS, INC., DENVER, CO. SN 76-174,389. FILED 12-1-2000.

PROFIT-DRIVEN CRM

NO CLAIM IS MADE TO THE EXCLUSIVE RIGHT TO USE "CRM", APART FROM THE MARK AS SHOWN.

FOR APPLICATION SERVICE PROVIDER FEATURING SOFTWARE IN THE FIELD OF PROFITABILITY ANALYSIS FOR USE IN HIGHLIGHTING PROFITABILITY ACROSS TIME BY INDIVIDUAL AND AGGREGATE CUSTOMER, MARKET SEGMENT, PRODUCT AND GEOGRAPHY (U.S. CLS. 100 AND 101).

FIRST USE 10-17-2000; IN COMMERCE 11-23-2000.

CLASS 42—(Continued).

2,572,351. GENUS, INC., WILMINGTON, DE. SN 76-176,149. FILED P.R. 12-5-2000; AM. S.R. 10-1-2001.

REPRODUCTIVE MANAGEMENT SYSTEM

NO CLAIM IS MADE TO THE EXCLUSIVE RIGHT TO USE "SYSTEM", APART FROM THE MARK AS SHOWN.

FOR CONSULTATION IN THE FIELD OF REPRODUCTIVE MANAGEMENT FOR COWS, NAMELY, RECOMMENDING CERTAIN PRODUCTS INCLUDING, FOR EXAMPLE, HEAT DETECTION, TAIL CHALKING AND TAIL CHALK READING DEVICES BASED ON THE GENETIC MAKEUP OF A DAIRY COW; EVALUATION OF HERD MANAGEMENT DEVICES BASED ON THE GENETIC MAKEUP OF A DAIRY COW; EVALUATION OF HERD MANAGEMENT RECORDS IN ORDER TO PROVIDE CERTAIN REPRODUCTIVE SOLUTIONS TO REPRODUCTIVE PROBLEMS (U.S. CLS. 100 AND 101).
FIRST USE 1-10-2000; IN COMMERCE 1-10-2000.

2,572,362. UNIPURE CORPORATION, HOUSTON, TX. SN 76-197,408. FILED P.R. 1-22-2001; AM. S.R. 1-22-2002.

PureEnergy Strategy

FOR TECHNICAL CONSULTATION IN THE FIELD OF PETROLEUM REFINING USING A GROUP OF PROPRIETARY PROCESS TECHNOLOGIES WHICH CLEAN, DEHYDRATE, DESULFURIZE, AND UPGRADE CHALLENGING CRUDE OILS AND POLISH REFINED PRODUCTS DOWN TO ULTRA-LOW LEVELS OF SULFUR (U.S. CLS. 100 AND 101).
FIRST USE 8-0-2000; IN COMMERCE 8-0-2000.

2,572,377. BRUDER, BARRY, SANTA MONICA, CA. SN 76-222,552. FILED P.R. 3-12-2001; AM. S.R. 8-7-2001.

BODYWURX

FOR MASSAGE SERVICES, AND PSYCHOLOGICAL COUNSELING, NAMELY, EMOTIONAL THERAPY (U.S. CLS. 100 AND 101).
FIRST USE 7-0-1989; IN COMMERCE 7-0-1989.

CLASS 42—(Continued).

2,572,381. PRIMARY PROVIDER MANAGEMENT COMPANY, INC., SAN DIEGO, CA. SN 76-230,823. FILED P.R. 3-26-2001; AM. S.R. 12-11-2001.

PRIMARY PROVIDER MANAGEMENT COMPANY, INC.

FOR MANAGED HEALTH CARE SERVICES, NAMELY, CONTRACTING PHYSICIAN NETWORKS, MANAGEMENT OF SPECIALIST CARE OUTSIDE OF HOSPITAL ENVIRONMENT, CLAIMS PROCESSING AND INFORMATION AND REPORTING SERVICES (U.S. CLS. 100 AND 101).

FIRST USE 7-22-1983; IN COMMERCE 7-22-1983.

2,572,384. PATHOLOGY SERVICES P.A., TOPEKA, KS. SN 76-234,888. FILED P.R. 4-3-2001; AM. S.R. 12-21-2001.

DERMATOPATHOLOGY DIAGNOSTICS

NO CLAIM IS MADE TO THE EXCLUSIVE RIGHT TO USE "DERMATOPATHOLOGY", APART FROM THE MARK AS SHOWN.

FOR MEDICAL SERVICES, NAMELY PATHOLOGY DERMATOLOGY (U.S. CLS. 100 AND 101).
FIRST USE 3-29-2001; IN COMMERCE 3-29-2001.

2,572,392. CELEBRATION PAVILIONS, L.L.C., DAVIE, FL. SN 76-266,122. FILED P.R. 6-4-2001; AM. S.R. 11-6-2001.

CELEBRATION PAVILIONS

FOR OPERATING CATERING FACILITIES WITH SERVICES FOR WEDDINGS, BANQUETS AND PARTIES (U.S. CLS. 100 AND 101).

FIRST USE 6-1-2000; IN COMMERCE 1-21-2001.

CLASS 42—(Continued).

2,572,395. SKIN CARE CENTER OF THE AMERICAS, INC., THE, FT. LAUDERDALE, FL. SN 76-275,736. FILED P.R. 6-25-2001; AM. S.R. 2-7-2002.

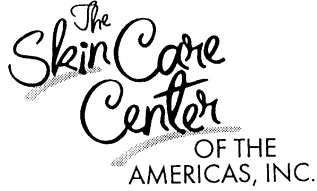

NO CLAIM IS MADE TO THE EXCLUSIVE RIGHT TO USE "THE SKIN CARE CENTER" AND "INC.", APART FROM THE MARK AS SHOWN.

THE STIPPLING IS A FEATURE OF THE MARK.
FOR SKIN CARE SERVICES, NAMELY, FACIAL TREATMENTS, MAKEOVERS, MESSAGES, ELECTROLYSIS, MICRODERMABRASION, WAXING, AND MICROPIGMENTATION (U.S. CLS. 100 AND 101).
FIRST USE 5-12-2000; IN COMMERCE 5-12-2000.

CLASS 42—(Continued).

2,572,417. PULS, FRED, M., BROOMFIELD, CO. SN 78-059,808. FILED P.R. 4-23-2001; AM. S.R. 8-6-2001.

BRINGMEINFO

FOR COMPUTER SERVICES, NAMELY, PROVIDING SEARCH ENGINES FOR OBTAINING DATA ON A GLOBAL COMPUTER NETWORK (U.S. CLS. 100 AND 101).

FIRST USE 3-5-2001; IN COMMERCE 4-2-2001.



2,572,420. HUO, WILLIAM, NEW YORK, NY. SN 78-080,889. FILED P.R. 8-23-2001; AM. S.R. 2-13-2002.

PAC RIM

FOR PROVISION OF FOOD AND DRINK, NAMELY RESTAURANT SERVICES (U.S. CLS. 100 AND 101).
FIRST USE 1-1-2001; IN COMMERCE 1-1-2001.

* * * * *

PRIOR UNITED STATES CLASSIFICATION

APPLICATION IN ONE CLASS

COLLECTIVE MEMBERSHIP MARKS

CLASS 200—COLLECTIVE MEMBERSHIP

2,572,305. TRADITIONAL COWBOY ARTS ASSOCIATION,
SALMON, ID. SN 76-031,889. FILED P.R. 4-21-2000; AM.
S.R. 4-23-2001.

**TRADITIONAL COWBOY
ARTS ASSOCIATION**

NO CLAIM IS MADE TO THE EXCLUSIVE RIGHT TO
USE "ARTS ASSOCIATION", APART FROM THE MARK AS
SHOWN.

FOR INDICATING MEMBERSHIP IN AN ORGANIZA-
TION WHICH IS AN ASSOCIATION OF INDIVIDUALS
WHO MAKE SADDLES, SADDLERY, BITS, BRIDLES,
HORSE HALTERS, WHIPS, REINS, RAWHIDE BRAIDED
ROPES, SPURS, AND ORNAMENTAL BELT BUCKLES
FOR CLOTHING, HAT ORNAMENTS, BOLO TIES, TIE
FASTENERS, SADDLE AND CHAPS DECORATION ALL
MADE IN SILVER (U.S. CL. 200).

FIRST USE 8-20-1998; IN COMMERCE 8-20-1998.

* * * * *

TRADEMARK REGISTRATIONS RENEWED

The designation "U.S. Cl." appearing in this section refers to the U.S. class in effect prior to Sep. 1, 1973 rather than the international class which applies to applications filed on or after that date. For adoption of international classification see notice in the OFFICIAL GAZETTE of Jun. 26, 1973 (911 O.G. TM 210).

| | | | |
|----------|--|----------|---|
| 148,174. | NCR. U.S. CL. 38. (INT. CL. 16). REG. 11-8-1921. | 719,205. | RHINO HIDE AND DESIGN. U.S. CL. 21. (INT. CL. 9). REG. 8-1-1961. |
| 154,687. | ESS-KAY (STYLIZED). U.S. CL. 46. (INT. CL. 29). REG. 4-18-1922. | 722,413. | MOUNTAIN RESCUE AND DESIGN. U.S. CL. 200. REG. 10-3-1961. |
| 277,569. | TRICOL. U.S. CL. 46. (INT. CL. 30). REG. 11-18-1930. | 722,480. | TERRA-GREEN. U.S. CL. 10. (INT. CL. 1). REG. 10-10-1961. |
| 287,746. | PEGASUS AND DESIGN. U.S. CL. 15. (INT. CL. 4). REG. 10-6-1931. | 724,128. | MULTIPRIME (STYLIZED). U.S. CL. 16. (INT. CL. 2). REG. 11-21-1961. |
| 289,329. | BUNDYWELD. U.S. CL. 13. (INT. CL. 6). REG. 11-24-1931. | 724,823. | PEABODY. U.S. CL. 34. (INT. CLS. 7 AND 11). REG. 12-5-1961. |
| 291,254. | PLASKON (STYLIZED). INT. CL. 1. (U.S. CL. 1). REG. 2-2-1932. | 725,020. | Q. U.S. CL. 21. (INT. CL. 9). REG. 12-12-1961. |
| 291,502. | SPUR. U.S. CL. 15. (INT. CL. 4). REG. 2-9-1932. | 725,429. | SUNNY CUP (STYLIZED). U.S. CL. 46. (INT. CL. 30). REG. 12-19-1961. |
| 291,625. | MISCELLANEOUS DESIGN. U.S. CL. 42. (INT. CL. 24). REG. 2-23-1932. | 725,575. | RS AND DESIGN. U.S. CL. 21. (INT. CL. 9). REG. 12-26-1961. |
| 291,639. | MISCELLANEOUS DESIGN. U.S. CL. 42. (INT. CL. 24). REG. 2-23-1932. | 725,814. | MACHINE-KUT (STYLIZED). U.S. CL. 15. (INT. CL. 4). REG. 1-2-1962. |
| 292,693. | GREENLUBE. U.S. CL. 15. (INT. CL. 4). REG. 3-22-1932. | 725,904. | LEWIS. U.S. CL. 23. (INT. CL. 7). REG. 1-2-1962. |
| 387,956. | MISCELLANEOUS DESIGN. U.S. CL. 28. (INT. CL. 14). REG. 6-10-1941. | 726,490. | OMICHRON. U.S. CL. 27. (INT. CL. 14). REG. 1-16-1962. |
| 392,624. | BARALYME. U.S. CL. 6. (INT. CL. 1). REG. 1-6-1942. | 726,593. | JOHNSON'S. U.S. CL. 52. (INT. CL. 3). REG. 1-16-1962. |
| 395,731. | FORD (STYLIZED). U.S. CL. 21. (INT. CL. 9). REG. 6-9-1942. | 727,200. | SCALEXTRIC. U.S. CL. 22. (INT. CL. 28). REG. 2-6-1962. |
| 396,008. | JUNIOR SCHOLASTIC (STYLIZED). U.S. CL. 38. (INT. CL. 16). REG. 6-23-1942. | 727,367. | AMWAY. U.S. CL. 6. (INT. CL. 3). REG. 2-13-1962. |
| 444,613. | NATIONAL (STYLIZED). U.S. CL. 35. (INT. CL. 17). REG. 12-4-1951. | 727,456. | W AND DESIGN. U.S. CL. 23. (INT. CL. 7). REG. 2-13-1962. |
| 540,398. | COCO RICO (STYLIZED). U.S. CL. 45. (INT. CL. 32). REG. 4-3-1951. | 727,518. | COLUMN WRITE. U.S. CL. 37. (INT. CL. 16). REG. 2-13-1962. |
| 543,580. | ALATHON (STYLIZED). U.S. CL. 6. (INT. CL. 1). REG. 6-12-1951. | 727,538. | COMFY. U.S. CL. 39. (INT. CL. 25). REG. 2-13-1962. |
| 547,415. | WIENIE-PAK (STYLIZED). U.S. CL. 2. (INT. CL. 18). REG. 9-4-1951. | 728,121. | LARK. U.S. CL. 3. (INT. CL. 18). REG. 3-6-1962. |
| 549,044. | NATIONAL (STYLIZED). U.S. CL. 12. (INT. CL. 17). REG. 10-2-1951. | 728,191. | RUBRAMIN PC (STYLIZED). U.S. CL. 18. (INT. CL. 5). REG. 3-6-1962. |
| 552,283. | MAXITROL. U.S. CL. 13. (INT. CL. 6). REG. 12-18-1951. | 729,253. | CHILI-ETS. U.S. CL. 46. (INT. CL. 29). REG. 3-27-1962. |
| 552,481. | GENERAL FAVORITE (STYLIZED). U.S. CL. 46. (INT. CL. 30). REG. 12-25-1951. | 729,324. | TRIS AMINO (STYLIZED). U.S. CL. 6. (INT. CL. 1). REG. 4-3-1962. |
| 554,721. | VITEX. U.S. CL. 18. (INT. CL. 5). REG. 2-12-1952. | 729,883. | BLU-KROME. U.S. CL. 13. (INT. CL. 6). REG. 4-10-1962. |
| 554,723. | KEYSTONE (STYLIZED). U.S. CL. 34. (INT. CL. 7). REG. 2-12-1952. | 732,278. | WHEREVER ELECTRICITY IS DISTRIBUTED AND CONTROLLED AND DESIGN. U.S. CL. 21. (INT. CL. 9). REG. 5-29-1962. |
| 555,093. | PROTO (STYLIZED). U.S. CL. 26. (INT. CL. 9). REG. 2-19-1952. | 732,618. | FRAGRANT ZONE. U.S. CL. 6. (INT. CL. 5). REG. 6-12-1962. |
| 555,116. | 48. U.S. CL. 22. (INT. CL. 16). REG. 2-19-1952. | 733,601. | TRANSORB. INT. CL. 1. (U.S. CL. 1). REG. 7-3-1962. |
| 559,239. | SUPERCake (STYLIZED). U.S. CL. 46. (INT. CL. 30). REG. 5-27-1952. | 734,286. | TOLL HOUSE. U.S. CL. 46. (INT. CL. 30). REG. 7-10-1962. |
| 561,160. | SOLDER SEAL AND DESIGN. U.S. CL. 52. (INT. CL. 3). REG. 7-8-1952. | 734,878. | BLACKMER. U.S. CL. 23. (INT. CL. 7). REG. 7-24-1962. |
| 561,559. | TROUBLE SAVER. U.S. CL. 50. (INT. CL. 6). REG. 7-15-1952. | 738,733. | BAG BALM. U.S. CL. 44. (INT. CL. 10). REG. 10-2-1962. |
| 564,885. | CRACKER JACK. U.S. CL. 46. (INT. CL. 30). REG. 10-7-1952. | 739,702. | PROMACUT (STYLIZED). U.S. CL. 23. (INT. CL. 7). REG. 10-23-1962. |
| 697,095. | MC MCCARTER AND DESIGN. U.S. CL. 23. (INT. CLS. 6, 7, 8, 9, 11, 12, 16, 21 AND 28). REG. 5-3-1960. | 888,836. | NDC. U.S. CL. 101. (INT. CLS. 35, 36, 38, 41 AND 42). REG. 3-31-1970. |
| 701,087. | TOWN & COUNTRY. U.S. CL. 46. (INT. CL. 29). REG. 7-12-1960. | 890,586. | ZEST. U.S. CL. 46. (INT. CL. 29). REG. 5-5-1970. |
| 716,041. | MYOFLEX. U.S. CL. 18. (INT. CL. 5). REG. 5-30-1961. | 918,077. | AMERICAN HERITAGE PRESS. U.S. CL. 38. (INT. CL. 16). REG. 8-10-1971. |
| 717,677. | D-C Q QUALITY (STYLIZED). U.S. CL. 52. (INT. CL. 3). REG. 6-27-1961. | 918,079. | ABC WIDE WORLD OF SPORTS AND DESIGN. U.S. CL. 107 ONLY. (INT. CL. 41). REG. 8-10-1971. |
| 717,737. | CAMERON (STYLIZED). U.S. CL. 13. (INT. CLS. 6 AND 9). REG. 7-4-1961. | 918,242. | JOYCE BERTRAM. U.S. CL. 101. (INT. CL. 35). REG. 8-10-1971. |
| 717,823. | AMP (STYLIZED). U.S. CL. 21. (INT. CL. 9). REG. 7-4-1961. | 918,409. | AIRBARGE. U.S. CL. 19. (INT. CL. 7). REG. 8-17-1971. |
| 717,840. | CAMERON (STYLIZED). U.S. CL. 23. (INT. CL. 7). REG. 7-4-1961. | 922,525. | WOOLITE. U.S. CL. 52. (INT. CL. 3). REG. 10-19-1971. |

- 924,571. MOD-U-FORM. U.S. CL. 12. (INT. CL. 19). REG. 11-30-1971.
- 925,513. MONTE CRISTO. U.S. CL. 28. (INT. CL. 8). REG. 12-14-1971.
- 927,322. PLICORD. U.S. CL. 35. (INT. CL. 17). REG. 1-18-1972.
- 927,332. MISCELLANEOUS DESIGN. U.S. CL. 37. (INT. CL. 16). REG. 1-18-1972.
- 927,610. DYNACHEM. U.S. CL. 6. (INT. CLS. 1 AND 2). REG. 1-25-1972.
- 928,967. TRI N 32. U.S. CL. 10. (INT. CL. 1). REG. 2-15-1972.
- 929,017. UREX. U.S. CL. 18. (INT. CL. 5). REG. 2-15-1972.
- 929,208. AMERICAL. U.S. CL. 39. (INT. CL. 25). REG. 2-15-1972.
- 929,258. CABLE CAR. U.S. CL. 46. (INT. CLS. 29, 30 AND 31). REG. 2-15-1972.
- 929,544. SULFREEN. U.S. CL. 26. (INT. CL. 9). REG. 2-22-1972.
- 929,877. TOGGLE ACTION. U.S. CL. 13. (INT. CL. 6). REG. 2-29-1972.
- 930,101. ROQUITAL THE SIGN OF THE DOVE SALAD DRESSING AND DESIGN. U.S. CL. 46. (INT. CL. 29). REG. 2-29-1972.
- 930,451. JUMBERCA. U.S. CL. 23. (INT. CL. 7). REG. 3-7-1972.
- 931,054. JIFFY. U.S. CL. 2. (INT. CL. 31). REG. 3-21-1972.
- 933,731. BARDAC. U.S. CL. 6. (INT. CL. 5). REG. 5-16-1972.
- 934,484. SAIL. U.S. CL. 38. (INT. CL. 16). REG. 5-23-1972.
- 935,518. TROGAMID. INT. CL. 1. (U.S. CL. 1). REG. 6-13-1972.
- 935,590. PROJECTS UNLIMITED AND DESIGN. U.S. CLS. 21 AND 26. (INT. CL. 9). REG. 6-13-1972.
- 935,850. BIAGI (STYLIZED). U.S. CL. 3. (INT. CL. 18). REG. 6-20-1972.
- 936,015. HE&M. U.S. CL. 23. (INT. CL. 7). REG. 6-20-1972.
- 936,381. KALENE. U.S. CL. 6. (INT. CL. 1). REG. 6-27-1972.
- 936,444. UNI-FORM SHELL. U.S. CL. 13. (INT. CL. 11). REG. 6-27-1972.
- 936,897. STA-FORM 60. U.S. CL. 6. (INT. CL. 1). REG. 7-4-1972.
- 937,259. FORDWAY. U.S. CL. 101. (INT. CL. 35). REG. 7-4-1972.
- 938,422. MISCELLANEOUS DESIGN. U.S. CL. 6. (INT. CL. 1). REG. 7-25-1972.
- 938,510. MARLBOROFILTER CIGARETTES AND DESIGN. U.S. CL. 17. (INT. CL. 34). REG. 7-25-1972.
- 939,291. MISCELLANEOUS DESIGN. U.S. CL. 1. (INT. CL. 17). REG. 8-1-1972.
- 939,673. S AND DESIGN. U.S. CL. 22. (INT. CL. 16). REG. 8-1-1972.
- 940,193. SIFCO. U.S. CL. 106. (INT. CL. 40). REG. 8-1-1972.
- 941,200. NUXTRA. U.S. CL. 6. (INT. CL. 1). REG. 8-22-1972.
- 941,244. MAKE TIGHT STAY AND DESIGN. U.S. CL. 13. (INT. CL. 6). REG. 8-22-1972.
- 942,174. LAMART. U.S. CL. 1. (INT. CL. 17). REG. 9-5-1972.
- 942,612. AQUASOL E. U.S. CL. 18. (INT. CL. 5). REG. 9-12-1972.
- 942,613. AQUASOL A. U.S. CL. 18. (INT. CL. 5). REG. 9-12-1972.
- 943,057. MISCELLANEOUS DESIGN. U.S. CL. 1. (INT. CL. 17). REG. 9-19-1972.
- 943,511. DYNASYLAN. U.S. CL. 6. (INT. CL. 1). REG. 9-26-1972.
- 946,150. PRESS AGENT. U.S. CL. 6. (INT. CL. 3). REG. 10-31-1972.
- 948,360. DOLLAR. U.S. CL. 100. (INT. CL. 39). REG. 12-5-1972.
- 949,859. METAPRO. U.S. CL. 39. (INT. CL. 9). REG. 1-2-1973.
- 1,152,043. SAYTEX. INT. CL. 1. (U.S. CL. 6). REG. 4-28-1981.
- 1,157,938. KERNEL KING AND DESIGN. INT. CLS. 11, 16, 29, 30 AND 31. (U.S. CLS. 2, 34 AND 46). REG. 6-23-1981.
- 1,159,346. FRUNAS. INT. CL. 30. (U.S. CL. 46). REG. 6-30-1981.
- 1,163,425. ENCO. INT. CLS. 7, 8 AND 9. (U.S. CLS. 23 AND 26). REG. 8-4-1981.
- 1,165,711. HAWAIIAN SUN (STYLIZED). INT. CLS. 29, 30 AND 32. (U.S. CL. 46). REG. 8-18-1981.
- 1,166,160. KC250. INT. CL. 7. (U.S. CL. 23). REG. 8-25-1981.
- 1,166,233. COULOSCOPE. INT. CL. 9. (U.S. CL. 26). REG. 8-25-1981.
- 1,166,480. ROLL/STOR. INT. CLS. 16 AND 20. (U.S. CLS. 2 AND 32). REG. 8-25-1981.
- 1,168,067. K060. INT. CL. 7. (U.S. CL. 23). REG. 9-8-1981.
- 1,170,711. F AND DESIGN. INT. CL. 42. (U.S. CL. 101). REG. 9-22-1981.
- 1,170,959. TAB. INT. CLS. 16 AND 20 ONLY. (U.S. CLS. 32 AND 37). REG. 9-29-1981.
- 1,172,530. SUTLIFF PRIVATE STOCK. INT. CL. 34. (U.S. CL. 17). REG. 10-6-1981.
- 1,174,140. ADVERTISING SPECIALTY REGISTER. INT. CL. 16 ONLY. (U.S. CL. 38). REG. 10-20-1981.
- 1,175,212. ROBYN PRODUCTS AND DESIGN. INT. CL. 20. (U.S. CL. 50). REG. 10-27-1981.
- 1,176,016. LIFE-LITE. INT. CL. 11. (U.S. CL. 21). REG. 11-3-1981.
- 1,177,292. BODY THERAPEUTICS. INT. CL. 20. (U.S. CL. 32). REG. 11-10-1981.
- 1,178,554. FANTASTIC FOUR. INT. CL. 41. (U.S. CL. 107). REG. 11-17-1981.
- 1,181,962. PZM. INT. CL. 9. (U.S. CL. 21). REG. 12-15-1981.
- 1,182,940. RAUMEDIC. INT. CL. 17. (U.S. CL. 1). REG. 12-22-1981.
- 1,183,052. BEAVER BRAND HATS AND DESIGN. INT. CL. 25. (U.S. CL. 39). REG. 12-22-1981.
- 1,183,215. T AND DESIGN. INT. CL. 36. (U.S. CL. 102). REG. 12-22-1981.
- 1,183,365. MAYCO AND DESIGN. INT. CL. 1. (U.S. CL. 6). REG. 12-29-1981.
- 1,184,297. SAKAPHEN AND DESIGN. INT. CLS. 1, 2 AND 17. (U.S. CLS. 1, 6 AND 16). REG. 1-5-1982.
- 1,184,354. PRE-TESTED (STYLIZED). INT. CL. 2. (U.S. CL. 16). REG. 1-5-1982.
- 1,187,732. HYDROFLEX. INT. CL. 24. (U.S. CL. 42). REG. 1-26-1982.
- 1,187,777. VITALIANO AND DESIGN. INT. CL. 25. (U.S. CL. 39). REG. 1-26-1982.
- 1,188,275. RICOH. INT. CLS. 1, 2 AND 3. (U.S. CLS. 1, 4, 6, 11, 50, 51 AND 52). REG. 2-2-1982.
- 1,188,998. SOUND SECURITY. INT. CL. 42. (U.S. CL. 100). REG. 2-2-1982.
- 1,189,013. CINNAMON SAM AND DESIGN. INT. CL. 42. (U.S. CL. 101). REG. 2-2-1982.
- 1,189,035. KURARAY POVAL. INT. CLS. 1 AND 17. (U.S. CLS. 1, 5 AND 6). REG. 2-9-1982.
- 1,189,052. CARBITAL. INT. CL. 2. (U.S. CL. 6). REG. 2-9-1982.
- 1,189,087. PNEUMOSUIS. INT. CL. 5. (U.S. CL. 18). REG. 2-9-1982.
- 1,189,113. MISCELLANEOUS DESIGN. INT. CL. 6. (U.S. CL. 14). REG. 2-9-1982.
- 1,189,121. ITT (STYLIZED). INT. CLS. 7 AND 9 ONLY. (U.S. CLS. 21, 23 AND 26). REG. 2-9-1982.
- 1,189,182. MOTRONIC. INT. CL. 9. (U.S. CLS. 21 AND 26). REG. 2-9-1982.
- 1,189,301. STYRO-STUD. INT. CL. 17. (U.S. CL. 12). REG. 2-9-1982.
- 1,189,347. SEALY AND DESIGN. INT. CL. 20. (U.S. CL. 32). REG. 2-9-1982.
- 1,189,450. BUDDY L (STYLIZED). INT. CL. 28. (U.S. CL. 22). REG. 2-9-1982.
- 1,189,525. VALU TIME. INT. CL. 34. (U.S. CL. 17). REG. 2-9-1982.
- 1,189,612. GGI (STYLIZED). INT. CL. 42. (U.S. CL. 100). REG. 2-9-1982.
- 1,189,773. USTER. INT. CL. 7. (U.S. CL. 23). REG. 2-16-1982.
- 1,189,785. BADGER. INT. CL. 7. (U.S. CL. 23). REG. 2-16-1982.
- 1,189,825. MICROFUGE. INT. CL. 9. (U.S. CLS. 21 AND 26). REG. 2-16-1982.
- 1,189,897. RONDAIR. INT. CL. 11. (U.S. CLS. 31 AND 34). REG. 2-16-1982.
- 1,189,918. AWARD COLLECTION. INT. CL. 11. (U.S. CL. 13). REG. 2-16-1982.
- 1,189,943. ROADHANDLER. INT. CL. 12. (U.S. CL. 35). REG. 2-16-1982.
- 1,190,000. SOUTHERN PIKNIK AND DESIGN. INT. CL. 20. (U.S. CL. 32). REG. 2-16-1982.
- 1,190,045. NINA AND DESIGN. INT. CL. 25. (U.S. CL. 39). REG. 2-16-1982.
- 1,190,080. NO BODY'S PERFECT. INT. CL. 25. (U.S. CL. 39). REG. 2-16-1982.
- 1,190,123. GUN-SMOKE. INT. CL. 28. (U.S. CL. 22). REG. 2-16-1982.
- 1,190,182. VITA BONE. INT. CL. 31. (U.S. CL. 46). REG. 2-16-1982.

- 1,190,219. PAYROLL PLUS. INT. CL. 36. (U.S. CLS. 101 AND 102). REG. 2-16-1982.
- 1,190,244. OLD CHICAGO. INT. CL. 42 ONLY. (U.S. CL. 100). REG. 2-16-1982.
- 1,190,330. OLD FASHIONED CHICKEN FRIED STEAK SUPREME. INT. CL. 42. (U.S. CL. 100). REG. 2-16-1982.
- 1,190,507. ARCWATER. INT. CL. 9. (U.S. CLS. 13, 34 AND 35). REG. 2-23-1982.
- 1,190,654. UHU STIC (STYLIZED). INT. CL. 16. (U.S. CL. 5). REG. 2-23-1982.
- 1,190,758. DURALACE. INT. CL. 24. (U.S. CL. 42). REG. 2-23-1982.
- 1,190,928. NEI-NORTHWEST EQUITY INVESTMENTS (STYLIZED). INT. CL. 36. (U.S. CL. 102). REG. 2-23-1982.
- 1,190,934. AMERICAN INTERNATIONAL. INT. CL. 36. (U.S. CL. 102). REG. 2-23-1982.
- 1,191,223. SEVEN STAR. INT. CL. 25. (U.S. CL. 39). REG. 3-2-1982.
- 1,191,258. XAVIER ROBERTS (STYLIZED). INT. CL. 28. (U.S. CL. 22). REG. 3-2-1982.
- 1,191,376. JJW AND DESIGN. INT. CL. 41. (U.S. CL. 107). REG. 3-2-1982.
- 1,191,412. CINNAMON SAM. INT. CL. 42. (U.S. CL. 101). REG. 3-2-1982.
- 1,191,961. NEW YORK! NEW YORK!!! (STYLIZED). INT. CL. 3. (U.S. CL. 51). REG. 3-16-1982.
- 1,192,225. SNOQUALMIE FALLS LODGE. INT. CL. 30 ONLY. (U.S. CL. 46). REG. 3-16-1982.
- 1,192,242. FIRST COLONY. INT. CL. 30. (U.S. CL. 46). REG. 3-16-1982.
- 1,193,440. LITTLE PERSON. INT. CL. 28. (U.S. CL. 22). REG. 4-6-1982.
- 1,193,722. ULYSSES. INT. CL. 31. (U.S. CL. 46). REG. 4-13-1982.
- 1,195,416. CARDIOPET. INT. CL. 42. (U.S. CL. 100). REG. 5-11-1982.
- 1,195,611. M LASTIC. INT. CL. 10. (U.S. CL. 44). REG. 5-18-1982.
- 1,196,384. PETER RABBIT AND DESIGN. INT. CL. 31. (U.S. CL. 46). REG. 5-25-1982.
- 1,197,273. RECORD MASTER. INT. CL. 20. (U.S. CL. 32). REG. 6-8-1982.
- 1,198,928. SALVER. INT. CL. 28. (U.S. CL. 22). REG. 6-22-1982.
- 1,199,401. TELSAR. INT. CL. 9. (U.S. CL. 21). REG. 6-29-1982.
- 1,200,043. FRUIT BITS. INT. CL. 29. (U.S. CL. 46). REG. 6-29-1982.
- 1,200,098. SONG SHU PAI PINE BRAND AND DESIGN. INT. CL. 5. (U.S. CL. 18). REG. 7-6-1982.
- 1,200,619. PREMIAT. INT. CL. 33. (U.S. CL. 47). REG. 7-6-1982.
- 1,201,041. THE PRESERVATION PRESS. INT. CL. 16. (U.S. CLS. 37 AND 38). REG. 7-13-1982.
- 1,201,116. VEKA AND DESIGN. INT. CL. 19. (U.S. CL. 12). REG. 7-13-1982.
- 1,201,202. SENTI-SPORT. INT. CL. 25. (U.S. CL. 39). REG. 7-13-1982.
- 1,201,283. IVANKO. INT. CL. 28. (U.S. CL. 22). REG. 7-13-1982.
- 1,202,195. SEA SHELLS (STYLIZED). INT. CL. 29. (U.S. CL. 46). REG. 7-20-1982.
- 1,202,278. ORANGE WHIP (STYLIZED). INT. CLS. 35 AND 42. (U.S. CLS. 100 AND 101). REG. 7-20-1982.
- 1,203,117. OLD BALDY CLUB AND DESIGN. INT. CL. 41. (U.S. CL. 107). REG. 7-27-1982.
- 1,203,368. CATLOW. INT. CL. 6. (U.S. CL. 13). REG. 8-3-1982.
- 1,204,524. 3M (STYLIZED). INT. CL. 16. (U.S. CL. 37). REG. 8-10-1982.
- 1,205,651. MISCELLANEOUS DESIGN. INT. CL. 33. (U.S. CL. 47). REG. 8-17-1982.
- 1,206,020. HYDROTECTOR. INT. CL. 9. (U.S. CL. 26). REG. 8-24-1982.
- 1,207,533. THE CLOSET STRETCHERS. INT. CL. 37. (U.S. CL. 103). REG. 9-7-1982.
- 1,208,740. HONEE-WEENEE. INT. CL. 29. (U.S. CL. 46). REG. 9-14-1982.
- 1,210,789. MISCELLANEOUS DESIGN. INT. CL. 29. (U.S. CL. 46). REG. 9-28-1982.
- 1,212,263. IRON AGE AND DESIGN. INT. CL. 9. (U.S. CL. 39). REG. 10-12-1982.
- 1,213,896. MISCELLANEOUS DESIGN. INT. CL. 16. (U.S. CLS. 37 AND 38). REG. 10-26-1982.
- 1,214,461. GENTLE DENTAL. INT. CL. 42. (U.S. CL. 100). REG. 10-26-1982.
- 1,215,657. FRAGMATOME. INT. CL. 10. (U.S. CL. 44). REG. 11-9-1982.
- 1,217,753. TOP-MATE. INT. CL. 30. (U.S. CL. 46). REG. 11-23-1982.
- 1,219,342. EMPEROR NORTON. INT. CL. 30. (U.S. CL. 46). REG. 12-7-1982.
- 1,220,073. AMERICAN BELT COMPANY AND DESIGN. INT. CL. 25. (U.S. CL. 39). REG. 12-14-1982.
- 1,220,211. EMPEROR NORTON 1853 ORIGINAL AND DESIGN. INT. CL. 30. (U.S. CL. 46). REG. 12-14-1982.
- 1,220,478. POLAR AND DESIGN. INT. CL. 1. (U.S. CL. 1). REG. 12-21-1982.
- 1,220,518. RADENT. INT. CL. 5. (U.S. CL. 44). REG. 12-21-1982.
- 1,224,197. THE STATE OF BLACK AMERICA. INT. CL. 16. (U.S. CL. 38). REG. 1-18-1983.
- 1,575,911. CODE. INT. CLS. 3 AND 5. (U.S. CLS. 4, 6, 18 AND 52). REG. 1-9-1990.
- 1,578,640. TOP GUN. INT. CL. 7. (U.S. CL. 23). REG. 1-23-1990.
- 1,584,561. VK (STYLIZED). INT. CL. 14. (U.S. CLS. 2, 27, 28 AND 50). REG. 2-27-1990.
- 1,584,562. VK. INT. CL. 14. (U.S. CLS. 2, 27, 28 AND 50). REG. 2-27-1990.
- 1,597,386. VIRGIN. INT. CLS. 16 AND 25. (U.S. CLS. 2, 5, 22, 23, 29, 37, 38, 39 AND 50). REG. 5-22-1990.
- 1,598,672. VELTRA. INT. CL. 24. (U.S. CL. 42). REG. 5-29-1990.
- 1,600,065. EARTHBEAT! AND DESIGN. INT. CL. 42. (U.S. CLS. 100 AND 101). REG. 6-5-1990.
- 1,601,473. WALKERCISE (STYLIZED). INT. CL. 41. (U.S. CL. 107). REG. 6-12-1990.
- 1,605,633. POLARTUFF. INT. CL. 24. (U.S. CL. 42). REG. 7-10-1990.
- 1,605,809. TEDDY BAR. INT. CL. 30. (U.S. CL. 46). REG. 7-10-1990.
- 1,614,506. SHOO!. INT. CL. 1. (U.S. CL. 6). REG. 9-25-1990.
- 1,620,914. SK TECHNOLOGIES AND DESIGN. INT. CL. 9. (U.S. CL. 38). REG. 11-6-1990.
- 1,624,185. BERTUCCI'S BRICK OVEN PIZZERIA. INT. CL. 42. (U.S. CLS. 100 AND 101). REG. 11-20-1990.
- 1,626,144. MISCELLANEOUS DESIGN. INT. CL. 29. (U.S. CL. 46). REG. 12-4-1990.
- 1,627,653. DIANAMIC AND DESIGN. INT. CL. 40. (U.S. CL. 106). REG. 12-11-1990.
- 1,628,792. MIC (STYLIZED). INT. CL. 9. (U.S. CL. 26). REG. 12-18-1990.
- 1,636,827. MISCELLANEOUS DESIGN. INT. CL. 12. (U.S. CL. 19). REG. 3-5-1991.
- 1,643,834. STAR SYSTEM. INT. CL. 35. (U.S. CL. 101). REG. 5-7-1991.
- 1,645,161. CELLINO. INT. CL. 14. (U.S. CL. 28). REG. 5-21-1991.
- 1,650,523. E-PREP. INT. CL. 3. (U.S. CL. 52). REG. 7-16-1991.
- 1,653,104. ADDCO. INT. CL. 20. (U.S. CL. 32). REG. 8-6-1991.
- 1,653,129. GARDEN MASTER. INT. CL. 25. (U.S. CL. 39). REG. 8-6-1991.
- 1,653,645. PERSONAL FINANCE AND DESIGN. INT. CL. 16. (U.S. CL. 38). REG. 8-13-1991.
- 1,653,891. PAYMENT CONNECTION. INT. CL. 36. (U.S. CL. 102). REG. 8-13-1991.
- 1,654,086. BEECH AND DESIGN. INT. CL. 10. (U.S. CLS. 26, 39 AND 44). REG. 8-13-1991.
- 1,654,203. GAP-GUARD. INT. CL. 9. (U.S. CL. 26). REG. 8-20-1991.
- 1,656,215. MODERN ROMANCES. INT. CL. 16. (U.S. CL. 38). REG. 9-10-1991.
- 1,656,334. BK AND DESIGN. INT. CL. 25. (U.S. CL. 39). REG. 9-10-1991.
- 1,656,341. SAGA. INT. CL. 27. (U.S. CL. 20). REG. 9-10-1991.
- 1,658,077. CADSTOR (STYLIZED). INT. CL. 9. (U.S. CL. 38). REG. 9-24-1991.
- 1,658,445. BASIC PLUS AND DESIGN. INT. CL. 31. (U.S. CL. 46). REG. 9-24-1991.
- 1,659,447. NAIL EATER. INT. CL. 7. (U.S. CL. 23). REG. 10-8-1991.
- 1,659,645. FILTR-CLEER. INT. CL. 11. (U.S. CL. 31). REG. 10-8-1991.
- 1,659,744. HYTHANE. INT. CL. 17. (U.S. CL. 35). REG. 10-8-1991.

- 1,660,186. ECKLER'S. INT. CL. 42. (U.S. CL. 101). REG. 10-8-1991.
- 1,662,684. NATURAL HARMONY. INT. CL. 31. (U.S. CL. 1). REG. 10-29-1991.
- 1,664,569. DON'T WORRY BE CRABBY. INT. CL. 42. (U.S. CLS. 100 AND 101). REG. 11-12-1991.
- 1,664,940. RHO/5.0. INT. CL. 12. (U.S. CLS. 19 AND 23). REG. 11-19-1991.
- 1,666,336. SYSTEM SAVER. INT. CL. 1. (U.S. CLS. 6 AND 52). REG. 12-3-1991.
- 1,666,342. SUPER U AGRICO AND DESIGN. INT. CL. 1. (U.S. CL. 10). REG. 12-3-1991.
- 1,667,364. PRISMA. INT. CL. 9. (U.S. CL. 26). REG. 12-10-1991.
- 1,668,808. THE WRECK ROOM. INT. CL. 37. (U.S. CL. 103). REG. 12-17-1991.
- 1,670,450. WILD TURKEY KENTUCKY LEGEND BEYOND DUPLICATION AND DESIGN. INT. CL. 33. (U.S. CL. 49). REG. 12-31-1991.
- 1,671,139. CAT MAT AND DESIGN. INT. CL. 20. (U.S. CLS. 3 AND 32). REG. 1-7-1992.
- 1,672,615. MIC-EZE. INT. CL. 20. (U.S. CL. 13). REG. 1-21-1992.
- 1,673,704. MISCELLANEOUS DESIGN. INT. CL. 41. (U.S. CL. 107). REG. 1-28-1992.
- 1,673,957. TING AND DESIGN. INT. CL. 3. (U.S. CL. 52). REG. 2-4-1992.
- 1,674,061. WHEN IT'S NEEDED. INT. CL. 9. (U.S. CL. 38). REG. 2-4-1992.
- 1,674,063. HAR-PAK (STYLIZED). INT. CL. 9. (U.S. CL. 21). REG. 2-4-1992.
- 1,674,277. MEET ME IN CHEERS AND DESIGN. INT. CL. 21. (U.S. CLS. 2, 30 AND 33). REG. 2-4-1992.
- 1,674,283. LUSTERSPUN. INT. CLS. 22 AND 23. (U.S. CLS. 1 AND 43). REG. 2-4-1992.
- 1,674,603. PROFESSIONAL APPLICATOR INSTITUTE. INT. CL. 41 ONLY. (U.S. CL. 107). REG. 2-4-1992.
- 1,674,724. THERMOSEAL. INT. CLS. 2 AND 19. (U.S. CLS. 12 AND 16). REG. 2-11-1992.
- 1,674,905. DPR. INT. CL. 9. (U.S. CL. 26). REG. 2-11-1992.
- 1,674,915. HUMBUCKER FROM HELL. INT. CL. 9. (U.S. CLS. 21 AND 36). REG. 2-11-1992.
- 1,674,927. TROJAN MAN. INT. CL. 10. (U.S. CL. 44). REG. 2-11-1992.
- 1,674,958. HUMIDIPAD. INT. CL. 11. (U.S. CL. 34). REG. 2-11-1992.
- 1,674,968. MISCELLANEOUS DESIGN. INT. CL. 12. (U.S. CLS. 19 AND 35). REG. 2-11-1992.
- 1,674,979. 747 (STYLIZED). INT. CL. 12. (U.S. CL. 19). REG. 2-11-1992.
- 1,674,980. 757 (STYLIZED). INT. CL. 12. (U.S. CL. 19). REG. 2-11-1992.
- 1,675,044. REGENT. INT. CL. 16. (U.S. CL. 31). REG. 2-11-1992.
- 1,675,065. F-217. INT. CL. 17. (U.S. CLS. 1 AND 35). REG. 2-11-1992.
- 1,675,111. FLEX-EZE. INT. CL. 20. (U.S. CL. 13). REG. 2-11-1992.
- 1,675,112. AIRFLOW 2000 AND DESIGN. INT. CL. 20. (U.S. CL. 32). REG. 2-11-1992.
- 1,675,113. NIGHTFLIGHT AND DESIGN. INT. CL. 20. (U.S. CL. 32). REG. 2-11-1992.
- 1,675,114. HARTFORD HOUSE. INT. CL. 20. (U.S. CL. 32). REG. 2-11-1992.
- 1,675,116. NORCAP. INT. CL. 20. (U.S. CL. 50). REG. 2-11-1992.
- 1,675,177. MISCELLANEOUS DESIGN. INT. CL. 25. (U.S. CL. 39). REG. 2-11-1992.
- 1,675,182. MISCELLANEOUS DESIGN. INT. CL. 25. (U.S. CLS. 22 AND 39). REG. 2-11-1992.
- 1,675,209. CESARANI (STYLIZED). INT. CL. 25. (U.S. CL. 39). REG. 2-11-1992.
- 1,675,235. INTERNATIONAL. INT. CL. 28. (U.S. CLS. 22, 23, 38 AND 50). REG. 2-11-1992.
- 1,675,248. H & N. INT. CL. 29. (U.S. CL. 46). REG. 2-11-1992.
- 1,675,249. AROMA. INT. CL. 30. (U.S. CL. 46). REG. 2-11-1992.
- 1,675,260. CRISTAL AND DESIGN. INT. CL. 32. (U.S. CL. 48). REG. 2-11-1992.
- 1,675,343. METAL COATERS AND DESIGN. INT. CL. 37. (U.S. CLS. 103 AND 106). REG. 2-11-1992.
- 1,675,411. YOGODA SATSANGA SOCIETY OF INDIA. INT. CLS. 41 AND 42. (U.S. CLS. 100, 101 AND 107). REG. 2-11-1992.
- 1,675,415. THE ISRAEL COLLOQUIUM. INT. CL. 41. (U.S. CL. 107). REG. 2-11-1992.
- 1,675,468. BIODIGITAL TECHNOLOGIES. INT. CL. 42. (U.S. CLS. 100 AND 101). REG. 2-11-1992.
- 1,675,488. MISCELLANEOUS DESIGN. INT. CL. 42. (U.S. CL. 101). REG. 2-11-1992.
- 1,675,493. COLLEGE NETWORK. INT. CL. 42. (U.S. CL. 100). REG. 2-11-1992.
- 1,675,524. LUMI-GAL. INT. CL. 1. (U.S. CL. 6). REG. 2-11-1992.
- 1,675,547. CORTRAC. INT. CL. 10. (U.S. CL. 44). REG. 2-11-1992.
- 1,675,578. AHA!. INT. CL. 35. (U.S. CL. 101). REG. 2-11-1992.
- 1,675,696. STAUBLI AND DESIGN. INT. CLS. 7 AND 9. (U.S. CLS. 23 AND 26). REG. 2-18-1992.
- 1,675,864. SILICONVALLEY (STYLIZED). INT. CL. 16. (U.S. CL. 38). REG. 2-18-1992.
- 1,675,874. TEMPERLITE. INT. CL. 17. (U.S. CL. 35). REG. 2-18-1992.
- 1,675,926. SABRES. INT. CL. 25. (U.S. CL. 39). REG. 2-18-1992.
- 1,675,954. QUEEN CARPET. INT. CL. 27. (U.S. CL. 42). REG. 2-18-1992.
- 1,675,981. COLD SPRINGS FARM. INT. CLS. 29 AND 31. (U.S. CLS. 1 AND 46). REG. 2-18-1992.
- 1,675,992. MISCELLANEOUS DESIGN. INT. CL. 29. (U.S. CL. 46). REG. 2-18-1992.
- 1,676,016. KAYO AND DESIGN. INT. CL. 30. (U.S. CL. 46). REG. 2-18-1992.
- 1,676,280. N NCAC AND DESIGN. U.S. CL. B. REG. 2-18-1992.
- 1,676,340. LIFE SHIELD. INT. CL. 10. (U.S. CL. 44). REG. 2-18-1992.
- 1,676,410. WILD HORSES (STYLIZED). INT. CL. 41. (U.S. CL. 107). REG. 2-18-1992.
- 1,676,426. HIGH VOLUME INDEPENDENT DRUG STORES. INT. CL. 16. (U.S. CL. 38). REG. 2-18-1992.
- 1,676,447. NORFOX. INT. CLS. 1 AND 4. (U.S. CLS. 6 AND 15). REG. 2-25-1992.
- 1,676,474. AQUA-CHEM. INT. CL. 2. (U.S. CL. 6). REG. 2-25-1992.
- 1,676,532. SN-X. INT. CL. 5. (U.S. CL. 18). REG. 2-25-1992.
- 1,676,567. SHERWOOD. INT. CL. 7. (U.S. CL. 23). REG. 2-25-1992.
- 1,676,576. KS AND DESIGN. INT. CL. 7. (U.S. CL. 23). REG. 2-25-1992.
- 1,676,577. KS AND DESIGN. INT. CL. 7. (U.S. CL. 23). REG. 2-25-1992.
- 1,676,617. PMI. INT. CL. 9. (U.S. CLS. 21 AND 26). REG. 2-25-1992.
- 1,676,653. CLICK-STOP. INT. CL. 10. (U.S. CL. 44). REG. 2-25-1992.
- 1,676,688. MISCELLANEOUS DESIGN. INT. CL. 11. (U.S. CL. 34). REG. 2-25-1992.
- 1,676,795. PERMA-FORM. INT. CL. 19. (U.S. CL. 12). REG. 2-25-1992.
- 1,676,851. COLORADO CUT AND DESIGN. INT. CL. 25. (U.S. CL. 39). REG. 2-25-1992.
- 1,676,883. THE STEP AND DESIGN. INT. CL. 25. (U.S. CL. 39). REG. 2-25-1992.
- 1,676,947. MOUNTAIN MEADOWS. INT. CL. 31. (U.S. CL. 1). REG. 2-25-1992.
- 1,676,948. BIRD COUNTRY. INT. CL. 31. (U.S. CL. 1). REG. 2-25-1992.
- 1,677,114. THE YOUNG AND THE RESTLESS. INT. CL. 41. (U.S. CL. 107). REG. 2-25-1992.
- 1,677,305. DUROX. INT. CL. 4. (U.S. CL. 15). REG. 3-3-1992.
- 1,677,333. SEPTODERM. INT. CL. 5. (U.S. CLS. 18 AND 52). REG. 3-3-1992.
- 1,677,373. INTEGRALE. INT. CL. 8. (U.S. CL. 23). REG. 3-3-1992.
- 1,677,484. DLP. INT. CL. 10. (U.S. CL. 44). REG. 3-3-1992.
- 1,677,492. MRINNERVU. INT. CL. 10. (U.S. CL. 44). REG. 3-3-1992.
- 1,677,628. PERMA-DRY. INT. CL. 17. (U.S. CL. 35). REG. 3-3-1992.
- 1,677,799. AMERICONE. INT. CL. 30. (U.S. CL. 46). REG. 3-3-1992.
- 1,677,995. PONDEROSA AND DESIGN. INT. CL. 42. (U.S. CL. 100). REG. 3-3-1992.
- 1,678,055. METRA. INT. CL. 9. (U.S. CL. 26). REG. 3-3-1992.
- 1,678,229. RAVE. INT. CL. 3. (U.S. CL. 51). REG. 3-10-1992.

- 1,678,399. SERVI-SERT. INT. CL. 11. (U.S. CL. 13). REG. 3-10-1992.
- 1,678,407. CERAMEM. INT. CL. 11. (U.S. CL. 31). REG. 3-10-1992.
- 1,678,469. TISSUEPAK (STYLIZED). INT. CL. 16. (U.S. CL. 37). REG. 3-10-1992.
- 1,678,514. EXOTIC DANCER. INT. CL. 16. (U.S. CL. 38). REG. 3-10-1992.
- 1,678,753. ARIES. INT. CL. 33. (U.S. CLS. 47 AND 49). REG. 3-10-1992.
- 1,678,819. MADE IN JAPAN. INT. CL. 37. (U.S. CLS. 100, 103 AND 106). REG. 3-10-1992.
- 1,678,863. FIEVEL'S PLAYLAND. INT. CL. 41. (U.S. CL. 107). REG. 3-10-1992.
- 1,679,149. CM AND DESIGN. INT. CLS. 6 AND 10 ONLY. (U.S. CLS. 2, 12, 13, 14, 23, 25, 44 AND 50). REG. 3-17-1992.
- 1,679,160. ZORVEX. INT. CL. 6. (U.S. CLS. 2, 12, 13, 14, 23, 25 AND 50). REG. 3-17-1992.
- 1,679,388. BIRCH SCROLL. INT. CL. 16. (U.S. CL. 38). REG. 3-17-1992.
- 1,679,411. CASHMERE. INT. CL. 19. (U.S. CL. 12). REG. 3-17-1992.
- 1,679,455. MISCELLANEOUS DESIGN. INT. CLS. 24 AND 25. (U.S. CLS. 22, 39 AND 42). REG. 3-17-1992.
- 1,679,500. MISCELLANEOUS DESIGN. INT. CL. 28. (U.S. CL. 22). REG. 3-17-1992.
- 1,679,536. BONUS CRISS CROSS. INT. CL. 28. (U.S. CLS. 22 AND 38). REG. 3-17-1992.
- 1,679,577. SUNSHINE FRESH (STYLIZED). INT. CL. 31. (U.S. CL. 46). REG. 3-17-1992.
- 1,679,669. TCS TRANS COURIER SYSTEMS (STYLIZED). INT. CL. 39. (U.S. CL. 105). REG. 3-17-1992.
- 1,679,766. S S Q C AND DESIGN. U.S. CL. A. REG. 3-17-1992.
- 1,680,899. ENVIRONMENTAL SAFETY SEAL AND DESIGN. INT. CL. 1. (U.S. CL. 5). REG. 3-31-1992.
- 1,681,082. ORATRONICS. INT. CL. 10. (U.S. CL. 44). REG. 3-31-1992.
- 1,681,183. SWEET VALLEY TWINS. INT. CL. 16. (U.S. CLS. 37 AND 38). REG. 3-31-1992.
- 1,681,221. TOUCHSTONE. INT. CL. 20. (U.S. CL. 50). REG. 3-31-1992.
- 1,681,257. DYNAMESH (STYLIZED). INT. CL. 24. (U.S. CL. 42). REG. 3-31-1992.
- 1,681,331. T TOWNSEND AND DESIGN. INT. CL. 29. (U.S. CL. 46). REG. 3-31-1992.
- 1,681,355. B AND DESIGN. INT. CL. 30. (U.S. CL. 46). REG. 3-31-1992.
- 1,681,366. CORONA (STYLIZED). INT. CL. 32. (U.S. CL. 48). REG. 3-31-1992.
- 1,681,501. MISCELLANEOUS DESIGN. INT. CL. 41. (U.S. CL. 107). REG. 3-31-1992.
- 1,681,550. BIRTHDAY CHOCOLATES. INT. CL. 42. (U.S. CL. 101). REG. 3-31-1992.
- 1,681,588. PRO-SET TOOL. INT. CL. 8. (U.S. CL. 23). REG. 3-31-1992.
- 1,681,644. TOTAL CRAFTS. INT. CL. 42. (U.S. CL. 101). REG. 3-31-1992.
- 1,681,722. MASTERY-DL. INT. CL. 3. (U.S. CL. 52). REG. 4-7-1992.
- 1,681,819. MERIDIAN SL. INT. CL. 9. (U.S. CLS. 21, 26 AND 38). REG. 4-7-1992.
- 1,681,847. MISCELLANEOUS DESIGN. INT. CLS. 9, 16 AND 25. (U.S. CLS. 36, 38 AND 39). REG. 4-7-1992.
- 1,681,993. THREE RIVERS NEWS. INT. CL. 16. (U.S. CL. 38). REG. 4-7-1992.
- 1,682,162. DAWN. INT. CL. 30. (U.S. CL. 46). REG. 4-7-1992.
- 1,682,453. COFFEE CROWN. INT. CL. 29. (U.S. CL. 46). REG. 4-7-1992.
- 1,682,666. STUBBLE DRILL. INT. CL. 7. (U.S. CLS. 13, 19, 21, 23, 31, 34 AND 35). REG. 4-14-1992.
- 1,682,713. TEKTON. INT. CL. 9. (U.S. CL. 38). REG. 4-14-1992.
- 1,682,744. HALO. INT. CL. 9. (U.S. CL. 26). REG. 4-14-1992.
- 1,682,820. MISCELLANEOUS DESIGN. INT. CL. 12. (U.S. CL. 19). REG. 4-14-1992.
- 1,682,901. CAPITOL ADVANTAGE. INT. CL. 16. (U.S. CL. 38). REG. 4-14-1992.
- 1,683,113. JF (STYLIZED). INT. CL. 30. (U.S. CL. 46). REG. 4-14-1992.
- 1,683,234. MINTIE CORPORATION. INT. CL. 37. (U.S. CL. 103). REG. 4-14-1992.
- 1,683,531. CHEMAFLUX. INT. CL. 1. (U.S. CL. 6). REG. 4-21-1992.
- 1,683,538. ACE (STYLIZED). INT. CLS. 2 AND 4. (U.S. CLS. 1, 6, 11, 15 AND 16). REG. 4-21-1992.
- 1,683,627. SAVRS. INT. CL. 9. (U.S. CL. 38). REG. 4-21-1992.
- 1,683,923. SHURFINE. INT. CL. 31. (U.S. CL. 46). REG. 4-21-1992.
- 1,683,981. BEATTY CONTRACTORS & WRECKERS, LTD. AND DESIGN. INT. CL. 37. (U.S. CL. 103). REG. 4-21-1992.
- 1,684,104. BIOELEMENTS AND DESIGN. INT. CLS. 3 AND 5. (U.S. CLS. 1, 4, 6, 18, 44, 46, 50, 51 AND 52). REG. 4-21-1992.
- 1,684,476. MISCELLANEOUS DESIGN. INT. CL. 21. (U.S. CLS. 2 AND 33). REG. 4-28-1992.
- 1,684,507. PURE OCEAN AND DESIGN. INT. CL. 25. (U.S. CL. 39). REG. 4-28-1992.
- 1,684,566. EDMOND FALLOT (STYLIZED). INT. CL. 30. (U.S. CLS. 1 AND 46). REG. 4-28-1992.
- 1,684,576. MISCELLANEOUS DESIGN. INT. CL. 30. (U.S. CL. 46). REG. 4-28-1992.
- 1,684,684. BERMUDA LIMOUSINE INTERNATIONAL. INT. CL. 39. (U.S. CL. 105). REG. 4-28-1992.
- 1,684,996. BRUSKE BLOT-IT NON-SKID, SPILL ADSORBENT COMPOUND (STYLIZED). INT. CL. 3. (U.S. CLS. 6 AND 52). REG. 5-5-1992.
- 1,685,314. X-FORCE. INT. CL. 16. (U.S. CLS. 2, 5, 22, 23, 29, 37, 38 AND 50). REG. 5-5-1992.
- 1,685,490. GOURMET VILLAGE MORIN HEIGHTS AND DESIGN. INT. CL. 30. (U.S. CL. 46). REG. 5-5-1992.
- 1,685,536. DUTY FREE SHOW OF THE AMERICAS. INT. CL. 35. (U.S. CL. 101). REG. 5-5-1992.
- 1,685,708. MISCELLANEOUS DESIGN. INT. CL. 42. (U.S. CL. 100). REG. 5-5-1992.
- 1,685,732. BRAKEMASTER. INT. CL. 6. (U.S. CL. 12). REG. 5-5-1992.
- 1,685,780. COLOR FINDER. INT. CL. 16. (U.S. CL. 38). REG. 5-5-1992.
- 1,685,871. CUSTOM. INT. CLS. 1, 3, 17 AND 19 ONLY. (U.S. CLS. 1, 4, 5, 6, 10, 12, 13, 26, 33, 35, 46, 50, 51 AND 52). REG. 5-12-1992.
- 1,685,994. MISCELLANEOUS DESIGN. INT. CL. 6. (U.S. CLS. 12 AND 13). REG. 5-12-1992.
- 1,686,128. GARDEN MASTER. INT. CL. 18 ONLY. (U.S. CLS. 1, 2, 3, 22 AND 41). REG. 5-12-1992.
- 1,686,136. ISHIDA. INT. CL. 9. (U.S. CLS. 23 AND 26). REG. 5-12-1992.
- 1,686,732. TRAC PAC. INT. CL. 36. (U.S. CL. 102). REG. 5-12-1992.
- 1,686,752. KIMCO. INT. CL. 37. (U.S. CL. 103). REG. 5-12-1992.
- 1,686,879. VALUBUY FOODS. INT. CL. 42. (U.S. CL. 101). REG. 5-12-1992.
- 1,686,936. CAFE MARIE AND DESIGN. INT. CL. 42. (U.S. CL. 100). REG. 5-12-1992.
- 1,687,299. PROFILE. INT. CL. 33. (U.S. CL. 47). REG. 5-12-1992.
- 1,687,301. ARIZONA AND DESIGN. INT. CL. 34. (U.S. CL. 17). REG. 5-12-1992.
- 1,687,669. TECHNASONIC. INT. CL. 9. (U.S. CLS. 21 AND 26). REG. 5-19-1992.
- 1,688,036. ROBERT C.'S (STYLIZED). INT. CL. 31. (U.S. CL. 46). REG. 5-19-1992.
- 1,688,037. OV OLD VIENNA PREMIUM QUALITY SINCE 1862 AND DESIGN. INT. CL. 32. (U.S. CL. 48). REG. 5-19-1992.
- 1,688,464. THE YORK PROTOCOL. INT. CL. 35. (U.S. CL. 101). REG. 5-19-1992.
- 1,688,803. CHEM-WHITE. INT. CL. 9. (U.S. CL. 26). REG. 5-26-1992.
- 1,689,283. AVATAR ASSOCIATES. INT. CL. 36. (U.S. CLS. 100 AND 102). REG. 5-26-1992.
- 1,689,606. BIGTYME FOOTBALL. INT. CL. 28. (U.S. CL. 22). REG. 5-26-1992.
- 1,689,849. DELCO AND DESIGN. INT. CL. 7. (U.S. CL. 23). REG. 6-2-1992.
- 1,690,018. PARTNERS IN QUALITY. INT. CL. 10. (U.S. CL. 44). REG. 6-2-1992.
- 1,690,019. KIMBERLY-CLARK + PARTNERS IN QUALITY + AND DESIGN. INT. CL. 10. (U.S. CL. 44). REG. 6-2-1992.
- 1,690,212. SYMMETRY. INT. CL. 20. (U.S. CLS. 2, 13, 22, 25, 32 AND 50). REG. 6-2-1992.
- 1,690,547. SK FOODS AND DESIGN. INT. CL. 40. (U.S. CL. 106). REG. 6-2-1992.

- 1,690,801. DOODAD. INT. CL. 17. (U.S. CLS. 13 AND 21). REG. 6-2-1992.
- 1,691,075. HI-TINT. INT. CL. 2. (U.S. CL. 16). REG. 6-9-1992.
- 1,691,149. RESTART ONE-4. INT. CL. 5. (U.S. CLS. 18 AND 46). REG. 6-9-1992.
- 1,691,214. L-COM AND DESIGN. INT. CL. 9. (U.S. CL. 21). REG. 6-9-1992.
- 1,691,914. LYNDEN INTERNATIONAL AND DESIGN. INT. CLS. 36 AND 39. (U.S. CLS. 101, 102 AND 105). REG. 6-9-1992.
- 1,692,053. AFTERMATH. INT. CL. 41. (U.S. CL. 107). REG. 6-9-1992.
- 1,692,110. THE WATER CLUB. INT. CL. 42. (U.S. CL. 100). REG. 6-9-1992.
- 1,692,276. BMC (STYLIZED). INT. CL. 2. (U.S. CL. 16). REG. 6-9-1992.
- 1,692,409. POSIDOT. INT. CL. 7. (U.S. CLS. 13 AND 23). REG. 6-9-1992.
- 1,692,689. FRENCH TOAST. INT. CL. 9. (U.S. CL. 26). REG. 6-9-1992.
- 1,692,770. WEIL-MCLAIN GOLD. INT. CL. 11. (U.S. CL. 34). REG. 6-9-1992.
- 1,692,999. FRENCH TOAST. INT. CL. 18. (U.S. CL. 3). REG. 6-9-1992.
- 1,693,043. TRANSITIONS. INT. CL. 20. (U.S. CL. 32). REG. 6-9-1992.
- 1,693,187. ST. JOHN. INT. CL. 25. (U.S. CL. 39). REG. 6-9-1992.
- 1,693,472. FREEPORT AND DESIGN. INT. CL. 34. (U.S. CL. 17). REG. 6-9-1992.
- 1,693,473. LONG BEACH AND DESIGN. INT. CL. 34. (U.S. CL. 17). REG. 6-9-1992.
- 1,693,474. PARK DRIVE AND DESIGN. INT. CL. 34. (U.S. CL. 17). REG. 6-9-1992.
- 1,693,970. DL (STYLIZED). INT. CLS. 6, 7, 8, 9 AND 12. (U.S. CLS. 9, 13, 19 AND 23). REG. 6-16-1992.
- 1,693,972. GEMPLUX AND DESIGN. INT. CL. 6. (U.S. CL. 13). REG. 6-16-1992.
- 1,694,059. BEST RATE. INT. CLS. 9 AND 42. (U.S. CLS. 38, 100 AND 101). REG. 6-16-1992.
- 1,694,210. CLASSIC. INT. CL. 11. (U.S. CLS. 13 AND 34). REG. 6-16-1992.
- 1,694,541. PURE VOLLEYBALL AND DESIGN. INT. CL. 25. (U.S. CL. 39). REG. 6-16-1992.
- 1,694,551. HEXALITE. INT. CL. 25. (U.S. CL. 39). REG. 6-16-1992.
- 1,694,832. THE RIGHT REPORT. INT. CL. 36. (U.S. CL. 102). REG. 6-16-1992.
- 1,694,869. KIMCO AND DESIGN. INT. CL. 37. (U.S. CL. 103). REG. 6-16-1992.
- 1,695,622. NEVADA HIGH DESERT (STYLIZED). INT. CL. 31. (U.S. CL. 46). REG. 6-16-1992.
- 1,695,659. ELECTRODAG. INT. CL. 1. (U.S. CL. 6). REG. 6-23-1992.
- 1,696,074. SAC. INT. CL. 16. (U.S. CL. 38). REG. 6-23-1992.
- 1,696,232. TANNED IN TACK. INT. CL. 28. (U.S. CL. 22). REG. 6-23-1992.
- 1,696,601. FIREWORKS SUPERMARKET AND DESIGN. INT. CL. 42. (U.S. CLS. 100 AND 101). REG. 6-23-1992.
- 1,697,156. PRACTICE PROFILES. INT. CL. 16. (U.S. CL. 38). REG. 6-23-1992.
- 1,697,277. ADVANTAGE. INT. CL. 2. (U.S. CL. 11). REG. 6-30-1992.
- 1,697,458. ACTION CONTROL SYSTEM. INT. CL. 9. (U.S. CL. 26). REG. 6-30-1992.
- 1,697,529. LESTER. INT. CL. 12. (U.S. CL. 35). REG. 6-30-1992.
- 1,697,854. BALDINGER. INT. CL. 30. (U.S. CL. 46). REG. 6-30-1992.
- 1,697,887. MISCELLANEOUS DESIGN. INT. CL. 31. (U.S. CL. 46). REG. 6-30-1992.
- 1,698,652. RESI-BOND. INT. CL. 1. (U.S. CLS. 1 AND 6). REG. 7-7-1992.
- 1,698,746. PHOS FUEL. INT. CL. 5. (U.S. CL. 18). REG. 7-7-1992.
- 1,698,833. PRO TEC AND DESIGN. INT. CL. 9. (U.S. CLS. 19, 21 AND 26). REG. 7-7-1992.
- 1,699,093. ROCKY MOUNTAIN LOG HOMES. INT. CL. 19. (U.S. CL. 12). REG. 7-7-1992.
- 1,699,217. CUE CUE CUBE CUBE AND DESIGN. INT. CL. 28. (U.S. CL. 22). REG. 7-7-1992.
- 1,699,818. INNOVA. INT. CL. 17. (U.S. CLS. 12 AND 35). REG. 7-7-1992.
- 1,700,502. SYMLOG. INT. CLS. 16, 35 AND 41. (U.S. CLS. 2, 5, 22, 23, 29, 37, 38, 50, 100, 101, 102 AND 107). REG. 7-14-1992.
- 1,700,555. TRUE-TUFF. INT. CL. 17. (U.S. CL. 1). REG. 7-14-1992.
- 1,700,970. CREATIVE MEDIA PRODUCTS. INT. CL. 42. (U.S. CLS. 100 AND 101). REG. 7-14-1992.
- 1,702,136. THE TRAVELING GARAGE. INT. CL. 37. (U.S. CL. 103). REG. 7-21-1992.
- 1,702,608. ULTIMATE EXT. INT. CL. 31. (U.S. CL. 46). REG. 7-21-1992.
- 1,702,649. TOTAL CRAFTS AND DESIGN. INT. CL. 42. (U.S. CL. 101). REG. 7-21-1992.
- 1,702,791. SHURFINE. INT. CL. 5. (U.S. CLS. 6, 18 AND 44). REG. 7-28-1992.
- 1,702,996. SHOPTRAC. INT. CL. 9. (U.S. CLS. 26 AND 38). REG. 7-28-1992.
- 1,703,061. COLLEGE PARK. INT. CL. 10. (U.S. CL. 44). REG. 7-28-1992.
- 1,703,228. SYSTEMS AUDITABILITY AND CONTROL. INT. CL. 16. (U.S. CL. 38). REG. 7-28-1992.
- 1,703,259. HAMCO (STYLIZED). INT. CL. 16. (U.S. CLS. 11 AND 37). REG. 7-28-1992.
- 1,703,378. BEACH ZONE AND DESIGN. INT. CL. 25. (U.S. CL. 39). REG. 7-28-1992.
- 1,703,575. ROCKING M CATTLE CO.. INT. CL. 31. (U.S. CL. 1). REG. 7-28-1992.
- 1,703,595. SHUR SAVING. INT. CL. 32. (U.S. CL. 45). REG. 7-28-1992.
- 1,704,192. PERCUDISC. INT. CL. 10. (U.S. CLS. 26, 39 AND 44). REG. 7-28-1992.
- 1,705,115. JESSICA MICHELLE. INT. CL. 25. (U.S. CL. 39). REG. 8-4-1992.
- 1,705,721. PERMEOX. INT. CL. 1. (U.S. CLS. 6 AND 10). REG. 8-4-1992.
- 1,705,845. QUICKSET. INT. CL. 16. (U.S. CLS. 2, 5, 22, 23, 29, 37, 38 AND 50). REG. 8-4-1992.
- 1,705,846. NOTE WRITERS. INT. CL. 16. (U.S. CL. 37). REG. 8-4-1992.
- 1,705,888. TOLI AND DESIGN. INT. CL. 27. (U.S. CL. 20). REG. 8-4-1992.
- 1,706,201. VETA-K1 (STYLIZED). INT. CL. 5. (U.S. CL. 18). REG. 8-11-1992.
- 1,706,326. GR-540-A. INT. CL. 9. (U.S. CL. 21). REG. 8-11-1992.
- 1,706,647. SOUTHWEST MISSOURI STATE. INT. CLS. 16, 21, 25 AND 41. (U.S. CLS. 2, 30, 33, 37, 38, 39 AND 107). REG. 8-11-1992.
- 1,707,658. EXCELLOLITH. INT. CL. 2. (U.S. CL. 11). REG. 8-18-1992.
- 1,709,127. POWER FUEL. INT. CL. 5. (U.S. CL. 18). REG. 8-18-1992.
- 1,709,532. PRESIDENT'S CLUB. INT. CL. 42. (U.S. CLS. 100 AND 101). REG. 8-18-1992.
- 1,710,962. QUICKPREP. INT. CL. 1. (U.S. CLS. 1 AND 6). REG. 9-1-1992.
- 1,711,052. SENTINEL. INT. CL. 3. (U.S. CLS. 44 AND 51). REG. 9-1-1992.
- 1,711,313. INTELLIDRIVE. INT. CL. 9. (U.S. CL. 26). REG. 9-1-1992.
- 1,711,779. WHISK-ON-PAN. INT. CL. 21. (U.S. CLS. 2 AND 13). REG. 9-1-1992.
- 1,711,945. MISCELLANEOUS DESIGN. INT. CL. 29. (U.S. CL. 46). REG. 9-1-1992.
- 1,712,007. 5 CRABS. INT. CL. 30. (U.S. CL. 46). REG. 9-1-1992.
- 1,712,865. HARMONY IN TUNE WITH NATURE. INT. CL. 1. (U.S. CL. 6). REG. 9-8-1992.
- 1,713,215. NORTHERN COMPUTERS, INC. AND DESIGN. INT. CL. 9. (U.S. CLS. 26 AND 38). REG. 9-8-1992.
- 1,714,479. RENAISSANCE CLUB. INT. CL. 42. (U.S. CL. 100). REG. 9-8-1992.
- 1,714,523. RESTORING AMERICAN PERFORMANCE. INT. CL. 42. (U.S. CLS. 100 AND 101). REG. 9-8-1992.
- 1,714,538. KUA 'AINA (STYLIZED). INT. CL. 42. (U.S. CL. 100). REG. 9-8-1992.
- 1,715,426. ENTERPRISE. INT. CL. 11. (U.S. CL. 34). REG. 9-15-1992.
- 1,716,155. JAY FLAVORS. INT. CL. 30. (U.S. CL. 46). REG. 9-15-1992.
- 1,716,450. KGA. INT. CL. 36. (U.S. CLS. 101 AND 102). REG. 9-15-1992.
- 1,716,877. GERAGHTY TENNIS AND DESIGN. INT. CL. 42. (U.S. CL. 101). REG. 9-15-1992.

- 1,717,673. NORTHERN COMPUTERS, INC. AND DESIGN. INT. CL. 9. (U.S. CLS. 21, 23, 26 AND 38). REG. 9-22-1992.
- 1,718,395. SUNNYLAND. INT. CL. 29. (U.S. CL. 46). REG. 9-22-1992.
- 1,718,818. NATIONAL. INT. CL. 39. (U.S. CL. 105). REG. 9-22-1992.
- 1,719,435. COLDISC. INT. CL. 11. (U.S. CL. 31). REG. 9-22-1992.
- 1,721,623. USURVEY. INT. CL. 9. (U.S. CL. 38). REG. 10-6-1992.
- 1,723,512. THERMEX AND DESIGN. INT. CL. 9. (U.S. CL. 26). REG. 10-13-1992.
- 1,723,672. MANITOU AND COG WHEEL ROUTE PIKE'S PEAKRAILWAY AND DESIGN. INT. CLS. 16 AND 39. (U.S. CLS. 38 AND 105). REG. 10-13-1992.
- 1,724,350. HILTON HEAD ISLAND CELEBRITY GOLF TOURNAMENT AND DESIGN. INT. CL. 41. (U.S. CL. 107). REG. 10-13-1992.
- 1,724,816. FERRO FLUX. INT. CL. 1. (U.S. CL. 6). REG. 10-20-1992.
- 1,724,824. SEMICOSIL (STYLIZED). INT. CL. 1. (U.S. CLS. 5 AND 6). REG. 10-20-1992.
- 1,726,065. SURGIVA AND DESIGN. INT. CL. 32. (U.S. CLS. 45, 46 AND 48). REG. 10-20-1992.
- 1,726,357. MISCELLANEOUS DESIGN. INT. CLS. 41 AND 42. (U.S. CLS. 100, 101 AND 107). REG. 10-20-1992.
- 1,726,603. TACK-PREP. INT. CL. 2. (U.S. CL. 16). REG. 10-20-1992.
- 1,728,239. THE YOGA INSTITUTE OF MIAMI. INT. CL. 41. (U.S. CL. 107). REG. 10-27-1992.
- 1,728,789. HERVE CHAPELIER. INT. CL. 18 ONLY. (U.S. CL. 3). REG. 11-3-1992.
- 1,728,907. QC (STYLIZED). INT. CL. 7. (U.S. CLS. 23 AND 24). REG. 11-3-1992.
- 1,730,003. OUTRAGEOUS RUGS INTERNATIONAL. INT. CL. 42. (U.S. CL. 101). REG. 11-3-1992.
- 1,730,369. TOLI MATURE. INT. CL. 27. (U.S. CL. 20). REG. 11-3-1992.
- 1,731,395. HARRY'S SOURDOUGH PRETZELS. INT. CL. 30. (U.S. CL. 46). REG. 11-10-1992.
- 1,731,554. ELITE. INT. CL. 36. (U.S. CL. 102). REG. 11-10-1992.
- 1,733,423. NEW ENGLAND BREWING CO.. INT. CL. 32. (U.S. CL. 48). REG. 11-17-1992.
- 1,733,643. COLORIFIC. INT. CL. 40. (U.S. CL. 106). REG. 11-17-1992.
- 1,735,058. AUNT MABEL'S. INT. CL. 29. (U.S. CL. 46). REG. 11-24-1992.
- 1,735,773. MRS. KARL'S COUNTRY WHEAT. INT. CL. 30. (U.S. CL. 46). REG. 11-24-1992.
- 1,736,090. BLACK BEAUTY. INT. CL. 7. (U.S. CL. 23). REG. 12-1-1992.
- 1,736,230. CHEMWINDOW. INT. CL. 9. (U.S. CL. 38). REG. 12-1-1992.
- 1,736,588. CLARMAC. INT. CL. 19. (U.S. CLS. 12 AND 42). REG. 12-1-1992.
- 1,737,200. SILENCE IS GOLDEN. INT. CL. 41. (U.S. CL. 107). REG. 12-1-1992.
- 1,737,261. HARVEST GRAIN 'N NUT. INT. CL. 42. (U.S. CL. 100). REG. 12-1-1992.
- 1,739,407. BIOTENE. INT. CL. 5. (U.S. CLS. 18 AND 52). REG. 12-15-1992.
- 1,739,774. THE REGULATOR. INT. CL. 16. (U.S. CL. 38). REG. 12-15-1992.
- 1,739,817. TRAINS GUIDE TO RECREATIONAL RAILROADING. INT. CL. 16. (U.S. CL. 38). REG. 12-15-1992.
- 1,739,968. PURE SURF AND DESIGN. INT. CL. 25. (U.S. CL. 39). REG. 12-15-1992.
- 1,739,969. PURE SNOW AND DESIGN. INT. CL. 25. (U.S. CL. 39). REG. 12-15-1992.
- 1,740,688. ITA. INT. CL. 42. (U.S. CL. 100). REG. 12-15-1992.
- 1,741,487. AUTO-SITE. INT. CL. 28. (U.S. CL. 22). REG. 12-22-1992.
- 1,741,586. FERRARI. INT. CL. 33. (U.S. CLS. 47 AND 49). REG. 12-22-1992.
- 1,741,722. ADAMS AND DESIGN. INT. CLS. 37 AND 42. (U.S. CLS. 101 AND 103). REG. 12-22-1992.
- 1,741,809. MISCELLANEOUS DESIGN. INT. CL. 41. (U.S. CLS. 100, 101 AND 107). REG. 12-22-1992.
- 1,741,881. UFCW LOCAL 770 UNITED FOOD & COMMERCIALWORKERS INT'L. UNION AND DESIGN. INT. CL. 42. (U.S. CL. 100). REG. 12-22-1992.
- 1,742,895. TRAFFIC-MANAGER. INT. CL. 9. (U.S. CLS. 21 AND 50). REG. 12-29-1992.
- 1,744,540. K2. INT. CLS. 18, 25 AND 28. (U.S. CLS. 3, 22 AND 39). REG. 1-5-1993.
- 1,751,742. BIND A ZYME (STYLIZED). INT. CLS. 1 AND 5. (U.S. CL. 6). REG. 2-9-1993.
- 1,751,743. BIND A RID (STYLIZED). INT. CLS. 1 AND 5. (U.S. CL. 6). REG. 2-9-1993.

* * * * *

TRADEMARK REGISTRATIONS CANCELED

The designation "U.S. Cl." appearing in this section refers to the U.S. class in effect prior to Sep. 1, 1973 rather than the international class which applies to applications filed on or after that date. For adoption of international classification see notice in the OFFICIAL GAZETTE of Jun. 26, 1973 (911 O.G. TM 210).

SECTION 7(D)

| | | | |
|------------|--|----------|---|
| 745,217. | CONTINENTAL'S CHARTER OAK. U.S. CL. 49. REG. 2-12-1963. | 709,500. | SANSET. U.S. CL. 5. REG. 1-10-1961. |
| 1,157,231. | PIROUETTES AND DESIGN. INT. CL. 14. REG. 6-9-1981. | 713,003. | NOPCOTAN. U.S. CL. 6. REG. 3-28-1961. |
| 2,068,747. | HEALTHCAREONE. INT. CL. 36. REG. 6-10-1997. | 713,009. | THERMTRON (STYLIZED). U.S. CL. 12. REG. 3-28-1961. |
| 2,084,293. | SABAN'S COOL KIDS RECORDS. INT. CL. 9. REG. 7-29-1997. | 713,020. | YALE. U.S. CL. 13. REG. 3-28-1961. |
| 2,118,369. | REGENTS COLLEGE AND DESIGN. INT. CL. 16. REG. 12-2-1997. | 713,026. | PER-FIT. U.S. CL. 14. REG. 3-28-1961. |
| 2,263,766. | MISCELLANEOUS DESIGN. INT. CL. 36. REG. 7-20-1999. | 713,027. | PART-EASE. U.S. CL. 15. REG. 3-28-1961. |
| 2,362,642. | NUTS ABOUT GOLF. INT. CL. 28. REG. 6-27-2000. | 713,045. | SURFACE-FLEX (STYLIZED). U.S. CL. 16. REG. 3-28-1961. |
| 2,508,002. | CAURUS. INT. CL. 33. REG. 11-13-2001. | 713,046. | ALUMAZON. U.S. CL. 16. REG. 3-28-1961. |
| 2,512,736. | EQUA-BOLIN. INT. CL. 5. REG. 11-27-2001. | 713,084. | F AND DESIGN. U.S. CL. 21. REG. 3-28-1961. |
| 2,523,957. | SPIN OUT INSIDE AND DESIGN. INT. CL. 1. REG. 1-1-2002. | 713,092. | GLAMOUR STRETCHER. U.S. CL. 22. REG. 3-28-1961. |

SECTION 8

| | | | |
|----------|--|----------|---|
| 140,748. | BLUE=JAY (STYLIZED). U.S. CL. 6. REG. 3-29-1921. | 713,164. | FROST-MAGNET. U.S. CL. 31. REG. 3-28-1961. |
| 140,773. | STANDARD. U.S. CL. 23. REG. 3-29-1921. | 713,175. | HOLLAND MAID (STYLIZED). U.S. CL. 32. REG. 3-28-1961. |
| 140,845. | INTERNATIONAL (STYLIZED). U.S. CL. 23. REG. 3-29-1921. | 713,176. | MISCELLANEOUS DESIGN. U.S. CL. 32. REG. 3-28-1961. |
| 140,859. | KLEINERT'S (STYLIZED). U.S. CL. 39. REG. 3-29-1921. | 713,186. | CONCERT HALL AND DESIGN. U.S. CL. 36. REG. 3-28-1961. |
| 140,876. | ADMIRATION (STYLIZED). U.S. CL. 6. REG. 3-29-1921. | 713,189. | REGISTER CHECK. U.S. CL. 37. REG. 3-28-1961. |
| 140,946. | BILLY BAXTER (STYLIZED). U.S. CL. 45. REG. 3-29-1921. | 713,191. | FARM STORE MERCHANDISING AND DESIGN. U.S. CL. 38. REG. 3-28-1961. |
| 383,747. | CHOPLETS. U.S. CL. 46. REG. 12-24-1940. | 713,212. | LUCKY DUCKS AND DESIGN. U.S. CL. 39. REG. 3-28-1961. |
| 385,922. | BRAVO. U.S. CL. 51. REG. 3-25-1941. | 713,220. | HEADLINERS!. U.S. CL. 39. REG. 3-28-1961. |
| 385,933. | GREAT SCOT BY BOND STREET AND DESIGN. U.S. CL. 39. REG. 3-25-1941. | 713,221. | CORDOTAN. U.S. CL. 39. REG. 3-28-1961. |
| 385,957. | OPTABS. U.S. CL. 18. REG. 3-25-1941. | 713,222. | MISTER L (STYLIZED). U.S. CL. 39. REG. 3-28-1961. |
| 385,986. | RUSTIC. U.S. CL. 46. REG. 3-25-1941. | 713,232. | ANNE FOGARTY (STYLIZED). U.S. CL. 39. REG. 3-28-1961. |
| 385,993. | CIBA AND DESIGN. U.S. CL. 6. REG. 3-25-1941. | 713,235. | EVERYDAY. U.S. CL. 40. REG. 3-28-1961. |
| 386,004. | DECOR (STYLIZED). U.S. CL. 37. REG. 3-25-1941. | 713,240. | COMARRA. U.S. CL. 42. REG. 3-28-1961. |
| 386,032. | BINGO (STYLIZED). U.S. CL. 6. REG. 3-25-1941. | 713,241. | SOVEREIGN. U.S. CL. 42. REG. 3-28-1961. |
| 386,053. | SBTO AND DESIGN. U.S. CL. 21. REG. 3-25-1941. | 713,246. | FEATHER-TOUCH. U.S. CL. 42. REG. 3-28-1961. |
| 386,054. | MADAME ORINE'S NEW DISCOVERY HAIR TONIC (STYLIZED). U.S. CL. 51. REG. 3-25-1941. | 713,252. | CHIEF JOSEPH AND DESIGN. U.S. CL. 46. REG. 3-28-1961. |
| 386,110. | HYGEIA (STYLIZED). U.S. CL. 2. REG. 3-25-1941. | 713,253. | AMERICO. U.S. CL. 46. REG. 3-28-1961. |
| 386,124. | BUDDY SEAT. U.S. CL. 19. REG. 3-25-1941. | 713,263. | IDAHO VALLEY (STYLIZED). U.S. CL. 46. REG. 3-28-1961. |
| 386,154. | CLINTEX. U.S. CL. 6. REG. 3-25-1941. | 713,264. | BEEF PACKER. U.S. CL. 46. REG. 3-28-1961. |
| 386,158. | MAD APPLE (STYLIZED). U.S. CL. 51. REG. 3-25-1941. | 713,268. | STUART & WILLIAMS. U.S. CL. 49. REG. 3-28-1961. |
| 386,167. | PREZAIN (STYLIZED). U.S. CL. 6. REG. 3-25-1941. | 713,278. | FAIRY PRINCESS. U.S. CL. 51. REG. 3-28-1961. |
| 386,168. | SODOL (STYLIZED). U.S. CL. 6. REG. 3-25-1941. | 713,283. | BIODROGA COSMETIC. U.S. CL. 51. REG. 3-28-1961. |
| 693,707. | MISCELLANEOUS DESIGN. U.S. CL. 14. REG. 3-1-1960. | 713,287. | MANI MAGIC. U.S. CL. 51. REG. 3-28-1961. |
| 695,996. | CARDWELL AND DESIGN. U.S. CL. 23. REG. 4-12-1960. | 713,288. | METEX COPPER BRIGHTENER CI (STYLIZED). U.S. CL. 52. REG. 3-28-1961. |
| | | 713,291. | NATIONAL RED STAMPS. U.S. CL. 101. REG. 3-28-1961. |
| | | 713,294. | DART DRUG AND DESIGN. U.S. CL. 101. REG. 3-28-1961. |
| | | 713,299. | THE MONEY MAN AT THE BUDGET PLAN. U.S. CL. 102. REG. 3-28-1961. |
| | | 715,774. | SEPHADEX. U.S. CL. 31. REG. 5-23-1961. |

- 1,133,048. MEDI-VAC. INT. CL. 10. REG. 4-15-1980.
1,149,523. R.MC AND DESIGN. INT. CLS. 1 AND 9. REG. 3-31-1981.
1,149,525. ULTRASIL. INT. CLS. 1 AND 9. REG. 3-31-1981.
1,149,531. CALCOTE. INT. CL. 1. REG. 3-31-1981.
1,149,533. METEOR. INT. CL. 1. REG. 3-31-1981.
1,149,534. MOWITON. INT. CL. 1. REG. 3-31-1981.
1,149,540. CHIL-KOTE. INT. CL. 2. REG. 3-31-1981.
1,149,548. FLORI ROBERTS GOLD. INT. CL. 3. REG. 3-31-1981.
1,149,559. MISCELLANEOUS DESIGN. INT. CL. 3. REG. 3-31-1981.
1,149,560. KISSING SLICKS. INT. CL. 3. REG. 3-31-1981.
1,149,564. SUNCUT. INT. CL. 4. REG. 3-31-1981.
1,149,566. PLACENGEL. INT. CL. 5. REG. 3-31-1981.
1,149,569. STERE-O-LENE. INT. CL. 5. REG. 3-31-1981.
1,149,575. AEROPAK. INT. CL. 5. REG. 3-31-1981.
1,149,589. USILOK. INT. CL. 6. REG. 3-31-1981.
1,149,591. BRIAR-CUT SUPREME. INT. CL. 6. REG. 3-31-1981.
1,149,601. MWS. INT. CL. 6. REG. 3-31-1981.
1,149,604. MAVILOR (STYLIZED). INT. CLS. 7 AND 40. REG. 3-31-1981.
1,149,606. C AND DESIGN. INT. CL. 7. REG. 3-31-1981.
1,149,608. MAKING THE GRADE. INT. CL. 7. REG. 3-31-1981.
1,149,610. OX. INT. CL. 7. REG. 3-31-1981.
1,149,613. PTO POWR-GARD. INT. CL. 7. REG. 3-31-1981.
1,149,615. ULTRA TORQ. INT. CL. 7. REG. 3-31-1981.
1,149,626. WELD-LAG. INT. CL. 7. REG. 3-31-1981.
1,149,629. POWERBAR. INT. CL. 7. REG. 3-31-1981.
1,149,631. COMPACTALL. INT. CL. 7. REG. 3-31-1981.
1,149,636. MAC-BLAST. INT. CL. 7. REG. 3-31-1981.
1,149,644. SARAN. INT. CL. 8. REG. 3-31-1981.
1,149,657. MISCELLANEOUS DESIGN. INT. CLS. 9 AND 16. REG. 3-31-1981.
1,149,664. QUANTAMATIC TX. INT. CL. 9. REG. 3-31-1981.
1,149,670. GEOSOURCE AND DESIGN. INT. CL. 9. REG. 3-31-1981.
1,149,671. GEOSOURCE. INT. CL. 9. REG. 3-31-1981.
1,149,672. GEOSOURCE AND DESIGN. INT. CL. 9. REG. 3-31-1981.
1,149,677. NORTHROP. INT. CLS. 9 AND 12. REG. 3-31-1981.
1,149,684. OZECK (STYLIZED). INT. CL. 9. REG. 3-31-1981.
1,149,689. A.M.S.S.. INT. CL. 9. REG. 3-31-1981.
1,149,690. EONITE. INT. CL. 9. REG. 3-31-1981.
1,149,691. HELIOS. INT. CL. 9. REG. 3-31-1981.
1,149,701. PDI. INT. CL. 9. REG. 3-31-1981.
1,149,704. HI-MIC (STYLIZED). INT. CL. 9. REG. 3-31-1981.
1,149,708. SLIDEPORT. INT. CL. 10. REG. 3-31-1981.
1,149,710. EXTEND-A-DUCT. INT. CL. 11. REG. 3-31-1981.
1,149,713. SCRUBAIR. INT. CL. 11. REG. 3-31-1981.
1,149,720. MISCELLANEOUS DESIGN. INT. CLS. 11 AND 42. REG. 3-31-1981.
1,149,724. GG (STYLIZED). INT. CL. 12. REG. 3-31-1981.
1,149,726. SNOOZER-CRUISER. INT. CL. 12. REG. 3-31-1981.
1,149,727. MOTO MIRROR AND DESIGN. INT. CL. 12. REG. 3-31-1981.
1,149,731. G (STYLIZED). INT. CL. 12. REG. 3-31-1981.
1,149,732. ACTION FACTORY. INT. CL. 12. REG. 3-31-1981.
1,149,733. MAGNOLIA. INT. CL. 12. REG. 3-31-1981.
1,149,737. THE GAS MISER. INT. CL. 12. REG. 3-31-1981.
1,149,740. PINWHEELS. INT. CL. 12. REG. 3-31-1981.
1,149,750. SYLVIA SIMS. INT. CL. 14. REG. 3-31-1981.
1,149,752. MISCELLANEOUS DESIGN. INT. CL. 14. REG. 3-31-1981.
1,149,762. MWC. INT. CL. 14. REG. 3-31-1981.
1,149,769. SEX PISTOLS. INT. CL. 16. REG. 3-31-1981.
1,149,771. THE APALACHICOLA TIMES. INT. CL. 16. REG. 3-31-1981.
1,149,772. THE APALACHICOLA TIMES (STYLIZED). INT. CL. 16. REG. 3-31-1981.
1,149,782. PEEPHOLE ON PEOPLE. INT. CL. 16. REG. 3-31-1981.
1,149,784. FAVER. INT. CL. 16. REG. 3-31-1981.
1,149,786. FLEE. INT. CL. 16. REG. 3-31-1981.
1,149,790. LSE. INT. CL. 16. REG. 3-31-1981.
1,149,793. CRAZYWORLD (STYLIZED). INT. CL. 16. REG. 3-31-1981.
1,149,795. ST. JOSEPH. INT. CL. 16. REG. 3-31-1981.
1,149,800. CLIPTIP. INT. CL. 16. REG. 3-31-1981.
1,149,801. MAGNETIP. INT. CL. 16. REG. 3-31-1981.
1,149,802. GULFSTREAMER. INT. CL. 16. REG. 3-31-1981.
1,149,805. LEADING LADY. INT. CL. 16. REG. 3-31-1981.
1,149,809. OMEGA AND DESIGN. INT. CL. 17. REG. 3-31-1981.
1,149,810. VAPOR MASTER. INT. CL. 17. REG. 3-31-1981.
1,149,814. PRESSURE RELIEF. INT. CL. 17. REG. 3-31-1981.
1,149,821. BENTLEY'S AND DESIGN. INT. CL. 18. REG. 3-31-1981.
1,149,825. THE TOUGH ROAD SAVIN' SLURRY SEAL AND DESIGN. INT. CL. 19. REG. 3-31-1981.
1,149,826. AGGLO-MARBLE. INT. CL. 19. REG. 3-31-1981.
1,149,828. EASY-FLOAT. INT. CL. 19. REG. 3-31-1981.
1,149,836. STOWAWAY. INT. CL. 20. REG. 3-31-1981.
1,149,843. TROPIC MAGE (STYLIZED). INT. CL. 20. REG. 3-31-1981.
1,149,849. COMFORT RISE. INT. CL. 20. REG. 3-31-1981.
1,149,852. TIGER STRIPE. INT. CL. 21. REG. 3-31-1981.
1,149,853. SPONGERAMA. INT. CL. 21. REG. 3-31-1981.
1,149,854. CAMEOS. INT. CL. 21. REG. 3-31-1981.
1,149,855. DECOR-AIDE. INT. CL. 21. REG. 3-31-1981.
1,149,856. FAST BACK SPONGE. INT. CL. 21. REG. 3-31-1981.
1,149,857. THE CANNERY. INT. CL. 21. REG. 3-31-1981.
1,149,867. SAS AND DESIGN. INT. CL. 24. REG. 3-31-1981.
1,149,873. THE DOUBLE 1 ACK-TI-LINING, INC. AND DESIGN. INT. CL. 24. REG. 3-31-1981.
1,149,882. LITTLE DIPPERS AND DESIGN. INT. CL. 25. REG. 3-31-1981.
1,149,884. NB NANI BON (STYLIZED). INT. CL. 25. REG. 3-31-1981.
1,149,887. OMO NORMA KAMALI (STYLIZED). INT. CLS. 25 AND 42. REG. 3-31-1981.
1,149,889. CHAUVIN. INT. CL. 25. REG. 3-31-1981.
1,149,895. VALU PLUS. INT. CL. 25. REG. 3-31-1981.
1,149,901. SUNLIGHTS. INT. CL. 25. REG. 3-31-1981.
1,149,903. INCOGNITO. INT. CL. 25. REG. 3-31-1981.
1,149,910. HAND 'N HAND (STYLIZED). INT. CL. 25. REG. 3-31-1981.
1,149,914. FOX VALLEY. INT. CL. 25. REG. 3-31-1981.
1,149,918. PRETTY PRO. INT. CL. 25. REG. 3-31-1981.
1,149,919. PRETTY SHAPELY. INT. CL. 25. REG. 3-31-1981.
1,149,922. LAMMERTZ NADELN AND DESIGN. INT. CL. 26. REG. 3-31-1981.
1,149,925. ROMAN CASCADE. INT. CL. 26. REG. 3-31-1981.
1,149,928. NATURE'S COVERINGS. INT. CL. 27. REG. 3-31-1981.
1,149,952. STAR BIRD. INT. CL. 28. REG. 3-31-1981.
1,149,954. PAK-GAMMON. INT. CL. 28. REG. 3-31-1981.
1,149,959. PRO COMBO. INT. CL. 28. REG. 3-31-1981.
1,149,961. FUNFISH. INT. CL. 28. REG. 3-31-1981.
1,149,965. PONDEROSA STEAKHOUSE. INT. CLS. 29 AND 30. REG. 3-31-1981.
1,149,970. GRECIAN DELIGHT AND DESIGN. INT. CL. 29. REG. 3-31-1981.
1,149,972. LOVEBIRD CUTLETS. INT. CL. 29. REG. 3-31-1981.
1,149,977. BIG BUBBLES-NO TROUBLES. INT. CL. 30. REG. 3-31-1981.
1,149,978. S & B GOLDEN (STYLIZED). INT. CL. 30. REG. 3-31-1981.
1,149,979. POPSICLE PIE. INT. CL. 30. REG. 3-31-1981.
1,149,980. FUDGSICLE PIE. INT. CL. 30. REG. 3-31-1981.
1,149,984. FASHION PARADE. INT. CL. 31. REG. 3-31-1981.
1,149,985. GARDEN EXCELLENCY. INT. CL. 31. REG. 3-31-1981.
1,149,986. AMERICANA. INT. CL. 31. REG. 3-31-1981.
1,149,987. ACROSS. INT. CL. 31. REG. 3-31-1981.
1,149,999. PREXY KF AND DESIGN. INT. CL. 31. REG. 3-31-1981.
1,150,005. SPORT SHACK. INT. CL. 35. REG. 3-31-1981.
1,150,011. DATAVEND (STYLIZED). INT. CL. 35. REG. 3-31-1981.

- 1,150,012. WA (STYLIZED). INT. CLS. 35 AND 36. REG. 3-31-1981.
- 1,150,018. RAINIER (STYLIZED). INT. CLS. 36 AND 42. REG. 3-31-1981.
- 1,150,019. UNION BANKABOUT (STYLIZED). INT. CL. 36. REG. 3-31-1981.
- 1,150,021. FLORIDA FEDERAL SAVINGS AND DESIGN. INT. CL. 36. REG. 3-31-1981.
- 1,150,025. THE UNIVERSE LIFE INSURANCE COMPANY AND DESIGN. INT. CL. 36. REG. 3-31-1981.
- 1,150,026. TEMP. INT. CL. 36. REG. 3-31-1981.
- 1,150,028. M AND DESIGN. INT. CL. 36. REG. 3-31-1981.
- 1,150,029. ALPHAKEY. INT. CL. 37. REG. 3-31-1981.
- 1,150,043. JET COLOR LAB (STYLIZED). INT. CL. 40. REG. 3-31-1981.
- 1,150,055. PARK AVENUE AND DESIGN. INT. CL. 41. REG. 3-31-1981.
- 1,150,057. JEWELCOR JEWELERS DISTRIBUTORS (STYLIZED). INT. CL. 42. REG. 3-31-1981.
- 1,150,065. TERRA. INT. CL. 42. REG. 3-31-1981.
- 1,150,066. SOUNDS GREAT. INT. CL. 42. REG. 3-31-1981.
- 1,150,071. ? AND DESIGN. INT. CL. 42. REG. 3-31-1981.
- 1,150,078. THE PAWNSHOP AND DESIGN. INT. CL. 42. REG. 3-31-1981.
- 1,150,082. NANCY REYNOLDS FASHION FINDS. INT. CL. 42. REG. 3-31-1981.
- 1,150,083. APARACOR. INT. CL. 42. REG. 3-31-1981.
- 1,150,084. HULA HUT AND DESIGN. INT. CL. 42. REG. 3-31-1981.
- 1,150,085. GOLD KIST. INT. CL. 42. REG. 3-31-1981.
- 1,150,088. BED & BREAKFAST INTERNATIONAL (STYLIZED). INT. CL. 42. REG. 3-31-1981.
- 1,150,090. RVP AND DESIGN. INT. CL. 42. REG. 3-31-1981.
- 1,150,095. DERMATRACK. INT. CL. 42. REG. 3-31-1981.
- 1,150,096. MOUSETRAP CHEESE. INT. CL. 42. REG. 3-31-1981.
- 1,150,097. MISCELLANEOUS DESIGN. INT. CL. 42. REG. 3-31-1981.
- 1,150,099. QUAIL WAGON. INT. CL. 42. REG. 3-31-1981.
- 1,165,132. LUCILLE ROBERTS. INT. CLS. 3, 5 AND 25 ONLY. REG. 8-18-1981.
- 1,170,959. TAB. INT. CL. 9 ONLY. REG. 9-29-1981.
- 1,174,140. ADVERTISING SPECIALTY REGISTER. INT. CL. 35 ONLY. REG. 10-20-1981.
- 1,190,244. OLD CHICAGO. INT. CL. 41 ONLY. REG. 2-16-1982.
- 1,192,225. SNOQUALMIE FALLS LODGE. INT. CL. 29 ONLY. REG. 3-16-1982.
- 1,571,514. AMORESSE. INT. CL. 3. REG. 12-19-1989.
- 1,622,606. BBC AND DESIGN. INT. CLS. 25 AND 42. REG. 11-13-1990.
- 1,630,154. PAINTED DESERT. INT. CL. 25. REG. 1-1-1991.
- 1,638,781. TOTALIDE. INT. CL. 1. REG. 3-26-1991.
- 1,638,785. K-19. INT. CL. 1. REG. 3-26-1991.
- 1,638,788. STEPPEZ. INT. CL. 1. REG. 3-26-1991.
- 1,638,799. PHOENIX. INT. CL. 2. REG. 3-26-1991.
- 1,638,802. MONEY HOUSE BLESSING STICK INCENSE 22 STICKS AND DESIGN. INT. CL. 3. REG. 3-26-1991.
- 1,638,807. STEPWAX. INT. CL. 3. REG. 3-26-1991.
- 1,638,809. VISIBLE YOUTH. INT. CLS. 3 AND 5. REG. 3-26-1991.
- 1,638,823. SEAL AND SHINE (STYLIZED). INT. CL. 3. REG. 3-26-1991.
- 1,638,847. AALBA DENT AND DESIGN. INT. CL. 5. REG. 3-26-1991.
- 1,638,866. LACTAMAX. INT. CL. 5. REG. 3-26-1991.
- 1,638,873. REPUBLIC ENGINEERED STEELS AND DESIGN. INT. CL. 6. REG. 3-26-1991.
- 1,638,874. REPUBLIC ENGINEERED STEELS. INT. CL. 6. REG. 3-26-1991.
- 1,638,883. MOBILE TECHNOLOGIES. INT. CL. 7. REG. 3-26-1991.
- 1,638,886. WINNER AND DESIGN. INT. CLS. 7, 9 AND 11. REG. 3-26-1991.
- 1,638,891. S OBERDORFER AND DESIGN. INT. CL. 7. REG. 3-26-1991.
- 1,638,896. CROSS-FIRE (STYLIZED). INT. CL. 7. REG. 3-26-1991.
- 1,638,899. MICRO-MITE. INT. CL. 7. REG. 3-26-1991.
- 1,638,907. SILK-EPIL (STYLIZED). INT. CL. 8. REG. 3-26-1991.
- 1,638,926. PLASMADOME. INT. CL. 9. REG. 3-26-1991.
- 1,638,927. SFA (STYLIZED). INT. CLS. 9 AND 42. REG. 3-26-1991.
- 1,638,942. CWC. INT. CL. 9. REG. 3-26-1991.
- 1,638,950. TEL-EASE. INT. CL. 9. REG. 3-26-1991.
- 1,638,952. RASTEROPS. INT. CL. 9. REG. 3-26-1991.
- 1,638,958. ADAPTALERT. INT. CL. 9. REG. 3-26-1991.
- 1,638,962. POWERBASE. INT. CL. 9. REG. 3-26-1991.
- 1,638,975. GRAVATRONIX. INT. CL. 9. REG. 3-26-1991.
- 1,638,982. HANAUCHROME. INT. CL. 10. REG. 3-26-1991.
- 1,638,983. SCRINET. INT. CL. 10. REG. 3-26-1991.
- 1,638,988. PRX (STYLIZED). INT. CL. 10. REG. 3-26-1991.
- 1,638,989. HUGGIE AIDS AND DESIGN. INT. CL. 10. REG. 3-26-1991.
- 1,638,995. LOKSHOT (STYLIZED). INT. CL. 10. REG. 3-26-1991.
- 1,639,005. MASTERPIECE IRIS. INT. CL. 11. REG. 3-26-1991.
- 1,639,013. WORLD-CLASS. INT. CL. 12. REG. 3-26-1991.
- 1,639,017. SKY COMMUTER AND DESIGN. INT. CL. 12. REG. 3-26-1991.
- 1,639,018. RYDER COMMAND. INT. CL. 12. REG. 3-26-1991.
- 1,639,019. SUPER 80. INT. CL. 12. REG. 3-26-1991.
- 1,639,025. ACCURIGHT. INT. CL. 13. REG. 3-26-1991.
- 1,639,027. ALEXANDRA COLLECTION (STYLIZED). INT. CL. 14. REG. 3-26-1991.
- 1,639,028. 77 PA. INT. CL. 14. REG. 3-26-1991.
- 1,639,032. SILBER'S AND DESIGN. INT. CL. 14. REG. 3-26-1991.
- 1,639,033. APCO AND DESIGN. INT. CL. 14. REG. 3-26-1991.
- 1,639,040. MISCELLANEOUS DESIGN. INT. CL. 16. REG. 3-26-1991.
- 1,639,047. GEORGE MEANY CENTER FOR LABOR STUDIES AND DESIGN. INT. CLS. 16, 21 AND 25. REG. 3-26-1991.
- 1,639,059. BOHICA AND DESIGN. INT. CL. 16. REG. 3-26-1991.
- 1,639,068. MISCELLANEOUS DESIGN. INT. CLS. 16 AND 42. REG. 3-26-1991.
- 1,639,084. FLO-BALL AND DESIGN. INT. CL. 16. REG. 3-26-1991.
- 1,639,085. POLARIS. INT. CL. 16. REG. 3-26-1991.
- 1,639,086. HAZARDPK. INT. CL. 16. REG. 3-26-1991.
- 1,639,087. IN A CLASS BY YOURSELF. INT. CL. 16. REG. 3-26-1991.
- 1,639,105. QUINTESENCE. INT. CL. 19. REG. 3-26-1991.
- 1,639,106. DOLOFLUX. INT. CL. 19. REG. 3-26-1991.
- 1,639,123. CIT. INT. CL. 21. REG. 3-26-1991.
- 1,639,130. COVINGTON. INT. CL. 24. REG. 3-26-1991.
- 1,639,133. ANNIE OAKLEY AND DESIGN. INT. CL. 25. REG. 3-26-1991.
- 1,639,135. GIULIANA BENETTON (STYLIZED). INT. CL. 25. REG. 3-26-1991.
- 1,639,140. CAT'S MEOW. INT. CL. 25. REG. 3-26-1991.
- 1,639,142. RAY-SUN AND DESIGN. INT. CL. 25. REG. 3-26-1991.
- 1,639,154. SAKS FIFTH AVENUE REAL CLOTHES - NEW YORK AND DESIGN. INT. CL. 25. REG. 3-26-1991.
- 1,639,159. DYNAPRO AND DESIGN. INT. CLS. 25 AND 28. REG. 3-26-1991.
- 1,639,163. CHEYENNE RIDING CLUB. INT. CL. 25. REG. 3-26-1991.
- 1,639,166. LAUREN HANSEN SPORT. INT. CL. 25. REG. 3-26-1991.
- 1,639,167. LA AND DESIGN. INT. CL. 25. REG. 3-26-1991.
- 1,639,170. GRIPS PLUS. INT. CL. 25. REG. 3-26-1991.
- 1,639,171. ALEXANDER JULIAN. INT. CL. 25. REG. 3-26-1991.
- 1,639,173. PRO-ACTION. INT. CL. 25. REG. 3-26-1991.
- 1,639,179. CARLISLE. INT. CL. 27. REG. 3-26-1991.
- 1,639,182. POWERTUNE. INT. CL. 28. REG. 3-26-1991.
- 1,639,184. TR DIAMOND. INT. CL. 28. REG. 3-26-1991.

- 1,639,185. XIII OVER/UNDER 13 AND DESIGN. INT. CL. 28. REG. 3-26-1991.
- 1,639,186. DISCOVERY ZONE AND DESIGN. INT. CL. 28. REG. 3-26-1991.
- 1,639,187. DISCOVERY ZONE. INT. CL. 28. REG. 3-26-1991.
- 1,639,188. SPORTS EXECUTIVE FITNESS AND DESIGN. INT. CL. 28. REG. 3-26-1991.
- 1,639,193. TRIMAX. INT. CL. 28. REG. 3-26-1991.
- 1,639,197. COBBLEVILLE AND DESIGN. INT. CL. 28. REG. 3-26-1991.
- 1,639,221. GRAND PLACE. INT. CL. 30. REG. 3-26-1991.
- 1,639,231. CHOUTEAU. INT. CL. 32. REG. 3-26-1991.
- 1,639,233. SOVARI. INT. CL. 32. REG. 3-26-1991.
- 1,639,235. ISTITUTO ITALIANO SPUMANTE CLASSICO AND DESIGN. INT. CL. 33. REG. 3-26-1991.
- 1,639,256. CB COMMERCIAL. INT. CL. 36. REG. 3-26-1991.
- 1,639,263. PRUTECT-A-CARD. INT. CL. 36. REG. 3-26-1991.
- 1,639,271. WHITEHAWK RANCH. INT. CLS. 37 AND 41. REG. 3-26-1991.
- 1,639,275. COASTAL. INT. CL. 37. REG. 3-26-1991.
- 1,639,276. AVGAS. INT. CL. 37. REG. 3-26-1991.
- 1,639,283. FFANY FASHION MEDAL OF HONOR. INT. CL. 41. REG. 3-26-1991.
- 1,639,289. LM AND DESIGN. INT. CLS. 41 AND 42. REG. 3-26-1991.
- 1,639,297. HEALTH PRESERVATION AUTO-REGULATION NUTRITION STRESS FITNESS ALLERGY & CHEMICALS AND DESIGN. INT. CL. 42. REG. 3-26-1991.
- 1,639,305. TELE-CARDS. INT. CL. 42. REG. 3-26-1991.
- 1,639,309. SAN ANTONIO TACO CO.. INT. CL. 42. REG. 3-26-1991.
- 1,639,311. REX THE ORIGINAL AND DESIGN. INT. CL. 42. REG. 3-26-1991.
- 1,639,313. CONFECTIONATELY YOURS. INT. CL. 42. REG. 3-26-1991.
- 1,639,319. FASHION BUG AND DESIGN. INT. CL. 42. REG. 3-26-1991.
- 1,639,323. YOU'VE GOT TO LOVE US. YOU'VE GOT OUR GUARANTEE.. INT. CL. 42. REG. 3-26-1991.
- 1,639,331. SIGNATURE SERIES AND DESIGN. INT. CL. 6. REG. 3-26-1991.
- 1,639,334. ULTRA HONE AND DESIGN. INT. CL. 7. REG. 3-26-1991.
- 1,639,336. GEMINI. INT. CL. 7. REG. 3-26-1991.
- 1,639,339. GROCERYMASTER. INT. CL. 9. REG. 3-26-1991.
- 1,639,347. TSDS. INT. CL. 9. REG. 3-26-1991.
- 1,639,356. INDY LITE. INT. CL. 12. REG. 3-26-1991.
- 1,639,359. VICTORIA JAMES DESIGNS. INT. CL. 14. REG. 3-26-1991.
- 1,639,367. ZIPPOST. INT. CL. 19. REG. 3-26-1991.
- 1,639,371. HARLEQUIN. INT. CL. 19. REG. 3-26-1991.
- 1,639,394. STERLING. INT. CL. 35. REG. 3-26-1991.
- 1,639,409. NEW TECHNOLOGY RECORDER. INT. CL. 9. REG. 3-26-1991.
- 1,639,412. EVENT VERIFICATION. INT. CL. 9. REG. 3-26-1991.
- 1,639,416. RE:MARKS AND DESIGN. INT. CL. 16. REG. 3-26-1991.
- 1,639,419. INCENTIVE. INT. CL. 16. REG. 3-26-1991.
- 1,639,421. DAIRY PROFIT WEEKLY. INT. CL. 16. REG. 3-26-1991.
- 1,639,422. THE EQUINE ATHLETE. INT. CL. 16. REG. 3-26-1991.
- 1,639,425. TREESHIELD (STYLIZED). INT. CL. 17. REG. 3-26-1991.
- 1,639,432. SEATTLE'S BEST COFFEE. INT. CL. 30. REG. 3-26-1991.
- 1,639,441. HORSES HELPING THE HANDICAPPED TO HEALTH. INT. CL. 41. REG. 3-26-1991.
- 1,652,227. WDB. INT. CL. 9. REG. 7-30-1991.
- 1,674,603. PROFESSIONAL APPLICATOR INSTITUTE. INT. CL. 42 ONLY. REG. 2-4-1992.
- 1,686,128. GARDEN MASTER. INT. CL. 9 ONLY. REG. 5-12-1992.
- 1,817,038. BIG CITY BAGELS. INT. CL. 30. REG. 1-18-1994.
- 1,819,642. HEARTHMASTER. INT. CL. 4. REG. 2-8-1994.
- 1,821,641. WHERE FUN IS SERIOUS BUSINESS. INT. CL. 35. REG. 2-15-1994.
- 1,836,627. BIZWARE. INT. CLS. 9 AND 42. REG. 5-17-1994.
- 1,840,137. CARDPORT. INT. CL. 9. REG. 6-14-1994.
- 1,840,210. FILMKOTE. INT. CL. 1. REG. 6-21-1994.
- 1,843,123. FROM THE EARTH TO THE TABLE. INT. CL. 33. REG. 7-5-1994.
- 1,846,930. MC2 THE MICHAEL CARTER COMPANY (STYLIZED). INT. CL. 35. REG. 7-26-1994.
- 1,851,329. MISCELLANEOUS DESIGN. INT. CL. 9. REG. 8-30-1994.
- 1,853,081. STUDIO. INT. CL. 18. REG. 9-6-1994.
- 1,855,688. DAM. INT. CL. 14. REG. 9-27-1994.
- 1,857,221. VAC N'ZAP. INT. CL. 9. REG. 10-4-1994.
- 1,857,705. BRUCE AMERICAN HOME SERIES AND DESIGN. INT. CL. 19. REG. 10-11-1994.
- 1,858,435. URBAN AUDIO WORKS. INT. CL. 9. REG. 10-18-1994.
- 1,859,469. DYNA TWIST. INT. CL. 7. REG. 10-25-1994.
- 1,860,094. CTI. INT. CL. 42. REG. 10-25-1994.
- 1,862,995. PIRATE SURF. INT. CLS. 18 AND 25. REG. 11-15-1994.
- 1,863,095. MAGNEX 2000. INT. CL. 9. REG. 11-15-1994.
- 1,863,337. 21 SUPER BUCKS. INT. CL. 41. REG. 11-15-1994.
- 1,864,843. BOBOLI. INT. CL. 30. REG. 11-29-1994.
- 1,867,567. SKIN-GARD P.F.. INT. CL. 10. REG. 12-13-1994.
- 1,867,873. BUTT UGLY. INT. CL. 25. REG. 12-13-1994.
- 1,868,121. RC/UPDATE. INT. CL. 9. REG. 12-20-1994.
- 1,868,122. PACKAGE/IT. INT. CL. 9. REG. 12-20-1994.
- 1,868,759. SEAFOOD EXCHANGE AND DESIGN. INT. CL. 42. REG. 12-20-1994.
- 1,869,383. PLATINUM PLAN ANALYZER. INT. CL. 9. REG. 12-27-1994.
- 1,869,384. PLATINUM DETECTOR. INT. CL. 9. REG. 12-27-1994.
- 1,869,385. RC/SECURE. INT. CL. 9. REG. 12-27-1994.
- 1,869,564. ROLLMAPLAST. INT. CLS. 17 AND 19. REG. 12-27-1994.
- 1,869,578. PRADA AND DESIGN. INT. CLS. 18 AND 25. REG. 12-27-1994.
- 1,869,637. LYOCELL BY LENZING AND DESIGN. INT. CLS. 23, 24 AND 25. REG. 12-27-1994.
- 1,870,119. MORRO CASTLE. INT. CL. 42. REG. 12-27-1994.
- 1,870,469. CONTOUR QUALITY LEATHER AND DESIGN. INT. CL. 12. REG. 12-27-1994.
- 1,870,877. SEAFOOD EXCHANGE. INT. CL. 42. REG. 12-27-1994.
- 1,871,014. FIRECONE. INT. CL. 7. REG. 1-3-1995.
- 1,871,212. CMC AND DESIGN. INT. CL. 12. REG. 1-3-1995.
- 1,871,213. C.M.C.. INT. CL. 12. REG. 1-3-1995.
- 1,871,576. C.M.C. AND DESIGN. INT. CL. 37. REG. 1-3-1995.
- 1,872,436. CONSTELACION DE PASATIEMPOS AND DESIGN. INT. CL. 16. REG. 1-10-1995.
- 1,872,558. CODE WEST AND DESIGN. INT. CL. 25. REG. 1-10-1995.
- 1,872,633. AERO TOUCH. INT. CL. 28. REG. 1-10-1995.
- 1,873,410. ACTICAT (STYLIZED). INT. CL. 40. REG. 1-10-1995.
- 1,873,947. HBO (STYLIZED). INT. CL. 25. REG. 1-17-1995.
- 1,874,092. BEGGAR DOG BISCUITS. INT. CL. 31. REG. 1-17-1995.
- 1,875,181. HBO (STYLIZED). INT. CLS. 11, 14, 16, 18, 20, 21, 24 AND 28. REG. 1-24-1995.
- 1,875,627. THE HARTWOOD SHOWJUMPING FESTIVAL AND DESIGN. INT. CL. 41. REG. 1-24-1995.
- 1,875,748. THE ROAD TO BETTER HEALTH. INT. CLS. 29, 30 AND 42. REG. 1-24-1995.
- 1,876,049. VERO. INT. CL. 30. REG. 1-24-1995.
- 1,876,684. SONATA. INT. CL. 21. REG. 1-31-1995.
- 1,877,045. AMERICA'S BOOTMAKER. INT. CL. 42. REG. 1-31-1995.
- 1,877,986. PERMA-DRY. INT. CL. 37. REG. 2-7-1995.
- 1,879,336. SILK AIR AND DESIGN. INT. CL. 39. REG. 2-14-1995.
- 1,880,436. SX-9000. INT. CL. 9. REG. 2-28-1995.
- 1,880,895. THE COLLISION SHOP AND DESIGN. INT. CL. 37. REG. 2-28-1995.

- 1,880,936. RADIO HULA. INT. CLS. 41 AND 42. REG. 2-28-1995.
- 1,881,376. C AND DESIGN. INT. CL. 10. REG. 2-28-1995.
- 1,882,001. PRINCIPLE-CENTERED LEADERSHIP. INT. CL. 9. REG. 3-7-1995.
- 1,882,693. WEIGHT WISE. INT. CL. 42. REG. 3-7-1995.
- 1,883,081. LEMONIADA AND DESIGN. INT. CL. 32. REG. 3-7-1995.
- 1,883,139. RICOCHET. INT. CL. 41. REG. 3-7-1995.
- 1,883,426. ACCUMART. INT. CL. 9. REG. 3-14-1995.
- 1,885,732. DIAPEUTIC. INT. CLS. 1 AND 5. REG. 3-28-1995.
- 1,885,733. DECAPOL. INT. CL. 1. REG. 3-28-1995.
- 1,885,734. EXTREME 4/50 (STYLIZED). INT. CL. 1. REG. 3-28-1995.
- 1,885,736. CHEMETALS (STYLIZED). INT. CL. 1. REG. 3-28-1995.
- 1,885,738. LASERWRITER. INT. CL. 1. REG. 3-28-1995.
- 1,885,739. STARMAG (STYLIZED). INT. CL. 1. REG. 3-28-1995.
- 1,885,745. UT-X. INT. CL. 1. REG. 3-28-1995.
- 1,885,746. HAZ-SEAL. INT. CL. 1. REG. 3-28-1995.
- 1,885,747. SOLIDRY. INT. CL. 1. REG. 3-28-1995.
- 1,885,751. STONE CRAFT. INT. CL. 2. REG. 3-28-1995.
- 1,885,753. MAX-LPRO. INT. CL. 2. REG. 3-28-1995.
- 1,885,755. SILPRIME. INT. CL. 2. REG. 3-28-1995.
- 1,885,758. COLOR-CARE. INT. CL. 3. REG. 3-28-1995.
- 1,885,759. HELIX. INT. CL. 3. REG. 3-28-1995.
- 1,885,761. KEMI LABORATORIES PRO-CIDIC-PLUS RINSE AND DESIGN. INT. CL. 3. REG. 3-28-1995.
- 1,885,762. KEMI LABORATORIES KEMI-AMINO NO-SOAP SHAMPOO AND DESIGN. INT. CL. 3. REG. 3-28-1995.
- 1,885,763. LYRA AND DESIGN. INT. CL. 3. REG. 3-28-1995.
- 1,885,766. SUPERSYNDIA. INT. CL. 3. REG. 3-28-1995.
- 1,885,768. DT-88 AND DESIGN. INT. CLS. 3 AND 4. REG. 3-28-1995.
- 1,885,772. COLORS O' PASSION. INT. CL. 3. REG. 3-28-1995.
- 1,885,774. SANBACT (STYLIZED). INT. CL. 5. REG. 3-28-1995.
- 1,885,775. ANDROMACO. INT. CL. 5. REG. 3-28-1995.
- 1,885,778. GLUIMMUN. INT. CL. 5. REG. 3-28-1995.
- 1,885,780. ALWAYS NATURAL PRODUCTS BIOMAX FOR MAXIMUM VITALITY AND DESIGN. INT. CL. 5. REG. 3-28-1995.
- 1,885,781. NUTRITIONAL SUPPLEMENTS FOR PEAK PERFORMANCE QUIKPIK SINGLE SERVING SIZE STRENGTH SYSTEMS USA AND DESIGN. INT. CL. 5. REG. 3-28-1995.
- 1,885,782. CLINTEC AND DESIGN. INT. CLS. 5, 9 AND 10. REG. 3-28-1995.
- 1,885,783. GEAVIT. INT. CL. 5. REG. 3-28-1995.
- 1,885,784. MISCELLANEOUS DESIGN. INT. CL. 5. REG. 3-28-1995.
- 1,885,786. IPRIUM TURBUHALER. INT. CL. 5. REG. 3-28-1995.
- 1,885,787. SYMBICORT. INT. CL. 5. REG. 3-28-1995.
- 1,885,789. HEART FOODS AND DESIGN. INT. CL. 5. REG. 3-28-1995.
- 1,885,797. IMPERIAL. INT. CLS. 6 AND 16. REG. 3-28-1995.
- 1,885,799. FR AND DESIGN. INT. CL. 6. REG. 3-28-1995.
- 1,885,800. TORPEDO AND DESIGN. INT. CL. 6. REG. 3-28-1995.
- 1,885,801. MISCELLANEOUS DESIGN. INT. CL. 6. REG. 3-28-1995.
- 1,885,803. RIVIERA. INT. CL. 6. REG. 3-28-1995.
- 1,885,804. DELTAFLEX. INT. CL. 6. REG. 3-28-1995.
- 1,885,812. PEDROLLO AND DESIGN. INT. CL. 7. REG. 3-28-1995.
- 1,885,815. FLIP TIP. INT. CL. 7. REG. 3-28-1995.
- 1,885,819. FILMAX. INT. CL. 7. REG. 3-28-1995.
- 1,885,821. ROMICRON AND DESIGN. INT. CL. 7. REG. 3-28-1995.
- 1,885,822. ROTOSOLVER. INT. CL. 7. REG. 3-28-1995.
- 1,885,823. ROTOMIXX. INT. CL. 7. REG. 3-28-1995.
- 1,885,825. EASE-ON AND DESIGN. INT. CL. 7. REG. 3-28-1995.
- 1,885,826. STLP AND DESIGN. INT. CL. 7. REG. 3-28-1995.
- 1,885,832. COMB YOUR PET A PERFECT HAIRCUT. INT. CL. 8. REG. 3-28-1995.
- 1,885,833. BAR-TECH. INT. CLS. 8 AND 21. REG. 3-28-1995.
- 1,885,838. DDS DIGITAL DATA STORAGE AND DESIGN. INT. CL. 9. REG. 3-28-1995.
- 1,885,839. SHARP AND DESIGN. INT. CLS. 9 AND 28. REG. 3-28-1995.
- 1,885,842. SKYPOD. INT. CL. 9. REG. 3-28-1995.
- 1,885,843. VIRTUAL STORE. INT. CL. 9. REG. 3-28-1995.
- 1,885,845. WATCOM. INT. CLS. 9 AND 16. REG. 3-28-1995.
- 1,885,847. PRODIGY A.R.T. AND DESIGN. INT. CL. 9. REG. 3-28-1995.
- 1,885,848. LIGHTSHIP. INT. CL. 9. REG. 3-28-1995.
- 1,885,849. AN COM AND DESIGN. INT. CL. 9. REG. 3-28-1995.
- 1,885,852. PRIORITY CALL SYSTEM. INT. CL. 9. REG. 3-28-1995.
- 1,885,853. MISCELLANEOUS DESIGN. INT. CL. 9. REG. 3-28-1995.
- 1,885,854. HILITE CALIFORNIA. INT. CL. 9. REG. 3-28-1995.
- 1,885,857. D'ARRIGO (STYLIZED). INT. CL. 9. REG. 3-28-1995.
- 1,885,858. DINVERTER. INT. CL. 9. REG. 3-28-1995.
- 1,885,860. SIMAS. INT. CL. 9. REG. 3-28-1995.
- 1,885,861. SPARCPHONE (STYLIZED). INT. CL. 9. REG. 3-28-1995.
- 1,885,862. LD2 AND DESIGN. INT. CL. 9. REG. 3-28-1995.
- 1,885,864. AE&E AMERICAN ELECTRONICS ENTERTAINMENT (STYLIZED). INT. CL. 9. REG. 3-28-1995.
- 1,885,865. DELTALINK. INT. CL. 9. REG. 3-28-1995.
- 1,885,866. PROCOMPILER. INT. CL. 9. REG. 3-28-1995.
- 1,885,868. EDUSERV OASIS. INT. CL. 9. REG. 3-28-1995.
- 1,885,869. PCVS. INT. CL. 9. REG. 3-28-1995.
- 1,885,870. ESVS. INT. CL. 9. REG. 3-28-1995.
- 1,885,871. COLLEGIATE VALUE PAK AND DESIGN. INT. CL. 9. REG. 3-28-1995.
- 1,885,874. NIGHTVIEW. INT. CL. 9. REG. 3-28-1995.
- 1,885,875. CAPDISC. INT. CLS. 9, 28 AND 42. REG. 3-28-1995.
- 1,885,876. RUFFHOUSE. INT. CL. 9. REG. 3-28-1995.
- 1,885,877. AXACTA. INT. CL. 9. REG. 3-28-1995.
- 1,885,879. ANSCHUTZ (STYLIZED). INT. CL. 9. REG. 3-28-1995.
- 1,885,880. RUFF HOUSE AND DESIGN. INT. CL. 9. REG. 3-28-1995.
- 1,885,885. SHAREWARE AMERICA. INT. CL. 9. REG. 3-28-1995.
- 1,885,887. PROGNOSYS. INT. CL. 9. REG. 3-28-1995.
- 1,885,888. DYNAPACK. INT. CL. 9. REG. 3-28-1995.
- 1,885,889. HOBBY MAXI. INT. CLS. 9 AND 28. REG. 3-28-1995.
- 1,885,890. IMAGE-IN SCANASSIST. INT. CL. 9. REG. 3-28-1995.
- 1,885,891. FOTO FUN XPRESS (STYLIZED). INT. CL. 9. REG. 3-28-1995.
- 1,885,892. PHASTTRANSFER. INT. CL. 9. REG. 3-28-1995.
- 1,885,893. NTDB (STYLIZED). INT. CL. 9. REG. 3-28-1995.
- 1,885,896. PROFESSIONAL PROOFIT. INT. CL. 9. REG. 3-28-1995.
- 1,885,897. PROFESSIONAL STEPIT. INT. CL. 9. REG. 3-28-1995.
- 1,885,898. PROFESSIONAL CURVEIT. INT. CL. 9. REG. 3-28-1995.
- 1,885,899. SIMEASE. INT. CL. 9. REG. 3-28-1995.
- 1,885,900. THE DATABASE CONSOLE. INT. CL. 9. REG. 3-28-1995.
- 1,885,902. SMARTRESERVE. INT. CL. 9. REG. 3-28-1995.
- 1,885,905. MPMUX. INT. CL. 9. REG. 3-28-1995.
- 1,885,906. RAN EXTENDER. INT. CL. 9. REG. 3-28-1995.
- 1,885,907. MPDCP. INT. CL. 9. REG. 3-28-1995.
- 1,885,910. INFOMOVER. INT. CL. 9. REG. 3-28-1995.
- 1,885,911. A AND DESIGN. INT. CL. 9. REG. 3-28-1995.
- 1,885,912. OBJECTLAND. INT. CL. 9. REG. 3-28-1995.
- 1,885,913. AZURE. INT. CL. 9. REG. 3-28-1995.
- 1,885,916. ZANTARES. INT. CL. 9. REG. 3-28-1995.
- 1,885,917. FIBER DOES, INC. AND DESIGN. INT. CL. 9. REG. 3-28-1995.
- 1,885,921. PUSH-NUTS. INT. CL. 9. REG. 3-28-1995.

- 1,885,923. MV BULLETIN BOARD. INT. CL. 9. REG. 3-28-1995.
- 1,885,924. PIE (STYLIZED). INT. CL. 9. REG. 3-28-1995.
- 1,885,926. DYNA-START TRUCK. INT. CL. 9. REG. 3-28-1995.
- 1,885,927. DYNA-START MEGA. INT. CL. 9. REG. 3-28-1995.
- 1,885,929. PROSTATHERMER. INT. CL. 10. REG. 3-28-1995.
- 1,885,930. DIAMOND AND DESIGN. INT. CL. 10. REG. 3-28-1995.
- 1,885,932. ALTRA NOVA. INT. CL. 10. REG. 3-28-1995.
- 1,885,933. ICPI AND DESIGN. INT. CL. 10. REG. 3-28-1995.
- 1,885,934. BRINGING ORTHOPEDICS TO INDUSTRY. INT. CL. 10. REG. 3-28-1995.
- 1,885,937. J-LINE. INT. CL. 10. REG. 3-28-1995.
- 1,885,938. DENTA POPS. INT. CL. 10. REG. 3-28-1995.
- 1,885,942. AMERICAN AIR FILTER SNYDER GENERAL AND DESIGN. INT. CLS. 11 AND 17. REG. 3-28-1995.
- 1,885,943. ATLANTIC COAST LIGHTING AND DESIGN. INT. CL. 11. REG. 3-28-1995.
- 1,885,944. SCOURGUARD (STYLIZED). INT. CL. 11. REG. 3-28-1995.
- 1,885,948. CFG. INT. CL. 11. REG. 3-28-1995.
- 1,885,950. FM XCL. INT. CL. 11. REG. 3-28-1995.
- 1,885,953. MEET THE GRILL OF YOUR DREAMS. INT. CL. 11. REG. 3-28-1995.
- 1,885,961. AMERI S380 AND DESIGN. INT. CL. 12. REG. 3-28-1995.
- 1,885,966. HOOTER. INT. CL. 13. REG. 3-28-1995.
- 1,885,968. .17CCM. INT. CL. 13. REG. 3-28-1995.
- 1,885,969. ANNE GHEZ (STYLIZED). INT. CL. 14. REG. 3-28-1995.
- 1,885,971. ACADEMY. INT. CL. 14. REG. 3-28-1995.
- 1,885,972. TC CORP. INT. CL. 14. REG. 3-28-1995.
- 1,885,973. D AND DESIGN. INT. CLS. 14, 16, 18, 25 AND 34. REG. 3-28-1995.
- 1,885,975. MULTIPLES. INT. CL. 14. REG. 3-28-1995.
- 1,885,980. LIFEPLAN PLUS AND DESIGN. INT. CL. 16. REG. 3-28-1995.
- 1,885,981. PARKER 95. INT. CL. 16. REG. 3-28-1995.
- 1,885,983. HEARTY SCHOOL LUNCH AND DESIGN. INT. CL. 16. REG. 3-28-1995.
- 1,885,984. PHOENIX CARDINALS. INT. CLS. 16 AND 25. REG. 3-28-1995.
- 1,885,985. CUTTING EDGE. INT. CLS. 16, 20 AND 27. REG. 3-28-1995.
- 1,885,986. APPRAP. INT. CL. 16. REG. 3-28-1995.
- 1,885,987. NO MATTER WHAT. INT. CLS. 16 AND 25. REG. 3-28-1995.
- 1,885,990. STARBLAST. INT. CL. 16. REG. 3-28-1995.
- 1,885,994. FUTURE VISION AND DESIGN. INT. CL. 16. REG. 3-28-1995.
- 1,885,995. BLUE INK. INT. CL. 16. REG. 3-28-1995.
- 1,885,997. THE MAN WITHOUT TIE. INT. CL. 16. REG. 3-28-1995.
- 1,885,999. BLOODWOLF. INT. CL. 16. REG. 3-28-1995.
- 1,886,000. DIAMOND STATE. INT. CLS. 16 AND 38. REG. 3-28-1995.
- 1,886,001. ULTIMA WINNER'S GOLD. INT. CL. 16. REG. 3-28-1995.
- 1,886,004. TEAM FAMILY. INT. CL. 16. REG. 3-28-1995.
- 1,886,005. PAPER CHAISE. INT. CL. 16. REG. 3-28-1995.
- 1,886,007. MISCELLANEOUS DESIGN. INT. CL. 16. REG. 3-28-1995.
- 1,886,008. SMARTFRAME. INT. CLS. 16 AND 41. REG. 3-28-1995.
- 1,886,012. SCANRITE. INT. CL. 16. REG. 3-28-1995.
- 1,886,013. SALON DYNAMICS, INC. AND DESIGN. INT. CL. 16. REG. 3-28-1995.
- 1,886,014. P AND DESIGN. INT. CL. 16. REG. 3-28-1995.
- 1,886,019. FFI AND DESIGN. INT. CL. 16. REG. 3-28-1995.
- 1,886,020. BEETHOVEN. INT. CL. 16. REG. 3-28-1995.
- 1,886,022. WESKOTE, INC.. INT. CL. 16. REG. 3-28-1995.
- 1,886,023. HERS. INT. CL. 16. REG. 3-28-1995.
- 1,886,024. IDI INSTANT DRUG INDEX AND DESIGN. INT. CL. 16. REG. 3-28-1995.
- 1,886,030. FLOYD'S. INT. CL. 16. REG. 3-28-1995.
- 1,886,031. RANGER RICK. INT. CL. 16. REG. 3-28-1995.
- 1,886,032. FOX KIDS CLUB AND DESIGN. INT. CL. 16. REG. 3-28-1995.
- 1,886,034. THE FAT DETECTOR. INT. CL. 16. REG. 3-28-1995.
- 1,886,036. INLINER. INT. CL. 17. REG. 3-28-1995.
- 1,886,038. COMPLETE CYCLE PLASTICS. INT. CLS. 17 AND 40. REG. 3-28-1995.
- 1,886,040. ROYALHOTIC. INT. CL. 17. REG. 3-28-1995.
- 1,886,041. FRE. INT. CL. 17. REG. 3-28-1995.
- 1,886,042. DYNEVER. INT. CL. 17. REG. 3-28-1995.
- 1,886,043. EN GARDE (STYLIZED). INT. CL. 17. REG. 3-28-1995.
- 1,886,048. HAZ-PATCH. INT. CL. 17. REG. 3-28-1995.
- 1,886,052. PRO-FIT. INT. CL. 18. REG. 3-28-1995.
- 1,886,054. PAL CARRY ON! AND DESIGN. INT. CL. 18. REG. 3-28-1995.
- 1,886,055. MAYAN HANDCRAFTED LEATHERGEAR NEW ENGLAND, USA AND DESIGN. INT. CL. 18. REG. 3-28-1995.
- 1,886,056. HEAD TURNERS. INT. CLS. 18 AND 25. REG. 3-28-1995.
- 1,886,058. DANIELLA AND DESIGN. INT. CL. 18. REG. 3-28-1995.
- 1,886,060. TRADESMAN VINYL. INT. CL. 19. REG. 3-28-1995.
- 1,886,062. CINCASOLO. INT. CL. 19. REG. 3-28-1995.
- 1,886,063. PET SHAK AND DESIGN. INT. CL. 19. REG. 3-28-1995.
- 1,886,069. NEYVEST. INT. CL. 19. REG. 3-28-1995.
- 1,886,073. RIC. INT. CL. 19. REG. 3-28-1995.
- 1,886,074. V AND DESIGN. INT. CL. 20. REG. 3-28-1995.
- 1,886,075. "TOITY TUNES" AND DESIGN. INT. CL. 20. REG. 3-28-1995.
- 1,886,076. THE SIDEKICK. INT. CL. 20. REG. 3-28-1995.
- 1,886,077. SPECSTONE. INT. CLS. 20 AND 21. REG. 3-28-1995.
- 1,886,078. TENTBED. INT. CL. 20. REG. 3-28-1995.
- 1,886,079. PLAYBED. INT. CL. 20. REG. 3-28-1995.
- 1,886,081. HEAT TO GO. INT. CL. 20. REG. 3-28-1995.
- 1,886,082. SHOWER FLOWER. INT. CL. 21. REG. 3-28-1995.
- 1,886,087. YARDBIRD AND DESIGN. INT. CL. 21. REG. 3-28-1995.
- 1,886,088. SOAPSAFE. INT. CL. 21. REG. 3-28-1995.
- 1,886,089. SWEETPOTS. INT. CL. 21. REG. 3-28-1995.
- 1,886,090. DOUGHMATE. INT. CL. 21. REG. 3-28-1995.
- 1,886,094. VILLA ROSA. INT. CL. 24. REG. 3-28-1995.
- 1,886,096. CHECKMATES (STYLIZED). INT. CL. 24. REG. 3-28-1995.
- 1,886,100. Q (STYLIZED). INT. CLS. 24, 25 AND 28. REG. 3-28-1995.
- 1,886,101. LINEASETA. INT. CL. 24. REG. 3-28-1995.
- 1,886,104. MISCELLANEOUS DESIGN. INT. CL. 25. REG. 3-28-1995.
- 1,886,105. KANGAROOS U.S.A. AND DESIGN. INT. CL. 25. REG. 3-28-1995.
- 1,886,107. KANGAROOS AND DESIGN. INT. CL. 25. REG. 3-28-1995.
- 1,886,109. NAKED COMFORT. INT. CL. 25. REG. 3-28-1995.
- 1,886,110. AFTER SIX (STYLIZED). INT. CL. 25. REG. 3-28-1995.
- 1,886,113. BYRON AND POOLE. INT. CL. 25. REG. 3-28-1995.
- 1,886,119. LONDON CLUB. INT. CL. 25. REG. 3-28-1995.
- 1,886,126. OSKAR ET COMPAGNIE. INT. CL. 25. REG. 3-28-1995.
- 1,886,127. TIP AND DESIGN. INT. CL. 25. REG. 3-28-1995.
- 1,886,129. TOP DAWG HAWAII. INT. CL. 25. REG. 3-28-1995.
- 1,886,136. HATJAXX. INT. CL. 25. REG. 3-28-1995.
- 1,886,137. SOIE AND DESIGN. INT. CL. 25. REG. 3-28-1995.
- 1,886,138. ARROW COLLECTION AND DESIGN. INT. CL. 25. REG. 3-28-1995.
- 1,886,140. LAND-N-LAKES. INT. CL. 25. REG. 3-28-1995.
- 1,886,141. IVLA CASUALWEAR. INT. CL. 25. REG. 3-28-1995.
- 1,886,142. BLUE PINE. INT. CL. 25. REG. 3-28-1995.
- 1,886,143. COMFORT CLOTHES. INT. CL. 25. REG. 3-28-1995.
- 1,886,145. PJ'S 2 GO. INT. CL. 25. REG. 3-28-1995.

- 1,886,149. SHANDLEZ. INT. CL. 25. REG. 3-28-1995.
1,886,150. EREZ LEVY. INT. CL. 25. REG. 3-28-1995.
1,886,151. MISCELLANEOUS DESIGN. INT. CL. 25. REG. 3-28-1995.
1,886,153. MARCO WACHTER. INT. CL. 25. REG. 3-28-1995.
1,886,154. AH-BON. INT. CL. 25. REG. 3-28-1995.
1,886,155. PEDS SELECT. INT. CL. 25. REG. 3-28-1995.
1,886,160. CONTEMPORARY LIFE. INT. CL. 25. REG. 3-28-1995.
1,886,161. E. VOGEL BOOTS & SHOES CUSTOM BOOTS TO MEASURE SINCE 1879 AND DESIGN. INT. CL. 25. REG. 3-28-1995.
1,886,164. BODY STUFF. INT. CL. 25. REG. 3-28-1995.
1,886,165. WORLD EXCHANGE AND DESIGN. INT. CL. 25. REG. 3-28-1995.
1,886,167. MADE TO WORK FOR YOU. INT. CL. 25. REG. 3-28-1995.
1,886,168. HAWKEYE. INT. CL. 25. REG. 3-28-1995.
1,886,169. LE GUIDE. INT. CL. 25. REG. 3-28-1995.
1,886,171. DECAMERA. INT. CL. 25. REG. 3-28-1995.
1,886,173. CRITIQUE. INT. CL. 25. REG. 3-28-1995.
1,886,174. THE BIG SLEEP. INT. CL. 25. REG. 3-28-1995.
1,886,176. CONCEPT 21. INT. CL. 25. REG. 3-28-1995.
1,886,180. LADYWORKS. INT. CL. 26. REG. 3-28-1995.
1,886,181. METROPOLITAN HAIR REPLACEMENT AND DESIGN. INT. CL. 26. REG. 3-28-1995.
1,886,182. FASTICK. INT. CL. 27. REG. 3-28-1995.
1,886,183. GALACTIC TRADERS. INT. CL. 28. REG. 3-28-1995.
1,886,184. PARTY ZONE. INT. CL. 28. REG. 3-28-1995.
1,886,186. FEET BALLS. INT. CL. 28. REG. 3-28-1995.
1,886,188. ROUE AVANT AND DESIGN. INT. CL. 28. REG. 3-28-1995.
1,886,189. PIGGLES. INT. CL. 28. REG. 3-28-1995.
1,886,191. TREE AND TRIM. INT. CL. 28. REG. 3-28-1995.
1,886,193. CHERRY MASTER. INT. CL. 28. REG. 3-28-1995.
1,886,195. NEXT. INT. CL. 28. REG. 3-28-1995.
1,886,198. U-BAIT-UM. INT. CL. 28. REG. 3-28-1995.
1,886,201. BILLIART. INT. CL. 28. REG. 3-28-1995.
1,886,202. SLAMWICH. INT. CL. 28. REG. 3-28-1995.
1,886,205. RAPID-SOUP. INT. CLS. 29, 30 AND 31. REG. 3-28-1995.
1,886,206. BLUE RIDGE BEEFALO AND DESIGN. INT. CL. 29. REG. 3-28-1995.
1,886,207. FLORES AND DESIGN. INT. CLS. 29, 30 AND 32. REG. 3-28-1995.
1,886,208. GOLDEN ROTISSERIE AND DESIGN. INT. CL. 29. REG. 3-28-1995.
1,886,215. GAJUNS AND DESIGN. INT. CL. 29. REG. 3-28-1995.
1,886,217. BONFARE AND DESIGN. INT. CL. 30. REG. 3-28-1995.
1,886,218. CAFE REY AND DESIGN. INT. CL. 30. REG. 3-28-1995.
1,886,221. MISCELLANEOUS DESIGN. INT. CL. 30. REG. 3-28-1995.
1,886,222. BIG K CHEESEBURGER. INT. CL. 30. REG. 3-28-1995.
1,886,223. T-REX CRUNCH. INT. CL. 30. REG. 3-28-1995.
1,886,224. 100% NATURAL TUTERRI'S HANDMADE PASTA AND DESIGN. INT. CL. 30. REG. 3-28-1995.
1,886,233. GOLF PRO NUTRITION BAR AND DESIGN. INT. CL. 30. REG. 3-28-1995.
1,886,235. PASTA SANTA NINFA AND DESIGN. INT. CL. 30. REG. 3-28-1995.
1,886,239. THE PIE LADY AUTHENTIC SEAL OF QUALITY "A TASTE OF EXCELLENCE" AND DESIGN. INT. CL. 30. REG. 3-28-1995.
1,886,240. PASTAIO. INT. CL. 30. REG. 3-28-1995.
1,886,241. PASTAIO BRAND A TRADITION OF HOME-MADE QUALITY PREMIUM QUALITY AND DESIGN. INT. CL. 30. REG. 3-28-1995.
1,886,242. MULBERRY CHOCOLATES. INT. CL. 30. REG. 3-28-1995.
1,886,244. K-9 FEAST. INT. CL. 31. REG. 3-28-1995.
1,886,245. CUMA (STYLIZED). INT. CL. 31. REG. 3-28-1995.
1,886,250. (QING DAO) LAO QUAN BIERE BEER AND DESIGN. INT. CL. 32. REG. 3-28-1995.
1,886,251. GOLDEN LION PREMIUM MALT LIQUOR AND DESIGN. INT. CL. 32. REG. 3-28-1995.
1,886,255. LOCKE'S OLD KILBEGGAN EST. 1757 AND DESIGN. INT. CL. 33. REG. 3-28-1995.
1,886,259. VOYAGEUR. INT. CL. 34. REG. 3-28-1995.
1,886,261. HYPERREALITY. INT. CLS. 35 AND 41. REG. 3-28-1995.
1,886,262. ACCENT ON DESIGN - WEST. INT. CL. 35. REG. 3-28-1995.
1,886,265. CALIFORNIA GOLD AND DESIGN. INT. CL. 35. REG. 3-28-1995.
1,886,266. EXPORAIL. INT. CL. 35. REG. 3-28-1995.
1,886,267. DR DIRECT TO RETAIL AND DESIGN. INT. CL. 35. REG. 3-28-1995.
1,886,268. EMDS. INT. CL. 35. REG. 3-28-1995.
1,886,269. KEENPEX AND DESIGN. INT. CL. 35. REG. 3-28-1995.
1,886,270. FIRST RUN. INT. CL. 35. REG. 3-28-1995.
1,886,271. NEW LEAF. INT. CL. 35. REG. 3-28-1995.
1,886,273. CONSTRUCTION MARKET INTELLIGENCE. INT. CL. 35. REG. 3-28-1995.
1,886,274. GOLDEN DISCOUNTS INCORPORATED AND DESIGN. INT. CL. 35. REG. 3-28-1995.
1,886,277. MOSBY DOCUMENT EXPRESS. INT. CL. 35. REG. 3-28-1995.
1,886,278. PAINT THE TOWN RED, INC.. INT. CLS. 35 AND 41. REG. 3-28-1995.
1,886,279. ALIGN AND DESIGN. INT. CL. 35. REG. 3-28-1995.
1,886,281. NAVIGISTICS. INT. CL. 35. REG. 3-28-1995.
1,886,282. OPTIONS PLUS (STYLIZED). INT. CL. 36. REG. 3-28-1995.
1,886,284. SIGNATURE CARD. INT. CL. 36. REG. 3-28-1995.
1,886,286. 401(K) 2020 AND DESIGN. INT. CL. 36. REG. 3-28-1995.
1,886,287. INSU AMERICA AND DESIGN. INT. CL. 36. REG. 3-28-1995.
1,886,289. PARTNERSHOPS. INT. CL. 36. REG. 3-28-1995.
1,886,290. LIFELINE. INT. CL. 36. REG. 3-28-1995.
1,886,291. CONCERT CAPITAL MANAGEMENT, INC. AND DESIGN. INT. CL. 36. REG. 3-28-1995.
1,886,294. MISCELLANEOUS DESIGN. INT. CL. 36. REG. 3-28-1995.
1,886,295. SAGE (STYLIZED). INT. CL. 36. REG. 3-28-1995.
1,886,298. CHIMP CHAMPS BANDING TOGETHER CAN MAKE A WORLD OF DIFFERENCE. INT. CL. 36. REG. 3-28-1995.
1,886,299. INSTA-LEASE. INT. CL. 36. REG. 3-28-1995.
1,886,300. THE ESCALATOR ACCOUNT. INT. CL. 36. REG. 3-28-1995.
1,886,301. HOUSEHOLD. FOR THE BUSINESS OF LIVING.. INT. CL. 36. REG. 3-28-1995.
1,886,303. ORB US GOLD AND DESIGN. INT. CL. 36. REG. 3-28-1995.
1,886,304. RETIREMENT INTEGRITY FOR THOSE WHO SERVE. INT. CL. 36. REG. 3-28-1995.
1,886,306. OUR LIFETIME PROMISE: YOUR CUSTOMERS' LIFESTYLE SECURITY. INT. CL. 36. REG. 3-28-1995.
1,886,311. FIRST VALLEY PREFERRED 50 GOLD. INT. CL. 36. REG. 3-28-1995.
1,886,312. FIRST VALLEY PREFERRED 50. INT. CL. 36. REG. 3-28-1995.
1,886,316. MISCELLANEOUS DESIGN. INT. CL. 36. REG. 3-28-1995.
1,886,317. CLOVERBELT CREDIT UNION AND DESIGN. INT. CL. 36. REG. 3-28-1995.
1,886,318. WHAT MAKES US DIFFERENT, MAKES US BETTER!. INT. CL. 36. REG. 3-28-1995.
1,886,319. GOLDRUSH. INT. CL. 36. REG. 3-28-1995.
1,886,322. GORILLA (STYLIZED). INT. CLS. 37 AND 42. REG. 3-28-1995.
1,886,323. GORILLA BICYCLE & FITNESS AND DESIGN. INT. CLS. 37 AND 42. REG. 3-28-1995.
1,886,324. CDR CONSTRUCTION DISPUTE RESOLUTION. INT. CL. 37. REG. 3-28-1995.
1,886,326. P FIXX-A-DENT AND DESIGN. INT. CL. 37. REG. 3-28-1995.

- 1,886,327. ADCOURT AND DESIGN. INT. CL. 37. REG. 3-28-1995.
- 1,886,328. PAINTER ONE. INT. CL. 37. REG. 3-28-1995.
- 1,886,331. AM ABLE, INC. AND DESIGN. INT. CL. 37. REG. 3-28-1995.
- 1,886,332. WANTED! YOU...WITH THE CLUTTERED CLOSET REWARD AND DESIGN. INT. CL. 37. REG. 3-28-1995.
- 1,886,334. RADIO RITMO. INT. CL. 38. REG. 3-28-1995.
- 1,886,335. COMPASS AND DESIGN. INT. CL. 38. REG. 3-28-1995.
- 1,886,337. PSINET AND DESIGN. INT. CL. 38. REG. 3-28-1995.
- 1,886,339. EASYANSWER. INT. CL. 38. REG. 3-28-1995.
- 1,886,340. 96 DAYS OF SUMMER. INT. CL. 38. REG. 3-28-1995.
- 1,886,345. RID-O-VIT AND DESIGN. INT. CL. 39. REG. 3-28-1995.
- 1,886,348. IMAGES SEALED ART. INT. CL. 40. REG. 3-28-1995.
- 1,886,351. MICROTRAINING PLUS (STYLIZED). INT. CL. 41. REG. 3-28-1995.
- 1,886,353. LIFECRAFT. INT. CL. 41. REG. 3-28-1995.
- 1,886,355. ACUTE CARE SPECIALISTS EMERGENCY MEDICINE INSTITUTE AND DESIGN. INT. CL. 41. REG. 3-28-1995.
- 1,886,356. TLK - THE TALK CHANNEL. INT. CL. 41. REG. 3-28-1995.
- 1,886,358. CANAD CINEMAS C AND DESIGN. INT. CL. 41. REG. 3-28-1995.
- 1,886,360. LIMESTONE ROME AND DESIGN. INT. CL. 41. REG. 3-28-1995.
- 1,886,361. THE DOWNTOWN TOOTSIE'S SALOON AND DESIGN. INT. CLS. 41 AND 42. REG. 3-28-1995.
- 1,886,363. SUPERSTAR. INT. CL. 41. REG. 3-28-1995.
- 1,886,365. THE KINGS MESSENGERS CHURCHES REVIVALS CONCERTS AND DESIGN. INT. CL. 41. REG. 3-28-1995.
- 1,886,367. THE HATTERS (STYLIZED). INT. CL. 41. REG. 3-28-1995.
- 1,886,368. GET READY MINISTRIES. INT. CL. 41. REG. 3-28-1995.
- 1,886,369. ZOO TO YOU. INT. CL. 41. REG. 3-28-1995.
- 1,886,370. GREAT INTERNATIONAL TOON IN. INT. CL. 41. REG. 3-28-1995.
- 1,886,376. VEGETABLE JUSTICE. INT. CL. 41. REG. 3-28-1995.
- 1,886,379. AQUANTA AND DESIGN. INT. CL. 41. REG. 3-28-1995.
- 1,886,381. HEAVISIDE LAYER. INT. CL. 41. REG. 3-28-1995.
- 1,886,382. MOBY GRAPE. INT. CL. 41. REG. 3-28-1995.
- 1,886,383. NEGOTIATING IN THE 21ST CENTURY. INT. CL. 41. REG. 3-28-1995.
- 1,886,385. MAGIC FINGERS. INT. CL. 41. REG. 3-28-1995.
- 1,886,387. MISCELLANEOUS DESIGN. INT. CL. 41. REG. 3-28-1995.
- 1,886,388. KIDSTITUTE. INT. CL. 41. REG. 3-28-1995.
- 1,886,389. PERFORMANCE CHALLENGE. INT. CL. 41. REG. 3-28-1995.
- 1,886,392. WORLD RHYTHM CENTER. INT. CL. 41. REG. 3-28-1995.
- 1,886,397. TASTY BASKET AND DESIGN. INT. CL. 42. REG. 3-28-1995.
- 1,886,399. THE GREAT COFFEE CO. AND DESIGN. INT. CL. 42. REG. 3-28-1995.
- 1,886,401. CYLIXALLIANCE. INT. CL. 42. REG. 3-28-1995.
- 1,886,402. MISCELLANEOUS DESIGN. INT. CL. 42. REG. 3-28-1995.
- 1,886,405. E FLORIDA EYE CENTER AND DESIGN. INT. CL. 42. REG. 3-28-1995.
- 1,886,408. PIZZETTI'S. INT. CL. 42. REG. 3-28-1995.
- 1,886,409. LINEAGE. INT. CL. 42. REG. 3-28-1995.
- 1,886,411. TOVON & CO.. INT. CL. 42. REG. 3-28-1995.
- 1,886,412. NCD AND DESIGN. INT. CL. 42. REG. 3-28-1995.
- 1,886,414. MISCELLANEOUS DESIGN. INT. CL. 42. REG. 3-28-1995.
- 1,886,416. POWERED BY PASTA JAY'S. INT. CL. 42. REG. 3-28-1995.
- 1,886,417. MOUNTAIN VIEW DESIGNS. INT. CL. 42. REG. 3-28-1995.
- 1,886,424. JACKEROOS DOWN UNDER ADVENTUROUS SPORTSWEAR AND DESIGN. INT. CL. 42. REG. 3-28-1995.
- 1,886,429. U.M.I. RACING USA...FOR THE UNCOMMON. INT. CL. 42. REG. 3-28-1995.
- 1,886,431. AMCEST NATION WIDE ALARM MONITORING AND DESIGN. INT. CL. 42. REG. 3-28-1995.
- 1,886,434. B.T.O.. INT. CL. 42. REG. 3-28-1995.
- 1,886,435. ALL EARS BOOKS AND MUSIC ON CASSETTE AND CD FOR ALL AGES AND DESIGN. INT. CL. 42. REG. 3-28-1995.
- 1,886,437. XENOGLASIC. INT. CL. 42. REG. 3-28-1995.
- 1,886,438. ANOTHER DAY ANOTHER DEAL. INT. CL. 42. REG. 3-28-1995.
- 1,886,440. THE CRY OF THE EAGLE AND DESIGN. INT. CL. 42. REG. 3-28-1995.
- 1,886,441. SEGURIDAD AL VOLANTE. INT. CL. 42. REG. 3-28-1995.
- 1,886,442. THE BOX TREE. INT. CL. 42. REG. 3-28-1995.
- 1,886,450. THE WOMEN'S INTERNATIONAL MOTORSPORT ASSOCIATION, INC. AND DESIGN. INT. CL. 42. REG. 3-28-1995.
- 1,886,451. RADIO SHACK GIFT EXPRESS. INT. CL. 42. REG. 3-28-1995.
- 1,886,452. ABBEY ROAD TAVERN AND DESIGN. INT. CL. 42. REG. 3-28-1995.
- 1,886,454. MCGUINNESS FUNERAL HOMES AND DESIGN. INT. CL. 42. REG. 3-28-1995.
- 1,886,455. DIGI-COLORADO AND DESIGN. INT. CL. 42. REG. 3-28-1995.
- 1,886,456. CON QUIP AND DESIGN. INT. CL. 42. REG. 3-28-1995.
- 1,886,459. THE IMAGE GURU. INT. CL. 42. REG. 3-28-1995.
- 1,886,460. THIEF OF HEARTS. INT. CL. 42. REG. 3-28-1995.
- 1,886,462. CART STUFFER SPECIALS AND DESIGN. INT. CL. 42. REG. 3-28-1995.
- 1,886,463. IEIS. INT. CL. 42. REG. 3-28-1995.
- 1,886,464. T AND DESIGN. INT. CL. 42. REG. 3-28-1995.
- 1,886,465. ALUMNI ADVANTAGE. INT. CL. 42. REG. 3-28-1995.
- 1,886,467. AMERICAN BOARD OF CERTIFIED MANAGED CARE PROVIDERS AND DESIGN. U.S. CL. B. REG. 3-28-1995.
- 1,886,472. SUPER CHOICE VALUE & SAVINGS AND DESIGN. INT. CLS. 3, 4, 5, 6, 8, 16, 29, 30, 31 AND 32. REG. 3-28-1995.
- 1,886,477. ZEI. INT. CLS. 41 AND 42. REG. 3-28-1995.
- 1,886,478. REAL ESTATE EFFICIENCY SYSTEMS. INT. CLS. 9, 16 AND 41. REG. 3-28-1995.
- 1,886,481. VIRTUAL ADVENTURES. INT. CLS. 28 AND 41. REG. 3-28-1995.
- 1,886,482. ERGOLINE. INT. CLS. 10 AND 11. REG. 3-28-1995.
- 1,886,485. MEDPOWER (STYLIZED). INT. CLS. 35 AND 36. REG. 3-28-1995.
- 1,886,486. SWEET THOUGHTS. INT. CLS. 16 AND 30. REG. 3-28-1995.
- 1,886,487. COFFEE SERVICE & MORE AND DESIGN. INT. CLS. 29, 30 AND 42. REG. 3-28-1995.
- 1,886,491. SERT. INT. CL. 1. REG. 3-28-1995.
- 1,886,494. BUCKSHOT. INT. CL. 1. REG. 3-28-1995.
- 1,886,497. BIOSAND BEADS. INT. CL. 1. REG. 3-28-1995.
- 1,886,499. CHIP SHOT. INT. CL. 1. REG. 3-28-1995.
- 1,886,503. BODY PRINCIPLES. INT. CL. 3. REG. 3-28-1995.
- 1,886,508. RELIEFMIST. INT. CL. 5. REG. 3-28-1995.
- 1,886,511. GALVINSITE. INT. CL. 6. REG. 3-28-1995.
- 1,886,516. TURBO-THREAD. INT. CL. 7. REG. 3-28-1995.
- 1,886,517. DURABELT. INT. CL. 7. REG. 3-28-1995.
- 1,886,518. VALU-LIFT. INT. CL. 7. REG. 3-28-1995.
- 1,886,519. LENTEX (STYLIZED). INT. CL. 7. REG. 3-28-1995.
- 1,886,520. MASTER SERIES. INT. CL. 8. REG. 3-28-1995.
- 1,886,521. BARBER BASICS. INT. CL. 8. REG. 3-28-1995.
- 1,886,526. BACKPAK. INT. CL. 9. REG. 3-28-1995.
- 1,886,531. AEGIS. INT. CL. 9. REG. 3-28-1995.
- 1,886,532. OASIS. INT. CL. 9. REG. 3-28-1995.
- 1,886,533. GUARDIAN ANGEL. INT. CL. 9. REG. 3-28-1995.

- 1,886,535. BEAM SHOT AND DESIGN. INT. CL. 9. REG. 3-28-1995.
- 1,886,536. ENVIRO-MAIL. INT. CL. 9. REG. 3-28-1995.
- 1,886,537. PLATES VEHICLE LICENSING AND DESIGN. INT. CL. 9. REG. 3-28-1995.
- 1,886,539. NEARNET. INT. CL. 9. REG. 3-28-1995.
- 1,886,540. LAZYKEYS. INT. CL. 9. REG. 3-28-1995.
- 1,886,544. EDT. INT. CL. 9. REG. 3-28-1995.
- 1,886,545. FIBERGUIDANCE. INT. CL. 9. REG. 3-28-1995.
- 1,886,548. PLAY IT BY EAR. INT. CL. 9. REG. 3-28-1995.
- 1,886,549. TCRT. INT. CL. 9. REG. 3-28-1995.
- 1,886,551. PLUMB-EASY. INT. CL. 9. REG. 3-28-1995.
- 1,886,553. INTEGRATION FINANCIAL SYSTEMS. INT. CL. 9. REG. 3-28-1995.
- 1,886,554. DATAPAD. INT. CL. 9. REG. 3-28-1995.
- 1,886,555. THE WINNER. INT. CL. 9. REG. 3-28-1995.
- 1,886,556. AZUR (STYLIZED). INT. CL. 9. REG. 3-28-1995.
- 1,886,558. CHECKVISION. INT. CL. 9. REG. 3-28-1995.
- 1,886,559. CREATIVE GALLERY. INT. CL. 9. REG. 3-28-1995.
- 1,886,560. OXYMORON. INT. CL. 9. REG. 3-28-1995.
- 1,886,561. WE MAKE WORK FUN. INT. CL. 9. REG. 3-28-1995.
- 1,886,562. QUALITY WITHOUT COMPROMISE. INT. CL. 9. REG. 3-28-1995.
- 1,886,563. CONNEXION. INT. CL. 9. REG. 3-28-1995.
- 1,886,564. S (STYLIZED). INT. CL. 9. REG. 3-28-1995.
- 1,886,565. RSVP. INT. CL. 9. REG. 3-28-1995.
- 1,886,567. BEE-TEK. INT. CL. 9. REG. 3-28-1995.
- 1,886,568. RICOH FT9101. INT. CL. 9. REG. 3-28-1995.
- 1,886,569. CELLHOST. INT. CL. 9. REG. 3-28-1995.
- 1,886,573. POP-UP DATA-VU (STYLIZED). INT. CL. 9. REG. 3-28-1995.
- 1,886,574. EXTRA. INT. CL. 9. REG. 3-28-1995.
- 1,886,583. STERI-MAX. INT. CL. 9. REG. 3-28-1995.
- 1,886,584. VISIONTOUCH. INT. CL. 9. REG. 3-28-1995.
- 1,886,585. MUSICWARE AND DESIGN. INT. CL. 9. REG. 3-28-1995.
- 1,886,586. AVENGER. INT. CL. 9. REG. 3-28-1995.
- 1,886,590. VALIANCE. INT. CL. 9. REG. 3-28-1995.
- 1,886,591. CHECKSTORE (STYLIZED). INT. CL. 9. REG. 3-28-1995.
- 1,886,595. BOSS FLOSS. INT. CL. 10. REG. 3-28-1995.
- 1,886,596. IN VIVO - CDK. INT. CL. 10. REG. 3-28-1995.
- 1,886,597. DAM-HER. INT. CL. 10. REG. 3-28-1995.
- 1,886,598. OCTAFLOSS. INT. CL. 10. REG. 3-28-1995.
- 1,886,599. MEROSPLINT. INT. CL. 10. REG. 3-28-1995.
- 1,886,601. FOUNTAIN OF YOUTH. INT. CL. 11. REG. 3-28-1995.
- 1,886,602. PRIMATRAC. INT. CL. 12. REG. 3-28-1995.
- 1,886,604. EUROSTAR. INT. CL. 12. REG. 3-28-1995.
- 1,886,605. SCIMITAR. INT. CL. 12. REG. 3-28-1995.
- 1,886,611. DESIGN-A-DAY. INT. CL. 16. REG. 3-28-1995.
- 1,886,612. WEBSTER'S 21ST CENTURY BOOK OF QUOTATIONS. INT. CL. 16. REG. 3-28-1995.
- 1,886,619. PEACE PILLOWS PLUS. INT. CL. 20. REG. 3-28-1995.
- 1,886,622. ECOLON. INT. CL. 20. REG. 3-28-1995.
- 1,886,623. THE REMOTE TREE AND DESIGN. INT. CL. 20. REG. 3-28-1995.
- 1,886,625. SABRE TIE. INT. CL. 20. REG. 3-28-1995.
- 1,886,627. SQUEEZE WITH EASE. INT. CL. 21. REG. 3-28-1995.
- 1,886,628. MEYER MILANO. INT. CL. 21. REG. 3-28-1995.
- 1,886,630. NOVO. INT. CL. 21. REG. 3-28-1995.
- 1,886,631. ARIES. INT. CL. 21. REG. 3-28-1995.
- 1,886,632. COOL ROLLER. INT. CL. 21. REG. 3-28-1995.
- 1,886,633. FISH-N-TACKLE. INT. CL. 21. REG. 3-28-1995.
- 1,886,636. GEMSTONE GEENIES. INT. CL. 21. REG. 3-28-1995.
- 1,886,639. CUDDLE SHEET. INT. CL. 24. REG. 3-28-1995.
- 1,886,641. OFF CORSS MC CORSS. INT. CL. 25. REG. 3-28-1995.
- 1,886,643. ZANIZOOZ AND DESIGN. INT. CL. 25. REG. 3-28-1995.
- 1,886,645. READY MADE AND DESIGN. INT. CL. 25. REG. 3-28-1995.
- 1,886,646. COMET. INT. CL. 25. REG. 3-28-1995.
- 1,886,648. PRECIOUS BEGINNINGS. INT. CL. 25. REG. 3-28-1995.
- 1,886,650. RACE WEAR AND DESIGN. INT. CL. 25. REG. 3-28-1995.
- 1,886,652. CHECK SIX. INT. CL. 25. REG. 3-28-1995.
- 1,886,653. ASHTON COVE. INT. CL. 25. REG. 3-28-1995.
- 1,886,654. SIGNATURE HOLE. INT. CL. 25. REG. 3-28-1995.
- 1,886,655. LAT-TRAC. INT. CL. 25. REG. 3-28-1995.
- 1,886,656. MY CRAZY LIFE/MCL. INT. CL. 25. REG. 3-28-1995.
- 1,886,657. THE UNIFLAG AND DESIGN. INT. CL. 25. REG. 3-28-1995.
- 1,886,658. WHAT AMERICA MAKES MAKES AMERICA. INT. CL. 25. REG. 3-28-1995.
- 1,886,659. J. RAG. INT. CL. 25. REG. 3-28-1995.
- 1,886,660. MISCELLANEOUS DESIGN. INT. CL. 25. REG. 3-28-1995.
- 1,886,661. RIVER STEP. INT. CL. 25. REG. 3-28-1995.
- 1,886,662. GILDA. INT. CL. 25. REG. 3-28-1995.
- 1,886,663. BAREFOOT. INT. CL. 27. REG. 3-28-1995.
- 1,886,664. TURN-PRO. INT. CL. 28. REG. 3-28-1995.
- 1,886,667. QUICK DRAW. INT. CL. 28. REG. 3-28-1995.
- 1,886,668. CRYSTALS & STARS. INT. CL. 28. REG. 3-28-1995.
- 1,886,671. CRABGRABS. INT. CL. 29. REG. 3-28-1995.
- 1,886,673. VELVEETA ITALIANA. INT. CL. 29. REG. 3-28-1995.
- 1,886,675. EXTREME. INT. CL. 30. REG. 3-28-1995.
- 1,886,677. BEYOND DECADENCE (STYLIZED). INT. CL. 30. REG. 3-28-1995.
- 1,886,678. TRIPLE BLAST. INT. CL. 30. REG. 3-28-1995.
- 1,886,680. PLAIN AND SIMPLE. INT. CL. 30. REG. 3-28-1995.
- 1,886,681. VAN NELLE. INT. CL. 30. REG. 3-28-1995.
- 1,886,682. KOSMONAUT. INT. CL. 30. REG. 3-28-1995.
- 1,886,683. PURE T. INT. CL. 30. REG. 3-28-1995.
- 1,886,685. PLANTERS HEAT. INT. CL. 30. REG. 3-28-1995.
- 1,886,688. HANAQUA. INT. CL. 31. REG. 3-28-1995.
- 1,886,689. THE MEMORIAL DAY FLOWER. INT. CL. 31. REG. 3-28-1995.
- 1,886,690. MISCELLANEOUS DESIGN. INT. CL. 31. REG. 3-28-1995.
- 1,886,691. BOSS/WATER. INT. CL. 32. REG. 3-28-1995.
- 1,886,692. REPLENERGY (STYLIZED). INT. CL. 32. REG. 3-28-1995.
- 1,886,693. VAN DIEMENS. INT. CL. 32. REG. 3-28-1995.
- 1,886,697. YUCA FLATS. INT. CL. 33. REG. 3-28-1995.
- 1,886,701. PRIMELINK. INT. CL. 35. REG. 3-28-1995.
- 1,886,702. TOPMARK. INT. CL. 35. REG. 3-28-1995.
- 1,886,706. GREAT AMERICAN INSURANCE COMPANIES STRENGTH WITH INTEGRITY AND DESIGN. INT. CL. 36. REG. 3-28-1995.
- 1,886,707. CRESTAR MANAGEMENT ACCESS XPRESS. INT. CL. 36. REG. 3-28-1995.
- 1,886,708. JUST ASK ERA. INT. CL. 36. REG. 3-28-1995.
- 1,886,709. UNITY USA (STYLIZED). INT. CL. 36. REG. 3-28-1995.
- 1,886,710. FOODSTOCK. INT. CL. 36. REG. 3-28-1995.
- 1,886,711. DO HWI IT CARD AND DESIGN. INT. CL. 36. REG. 3-28-1995.
- 1,886,715. ALLEGIANCE REALTY GROUP. INT. CL. 36. REG. 3-28-1995.
- 1,886,716. DIGITAL BY QUALCOMM AND DESIGN. INT. CL. 37. REG. 3-28-1995.
- 1,886,718. GREENFIELD ENVIRONMENTAL. INT. CL. 40. REG. 3-28-1995.
- 1,886,719. WE DELIVER SMILES. INT. CL. 40. REG. 3-28-1995.
- 1,886,720. SHOOT-A-ROUND. INT. CL. 41. REG. 3-28-1995.
- 1,886,723. P.E.TV. INT. CL. 41. REG. 3-28-1995.
- 1,886,728. POKER PLAYED PERFECT. INT. CL. 41. REG. 3-28-1995.
- 1,886,732. DIVINION (STYLIZED). INT. CL. 41. REG. 3-28-1995.
- 1,886,734. THE ZULU BIRD. INT. CL. 42. REG. 3-28-1995.
- 1,886,738. SPO. INT. CL. 42. REG. 3-28-1995.
- 1,886,739. SQL ACCESS GROUP AND DESIGN. INT. CL. 42. REG. 3-28-1995.
- 1,886,741. DOGMEISTERS AND DESIGN. INT. CL. 42. REG. 3-28-1995.

- 1,886,742. RENEW REHAB CENTER AND DESIGN. INT. CL. 42. REG. 3-28-1995.
- 1,886,744. RIDGELAND INN R AND DESIGN. INT. CL. 42. REG. 3-28-1995.
- 1,886,745. NO PLANE NO GAIN AND DESIGN. INT. CL. 42. REG. 3-28-1995.
- 1,886,746. NATURA. INT. CL. 42. REG. 3-28-1995.
- 1,886,747. ROWDY'S (STYLIZED). INT. CL. 42. REG. 3-28-1995.
- 1,886,749. COMPETE. INT. CL. 42. REG. 3-28-1995.
- 1,886,751. QUALLOESSENCE. U.S. CL. A. REG. 3-28-1995.
- 1,886,752. ENTERPRISE ENGINEERING. INT. CLS. 41 AND 42. REG. 3-28-1995.
- 1,886,754. SHIMKIT. INT. CLS. 6 AND 20. REG. 3-28-1995.
- 1,886,755. DAWSON. INT. CLS. 6, 14, 20, 21, 24 AND 27. REG. 3-28-1995.
- 1,886,756. HUMMERT. INT. CLS. 31, 37, 39 AND 42. REG. 3-28-1995.
- 1,886,757. READ USA. INT. CLS. 9 AND 16. REG. 3-28-1995.
- 1,886,758. SHEPPARD AND DESIGN. INT. CLS. 9 AND 12. REG. 3-28-1995.
- 1,886,761. CALIFORNIA COLLECTION (STYLIZED). INT. CL. 3. REG. 3-28-1995.
- 1,886,764. VECTOR DRIVE. INT. CL. 7. REG. 3-28-1995.
- 1,886,767. INVERTER DRIVE. INT. CL. 7. REG. 3-28-1995.
- 1,886,768. STRATEDGE. INT. CL. 7. REG. 3-28-1995.
- 1,886,771. INTELLIGENT DOCUMENT. INT. CL. 9. REG. 3-28-1995.
- 1,886,772. SWING STAT. INT. CL. 9. REG. 3-28-1995.
- 1,886,773. NETWORK-GRADE. INT. CL. 9. REG. 3-28-1995.
- 1,886,774. VOICE INPUT PLANNER. INT. CL. 9. REG. 3-28-1995.
- 1,886,776. CORPORATE SECRETARY. INT. CL. 9. REG. 3-28-1995.
- 1,886,777. DONORBASE. INT. CL. 9. REG. 3-28-1995.
- 1,886,781. WESTON. INT. CL. 10. REG. 3-28-1995.
- 1,886,785. MISCELLANEOUS DESIGN. INT. CL. 16. REG. 3-28-1995.
- 1,886,787. RIFLE & SHOTGUN SPORT SHOOTING AND DESIGN. INT. CL. 16. REG. 3-28-1995.
- 1,886,788. TRACKING TEXAS. INT. CL. 16. REG. 3-28-1995.
- 1,886,791. COMPRESSION GLAZED. INT. CL. 19. REG. 3-28-1995.
- 1,886,795. LUZ. INT. CL. 21. REG. 3-28-1995.
- 1,886,796. CORNER CLEANER. INT. CL. 21. REG. 3-28-1995.
- 1,886,798. NICKLAUS. INT. CL. 25. REG. 3-28-1995.
- 1,886,801. ENGLAND PITBULL LOCKE "ONCE IT'S ON, IT'S ON" AND DESIGN. INT. CL. 25. REG. 3-28-1995.
- 1,886,805. LIFESTAGE MATRIX MARKETING. INT. CL. 35. REG. 3-28-1995.
- 1,886,807. AMERICA'S FINEST INVESTORS. INT. CL. 36. REG. 3-28-1995.
- 1,886,809. FOR A HEALTHIER INDOOR AIR ENVIRONMENT (STYLIZED). INT. CL. 37. REG. 3-28-1995.
- 1,886,811. SEARCH AND RESCUE DOGS OF MARYLAND, INC.. INT. CL. 39. REG. 3-28-1995.
- 1,886,812. MIDDLE EAST COUNCIL. INT. CL. 41. REG. 3-28-1995.
- 1,886,813. QUALITY, AFFORDABLE GOLF. INT. CL. 41. REG. 3-28-1995.
- 1,886,815. NATIONAL DREAM HOTLINE. INT. CL. 42. REG. 3-28-1995.
- 1,886,819. AIR COMPLIANCE TESTING. INT. CL. 42. REG. 3-28-1995.
- 1,888,095. CAROLINA PLANT ENGINEERING & MAINTENANCE SHOW. INT. CL. 35. REG. 4-4-1995.
- 1,889,109. H2OIL-BASE (STYLIZED). INT. CL. 2. REG. 4-11-1995.
- 1,890,303. THE GUN BARREL GB AND DESIGN. INT. CL. 42. REG. 4-18-1995.
- 1,891,783. FLEAS ON FRED. INT. CL. 28. REG. 4-25-1995.
- 1,893,131. CAPRICE DESIGN. INT. CL. 18. REG. 5-9-1995.
- 1,900,700. KEG WRAP AND DESIGN. INT. CL. 21. REG. 6-20-1995.
- 1,901,385. ETHNO-MEDICINE PRESERVATION PROJECT. INT. CL. 42. REG. 6-20-1995.
- 1,901,535. OCTA-PAC. INT. CL. 9. REG. 6-27-1995.
- 1,902,133. MISCELLANEOUS DESIGN. INT. CL. 9. REG. 6-27-1995.
- 1,902,236. MACTV. INT. CL. 41. REG. 6-27-1995.
- 1,903,404. CPMS. INT. CL. 9. REG. 7-4-1995.
- 1,904,237. WAVEFRONT. INT. CL. 9. REG. 7-11-1995.
- 1,905,267. DUAL C 600. INT. CL. 5. REG. 7-18-1995.
- 1,919,608. FILIPPO BERIO OLIVE OIL AND DESIGN. INT. CL. 16 ONLY. REG. 9-19-1995.
- 1,920,013. ATF. INT. CL. 30. REG. 9-19-1995.
- 1,921,470. ECONOCO. INT. CLS. 6, 16, 18, 20 AND 22. REG. 9-26-1995.
- 1,923,124. AUTO TRIM DESIGN (STYLIZED). INT. CL. 37. REG. 9-26-1995.
- 1,940,573. HEX - PLUS AND DESIGN. INT. CLS. 6, 7 AND 20 ONLY. REG. 12-12-1995.
- 1,952,198. ATLANTA 1996. INT. CLS. 16, 18, 20, 21, 24, 25, 28 AND 41 ONLY. REG. 1-30-1996.
- 1,952,406. PEDIA PALS. INT. CL. 10 ONLY. REG. 1-30-1996.
- 1,953,992. HEROES OF BASEBALL. INT. CL. 41 ONLY. REG. 2-6-1996.
- 1,955,838. ROADSTER. INT. CL. 9 ONLY. REG. 2-13-1996.
- 1,964,460. SAVE-IT. INT. CLS. 3, 16 AND 29 ONLY. REG. 3-26-1996.
- 1,965,212. DOMINANT. INT. CLS. 7 AND 9 ONLY. REG. 4-2-1996.
- 1,975,797. FF AND DESIGN. INT. CL. 9 ONLY. REG. 5-28-1996.
- 1,983,078. UW AND DESIGN. INT. CL. 41 ONLY. REG. 6-25-1996.
- 1,999,582. PERFECTION HY-TEST. INT. CL. 7 ONLY. REG. 9-10-1996.

SECTION 18

- 927,409. LION SIZE AND DESIGN. U.S. CL. 46. REG. 1-18-1972.
- 1,234,702. BRISTOL. INT. CL. 25. REG. 4-12-1983.
- 1,344,759. BRISTOL. INT. CL. 28. REG. 6-25-1985.
- 1,487,919. CARPETEXPO AND DESIGN. INT. CL. 42. REG. 5-10-1988.
- 1,679,573. THE PIZZA MAKER!. INT. CL. 30. REG. 3-17-1992.
- 2,071,186. CARPET TILE EXPO (STYLIZED). INT. CL. 27. REG. 6-17-1997.
- 2,209,703. PROJECT OFFICE / 2000. INT. CL. 42. REG. 12-8-1998.

2,347,921. MISCELLANEOUS DESIGN. INT. CL. 9. REG. 5-9-2000.

SECTION 37

1,928,879. RUNNING ROOM. INT. CLS. 18, 25 AND 42. REG. 10-24-1995.

**INADVERTENTLY ISSUED REGISTRATION
NUMBERS**

2,526,493. O D OUTDOOR DESIGNS AND DESIGN. INT. CLS. 18, 20 AND 25. REG. 1-8-2002. RESTORED TO SN 75-697,103.

* * * * *

TRADEMARK REGISTRATIONS AMENDED, CORRECTED, ETC.

The designation "U.S. Cl." appearing in this section refers to the U.S. class in effect prior to Sep. 1, 1973 rather than the international class which applies to applications filed on or after that date. For adoption of international classification see notice in the OFFICIAL GAZETTE of Jun. 26, 1973 (911 O.G. TM 210).

Any change to the registration will be indicated at the bottom of each entry under ELEMENTS AMENDED, CORRECTED OR RESTRICTED. With the exception of changes to the goods and services, additions to the registration will appear in asterisks and deletions of the registration will appear in brackets. Elements which are only changed will be listed with no punctuation. As to the goods/services statement, amendments to the goods/services will appear in asterisks and deletions will appear in brackets. In addition if any change to the goods/services occurs, the element "Goods/Services" will be listed under ELEMENTS AMENDED, CORRECTED OR RESTRICTED.

717,307. REG. 6-20-1961. USA RICE COUNCIL (TEXAS NON-PROFIT CORPORATION) PO BOX 740123, HOUSTON, TX, 77274, BY CHANGE OF NAME RICE INDUSTRY, THE (TEXAS CORPORATION), HOUSTON, TX, SN 72-091,845. FILED 2-29-1960. PRINCIPAL REGISTER.



APPLICANT DISCLAIMS ANY EXCLUSIVE RIGHTS IN THE WORDS "RICE" APART FROM THE MARK AS SHOWN.

INT. CL. 42/U.S. CL. 100

FOR SERVICES RENDERED TO THE RICE INDUSTRY AND CONSUMERS, INCLUDING PUBLIC RELATION SERVICES, DISSEMINATION OF SPECIAL INFORMATION REGARDING THE CONSUMPTION AND UTILIZATION OF RICE, AND TRADE ASSOCIATION SERVICES.

FIRST USE 7-1-1959; IN COMMERCE 7-1-1959.

ELEMENTS AMENDED
MARK
DISCLAIMER

921,345. REG. 9-28-1971. IDA CASON CALLAWAY FOUNDATION (GEORGIA CORPORATION), POST OFFICE BOX 2000, 205 NORTH CHERRY STREET, PINE MOUNTAIN, GA, 318222000, SN 72-328,949. FILED 6-3-1969. PRINCIPAL REGISTER.



Callaway Gardens

INT. CL. 41/U.S. CL. 107

FOR PROVIDING FACILITIES FOR RESORT AND RECREATIONAL ACTIVITIES.
FIRST USE 3-0-1961; IN COMMERCE 3-0-1961.

ELEMENTS AMENDED
MARK

1,147,250. REG. 2-17-1981. SAUCONY, INC. (MASSACHUSETTS CORPORATION), 13 CENTENNIAL DRIVE, PEABODY, MA, 01961, ASSIGNEE OF; BY CHANGE OF NAME SAUCONY SHOE MANUFACTURING COMPANY, INC. (PENNSYLVANIA CORPORATION), KUTZTOWN, PA, SN 73-201,269. FILED 1-24-1979. PRINCIPAL REGISTER.

SAUCONY

INT. CL. 25/U.S. CL. 39

FOR SHOES.

FIRST USE 6-0-1976; IN COMMERCE 7-0-1976.

ELEMENTS AMENDED
MARK

1,162,128. REG. 7-21-1981. BIENES INMUEBLES DE TLAXCALA, S.A. DE C.V. (MEXICO CORPORATION), REFORMA SUR #27, PANZACOLA, TLAXCALA C.P., MEXICO., BY ASSIGNMENT, BY ASSIGNMENT, BY ASSIGNMENT SANGRITA DE LA VIUDA DE SANCHEZ, S.A. (MEXICO CORPORATION), CHAPALA, JALISCO, MEXICO, SN 73-110,648. FILED 12-23-1976. PRINCIPAL REGISTER.

VIUDA DE SANCHEZ

OWNER OF MEXICO REG. NO. 183,694, DATED 5-16-1973. THE ENGLISH TRANSLATION OF "VIUDA DE SANCHEZ" IN THE MARK IS "SANCHEZ'S WIDOW".

INT. CL. 32/U.S. CL. 46

FOR NON-ALCOHOLIC COCKTAIL MIX.

ELEMENTS AMENDED
MARK
TRANSLATION OF MARK

1,173,752. REG. 10-20-1981. FISHER SCIENTIFIC COMPANY LLC (DELAWARE LIMITED LIABILITY COMPANY) LIBERTY LANE, HAMPTON, NH, 03842, BY MERGER, BY MERGER, BY ASSIGNMENT PACIFIC HEMOSTASIS LABORATORY, INC. (CALIFORNIA CORPORATION), BAKERSFIELD, CA, SN 73-203,366. FILED 2-9-1979. PRINCIPAL REGISTER.

THROMBOSTRATE

INT. CL. 1/U.S. CL. 6
FOR BLOOD DIAGNOSTIC REAGENT—NAMELY, FACTOR X DEFICIENT SUBSTRATE.
FIRST USE 3-31-1978; IN COMMERCE 8-8-1978.

ELEMENTS AMENDED
MARK
[DISCLAIMER]

1,186,117. REG. 1-12-1982. MASTERCARD INTERNATIONAL INCORPORATED (DELAWARE CORPORATION), 2000 PURCHASE STREET, PURCHASE, NY, 105772509, BY CHANGE OF NAME INTERBANK CARD ASSOCIATION (DELAWARE CORPORATION), NEW YORK, NY, SN 73-259,545. FILED 4-25-1980. PRINCIPAL REGISTER.

MasterCard

INT. CL. 36/U.S. CL. 102
FOR FINANCIAL SERVICES—NAMELY, PROVIDING BANK CARD SERVICES.
FIRST USE 2-11-1980; IN COMMERCE 2-11-1980.

ELEMENTS AMENDED
OWNER ADDRESS

1,394,569. REG. 5-27-1986. VARN PRODUCTS CO., INC. (NEW JERSEY CORPORATION), 175 ROUTE 208, OAKLAND, NJ, 07436, SN 73-531,341. FILED 4-8-1985. PRINCIPAL REGISTER.

BLUE VELVET

NO CLAIM IS MADE TO THE EXCLUSIVE RIGHT TO USE "BLUE", APART FROM THE MARK AS SHOWN.
INT. CL. 3/U.S. CL. 52
FOR INDUSTRIAL LIQUID HAND CLEANER.
FIRST USE 10-14-1984; IN COMMERCE 10-14-1984.

ELEMENTS CORRECTED
OWNER NAME

1,475,428. REG. 2-2-1988. LIFECELL CORPORATION (DELAWARE CORPORATION), 3606 RESEARCH FOREST DRIVE, THE WOODLANDS, TX, 77381, SN 73-633,487. FILED 12-3-1986. PRINCIPAL REGISTER.

LIFECELL

INT. CL. 42/U.S. CL. 100
FOR PREPARING AND PRESERVING TISSUE SAMPLES FOR USE BY OTHERS FOR LATER ANALYSIS.
FIRST USE 7-30-1986; IN COMMERCE 7-30-1986.

ELEMENTS CORRECTED
ENTITY

1,557,681. REG. 9-26-1989. CORRUGATED TECHNOLOGIES, INC. (CALIFORNIA CORPORATION), 7220 TRADE STREET, #220, SAN DIEGO, CA, 921212324, SN 73-709,909. FILED 2-8-1988. PRINCIPAL REGISTER.

CORRTRIM

INT. CL. 9/U.S. CL. 38
FOR COMPUTER PROGRAMS FOR USE IN SCHEDULING AND COMBINING ORDERS IN ORDER TO OPTIMIZE CORRUGATOR PRODUCTIVITY AND ROLL STOCK OPTIMIZATION FOR THE CORRUGATED BOX MANUFACTURING INDUSTRY.
FIRST USE 4-15-1981; IN COMMERCE 4-15-1981.

ELEMENTS AMENDED
OWNER ADDRESS
MARK

1,587,593. REG. 3-20-1990. CORRUGATED TECHNOLOGIES, INC. (CALIFORNIA CORPORATION), 7220 TRADE STREET, SUITE 220, SAN DIEGO, CA, 921213758, SN 73-818,076. FILED 8-9-1989. PRINCIPAL REGISTER.

CORRLINK

INT. CL. 9/U.S. CL. 38
FOR COMPUTER PROGRAM FOR USE IN TRANSFERRING AND MANIPULATING INFORMATION BETWEEN COMPUTERS IN THE CORRUGATED BOX MANUFACTURING INDUSTRY.
FIRST USE 7-8-1988; IN COMMERCE 7-8-1988.

ELEMENTS AMENDED
MARK

1,618,485. REG. 10-23-1990. CONNECTIX CORPORATION (CALIFORNIA CORPORATION), 2655 CAMPUS DRIVE, SAN MATEO, CA, 94403, SN 73-795,705. FILED 4-25-1989. PRINCIPAL REGISTER.

CONNECTIX

INT. CL. 9/U.S. CLS. 26 AND 38

FOR COMPUTER MEMORY MANAGEMENT UNITS FOR COMPUTERS, AND MEMORY MANAGEMENT COMPUTER PROGRAMS AND INSTRUCTION MANUALS THEREFOR SOLD TOGETHER WITH SUCH COMPUTER PROGRAMS AS A UNIT.
FIRST USE 1-14-1989; IN COMMERCE 1-14-1989.

ELEMENTS AMENDED
OWNER NAME

FOR COMPUTER PROGRAM FOR USE IN PRINTING OF TAGS FOR THE CORRUGATED BOX MANUFACTURING INDUSTRY.
FIRST USE 7-23-1990; IN COMMERCE 7-23-1990.

ELEMENTS AMENDED
OWNER ADDRESS
MARK

1,621,454. REG. 11-6-1990. THE DERBY CONE COMPANY (KENTUCKY CORPORATION), 2208 PLANTSIDE DRIVE, LOUISVILLE, KY, 40299, SN 73-627,931. FILED 10-31-1986. PRINCIPAL REGISTER.

1,775,104. REG. 6-8-1993. GARRITY INDUSTRIES (CONNECTICUT CORPORATION), 14 NEW ROAD, MADISON, CT, 06443, SN 74-261,409. FILED 4-1-1992. PRINCIPAL REGISTER.

EV-R-CRISP

SEC. 2(F).
INT. CL. 30/U.S. CL. 46
FOR ICE CREAM CONES, CAKE CUPS, ICE CREAM SANDWICH WAFERS AND OTHER BAKERY GOODS.
FIRST USE 1-31-1962; IN COMMERCE 1-31-1962.

ELEMENTS CORRECTED
OWNER NAME

AMERICA'S FASTEST GROWING NAME IN LIGHTING

INT. CL. 11/U.S. CL. 21
FOR FLASHLIGHTS.
FIRST USE 0-0-1988; IN COMMERCE 0-0-1988.

ELEMENTS CORRECTED
OWNER NAME

1,667,805. REG. 12-10-1991. COMMONWEALTH BRANDS, INC. (KENTUCKY CORPORATION), 811 RAVEN AVENUE, BOWLING GREEN, KY, 42101, SN 74-129,427. FILED 1-10-1991. PRINCIPAL REGISTER.

1,820,925. REG. 2-15-1994. IL MARCHESE COCCAPANI S.P.A. (ITALY CORPORATION), VIA MODENA CARPI 290, 41019 SOLIERA, MODENA, ITALY, SN 74-337,407. FILED 12-7-1992. PRINCIPAL REGISTER.

Montclair



OWNER OF U.S. REG. NO. 737,762.
INT. CL. 34/U.S. CL. 17
FOR CIGARETTES.
FIRST USE 8-8-1989; IN COMMERCE 8-8-1989.

ELEMENTS AMENDED
MARK



OWNER OF ITALY REG. NO. 502047, DATED 12-5-1988.
THE ENGLISH TRANSLATION OF THE FOREIGN WORDING "IL MARCHESE" IS "THE MARQUESS".
INT. CL. 3/U.S. CLS. 1, 4, 6, 50, 51 AND 52

FOR [TOILET SOAPS, PERFUME, COLOGNE, ESSENTIAL OILS FOR PERSONAL USE, MAKEUP, HAIR LOTIONS AND DENTIFRICES].
FIRST USE ; IN COMMERCE .

INT. CL. 25/U.S. CLS. 22 AND 39
FOR CLOTHING; NAMELY, OVERCOATS, [SHORT OVERCOATS], JACKETS, LONG JACKETS, WOMEN'S JACKETS, ZIPPERED JACKETS, LONG FITTED JACKETS, [SPORTS JACKETS FOR MEN, QUILT BOMBER-PILOT-STYLE JACKETS], BERMUDA SHORTS, [SHAWLS], SHIRTS, TROUSERS, JEANS, TURTLENECK SWEATERS, CARDIGANS, STRETCH PANTS, BLOUSES, STONE-WASHED JEANS, KNIT SKIRTS, SKIRTS, T-SHIRTS, HIGH-NECK T-SHIRTS, POLO SHIRTS, WOOL SUITS, SUITS, SCARVES, [TIES], FOULARDS, [PLAID JUMPERS], DRESSES, CAPS.
FIRST USE ; IN COMMERCE .

1,692,705. REG. 6-9-1992. CORRUGATED TECHNOLOGIES, INC. (CALIFORNIA CORPORATION), 7220 TRADE STREET, #220, SAN DIEGO, CA, 921212324, SN 74-127,854. FILED 1-4-1991. PRINCIPAL REGISTER.

CORRTAG

OWNER OF U.S. REG. NOS. 1,557,681 AND 1,587,593.
INT. CL. 9/U.S. CL. 38

ELEMENTS AMENDED
MARK

1,829,858. REG. 4-5-1994. PACIFIC COAST FEATHER CO., INC. (WASHINGTON CORPORATION), P.O. BOX 80385, SEATTLE, WA, 98108, SN 74-293,259. FILED 7-13-1992. PRINCIPAL REGISTER.

SOFT SIDE-UP

INT. CL. 20/U.S. CL. 32
FOR PILLOWS.
FIRST USE 7-0-1992; IN COMMERCE 7-0-1992.

ELEMENTS AMENDED
MARK

1,843,179. REG. 7-5-1994. COMMONWEALTH RISK SERVICES, L.P. (DELAWARE LIMITED PARTNERSHIP), ONE LOGAN SQUARE, SUITE 1500, PHILADELPHIA, PA, 19103. BY ASSIGNMENT COMMONWEALTH RISK SERVICES, INC. (PENNSYLVANIA CORPORATION), PHILADELPHIA, PA, SN 74-389,355. FILED 5-4-1993. PRINCIPAL REGISTER.

CommonwealthRisk
Services, Inc.

NO CLAIM IS MADE TO THE EXCLUSIVE RIGHT TO USE "RISK ", APART FROM THE MARK AS SHOWN.
INT. CL. 36/U.S. CL. 102

FOR CONSULTING SERVICES IN THE FIELD OF RISK FINANCING; REINSURANCE BROKERAGE SERVICES.

FIRST USE 11-4-1991; IN COMMERCE 11-4-1991.

ELEMENTS AMENDED
MARK
DISCLAIMER

1,901,647. REG. 6-27-1995. ESAOTE S.P.A. (ITALY CORPORATION), VIA SIFFREDI 58, 16153 GENOA, ITALY., BY ASSIGNMENT ESAOTE BIOMEDICA (ITALY CORPORATION), 16153 GENOA, ITALY, SN 74-475,127. FILED 12-21-1993. PRINCIPAL REGISTER.

ARTOSCAN

INT. CL. 10/U.S. CL. 44
FOR MAGNETIC RESONANCE IMAGING APPARATUS.
FIRST USE 11-30-1992; IN COMMERCE 11-30-1992.

ELEMENTS CORRECTED
OWNER NAME

1,924,875. REG. 10-3-1995. SAVAREZ (FRANCE SOCIETE ANONYME) 51 RUE DELEUVRE, 69004 LYON, FRANCE., SN 74-619,145. FILED P.R. 1-9-1995; AM. S.R. 6-29-1995. SUPPLEMENTAL REGISTER.

CORUM

INT. CL. 15/U.S. CLS. 2, 21 AND 36
FOR STRINGS FOR MUSICAL INSTRUMENTS.
FIRST USE 4-0-1994; IN COMMERCE 7-0-1994.

ELEMENTS AMENDED
OWNER NAME

1,952,646. REG. 1-30-1996. PIO ECHEVERRIA LIZARAZU (SPAIN CORPORATION), BO. CARABEL-TXIKI, S/N, 20120 HERNANI (GUIPUZKOA), SPAIN., SN 74-579,655. FILED 9-28-1994. PRINCIPAL REGISTER.



THE MARK CONSISTS, IN PART, OF A STYLIZED CLAMP.

INT. CL. 7/U.S. CL. 23
FOR MACHINES FOR NUMBERING, RIVETING, ENGRAVING, INSERTING AND DATING; MACHINES FOR MARKING BY LASER. BY IMPACT, BY NOT STAMPING AND BY ROLLING.

FIRST USE 0-0-1992; IN COMMERCE 0-0-1992.

ELEMENTS CORRECTED
ENTITY

1,953,034. REG. 1-30-1996. MOTLEY FOOL, INC., THE (DELAWARE CORPORATION), 123 NORTH PITT STREET, ALEXANDRIA, VA, 22314, SN 74-629,137. FILED 1-24-1995. PRINCIPAL REGISTER.

THE MOTLEY FOOL

INT. CL. 16/U.S. CLS. 2, 5, 22, 23, 29, 37, 38 AND 50
FOR NEWSLETTERS IN THE FIELDS OF FINANCE, ENTERTAINMENT, SPORTS AND HUMOR.
FIRST USE 7-0-1993; IN COMMERCE 7-0-1993.

INT. CL. 42/U.S. CLS. 100 AND 101
FOR ONLINE COMPUTER SERVICES, NAMELY PROVIDING ACCESS TIME TO A COMPUTER DATA BASE IN THE NATURE OF A COMPUTER BULLETIN BOARD IN THE FIELDS OF FINANCE, ENTERTAINMENT, SPORTS, AND HUMOR.
FIRST USE 7-0-1993; IN COMMERCE 7-0-1993.

ELEMENTS CORRECTED
CITIZENSHIP

1,983,275. REG. 7-2-1996. AKU S.R.L. (ITALY LIMITED LIABILITY COMPANY) VIA SCHIAVONESCA PRIULA 65, MONTEBELLUNA - (TREVISO), ITALY., SN 74-472,080. FILED 12-17-1993. PRINCIPAL REGISTER.



PRIORITY CLAIMED UNDER SEC. 44(D) ON ITALY APPLICATION NO. TV93C000167, FILED 6-22-1993, REG. NO. 608443, DATED 11-2-1993, EXPIRES 6-22-2003.

INT. CL. 25/U.S. CLS. 22 AND 39

FOR UNDERWEAR, BRASSIERES, CORSETS, HOSIERY, PETTICOATS, NIGHTGOWNS, PAJAMAS, PULL-OVERS, DRESSING GOWNS, BATH ROBES, GLOVES, CARDIGANS, HATS, JERSEYS; FOULARD TIES, SCARVES, AND SWEATERS, SOCKS, STOCKINGS, TROUSERS, LEGGINGS, SKIRTS, JACKETS, JERKINS, SHIRTS, VESTS, JUMPERS, TRACK SUITS, BLOUSES, JEANS, PANTS, BERMUDA SHORTS, T-SHIRTS, CAPS, PANTIES, SWEAT-SHIRTS, SUITS AND DRESSES, OVERCOATS, COATS, ANORAKS, RAINCOATS, BATHING SUITS, BELTS, SHOES, BOOTS, SLIPPERS, ATHLETIC SHOES, SKI BOOTS, GOLF SHOES, SKI GAITERS.

INT. CL. 28/U.S. CLS. 22, 23, 38 AND 50

FOR SKI CASES, SKI POLES, SKI BINDINGS, SKIS, SNOW SLEDS, ROLLER SKATES, ICE SKATES, RACQUETBALL RACKETS, SQUASH RACKETS, TENNIS RACKETS, TABLE-TENNIS BATS, TENNIS BALLS, GOLF CLUBS, GOLF BALLS, SKI-BINDING COVERS, BASKETBALLS, BASKETBALL BACKBOARDS, SKATEBOARDS, SPORTS BALLS, WATERSKIS, EXERCISE BARS, EXERCISE MACHINES, SNOW BOARDS, MONOSKIS, SURF BOARDS, WINDSURF BOARDS.

ELEMENTS CORRECTED
OWNER NAME

1,995,095. REG. 8-20-1996. PANTONE, INC. (DELAWARE CORPORATION), 590 COMMERCE BOULEVARD, CARLSTADT, NJ, 07072, SN 74-688,339. FILED 6-9-1995. PRINCIPAL REGISTER.

**PANTONE THE POWER OF
COLOR**

INT. CL. 42/U.S. CLS. 100 AND 101

FOR PROMOTING THE STUDY OF THE PSYCHOLOGY OF COLOR AND SOCIETAL COLOR TRENDS; SPECIFYING AND VERIFYING COLOR AS USED BY PRINTERS AND GRAPHIC ARTISTS IN MANY AREAS OF DESIGN, NAMELY GRAPHIC DESIGN, INDUSTRIAL DESIGN, ARCHITECTURE AND INTERIOR DESIGN, COSMETICS AND FASHION DESIGN; AND DEVELOPING CUSTOMIZED STANDARDS TO ASSURE COLOR CONSISTENCY AND ACCURACY IN THE REPRODUCTION OF COLORS IN DYES AND FABRICS; DEVELOPING CUSTOMIZED PRINTING INK COLOR STANDARDS TO ASSURE COLOR CONSISTENCY; AND SPECIFYING COLORS FOR CORPORATE IDENTIFICATION PROGRAMS BY PROVIDING COLOR ANALYSIS FOR MATCHING AGAINST STANDARDS FOR A COLOR, TO THE ORDER AND/OR SPECIFICATION OF OTHERS.

FIRST USE 4-17-1995; IN COMMERCE 4-17-1995.

ELEMENTS CORRECTED
CITIZENSHIP

2,002,532. REG. 9-24-1996. GIROSOL CORP. (NEW JERSEY CORPORATION), 815 ELIZABETH AVENUE, 3RD FLOOR, ELIZABETH, NJ, 07201, SN 74-676,432. FILED 5-18-1995. PRINCIPAL REGISTER.



INT. CL. 36/U.S. CLS. 100, 101 AND 102

FOR FINANCIAL SERVICES, NAMELY PROVIDING INTERNATIONAL MONEY ORDER AND ELECTRONIC FUNDS TRANSFER SERVICES TO THE PUBLIC.

FIRST USE 2-13-1995; IN COMMERCE 2-13-1995.

ELEMENTS AMENDED
MARK

2,066,256. REG. 6-3-1997. VISIONAMERICA INCORPORATED (DELAWARE CORPORATION), 5350 POPLAR AVENUE, SUITE 900, MEMPHIS, TN, 38119, BY CHANGE OF NAME OMEGA HEALTH SYSTEMS, INC. (DELAWARE CORPORATION), MEMPHIS, TN, SN 74-711,359. FILED 8-4-1995. PRINCIPAL REGISTER.

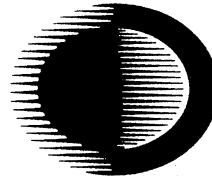

INT. CL. 35/U.S. CLS. 100, 101 AND 102

FOR PROVIDING BUSINESS MANAGEMENT SERVICES, ADVERTISING SERVICES, NAMELY, TELEVISION ADVERTISING TO OPHTHALMOLOGISTS AND OPTOMETRISTS, PREPARING AUDIO-VISUAL PRESENTATIONS FOR USE IN ADVERTISING TO OPHTHALMOLOGISTS AND OPTOMETRISTS AND DIRECT MAIL ADVERTISING; AND MARKET RESEARCH SERVICES TO OPHTHALMOLOGISTS AND OPTOMETRISTS.

FIRST USE 1-1-1987; IN COMMERCE 1-1-1987.
INT. CL. 42/U.S. CLS. 100 AND 101
FOR OPHTHALMOLOGY AND OPTOMETRY SERVICES.

FIRST USE 7-1-1986; IN COMMERCE 1-1-1987.

ELEMENTS AMENDED
GOODS/SERVICES

2,176,001. REG. 7-28-1998. SCHULER, BERND (FED REP GERMANY CITIZEN), LINDENWEG 16, D-35708 HAIGER, FED REP GERMANY., BY ASSIGNMENT DOCUMENTATIONSSERVICE GMBH (FED REP GERMANY CORPORATION), D-64295 DARMSTADT, FED REP GERMANY, SN 75-097,186. FILED 5-1-1996. PRINCIPAL REGISTER.

MEDDIRECT

PRIORITY CLAIMED UNDER SEC. 44(D) ON FED REP GERMANY APPLICATION NO. 39550604.2, FILED 12-12-1995, REG. NO. 39550604, DATED 9-4-1996.

INT. CL. 16/U.S. CLS. 2, 5, 22, 23, 29, 37, 38 AND 50

FOR PRINTED MATTER, NAMELY, BROCHURES, JOURNALS CONCERNING TOPICS OF MEDICAL AND NATURAL SCIENCE INTEREST *ALL OF THE FOREGOING EXCLUDING ANY PRODUCTS RELATIVE TO TRAVEL, ENTERTAINMENT, TOURIST AND LEISURE FACILITIES AND OF ANY RELATED ACTIVITIES.*

FIRST USE ; IN COMMERCE .

INT. CL. 42/U.S. CLS. 100 AND 101

FOR DISSEMINATION OF INFORMATION REGARDING MEDICAL PRODUCTS AND SERVICES OF OTHERS, AND LITERATURE, EDUCATION AND TRAINING VIA A GLOBAL INTERACTIVE ON-LINE COMPUTER NETWORK; COMPUTER SERVICES, NAMELY, PROVIDING ON-LINE FACILITIES FOR REAL TIME INTERACTION WITH OTHER COMPUTER USERS CONCERNING TOPICS OF MEDICAL AND NATURAL SCIENTIFIC INTEREST *ALL OF THE FOREGOING EXCLUDING SERVICES RELATIVE TO TRAVEL ENTERTAINMENT, TOURIST AND LEISURE FACILITIES AND OF ANY RELATED ACTIVITIES.

FIRST USE ; IN COMMERCE .

ELEMENTS AMENDED
GOODS/SERVICES

2,190,904. REG. 9-22-1998. CORRUGATED TECHNOLOGIES, INC. (CALIFORNIA CORPORATION), 7220 TRADE STREET, #220, SAN DIEGO, CA, 921212324, SN 75-344,723. FILED 8-21-1997. PRINCIPAL REGISTER.

CORRTRAC

INT. CL. 9/U.S. CLS. 21, 23, 26, 36 AND 38

FOR COMPUTER PROGRAM FOR INVENTORY TRACKING FOR THE CORRUGATED BOX MANUFACTURING INDUSTRY.

FIRST USE 12-15-1997; IN COMMERCE 12-15-1997.

ELEMENTS AMENDED
OWNER ADDRESS
MARK

2,251,288. REG. 6-8-1999. NELL'S INC. (NEW YORK CORPORATION), 145 BROADWAY, NEW YORK, NY, 10013, SN 75-452,594. FILED 3-18-1998. PRINCIPAL REGISTER.

NELLS

"NELL'S" DOES NOT IDENTIFY A PARTICULAR LIVING INDIVIDUAL.

INT. CL. 42/U.S. CLS. 100 AND 101

FOR RESTAURANT SERVICES.

FIRST USE 10-0-1986; IN COMMERCE 10-0-1986.

ELEMENTS AMENDED
MARK

2,271,074. REG. 8-17-1999. CONSECO, INC. (INDIANA CORPORATION), 11825 N. PENNSYLVANIA STREET, P.O. BOX 1911, CARMEL, IN, 46032, SN 75-341,942. FILED 8-15-1997. PRINCIPAL REGISTER.

CONSECO ADVANTAGE VARIABLE ANNUITY

OWNER OF U.S. REG. NO. 2,020,988.

NO CLAIM IS MADE TO THE EXCLUSIVE RIGHT TO USE "VARIABLE ANNUITY", APART FROM THE MARK AS SHOWN.

INT. CL. 36/U.S. CLS. 100, 101 AND 102

FOR UNDERWRITING OF LIFE INSURANCE, PRIVATE PENSION PLANS AND ANNUITIES.

FIRST USE 2-28-1998; IN COMMERCE 2-28-1998.

ELEMENTS CORRECTED
CITIZENSHIP

2,291,646. REG. 11-9-1999. NETWORKS ASSOCIATES TECHNOLOGY, INC. (DELAWARE CORPORATION), 3965 FREEDOM CIRCLE, SANTA CLARA, CA, 95054, BY MERGER, BY ASSIGNMENT HELIX SOFTWARE COMPANY, INC. (GEORGIA CORPORATION), LONG ISLAND CITY, NY, SN 75-346,139. FILED P.R. 8-25-1997; AM. S.R. 7-6-1999. SUPPLEMENTAL REGISTER.

REGISTRY WIZARD

NO CLAIM IS MADE TO THE EXCLUSIVE RIGHT TO USE "WIZARD", APART FROM THE MARK AS SHOWN.

INT. CL. 9/U.S. CLS. 21, 23, 26, 36 AND 38

FOR COMPUTER SOFTWARE FOR CLEANING, REPAIRING AND OPTIMIZING COMPUTER HARD DRIVES.

FIRST USE 4-1-1997; IN COMMERCE 4-11-1997.

ELEMENTS CORRECTED
OWNER NAME

2,313,279. REG. 2-1-2000. THINGWORLD.COM,LLC (DELAWARE CORPORATION), 1220 WASHINGTON STREET, NEWTON, MA. 02465, BY CHANGE OF NAME PARABLE LLC (DELAWARE CORPORATION), NEWTON, MA, SN 75-484,787. FILED 5-14-1998. PRINCIPAL REGISTER.

THINGCONVERTER

INT. CL. 9/U.S. CLS. 21, 23, 26, 36 AND 38

FOR COMPUTER SOFTWARE ENABLING THE CONVERSION OF PREVIOUSLY FORMATTED MULTIMEDIA CONTENT TO ANOTHER FORMAT.

FIRST USE 12-17-1996; IN COMMERCE 12-17-1996.

ELEMENTS CORRECTED
OWNER NAME

2,317,512. REG. 2-15-2000. TELEDYNE INDUSTRIES INC. (CALIFORNIA CORPORATION), 2049 CENTURY PARK EAST, STE 1500, LOS ANGELES, CA, 900673101, SN 75-252,512. FILED 2-24-1997. PRINCIPAL REGISTER.



NO CLAIM IS MADE TO THE EXCLUSIVE RIGHT TO USE " INFORMATION SERVICES, APART FROM THE MARK AS SHOWN.

THE LINING IS A FEATURE OF THE MARK AND IS NOT INTENDED TO INDICATE COLOR. THE STIPPLING IS FOR SHADING PURPOSES ONLY AND IS NOT INTENDED TO INDICATE COLOR.

INT. CL. 35/U.S. CLS. 100, 101 AND 102

FOR CUSTOMER SUPPORT SERVICES, NAMELY, PROVIDING MAINTENANCE INFORMATION, SERVICE BULLETINS, FAA AIRWORTHINESS DIRECTIVES REGARDING A CUSTOMER'S PARTICULAR AIRCRAFT ENGINE BY TELEPHONE AND OR BY COMPUTER CONNECTION.

FIRST USE 7-0-1994; IN COMMERCE 7-0-1994.

ELEMENTS AMENDED
DISCLAIMER
MARK

2,354,485. REG. 6-6-2000. INDUSTRIAS ALIMENTARIAS DE NAVARRA, S.A. (SPAIN CORPORATION), SAN ADRIAN NAVARRA, SPAIN., SN 75-463,587. FILED 4-7-1998. PRINCIPAL REGISTER.

BEBE

OWNER OF SPAIN REG. NO. 1023939, DATED 12-13-1982, EXPIRES 12-13-2002.

OWNER OF SPAIN REG. NO. 788167, DATED 3-18-1982, EXPIRES 3-18-2002.

THE ENGLISH TRANSLATION OF "BEBE" IS "BABY" OR "HE/SHE/IT DRINKS".

INT. CL. 29/U.S. CL. 46

FOR PRESERVED, DRIED AND COOKED FRUITS AND VEGETABLES, JELLIES, JAMS AND PICKLES.

INT. CL. 30/U.S. CL. 46

FOR COFFEE; TEA, COCOA, RICE, TAPIOCA, ARTIFICIAL COFFEE; BREAD SPONGECAKE, CAKES, PASTRY; HONEY, TREAACLE, YEAST, SALT, MUSTARD; VINEGAR, SAUCES (EXCEPT SALAD DRESSINGS); SPICES; ICE.

ELEMENTS CORRECTED

FOREIGN REG. EXPIRATION DATE

2,362,355. REG. 6-27-2000. LOUVER-LITE LIMITED (UNITED KINGDOM LIMITED LIABILITY COMPANY) ASHTON ROAD, HYDE, CHESHIRE SK14 4BG, ENGLAND., SN 75-794,780. FILED 9-9-1999. PRINCIPAL REGISTER.

LOUVOLITE

OWNER OF U.S. REG. NO. 1,788,177.

INT. CL. 7/U.S. CLS. 13, 19, 21, 23, 31, 34 AND 35

FOR MACHINES AND MACHINE TOOLS FOR THE MANUFACTURE AND ASSEMBLY OF WINDOW BLINDS NAMELY, LOUVER CUTTING MACHINES, PNEUMATIC LINK CURLING TOOLS, LINK REDUCING TOOLS, CORD CUTTERS AND SEALERS, AND PNEUMATIC LOUVER PUNCHES.

FIRST USE 0-0-1983; IN COMMERCE 0-0-1983.

INT. CL. 8/U.S. CLS. 23, 28 AND 44

FOR HAND TOOLS FOR THE MANUFACTURE AND ASSEMBLY OF WINDOW BLINDS, NAMELY- LOUVER-CUT-PUNCH-CREASE TOOLS, FABRIC CLAMPS WITH FABRIC CUTTER, GLUE GUNS, PLASTIC FORMING TOOLS, PUNCHES, MYLAR DISPENSERS, BOTTOM BAR GROOVE WIDENERS, CREASING TOOLS, FORMING TOOLS, FABRIC CUTTERS, BLADE HOLDERS, MAGNETS, ANTI-FRAY PENS, JOINTING PLIERS, THRUST WASHER AND CIRCLIP TOOLS, MANUAL LINK CURLING TOOLS, MANUALLOUVERPUNCHES, SLAT MEASURING CLAMPS, PLIERS FOR EYELETS, GROMMET TOOLS AND SUPPORT BLOCKS, FABRIC DRILLING BITS, FABRIC DRILLING PADS, FABRIC DRILL EXHAUST/ADAPTORS, FABRIC DISC BLADE CUTTERS/SHARPENERS, AND TAG GUNS.

FIRST USE 0-0-1983; IN COMMERCE 0-0-1983.

INT. CL. 9/U.S. CLS. 21, 23, 26, 36 AND 38

FOR ELECTRIC MOTOR END SETS, RECEIVER/BATTERY HOLDERS AND REMOTE CONTROL UNITS FOR REMOTE OPERATION OF WINDOW BLINDS[COLOR AND FABRIC SELECTOR BOOKS FOR WINDOW BLINDS] .

FIRST USE 0-0-1983; IN COMMERCE 0-0-1983.

INT. CL. 16/U.S. CLS. 2, 5, 22, 23, 29, 37, 38 AND 50

FOR COLOR AND FABRIC SELECTOR BOOKS FOR WINDOW BLINDS.

FIRST USE 0-0-1983; IN COMMERCE 0-0-1983.

INT. CL. 20/U.S. CLS. 2, 13, 22, 25, 32 AND 50

FOR [VENETIAN BLINDS,] PLEATED BLINDS, ROLLER BLINDS AND VERTICAL LOUVER BLINDS MADE OF METAL, PLASTIC, WOOD, OR FABRIC; FABRIC AND BRAID FOR BLINDS - STORE DISPLAY STANDS FOR DISPLAYING BLINDS - BLIND FABRIC SELECTOR STANDS; AND COMPONENT PARTS FOR [VENETIAN BLINDS,] PLEATED BLINDS, ROLLER BLINDS AND VERTICAL LOUVER BLINDS, NAMELY - FOR [VENETIAN BLINDS - HEAD AND BOTTOM RAILS, TILT RODS, TILER SETS, CORD LOCKS, TAPE ROLL SUPPORTS WITH ROLLER, TAPE ROLLS, END CAPS, END CAP HOLDDOWNS, HOLD DOWN BRACKETS, TAPE BUTTONS, CORDS, LADDER BRAID, TOP SLAT CLIPS, INTERMEDIATE SUPPORT BRACES, FACE/TOP FIXING, FACE/TOP FIXING BRACKETS, UNIVERSAL END FIX BRACKETS, ADAPTER ANGLE BRACKETS, STAR WASHERS, CONCEALED BRACKETS, TOP FIX, TILTING CONTROL SETS, TAPE ROLLS WITH SCREW, CORD CLAMPING BUTTONS, EYELETS, INDIVIDUAL SLATS AND SLAT SELECTOR DECKS FOR] PLEATED BLINDS - CHANNEL SECTIONS FOR HEADRAILS AND LOWER RAILS, BOTTOM BAR WEIGHTS, ALUMINUM SLATTING, DOUBLE-SIDED SELF ADHESIVE TAPE, PLASTIC GROMMETS, BRIDGE PIECE GROMMETS, EYELETS, END CAPS FOR HEAD RAILS AND LOWER RAILS, LIFT CORDS, PULL CORDS, CORD LOCKS, LIFT COR D TENSION SPRINGS, WASHERS, AND SUPPORTS AND CONNECTOR BALLS, FABRIC SUPPORT GUIDES AND FABRIC SUPPORT GUIDE HOLDING BRACKETS, CLAMPING PLATES, CLAMPING BUTTONS, TENSION SPRINGS AND BARREL CLAMPS, OPERATING HANDLES AND WANDS, FABRIC EYELET SETS, RIBBON, RIBBON CLAMPING SETS, TOP FIX BRACKETS-SPRING TYPE, TOP FIX TURNBUCKLE BRACKETS, FACE-FIX BRACKETS-SPRING TYPE, FACE FIX TURNBUCKLE BRACKETS, EXTENSION SPRING CLIP FACES FIX BRACKETS, EXTENSION FACE FIX TRUNBUCKLE BRACKET SETS-INTERNAL FIXING, AND APEX TURNBUCKLE BRACKET SETS-FACE FIXING, FOR ROLLER BLINDS- END SETS, PULL CORDS, PEN BALLS AND WASHERS, ACORNS, RING PULLS, HANDLES, COMPONENTS FOR SIDE CONTROL SYSTEMS (SIDE CHAIN) NAMELY; END SETS-UNIVERSAL, EXTENSION BRACKETS, CHAIN ROTATION CONNECTORS, ROLLERS, BOTTOM BARS, BOTTOM BAR WEIGHTS, BOTTOM BAR END CAPS, FABRIC LOCKING TAPE, SIDE CHANNELS, PELMET BARS AND BRACKETS, BRAID, POLES, AND FINNIALS, FOR VERTICAL BLINDS, COMMON SYSTEM- TILT RODS, SPACER BARS AND TUBES, CIRCLIPS, THRUST WASHERS, ADJUSTABLE END STOPS, SPACER LINKS, BLIND TRAVERSING CORDS, CORD WEIGHTS, SPRING CORD TENSIONERS, OPEN BALLS, CHAIN ROTATION, CONNECTORS, ADAPTOR ANGLE BRACKETS, EXTENSION/ADAPTOR ANGLE BRACKETS, PELMET BARS, LOUVER INSERTS, EXTENSION HOOKS, BALLAST WEIGHTS, AND STABILIZING CHAINS WITH "C" CLIPS, FOR VERTICAL BLINDS, "MAESTRO" SYSTEM- RIBBED CHANNELS WITH TILT RODS, SPACER BARS, END CAP SETS, THRUST WASHERS, CENTER ROD SUPPORTS WITH SPACER TUBES, CORD LOCKS, FACE FIX BRACKETS, SHALLOW FRAME FACE FIX BRACKETS, SPRING TYPE, ADJUSTABLE FACE FIX BRACKETS, EXTENSION TOP FIX BRACKETS, SIDE FIX BRACKETS, PELMET BRACKETS, AND CARRIER TRUCKS, SELF-ALIGNING, FOR VERTICAL BLINDS, "SLIMLINE" SYSTEM- RIBBED CHANNELS WITH TILT RODS, CHANNELS, FABRIC RECESSES WITH TILT RODS, FLEXIBLE TRACK JOINTS, END CAP SETS, CENTER ROD SUPPORTS WITH SPACER TUBES, ONE WAY ROD SUPPORTS WITH SPACER TUBES, FACE FIX BRACKETS, SCREW TYPE, TOP FIX BRACKETS, SPRING TYPE, ADJUSTABLE FACE FIX BRACKETS, EXTENSION TOP FIX BRACKETS, SHALLOW FRAME EXTENSION, EQUIPMENT FOR THE MANUFACTURE AND ASSEMBLY OF WINDOW BLINDS NAMELY, WORK STATIONS AND TABLES, SUPPORT LEGS WITH BRACES, INSPECTION FRAMES, FABRIC ATTACHMENT TRAYS, TOOL RACKS, TEMPLATES FOR MAKING SCALLOPS,

UNIVERSAL HANDRAIL AND TILT ROD CUTTING JIGS, TRACK ASSEMBLY JIGS AND FIXTURES, LOWER CUTTING JIGS AND FIXTURES, MEASURING JIGS, FABRIC BAR HOLDERS, FABRIC CLAMPS, FABRIC SUPPORT BARS, FABRIC FRONT TRAYS, BLADE HOLDERS, EQUIPLEAT FIXING BOARDS, FIXING BOARD SUPPORT FRAMES, CLAMPING SETS AND FABRIC SUPPORT FRAMES, FACE FIX BRACKETS, SIDE FIX BRACKETS, PELMET BRACKETS, CARRIER TRUCKS FIXED GEAR TYPE, SELF-ALIGNING TYPE AND SELF-ALIGNING "CUT-AWAY" TYPE, AND CORD LOCKS.

FIRST USE 0-0-1983; IN COMMERCE 0-0-1983.

ELEMENTS CORRECTED
GOODS/SERVICES

2,369,007. REG. 7-18-2000. RIPALTA S.N.C. DI MARCUZZI CLAUDIA E SUTOR ARMANDO (PARTNERSHIP), VIA D'ANNUNZIO 7, TREVISO, ITALY., SN 75-264,327. FILED 3-26-1997. PRINCIPAL REGISTER.

GRANSASSO

INT. CL. 19/U.S. CLS. 1, 12, 33 AND 50

FOR FIRED CERAMIC TILES, TILES OF - ENAMEL SANDSTONE, GRES, CLAY, GYPSUM, CERAMIC AND CERAMIC ENAMEL, EARTHENWARE, GLASS, ALL FOR WALL, FLOOR OR CEILING, WALL PANELS NOT OF METAL; CERAMIC WALL PANELS; NON-METAL ROOFING PANELS, NON-METAL CEILING PANELS, NON-METAL STEPS, STAIRCASES, NON-METAL WINDOW FRAMES, NON-METAL DOOR FRAMES, NON-METAL WINDOW CASEMENTS, NON-METAL DOOR CASINGS, NON-METAL CASTINGS; STATUES OF STONE; STATUES OF MARBLE; STONES; WINDOW GLASS; WINDOW PANES; GLASS PANELS; INSULATED GLASS; CEMENT POSTS; WOOD JOISTS; BRICKS; CONCRETE POSTS, CONCRETE SLABS, CONCRETE PANELS, PAVING TILES; NON-METAL CORNICES.

FIRST USE 1-2-2000; IN COMMERCE 1-28-2000.

INT. CL. 27/U.S. CLS. 19, 20, 37, 42 AND 50

FOR HARD SURFACE COVERINGS FOR FLOORS, RESILIENT HARD SURFACE COVERINGS FOR FLOORS, WALLS AND OTHER SURFACES.

FIRST USE 1-2-2000; IN COMMERCE 1-28-2000.

ELEMENTS CORRECTED
OWNER NAME

2,381,023. REG. 8-29-2000. JUNGLE LABORATORIES CORPORATION (TEXAS CORPORATION), P.O. BOX 630, CIBOLO, TX, 781080630, SN 75-706,379. FILED 5-14-1999. PRINCIPAL REGISTER.

FUNGUS ELIMINATOR

SEC. 2(F).

INT. CL. 5/U.S. CLS. 6, 18, 44, 46, 51 AND 52

FOR WATER CONDITIONING CHEMICALS, NAMELY, BIOCIDAL PREPARATIONS FOR EXTERMINATING FUNGUS AND [BACTERIAL] * BACTERIA * IN AQUARIUMS.

FIRST USE 9-0-1990; IN COMMERCE 9-0-1990.

ELEMENTS CORRECTED
GOODS/SERVICES

2,389,457. REG. 9-26-2000. NORDSTROM, INC. (WASHINGTON CORPORATION), 1617 - 6TH AVENUE, 6TH FLOOR, SEATTLE, WA, 98101, SN 75-681,310. FILED 4-13-1999. PRINCIPAL REGISTER.

PREVIEW COLLECTION

OWNER OF U.S. REG. NOS. 1,556,939 AND 2,014,715.
NO CLAIM IS MADE TO THE EXCLUSIVE RIGHT TO USE "COLLECTION", APART FROM THE MARK AS SHOWN.

INT. CL. 18/U.S. CLS. 1, 2, 3, 22 AND 41

FOR SMALL LEATHER GOODS, NAMELY, HANDBAGS, WALLETS, KEY CASES, COIN PURSES, COSMETIC CASES SOLD EMPTY, CELL PHONE CASES, CREDIT CARD HOLDERS, FANNY PACKS, BELT BAGS, BRIEF CASES, TOTE BAGS.

FIRST USE 8-0-1996; IN COMMERCE 8-0-1996.

ELEMENTS CORRECTED
FILING DATE

2,390,731. REG. 10-3-2000. Q-MED AKTIEBOLAG (SWEDEN CORPORATION), SEMINARIEGATAN 21, 752 28 UPPSALA, SWEDEN., SN 75-397,541. FILED 12-1-1997. PRINCIPAL REGISTER.



PRIORITY CLAIMED UNDER SEC. 44(D) ON SWEDEN APPLICATION NO. 97-08036, FILED 9-10-1997, REG. NO. 333346, DATED 10-1-1999, EXPIRES 10-1-2009.

OWNER OF U.S. REG. NO. 2,030,837.

INT. CL. 5/U.S. CLS. 6, 18, 44, 46, 51 AND 52

FOR TISSUE AUGMENTING GEL, NAMELY, A GEL INJECTED UNDER THE SKIN TO SMOOTH OUT WRINKLES.

FIRST USE ; IN COMMERCE .

ELEMENTS CORRECTED
PRIORITY CLAIMED STATEMENT

2,395,590. REG. 10-17-2000. TEACHERS FEDERAL CREDIT UNION (UNITED STATES FEDERAL CREDIT UNION) 2410 NORTH OCEAN AVENUE, FARMINGDALE, NY, 11738, SN 75-799,501. FILED 9-15-1999. PRINCIPAL REGISTER.



NO CLAIM IS MADE TO THE EXCLUSIVE RIGHT TO USE "TEACHERS FEDERAL CREDIT UNION", APART FROM THE MARK AS SHOWN.

THE MARK CONSISTS OF THE LETTERS "TFCU" IN A UNIQUE STYLIZED PRESENTATION AND THE WORDS "TEACHERS FEDERAL CREDIT UNION" OVER A DRAWING OF LONG ISLAND, NEW YORK.

INT. CL. 36/U.S. CLS. 100, 101 AND 102

FOR CREDIT UNION SERVICES.

FIRST USE 5-0-1999, THE WORDS " TEACHERS FEDERAL CREDIT UNION " WAS FIRST USED AS EARLY AS AUGUST 16, 1968. THE LETTERS " TFCU " WERE FIRST USED AT LEAST AS EARLY AS MAY 1986.; IN COMMERCE 5-0-1999.

ELEMENTS CORRECTED
USE IN ANOTHER FORM STATEMENT

2,399,935. REG. 10-31-2000. PNEUMOFOR S.P.A. (ITALY JOINT STOCK COMPANY), VIA SAGRA S. MICHELE, 66, TORINO, ITALY., SN 75-827,437. FILED 10-20-1999. PRINCIPAL REGISTER.



OWNER OF ERPN CMNTY TM OFC REG. NO. 366922, DATED 1-7-1999, EXPIRES 9-23-2006.

INT. CL. 37/U.S. CLS. 100, 103 AND 106

FOR INSTALLATION, MAINTENANCE AND REPAIR OF AIR CONDITIONING APPARATUS; MACHINERY MAINTENANCE AND REPAIR.

FIRST USE ; IN COMMERCE .

ELEMENTS CORRECTED
FOREIGN REG. EXPIRATION DATE

2,403,101. REG. 11-14-2000. GIESECKE & DEVRIENT GMBH (FED REP GERMANY CORPORATION), PRINZREGENSTRASSE 159, D-81677 MUNCHEN, FED REP GERMANY., SN 75-378,554. FILED 10-24-1997. PRINCIPAL REGISTER.

NOTAPACK

OWNER OF FED REP GERMANY REG. NO. 39718456, DATED 6-3-1997, EXPIRES 4-30-2007.

INT. CL. 7/U.S. CLS. 13, 19, 21, 23, 31, 34 AND 35

FOR PACKING MACHINES FOR DOCUMENTS, NAMELY, BANK NOTES, STOCKS, CHECKS, IDENTIFICATION CARDS, CREDIT CARDS AND BANK CARDS.

FIRST USE ; IN COMMERCE .

INT. CL. 16/U.S. CLS. 2, 5, 22, 23, 29, 37, 38 AND 50

FOR PRINTED MATTER, NAMELY, BANK NOTES, AND BANK CHECKS, STOCK CERTIFICATES, PAPER IDENTIFICATION CARDS, MEDICAL IDENTIFICATION CARDS, CREDIT CARDS AND BANK CARDS.

FIRST USE ; IN COMMERCE .

ELEMENTS CORRECTED
PRIORITY CLAIMED STATEMENT

2,410,184. REG. 12-5-2000. PIVOTAL CORPORATION (CANADA CORPORATION), 300-224 WEST ESPLANADE, NORTH VANCOUVER, BRITISH COLUMBIA, CANADA, V7M 3M6. SN 75-733,554. FILED 6-11-1999. PRINCIPAL REGISTER.

2,428,027. REG. 2-13-2001. PROTEUS, INC. (D.C. CORPORATION), 1233 20TH STREET, NW, SUITE 206, WASHINGTON, DC, 20036. SN 75-732,531. FILED 6-21-1999. PRINCIPAL REGISTER.

PIVOTAL ERELATIONSHIP



OWNER OF U.S. REG. NOS. 2,137,730 AND 2,220,681.
NO CLAIM IS MADE TO THE EXCLUSIVE RIGHT TO USE "ERELATIONSHIP", APART FROM THE MARK AS SHOWN.

INT. CL. 9/U.S. CLS. 21, 23, 26, 36 AND 38
FOR COMPUTER SOFTWARE FOR USE IN THE TOTAL MANAGEMENT OF CUSTOMER AND SALES PARTNER RELATIONSHIPS, NAMELY, CUSTOMER COMMUNICATIONS BY FACSIMILES, TELEPHONES, E-MAIL AND THE GLOBAL COMPUTER NETWORK; CUSTOMER CONTACT MANAGEMENT, NAMELY, STORAGE OF CUSTOMER PERSONNEL INFORMATION AND ADDRESSES; CLASSIFICATION OF CONTACTS BY TYPE; SCHEDULING OF APPOINTMENTS AND TASKS; RECORDING OF CUSTOMER INTERACTION; MAINTENANCE OF A COMMUNICATIONS LOG; AUTOMATIC GENERATION OF FOLLOW-UP ACTIVITIES; AUTOMATIC NOTIFICATION OF IMPORTANT EVENTS AND CUSTOMER INTERACTIONS; AND SALES MANAGEMENT, NAMELY, QUALIFICATION AND DISTRIBUTION OF LEADS.
FIRST USE 2-0-1999; IN COMMERCE 2-0-1999.

ELEMENTS CORRECTED
MARK

THE MARK CONSISTS OF A STYLIZED DRAWING OF AN EYE.
INT. CL. 42/U.S. CLS. 100 AND 101
FOR COMPUTER SERVICES, NAMELY, DESIGNING AND IMPLEMENTING WEB SITES FOR OTHERS AND INSTALLING APPLICATIONS FOR USE IN ALLOWING USERS TO PERFORM ELECTRONIC BUSINESS TRANSACTIONS VIA A GLOBAL COMPUTER NETWORK; AND CONSULTATION IN THE FIELD OF TECHNOLOGY, NAMELY, SYSTEMS INTEGRATION FOR OTHERS.
FIRST USE 5-10-1998; IN COMMERCE 5-10-1998.

ELEMENTS CORRECTED
MARK

2,427,442. REG. 2-6-2001. SAVE-A-LOT FOOD STORES, INC. (MISSOURI CORPORATION), 100 CORPORATE OFFICE DRIVE, EARTH CITY, MO, 63045, BY ASSIGNMENT MORAN FOODS, INC. (MISSOURI CORPORATION), EARTH CITY, MO, SN 75-642,368. FILED 2-17-1999. PRINCIPAL REGISTER.

2,429,038. REG. 2-20-2001. LINDSEY, BARBARA C. (UNITED STATES CITIZEN), 623 O'NEAL DRIVE, HOOVER, AL, 35226, SN 75-270,443. FILED 4-7-1997. PRINCIPAL REGISTER.

ABOUT MY FATHER'S BUSINESS

INT. CL. 16/U.S. CLS. 2, 5, 22, 23, 29, 37, 38 AND 50
FOR MOUNTED AND UNMOUNTED PHOTOGRAPHS; GRAPHIC ART REPRODUCTIONS.
FIRST USE 3-1-1997; IN COMMERCE 3-21-1997.

ELEMENTS CORRECTED
OWNER ADDRESS

TRESKY

2,432,495. REG. 3-6-2001. DINO LIFT OY (FINLAND CORPORATION), RAIKKOLANTIE 145, FIN-32210 LOIMAA, FINLAND., SN 75-372,133. FILED 10-14-1997. PRINCIPAL REGISTER.

DINO LIFT

INT. CL. 29/U.S. CL. 46
FOR PROCESSED NUTS.
FIRST USE 6-25-1999; IN COMMERCE 6-25-1999.

PRIORITY CLAIMED UNDER SEC. 44(D) ON ERPNCMNTY TM OFC APPLICATION NO. 000523480, FILED 4-23-1997, REG. NO. 523480, DATED 2-1-1999, EXPIRES 4-23-2007.
NO CLAIM IS MADE TO THE EXCLUSIVE RIGHT TO USE "LIFT", APART FROM THE MARK AS SHOWN.
INT. CL. 7/U.S. CLS. 13, 19, 21, 23, 31, 34 AND 35

ELEMENTS CORRECTED
ASSIGNMENT/NAME CHANGE
OWNER NAME
DATE OF FIRST USE IN COMMERCE

FOR MACHINES FOR THE CONSTRUCTION INDUSTRY, NAMELY, ELEVATORS, LIFTS AND ELEVATING WORK PLATFORMS.

2,446,088. REG. 4-24-2001. DATATRAC INFORMATION SERVICES, INC. (TEXAS CORPORATION), 2140 LAKE PARK BOULEVARD, SUITE 113, RICHARDSON, TX, 75080, SN 75-886,406. FILED 1-5-2000. PRINCIPAL REGISTER.

ELEMENTS CORRECTED
FOREIGN REG. DATE

2,435,532. REG. 3-13-2001. NATURE'S SUNSHINE PRODUCTS, INC. (UTAH CORPORATION), 75 EAST 1700 SOUTH, P. O. BOX 19005, PROVO, UT, 84605, SN 75-398,387. FILED 12-1-1997. PRINCIPAL REGISTER.



G-CRM

INT. CL. 3/U.S. CLS. 1, 4, 6, 50, 51 AND 52

FOR [NON-MEDICATED TOILET PREPARATIONS, NAMELY, HAND AND BODY SOAPS, BODY LOTIONS AND CONDITIONERS, SKIN SALVES, SKIN CREAM; SKIN LOTIONS AND SKIN CONDITIONING GELS; COSMETICS, NAMELY, FACIAL MOISTURIZERS, TONERS, CLEANSERS, SKIN TREATMENTS, EYE CREAMS; BATH AND SHOWER GELS, OILS, SOAPS AND SALTS; HAIR SHAMPOOS AND CONDITIONERS; MASSAGE LOTIONS, ESSENTIAL OILS FOR PERSONAL USE; TOOTHPASTE; NON-MEDICATED INHALATION SACHET; ALL-PURPOSE CLEANING PREPARATIONS; AND] BREATH FRESHENING TABLETS.

FIRST USE 1-31-1998; IN COMMERCE 1-31-1998.

ELEMENTS CORRECTED
GOODS/SERVICES

2,445,407. REG. 4-24-2001. EXPLORENT CHIRURGISCHE INSTRUMENTE GMBH (FED REP GERMANY LIMITED LIABILITY COMPANY) FOHRENSTRASSE 49, D-78532 TUTTLINGEN, FED REP GERMANY., SN 75-390,414. FILED 11-14-1997. PRINCIPAL REGISTER.

EXPLORENT

PRIORITY CLAIMED UNDER SEC. 44(D) ON ERPN CMNTY TM OFC APPLICATION NO. 000534867, FILED 5-14-1997, REG. NO. 534867, DATED 12-22-1999, EXPIRES 5-14-2007.

INT. CL. 10/U.S. CLS. 26, 39 AND 44

FOR SURGICAL AND MEDICAL APPARATUS AND INSTRUMENTS FOR EXAMINATION, TREATMENT, AND SURGERY IN THE FIELD OF EAR, NOSE AND THROAT, NAMELY, SUTURES; ARTIFICIAL LIMBS, EYES AND TEETH.

FIRST USE ; IN COMMERCE .

ELEMENTS CORRECTED
OWNER NAME

INT. CL. 35/U.S. CLS. 100, 101 AND 102

FOR BUSINESS MANAGEMENT CONSULTING SERVICES PROVIDED TO FEDERAL, STATE AND LOCAL AGENCIES RELATING TO THE DEVELOPMENT AND MAINTENANCE OF RELATIONSHIPS WITH MEMBERS OF THE PUBLIC, BUSINESS PROCESS RE-ENGINEERING, CUSTOMER SATISFACTION MEASUREMENT AND CUSTOMER SERVICE PROGRAMS, NAMELY, CONDUCTING BUSINESS RESEARCH AND BUSINESS SURVEYS; AND OUTSOURCED TELEPHONE CALL CENTER, E-MAIL AND GLOBAL COMPUTER NETWORK TRANSACTION HANDLING SERVICES.

FIRST USE 2-24-2000; IN COMMERCE 2-24-2000.

INT. CL. 37/U.S. CLS. 100, 103 AND 106

FOR INSTALLATION, UPGRADE AND MAINTENANCE OF CALL CENTER HARDWARE, CONTACT MANAGEMENT AND CUSTOMER INTERACTION SYSTEMS, COMPUTER TELEPHONY INTEGRATION, INTERACTIVE VOICE RESPONSE SYSTEMS, E-MAIL AND INTERACTIVE SYSTEMS PROVIDED OVER A GLOBAL COMPUTER NETWORK, FOR FEDERAL, STATE AND LOCAL AGENCIES.

FIRST USE 2-24-2000; IN COMMERCE 2-24-2000.

INT. CL. 41/U.S. CLS. 100, 101 AND 107

FOR TRAINING SERVICES PROVIDED TO FEDERAL, STATE AND LOCAL AGENCIES RELATED TO THE DEVELOPMENT AND MAINTENANCE OF RELATIONSHIPS WITH MEMBERS OF THE PUBLIC, NAMELY, CONDUCTING SEMINARS, CLASSES AND WORKSHOPS IN THE FIELD OF ADVANCED COMMUNICATION SKILLS, GRAMMAR, PRONUNCIATION AND VOCABULARY, ACTIVE LISTENING, BUILDING REPORT, SKILLFUL USE OF QUESTIONS, CALL FLOW MANAGEMENT, AND HANDLING DIFFICULT CALLERS.

FIRST USE 2-24-2000; IN COMMERCE 2-24-2000.

INT. CL. 42/U.S. CLS. 100 AND 101

FOR CONSULTATION SERVICES PROVIDED FOR FEDERAL, STATE AND LOCAL AGENCIES RELATING TO INFORMATION TECHNOLOGY AND INFORMATION MANAGEMENT, COMPUTERS, NETWORKS, TELEPHONY SYSTEMS, AND SOFTWARE; AND INSTALLATION AND MAINTENANCE OF COMPUTER SOFTWARE SYSTEMS, NAMELY, ACD/PBX SYSTEMS.

FIRST USE 2-24-2000; IN COMMERCE 2-24-2000.

ELEMENTS AMENDED
OWNER ADDRESS

2,454,365. REG. 5-29-2001. M.G. - MINI GEARS S.P.A. (ITALY JOINT STOCK COMPANY), VIA LUSSEMBURGO, 25/27, PADOVA ZONA INDUSTRIALE, ITALY., SN 75-378,151. FILED 10-23-1997. PRINCIPAL REGISTER.



PRIORITY CLAIMED UNDER SEC. 44(D) ON ITALY APPLICATION NO. 000247, FILED 5-9-1997, REG. NO. 00799737, DATED 5-9-1997, EXPIRES 5-9-2007. INT. CL. 7/U.S. CLS. 13, 19, 21, 23, 31, 34 AND 35 FOR TRANSMISSION GEARS FOR MACHINES, NAMELY, SPEED REDUCTION GEARS AND EPICYCLOIDAL SPEED REDUCTION GEARS. FIRST USE ; IN COMMERCE .

ELEMENTS CORRECTED
FOREIGN REG. DATE

2,457,909. REG. 6-5-2001. E. & J. GALLO WINERY (CALIFORNIA CORPORATION), 600 YOSEMITE BOULEVARD, MODESTO, CA, 95354, SN 75-576,387. FILED 10-27-1998. PRINCIPAL REGISTER.

BELLA SERA

THE ENGLISH TRANSLATION OF THE TERM "BELLA SERA" IS BEAUTIFUL EVENING. INT. CL. 33/U.S. CLS. 47 AND 49 FOR WINES. FIRST USE 6-27-2000; IN COMMERCE 6-27-2000.

ELEMENTS AMENDED
MARK

2,460,482. REG. 6-12-2001. ERCO LEUCHTEN GMBH (FED REP GERMANY CORPORATION), BROCKHAUSER WEG 78-82, 58507 LUDENSCHIED, FED REP GERMANY., SN 75-865,742. FILED 11-2-1999. PRINCIPAL REGISTER.

LUCY

OWNER OF FED REP GERMANY REG. NO. 2903894, DATED 3-28-1995, EXPIRES 10-13-2009. INT. CL. 11/U.S. CLS. 13, 21, 23, 31 AND 34

FOR ELECTRIC LIGHTING FIXTURES AND ELECTRIC LIGHTING FIXTURE SYSTEMS COMPRISING BASES, SOCKETS, SOCKET HOLDERS AND COVERS SOLD TOGETHER . FIRST USE 1-1-1996; IN COMMERCE 12-31-1998.

ELEMENTS CORRECTED
FOREIGN REG. EXPIRATION DATE

2,465,068. REG. 7-3-2001. LEO BURNETT WORLDWIDE, INC. (DELAWARE CORPORATION), 35 W. WACKER DRIVE, CHICAGO, IL, 60601, BY CHANGE OF NAME LEO GROUP, INC. THE (DELAWARE CORPORATION), CHICAGO, IL, SN 75-769,382. FILED 8-4-1999. PRINCIPAL REGISTER.



Starcom

INT. CL. 35/U.S. CLS. 100, 101 AND 102 FOR ADVERTISING AGENCY SERVICES, NAMELY MEDIA BUYING SERVICES AND EVENT MARKETING AND PROMOTION SERVICES. FIRST USE 3-24-1999; IN COMMERCE 3-24-1999.

ELEMENTS CORRECTED
ASSIGNMENT/NAME CHANGE
OWNER NAME

2,465,104. REG. 7-3-2001. SOLVAY (SOCIETE ANONYME) (BELGIUM CORPORATION), 33 RUE DU PRINCE ALBERT, B-1050 BRUSSELS, BELGIUM., SN 75-794,553. FILED 9-8-1999. PRINCIPAL REGISTER.

SOLVIN

OWNER OF BENELUX REG. NO. 649908, DATED 3-9-1999, EXPIRES 3-9-2009. INT. CL. 1/U.S. CLS. 1

FOR CHEMICAL SUBSTANCES AND ADDITIVES FOR USE IN THE MANUFACTURE OF PLASTICS; VINYL CHLORIDE POLYMERS, COPOLYMERS, COMPOUNDS AND PREMIXES, [VINYLIDINE] * VINYLIDENE * CHLORIDE POLYMERS, COPOLYMERS AND COMPOUNDS FOR INDUSTRIAL USE AND FOR USE IN FURTHER MANUFACTURING; ARTIFICIAL UN-PROCESSED RESINS FOR INDUSTRIAL USE AND FOR USE IN FURTHER MANUFACTURING. FIRST USE ; IN COMMERCE .

INT. CL. 17/U.S. CLS. 1, 5, 12, 13, 35 AND 50 FOR PLASTIC IN EXTRUDED FORM FOR GENERAL INDUSTRIAL USE. FIRST USE ; IN COMMERCE .

ELEMENTS CORRECTED
GOODS/SERVICES

2,465,897. REG. 7-3-2001. METAPATH SOFTWARE INTERNATIONAL (US), INC. (DELAWARE CORPORATION), 777 - 108TH AVENUE, N.E., SUITE 200, BELLEVUE, WA, 98004, BY CHANGE OF NAME; BY MERGER; BY CHANGE OF NAME METAPATH CORPORATION (DELAWARE CORPORATION), REDMOND, WA, SN 75-220,949. FILED 1-3-1997. PRINCIPAL REGISTER.

CEOS

INT. CL. 42/U.S. CLS. 100 AND 101
FOR CONSULTING RELATING TO COMPUTER HARDWARE AND SOFTWARE IN THE FIELD OF COMMUNICATIONS AND UPDATING OF COMPUTER COMMUNICATIONS SOFTWARE FOR THIRD PARTIES. FIRST USE 1-9-1997; IN COMMERCE 1-9-1997.

ELEMENTS CORRECTED
ASSIGNMENT/NAME CHANGE
OWNER NAME

2,471,661. REG. 7-24-2001. ABBIGLIAMENTO RIBO' S.R.L. (ITALY ITALIAN JOINT STOCK COMPANY WITH LIMITED LIABILITY) VIALE ARTIGIANATO 32, 37064 POVEGLIANO VERONESE (VR), ITALY., SN 76-096,992. FILED 7-27-2000. PRINCIPAL REGISTER.

EMPORIUM VIRI

OWNER OF ITALY REG. NO. 630234, DATED 9-27-1994, EXPIRES 9-27-2004.

INT. CL. 25/U.S. CLS. 22 AND 39
FOR CLOTHING, NAMELY, JACKETS, COATS, DRESSES, TROUSERS, PANTS, SKIRTS, SWEATERS, BLOUSES, PULLOVERS, CARDIGANS, SWEATSHIRTS, TRACKSUITS, SHIRTS, POLO SHIRTS, T-SHIRTS, VESTS, TANK TOPS, PAJAMAS, NECKTIES, MANTLES, GLOVES, STOCKINGS, TIGHTS, SOCKS, SUSPENDERS, BELTS, ROBES, SWIMSUITS, AND BATHROBES.

ELEMENTS CORRECTED
ENTITY

2,476,955. REG. 8-14-2001. WACKER-CHEMIE GMBH (FED REP GERMANY LIMITED LIABILITY COMPANY) HANNS-SEIDEL-PLATZ 4, D-81737 MUNICH, FED REP GERMANY., SN 75-484,818. FILED 5-14-1998. PRINCIPAL REGISTER.

CAVAMAX

PRIORITY CLAIMED UNDER SEC. 44(D) ON FED REP GERMANY APPLICATION NO. 39755428.1, FILED 11-19-1997, REG. NO. 39755428, DATED 4-24-1998, EXPIRES 11-30-2007.

INT. CL. 1/U.S. CLS. 1

FOR CHEMICALS, NAMELY, OLIGOSACCHARIDES AND POLYSACCHARIDES AND THEIR DERIVATIVES FOR USE IN THE CHEMICAL, PLASTICS, PAPER, PHOTOGRAPHY, AGRICULTURAL, HORTICULTURAL, FORESTRY, BUILDING, CONSTRUCTION, INSULATION, PACKAGING, PHARMACEUTICAL, COSMETIC, FRAGRANCE, TEXTILE, LEATHER, HEALTHCARE, FOOD AND PAINT INDUSTRIES; CHEMICALS, NAMELY, CYCLODEXTRINS AND CYCLODEXTRIN DERIVATIVES FOR USE IN THE CHEMICAL, PLASTICS, PAPER, PHOTOGRAPHY, AGRICULTURAL, HORTICULTURAL, FORESTRY, BUILDING, CONSTRUCTION, INSULATION, PACKAGING, PHARMACEUTICAL, COSMETIC, FRAGRANCE, TEXTILE, LEATHER, HEALTHCARE, FOOD AND PAINT INDUSTRIES; CHEMICAL COMPOUNDS WHICH COMPRISE CYCLODEXTRINS AND CYCLODEXTRIN DERIVATIVES FOR USE IN THE CHEMICAL, PLASTICS, PAPER, PHOTOGRAPHY, AGRICULTURAL, HORTICULTURAL, FORESTRY, BUILDING, CONSTRUCTION, INSULATION, PACKAGING, PHARMACEUTICAL, COSMETIC, FRAGRANCE, TEXTILE, LEATHER, HEALTHCARE, FOOD AND PAINT INDUSTRIES; CHEMICAL SOLUTIONS, DISPERSIONS, EMULSIONS AND POLYMERIC MATERIALS WHICH COMPRISE CYCLODEXTRINS AND CYCLODEXTRIN DERIVATIVES FOR USE IN THE CHEMICAL, PLASTICS, PAPER, PHOTOGRAPHY, AGRICULTURAL, HORTICULTURAL, FORESTRY, BUILDING, CONSTRUCTION, INSULATION, PACKAGING, PHARMACEUTICAL, COSMETIC, FRAGRANCE, TEXTILE, LEATHER, HEALTHCARE, FOOD AND PAINT INDUSTRIES; CHEMICAL AGENTS FOR IMPREGNATING, BINDING OR COATING TEXTILES, FURS, LEATHER, NON-WOVENS AND FABRICS; CHEMICAL ANTI-FOAM AND FLOW CONTROL AGENTS FOR LIQUIDS; CHEMICAL SOFTENERS FOR TEXTILES; CHEMICAL THICKENERS AND THIXOTROPIC RELEASE AGENTS FOR USE IN THE MANUFACTURE OF VARNISHES, PAINTS, ADHESIVES AND PAINTS; CHEMICAL ADDITIVES FOR USE IN THE MANUFACTURE OF PRESERVATIVES; CHEMICAL BINDERS FOR USE IN THE MANUFACTURE OF PAINTS, VARNISHES AND GLUES; CHEMICAL ADDITIVES FOR USE IN THE MANUFACTURE OF COSMETICS; RAW MATERIALS, ACTIVE SUBSTANCES AND AUXILIARIES, NAMELY, CYCLODEXTRIN[E]S AND CYCLODEXTRIN DERIVATIVES FOR USE IN THE MANUFACTURE OF PHARMACEUTICALS, CROP PROTECTION COMPOSITIONS AND PEST CONTROL COMPOSITIONS; CHEMICALS USED IN AGRICULTURE, NAMELY, SEED DRESSINGS; CHEMICALS IN THE NATURE OF RAW MATERIALS, NAMELY, CYCLODEXTRINS AND CYCLODEXTRIN DERIVATIVES FOR USE IN THE MANUFACTURE OF COATINGS; CHEMICALS, NAMELY, CYCLODEXTRINS AND CYCLODEXTRIN DERIVATIVES FOR USE IN THE MANUFACTURE OF COSMETICS; CHEMICAL ADDITIVES, NAMELY, OLIGOSACCHARIDES AND POLYSACCHARIDES AND THEIR DERIVATIVES, CYCLODEXTRINS AND CYCLODEXTRIN DERIVATIVES FOR USE IN THE MANUFACTURE OF PHARMACEUTICALS.
FIRST USE ; IN COMMERCE .

INT. CL. 2/U.S. CLS. 6, 11 AND 16
FOR PAINTS FOR ARTISTS, EXTERIOR SURFACES, INTERIOR SURFACES, METAL SURFACES, FURNITURE, CONCRETE FLOORS, WOOD FLOORS AND HOUSES; VARNISHES; LACQUERS IN THE NATURE OF A COATING; WOOD PRESERVATIVES; LEVELING AGENTS; BINDERS AND DILUENTS FOR PAINTS AND COATINGS; BACTERICIDAL PAINTS; FIREPROOF AND HAMMER FINISH ADDITIVES FOR LACQUERS[,] * ; * LACQUERS FOR COATING ELECTRICAL AND ELECTRONIC PARTS AND COMPONENTS; COATINGS IN THE NATURE OF AUTOMOBILE FINISHING; THICKENERS FOR PAINTS; POLYMERIC COATINGS WHICH COMPRISE CYCLODEXTRINS AND CYCLODEXTRIN DERIVATIVES FOR USE IN THE CHEMICAL, PLASTIC * S * PAPER, PHOTOGRAPHY, AGRICULTURAL, HORTICULTURAL, FORESTRY, BUILDING, CONSTRUCTION, INSULATION, PACKAGING, PHARMACEUTICAL, COSMETIC, FRAGRANCE, TEXTILE, LEATHER, HEALTHCARE, FOOD AND PAINT INDUSTRIES.
FIRST USE ; IN COMMERCE .

INT. CL. 3/U.S. CLS. 1, 4, 6, 50, 51 AND 52

FOR CLEANING, POLISHING, AND ABRASIVE PREPARATIONS CONTAINING CYCLODEXTRINS AND CYCLODEXTRIN DERIVATIVES USED IN THE CHEMICAL, PLASTICS, METALLURGICAL, GLASS, PAPER, CERAMIC, PHOTOGRAPHY, AGRICULTURAL, FORESTRY, COMMERCIAL AND RESIDENTIAL BUILDING, AUTOMOBILE, AUTOMOTIVE, ELECTRONICS, PHARMACEUTICAL, COSMETIC, HEALTH CARE AND PAINT INDUSTRIES; ROOM FRAGRANCES; PERFUME; CYCLODEXTRINS AND CYCLODEXTRIN DERIVATIVES SOLD AS AN INTEGRAL COMPONENT OF COSMETICS; DETERGENTS FOR MEDICAL PURPOSES.
FIRST USE ; IN COMMERCE .

INT. CL. 5/U.S. CLS. 6, 18, 44, 46, 51 AND 52
FOR OLIGOSACCHARIDES AND POLYSACCHARIDES AND THEIR DERIVATIVES, CYCLODEXTRINS AND CYCLODEXTRIN DERIVATIVES USED AS AUXILIARIES AND ADDITIVES AND AS CARRIERS, ALL SOLD AS INTEGRAL COMPONENTS OF PHARMACEUTICALS; CROP PROTECTION PRODUCTS FOR INDUSTRIAL PURPOSES, NAMELY, FUNGICIDES AND HERBICIDES; PEST CONTROL COMPOSITIONS FOR INDUSTRIAL USE, NAMELY PESTICIDES AND INSECTICIDES; BIOCIDES FOR DOMESTIC AND AGRICULTURAL USE; AND ANIMAL FEEDS FOR USE AS A NUTRITIONAL SUPPLEMENT.
FIRST USE ; IN COMMERCE .

INT. CL. 16/U.S. CLS. 2, 5, 22, 23, 29, 37, 38 AND 50
FOR PACKAGING MATERIALS, NAMELY, FILMS OF PLASTIC, COATED CARDBOARD; PRESSURE SENSITIVE ADHESIVE FILMS AND ADHESIVE TAPES FOR STATIONERY AND HOUSEHOLD PURPOSES.
FIRST USE ; IN COMMERCE .

ELEMENTS CORRECTED
GOODS/SERVICES

2,477,024. REG. 8-14-2001. WALLACE-O'FARRELL MARKETING, INC. (WASHINGTON CORPORATION), 11302 164TH STREET EAST, PUYALLUP, WA, 98374, SN 75-584,652. FILED 11-5-1998. PRINCIPAL REGISTER.

BEAUX GEST

INT. CL. 3/U.S. CLS. 1, 4, 6, 50, 51 AND 52
FOR SCENTED OIL CONTAINING AN ANDROGENIC HORMONE FOR PERSONAL USE.
FIRST USE 4-20-1990; IN COMMERCE 4-20-1990.

ELEMENTS CORRECTED
OWNER NAME

2,477,327. REG. 8-14-2001. PIERRE FABRE, S.A. (FRANCE SOCIETE ANONYM) 45, PLACE ABEL GANCE, 92100 BOULOGNE, FRANCE., AND PIERRE FABRE, S.A. (FRANCE SOCIETE ANONYME) 45, PLACE ABEL GANCE, 92100 BOULOGNE, FRANCE., SN 75-822,782. FILED 10-14-1999. PRINCIPAL REGISTER.

YDEALYS

OWNER OF FRANCE REG. NO. 97710687, DATED 12-17-1997, EXPIRES 12-17-2007.

INT. CL. 3/U.S. CLS. 1, 4, 6, 50, 51 AND 52
FOR COSMETICS AND CLEANING PREPARATIONS, NAMELY TOILET SOAPS, PERFUMES, ESSENTIAL OILS FOR PERSONAL USE, SKIN CREAMS, OILS, GELS, LOTIONS, MILKS AND EMULSIONS, NON-MEDICATED SKIN BALMS, MAKE-UP, FOUNDATION, MASCARA, EYE LINER, NON-MEDICATED HAIR CARE PREPARATIONS.
FIRST USE ; IN COMMERCE .

INT. CL. 5/U.S. CLS. 6, 18, 44, 46, 51 AND 52

FOR PHARMACEUTICALS, NAMELY, PREPARATIONS FOR THE TREATMENT OF ALLERGY, CANCER, ASTHMA AND CARDIOVASCULAR DISEASES, PSYCHIATRIC, RESPIRATORY, UROLOGIC AND DERMATOLOGIC DISORDERS AND DISEASES, MEDICATED DERMO-COSMETICS FOR HYGIENE AND CARE OF THE SKIN AND HAIR; DIETARY FOOD SUPPLEMENTS.
FIRST USE ; IN COMMERCE .

ELEMENTS CORRECTED
GOODS/SERVICES

2,480,300. REG. 8-21-2001. JOBSERVE LIMITED (UNITED KINGDOM CORPORATION), TOWER BUSINESS PARK, KELVEDON ROAD, TIPTREE, ESSEX, UNITED KINGDOM, CO5 0LX, SN 75-485,560. FILED 5-15-1998. PRINCIPAL REGISTER.

JobServe

OWNER OF UNITED KINGDOM REG. NO. 1577449, DATED 7-14-1994, EXPIRES 7-7-2001.

INT. CL. 35/U.S. CLS. 100, 101 AND 102
FOR COMPUTERIZED DATABASE MANAGEMENT; PERSONNEL PLACEMENT AND RECRUITMENT THROUGH AN ELECTRIC BILLBOARD AND THROUGH A GLOBAL COMPUTER NETWORK .
FIRST USE 5-4-1994; IN COMMERCE 10-0-1997.

ELEMENTS CORRECTED
OWNER ADDRESS

2,483,534. REG. 8-28-2001. CUSTOM ROTO-MOLD, INC. (MINNESOTA CORPORATION), 140 30TH AVENUE SE, P. O. BOX 159, BENSON, MN, 56215, SN 75-843,041. FILED 11-5-1999. PRINCIPAL REGISTER.

PORTAPOND

INT. CL. 20/U.S. CLS. 2, 13, 22, 25, 32 AND 50
FOR PORTABLE CONTAINER FOR TRANSFERRING [ACQUICULTURE] * ACQUACULTURE *.
FIRST USE 6-1-2000; IN COMMERCE 6-1-2000.

ELEMENTS CORRECTED
GOODS/SERVICES

2,484,599. REG. 9-4-2001. ARTURO SALICE S.P.A. (ITALY CORPORATION), VIA PROVINCIALE NOVEDRATESE 10, 22060 NOVEDRATE (COMO), ITALY., SN 75-892,921. FILED 1-10-2000. PRINCIPAL REGISTER.

2,491,673. REG. 9-25-2001. KAWAI, TAKEO (JAPAN CITIZEN), 69-20 TORIGAOKA TOTSUKA-KU, YOKOHAMA-SHI, JAPAN., SN 75-468,559. FILED 4-15-1998. PRINCIPAL REGISTER.



川井筋系帯療法

PRIORITY CLAIMED UNDER SEC. 44(D) ON ITALY APPLICATION NO. MI99C009122, FILED 9-10-1999, REG. NO. 802110, DATED 9-27-2000, EXPIRES 9-10-2009.

OWNER OF U.S. REG. NOS. 1,357,597 AND 1,367,302.

THE MARK IS LINED FOR THE COLOR ORANGE.

INT. CL. 6/U.S. CLS. 2, 12, 13, 14, 23, 25 AND 50

FOR METAL GOODS, NAMELY, SLIDES FOR FURNITURE SHUTTERS, WINDOW SHUTTERS, DRAWERS, CABINET DOORS AND SHELVES; METAL HINGES; METAL FASTENERS, NAMELY, BOLTS, NAILS, RIVETS, SCREWS FOR FURNITURE AND, CONSTRUCTION; SMALL METAL GOODS AND METAL FITTINGS, NAMELY METAL KNOBS, SCREWS, NUTS, PLATES, BARS, ESCUTCHEONS, DOOR, WINDOW AND DRAWER TRIM, PULLS, HANDLES, CATCHES, LATCHES, HOOKS, EYES, STOPS, SLIDES AND HANDLES FOR USE WITH FURNITURE, DOORS AND BUILDINGS.

FIRST USE ; IN COMMERCE .

ELEMENTS CORRECTED
FOREIGN REG. DATE

OWNER OF JAPAN REG. NO. 3202526, DATED 9-30-1996, EXPIRES 9-30-2006.

NO CLAIM IS MADE TO THE EXCLUSIVE RIGHT TO USE "NON-LATIN CHARACTERS THAT TRANSLITERATE TO MUSCULAR SYSTEM AREA THERAPY METHOD", APART FROM THE MARK AS SHOWN.

THE NON-LATIN CHARACTERS IN THE MARK TRANSLITERATE TO KAWAI KINKETAI RYOHO AND THIS MEANS MUSCULAR SYSTEM AREA THERAPY METHOD IN ENGLISH.

INT. CL. 42/U.S. CLS. 100 AND 101

FOR MUSCULAR THERAPY SERVICES, NAMELY, NORMALIZATION OF MUSCLES AND ARTICULATION OF THE HUMAN BODY BY ACTING ON MUSCLES AND ARTICULATION BY HAND.

FIRST USE 5-1-1996; IN COMMERCE 5-1-1996.

ELEMENTS CORRECTED
TRANSLATION OF MARK

2,486,359. REG. 9-4-2001. INTERNATIONAL BRACHYTHERAPY, S.A. (BELGIUM CORPORATION), ZONE INDUSTRIELLE C, 7180 SENEFFE, BELGIUM., SN 75-530,286. FILED P.R. 8-4-1998; AM. S.R. 8-22-2000. SUPPLEMENTAL REGISTER.

INTERNATIONAL
BRACHYTHERAPY

NO CLAIM IS MADE TO THE EXCLUSIVE RIGHT TO USE "BRANCHYTHERAPY", APART FROM THE MARK AS SHOWN.

THE MARK CONSISTS OF THE TERMS SHOWN IN THE DRAWING, WITHOUT STYLIZATION OR THE USE OF ANY PARTICULAR TYPEFACE.

INT. CL. 10/U.S. CLS. 26, 39 AND 44

FOR HOUSE MARK FOR MEDICAL DEVICES, NAMELY, RADIOTHERAPY MEDICAL DEVICES.

FIRST USE 8-21-2000; IN COMMERCE 8-1-2000.

ELEMENTS CORRECTED
OWNER NAME
DESCRIPTION OF MARK

2,494,343. REG. 10-2-2001. SANDLER SYSTEMS, INC. (MARYLAND CORPORATION), 10411 STEVENSON ROAD, STEVENSON, MD, 21153, SN 76-141,328. FILED 10-6-2000. PRINCIPAL REGISTER.

Sandlerworks!

OWNER OF U.S. REG. NO. 2,077,423.

INT. CL. 41/U.S. CLS. 100, 101 AND 107

FOR EDUCATIONAL SERVICES, NAMELY, CONDUCTING SEMINARS, WORKSHOPS AND COACHING REINFORCEMENT INSTRUCTION RELATING TO THE AREAS OF SALES AND SALES MANAGEMENT.

FIRST USE 2-10-1998; IN COMMERCE 2-24-1998.

ELEMENTS CORRECTED
MARK

2,495,417. REG. 10-9-2001. DA VIA' LUIGI S.R.L. (ITALY LIMITED LIABILITY COMPANY) VIA F. COLETTI, 104, PIEVE DI CADORE, FRAZIONE TAI (BELLUNO), ITALY., SN 75-733,513. FILED 6-21-1999. PRINCIPAL REGISTER.



DA VIA LUIGI

PRIORITY CLAIMED UNDER SEC. 44(D) ON ERPNTY TM OFC APPLICATION NO. 1121268, FILED 3-29-1999, REG. NO. 1121268, DATED 7-26-2000, EXPIRES 3-29-2010.

THE MARK CONSISTS, IN PART, OF THE STYLIZED LETTERS "D" AND "V" IN A CIRCLE.

INT. CL. 9/U.S. CLS. 21, 23, 26, 36 AND 38

FOR EYEGLASSES, SUNGLASSES, SPECTACLE CASES, SPECTACLE FRAMES, SPECTACLE CHAINS, PADS FOR EYEGLASSES, PAD ARMS FOR EYEGLASSES, TEMPLE TIPS FOR EYEGLASSES.

ELEMENTS CORRECTED
FOREIGN REG. DATE

2,498,840. REG. 10-16-2001. PLAUENER SPINNHUTTE GMBH (FED REP GERMANY LIMITED LIABILITY COMPANY) CELLER STRASSE 20, 08525 PLAUEN, FED REP GERMANY., SN 75-730,671. FILED 6-22-1999. PRINCIPAL REGISTER.

CLARA S.

PRIORITY CLAIMED UNDER SEC. 44(D) ON FED REP GERMANY APPLICATION NO. 74.446-7, FILED 12-24-1998, REG. NO. 39874446, DATED 6-10-1999, EXPIRES 12-31-2008.

THE NAME "CLARA S." DOES NOT IDENTIFY A LIVING INDIVIDUAL.

INT. CL. 24/U.S. CLS. 42 AND 50

FOR BED LINEN AND BEDDING ITEMS, NAMELY BED SHEETS, PILLOW CASES, PILLOW SHAMS, PILLOW TICKS, NAMELY, CLOTH CASES FOR PILLOWS, BLANKET COVERS, BED SPREADS AND DUST RUFFLES; FABRICS FOR COVERING PILLOWS MADE OF NATURAL SILK OR MIXED FABRICS WITH CONTENT OF NATURAL SILK.

FIRST USE 4-1-2000; IN COMMERCE 4-1-2000.

INT. CL. 25/U.S. CLS. 22 AND 39

FOR CLOTHING, NAMELY, SHIRTS, PANTS, T-SHIRTS, SHORTS, JACKETS, TIES, NEGLIGÉES, BLOUSES, SKIRTS, DRESSES, TANK SHIRTS, SLACKS AND SCARVES MADE OF NATURAL SILK OR MIXED FABRICS WITH A CONTENT OF NATURAL SILK.

FIRST USE 4-1-2000; IN COMMERCE 4-1-2000.

ELEMENTS CORRECTED
FOREIGN APPLICATION NO.

2,505,811. REG. 11-13-2001. REYNARD, ADRIAN JOHN (UNITED KINGDOM CITIZEN), CHALET CHAPERON ROUGE, APARTMENT A9, 1885 CHESIÈRES, SWITZERLAND., SN 75-739,272. FILED 6-29-1999. PRINCIPAL REGISTER.



OWNER OF UNITED KINGDOM REG. NO. 2179778, DATED 10-16-1998, EXPIRES 10-16-2008.

INT. CL. 7/U.S. CLS. 13, 19, 21, 23, 31, 34 AND 35

FOR MOTORS AND ENGINES FOR MACHINES, MACHINE COUPLINGS AND TRANSMISSION PARTS, MACHINE TOOLS, DRILLING MACHINES AND PUNCHES, EXHAUSTS FOR MACHINES, PARTS FOR ALL THE FOREGOING.

FIRST USE : IN COMMERCE .

INT. CL. 9/U.S. CLS. 21, 23, 26, 36 AND 38

FOR AUDIO AND VIDEO RECORDERS, MAGNETIC DATA CARRIERS, PRE-RECORDED AUDIO AND VIDEO DISCS, COMPACT DISCS, AND CASSETTES; COMPUTER SOFTWARE PROGRAMS RELATING TO THE DESIGN OF VEHICLES AND PARTS OF VEHICLES; COMPUTER GAMES SOFTWARE PROGRAMS, VIDEO GAME MACHINES, ARCADE AMUSEMENT GAME MACHINES, MAGNETICALLY ENCODED, PREPAID TELEPHONE CARDS, EYE GLASSES, SUNGLASSES AND PARTS FOR EYE GLASSES AND SUNGLASSES.

FIRST USE : IN COMMERCE .

INT. CL. 12/U.S. CLS. 19, 21, 23, 31, 35 AND 44

FOR VEHICLES, NAMELY, CARS, MOTORCYCLES, AIR PLANES, TRAINS, BUSES, LORRIES, VANS, HELICOPTERS, BICYCLES, SHIPS, BOATS, TIRES FOR AUTOMOBILES, AND STRUCTURAL PARTS FOR ALL THE FOREGOING.

FIRST USE : IN COMMERCE .

INT. CL. 18/U.S. CLS. 1, 2, 3, 22 AND 41

FOR LEATHER AND IMITATIONS OF LEATHER, ARTICLES MADE FROM LEATHER AND IMITATIONS OF LEATHER, NAMELY, BAGS, CASES, TRUNKS, SPORT BAGS, BEACH BAGS, BELTS, CARD CASES, TRAVEL BAGS, SOLD EMPTY, KEY CASES, WALLETS, PURSES, RUCKSACKS, AND PARTS FOR THE FOREGOING.

FIRST USE : IN COMMERCE .

INT. CL. 25/U.S. CLS. 22 AND 39

FOR HEADGEAR, NAMELY, HATS.

FIRST USE : IN COMMERCE .

INT. CL. 42/U.S. CLS. 100 AND 101

FOR DESIGN, ENGINEERING, AND PROTOTYPING SERVICES FOR RACE CARS; DESIGNING SERVICE FOR RACE CARS USING COMPUTER MODELLING AND TESTING; AND DEVELOPING FUTURE DESIGNS FOR RACE CARS.

FIRST USE : IN COMMERCE .

ELEMENTS CORRECTED
OWNER NAME

2,507,276. REG. 11-13-2001. RIVIERA TRADING INC (DELAWARE CORPORATION), 90 PARK AVE, NEW YORK, NY, 10016, BY ASSIGNMENT RIVIERA TRADING CORPORATION (NEW YORK CORPORATION), NEW YORK, NY, SN 74-244,048. FILED 2-7-1992. PRINCIPAL REGISTER.

RIVIERA KIDS

OWNER OF U.S. REG. NOS. 641,457 AND 657,116. NO CLAIM IS MADE TO THE EXCLUSIVE RIGHT TO USE "KIDS", APART FROM THE MARK AS SHOWN.
INT. CL. 9/U.S. CLS. 21, 23, 26, 36 AND 38

FOR SUNGLASSES.
 FIRST USE 4-22-1992; IN COMMERCE 4-22-1992.
 INT. CL. 14/U.S. CLS. 2, 27, 28 AND 50
 FOR CHILDREN'S JEWELRY; NAMELY, NECK-
 LACES, EARRINGS, BRACELETS, PINS, ORNAMENTS
 IN THE NATURE OF SHOE CLIPS, DRESS PINS AND
 CLIPS, SHIRT PINS AND CLIPS.
 FIRST USE 4-22-1992; IN COMMERCE 4-22-1992.
 INT. CL. 26/U.S. CLS. 37, 39, 40, 42 AND 50
 FOR HAIR ACCESSORIES; NAMELY, DECORATIVE
 HAIR COMBS, BARRETTES, BOWS AND CLIPS.
 FIRST USE 4-22-1992; IN COMMERCE 4-22-1992.

ELEMENTS CORRECTED
 ASSIGNMENT/NAME CHANGE

2,508,302. REG. 11-20-2001. WEDDINGCHANNEL.COM, INC.
 (DELAWARE CORPORATION), 888 S. FIGUEROA
 STREET, STE 700, LOS ANGELES, DE, 90017, BY CHANGE
 OF NAME WEDCOM INC. (DELAWARE CORPORA-
 TION), PASADENA, CA, SN 75-293,805. FILED 5-19-1997.
 PRINCIPAL REGISTER.

WEDDING CHANNEL

SEC. 2(F).
 INT. CL. 35/U.S. CLS. 100, 101 AND 102
 FOR ADVERTISING AGENCIES AND BUSINESS
 MARKETING CONSULTING SERVICES.
 FIRST USE 7-15-1997; IN COMMERCE 7-15-1997.
 INT. CL. 39/U.S. CLS. 100 AND 105
 FOR TRAVEL INFORMATION SERVICES.
 FIRST USE 7-15-1997; IN COMMERCE 7-15-1997.

ELEMENTS CORRECTED
 ASSIGNMENT/NAME CHANGE

2,509,483. REG. 11-20-2001. STAR HORSE PRODUCTS, INC.
 (MISSISSIPPI CORPORATION), 262 WEST WASHINGTON
 STREET, RIDGELAND, MS, 39157, BY ASSIGNMENT J.T.
 INDUSTRIES (PARTNERSHIP), SANTA ANA, CA, SN 76-
 131,377. FILED 9-15-2000. PRINCIPAL REGISTER.

STAR HORSE

NO CLAIM IS MADE TO THE EXCLUSIVE RIGHT TO
 USE "HORSE", APART FROM THE MARK AS SHOWN.
 INT. CL. 5/U.S. CLS. 6, 18, 44, 46, 51 AND 52
 FOR INSECTICIDES AND ECTOPARASITICIDES FOR
 USE ON LIVESTOCK AND DOMESTIC PETS, LIVE-
 STOCK FEED SUPPLEMENTS AND MEDICATED LIVE-
 STOCK FEED SUPPLEMENTS.
 FIRST USE 9-15-2000; IN COMMERCE 11-12-2000.

ELEMENTS CORRECTED
 OWNER NAME
 OWNER ADDRESS
 ASSIGNMENT/NAME CHANGE

2,518,625. REG. 12-11-2001. VALASSIS COMMUNICATIONS,
 INC. (DELAWARE CORPORATION), 19975 VICTOR
 PARKWAY, LIVONIA, MI, 481527001, SN 75-943,253.
 FILED 3-13-2000. PRINCIPAL REGISTER.

CONNECTING PEOPLE TO BRANDS

INT. CL. 35/U.S. CLS. 100, 101 AND 102
 FOR PROMOTING THE GOODS AND SERVICES OF
 OTHERS THROUGH THE DISTRIBUTION OF COU-
 PONS, SAMPLES AND PRINTED ADVERTISING; MED-
 IA PLANNING SERVICES; MARKETING ANALYSIS
 FOR SUCH PROMOTIONS; AND PROVIDING SUCH
 SERVICES BOTH IN PRINT AND VIA ONLINE ELEC-
 TRONIC COMMUNICATIONS.
 FIRST USE 4-2-2001; IN COMMERCE 4-2-2001.

ELEMENTS CORRECTED
 MARK

2,528,813. REG. 1-15-2002. ILLINOIS POWER COMPANY
 (ILLINOIS CORPORATION), 500 SOUTH 27TH STREET
 PO BOX 511, DECATUR, IL, 625251805, SN 75-522,658.
 FILED 7-21-1998. PRINCIPAL REGISTER.



NO CLAIM IS MADE TO THE EXCLUSIVE RIGHT TO
 USE "CUSTOMER DIRECT", APART FROM THE MARK AS
 SHOWN.

INT. CL. 42/U.S. CLS. 100 AND 101
 FOR COMPUTER SERVICES, NAMELY, PROVIDING
 ONLINE ACCOUNT INFORMATION FOR ELECTRIC
 AND GAS UTILITY CUSTOMERS TO REVIEW AND
 MODIFY, AND PROVIDING THE ABILITY TO SCHED-
 ULE UTILITY SERVICE CHANGES ONLINE.
 FIRST USE 1-0-1998; IN COMMERCE 1-0-1998.

ELEMENTS CORRECTED
 OWNER NAME

2,531,254. REG. 1-22-2002. ALASKA PRIDE BAKING COM-
 PANY LLC (ALASKA LIMITED LIABILITY COMPANY)
 1115 WHITNEY ROAD, ANCHORAGE, AK, 99501, SN 75-
 862,198. FILED 12-1-1999. PRINCIPAL REGISTER.

ALASKA PRIDE

NO CLAIM IS MADE TO THE EXCLUSIVE RIGHT TO
 USE "ALASKA", APART FROM THE MARK AS SHOWN.
 INT. CL. 30/U.S. CL. 46

FOR BAKERY GOODS AND PRODUCTS, NAMELY BREAD, BREAD STICKS, ROLLS, BUNS AND MUFFINS.
FIRST USE 3-1-1997; IN COMMERCE 3-1-1997.

ELEMENTS CORRECTED
OWNER NAME

2,533,722. REG. 1-29-2002. MERCK-MEDCO MANAGED CARE, L.L.C. (DELAWARE LIMITED LIABILITY COMPANY) 100 PARSONS POND DRIVE, FRANKLIN LAKES, NJ, 07417, SN 76-058,310. FILED 5-30-2000. PRINCIPAL REGISTER.

POSITIVE APPROACHES

INT. CL. 16/U.S. CLS. 2, 5, 22, 23, 29, 37, 38 AND 50
FOR NEWSLETTERS, SERIES OF BOOKS, BROCHURES AND PAMPHLETS IN THE FIELD OF HEALTH CARE.
FIRST USE 6-8-2000; IN COMMERCE 6-8-2000.

ELEMENTS CORRECTED
ENTITY

2,533,751. REG. 1-29-2002. BERRYMAN PRODUCTS, INC. (TEXAS CORPORATION), 3800 E. RANDOL MILL ROAD, ARLINGTON, TX, 760115474, SN 76-069,917. FILED 6-14-2000. PRINCIPAL REGISTER.



OWNER OF U.S. REG. NOS. 697,357, 997,229 AND 1,019,024.

INT. CL. 1/U.S. CLS. 1

FOR [CHEMICALS] * CHEMICAL * GASOLINE ADDITIVES; CHEMICAL MOTOR OIL ADDITIVES; CHEMICAL ADDITIVES FOR FUEL TREATMENT; OCTANE BOOSTER FUEL CHEMICAL ADDITIVES; DEGREASING PREPARATIONS USED IN THE MANUFACTURING PROCESS, FOR ENGINES.

FIRST USE 11-1-1997; IN COMMERCE 12-1-1997.
INT. CL. 16/U.S. CLS. 2, 5, 22, 23, 29, 37, 38 AND 50
FOR POSTERS.

FIRST USE 11-1-1997; IN COMMERCE 12-1-1997.

INT. CL. 25/U.S. CLS. 22 AND 39

FOR T-SHIRTS.

FIRST USE 11-1-1997; IN COMMERCE 12-1-1997.

ELEMENTS CORRECTED
GOODS/SERVICES

2,533,817. REG. 1-29-2002. BEELE ENGINEERING B.V. (NETHERLANDS LIMITED LIABILITY COMPANY) BEUNKDIJK 11, 7122 NZ AALTEN, NETHERLANDS., SN 76-095,838. FILED 7-25-2000. PRINCIPAL REGISTER.

LUMIREFLEC

PRIORITY CLAIMED UNDER SEC. 44(D) ON BENELUX APPLICATION NO. 957439, FILED 2-17-2000, REG. NO. 0665807, DATED 2-17-2000, EXPIRES 2-17-2010.

INT. CL. 6/U.S. CLS. 2, 12, 13, 14, 23, 25 AND 50

FOR NON-ELECTRIC LUMINOUS SIGNAL PANELS MADE OF ALUMINUM; NON-ELECTRIC LUMINOUS SIGNAL PANELS MADE OF ALUMINUM WITH A PLASTIC FILM.

FIRST USE ; IN COMMERCE .

INT. CL. 9/U.S. CLS. 21, 23, 26, 36 AND 38

FOR ELECTRIC LUMINESCENT SIGNAL DISPLAY PANELS CONTAINING STICKERS, ADHESIVE TAPE, GUMMED TAPE, AND TAPE FOR MARKING ESCAPE ROUTES IN BUILDINGS AND IN MEANS FOR TRANSPORT OVER LAND, THROUGH THE AIR OR OVER THE WATER, AS WELL AS FOR MARKING OBSTACLES WHICH ARE NOT OR ARE HARDLY VISIBLE IN THE DARK.

FIRST USE ; IN COMMERCE .

INT. CL. 17/U.S. CLS. 1, 5, 12, 13, 35 AND 50

FOR LUMINOUS RUBBER OR SIMILAR ELASTIC MATERIALS, NAMELY, NON-ELECTRIC LUMINOUS SIGNAL PANELS, STICKERS, ADHESIVE TAPE AND GUMMED TAPES FOR MARKING AND MAKING SAFE ESCAPE ROUTES IN BUILDINGS AND IN OTHER MEANS FOR TRANSPORT OVER LAND, THROUGH THE AIR OR OVER THE WATER, AS WELL AS FOR MARKING OBSTACLES WHICH ARE NOT OR ARE HARDLY VISIBLE IN THE DARK; TAPES, NAMELY, STICKERS, ADHESIVE TAPES FOR INDUSTRIAL PURPOSES, AND GUMMED TAPES FOR INDUSTRIAL PURPOSES.

FIRST USE ; IN COMMERCE .

INT. CL. 19/U.S. CLS. 1, 12, 33 AND 50

FOR BUILDING MATERIALS, NAMELY, RUBBER OR ANY SIMILAR ELASTIC NON-LUMINOUS OR NON-MECHANICAL MATERIALS, NAMELY RAILINGS, WINDOW FRAMES NOT OF METAL, DOORFRAMES NOT OF METAL, LUMINOUS PAVEMENT TILES AND/OR PARTS THEREOF.

FIRST USE ; IN COMMERCE .

INT. CL. 42/U.S. CLS. 100 AND 101

FOR PRODUCT DEVELOPMENT CONSULTATION AND PRODUCT DEVELOPMENT IN THE FIELD OF MARKING ESCAPE ROUTES AND IN MEANS FOR TRANSPORT OVER LAND, THROUGH THE AIR OR OVER THE WATER, AS WELL AS THE MARKING OF OBSTACLES WHICH ARE NOT OR ARE HARDLY VISIBLE IN THE DARK.

FIRST USE ; IN COMMERCE .

ELEMENTS CORRECTED
OWNER ADDRESS

2,534,402. REG. 1-29-2002. GLOBAL COMPUTER SUPPLIES, INC. (NEW YORK CORPORATION), 22 HARBOR PARK DRIVE, PORT WASHINGTON, NY, 11050, BY MERGER CONTINENTAL DYNAMICS CORPORATION (NEW YORK CORPORATION), PORT WASHINGTON, NY, SN 75-391,645. FILED 11-17-1997. PRINCIPAL REGISTER.

GO CONFIGURE

INT. CL. 40/U.S. CLS. 100, 103 AND 106

FOR CUSTOMIZED MANUFACTURE OF COMPUTER HARDWARE FOR OTHERS.
FIRST USE 12-0-1997; IN COMMERCE 12-0-1997.

ELEMENTS CORRECTED
OWNER NAME
OWNER ADDRESS
ASSIGNMENT/NAME CHANGE

2,535,292. REG. 2-5-2002. WACKER-CHEMIE GMBH (FED REP GERMANY LIMITED LIABILITY COMPANY) HANNS-SEIDEL-PLATZ 4, D-81737 MUNICH, FED REP GERMANY., SN 75-716,598. FILED 5-27-1999. PRINCIPAL REGISTER.

SILMIX

PRIORITY CLAIMED UNDER SEC. 44(D) ON FED REP GERMANY APPLICATION NO. 39869564.4, FILED 12-2-1998, REG. NO. 39869564, DATED 1-14-1999, EXPIRES 12-31-2008.
INT. CL. 1/U.S. CLS. 1

FOR UNPROCESSED PLASTICS; CHEMICAL COMPOUNDS THAT CROSSLINK TO FORM PLASTICS; CHEMICALS IN THE FORM OF RAW MATERIALS, AUXILIARIES, ADDITIVES AND CATALYSTS USED IN PLASTICS PRODUCTION; CHEMICAL COMPOUNDS, NAMELY, SILANES, SILICONES, SILICONE FLUIDS, SILICONE RESINS, SILICONE GREASES, SILICONE PASTES, SILICONE ELASTOMERS; CHEMICAL COMPOUNDS THAT CROSSLINK TO FORM SILICONE ELASTOMERS; EMBEDDING COMPOUNDS ON THE BASE OF ORGANOSILICON COMPOUNDS; ALL OF THE ABOVE FOR USE IN THE CHEMICALS, PLASTICS, METALLURGICAL, GLASS, PAPER, CERAMICS, PHOTOGRAPHY, AGRICULTURAL, HORTICULTURAL, FORESTRY, COMMERCIAL AND RESIDENTIAL BUILDING, CONSTRUCTION, AUTOMOBILE, AUTOMOTIVE, INSULATION, PACKAGING, ENGINEERING, ENERGY, ELECTRONICS, PHARMACEUTICAL, COSMETIC, FRAGRANCE, TEXTILE, LEATHER, SYNTHETIC RUBBER, HEALTH CARE, FOOD, PAINT, MOULD MAKING, SEMI-CONDUCTOR, MICROCHIP AND TERRESTRIAL PHOTOVOLTAIC INDUSTRIES; PLASTIC MOULDING COMPOUNDS FOR USE IN THE MANUFACTURE OF PLASTIC SHEETS, PLASTIC FILMS AND MOLDED PLASTIC ARTICLES; CHEMICAL MOULD RELEASE COMPOUNDS FOR THE PLASTICS/FIBER GLASS INDUSTRIES .

FIRST USE ; IN COMMERCE .

INT. CL. 17/U.S. CLS. 1, 5, 12, 13, 35 AND 50

FOR SEMIPROCESSED PLASTICS AND PLASTIC GOODS, NAMELY, SEMIPROCESSED PLASTICS USED FOR SEALING, PACKING AND INSULATING MATERIAL; PLASTICS AND SEMIPROCESSED PLASTICS IN THE FORM OF BLOCKS, EXTRUDATES, POWDERS, SHEETS, FILMS, RODS, FLEXIBLE PIPES AND FIBERS, FOR GENERAL INDUSTRIAL USE BUT NOT FOR TEXTILE USE; MOULDED BODIES, SOLUTIONS, EMULSIONS, DISPERSIONS AND GRANULES FOR USE IN THE CHEMICALS, PLASTICS, METALLURGICAL, GLASS, PAPER, CERAMICS, PHOTOGRAPHY, AGRICULTURAL, HORTICULTURAL, FORESTRY, COMMERCIAL AND RESIDENTIAL BUILDING, CONSTRUCTION, AUTOMOBILE, AUTOMOTIVE, INSULATION, PACKAGING, ENGINEERING, ENERGY, ELECTRONICS, PHARMACEUTICAL, COSMETIC, FRAGRANCE, TEXTILE, LEATHER, SYNTHETIC RUBBER, HEALTH CARE, FOOD, PAINT, MOULD MAKING, SEMI-CONDUCTOR, MICRO-CHIP AND TERRESTRIAL PHOTOVOLTAIC INDUSTRIES; [THERMO-PLASTIC] *THERMOPLASTIC* SYNTHETIC RESINS ON THE BASE OF [ORGANO SILICON] *ORGANOSILICON* COMPOUNDS FOR GENERAL INDUSTRIAL USE; SEALANTS FOR JOINTS IN THE BUILDING AND ROAD CONSTRUCTION INDUSTRIES; INSULATING PAINTS AND VARNISHES FOR USE IN THE CHEMICALS, PLASTICS, METALLURGICAL, GLASS, PAPER, CERAMICS, PHOTOGRAPHY, AGRICULTURAL, HORTICULTURAL, FORESTRY, COMMERCIAL AND RESIDENTIAL BUILDING, CONSTRUCTION, AUTOMOBILE, AUTOMOTIVE, INSULATION, PACKAGING,

ENGINEERING, ENERGY, ELECTRONICS, PHARMACEUTICAL, COSMETIC, FRAGRANCE, TEXTILE, LEATHER, SYNTHETIC RUBBER, HEALTH CARE, FOOD, PAINT, MOULD MAKING, SEMI-CONDUCTOR, MICROCHIP AND TERRESTRIAL PHOTOVOLTAIC INDUSTRIES; INSULATING OILS FOR USE IN THE CHEMICALS, PLASTICS, METALLURGICAL, GLASS, PAPER, CERAMICS, PHOTOGRAPHY, AGRICULTURAL, HORTICULTURAL, FORESTRY, COMMERCIAL AND RESIDENTIAL BUILDING, CONSTRUCTION, AUTOMOBILE, AUTOMOTIVE, INSULATION, PACKAGING, ENGINEERING, ENERGY, ELECTRONICS, PHARMACEUTICAL, COSMETIC, FRAGRANCE, TEXTILE, LEATHER, SYNTHETIC RUBBER, HEALTHCARE, FOOD, PAINT, MOULD MAKING, SEMI-CONDUCTOR, MICROCHIP AND TERRESTRIAL PHOTOVOLTAIC INDUSTRIES; PLASTIC GASKETS FOR SEALING PURPOSES; YARNS, FIBERS AND THREADS ON THE BASE OF PLASTIC FOR GENERAL INDUSTRIAL USE BUT NOT FOR TEXTILE USE; THERMAL INSULATION MADE OF PLASTIC AND INORGANIC MATERIAL FOR ANY PURPOSE WHERE HEAT OR COLD HAS TO BE INSULATED.

FIRST USE ; IN COMMERCE .

ELEMENTS CORRECTED
GOODS/SERVICES

2,535,320. REG. 2-5-2002. CLEM DEL. INC. (DELAWARE CORPORATION), P.O. BOX 1958, WILMINGTON, DE, 19899, SN 75-738,724. FILED 6-28-1999. PRINCIPAL REGISTER.

CONSIDER THE SOURCE

INT. CL. 35/U.S. CLS. 100, 101 AND 102

FOR RETAIL GROCERY STORE SERVICES; NAMELY, SERVICES IN CONNECTION WITH THE RETAIL SALE OF [FRESHS] * FRESH FRUITS * AND VEGETABLES.

FIRST USE 3-3-1999; IN COMMERCE 3-3-1999.

ELEMENTS CORRECTED
GOODS/SERVICES

2,535,352. REG. 2-5-2002. PARLETT, ISABEL (UNITED STATES SOLE PROPRIETORSHIP) 903 WEST ALAMEDA, PMB 127, SANTA FE, NM, 87501, SN 75-773,414. FILED 8-6-1999. PRINCIPAL REGISTER.

THE INSPIRED PROFESSIONAL

NO CLAIM IS MADE TO THE EXCLUSIVE RIGHT TO USE "PROFESSIONAL", APART FROM THE MARK AS SHOWN.

INT. CL. 41/U.S. CLS. 100, 101 AND 107

FOR EDUCATIONAL SERVICES, NAMELY, CONDUCTING PROGRAMS IN THE NATURE OF WORKSHOPS AND COACHING THAT MOTIVATE INDIVIDUALS TO MAXIMIZE THE ENJOYMENT DERIVED [FORM] *FROM* THEIR WORK; PUBLISHING NEWSLETTER, ARTICLES, BOOKS, BOOKLETS, AND INSTRUCTIONAL MATERIALS FOR INDIVIDUALS IN THE FIELD OF MAXIMIZING THE ENJOYMENT DERIVED FROM ONE'S WORK.

FIRST USE 1-27-1998; IN COMMERCE 1-27-1998.

ELEMENTS CORRECTED
GOODS/SERVICES

2,536,696. REG. 2-5-2002. STADT CORPORATION (FLORIDA CORPORATION), 2 CUMBERLAND STREET, BROOKLYN, NY, 11205, SN 76-295,076. FILED 8-3-2001. PRINCIPAL REGISTER.

2,541,072. REG. 2-19-2002. TELEDYNE TECHNOLOGIES INCORPORATED (CALIFORNIA CORPORATION), 12333 W. OLYMPIC BOULEVARD, LOS ANGELES, CA, 900641021, BY ASSIGNMENT TELEDYNE INDUSTRIES, INC. (CALIFORNIA CORPORATION), LOS ANGELES, CA, SN 75-724,188. FILED 6-8-1999. PRINCIPAL REGISTER.

NATRATASTE

GROUNDLINK

INT. CL. 30/U.S. CL. 46
FOR SUGAR SUBSTITUTES.
FIRST USE 11-17-1987; IN COMMERCE 11-17-1987.

INT. CL. 9/U.S. CLS. 21, 23, 26, 36 AND 38
FOR HARDWARE AND SOFTWARE FOR WIRELESS DATA TRANSMISSION AND RECEPTION TO AND FROM AIRCRAFT USING CELLULAR/PCS TECHNOLOGY.
FIRST USE 3-16-1999; IN COMMERCE 3-29-1999.

ELEMENTS CORRECTED
FILING DATE

ELEMENTS CORRECTED
OWNER ADDRESS

2,537,137. REG. 2-5-2002. WATER PIK, INC. (DELAWARE CORPORATION), 23 CORPORATE PLAZA, SUITE 246, NEWPORT BEACH, CA, 92660, BY ASSIGNMENT, BY ASSIGNMENT TELEDYNE INDUSTRIES, INC. (CALIFORNIA CORPORATION), DBA TELEDYNE WATER PIK, LOS ANGELES, CA, SN 75-811,016. FILED 9-29-1999. PRINCIPAL REGISTER.

2,543,312. REG. 2-26-2002. MAIN STREET YORK, INC. (PENNSYLVANIA CORPORATION), 14 WEST MARKET STREET, YORK, PA, 17401, BY ASSIGNMENT YORK COUNTY, PENNSYLVANIA, 250TH ANNIVERSARY CORPORATION (PENNSYLVANIA CORPORATION), YORK, PA, SN 75-681,115. FILED 4-12-1999. PRINCIPAL REGISTER.

SEA FOAM SPRAY

YORKFEST

NO CLAIM IS MADE TO THE EXCLUSIVE RIGHT TO USE "SPRAY", APART FROM THE MARK AS SHOWN.
INT. CL. 11/U.S. CLS. 13, 21, 23, 31 AND 34
FOR SHOWER HEAD SETTING AS A COMPONENT PART OF SHOWER HEADS.
FIRST USE 9-21-2000; IN COMMERCE 9-21-2000.

INT. CL. 16/U.S. CLS. 2, 5, 22, 23, 29, 37, 38 AND 50
FOR POSTERS.
FIRST USE 8-0-1999; IN COMMERCE 8-0-1999.
INT. CL. 25/U.S. CLS. 22 AND 39
FOR T-SHIRTS AND SWEATSHIRTS .
FIRST USE 8-0-1999; IN COMMERCE 8-0-1999.

ELEMENTS CORRECTED
ASSIGNMENT/NAME CHANGE

ELEMENTS CORRECTED
ASSIGNMENT/NAME CHANGE
OWNER NAME
OWNER ADDRESS

* * * * *

TRADEMARK REGISTRATIONS—NEW CERTIFICATES

New Certificates issued under section 7(e) of the Trademark Act of 1946 for the unexpired term of the original registrations.

2,196,087. T.K. AND DESIGN. INT. CL. 30. T.K. FOOD CO., LTD., CHIAYI HSIEN, TAIWAN, R.O.C., TAIWAN. REG. 10-13-1998. NEW CERT. SEC. 7(C) TO REGISTRANT.

2,364,345. WOLF CAMERA AND DESIGN. INT. CL. 40. WOLF CAMERA, INC., ALPHARETTA, GA. REG. 7-4-2000. NEW CERT. SEC. 7(C) TO REGISTRANT.

2,210,117. AMERICAN SAVINGS BANK. INT. CL. 36. WASHINGTON MUTUAL BANK, F.A., STOCKTON, CA. REG. 12-15-1998. NEW CERT. SEC. 7(C) TO AMERICAN SAVINGS BANK, F.S.B., HONOLULU, HI.

2,474,872. LATINET. INT. CL. 42. LATIN AMERICAN ELECTRONIC COMMUNITY & INFORMATION NETWORK, LLC, MIAMI, FL. REG. 8-7-2001. NEW CERT. SEC. 7(C) TO REGISTRANT.

* * * * *

This page is intentionally blank

INDEX OF REGISTRANTS

MAY 21, 2002

(Registered; Renewed; Canceled; Amended, Corrected, etc.; New Certificates; 12c Publications.)

The designation "U.S. Cl." appearing in this section refers to the U.S. class in effect prior to Sep. 1, 1973 rather than the international class which applies to applications filed on or after that date. For adoption of international classification see notice in the OFFICIAL GAZETTE of Jun. 26, 1973 (911 O.G. TM 210).

- A. MEYERS & SONS CORP., NEW YORK, NY:
1,886,625, CANC. INT. CL. 20.
- A. V. PAEGE, LTD., NEW YORK, NY:
1,886,442, CANC. INT. CL. 42.
- A.G. MORGAN & ASSOCIATES:
See— PROJECTTOOLS.COM, INC..
- A.O.K. INDUSTRIAL CO., TAICHUNG, TAIWAN:
2,571,061, PUB. 2-26-2002. INT. CL. 8.
- A/S KJOBENHAVNS SOMMER-TIVOLI, 1630 COPENHAGEN V, DENMARK:
2,570,494, PUB. 12-22-1998. MULTIPLE CLASS, INT. CLS. 35, 41 AND 42.
- AALBA DENT, INC., CORDELIA, CA:
1,638,847, CANC. INT. CL. 5.
- AALBORG INDUSTRIES, INC., ERIE, PA, ERIE CITY IRON WORKS, ERIE, PA:
554,723. REN. 4-6-02. U.S. CL. 34 (INT. CL. 7).
- ABA, INC., MIDDLETOWN, CT:
2,571,138, PUB. 2-26-2002. INT. CL. 9.
- ABARTA, INC., PITTSBURGH, PA:
140,946, CANC. U.S. CL. 45.
- ABB AUTOMATION INC., NORWALK, CT:
2,571,603, PUB. 10-2-2001. INT. CL. 9.
- ABBIGLIAMENTO RIBO' S.R.L., 37064 POVEGLIANO VERONESE (VR), ITALY:
2,471,661, COR. INT. CL. 25.
- ABBOTT LABORATORIES, ABBOTT PARK, IL:
1,676,340. REN. 4-10-02. INT. CL. 10.
- ABBOTT SNEYD ANDERSON S.A.R.L., 34000 MONTPELLIER, FRANCE:
2,508,002, CANC. INT. CL. 33.
- ABC SPORTS, INC., NEW YORK, NY, AMERICAN BROADCASTING COMPANIES, INC., NEW YORK, NY:
918,079. REN. 4-10-02. U.S. CL. 107 (INT. CL. 41).
- ABF FREIGHT SYSTEM, INC., FORT SMITH, AR:
2,571,652, PUB. 2-26-2002. INT. CL. 39.
- ABLE EQUIPMENT RENTAL, INC., COPIAGUE, NY:
2,571,537, PUB. 2-26-2002. INT. CL. 37.
- ABS FAX TECHNOLOGIES, INC., HOUSTON, TX:
2,572,285, INT. CL. 38.
- ABSOLUTE BRILLIANCE, INC., NEW YORK, NY:
2,570,841, PUB. 2-26-2002. INT. CL. 14.
- ABUGHOSH, MUSA, SAN FRANCISCO, CA:
2,570,929, PUB. 2-26-2002. INT. CL. 35.
- AC-CETERA, INC., PITTSBURGH, PA:
1,672,615. REN. 4-11-02. INT. CL. 20.
1,675,111. REN. 4-11-02. INT. CL. 20.
- ACADIAN CANDLE COMPANY, BLOOMINGTON, MN:
2,571,476, PUB. 2-26-2002. INT. CL. 4.
2,571,477, PUB. 2-26-2002. INT. CL. 4.
- ACCESS: GLOBAL, INCORPORATED, PLANO, TX:
2,571,858, MULTIPLE CLASS, INT. CLS. 8 AND 16.
- ACCO WORLD CORPORATION, LINCOLNSHIRE, IL, WILSON JONES COMPANY, CHICAGO, IL:
727,518. REN. 4-12-02. U.S. CL. 37 (INT. CL. 16).
- ACCO WORLD CORPORATION, LINCOLNSHIRE, IL:
2,572,004, INT. CL. 9.
- ACCURATE DATA SYSTEMS, INC., SOUTHFIELD, MI:
1,883,426, CANC. INT. CL. 9.
- ACE HARDWARE CORPORATION, OAK BROOK, IL:
1,683,538. REN. 4-12-02. MULTIPLE CLASS, INT. CLS. 2 AND 4.
- ACHESON INDUSTRIES, INC., PORT HURON, MI:
1,695,659. REN. 4-6-02. INT. CL. 1.
- ACK-TI-LINING, INC., NEW YORK, NY:
1,149,873, CANC. INT. CL. 24.
- ACME BOOT COMPANY, INC., CLARKSVILLE, TN:
1,886,167, CANC. INT. CL. 25.
1,886,168, CANC. INT. CL. 25.
- ACS, INC., AKRON, OH, DBA THE EMERGENCY MEDICINE INSTITUTE:
1,886,355, CANC. INT. CL. 41.
- ACTION FACTOR INC., BEAVERCREEK, OH:
2,571,047, PUB. 2-26-2002. INT. CL. 9.
- ACUITY CORPORATION, MALVERN, PA, DBA ADCOURT:
1,886,327, CANC. INT. CL. 37.
- ACXIOM CORPORATION, LITTLE ROCK, AR:
2,571,220, PUB. 2-26-2002. INT. CL. 35.
- ADAMA, INC., PORT ORANGE, FL:
2,572,146, INT. CL. 16.
- ADAMS HEATING AND AIR CONDITIONING, INC., CHARLOTTE, NC:
1,741,722. REN. 4-10-02. MULTIPLE CLASS, INT. CLS. 37 AND 42.
- ADAMS/HUNTER PUBLISHING, INC., CATHEDRAL CITY, CA:
2,571,014, PUB. 2-26-2002. INT. CL. 16.
- ADAMS, HARKNESS & HILL, INC., BOSTON, MA:
2,571,105, PUB. 2-26-2002. MULTIPLE CLASS, INT. CLS. 16, 35, 36 AND 41.
- ADAPTEC, INC., MILPITAS, CA FROM ADAPTEC, INC., MILPITAS, CA:
2,571,882, INT. CL. 9.
- ADDCO, INC., ST. PAUL, MN, ADDCO MANUFACTURING INC., ST. PAUL, MN:
1,653,104. REN. 4-11-02. INT. CL. 20.
- ADDCO, INC., ST. PAUL, MN:
2,571,366, PUB. 2-26-2002. INT. CL. 9.
- ADESCOM INC., SANTA CRUZ, CA:
2,571,610, PUB. 2-26-2002. INT. CL. 42.
- ADLER GROUP, INC., MIAMI, FL:
2,571,807, MULTIPLE CLASS, INT. CLS. 35, 36 AND 39.
2,571,809, MULTIPLE CLASS, INT. CLS. 35, 36 AND 39.
2,571,810, MULTIPLE CLASS, INT. CLS. 35, 36 AND 39.
- ADLER, JEFF, CINCINNATI, OH AND HINES, STEVE, CINCINNATI, OH:
2,570,984, PUB. 2-26-2002. INT. CL. 25.
- ADMIX, INC., LONDONDERRY, NH:
1,885,822, CANC. INT. CL. 7.
1,885,823, CANC. INT. CL. 7.
- ADOBE SYSTEMS INCORPORATED, SAN JOSE, CA, ADOBE SYSTEMS INCORPORATED, MOUNTAIN VIEW, CA:
1,682,713. REN. 4-9-02. INT. CL. 9.
- ADRENALINE JOE AGGRESSIVE SPORTSWEAR, BELLEVILLE, IL:
2,571,350, PUB. 2-26-2002. INT. CL. 25.
- ADS PROPERTIES CORP., BURLINGTON, VT, MALDEN MILLS INDUSTRIES, INC., NEW YORK, NY:
1,605,633. REN. 4-9-02. INT. CL. 24.
- ADSIL LC, PALM COAST, FL:
2,571,481, PUB. 2-26-2002. INT. CL. 2.
- ADVANCED DATA SOLUTIONS, INC., HOUSTON, TX:
2,571,839, INT. CL. 9.

- ADVANCED SYSTEMS INTERNATIONAL, SOUTHFIELD, MI:
2,570,649, PUB. 8-21-2001. INT. CL. 9.
- ADVENTIST HEALTH SYSTEM/WEST, ROSEVILLE, CA, DBA ADVENTIST HEALTH:
2,571,349, PUB. 2-26-2002. INT. CL. 9.
- ADVERTISING SPECIALTY INSTITUTE INC., TREVOSE, PA, NATIONAL BUSINESS SERVICES, INC., LANGHORNE, PA, AKA ADVERTISING SPECIALTY INSTITUTE:
1,174,140. REN. 4-8-02. INT. CL. 16.
- ADWARE SYSTEMS, INC., LOUISVILLE, KY:
2,571,875, MULTIPLE CLASS, INT. CLS. 39, 41 AND 42.
- AEGIS, L.P., LOS ANGELES, CA:
1,886,777, CANC. INT. CL. 9.
- AERIAL VIEW SYSTEMS, INC., NEWPORT BEACH, CA:
2,571,005, PUB. 2-26-2002. INT. CL. 9.
- AERONET, INC., IRVINE, CA:
2,571,883, INT. CL. 39.
- AEROTECH LABORATORIES, INC., PHOENIX, AZ:
2,571,479, PUB. 2-26-2002. INT. CL. 9.
- AESCLAP-MEDITEC GMBH, D-07745 JENA, FED REP GERMANY:
2,570,511, PUB. 5-11-1999. MULTIPLE CLASS, INT. CLS. 9 AND 10.
- AFFILIATED RESOURCES, INC., PORTLAND, OR:
2,571,935, INT. CL. 19.
2,571,936, INT. CL. 19.
- AFN COMMUNICATIONS, LLC, TULSA, OK:
2,571,125, PUB. 2-26-2002. INT. CL. 38.
- AFS LABS, INC., CORAL SPRINGS, FL:
2,512,736, CANC. INT. CL. 5.
- AFTERMARKET AUTO PARTS ALLIANCE, INC., SAN ANTONIO, TX:
2,571,431, PUB. 2-26-2002. INT. CL. 36.
- AFTERMATH ENTERTAINMENT, LOS ANGELES, CA, TSIOLIS, KYRIAKOS, CHICAGO, IL:
1,692,053. REN. 4-6-02. INT. CL. 41.
- AGCO CORPORATION, NORCROSS, GA, TYE COMPANY, THE, LOCKNEY, TX:
1,682,666. REN. 4-8-02. INT. CL. 7.
- AGENCY OF AMERICA, INC., NAPERVILLE, IL:
2,571,501, PUB. 2-26-2002. INT. CL. 42.
- AGGLO-MARMOWERK G.M.B.H, LICHTENAU 3, FED REP GERMANY:
1,149,826, CANC. INT. CL. 19.
- AGRATECH SEEDS INC., ATLANTA, GA:
1,886,389, CANC. INT. CL. 41.
- AGRI-MARKETING INCORPORATED, SALT LAKE CITY, UT:
1,886,245, CANC. INT. CL. 31.
- AGRICULTURAL RETAILERS ASSOCIATION, WASHINGTON, DC, ICI AMERICAS INC., WILMINGTON, DE:
1,674,603. REN. 4-8-02. INT. CL. 41.
- AGRO DISTRIBUTION, LLC, ARDEN HILLS, MN:
2,572,231, INT. CL. 5.
- AH-BON ATHLETICS, INC., CHARLOTTE, NC:
1,886,154, CANC. INT. CL. 25.
- AIR COMPLIANCE TESTING, INC., NORTH ROYALTON, OH:
1,886,819, CANC. INT. CL. 42.
- AIRBARGE COMPANY, PALOS VERDES PENINSULA, CA:
918,409. REN. 4-12-02. U.S. CL. 19 (INT. CL. 7).
- AIRWAY INDUSTRIES, INC., ELLWOOD CITY, PA:
2,571,821, INT. CL. 18.
- AISLANTES MINERALES, S.A. DE C.V., MONTERREY, MEXICO, INNOVA TECHNOLOGIES, INC., SHELBYVILLE, IN:
1,675,874. REN. 4-11-02. INT. CL. 17.
1,699,818. REN. 4-11-02. INT. CL. 17.
- AKAMBA CORPORATION, LOS GATOS, CA:
2,572,069, INT. CL. 9.
- AKTIEBOLAGET ASTRA, S-151 85 SODERTALJE, SWEDEN:
1,885,786, CANC. INT. CL. 5.
1,885,787, CANC. INT. CL. 5.
- AKU S.R.L., 65 - MONTEBELLUNA - (TREVISO), ITALY:
1,983,275, COR. INT. CL. 25.
- AL SYSTEMS, INC., ROCKAWAY, NJ:
1,885,888, CANC. INT. CL. 9.
- ALAMO WATER REFINERS, INC., SAN ANTONIO, TX:
2,571,355, PUB. 2-26-2002. INT. CL. 11.
- ALASKA PRIDE BAKING COMPANY LLC, ANCHORAGE, AK:
2,531,254, COR. INT. CL. 30.
- ALASKA SUPPLY CHAIN INTEGRATORS, LLC, ANCHORAGE, AK:
2,571,504, PUB. 2-26-2002. INT. CL. 42.
- ALBANY INTERNATIONAL CORP., ALBANY, NY, GESCHMAY WET FELTS, INC., GREENVILLE, SC:
1,187,732. REN. 4-11-02. INT. CL. 24.
- ALBEMARLE CORPORATION, BATON ROUGE, LA, SAYTECH, INC., EAST BRUNSWICK, NJ:
1,152,043. REN. 4-8-02. INT. CL. 1.
- ALBERTO-CULVER COMPANY, MELROSE PARK, IL:
2,571,670, PUB. 2-26-2002. INT. CL. 3.
- ALBION COSMETICS CO., LTD., TOKYO, JAPAN:
2,570,956, PUB. 2-26-2002. INT. CL. 3.
- ALCISA S.P.A., 40069 ZOLA PREDOSA (BOLOGNA), ITALY:
2,570,717, PUB. 11-20-2001. INT. CL. 29.
- ALCON MANUFACTURING, LTD., FORT WORTH, TX, COOPER LABORATORIES, INC., PALO ALTO, CA:
1,215,657. REN. 4-6-02. INT. CL. 10.
- ALCON MANUFACTURING, LTD., FORT WORTH, TX:
2,571,203, PUB. 9-11-2001. INT. CL. 5.
- ALDI INC., BATAVIA, IL:
2,572,100, INT. CL. 9.
- ALERTS.COM, INC., RALEIGH, NC:
2,570,849, PUB. 2-26-2002. INT. CL. 42.
- ALEXANDER JULIAN, INC., RIDGEFIELD, CT:
1,639,171, CANC. INT. CL. 25.
- ALEXANDER MFG. CO., PARSONS, KS:
2,571,572, PUB. 2-26-2002. INT. CL. 6.
- ALEXANDER, DARLEDIA, WIRTZ, VA:
2,571,372, PUB. 2-26-2002. INT. CL. 9.
- ALGER ASSOCIATES, INC., NEW YORK, NY:
2,572,011, INT. CL. 16.
- ALGO VISION PLC, LONDON, ENGLAND:
2,571,946, MULTIPLE CLASS, INT. CLS. 9 AND 38.
- ALIEN ANT FARM, ENCINO, CA:
2,571,285, PUB. 2-26-2002. MULTIPLE CLASS, INT. CLS. 9, 25 AND 41.
- ALIGN CORPORATION, ATLANTA, GA:
1,886,279, CANC. INT. CL. 35.
- ALIMENTITALIA, SRL, 38014 GARDOLO TN, ITALY:
2,571,977, INT. CL. 29.
- ALL EARS, INC., MARCO ISLAND, FL:
1,886,435, CANC. INT. CL. 42.
- ALL NATIONS CHURCH, INC., CHARLOTTE, NC:
2,570,914, PUB. 2-26-2002. MULTIPLE CLASS, INT. CLS. 9, 16, 41 AND 42.
- ALLAN, SUSAN, STUDIO CITY, CA:
2,572,390, INT. CL. 41.
- ALLDATA LLC, ELK GROVE, CA:
2,571,052, PUB. 2-26-2002. INT. CL. 37.
- ALLEGIANCE REALTY GROUP, INC., SKOKIE, IL:
1,886,715, CANC. INT. CL. 36.
- ALLEN & COMPANY, INC., BALTIMORE, MD:
1,886,472, CANC. MULTIPLE CLASS, INT. CLS. 3, 4, 5, 6, 8, 16, 29, 30, 31 AND 32.
- ALLEN POMERANTZ CO., INC., LOS ANGELES, CA:
1,639,033, CANC. INT. CL. 14.
- ALLIED HEALTHCARE PRODUCTS, INC., ST. LOUIS, MO:
392,624. REN. 4-9-02. U.S. CL. 6 (INT. CL. 1).
- ALOHA HOUSEWARES, INC., DALLAS, TX:
2,570,666, PUB. 11-6-2001. INT. CL. 11.
- ALOIS AUGENDOPLER GESELLSCHAFT M.B.H., A-1140 WIEN, AUSTRIA:
2,570,510, PUB. 6-29-1999. INT. CL. 30.
- ALPHA GETRIEBEBAU GMBH, IGERSHEIM, FED REP GERMANY:
2,571,149, PUB. 9-4-2001. INT. CL. 7.
- ALPHA INTERNATIONAL, INC., CEDAR RAPIDS, IA, BUDDY L CORPORATION, NEW YORK, NY:
1,189,450. REN. 4-10-02. INT. CL. 28.

ALPHATYPE CORPORATION, NILES, IL:
1,150,029, CANC. INT. CL. 37.

ALTERNATIVE RESOLUTION CENTERS, LOS ANGELES, CA:
2,571,076, PUB. 2-26-2002. INT. CL. 42.

ALTHIN MEDICAL, INC., MIAMI LAKES, FL:
1,885,932, CANC. INT. CL. 10.

ALTICOR INC., ADA, MI, AMWAY SALES CORPORATION, ADA, MI:
727,367, REN. 4-8-02. U.S. CL. 6 (INT. CL. 3).

ALUMA ENTERPRISES INC., TORONTO ONTARIO M3H 5S8, CANADA:
2,571,877, MULTIPLE CLASS, INT. CLS. 6 AND 37.

ALUMA USA INC., SAN FRANCISCO, CA:
2,570,619, PUB. 2-26-2002. INT. CL. 14.

ALVA LEARNING SYSTEMS, LLC., AURORA, CO:
2,570,667, PUB. 2-26-2002. INT. CL. 41.

ALWIN ENTERPRISES INTERNATIONAL, INC., POMPA-
NO BEACH, FL:
1,886,503, CANC. INT. CL. 3.

AM ABLE, INC., LA MESA, CA:
1,886,331, CANC. INT. CL. 37.

AMANA REFRIGERATION, INC. (DEL. CORP.), AMANA
IA:
713,164, CANC. U.S. CL. 31.

AMBLIN ENTERTAINMENT, INC., LOS ANGELES, CA:
1,741,809, REN. 4-8-02. INT. CL. 41.

AMCEST CORPORATION, ROSELLE, NJ:
1,886,431, CANC. INT. CL. 42.

AMERICA INTERSTATE CORPORATION, CITY OF WAL-
NUT, CA:
1,886,250, CANC. INT. CL. 32.

AMERICA'S FINEST, INC., CHARLOTTE, NC:
1,886,807, CANC. INT. CL. 36.

AMERICAL CORPORATION, HENDERSON, NC:
929,208, REN. 4-11-02. U.S. CL. 39 (INT. CL. 25).

AMERICAL CORPORATION, NEW YORK, NY:
1,886,155, CANC. INT. CL. 25.

AMERICAN ACADEMY OF NEUROLOGY, THE, SAINT
PAUL, MN:
2,571,380, PUB. 2-26-2002. INT. CL. 42.

AMERICAN AIRLINES, INC., DFW AIRPORT, TX:
2,570,820, PUB. 2-26-2002. MULTIPLE CLASS, INT. CLS.
18, 24, 25 AND 28.

AMERICAN ASSOCIATION OF MUSEUMS, WASHING-
TON, DC:
2,570,934, PUB. 2-26-2002. INT. CL. 42.

AMERICAN AVENTS CORPORATION, CINCINNATI, OH:
1,150,055, CANC. INT. CL. 41.

AMERICAN BIRKEBEINER SKI FOUNDATION, INC.,
HAYWARD, WI:
1,679,388, REN. 4-10-02. INT. CL. 16.

AMERICAN CENTER FOR WINE, FOOD AND THE ARTS,
THE, NAPA, CA:
2,571,724, INT. CL. 35.

AMERICAN COLLEGE OF NURSE-MIDWIVES INC., WA-
SHINGTON, DC:
2,572,153, MULTIPLE CLASS, INT. CLS. 41 AND 42.

AMERICAN CONSOLID, INC., DAVENPORT, IA:
1,885,747, CANC. INT. CL. 1.

AMERICAN CONSUMER PRODUCTS, LLC, LOS AN-
GELES, CA:
2,570,909, PUB. 2-26-2002. INT. CL. 3.

AMERICAN ELECTRONICS ENTERTAINMENT COR-
PORATION, PLEASANTON, CA:
1,885,864, CANC. INT. CL. 9.

AMERICAN EXPRESS COMPANY, NEW YORK, NY:
2,571,643, PUB. 2-26-2002. INT. CL. 36.
2,571,644, PUB. 2-26-2002. INT. CL. 36.

AMERICAN FENCE ASSOCIATION, INC, SNELLVILLE,
GA:
2,571,455, PUB. 2-26-2002. INT. CL. 35.

AMERICAN GREASE STICK COMPANY, MUSKEGON
HEIGHTS, MI:
713,027, CANC. U.S. CL. 15.

AMERICAN GREETINGS CORPORATION, CLEVELAND,
OH:
1,149,793, CANC. INT. CL. 16.

AMERICAN HEALTH KENNELS, INC., POMPANO BEACH,
FL:
1,697,887, REN. 4-7-02. INT. CL. 31.

AMERICAN HEART ASSOCIATION, DALLAS, TX:
1,885,983, CANC. INT. CL. 16.

AMERICAN HERITAGE INC., NEW YORK, NY, AMERI-
CAN HERITAGE PUBLISHING CO., INC., NEW YORK,
NY:
918,077, REN. 4-12-02. U.S. CL. 38 (INT. CL. 16).

AMERICAN HOSPITAL SUPPLY CORPORATION, EVAN-
STON, IL:
1,133,048, CANC. INT. CL. 10.

AMERICAN INFORMATION SYSTEMS, INC., WELL-
SBORO, PA:
1,885,911, CANC. INT. CL. 9.

AMERICAN INGREDIENTS COMPANY, KANSAS CITY,
MO, BREDDO-FOOD PRODUCTS CORPORATION, INC.,
KANSAS CITY, KS:
1,217,753, REN. 4-6-02. INT. CL. 30.

AMERICAN INSTITUTE OF BANKING OF GREATER NEW
YORK, THE, NEW YORK, NY:
2,572,385, INT. CL. 41.

AMERICAN INTERNATIONAL GROUP, INC., NEW YORK,
NY:
1,190,934, REN. 4-10-02. INT. CL. 36.

AMERICAN LUNG ASSOCIATION OF WASHINGTON,
SEATTLE, WA:
2,570,969, PUB. 10-30-2001. INT. CL. 36.

AMERICAN MANAGEMENT SYSTEMS, FAIRFAX, VA:
2,571,106, PUB. 2-26-2002. INT. CL. 9.

AMERICAN MOVIE CLASSICS COMPANY, BETHPAGE,
NY:
2,571,887, INT. CL. 41.

AMERICAN MULTI-CINEMA, INC., KANSAS CITY, MO:
1,737,200, REN. 4-10-02. INT. CL. 41.

AMERICAN NUTRITION, INC., OGDEN, UT:
1,190,182, REN. 4-12-02. INT. CL. 31.
1,658,445, REN. 4-10-02. INT. CL. 31.
1,662,684, REN. 4-10-02. INT. CL. 31.

AMERICAN OATS, INC, WAYZATA, MN:
2,571,071, PUB. 11-20-2001. INT. CL. 30.

AMERICAN RING CO., INC., EAST PROVIDENCE, RI:
1,639,027, CANC. INT. CL. 14.

AMERICAN STOCK EXCHANGE, LLC, NEW YORK, NY:
2,571,993, INT. CL. 36.

AMERICANA SEEDS, INC., MUSCATINE, IA:
1,149,986, CANC. INT. CL. 31.

AMERISOURCE HERITAGE CORPORATION, WILMING-
TON, DE:
2,571,436, PUB. 2-26-2002. INT. CL. 35.

AMERIVINE, INC., SANTA ROSA, CA:
2,570,933, PUB. 2-26-2002. INT. CL. 33.

AMERSHAM BIOSCIENCES AB, SE-751 84 UPPSALA, SWE-
DEN, PHARMACIA LKB BIOTECHNOLOGY INC., PIS-
CATAWAY, NJ:
1,710,962, REN. 4-12-02. INT. CL. 1.

AMF BOWLING, INC., MECHANICSVILLE, VA:
1,639,336, CANC. INT. CL. 7.

AMF INCORPORATED, WHITE PLAINS, NY:
386,124, CANC. U.S. CL. 19.

AMITY HOSIERY CO., INC., GARDEN CITY PARK, NY:
2,571,119, PUB. 8-14-2001. INT. CL. 25.

AMITY LEATHER PRODUCTS CO., WEST BEND, WI TO
TBAC INVESTMENT TRUST, ARLINGTON, TX:
1,853,081, CANC. INT. CL. 18.

AMORESSE LABORATORIES, INC., RIVERSIDE, CA:
1,571,514, CANC. INT. CL. 3.

AMWAY HOTEL CORPORATION, ADA, MI:
1,886,361, CANC. MULTIPLE CLASS, INT. CLS. 41 AND
42.

ANACOMP, INC., CARMEL, IN:
1,885,738, CANC. INT. CL. 1.

ANADIGM LTD., CREWE CW 1 6ZG, ENGLAND, UNITED
KINGDOM:
2,571,155, PUB. 2-26-2002. INT. CL. 9.

ANALYTICAL RESEARCH LABORATORIES, EDMOND,
OK:
2,572,014, INT. CL. 5.

- ANCOM INC., YORBA LINDA, CA:
1,885,849, CANC. INT. CL. 9.
- ANDE ROONEY INC., HIGHLAND, NY:
2,571,362, PUB. 2-26-2002. INT. CL. 21.
- ANDERSON PRODUCTS, INC., PALATINE, IL:
1,859,469, CANC. INT. CL. 7.
- ANGELICA CORPORATION, CHESTERFIELD, MO:
2,571,331, PUB. 2-26-2002. INT. CL. 25.
- ANGER, JULIE E., LIVONIA, MI, DBA POET GIFTS:
2,572,337, INT. CL. 25.
- ANGUS CHEMICAL COMPANY, BUFFALO GROVE, IL,
COMMERCIAL SOLVENTS CORPORATION, NEW
YORK, NY:
729,324, REN. 4-8-02. U.S. CL. 6 (INT. CL. 1).
- ANHEUSER-BUSCH, INCORPORATED, ST. LOUIS, MO:
2,570,883, PUB. 12-4-2001. INT. CL. 32.
- ANN ARBOR ANNUITY EXCHANGE, INC., ANN ARBOR,
MI:
2,571,101, PUB. 2-26-2002. INT. CL. 36.
- ANNUITY SOLUTIONS, INC., TORRANCE, CA:
2,571,036, PUB. 2-26-2002. INT. CL. 16.
- ANSCHUTZ & CO., G.M.B.H., ZEYSTR, 16-24, FED REP
GERMANY:
1,885,879, CANC. INT. CL. 9.
- ANSELL PROTECTIVE PRODUCTS INC., COSHOCTON,
OH, PDL TRUST, THE, CHICAGO, IL:
1,688,803, REN. 4-12-02. INT. CL. 9.
- ANSWERSPACE, INCORPORATED, NEW YORK, NY:
2,571,398, PUB. 2-26-2002. INT. CL. 42.
- ANYWHEREYOUGO.COM, INC., DALLAS, TX FROM PEO-
PLE DESIGN TECHNOLOGY, LLC, DALLAS, TX:
2,570,652, PUB. 2-26-2002. INT. CL. 35.
- AOC, LLC, COLLIERVILLE, TN:
2,571,815, INT. CL. 1.
- APACHE TECHNOLOGIES, INC., DAYTON, OH:
2,571,677, PUB. 2-26-2002. INT. CL. 9.
- APALACHEE PUBLISHING COMPANY, APALACHICOLA,
FL:
1,149,771, CANC. INT. CL. 16.
1,149,772, CANC. INT. CL. 16.
- APARACOR INC., EVANSTON, IL:
1,150,083, CANC. INT. CL. 42.
- APARACOR, INC., EVANSTON, IL:
1,150,082, CANC. INT. CL. 42.
- APEX THERMOGRAPHERS INC., KEARNEY, NE:
2,570,583, PUB. 9-11-2001. INT. CL. 35.
- APOGEE, INC., KING OF PRUSSIA, PA:
1,886,414, CANC. INT. CL. 42.
- APOLLO COLORS, INC., ROCKDALE, IL:
2,570,747, PUB. 4-24-2001. INT. CL. 2.
- APPLIED NATURAL SCIENCES, INC., HAMILTON, OH:
2,571,033, PUB. 2-26-2002. INT. CL. 42.
- APPLIED SCIENCE AND TECHNOLOGY, INC., WOBURN,
MA:
1,638,926, CANC. INT. CL. 9.
- APPLIED SOLUTIONS, INC., CARLSBAD, CA:
2,571,890, INT. CL. 29.
- APPSECURE, INC., MINNEAPOLIS, MN:
2,570,663, PUB. 5-23-2000. INT. CL. 9.
- APPSERV, INC.:
See—IBILL TECHNOLOGIES, L.L.C.
- AQUANTA CREATIVE INTELLIGENCE TECHNOLOGIES,
INC., CARBONDALE, CO 81623, CO:
1,886,379, CANC. INT. CL. 41.
- AQUARIA, INC., MOORPARK, CA:
1,675,044, REN. 4-8-02. INT. CL. 16.
- ARANGOLD CORPORATION, NORTHBROOK, IL:
2,571,089, PUB. 2-26-2002. INT. CL. 16.
- ARGONAUT SOFTWARE LIMITED, MIDDLESEX HAS
5XZ, ENGLAND:
2,571,902, MULTIPLE CLASS, INT. CLS. 9 AND 16.
- ARGUS SYSTEMS GROUP, INC., SAVOY, IL:
2,571,063, PUB. 2-26-2002. INT. CL. 9.
- ARIENS COMPANY, BRILLION, WI:
2,570,712, PUB. 2-26-2002. MULTIPLE CLASS, INT. CLS. 7
AND 8.
- ARITECH CORPORATION, HICKORY, NC:
1,639,412, CANC. INT. CL. 9.
- ARMAND & RICHARD, LOS ANGELES, CA, DBA CAPRICE
DESIGN:
1,893,131, CANC. INT. CL. 18.
- ARMKEL, LLC, PRINCETON, NJ, CARTER-WALLACE,
INC., NEW YORK, NY:
1,674,927, REN. 4-10-02. INT. CL. 10.
- ARMOR AII/STP PRODUCTS COMPANY, THE, OAKLAND,
CA:
2,570,964, PUB. 2-26-2002. MULTIPLE CLASS, INT. CLS. 2
AND 4.
- ARMSTRONG, CANDY S., KILL DEVIL HILLS, NC AND
COHOON, ANGELA R., KILL DEVIL HILLS, NC:
1,886,034, CANC. INT. CL. 16.
- ARNOLD, ROBERT, BIRMINGHAM, MI, DBA BOB AR-
NOLD AND ASSOCIATES FOOD BROKERS:
1,886,244, CANC. INT. CL. 31.
- ARONSON, CHARLES N., ARCADE, NY:
1,149,782, CANC. INT. CL. 16.
- ARROW INTERNATIONAL, INC., BROOKLYN, OH:
1,886,001, CANC. INT. CL. 16.
- ARSENEAU, WILLIAM F. JR., POMPANO BEACH, FL:
2,572,060, INT. CL. 41.
- ART AIDS AFRICA, AVONDALE ESTATES, GA:
2,571,568, PUB. 2-26-2002. MULTIPLE CLASS, INT. CLS.
35 AND 36.
- ARTHRITISIZE, INC., SATELLITE BEACH, FL:
2,571,267, PUB. 2-26-2002. INT. CL. 9.
- ARTHUR HOLLAND, INC., SINGER ISLAND, FL, ARTHUR
HOLLAND, INC., NEW YORK, NY:
1,191,961, REN. 4-12-02. INT. CL. 3.
- ARTURO SALICE S.P.A., 22060 NOVEDRATE (COMO),
ITALY:
2,484,599, COR. INT. CL. 6.
- ARXX BUILDING PRODUCTS, INC., COBOURG, ONTAR-
IO, CANADA FROM AAB BUILDING SYSTEM, INC.,
COBOURG, ONTARIO K9A 4J9, CANADA:
2,572,135, INT. CL. 41.
- AS LICENSING CORP., CHICAGO, IL:
1,886,110, CANC. INT. CL. 25.
- ASAHI, INC., LAWRENCEVILLE, GA:
1,886,655, CANC. INT. CL. 25.
- ASCO GROUP LIMITED, NEW HYDE PARK, NY:
1,886,105, CANC. INT. CL. 25.
1,886,107, CANC. INT. CL. 25.
- ASCOT CAR & UTE RENTALS AUSTRALIA PTY LTD.,
KINGS CROSS NSW 2011, AUSTRALIA:
2,570,700, PUB. 2-26-2002. INT. CL. 39.
- ASICS CORPORATION, KOBE 650-8555, JAPAN:
2,571,306, PUB. 2-26-2002. INT. CL. 24.
- ASPEN GROVE, INC., MARLTON, NJ:
2,571,840, MULTIPLE CLASS, INT. CLS. 9 AND 42.
- ASSOCIATED MATERIALS INCORPORATED, AKRON,
OH, DBA ALSIDE:
1,149,591, CANC. INT. CL. 6.
- ASSOCIATION FOR SUPERVISION AND CURRICULUM
DEVELOPMENT, ALEXANDRIA, VA:
2,571,731, INT. CL. 42.
- ASTRA AKTIEBOLAG, S-151 85 SODERTALJE, SWEDEN:
2,570,676, PUB. 2-26-2002. INT. CL. 5.
- ASTRO-MED, INC., WEST WARWICK, RI:
1,639,409, CANC. INT. CL. 9.
- AT&T CORP., NEW YORK, NY:
1,886,531, CANC. INT. CL. 9.
2,572,124, INT. CL. 36.
2,572,219, INT. CL. 38.
- ATI PROPERTIES, INC., GARDENA, CA:
2,572,378, INT. CL. 6.
- ATLANGENE APPLICATIONS, NANTES, FRANCE:
2,570,734, PUB. 1-22-2002. MULTIPLE CLASS, INT. CLS.
1, 5 AND 42.
- ATLANTA COMMITTEE FOR THE OLYMPIC GAMES,
INC., ATLANTA, GA TO UNITED STATES OLYMPIC
COMMITTEE, COLORADO SPRINGS, CO:
1,952,198, CANC. MULTIPLE CLASS, INT. CLS. 16, 18, 20,
21, 24, 25, 28 AND 41.
- ATLANTIC MUTUAL INSURANCE COMPANY, NEW
YORK, NY:
2,570,636, PUB. 2-26-2002. INT. CL. 36.

- ATLANTIC RICHFIELD COMPANY, CHICAGO, IL:
2,571,939, MULTIPLE CLASS, INT. CLS. 35 AND 42.
- AUDIBLE MAGIC CORPORATION, LOS GATOS, CA:
2,570,936, PUB. 2-26-2002. INT. CL. 9.
- AURA LENS PRODUCTS, INC., SAUK RAPIDS, MN:
2,570,595, PUB. 10-17-2000. INT. CL. 9.
- AURACLE SALON CORPORATION, IRVINGTON, NY:
2,571,293, PUB. 2-26-2002. INT. CL. 42.
- AURO TECH, INC., MENOMONEE FALLS, WI:
1,920,013, CANC. INT. CL. 30.
- AURORA LOAN SERVICES INC., AURORA, CO:
2,572,287, INT. CL. 36.
- AUSTIN NICHOLS & CO., INCORPORATED, NEW YORK, NY:
1,670,450, REN. 4-8-02. INT. CL. 33.
- AUSTIN, MICHAEL W., POINT PLEASANT, WV:
2,572,342, INT. CL. 28.
- AUSTIN, RICHARD D, SAN BERNADINO, CA, AUSTIN INDUSTRIES, SAN BERNARDINO, CA:
1,578,640, REN. 4-6-02. INT. CL. 7.
- AUSTIN, TODD M., ANN ARBOR, MI:
2,570,947, PUB. 2-26-2002. INT. CL. 9.
- AUSTRALIAN BEVERAGE EXPORTERS, PTY. LTD., MELBOURNE 3000, AUSTRALIA:
1,886,693, CANC. INT. CL. 32.
- AUTO TRIM DESIGN NETWORK, INC., INDIANAPOLIS, IN:
1,923,124, CANC. INT. CL. 37.
- AUTODESK, INC., SAN RAFAEL, CA:
2,572,160, INT. CL. 9.
- AUTOKAM-SHELBURG, LTD., SCOTTSDALE, AZ:
1,886,605, CANC. INT. CL. 12.
- AUTOMATED COMPLIANCE SYSTEMS, INC., BRIDGEWATER, NJ:
1,886,526, CANC. INT. CL. 9.
- AUTOMATIC DATA PROCESSING, INC., ROSELAND, DE, MANAGISTICS, INC., NEW YORK, NY:
1,190,219, REN. 4-9-02. INT. CL. 36.
- AUTOMATION SERVICES, INC., LEXINGTON, KY:
2,571,686, PUB. 2-26-2002. INT. CL. 9.
- AUTOMOTIVE EQUIPMENT SERVICE, INC., KANSAS CITY, MO, DBA AES-LAWNPARTS:
2,570,748, PUB. 11-6-2001. INT. CL. 7.
- AUTONATION HOLDING CORP., FORT LAUDERDALE, FL FROM AUTONATION, INC., FORT LAUDERDALE, FL:
2,572,098, INT. CL. 37.
- AUTOQUIP CORPORATION, GUTHRIE, OK:
1,885,825, CANC. INT. CL. 7.
- AVATAR INVESTORS ASSOCIATES CORP., NEW YORK, NY:
1,689,283, REN. 4-8-02. INT. CL. 36.
- AVCOM SYSTEMS, INC., SUNNYVALE, CA:
1,885,861, CANC. INT. CL. 9.
- AVID TECHNOLOGY, INC., TEWKSBURY, MA:
2,572,022, INT. CL. 9.
- AVIKO USA, LLC, JAMESTOWN, ND:
2,571,594, PUB. 2-26-2002. INT. CL. 29.
- AVITAN, ASHER, GRANADA HILLS, CA:
2,571,262, PUB. 2-26-2002. INT. CL. 9.
- AXON INSTRUMENTS, INC., UNION CITY, CA:
2,571,462, PUB. 2-26-2002. INT. CL. 9.
- AZERITY, SAN JOSE, CA:
2,571,672, PUB. 2-26-2002. MULTIPLE CLASS, INT. CLS. 9 AND 35.
- AZIEL, BARBIE-DAE, ALTAMONTE SPRINGS, FL:
2,571,334, PUB. 2-26-2002. INT. CL. 16.
- AZORIN & ASSOCIATES, TAMPA, FL, DBA VILLA ROSA DISTINCTIVE LINENS:
1,886,094, CANC. INT. CL. 24.
- B D INTERNATIONAL CORPORATION, PORTLAND, OR:
1,874,092, CANC. INT. CL. 31.
- B. FORMAN CO., INC., PHILADELPHIA, PA:
2,570,987, PUB. 2-26-2002. MULTIPLE CLASS, INT. CLS. 37 AND 42.
- B.J. ALAN COMPANY, YOUNGSTOWN, OH:
2,572,162, INT. CL. 13.
2,572,163, INT. CL. 13.
- B.V.T.V., INC., MARSTONS MILLS, MA:
2,570,957, PUB. 2-26-2002. INT. CL. 16.
- B&B HOLDINGS, INC., TEMPE, AZ, DBA PHOENIX CARDINALS:
1,885,984, CANC. MULTIPLE CLASS, INT. CLS. 16 AND 25.
- B-TREE VERIFICATION SYSTEMS, INC., MINNETONKA, MN:
1,885,869, CANC. INT. CL. 9.
1,885,870, CANC. INT. CL. 9.
- BABCOCK & WILCOX COMPANY, THE, NEW ORLEANS, LA:
1,885,950, CANC. INT. CL. 11.
- BABIARZ, DAVE, TUCSON, AZ:
2,571,990, INT. CL. 25.
- BABSON COLLEGE, WELLESLEY, MA:
2,572,081, INT. CL. 41.
- BACON FELT COMPANY, INC., EAST TAUNTON, MA:
1,149,575, CANC. INT. CL. 5.
- BACON, DOROTHY, MENOMONIE, WI:
2,571,527, PUB. 2-26-2002. INT. CL. 42.
- BACOU USA SAFETY, INC., MIDDLETOWN, CT:
2,571,161, PUB. 2-26-2002. INT. CL. 9.
- BACOU USA SAFETY, INC., SMITHFIELD, RI:
2,571,943, INT. CL. 9.
- BADGER AIR BRUSH CO., FRANKLIN PARK, IL:
1,189,785, REN. 4-10-02. INT. CL. 7.
- BADGER METER, INC., MILWAUKEE, WI:
1,638,975, CANC. INT. CL. 9.
- BAKER HUGHES INCORPORATED, HOUSTON, TX, TELECO OILFIELD SERVICES, INC., MERIDEN, CT:
1,674,905, REN. 4-6-02. INT. CL. 9.
- BAKER HUGHES INCORPORATED, HOUSTON, TX:
1,885,944, CANC. INT. CL. 11.
- BALANCE SPECIALTIES, INC., CHICAGO, IL:
2,572,084, INT. CL. 9.
- BALANCED BODY, INC., SACRAMENTO, CA:
2,570,605, PUB. 2-26-2002. INT. CL. 28.
- BALCOM CHEMICALS, INC., GREELEY, CO, DBA MPOWER 3:
2,572,345, INT. CL. 40.
- BALDOR ELECTRIC COMPANY, FORT SMITH, AR:
1,886,764, CANC. INT. CL. 7.
1,886,767, CANC. INT. CL. 7.
- BALDWIN GRAFOTEC GMBH, D-88165 AUGSBURG, FED REP GERMANY:
2,570,681, PUB. 12-18-2001. MULTIPLE CLASS, INT. CLS. 7 AND 11.
- BALDWIN HARDWARE CORPORATION, READING, PA:
2,572,118, INT. CL. 21.
- BALEEN FILTERS PTY LIMITED, UNLEY, SOUTH AUSTRALIA, AUSTRALIA:
2,570,635, PUB. 10-24-2000. INT. CL. 11.
- BALLET MAKERS, INC., TOTOWA, NJ:
2,571,827, INT. CL. 25.
- BAMFLEX.COM, INC., CULVER CITY, CA:
2,570,755, PUB. 2-26-2002. INT. CL. 35.
- BANDAG LICENSING CORPORATION, MUSCATINE, IA:
2,570,826, PUB. 2-26-2002. INT. CL. 7.
- BANKRATE, INC., NORTH PALM BEACH, FL:
2,572,346, INT. CL. 36.
- BARAZZOTTO, ZOT, XENIA, OH, DBA TETON TECHNOLOGY:
2,571,718, INT. CL. 10.
- BARNES, RUTH, ST. LOUIS PARK, MN:
2,571,175, PUB. 2-26-2002. INT. CL. 9.
- BARNETT LIPTON PRODUCTIONS, INC., NEW YORK, NY:
1,886,261, CANC. MULTIPLE CLASS, INT. CLS. 35 AND 41.
- BARNEY'S, INC., NEW YORK, NY:
2,571,696, MULTIPLE CLASS, INT. CLS. 24 AND 25.
- BARTEL, JOYCE, SAN CARLOS, CA, DBA REAL ESTATE EFFICIENCY SYSTEMS:
1,886,478, CANC. MULTIPLE CLASS, INT. CLS. 9, 16 AND 41.
- BARTON BRANDS, LTD., CHICAGO, IL:
713,268, CANC. U.S. CL. 49.

- BASF CORPORATION, PARSIPPANY, NJ:
1,885,734, CANC. INT. CL. 1.
- BAT ACQUISITION, LLC, PITTSBURGH, PA FROM BAY
ADVANCED TECHNOLOGIES, INC., MENLO PARK, CA:
2,570,604, PUB. 2-26-2002. MULTIPLE CLASS, INT. CLS.
35 AND 40.
- BATEMAN, BRENT A., LOS ANGELES, CA:
2,571,148, PUB. 2-26-2002. MULTIPLE CLASS, INT. CLS.
25, 30 AND 39.
- BATES ADVERTISING USA, INC., NEW YORK, NY:
2,570,880, PUB. 2-26-2002. INT. CL. 35.
- BAUMGARTNER PAPIERS S.A., 1023 CRISSIER, SWITZER-
LAND:
2,571,297, PUB. 2-26-2002. INT. CL. 34.
2,571,298, PUB. 2-26-2002. INT. CL. 34.
- BAUSCH & LOMB INCORPORATED, ROCHESTER, NY:
2,571,287, PUB. 2-26-2002. INT. CL. 9.
- BAXTER INTERNATIONAL INC.:
See— EDWARDS LIFESCIENCES CORPORATION.
- BAY ADVANCED TECHNOLOGIES, INC.:
See— BAT ACQUISITION, LLC.
- BAYER CORPORATION, PITTSBURGH, PA:
2,572,212, INT. CL. 5.
2,572,264, INT. CL. 5.
- BAYPORT RESTAURANT GROUP, INC., HOLLYWOOD, FL
TO LANDRY'S TRADEMARK, INC., WILMINGTON, DE:
1,868,759, CANC. INT. CL. 42.
1,870,877, CANC. INT. CL. 42.
- BB TECHNOLOGIES, INC., WILMINGTON, DE:
2,570,760, PUB. 6-5-2001. INT. CL. 42.
- BBC INTERNATIONAL LTD., BOCA RATON, FL:
1,622,606, CANC. MULTIPLE CLASS, INT. CLS. 25 AND
42.
- BEAGLE I, INC., MONTEREY PARK, CA:
1,886,663, CANC. INT. CL. 27.
- BEALL, RICHARD W. (SKIP) III, HERMOSA BEACH, CA:
1,684,507, REN. 4-12-02. INT. CL. 25.
1,694,541, REN. 4-12-02. INT. CL. 25.
1,703,378, REN. 4-9-02. INT. CL. 25.
1,739,968, REN. 4-9-02. INT. CL. 25.
1,739,969, REN. 4-8-02. INT. CL. 25.
- BEAMCO, MOUNTAIN VIEW, CA:
2,571,730, INT. CL. 7.
- BEATTY CONTRACTORS & WRECKERS, LTD., NAZAR-
ETH, PA:
1,683,981, REN. 4-9-02. INT. CL. 37.
- BEAULIEU CANADA COMPANY, ACTON VALE, QUEBEC
FROM PEERLESS CARPET CORPORATION, ACTON
VALE, CANADA:
2,570,520, PUB. 2-26-2002. INT. CL. 35.
- BEAULIEU GROUP, LLC, DALTON, GA:
2,570,698, PUB. 6-26-2001. INT. CL. 27.
- BECKMAN COULTER, INC., FULLERTON, CA, BECKMAN
INSTRUMENTS, INC., FULLERTON, CA:
1,189,825, REN. 4-10-02. INT. CL. 9.
- BECKMAN INSTRUMENTS, INC.:
1,149,525, CANC. MULTIPLE CLASS, INT. CLS. 1 AND 9.
- BEE-TEK LTD., HATBORO, PA:
1,886,567, CANC. INT. CL. 9.
- BEECH MEDICAL PRODUCTS, INC., NEW PORT RICHEY,
FL, BIMECO, INC., LARGO, FL:
1,654,086, REN. 4-8-02. INT. CL. 10.
- BEELE ENGINEERING B.V., 7122 NZ AALTEN, NETHER-
LANDS:
2,533,817, COR. MULTIPLE CLASS, INT. CLS. 6, 9, 17, 19
AND 42.
- BEEMA INCORPORATED, CAMPBELL, CA:
2,571,502, PUB. 2-26-2002. INT. CL. 42.
- BELL ATLANTIC CORPORATION, PHILADELPHIA, PA:
1,886,000, CANC. MULTIPLE CLASS, INT. CLS. 16 AND
38.
- BELL, LAWRENCE L., BETHESDA, MD:
2,570,699, PUB. 7-17-2001. INT. CL. 36.
- BELLAGIO:
See— BELLAGIO, LLC.
- BELLAGIO, LLC., LAS VEGAS, NV FROM BELLAGIO, LAS
VEGAS, NV:
2,570,928, PUB. 2-26-2002. INT. CL. 41.
- BELLSOUTH INTELLECTUAL PROPERTY CORPORA-
TION, WILMINGTON, DE FROM BELLSOUTH COR-
PORATION, ATLANTA, GA:
2,571,758, INT. CL. 38.
- BENDEL, FRANK, 21379 BOLTERSEN, FED REP GER-
MANY:
2,571,996, MULTIPLE CLASS, INT. CLS. 6, 7 AND 8.
- BENEFIT COSMETICS LLC, SAN FRANCISCO, CA:
2,571,425, PUB. 2-26-2002. INT. CL. 3.
- BENETTON GROUP S.P.A., 31050 PONZANO VENETO
(TREVISO), ITALY:
1,639,135, CANC. INT. CL. 25.
- BENNETT, BRAD, ST. GEORGE, UT:
2,570,875, PUB. 2-26-2002. INT. CL. 11.
- BENNETT, CHRISTOPHER ROBERT, ST. HELIERS, AUCK-
LAND, NEW ZEALAND:
2,570,646, PUB. 2-26-2002. INT. CL. 25.
- BENNETT, LEIGH, VAN NUYS, CA:
2,572,194, MULTIPLE CLASS, INT. CLS. 41 AND 42.
- BENSHOP, JOHN, BOSTON, MA:
2,571,591, PUB. 2-26-2002. INT. CL. 41.
- BENTLEY'S LUGGAGE CORP.:
1,149,821, CANC. INT. CL. 18.
- BENTZ, WILLIAM, LA MESA, CA:
2,571,465, PUB. 2-26-2002. INT. CL. 25.
- BERGEN BRUNSWIG CORPORATION, ORANGE, CA:
2,571,335, PUB. 2-26-2002. INT. CL. 35.
- BERGHAUS LIMITED, FINCHLEY, LONDON N3 2QL,
ENGLAND:
2,570,971, PUB. 6-26-2001. MULTIPLE CLASS, INT. CLS.
24 AND 25.
2,571,020, PUB. 2-26-2002. INT. CL. 17.
- BERKELEY HEARTLAB, INC., SAN MATEO, CA:
2,571,576, PUB. 2-26-2002. INT. CL. 42.
- BERMUDA DEPARTMENT OF TOURISM, HAMILTON HM
12, BERMUDA:
2,572,375, INT. CL. 41.
- BERMUDA LIMOUSINE INTERNATIONAL, INC., NEW
YORK, NY:
1,684,684, REN. 4-10-02. INT. CL. 39.
- BERRYMAN PRODUCTS, INC., ARLINGTON, TX:
2,533,751, COR. MULTIPLE CLASS, INT. CLS. 1, 16 AND
25.
- BERTRAND, ROBERT, BATON ROUGE, LA:
2,572,180, INT. CL. 7.
- BERTUCCI'S RESTAURANT CORP., WAKEFIELD, MA,
BERTUCCI'S, INC., WOBURN, MA:
1,624,185, REN. 4-12-02. INT. CL. 42.
- BETAEXPRESS, INC., ENDICOTT, NY:
2,572,167, INT. CL. 5.
- BETTER SLEEP, INC., BERKELEY HEIGHTS, NJ:
2,572,366, INT. CL. 27.
- BETZDEARBORN INC., TREVISO, PA:
2,570,727, PUB. 10-10-2000. INT. CL. 42.
- BEYAZIAN, SERGIO, COLUMBUS, OH:
2,571,587, PUB. 2-26-2002. INT. CL. 42.
- BFS BRANDS, LLC, NASHVILLE, TN, FIRESTONE TIRE &
RUBBER COMPANY, THE, AKRON, OH:
1,170,711, REN. 4-12-02. INT. CL. 42.
- BHA GROUP HOLDINGS, INC., KANSAS CITY, MO:
2,571,146, PUB. 2-26-2002. INT. CL. 9.
- BHS HOLDINGS, LLC, NEW YORK, NY:
2,570,803, PUB. 2-26-2002. INT. CL. 36.
- BIG CITY BAGELS, INC., HICKSVILLE, NY:
1,817,038, CANC. INT. CL. 30.
- BIG DOG HOLDINGS, INC., SANTA BARBARA, CA:
2,570,563, PUB. 2-6-2001. INT. CL. 35.
- BIGELOW DEVELOPMENT AEROSPACE LIMITED LIAB-
ILITY COMPANY, LAS VEGAS, NV:
2,571,575, PUB. 2-26-2002. INT. CL. 42.
- BIKE & BRUNCH, INC., BETHESDA, MD:
2,571,637, PUB. 2-26-2002. INT. CL. 41.
- BILIBOTTOMS, INC., HERSHEY, PA:
2,571,662, PUB. 2-26-2002. INT. CL. 16.
- BILL BLASS INTERNATIONAL LLC, NEW YORK, NY
FROM BILL BLASS, LTD., NEW YORK, NY:
2,571,865, INT. CL. 25.

- BILL COMMUNICATIONS, INC., NEW YORK, NY:
1,639,419, CANC. INT. CL. 16.
- BILLIART, INC., NORTHBROOK, IL:
1,886,201, CANC. INT. CL. 28.
- BILTMORE COMPANY, THE, ASHEVILLE, NC, AKA BILTMORE ESTATE:
1,673,704, REN. 4-9-02. INT. CL. 41.
- BIMEDA INC., RIVERSIDE, MO, SANOFI ANIMAL HEALTH, INC., OVERLAND PARK, KS:
1,706,201, REN. 4-7-02. INT. CL. 5.
- BINDING SITE LIMITED, THE, BIRMINGHAM, UNITED KINGDOM:
1,751,742, REN. 4-8-02. MULTIPLE CLASS, INT. CLS. 1 AND 5.
1,751,743, REN. 4-8-02. MULTIPLE CLASS, INT. CLS. 1 AND 5.
- BIO-RAD LABORATORIES INC., HERCULES, CA:
1,736,230, REN. 4-10-02. INT. CL. 9.
- BIODAN MEDICAL SYSTEMS LTD., REHOVOT, 76 120, ISRAEL:
1,885,929, CANC. INT. CL. 10.
- BIODIGITAL TECHNOLOGIES, INC., MCKINNEY, TX:
1,675,468, REN. 4-6-02. INT. CL. 42.
- BIOELEMENTS, INC., CHICAGO, IL, BARBARA SALOMONE AND ASSOCIATES, INC., DES PALINES, IL, DBA BARBARA SALOMONE:
1,684,104, REN. 4-6-02. MULTIPLE CLASS, INT. CLS. 3 AND 5.
- BIOSAND INTERNATIONAL, INC., LANSDOWNE, PA:
1,886,497, CANC. INT. CL. 1.
- BIOSPECIFICS, LLC, HOUSTON, TX:
2,570,723, PUB. 5-22-2001. INT. CL. 5.
- BIOTEST LABORATORIES, LLC, COLORADO SPRINGS, CO:
2,571,913, INT. CL. 5.
- BIRCH POINT MEDICAL, INC., OAKDALE, MN:
2,571,142, PUB. 2-26-2002. INT. CL. 10.
- BIRCH TREE STUDIO, LLC, LAKE FOREST, IL:
2,571,194, PUB. 2-26-2002. INT. CL. 14.
- BITTLE, JAMES J., SAN DIEGO, CA:
1,871,014, CANC. INT. CL. 7.
- BIZAVINGS, INC., LAS VEGAS, NV:
2,571,166, PUB. 2-26-2002. INT. CL. 35.
- BIZWARE COMPUTER SYSTEMS (CANADA) INC., MONTREAL, QUEBEC H4X 1N1, CANADA:
1,836,627, CANC. MULTIPLE CLASS, INT. CLS. 9 AND 42.
- BKL TECHNOLOGIES INC., BROWNSVILLE, TX:
2,571,753, INT. CL. 9.
- BLACK HAWK-GRUNDY MENTAL HEALTH CENTER, INC., WATERLOO, IA:
2,571,524, PUB. 2-26-2002. INT. CL. 41.
- BLANK, MICHAEL, M., D.D.S., MT AIRY, MD:
1,639,059, CANC. INT. CL. 16.
- BLANKS, WILLIE R., ERIE, PA:
2,570,729, PUB. 2-26-2002. MULTIPLE CLASS, INT. CLS. 25 AND 41.
- BLAUER MANUFACTURING COMPANY, INC., BOSTON, MA:
2,572,112, INT. CL. 25.
- BLINDS TO GO (U.S.) INC., LAKEWOOD, NJ:
2,570,980, PUB. 2-26-2002. INT. CL. 6.
- BLOUNT, INC., PORTLAND, OR:
2,572,044, INT. CL. 7.
- BLUE BELL, INC., GREENSBORO, NC TO WRANGLER CLOTHING CORP., WILMINGTON, DE:
1,630,154, CANC. INT. CL. 25.
- BLUE CHIP FASTENERS, INC., CINCINNATI, OH:
2,570,981, PUB. 9-18-2001. INT. CL. 35.
- BLUE CROSS AND BLUE SHIELD ASSOCIATION, CHICAGO, IL:
2,571,307, PUB. 2-26-2002. INT. CL. 36.
- BLUE CROSS BLUE SHIELD ASSOCIATION, CHICAGO, IL:
1,885,995, CANC. INT. CL. 16.
- BLUE RIDGE BEEFALO, INC., ASHEVILLE, NC:
1,886,206, CANC. INT. CL. 29.
- BLUECADIA AQUACULTURE INC., FAIRFAX, VA:
2,571,243, PUB. 2-26-2002. INT. CL. 29.
- BLUESTAR UNDERWRITERS, LLC, CHARLOTTE, NC:
2,570,655, PUB. 5-16-2000. INT. CL. 36.
- BOARD OF GOVERNORS OF SOUTHWEST MISSOURI STATE UNIVERSITY, SPRINGFIELD, MO:
1,706,647, REN. 4-11-02. MULTIPLE CLASS, INT. CLS. 16, 21, 25 AND 41.
- BOARD OF REGENTS, THE UNIVERSITY OF TEXAS SYSTEM, AUSTIN, TX:
2,572,259, MULTIPLE CLASS, INT. CLS. 24 AND 25.
- BOARD OF TRUSTEES OF THE CARNEGIE LIBRARY OF PITTSBURGH, THE, PITTSBURGH, PA:
1,681,993, REN. 4-10-02. INT. CL. 16.
- BOARD OF TRUSTEES OF THE LELAND STANFORD JUNIOR UNIVERSITY, THE, STANFORD, CA:
2,571,159, PUB. 2-26-2002. INT. CL. 42.
- BOATMEN'S BANCSHARES, INC., ST. LOUIS, MO:
1,886,282, CANC. INT. CL. 36.
- BOB'S SPACE RACERS, INC., DAYTONA BEACH, FL:
2,571,554, PUB. 2-26-2002. INT. CL. 28.
- BODA NOVA HOLDING AB, HOGANAS, SWEDEN:
2,570,594, PUB. 3-6-2001. MULTIPLE CLASS, INT. CLS. 8 AND 21.
- BODY THERAPEUTICS, LAKE ELSINORE, CA:
1,177,292, REN. 4-6-02. INT. CL. 20.
- BOEHRINGER MANNHEIM CORPORATION, INDIANAPOLIS, IN:
1,886,563, CANC. INT. CL. 9.
- BOEING MANAGEMENT COMPANY, SEAL BEACH, CA, BOEING COMPANY, THE, SEATTLE, WA:
1,674,979, REN. 4-10-02. INT. CL. 12.
1,674,980, REN. 4-10-02. INT. CL. 12.
- BOLD DISTRIBUTION, INC., CAPE CORAL, FL:
2,571,042, PUB. 2-26-2002. MULTIPLE CLASS, INT. CLS. 25 AND 28.
- BONFARE FOOD STORES, INC., BOONVILLE, NY:
1,886,217, CANC. INT. CL. 30.
- BONIDE PRODUCTS, INC., ORISKANY, NY:
2,571,289, PUB. 2-26-2002. MULTIPLE CLASS, INT. CLS. 1 AND 5.
- BOOTH, CYNTHIA ALLEN, DARNESTOWN, MD:
2,571,193, PUB. 9-11-2001. INT. CL. 42.
- BOREGAARD, PEDRO, NEW YORK, NY:
2,571,457, PUB. 2-26-2002. INT. CL. 14.
- BORROUGHS CORPORATION, KALAMAZOO, MI, ANDREW WILSON COMPANY, LAWRENCE, MA:
1,197,273, REN. 4-11-02. INT. CL. 20.
- BOSE CORPORATION, FRAMINGHAM, MA:
2,571,971, INT. CL. 9.
- BOSS/WATER MARKETING CORPORATION, THE, SALT-SPRING ISLAND, BRITISH COLUMBIA, CANADA:
1,886,691, CANC. INT. CL. 32.
- BOSTON DUCK TOURS, LIMITED PARTNERSHIP, BOSTON, MA:
2,570,524, PUB. 9-21-1999. INT. CL. 39.
- BOSTON'S FOURTH OF JULY, INC., BOSTON, MA:
2,571,540, PUB. 2-26-2002. INT. CL. 41.
- BOTHE, KLAUS, 92056 ICKING, FED REP GERMANY AND HIESINGER, REINHARD, 87724 OTTOBEUREN, FED REP GERMANY AND MANN, KURT, 87748 FELLHEIM, FED REP GERMANY:
2,570,528, PUB. 6-19-2001. MULTIPLE CLASS, INT. CLS. 9 AND 11.
- BOVINE HEALTH PRODUCTS, INC., GRANGEVILLE, ID:
2,571,213, PUB. 2-26-2002. INT. CL. 5.
- BOYDS COLLECTION, LTD, THE, MCSHERRYSTOWN, PA:
2,571,426, PUB. 2-26-2002. INT. CL. 20.
- BOYER INDUSTRIES CORPORATION, LAWRENCE, KS, PROSOCO, INC., KANSAS CITY, KS:
1,692,276, REN. 4-6-02. INT. CL. 2.
- BP AMOCO P.L.C., LONDON EC2M 7BA, ENGLAND FROM BRITISH PETROLEUM COMPANY P.L.C., THE, LONDON EC2M 7BA, ENGLAND:
2,570,486, PUB. 8-8-2000. MULTIPLE CLASS, INT. CLS. 35 AND 37.
2,570,504, PUB. 7-25-2000. INT. CL. 4.
- BPB ACQUISITION, INC., MISSISSAUGUA, ONTARIO, CANADA, CELOTEX CORPORATION, THE, TAMPA, FL:
1,679,411, REN. 4-7-02. INT. CL. 19.

- BRACH VAN HOUTEN HOLDING INC., OAKBROOK TERRACE, IL:
1,886,486, CANC. MULTIPLE CLASS, INT. CLS. 16 AND 30.
- BRADMARK TECHNOLOGIES, INC., HOUSTON, TX:
1,885,900, CANC. INT. CL. 9.
- BRAINHEAD.COM, SOUTHPORT, CT FROM BRAVE NEW KITCHEN, INC., BIRMINGHAM, MI:
2,571,863, INT. CL. 42.
- BRANDJUICE CONSULTING, INC., DENVER, CO:
2,571,201, PUB. 2-26-2002. INT. CL. 35.
- BRANFORD COMPANIES, INC., THE, SUMMERVILLE, SC:
2,571,737, INT. CL. 10.
- BRAZLEY, ALVIN LORENZO, BLUE ISLAND, IL:
2,572,215, INT. CL. 41.
- BREAD FOR THE CITY, INC., WASHINGTON, DC:
2,572,157, MULTIPLE CLASS, INT. CLS. 36 AND 42.
- BREAKAWAY PUBLISHING, LTD., ALBANY, TX:
2,571,447, PUB. 2-26-2002. INT. CL. 41.
- BREATHE AMERICA, INC., NASHVILLE, TN:
2,571,512, PUB. 2-26-2002. INT. CL. 9.
- BRECONCHERRY LIMITED, LEDBURY, HEREFORDSHIRE, HR8 2DH, ENGLAND:
2,571,767, INT. CL. 7.
- BREDDERMAN, THEODORE A., DELMAR, NY, DBA DEL DESIGNS:
2,571,761, INT. CL. 21.
- BREWSTER WALLCOVERING COMPANY, RANDOLPH, MA:
2,572,155, INT. CL. 27.
- BRICK HANAUER CO., WALTHAM, MA, DBA BRICK HANAUER, INC.:
1,886,259, CANC. INT. CL. 34.
- BRICKELL FINANCIAL SERVICES-MOTOR CLUB, INC., CORAL GABLES, FL:
2,571,257, PUB. 2-26-2002. INT. CL. 42.
- BRIGANTINE, THE, SAN DIEGO, CA:
2,570,558, PUB. 2-26-2002. INT. CL. 42.
- BRIGHTHOUSE, LLC, ATLANTA, GA FROM GGT U.S.A./SOUTH, INC., ATLANTA, GA, DBA BRIGHTHOUSE:
2,571,710, INT. CL. 35.
- BRISTOL GOLF CORPORATION, ELK GROVE VILLAGE, IL TO RAM GOLF CORPORATION, MELROSE PARK, IL:
1,234,702, CANC. INT. CL. 25.
- BRISTOL HOSPITAL, BRISTOL, CT:
2,571,192, PUB. 8-14-2001. INT. CL. 42.
- BRITE MUSIC ENTER. INC., SALT LAKE CITY, UT, DBA BRITE MUSIC INC.:
2,570,886, PUB. 2-26-2002. INT. CL. 16.
- BRITISH PETROLEUM COMPANY P.L.C., THE:
See— BP AMOCO P.L.C..
- BRITISH PETROLEUM COMPANY P.L.C., THE:
See— BP AMOCO P.L.C..
- BRODOW, ED, MONTEREY, CA:
1,886,383, CANC. INT. CL. 41.
- BROTHERHOOD MUTUAL INSURANCE COMPANY, FT. WAYNE, IN:
2,570,996, PUB. 2-26-2002. INT. CL. 36.
- BROWN RAYSMAN MILLSTEIN FELDER & STEINER LLP, NEW YORK, NY:
2,572,352, INT. CL. 41.
- BROWN, JEAN MARIE, KENSINGTON, CA, DBA BED & BREAKFAST INTERNATIONAL:
1,150,088, CANC. INT. CL. 42.
- BROWNSTONE PUBLISHERS, INC., NEW YORK, NY:
2,572,213, INT. CL. 16.
- BRUDER, BARRY, SANTA MONICA, CA:
2,572,377, INT. CL. 42.
- BRUNSWICK BOWLING & BILLIARDS CORPORATION, MUSKEGON, MI:
1,886,100, CANC. MULTIPLE CLASS, INT. CLS. 24, 25 AND 28.
- BRUNSWICK CORPORATION, LAKE FOREST, IL:
2,570,974, PUB. 2-26-2002. INT. CL. 28.
- BRUSKE ENTERPRISES, INC., TINLEY PARK, IL:
1,684,996, REN. 4-10-02. INT. CL. 3.
- BTK INTERNATIONAL, INC., BAINBRIDGE ISLAND, WA:
2,570,592, PUB. 2-26-2002. INT. CL. 30.
- BUCKEYE CABLEVISION, INC., TOLEDO, OH:
2,571,752, INT. CL. 9.
- BUCKEYE INTERNATIONAL, INC., MARYLAND HEIGHTS, MO:
1,697,458, REN. 4-12-02. INT. CL. 9.
- BUEHLER LTD., LAKE BLUFF, IL:
2,572,016, INT. CL. 7.
- BUFFALO BILLS, INC., ORCHARD PARK, NY:
2,571,410, PUB. 2-26-2002. MULTIPLE CLASS, INT. CLS. 16, 25, 28 AND 41.
- BULLFROG TECHNOLOGIES, LLC, ENGLEWOOD, CO:
2,571,513, PUB. 2-26-2002. MULTIPLE CLASS, INT. CLS. 35 AND 42.
- BUNDY CORPORATION, WARREN, MI, BUNDY TUBING COMPANY, DETROIT, MI:
289,329, REN. 4-12-02. U.S. CL. 13 (INT. CL. 6).
- BURGESS CHEMICALS, LTD., BALTIMORE, MD:
2,570,988, PUB. 2-26-2002. INT. CL. 2.
- BURRELL, DEBRA S., BIRMINGHAM, AL:
2,571,950, INT. CL. 42.
- BURROUGHS CORPORATION, DETROIT, MI:
713,189, CANC. U.S. CL. 37.
- BUSH HOLDING, VAILLANT, BOLOGNE, FRANCE, CHAPELIER, HERVE, 92100 BOULOGNE BILLANCOURT, FRANCE:
1,728,789, REN. 4-6-02. INT. CL. 18.
- BUSINESS GUIDES, INC., NEW YORK, NY:
1,676,426, REN. 4-11-02. INT. CL. 16.
- BUTZEL LONG, DETROIT, MI:
2,570,908, PUB. 2-26-2002. INT. CL. 42.
- BUYLINK CORPORATION, SAN MATEO, CA FROM BUYLINK.COM, INC., SOUTH SAN FRANCISCO, CA:
2,570,860, PUB. 2-26-2002. INT. CL. 9.
- BUYLINK.COM, INC.:
See— BUYLINK CORPORATION.
- BWI COMPANIES, INC., NASH, TX:
1,886,499, CANC. INT. CL. 1.
- BYRON & POOLE, INC., NEW YORK, NY:
1,886,113, CANC. INT. CL. 25.
- BYRON KATIE, INC., MANHATTAN BEACH, CA:
2,570,925, PUB. 2-26-2002. INT. CL. 41.
- C & C DISTRIBUTORS, INC., CHINA, ME:
2,571,520, PUB. 2-26-2002. MULTIPLE CLASS, INT. CLS. 12 AND 19.
- C & E ENTERPRISE, INC., GUADALUPE, CA, DBA KOYAMA FARMS:
1,149,999, CANC. INT. CL. 31.
- C. J. VAN HOUTEN & ZOON B.V., WEESP, NETHERLANDS:
713,253, CANC. U.S. CL. 46.
- C.A.O. INTERNATIONAL, INC., NASHVILLE, TN:
2,570,586, PUB. 8-28-2001. INT. CL. 34.
- C.B. FLEET INVESTMENT CORPORATION, WILMINGTON, DE:
2,571,802, INT. CL. 5.
- C.E.O.SPA, LLC, DALLAS, TX:
2,570,785, PUB. 2-26-2002. INT. CL. 35.
- C.M.C. TRAILER DISTRIBUTORS, INC., FT. WORTH, TX:
1,871,212, CANC. INT. CL. 12.
1,871,213, CANC. INT. CL. 12.
1,871,576, CANC. INT. CL. 37.
- C.R. EKERN & COMPANY, PHOENIX, AZ:
2,572,240, INT. CL. 41.
- C.S.F. CORP., WILMINGTON, DE:
1,639,319, CANC. INT. CL. 42.
2,570,615, PUB. 2-26-2002. INT. CL. 25.
- CABANILLAS, JOSE GONZALO, BOULDER, CO AND ST. CLAIRE, DEBRA JEANE, BOULDER, CO:
1,901,385, CANC. INT. CL. 42.
- CABELA'S INCORPORATED, SIDNEY, NE:
2,572,131, INT. CL. 28.
- CAFE EL REY, S.A., SAN JOSE, COSTA RICA:
1,886,218, CANC. INT. CL. 30.
- CAFEPRESS.COM, HAYWARD, CA:
2,571,049, PUB. 2-26-2002. INT. CL. 35.
- CALCADOS AZAIEIA S.A., 95630 PAROBE/ RS, BRAZIL:
2,570,588, PUB. 2-26-2002. INT. CL. 25.
- CALIFORNIA IMPRINTED APPAREL, INC., VISTA, CA:
2,571,906, INT. CL. 25.

CALIFORNIA INSTITUTE OF TECHNOLOGY, PASADENA, CA:
1,639,123, CANC. INT. CL. 21.

CALIFORNIA IVY, INC., VERNON, CA:
1,886,141, CANC. INT. CL. 25.

CALIFORNIA SCENTS, IRVINE, CA:
2,571,000, PUB. 2-26-2002. INT. CL. 5.

CALIFORNIA STROLEE, INC., COMPTON, CA, AKA STROLLEE OF CALIFORNIA:
1,149,726, CANC. INT. CL. 12.

CALIFORNIA SUNCARE, INC., LOS ANGELES, CA:
1,885,759, CANC. INT. CL. 3.

CALIFORNIA VERKOOPMAATSCHAPPIJ B.V., 3842 LE HARDERWIJK, NETHERLANDS:
1,886,205, CANC. MULTIPLE CLASS, INT. CLS. 29, 30 AND 31.

CALLAWAY GOLF COMPANY, CARLSBAD, CA:
2,571,636, PUB. 2-26-2002. INT. CL. 28.
2,572,230, INT. CL. 28.

CALLIGAN, JOHN S, ELLERSLIE, MD:
2,571,529, PUB. 2-26-2002. INT. CL. 35.

CALTERM, INC., EL CAJON, CA:
1,885,921, CANC. INT. CL. 9.

CALTOMIC CORPORATION, GARDENA, CA:
2,572,141, INT. CL. 8.

CAMBRIDGE IN AMERICA, NEW YORK, NY:
2,571,266, PUB. 2-26-2002. INT. CL. 36.

CAMERA DEN, INC., SALT LAKE CITY, UT, DBA THE GORILLA BICYCLE CO.:
1,886,322, CANC. MULTIPLE CLASS, INT. CLS. 37 AND 42.
1,886,323, CANC. MULTIPLE CLASS, INT. CLS. 37 AND 42.

CAMPBELLSVILLE INDUSTRIES, INC., CAMPBELLSVILLE, KY:
2,571,973, INT. CL. 6.

CAMPUS ASSOCIATES, WOODBURY, NY:
2,572,144, INT. CL. 41.

CAMPUS ASSOCIATES, NEW YORK, VA:
2,572,145, INT. CL. 41.

CAMPUSCAREERCENTER.COM, INC., CAMBRIDGE, MA:
2,572,266, INT. CL. 35.

CANAC INC., MONTREAL, H3B 3A5 QUEBEC, CANADA:
2,570,611, PUB. 11-20-2001. INT. CL. 9.

CANAD, INC., MANCHESTER, NH:
1,886,358, CANC. INT. CL. 41.

CANADIAN CENTRE FOR HIGH PERFORMANCE INC., COLLINGWOOD, ONTARIO, CANADA:
1,886,008, CANC. MULTIPLE CLASS, INT. CLS. 16 AND 41.

CANON KABUSHIKI KAISHA, TOKYO, JAPAN:
2,571,892, INT. CL. 9.

CANTALUPI S.R.L., VIAREGGIO (LU), ITALY:
2,570,897, PUB. 4-10-2001. INT. CL. 11.

CAP-TECH PRODUCTS, INC., HARTFORD, CT:
2,572,319, MULTIPLE CLASS, INT. CLS. 19 AND 25.

CAPE MAY FOODS, INC., CAPE MAY, NJ:
2,571,039, PUB. 2-26-2002. INT. CL. 29.

CAPITAL DESIGN, INC., EAST PROVIDENCE, RI:
2,571,776, MULTIPLE CLASS, INT. CLS. 6, 9, 16 AND 28.

CAPITAL ONE FINANCIAL CORPORATION, FALLS CHURCH, VA:
2,572,257, INT. CL. 36.

CAPITOL MULTIMEDIA, INC., WASHINGTON, DC:
1,885,875, CANC. MULTIPLE CLASS, INT. CLS. 9, 28 AND 42.

CARA COSMETICS INTERNATIONAL, INC., WINTER PARK, FL:
2,570,846, PUB. 2-26-2002. INT. CL. 3.

CARDIAC PACEMAKERS, INC., ST. PAUL, MN:
1,638,988, CANC. INT. CL. 10.

CARDIOPET INCORPORATED, LITTLE FALLS, NJ, CARDIO PET, INC., BROOKLYN, NY:
1,195,416, REN. 4-10-02. INT. CL. 42.

CARDXPRESS VENDING, INC., EDISON, NJ:
1,885,891, CANC. INT. CL. 9.

CARECENTRIC NATIONAL, LLC, ATLANTA, GA:
2,571,424, PUB. 2-26-2002. INT. CL. 9.

CAREER GROUP, INC., LOS ANGELES, CA:
2,571,397, PUB. 2-26-2002. INT. CL. 35.

CAREER SYSTEMS INTERNATIONAL INC., SCRANTON, PA:
2,571,750, INT. CL. 41.

CARIBOU MOUNTAINEERING, INC., CHICO, CA:
1,149,954, CANC. INT. CL. 28.

CARLI GRY INTERNATIONAL A/S, 3480 FREDENSBORG, DENMARK:
1,886,126, CANC. INT. CL. 25.

CARLISLE MANAGEMENT COMPANY, SYRACUSE, NY:
1,639,179, CANC. INT. CL. 27.

CARLISLE MANAGEMENT COMPANY, SYRACUSE, NY:
2,570,978, PUB. 6-26-2001. INT. CL. 9.

CARLSON MARKETING GROUP, INC., MINNEAPOLIS, MN:
713,291, CANC. U.S. CL. 101.

CAROLINA SOY PRODUCTS, INC., WARSAW, NC:
2,572,368, INT. CL. 29.

CARPENTER CO., RICHMOND, VA:
1,886,076, CANC. INT. CL. 20.
1,886,182, CANC. INT. CL. 27.

CARPETEXPO, INC., FT. LAUDERDALE, FL:
1,487,919, CANC. INT. CL. 42.
2,071,186, CANC. INT. CL. 27.

CARRIAGE TRADE PUBLICATIONS II, INC., SAVANNAH, GA, DBA CARRIAGE TRADE PUBLIC RELATIONS, INC.:
2,571,541, PUB. 2-26-2002. INT. CL. 41.

CARTER, EARLEST, CHICAGO, IL, DBA ROUE AVANT:
1,886,188, CANC. INT. CL. 28.

CARTER, SHANNON, AUSTIN, TX:
1,846,930, CANC. INT. CL. 35.

CARTOON NETWORK LP, LLLP, THE, ATLANTA, GA:
2,572,134, INT. CL. 41.

CARUSO TELEVISION MARKETING, INC., LOS ANGELES, CA:
1,886,761, CANC. INT. CL. 3.

CASCADE BROADCASTING GROUP, L.L.C., BOISE, ID:
2,571,995, INT. CL. 38.

CASS INFORMATION SYSTEMS, INC., BRIDGETON, MO, CASS LOGISTICS INC., ST. LOUIS, MO:
1,694,059, REN. 4-12-02. MULTIPLE CLASS, INT. CLS. 9 AND 42.

CASTALDI, TINA, TOLUCA LAKE, CA:
2,571,578, PUB. 2-26-2002. INT. CL. 41.

CATAPULT COMMUNICATIONS CORPORATION, MOUNTAIN VIEW, CA:
2,571,829, INT. CL. 9.

CATLOW, INC., TIPP CITY, OH, CATLOW NOZZLES, INC., TIPP CITY, OH, AKA CATLOW FUELING NOZZLES INC.:
1,203,368, REN. 4-12-02. INT. CL. 6.

CAUDILL SEED COMPANY, LOUISVILLE, KY:
1,638,785, CANC. INT. CL. 1.

CB COMMERCIAL REAL ESTATE SERVICES GROUP, INC., LOS ANGELES, CA:
1,639,256, CANC. INT. CL. 36.

CBC (AMERICA) CORP., COMMACK, NY, CHUGAI BOYEKI (AMERICA) CORP., COMMACK, NY:
1,705,888, REN. 4-9-02. INT. CL. 27.
1,730,369, REN. 4-9-02. INT. CL. 27.

CCM COMMUNICATIONS INC., CAMARILLO, CA:
2,570,854, PUB. 2-26-2002. INT. CL. 16.

CEDAR WORKS, INC., THE, PEBBLES, OH:
1,639,367, CANC. INT. CL. 19.

CELEBRATION PAVILIONS, L.L.C., DAVIE, FL:
2,572,392, INT. CL. 42.

CELEBRITY CRUISES INC., MIAMI, FL:
2,571,470, PUB. 2-26-2002. INT. CL. 39.

CELEBRITY GOLF FOUNDATION, THE, HILTON HEAD ISLAND, SC:
1,724,350, REN. 4-12-02. INT. CL. 41.

CELLINO, INC., NEW YORK, NY:
1,645,161, REN. 4-8-02. INT. CL. 14.

CENDRES & METAUX SA, CH-2501 BIENNE, SWITZERLAND:
1,679,149, REN. 4-8-02. MULTIPLE CLASS, INT. CLS. 6 AND 10.

- CENTERCORE GROUP, INC., THE, ELKHART, IN, CENTERCORE, INC., PLAINFIELD, NJ:
1,675,112. REN. 4-10-02. INT. CL. 20.
- CENTERLINE, INC., POWELL, OH:
1,886,462. CANC. INT. CL. 42.
- CENTURION TECHNOLOGIES, INC., ST. LOUIS, MO:
2,570,522. PUB. 2-26-2002. INT. CL. 9.
- CERAMEM CORPORATION, WALTHAM, MA:
1,678,407. REN. 4-10-02. INT. CL. 11.
- CERTAINTEED CORPORATION, VALLEY FORGE, PA:
2,571,888. INT. CL. 2.
- CERVECERIA MODELO S.A. DE C.V., 11320 MEXICO, D.F., MEXICO:
1,681,366. REN. 4-6-02. INT. CL. 32.
- CES INC., SAN DIEGO, CA:
2,570,829. PUB. 2-26-2002. INT. CL. 42.
- CESARANI, SALVATORE J., NEW YORK, NY:
1,675,209. REN. 4-6-02. INT. CL. 25.
- CETRUS, INC., DANVILLE, CA:
2,571,240. PUB. 2-26-2002. INT. CL. 42.
- CH. HANSEN, INC., MILWAUKEE, WI, AMERICAN MOLLASSES CO., THE, NEW YORK, NY:
277,569. REN. 4-9-02. U.S. CL. 46 (INT. CL. 30).
- CHAMBERLAND, EUGENE G., BRANDON, VT:
2,571,830. INT. CL. 9.
- CHAMPION ROAD MACHINERY LIMITED, GODERICH, ONTARIO, CANADA:
1,149,606. CANC. INT. CL. 7.
- CHANCELLOR MEDIA CORPORATION OF MASSACHUSETTS, WALTHAM, MA:
2,570,573. PUB. 11-16-1999. INT. CL. 38.
- CHANG, HUEI MENG, MILPITAS, CA, DBA WISE ENTERPRISE:
1,675,864. REN. 4-9-02. INT. CL. 16.
- CHARLES & COLVARD, LTD., MORRISVILLE, NC FROM C3, INC., MORRISVILLE, NC, DBA CHARLES & COLVARD:
2,571,972. INT. CL. 35.
- CHARTER CAPITAL, INC. PLAINFIELD, IN:
2,572,369. INT. CL. 25.
- CHASE MEDICAL, LP, RICHARDSON, TX:
2,572,046. INT. CL. 10.
- CHASING ARROWS, INC., ST. LOUIS, MO:
2,571,968. MULTIPLE CLASS, INT. CLS. 1 AND 31.
2,571,989. MULTIPLE CLASS, INT. CLS. 1 AND 31.
- CHATEAU YALDARA PTY LIMITED, AUSTRALIA:
2,570,731. PUB. 11-7-2000. INT. CL. 33.
- CHAUVIN INTERNATIONAL LTD., LOS ANGELES, CA:
1,149,889. CANC. INT. CL. 25.
- CHEETAH LEARNING LLC, EAST HARTFORD, CT:
2,570,749. PUB. 9-11-2001. INT. CL. 35.
- CHEF AMERICA, INC., ENGLEWOOD, CO:
2,570,546. PUB. 5-4-1999. INT. CL. 30.
- CHEF'S GARDEN, INC., THE, HURON, OH:
2,571,195. PUB. 2-26-2002. MULTIPLE CLASS, INT. CLS. 31, 35 AND 42.
- CHEMALLOY COMPANY, INC., BRYN MAWR, PA:
1,683,531. REN. 4-12-02. INT. CL. 1.
- CHEMETALS INCORPORATED, BALTIMORE, MD:
1,885,736. CANC. INT. CL. 1.
- CHEMICAL & PIGMENT CO., PITTSBURG, CA:
1,149,533. CANC. INT. CL. 1.
- CHEMICAL DEVELOPMENT CORPORATION, DANVERS, MA TO ILLINOIS TOOL WORKS INC., GLENVIEW, IL:
693,707. CANC. U.S. CL. 14.
- CHEMICAL MANUFACTURERS ASSOCIATION, INC., WASHINGTON, DC:
1,886,464. CANC. INT. CL. 42.
- CHEMREX INC., NEW BERLIN, WI:
1,885,755. CANC. INT. CL. 2.
- CHERRY HILL CORPORATION, CHERRY HILL, NJ:
1,886,622. CANC. INT. CL. 20.
- CHESEBROUGH-POND'S INC., GREENWICH, CT:
386,158. CANC. U.S. CL. 51.
- CHESEBROUGH-POND'S INC., WILMINGTON, DE:
1,678,229. REN. 4-6-02. INT. CL. 3.
- CHICOPEE, INC., NORTH CHARLESTON, SC, JOHNSON & JOHNSON, NEW BRUNSWICK, NJ:
1,190,758. REN. 4-9-02. INT. CL. 24.
- CHILDERS PRODUCTS COMPANY, INC., EASTLAKE, OH:
1,149,540. CANC. INT. CL. 2.
- CHILDREN'S HEART FUND, MINNEAPOLIS, MN:
1,886,290. CANC. INT. CL. 36.
- CHIPPEWA PRODUCTS COMPANY, ST. LOUIS, MO:
732,618. REN. 4-10-02. U.S. CL. 6 (INT. CL. 5).
- CHISUM, F. LAVELL, CLAREMORE, OK:
1,885,847. CANC. INT. CL. 9.
- CHOCK FULL O'NUTS CORPORATION, NEW YORK, NY, CAIN'S COFFEE CO., OKLAHOMA CITY, OK:
725,429. REN. 4-9-02. U.S. CL. 46 (INT. CL. 30).
- CHOCOLATE RESEARCH & AMERICAN CULINARY HISTORY LIBRARY, LTD., CHICAGO, IL:
2,571,249. PUB. 2-26-2002. INT. CL. 41.
- CHRISTIAN UNIVERSITY GLOBALNET, ENGLEWOOD, CO:
2,572,138. INT. CL. 41.
- CHROMA CORPORATION, MCHENRY, IL:
2,570,525. PUB. 2-26-2002. INT. CL. 2.
- CHUNG, JAE BOCK, MADISON, WI:
2,572,326. INT. CL. 41.
- CHUNG, SANH, SAN FRANCISCO, CA, DBA VIET HUONG CO.:
1,712,007. REN. 4-12-02. INT. CL. 30.
- CHI COMMUNICATIONS INC., NEW YORK, NY:
2,572,205. INT. CL. 38.
- CIBA CORNING DIAGNOSTICS CORP., MEDFIELD, MA:
1,886,544. CANC. INT. CL. 9.
- CIBA-GEIGY CORPORATION, ARDSLEY, NY:
385,993. CANC. U.S. CL. 6.
- CIBC NATIONAL BANK, MAITLAND, FL:
2,572,076. INT. CL. 36.
- CIMARRON STEAK HOUSES, INC., OKLAHOMA CITY, OK:
2,571,383. PUB. 2-26-2002. INT. CL. 42.
2,571,384. PUB. 2-26-2002. INT. CL. 42.
- CINCA - COMPANHIA INDUSTRIAL DE CERAMICA, S.A., FIAES, FEIRA, PORTUGAL:
1,886,062. CANC. INT. CL. 19.
- CINCINNATI BENGALS, INC., CINCINNATI, OH:
2,571,694. INT. CL. 28.
2,571,695. INT. CL. 28.
- CISCO SALES CORPORATION, TORRANCE, CA:
2,570,682. PUB. 2-26-2002. INT. CL. 9.
- CITICORP, NEW YORK, NY:
2,571,874. INT. CL. 36.
- CITIZENS COMMUNICATIONS COMPANY, STANFORD, CT FROM GLOBAL CROSSING NORTH AMERICA, INC., ROCHESTER, NY:
2,572,139. INT. CL. 38.
- CITIZENS FINANCIAL GROUP, INC., PROVIDENCE, RI:
2,571,428. PUB. 2-26-2002. INT. CL. 36.
- CITY OF BEVERLY HILLS, THE, BEVERLY HILLS, CA:
2,571,244. PUB. 2-26-2002. INT. CL. 35.
- CITY OF GLENDALE, ARIZONA, GLENDALE, AZ:
2,571,492. PUB. 2-26-2002. INT. CL. 42.
- CITYFEET.COM, INC., ATLANTA, GA:
2,571,310. PUB. 2-26-2002. INT. CL. 36.
- CITYSCAPES, LLC, HUNTSVILLE, AL:
2,571,456. PUB. 2-26-2002. INT. CL. 37.
- CIVIC IMPORTS, INC., REGO PARK, NY:
1,886,645. CANC. INT. CL. 25.
- CLARK-CUTLER-MCDERMOTT CO., FRANKLIN, MA:
1,736,588. REN. 4-9-02. INT. CL. 19.
- CLARUS CORPORATION, SUWANEE, GA:
2,571,917. MULTIPLE CLASS, INT. CLS. 9 AND 41.
- CLASSNOTES INC., SACRAMENTO, CA:
2,572,058. INT. CL. 36.
- CLAYBORNE, SARAH, MEMPHIS, TN:
1,886,239. CANC. INT. CL. 30.
- CLEAN AMERICA, INC., BREA, CA:
2,572,203. MULTIPLE CLASS, INT. CLS. 7, 9 AND 17.
- CLEAR WITH COMPUTERS, INC., MANKATO, MN:
1,638,942. CANC. INT. CL. 9.

- CLEARCO PRODUCT LIMITED, WU KU HSIANG, TAIWAN:
2,571,505, PUB. 2-26-2002. INT. CL. 12.
- CLEARMARK, INC., SYRACUSE, NY:
2,571,842, INT. CL. 9.
- CLEM DEL, INC., WILMINGTON, DE:
2,535,320, COR. INT. CL. 35.
- CLEVELAND ZOOLOGICAL SOCIETY, CLEVELAND, OH:
1,886,298, CANC. INT. CL. 36.
- CLINTEC NUTRITION COMPANY, DEERFIELD, IL:
1,885,782, CANC. MULTIPLE CLASS, INT. CLS. 5, 9 AND 10.
- CLINTON COMPANY, CLINTON, IA:
386,154, CANC. U.S. CL. 6.
- CLOUGHERTY PACKING COMPANY, LOS ANGELES, CA:
2,571,136, PUB. 2-26-2002. INT. CL. 29.
- CLOVERBELT CREDIT UNION, WAUSAU, WI:
1,886,317, CANC. INT. CL. 36.
- CLUB LIBBY LU, LLC, CHICAGO, IL FROM DROLET, MARY, CHICAGO, IL:
2,571,942, MULTIPLE CLASS, INT. CLS. 3, 14, 18, 20, 24, 25 AND 26.
- CLUETT PEABODY RESOURCES CORPORATION, WILMINGTON, DE:
1,886,138, CANC. INT. CL. 25.
- CMP MEDIA INC.:
See—CMP MEDIA LLC.
- CMP MEDIA LLC, MANHASSET, NY FROM CMP MEDIA INC., MANHASSET, NY:
2,572,327, MULTIPLE CLASS, INT. CLS. 35 AND 41.
- CNA FINANCIAL CORPORATION, CHICAGO, IL:
2,570,787, PUB. 2-26-2002. INT. CL. 36.
2,571,100, PUB. 2-26-2002. INT. CL. 42.
- CNF, INC., MORGAN HILL, CA:
1,840,137, CANC. INT. CL. 9.
- COASTAL CORPORATION, THE, HOUSTON, TX:
1,639,275, CANC. INT. CL. 37.
- COBORN'S INCORPORATED, ST. CLOUD, MN:
1,735,058, REN. 4-10-02. INT. CL. 29.
- COCO RICO INC., SAN JUAN, PUERTO RICO:
540,398, REN. 4-12-02. U.S. CL. 45 (INT. CL. 32).
- COCOCARE PRODUCTS, INC., DOVER, NJ:
2,570,907, PUB. 2-26-2002. INT. CL. 3.
- COFFEEN, ERIC L., SAN DIEGO, CA, DBA COFE PRODUCTS:
2,572,353, INT. CL. 28.
- COGENTRIC, INC., WAKEFIELD, MA:
2,571,130, PUB. 8-14-2001. MULTIPLE CLASS, INT. CLS. 9 AND 42.
- COGNEX CORPORATION, NATICK, MA:
2,572,355, INT. CL. 9.
2,572,356, INT. CL. 9.
- COILTRONICS, INC., BOCA RATON, FL:
1,901,535, CANC. INT. CL. 9.
- COKER TIRE COMPANY, CHATTANOOGA, TN, UNIVERSAL TIRE COMPANY, LANCASTER, PA:
1,697,529, REN. 4-9-02. INT. CL. 12.
- COLD SPRINGS FARM LIMITED, THAMESFORD, ONTARIO, CANADA:
1,675,981, REN. 4-10-02. MULTIPLE CLASS, INT. CLS. 29 AND 31.
- COLDWATER CREEK INC., SANDPOINT, ID:
2,571,198, PUB. 2-26-2002. INT. CL. 25.
2,571,280, PUB. 10-30-2001. INT. CL. 35.
- COLEMAN COMPANY, INC., THE, WICHITA, KS:
1,886,633, CANC. INT. CL. 21.
- COLGATE-PALMOLIVE COMPANY, NEW YORK, NY:
140,748, CANC. U.S. CL. 6.
- COLLECTIONINDUSTRY.COM, LLC, BETHESDA, MD:
2,572,344, INT. CL. 35.
- COLLEGE PARK INDUSTRIES INC., FRASER, MI:
1,703,061, REN. 4-7-02. INT. CL. 10.
- COLLEGIATE TELEPHONES, INC., PEACHTREE CITY, GA:
1,885,871, CANC. INT. CL. 9.
- COLLINS, TITUS, CHICAGO, IL:
2,572,119, INT. CL. 16.
- COLLISION SHOP INC., THE, TROY, MI:
1,880,895, CANC. INT. CL. 37.
- COLONIAL SURGICAL SUPPLY, INC., LOS ANGELES, CA:
2,572,233, INT. CL. 10.
- COLOR DNA, GLENDALE, CA:
2,571,154, PUB. 2-26-2002. INT. CL. 1.
- COLOR MERCHANTS, INC., NEW YORK, NY:
2,570,817, PUB. 2-26-2002. INT. CL. 14.
- COLORADO CONTRACT CUT AND SEW INC., DENVER, CO:
1,676,851, REN. 4-10-02. INT. CL. 25.
- COLUMBIA FOOTWEAR CORPORATION, HAZLETON, PA:
1,886,646, CANC. INT. CL. 25.
- COMMERCE BANCORP, INC., CHERRY HILL, NJ:
2,570,816, PUB. 2-26-2002. INT. CL. 36.
- COMMERCEQUEST, INC., TAMPA, FL FROM TECHNOLOGY INVESTMENTS OF TAMPA BAY, INC., TAMPA, FL:
2,570,545, PUB. 9-25-2001. MULTIPLE CLASS, INT. CLS. 9 AND 42.
- COMMONWEALTH BRANDS, INC., BOWLING GREEN, KY:
1,667,805, AM. INT. CL. 34.
- COMMONWEALTH RISK SERVICES, INC., PHILADELPHIA, PA TO COMMONWEALTH RISK SERVICES, L.P., PHILADELPHIA, PA:
1,843,179, AM. INT. CL. 36.
- COMMUNICATION SOCIETY LLC, CARY, IL:
2,571,982, INT. CL. 35.
- COMMUNICATIONS PRODUCTS AND EQUIPMENT CO., LAWRENCEVILLE, IL:
1,638,950, CANC. INT. CL. 9.
- COMPASS MARKETING, INC., MINNEAPOLIS, MN:
2,572,274, INT. CL. 16.
- COMPOSITE TECHNOLOGY GROUP, LLC, SHEBOYGAN, WI:
2,571,299, PUB. 2-26-2002. INT. CL. 1.
- COMPTON, ROBERT C., KENOSHA, WI:
1,674,061, REN. 4-12-02. INT. CL. 9.
- COMPUNET CREDIT SERVICES, INC., LAKE HAVASU CITY, AZ:
2,571,164, PUB. 2-26-2002. INT. CL. 36.
- COMPUSERVE INCORPORATED, COLUMBUS, OH:
1,886,465, CANC. INT. CL. 42.
- COMPUTER PRODUCTS CENTER, INC., IRVINE, CA:
1,885,854, CANC. INT. CL. 9.
- COMPUTER SUPPORT SERVICES, INC., OMAHA, NE:
2,570,888, PUB. 2-26-2002. INT. CL. 42.
- CONAGRA, INC., OMAHA, NE, DBA COUNTRY GENERAL STORES:
1,885,926, CANC. INT. CL. 9.
1,885,927, CANC. INT. CL. 9.
- CONCEPT MIKE & LINDA TOTT INC., MORIN HEIGHTS, PROVINCE OF QUEBEC, CANADA:
1,685,490, REN. 4-8-02. INT. CL. 30.
- CONCEPT SYSTEMS INC., ALBANY, OR:
2,571,376, PUB. 2-26-2002. INT. CL. 9.
- CONCEPTUS, INC., FREMONT, CA:
1,881,376, CANC. INT. CL. 10.
- CONCERT CAPITAL MANAGEMENT, INC., BOSTON, MA:
1,886,291, CANC. INT. CL. 36.
- CONCORDIA UNIVERSITY, RIVER FOREST, IL:
2,571,055, PUB. 2-26-2002. INT. CL. 16.
- CONDEA SERVO, BV, 7491 AE DELDEN, NETHERLANDS, TENNECO CHEMICALS, INC., NEW YORK, NY:
941,200, REN. 4-6-02. U.S. CL. 6 (INT. CL. 1).
- CONFECTIONATELY YOURS, INC., MARIETTA, GA:
1,639,313, CANC. INT. CL. 42.
- CONFERENCE TECHNOLOGY GROUP LLC, PLAINVILLE, CT:
2,572,332, INT. CL. 9.
- CONFIDENT SOFTWARE, INC., TUCKER, GA:
1,683,627, REN. 4-11-02. INT. CL. 9.
- CONGRESSIONAL QUARTERLY, INC., WASHINGTON, DC:
2,571,379, PUB. 2-26-2002. INT. CL. 42.
- CONNECTIX CORPORATION, SAN MATEO, CA:
1,618,485, AM. INT. CL. 9.
- CONNER, ARTHUR RALPH, MOBILE, AL:
1,702,136, REN. 4-8-02. INT. CL. 37.

- CONNERS, DAVID C., SAN DIEGO, CA:
2,571,144, PUB. 2-26-2002. INT. CL. 41.
- CONQUIP, INC., LOVELAND, CO:
1,886,456, CANC. INT. CL. 42.
- CONSECO, INC., CARMEL, IN:
2,271,074, COR. INT. CL. 36.
- CONSIGNIA PLC., LONDON EC1V 9HQ, ENGLAND FROM
POST OFFICE, THE, LONDON, ENGLAND:
2,570,669, PUB. 5-1-2001. MULTIPLE CLASS, INT. CLS. 35
AND 39.
- CONSOLIDATED CIGAR CORPORATION, FT. LAUDER-
DALE, FL:
2,571,691, INT. CL. 34.
- CONSUMERS UNION OF UNITED STATES, INC., YON-
KERS, NY:
2,572,299, INT. CL. 16.
- CONTACT LENS DEPOT, INC., HERNDON, VA:
2,571,563, PUB. 2-26-2002. INT. CL. 35.
- CONTEX A/S, 3450 ALLEROD, DENMARK:
1,658,077, REN. 4-10-02. INT. CL. 9.
- CONTINENTAL DYNAMICS CORPORATION, PORT WA-
SHINGTON, NY TO CONTINENTAL DYNAMICS COR-
PORATION, PORT WASHINGTON, NY:
2,534,402, COR. INT. CL. 40.
- CONTINENTAL REPORTING SERVICE, INC., SEATTLE,
WA:
2,571,202, PUB. 2-26-2002. INT. CL. 42.
- CONTRACTOR MARKETPLACE, INC., LOUISVILLE, KY:
2,571,962, INT. CL. 35.
- CONTROL TECHNIQUES PLC, NEWTOWN, POWYS SY16
3AJ, UNITED KINGDOM:
1,885,858, CANC. INT. CL. 9.
- CONWEST RESOURCES INC., SAN FRANCISCO, CA:
2,571,214, PUB. 2-26-2002. INT. CL. 9.
- COOK COMMUNICATIONS MINISTRIES, COLORADO
SPRINGS, CO:
2,570,922, PUB. 2-26-2002. INT. CL. 16.
- COOKSON SINGAPORE PTE, LTD., SINGAPORE, TOLEDO
SYNTHETIC PRODUCTS, INC., TOLEDO, OH:
291,254, REN. 4-10-02. U.S. CL. 1 (INT. CL. 1).
- COOLEY DISTILLERY PLC, COUNTY LOUTH, IRELAND:
1,886,255, CANC. INT. CL. 33.
- COOPER BRANDS, INC., HOUSTON, TX, CAMPBELL
CHAIN COMPANY, YORK, PA:
729,883, REN. 4-9-02. U.S. CL. 13 (INT. CL. 6).
- COOPER CAMERON CORPORATION, HOUSTON, TX,
CAMERON IRON WORKS, INC., HOUSTON, TX:
717,737, REN. 4-9-02. U.S. CL. 13 (INT. CLS. 6 AND 9).
717,840, REN. 4-10-02. U.S. CL. 23 (INT. CL. 7).
- COOPER FIREARMS, INC., STEVENSVILLE, MT:
1,885,968, CANC. INT. CL. 13.
- COOPERATIVE COMPUTING, INC., AUSTIN, TX:
2,570,701, PUB. 2-26-2002. INT. CL. 9.
- COPPLEY, NOYES AND RANDALL LIMITED, THE, HA-
MILTON, ONTARIO, CANADA:
1,886,104, CANC. INT. CL. 25.
- COPPOLA, FRANK, PALM HARBOR, FL:
1,886,348, CANC. INT. CL. 40.
- CORE-MARK INTERNATIONAL, INC., SOUTH SAN FRAN-
CISCO, CA, CABLE CAR CANDY CO., LONG BEACH, CA:
929,258, REN. 4-10-02. U.S. CL. 46 (INT. CLS. 29, 30 AND
31).
- CORIOLIS GROUP, L.L.C., THE, SCOTTSDALE, AZ:
2,571,032, PUB. 2-26-2002. INT. CL. 9.
- CORNING CABLE SYSTEMS BRANDS, INC., WILMING-
TON, DE, SIECOR CORPORATION, HICKORY, NC:
1,628,792, REN. 4-10-02. INT. CL. 9.
- CORPAK, INC., WHEELING, IL:
1,675,547, REN. 4-6-02. INT. CL. 10.
- CORPORATION 2000, INC., PISCATAWAY, NJ:
2,571,337, PUB. 2-26-2002. INT. CL. 9.
- CORRAL WEST RANCHWEAR, INC., CHEYENNE, WY:
2,570,935, PUB. 2-26-2002. INT. CL. 35.
- CORRUGATED TECHNOLOGIES, INC., SAN DIEGO, CA:
1,557,681, AM. INT. CL. 9.
1,587,593, AM. INT. CL. 9.
1,692,705, AM. INT. CL. 9.
2,190,904, AM. INT. CL. 9.
- CORSHE KNITS, INC., NEW YORK, NY:
1,639,166, CANC. INT. CL. 25.
- CORSINI, FRANK A., TIBURON, CA:
1,886,692, CANC. INT. CL. 32.
- COSMAIR CREATIVE, INC., NEW YORK, NY FROM
COSMAIR CREATIVE, INC., NEW YORK, NY:
2,571,845, INT. CL. 3.
- COSMO COSMETICS, INC., LOS ANGELES, CA:
1,885,772, CANC. INT. CL. 3.
- COTTAGE CRAFTS, INC., NEW YORK, NY:
2,571,926, INT. CL. 25.
- COTTON MOVING AND STORAGE, INC., HOUSTON, TX:
2,570,811, PUB. 4-10-2001. INT. CL. 39.
- COUNTRY GARDENS, INC., DANBURY, CT:
2,570,513, PUB. 2-26-2002. MULTIPLE CLASS, INT. CLS.
35 AND 42.
- COUNTRY PEDDLERS AND COMPANY OF AMERICA,
INC., THE, ALSIP, IL:
2,571,075, PUB. 2-26-2002. INT. CL. 35.
- COUNTY SADDLERY, INC., WOODBINE, MD:
1,886,052, CANC. INT. CL. 18.
- COURIER COOL LIMITED, SPEEN, UNITED KINGDOM:
2,571,978, INT. CL. 20.
- COUSIN CORPORATION OF AMERICA, LARGO, FL:
2,571,641, PUB. 2-26-2002. INT. CL. 14.
- COVEY LEADERSHIP CENTER, PROVO, UT TO FRANK-
LIN COVEY CO., SALT LAKE CITY, UT:
1,882,001, CANC. INT. CL. 9.
- COZMO WHEEL COMPANY PTY LIMITED, NEW SOUTH
WALES 2094, AUSTRALIA:
2,571,446, PUB. 2-26-2002. INT. CL. 28.
- CPELITE, INC., CHAPIN, SC:
1,639,087, CANC. INT. CL. 16.
- CPI CHURCH STREET, INC., BALTIMORE, MD:
1,639,289, CANC. MULTIPLE CLASS, INT. CLS. 41 AND
42.
- CPI HOLDING S.A., CH-1701 FRIBOURG, SWITZERLAND:
1,885,890, CANC. INT. CL. 9.
- CPN INTERNATIONAL, INC., MARTINEZ, CA, CPN CORP.,
MARTINEZ, CA, DBA CAMPBELL PACIFIC NUCLEAR:
1,206,020, REN. 4-11-02. INT. CL. 9.
- CPT HOLDINGS, INC., CULVER CITY, CA:
1,677,114, REN. 4-9-02. INT. CL. 41.
- CPTO INDUSTRIES, INC., NEW YORK, NY:
1,886,164, CANC. INT. CL. 25.
- CRABTREE & EVELYN, LTD., WOODSTOCK, CT:
2,572,204, MULTIPLE CLASS, INT. CLS. 3, 4 AND 16.
- CRAFT EXPRESS, INC., FAIRFAX, VA, ASHLAND
CRAFTS, INC., FAIRFAX, VA:
1,681,644, REN. 4-12-02. INT. CL. 42.
1,702,649, REN. 4-12-02. INT. CL. 42.
- CRAWFORD, DAVID, CENTRE, AL, DBA MODEL TEES:
2,571,405, PUB. 2-26-2002. INT. CL. 25.
- CRE MANAGEMENT, LC, SALT LAKE CITY, UT, DBA
MILOSPORT:
2,570,668, PUB. 2-26-2002. INT. CL. 28.
- CREANOVA INC., PARSIPPANY, NJ, HULS AMERICA
INC., PISCATAWAY, NJ:
1,676,474, REN. 4-10-02. INT. CL. 2.
- CREATIVE CONCEPTS OF CHARLOTTE, INC., CHAR-
LOTTE, NC:
2,571,851, INT. CL. 35.
- CREST APPAREL CO. INC., NEW YORK, NY:
1,149,882, CANC. INT. CL. 25.
- CRESTAR FINANCIAL CORPORATION, RICHMOND, VA:
1,886,707, CANC. INT. CL. 36.
- CREW WORKS, INC., THE, BALTIMORE, MD:
2,570,993, PUB. 2-26-2002. INT. CL. 37.
2,570,994, PUB. 2-26-2002. INT. CL. 37.
- CRI INTERNATIONAL, INC., HOUSTON, TX:
1,873,410, CANC. INT. CL. 40.
- CROSSGENERATION COMICS, INC., OLDSMAR, FL:
2,572,171, INT. CL. 16.
- CROTIX, ETNA, NH:
2,571,605, PUB. 2-26-2002. INT. CL. 36.
- CRY OF THE EAGLE MINISTRIES, THE, BROKEN AR-
ROW, OK:
1,886,440, CANC. INT. CL. 42.

- CTI AND ASSOCIATES, INCORPORATED, BRIGHTON, MI:
1,860,094, CANC. INT. CL. 42.
- CTI2 LTD., HERZLIYA PITUACH 46733, ISRAEL:
2,571,722, INT. CL. 9.
- CUIRCO DIFFUSION, 75003 PARIS, FRANCE:
2,570,483, PUB. 3-17-1998. MULTIPLE CLASS, INT. CLS.
18 AND 25.
- CUIRCO DIFFUSION, 77290 MITRY MORY, FRANCE:
2,570,677, PUB. 2-20-2001. MULTIPLE CLASS, INT. CLS.
18 AND 25.
- CULLIGAN INTERNATIONAL COMPANY, NORTH-
BROOK, IL:
1,659,645, REN. 4-8-02. INT. CL. 11.
- CURECRETE CHEMICAL CO., INC., SPRINGVILLE, UT:
2,571,281, PUB. 2-26-2002. INT. CL. 37.
- CURTICE-BURNS, INC., ROCHESTER, NY:
385,986, CANC. U.S. CL. 46.
- CUSTOM BUILDING PRODUCTS, SEAL BEACH, CA, B & P
CUSTOM BUILDING PRODUCTS, INC., BELL, CA, DBA
CUSTOM BUILDING PRODUCTS:
1,685,871, REN. 4-6-02. MULTIPLE CLASS, INT. CLS. 1, 3,
17 AND 19.
- CUSTOM LEATHERCRAFT MANUFACTURING CO. INC.,
LOS ANGELES, CA TO PRO GROUP, INC., ENGLE-
WOOD, CO:
1,686,128, CANC. INT. CL. 9.
- CUSTOM ROTO-MOLD, INC., BENSON, MN:
2,483,534, COR. INT. CL. 20.
- CYBER-CLENZ, L.L.C., HICKSVILLE, NY:
2,570,982, PUB. 2-26-2002. MULTIPLE CLASS, INT. CLS. 5
AND 21.
- CYBERSHIELD INTERNATIONAL, INC., DALLAS, TX:
2,571,891, MULTIPLE CLASS, INT. CLS. 40 AND 42.
- CYLIX COMMUNICATIONS CORPORATION, MEMPHIS,
TN:
1,886,401, CANC. INT. CL. 42.
- CYPRESS POINT CLUB, PEBBLE BEACH, CA:
2,571,482, PUB. 2-26-2002. MULTIPLE CLASS, INT. CLS.
25 AND 41.
- CYTOLOGIX CORPORATION, CAMBRIDGE, MA:
2,571,861, INT. CL. 10.
- D & D BEAUTY DISTRIBUTORS, INC., DARLINGTON, SC:
2,570,828, PUB. 2-26-2002. INT. CL. 3.
- D. JOE FREED, WICHITA, KS, DBA THIEF OF HEARTS:
1,886,460, CANC. INT. CL. 42.
- D&D GAMING PATENTS, INC., FORT LAUDERDALE, FL
TO D&D GAMING PATENTS, INC., FORT LAUDER-
DALE, FL:
1,863,337, CANC. INT. CL. 41.
- D'ARRIGO MODA ITALIA SRL, 32040 LORENZAGO DI
CADORE (BL), ITALY:
1,885,857, CANC. INT. CL. 9.
- DA VIA' LUIGI S.R.L., FRAZIONE TAI (BELLUNO), ITALY:
2,495,417, COR. INT. CL. 9.
- DAC N SAC INC., CAMPBELL, CA, DBA MADE IN JAPAN:
1,678,819, REN. 4-6-02. INT. CL. 37.
- DAIRY ASSOCIATION COMPANY, INC., LYNDONVILLE,
VT:
738,733, REN. 4-10-02. U.S. CL. 44 (INT. CL. 10).
- DAIWA GOLF CO., LTD., HIGASHIKURUME-CITY, TO-
KYO, JAPAN:
1,639,184, CANC. INT. CL. 28.
- DALEEN TECHNOLOGIES, INC., BOCA RATON, FL:
2,571,368, PUB. 2-26-2002. INT. CL. 42.
- DAMON INDUSTRIES, INC., ALLIANCE, OH, DAMON
CHEMICAL COMPANY, INC., ALLIANCE, OH:
717,677, REN. 4-9-02. U.S. CL. 52 (INT. CL. 3).
- DAN RIVER INC., DANVILLE, VA:
713,241, CANC. U.S. CL. 42.
2,571,912, INT. CL. 24.
- DANA CORPORATION, TOLEDO, OH, WEATHERHEAD
COMPANY, THE, CLEVELAND, OH:
727,456, REN. 4-11-02. U.S. CL. 23 (INT. CL. 7).
- DANA INNOVATIONS, SAN CLEMENTE, CA:
2,571,869, INT. CL. 9.
- DANCEMASTERS DISC JOCKEY ENTERTAINERS, LLC,
OSSINING, NY:
2,572,414, INT. CL. 9.
- DANIEL GREEN COMPANY, OLD TOWNE, ME:
727,538, REN. 4-11-02. U.S. CL. 39 (INT. CL. 25).
- DANTE PRINI, S.R.L., LUCINO (COMO), ITALY:
1,886,101, CANC. INT. CL. 24.
- DARDEN, KAREN M., TRINIDAD, CA AND PARKINSON,
GABRIELLE, BAYSIDE, CA:
2,571,592, PUB. 2-26-2002. INT. CL. 41.
- DART DRUG CORPORATION, LANDOVER, MD:
713,294, CANC. U.S. CL. 101.
- DARYL THOMPSON ENTERPRISES, INC., MANDEVILLE,
LA:
1,886,747, CANC. INT. CL. 42.
- DASHAMERICA, INC., BROOMFIELD, CO:
2,572,129, INT. CL. 25.
- DATATRAC INFORMATION SERVICES, INC., RICHARD-
SON, TX:
2,446,088, AM. MULTIPLE CLASS, INT. CLS. 35, 37, 41
AND 42.
- DATAVOX BUSINESS COMMUNICATIONS, HOUSTON,
TX:
2,571,341, PUB. 2-26-2002. INT. CL. 41.
- DAWN HOLDINGS, INC., JACKSON, MI:
1,682,162, REN. 4-6-02. INT. CL. 30.
- DAWSON HOME FASHIONS, INC., NEW YORK, NY:
1,886,755, CANC. MULTIPLE CLASS, INT. CLS. 6, 14, 20,
21, 24 AND 27.
- DAY INTERNATIONAL, INC., CLEVELAND, OH:
1,886,517, CANC. INT. CL. 7.
- DAY; FRANK B., BOULDER, CO TO ROCK BOTTOM
RESTAURANTS, INC., LOUISVILLE, CO:
1,190,244, CANC. INT. CL. 41.
- DAY-GLO COLOR CORP., CLEVELAND, OH:
1,691,075, REN. 4-7-02. INT. CL. 2.
- DAYCO PRODUCTS, LLC, DAYTON, OH:
2,571,627, PUB. 2-26-2002. INT. CL. 12.
- DDC DATA DEVICE CORPORATION, BOHEMIA, NY
FROM ILC DATA DEVICE CORPORATION, LONG
ISLAND, NY:
2,571,819, INT. CL. 9.
- DEAD ON TOOLS L.L.C., TORRANCE, CA:
2,571,158, PUB. 2-26-2002. INT. CL. 28.
- DEB SBS INC., STANLEY, NC:
2,572,042, MULTIPLE CLASS, INT. CLS. 3, 5 AND 21.
- DEBRA C. JAMES & STANLEY W. EPSTEIN, P. A., WELL-
INGTON, FL:
2,570,794, PUB. 2-26-2002. INT. CL. 36.
- DEC INTERNATIONAL, INC., MADISON, WI:
2,570,954, PUB. 2-26-2002. MULTIPLE CLASS, INT. CLS.
3, 4, 5, 6, 7, 8, 9, 11, 17, 20 AND 21.
- DECATHLON, 5965 VILLENEUVE D'ASCO, FRANCE:
2,570,547, PUB. 1-25-2000. MULTIPLE CLASS, INT. CLS.
9, 18, 25, 28, 38 AND 41.
- DECISION ANALYST, INC., ARLINGTON, TX:
2,572,402, INT. CL. 35.
2,572,403, INT. CL. 35.
2,572,404, INT. CL. 35.
- DECISION FOCUS, INC., LOS ALTOS, CA:
1,639,085, CANC. INT. CL. 16.
- DECK AMERICA, INC., WOODBRIDGE, VA:
2,570,923, PUB. 2-26-2002. INT. CL. 42.
2,570,924, PUB. 2-26-2002. INT. CL. 42.
- DECON LABORATORIES, INC., BRYN MAWR, PA:
2,570,581, PUB. 2-26-2002. INT. CL. 3.
- DEERE & COMPANY, MOLINE, IL:
1,149,613, CANC. INT. CL. 7.
- DEFLECTO CORPORATION, INDIANAPOLIS, IN:
1,149,710, CANC. INT. CL. 11.
- DEGUSSA AG, D-40474 DUSSELDORF, FED REP GER-
MANY, DYNAMIT NOBEL AKTIENGESELLSCHAFT,
521 TROISDORF, FED REP GERMANY:
935,518, REN. 4-8-02. U.S. CL. 1 (INT. CL. 1).
943,511, REN. 4-8-02. U.S. CL. 6 (INT. CL. 1).
- DEGUSSA HEALTH & NUTRITION AMERICAS, INC.,
BEACHWOOD, OH, NOPCO CHEMICAL COMPANY,
HARRISON, NJ:
554,721, REN. 4-10-02. U.S. CL. 18 (INT. CL. 5).
- DEJA BLEU, LLC, NEW YORK, NY:
2,572,244, INT. CL. 25.

- DEJAY CORPORATION, GREENEVILLE, TN TO KAZ, INC., NEW YORK, NY:
1,857,221, CANC. INT. CL. 9.
- DEL RANCHO USA, INC., OKLAHOMA CITY, OK, HOLT; J. R., OKLAHOMA CITY, OK, DBA DEL RANCHO:
1,190,330, REN. 4-6-02. INT. CL. 42.
- DELAWARE CAPITAL FORMATION, INC., WILMINGTON, DE, BLACKMER PUMP COMPANY, GRAND RAPIDS, MI:
734,878, REN. 4-10-02. U.S. CL. 23 (INT. CL. 7).
- DELAWARE CAPITAL FORMATION, INC., WILMINGTON, DE:
2,571,413, PUB. 2-26-2002. INT. CL. 22.
2,571,852, INT. CL. 9.
2,572,078, INT. CL. 9.
- DELAWARE CORPORATIONS LLC, WILMINGTON, DE:
2,572,307, INT. CL. 35.
- DELFIELD COMPANY, THE, MOUNT PLEASANT, MI:
2,571,233, PUB. 2-26-2002. INT. CL. 11.
- DELOMBARD, ANDRE J., JACKSON, MI, DBA CHECK SIX:
1,886,652, CANC. INT. CL. 25.
- DELSYS INCORPORATED, BOSTON, MA:
2,570,590, PUB. 5-8-2001. INT. CL. 10.
- DELTA/TRIMAX CORP., JANESVILLE, WI:
1,639,193, CANC. INT. CL. 28.
- DELTANET TECHNOLOGY, INC., ATLANTA, GA:
1,885,865, CANC. INT. CL. 9.
- DEMEESTER, JACQUES, CROISSY SUR SEINE, FRANCE:
1,638,907, CANC. INT. CL. 8.
- DENTAL LEARNING SYSTEMS CO., INC., JAMESBURG, NJ:
2,570,991, PUB. 2-26-2002. INT. CL. 16.
- DENTAL RESOURCE ALLIANCE, INC., CLAYTON, MO:
2,570,874, PUB. 2-26-2002. INT. CL. 42.
- DENTCO, INC., HUMACAO, PUERTO RICO:
2,571,321, PUB. 2-26-2002. INT. CL. 3.
- DENTSPLY INTERNATIONAL INC., YORK, PA:
2,572,039, INT. CL. 5.
- DERMABLEND, INC., A DIVISION OF CARSON PRODUCTS COMPANY:
See—SOFT SHEEN/CARSON INC.
- DERMATRACK, INC., LOS ANGELES, CA:
1,150,095, CANC. INT. CL. 42.
- DEROYAL INDUSTRIES, INC., POWELL, TN:
2,572,142, INT. CL. 10.
- DESERT TROON LIMITED, L.L.C., SCOTTSDALE, AZ:
2,571,886, INT. CL. 28.
- DESIGN SEARCH, INC., NEW YORK, NY:
1,886,137, CANC. INT. CL. 25.
- DESIGN-A-DAY, INC., MORGANVILLE, NJ:
1,886,611, CANC. INT. CL. 16.
- DESLEE, NAAMLOZE VENNOOTSCHAP, VICHTE, BELGIUM:
2,571,612, PUB. 2-26-2002. INT. CL. 24.
- DEUTSCHENDORF, HENRY J., ASPEN, CO, AKA JOHN DENVER:
1,886,387, CANC. INT. CL. 41.
- DEVICECAST, INC., WESTLAKE, OH:
2,570,778, PUB. 2-26-2002. INT. CL. 38.
- DFS GROUP L.P., SAN FRANCISCO, CA:
1,639,221, CANC. INT. CL. 30.
- DHX, INC., RANCHO DOMINGUEZ, CA:
2,570,901, PUB. 2-26-2002. INT. CL. 39.
- DI CRISTOFALO S.P.A., PALERMO, ITALY:
1,639,028, CANC. INT. CL. 14.
- DIAMOND SHAMROCK CORPORATION, DALLAS, TX:
713,003, CANC. U.S. CL. 6.
- DIAMOND-U PRODUCTS, INC., LONG BEACH, CA:
1,885,801, CANC. INT. CL. 6.
- DIAMONDSALE.COM, ORLANDO, FL:
2,572,313, INT. CL. 35.
- DIANAMIC ABRASIVE PRODUCTS, TROY, MI:
1,627,653, REN. 4-8-02. INT. CL. 40.
- DICK CLARK PRODUCTIONS, INC., BURBANK, CA:
2,571,783, MULTIPLE CLASS, INT. CLS. 41 AND 42.
- DIE-CUT PRODUCTS CO., CLEVELAND, OH:
1,886,754, CANC. MULTIPLE CLASS, INT. CLS. 6 AND 20.
- DIGITAL HAIKU, WEST HOLLYWOOD, CA:
2,572,206, INT. CL. 42.
- DIMARZIO, INC., STATEN ISLAND, NY:
1,674,915, REN. 4-6-02. INT. CL. 9.
- DINO LIFT OY, FIN-32210 LOIMAA, FINLAND:
2,432,495, COR. INT. CL. 7.
- DIPIERO, BOB, NASHVILLE, TN:
2,570,905, PUB. 2-26-2002. MULTIPLE CLASS, INT. CLS. 9, 28 AND 41.
2,570,906, PUB. 2-26-2002. MULTIPLE CLASS, INT. CLS. 9, 28 AND 41.
- DIRACHI, INC., LOS ANGELES, CA:
2,571,422, PUB. 2-26-2002. INT. CL. 14.
- DIRECT TO RETAIL, INC., NATICK, MA:
1,886,267, CANC. INT. CL. 35.
- DIRT ROAD PRODUCTIONS, INC., CLOVIS, CA:
2,570,862, PUB. 2-26-2002. INT. CL. 41.
- DISCOVERY COMMUNICATIONS, INC., BETHESDA, MD, DBA DISCOVERY CHANNEL:
2,571,705, MULTIPLE CLASS, INT. CLS. 9, 16, 18 AND 25.
- DISCOVERY COMMUNICATIONS, INC., BETHESDA, MD:
2,571,812, INT. CL. 41.
- DISCOVERY COMMUNICATIONS, INC., BETHESDA, MD, DBA THE DISCOVERY CHANNEL:
2,572,033, INT. CL. 9.
- DISCOVERY ZONE, INC., KANSAS CITY, MO TO DISCOVERY ZONE L.P., KANSAS CITY, MO:
1,639,186, CANC. INT. CL. 28.
1,639,187, CANC. INT. CL. 28.
- DISCUS DENTAL IMPRESSIONS, INC., CULVER CITY, CA:
2,570,658, PUB. 2-26-2002. INT. CL. 9.
- DISNEY ENTERPRISES, INC., BURBANK, CA:
2,572,083, INT. CL. 29.
- DISTRIBUCIONES HERMECO LTDA., MEDELLIN, COLOMBIA:
1,886,641, CANC. INT. CL. 25.
- DIVERSEY CORP., LIVONIA, MI:
1,885,877, CANC. INT. CL. 9.
- DIVERSIFIED INNOVATIONS, HADDONFIELD, NJ:
2,572,148, INT. CL. 35.
- DIZOGLIO, FRANK P. III, JAMESTOWN, RI:
2,572,394, INT. CL. 33.
- DLJ LONG TERM INVESTMENT CORPORATION, CHICAGO, IL:
2,571,322, PUB. 2-26-2002. INT. CL. 16.
- DOCUWARE VERLAG UND DOKUMENTATIONSSERVICE GMBH, D-64295 DARMSTADT, FED REP GERMANY TO SCHULER, BERND, D-35708 HAIGER, FED REP GERMANY:
2,176,001, AM. MULTIPLE CLASS, INT. CLS. 16 AND 42.
- DODO CORP., SEOUL, REPUBLIC OF KOREA:
2,570,861, PUB. 10-23-2001. INT. CL. 3.
- DOGMEISTERS LTD., MATTESON, IL:
1,886,741, CANC. INT. CL. 42.
- DOHRING, RAHN, ORION, MI:
2,570,654, PUB. 2-27-2001. INT. CL. 42.
- DOLLAR RENT A CAR SYSTEMS, INC., TULSA, OK, DOLLAR-A-DAY RENT-A-CAR SYSTEMS, INC., LOS ANGELES, CA:
948,360, REN. 4-9-02. U.S. CL. 100 (INT. CL. 39).
- DOMAINE BOYAR AD, BG-2230 KOSTINBROD, BULGARIA:
2,570,634, PUB. 9-12-2000. INT. CL. 33.
- DONAHOE & PUROHIT, INC., CHICAGO, IL:
2,572,280, INT. CL. 41.
- DOREL JUVENILE GROUP, INC., CANTON, MA FROM COSCO, INC., COLUMBUS, IN:
2,572,007, INT. CL. 20.
- DOTCOM MARKETING, INC., CHICAGO, IL:
2,571,493, PUB. 2-26-2002. INT. CL. 42.
- DOUBLETWIST, INC., OAKLAND, CA:
2,571,179, PUB. 2-26-2002. INT. CL. 42.
2,571,180, PUB. 2-26-2002. INT. CL. 42.
- DOUGLAS MANUFACTURING COMPANY, PELL CITY, AL:
2,572,312, INT. CL. 7.
- DOUGLAS, CHRISTOPHER J., CULVER CITY, CA:
2,572,105, INT. CL. 9.

DOUGLASS, WILLIAM F., GLOUCESTER POINT, VA:
1,639,197, CANC. INT. CL. 28.

DOUWE EGBERTS VAN NELLE TABAKSMAATSCHAPPIJ B.V., 3044 BC ROTTERDAM, NETHERLANDS:
1,886,681, CANC. INT. CL. 30.

DOW CONSUMER PRODUCTS INC., GREENVILLE, SC:
1,149,559, CANC. INT. CL. 3.

DOW JONES & COMPANY, INC., NEW YORK, NY:
1,886,788, CANC. INT. CL. 16.

DOWLING, WILLIAM P., SAVANNAH, GA:
2,571,245, PUB. 2-26-2002. INT. CL. 16.

DPW PUBLISHING, INC., MINNEAPOLIS, MN:
1,639,421, CANC. INT. CL. 16.

DR. PEPPER/SEVEN UP, INC., PLANO, TX, RADCLIFF; WILL, CINCINNATI, OH, DBA THE RADCLIFF CO.:
1,157,938. REN. 4-11-02. MULTIPLE CLASS, INT. CLS. 11, 16, 29, 30 AND 31.

DRAZGA, EDWARD A., CHERRY HILL, NJ:
2,571,302, PUB. 2-26-2002. MULTIPLE CLASS, INT. CLS. 3 AND 17.

DRIVERS4HIRE.COM, LLC, COTTAGE GROVE, MN:
2,572,336, INT. CL. 35.

DRUKIN, MEL, GLEN MILLS, PA:
1,675,493. REN. 4-6-02. INT. CL. 42.

DRUMMERS COLLECTIVE, INC., NEW YORK, NY:
1,886,392, CANC. INT. CL. 41.

DSI TOYS, INC., HOUSTON, TX:
2,571,958, INT. CL. 28.

DUCLAW BREWERY, LLC, TOWSON, MD:
2,571,432, PUB. 2-26-2002. INT. CL. 32.
2,571,433, PUB. 2-26-2002. INT. CL. 32.
2,571,434, PUB. 2-26-2002. INT. CL. 32.
2,571,435, PUB. 2-26-2002. INT. CL. 32.

DUCON CORPORATION, NAPERVILLE, IL:
1,885,768, CANC. MULTIPLE CLASS, INT. CLS. 3 AND 4.

DULCES LA FRESA, S.A. DE C.V., TLAJOMULCO DE ZUNIGA, JALISCO, MEXICO:
1,876,049, CANC. INT. CL. 30.

DUN & BRADSTREET HEALTHCARE INFORMATION, INC., PRINCETON, NJ:
1,886,749, CANC. INT. CL. 42.

DUNBARTON CORPORATION, DOTHAN, AL:
2,571,354, PUB. 2-26-2002. INT. CL. 6.

DUQUESNE LIGHT COMPANY, PITTSBURGH, PA:
2,571,831, INT. CL. 35.

DURIRON COMPANY, INC., THE, DAYTON, OH:
713,111, CANC. U.S. CL. 23.

DURON, INC., BELTSVILLE, MD:
1,726,603. REN. 4-9-02. INT. CL. 2.

DUTTON-LAINSON COMPANY, HASTINGS, NE:
1,693,970. REN. 4-12-02. MULTIPLE CLASS, INT. CLS. 6, 7, 8, 9 AND 12.

DYNACCO, INC., MONROE, WA:
2,571,881, INT. CL. 21.

DYNAMESH INC., WEST CHICAGO, IL:
1,681,257. REN. 4-12-02. INT. CL. 24.

DYNAMIC CAPITAL MANAGEMENT, INC., ANCHORAGE, AK:
2,572,295, INT. CL. 36.

DYNAMIC TECHNOLOGIES, INC., BURTONSVILLE, MD, DBA OCEAN SYSTEMS:
2,571,994, INT. CL. 9.

DYNAPRO PRODUCTS, INC., NORTHBROOK, IL TO DOUBLE EAGLE GOLF COMPANY, WILMETTE, IL, DBA DYNAPRO GOLF:
1,639,159, CANC. MULTIPLE CLASS, INT. CLS. 25 AND 28.

D2 RESTAURANT SYSTEMS, LLC, ROCHESTER, NY:
2,571,265, PUB. 2-26-2002. INT. CL. 42.

E. & J. GALLO WINERY, MODESTO, CA:
2,457,909, AM. INT. CL. 33.

E. I. DU PONT DE NEMOURS AND COMPANY, WILMINGTON, DE:
1,886,751, CANC. U.S. CL. A.

E. VOGEL, INC., NEW YORK, NY:
1,886,161, CANC. INT. CL. 25.

E. W. BLISS COMPANY, INC., HASTINGS, MI:
1,149,629, CANC. INT. CL. 7.

E.D. PUBLICATIONS, INC., CLEARWATER, FL:
1,678,514. REN. 4-11-02. INT. CL. 16.

E.F. JOHNSON COMPANY, BURNSVILLE, MN:
1,886,586, CANC. INT. CL. 9.

E.R. SQUIBB & SONS, L.L.C., PRINCETON, NJ, OLIN MATHIESON CHEMICAL CORPORATION, NEW YORK, NY:
728,191. REN. 4-9-02. U.S. CL. 18 (INT. CL. 5).

E.S. ORIGINALS, INC., NEW YORK, NY:
1,886,661, CANC. INT. CL. 25.

E-NICIAL VENTURES ADVISORS LLC, NEW YORK, NY FROM CONEXION CAPITAL ADVISORS LLC, NEW YORK, NY:
2,572,043, INT. CL. 36.

E-VISORS, INC., NEW YORK, NY:
2,571,583, PUB. 11-27-2001. INT. CL. 35.

E-Z LEGAL FORMS, INC., DEERFIELD BEACH, FL:
1,886,776, CANC. INT. CL. 9.

E'OLA INTERNATIONAL, ST. GEORGE, UT:
2,571,847, INT. CL. 5.

EAGLE ENGINEERING AEROSPACE CO., LTD., TOKYO, JAPAN:
2,572,127, INT. CL. 6.

EAGLEROCK CAPITAL MANAGEMENT, LLC, NEW YORK, NY:
2,571,408, PUB. 2-26-2002. INT. CL. 36.

EARLE, EYVIND A., CARMEL, CA:
2,570,662, PUB. 2-26-2002. INT. CL. 16.

EAST BALT. INC., CHICAGO, IL:
1,681,355. REN. 4-10-02. INT. CL. 30.
1,697,854. REN. 4-10-02. INT. CL. 30.

EASTWOOD INSURANCE SERVICES, INC., ANAHEIM HILLS, CA:
2,571,649, PUB. 2-26-2002. INT. CL. 36.

EASY FLOAT PRODUCTS, INC., TAMPA, FL:
1,149,828, CANC. INT. CL. 19.

EASY WAY INTERNATIONAL, INC., INDIANAPOLIS, IN:
2,572,079, INT. CL. 5.

EASYCO L.L.C., GLENOLDEN, PA FROM REPTON DATA, INC., SPRINGFIELD, PA:
2,571,866, INT. CL. 42.

EATON CORPORATION, CLEVELAND, OH:
713,020, CANC. U.S. CL. 13.
713,125, CANC. U.S. CL. 23.

EBEJER, BRIAN, NEW YORK, NY AND EBEJER, ERIKH, NEW YORK, NY:
2,572,293, INT. CL. 25.

EBEL, BRANDON, SEATTLE, WA:
2,571,947, MULTIPLE CLASS, INT. CLS. 9 AND 25.

EBRARY.COM, SUNNYVALE, CA:
2,570,625, PUB. 2-26-2002. INT. CL. 42.

EBSCO INDUSTRIES, INC., BIRMINGHAM, AL:
2,570,500, PUB. 10-27-1998. INT. CL. 28.

ECCOUNTING SOLUTIONS, LLC, MANSFIELD, MA:
2,571,190, PUB. 10-9-2001. INT. CL. 9.

ECONOCO CORPORATION, HICKSVILLE, NY:
1,921,470, CANC. MULTIPLE CLASS, INT. CLS. 6, 16, 18, 20 AND 22.

ECONOMICS AND STATISTICS ADMINISTRATION U.S. DEPARTMENT OF COMMERCE, WASHINGTON, DC:
1,885,893, CANC. INT. CL. 9.

EDICIONES PLEYADES, S.A., 28015 MADRID, SPAIN:
1,872,436, CANC. INT. CL. 16.

EDMONTON RUNNING ROOM LTD., EDMONTON, ALBERTA, CANADA:
1,928,879, CANC. MULTIPLE CLASS, INT. CLS. 18, 25 AND 42.

EDRAMA LEARNING, INC., MONTEREY, CA:
2,571,811, INT. CL. 41.

EDUCATION LOAN SERVICING CENTER, INC., INDIANAPOLIS, IN:
1,886,709, CANC. INT. CL. 36.

EDUCATIONAL CREDIT SERVICES COMPANY, ST. PAUL, MN:
2,571,573, PUB. 2-26-2002. INT. CL. 36.

EDUSERV TECHNOLOGIES, INC., ST. PAUL, MN:
1,885,868, CANC. INT. CL. 9.

- EDWARD LEWIS TOBINICK, M.D., A MEDICAL CORPORATION, LOS ANGELES, CA:
2,572,341, INT. CL. 42.
- EDWARDS LIFESCIENCES CORPORATION, IRVINE, CA FROM BAXTER INTERNATIONAL INC., DEEFIELD, IL:
2,570,675, PUB. 9-4-2001. INT. CL. 10.
- EDWARDS, MILES S., PHOENIX, AZ AND EDWARDS, CAROL D., PHOENIX, AZ:
1,885,885, CANC. INT. CL. 9.
- EFR/RUSSELL, INC., OAKBROOK TERRACE, IL:
1,886,286, CANC. INT. CL. 36.
- EGJ, INC., LOWELL, MA, DBA ABBEY ROAD TAVERN:
1,886,452, CANC. INT. CL. 42.
- EGS, INC., WHITEHOUSE STATION, NJ:
2,571,129, PUB. 2-26-2002. INT. CL. 9.
- EIGHTH AVE TAVERN, INC., NEW YORK, NY:
2,571,292, PUB. 2-26-2002. INT. CL. 25.
- EISAI INC., TEANECK, NJ:
2,572,037, INT. CL. 41.
- EKLER INDUSTRIES, LLC, TITUSVILLE, FL, ECKLER INDUSTRIES INC., TITUSVILLE, FL:
1,660,186, REN. 4-9-02. INT. CL. 42.
- ELEASERRETURNS.COM, DANVILLE, CA:
2,571,022, PUB. 2-26-2002. INT. CL. 35.
- ELECTROCHEMICAL PRODUCTS, INC., NEW BERLIN, WI:
1,650,523, REN. 4-9-02. INT. CL. 3.
- ELECTRONIC DATA SYSTEMS CORPORATION, PLANO, TX:
1,886,537, CANC. INT. CL. 9.
- ELECTRONIC DATA SYSTEMS CORPORATION, DALLAS, TX:
1,886,738, CANC. INT. CL. 42.
- ELECTRONIC INDUSTRIES FOUNDATION, ARLINGTON, VA:
2,572,421, INT. CL. 41.
- ELECTRONIC REALTY ASSOCIATES, L.P., SHAWNEE MISSION, KS:
1,886,318, CANC. INT. CL. 36.
1,886,708, CANC. INT. CL. 36.
- ELEMENTIS SPECIALITIES, INC., HIGHTSTOWN, NJ, HARDMAN INCORPORATED, NEWARK, NJ:
936,381, REN. 4-6-02. U.S. CL. 6 (INT. CL. 1).
- ELI EDMUND CO., THE, KITTY HAWK, NC:
2,571,218, PUB. 2-26-2002. INT. CL. 16.
- ELIAS ARTS LTD., NEW YORK, NY:
2,571,754, MULTIPLE CLASS, INT. CLS. 35, 41 AND 42.
- ELIASON CORPORATION, KALAMAZOO, MI:
2,571,238, PUB. 2-26-2002. MULTIPLE CLASS, INT. CLS. 6 AND 19.
- ELKEM LIMITED, MOON TOWNSHIP, PA, ELKEM METALS COMPANY, PITTSBURGH, PA:
1,679,160, REN. 4-6-02. INT. CL. 6.
- ELLERBE, SHELTON MAURICE, ATLANTA, GA:
2,571,024, PUB. 2-26-2002. INT. CL. 41.
- ELLIANCE, INC., PITTSBURGH, PA FROM RESEARCH ACCESS, INC., PITTSBURGH, PA:
2,572,288, MULTIPLE CLASS, INT. CLS. 35 AND 42.
- ELRO CORPORATION, NEW YORK, NY:
2,571,648, PUB. 2-26-2002. INT. CL. 42.
- EMARKMONITOR INC., BOISE, ID:
2,572,253, INT. CL. 42.
- EMASTER CORPORATION, ARCADIA, CA:
2,571,087, PUB. 2-26-2002. INT. CL. 9.
- EMC VENTURES, INC., WILMINGTON, NC:
2,572,316, INT. CL. 42.
- EMCO ENTERPRISES, INC., DES MOINES, IA, DBA EMCO SPECIALTIES, INC.:
1,885,803, CANC. INT. CL. 6.
- EMERGENCY RESTORATION SERVICES, INC., CHICAGO, IL:
2,571,034, PUB. 2-26-2002. INT. CL. 37.
- EMERSON ELECTRIC CO., ST. LOUIS, MO:
1,149,615, CANC. INT. CL. 7.
- EMOTION, INC., VIENNA, VA:
2,570,782, PUB. 2-26-2002. INT. CL. 42.
2,570,783, PUB. 2-26-2002. MULTIPLE CLASS, INT. CLS. 35 AND 39.
- EMPOWERED BENEFITS, LLC, CHARLOTTE, NC:
2,572,401, INT. CL. 36.
- ENCO MANUFACTURING COMPANY, INC., MELVILLE, NY, ENCO MANUFACTURING COMPANY, CHICAGO, IL:
1,163,425, REN. 4-10-02. MULTIPLE CLASS, INT. CLS. 7, 8 AND 9.
- ENDICOTT JOHNSON CORPORATION, ENDICOTT, NY:
713,221, CANC. U.S. CL. 39.
- ENERGY ABSORPTION SYSTEMS, INC., CHICAGO, IL:
1,685,732, REN. 4-10-02. INT. CL. 6.
- ENGELHARD CORPORATION, ISELIN, NJ:
2,571,878, INT. CL. 2.
- ENGINEERED DATA PRODUCTS, INC., BROOMFIELD, CO:
2,571,806, INT. CL. 9.
- ENGINEERED PRODUCTS & SERVICES, INC., BROOKFIELD, WI:
2,572,418, MULTIPLE CLASS, INT. CLS. 17 AND 42.
- ENGINEERING.COM INCORPORATED, MISSISSAUGA, ONTARIO:
2,571,096, PUB. 2-26-2002. INT. CL. 42.
- ENIC CORPORATION, SEATTLE, WA:
2,570,781, PUB. 2-26-2002. INT. CL. 38.
- ENID BLYTON LIMITED, LONDON, ENGLAND:
2,570,490, PUB. 7-10-2001. MULTIPLE CLASS, INT. CLS. 3, 9, 14, 16, 18, 20, 21, 24, 25, 27, 28, 29, 30 AND 41.
- ENTERPRISE DIRECT, INC., NASHVILLE, TN, ENTERPRISE APPLIANCE CORPORATION, NASHVILLE, TN:
1,715,426, REN. 4-9-02. INT. CL. 11.
- ENTREON CORPORATION, MINNETONKA, MN:
2,570,745, PUB. 5-8-2001. INT. CL. 9.
- ENTREPRENEUR MEDIA, INC., IRVINE, CA:
2,572,347, INT. CL. 9.
- ENVENT ENERGY, LLC, DENVER, CO:
2,571,531, PUB. 2-26-2002. INT. CL. 35.
- EPC CORPORATION, MARKHAM, ONTARIO, CANADA:
2,570,683, PUB. 5-29-2001. INT. CL. 9.
- EPINIONS, INC., BRISBANE, CA:
2,570,859, PUB. 2-26-2002. INT. CL. 35.
- EPNEUMATICS, INC., SANTA FE SPRINGS, CA:
2,572,126, INT. CL. 35.
- EPSTEIN, DARREN L., FT. LAUDERDALE, FL:
2,572,320, MULTIPLE CLASS, INT. CLS. 35 AND 42.
- EQUILATERAL TECHNOLOGIES, INC., LEXINGTON, MA:
2,571,371, PUB. 2-26-2002. INT. CL. 42.
- EQUIPMAX, INC., ODESSA, TX:
2,570,943, PUB. 2-26-2002. INT. CL. 30.
- EQUISTAR CHEMICALS, LP, HOUSTON, TX, E.I. DU PONT DE NEMOURS AND COMPANY, WILMINGTON, DE:
543,580, REN. 4-6-02. U.S. CL. 6 (INT. CL. 1).
- ERCO LEUCHTEN GMBH, 58507 LUDENSCHIED, FED REP GERMANY:
2,460,482, COR. INT. CL. 11.
- EREFERENCEDESK, LLC, ST. PETERSBURG, FL:
2,571,374, PUB. 2-26-2002. INT. CL. 41.
- ERIC JUSTICE AND RENE COLLINS PARTNERSHIP, THE, NEW YORK, NY:
2,571,167, PUB. 2-26-2002. INT. CL. 41.
- ERICKSON, JOHN R., PERRYTON, TX, ERICKSON, JOHN R., PERRYTON, TX:
1,681,847, REN. 4-11-02. MULTIPLE CLASS, INT. CLS. 9, 16 AND 25.
- ERO INDUSTRIES, INC., CHICAGO, IL:
1,149,959, CANC. INT. CL. 28.
- ESAB AB, S-402 77 GOTEBOG, SWEDEN, ESAB AB, S-402 77 GOTEBOG, SWEDEN:
1,724,816, REN. 4-9-02. INT. CL. 1.
- ESAB WELDING PRODUCTS, INC., FLORENCE, SC:
1,728,907, REN. 4-10-02. INT. CL. 7.
- ESAOTE BIOMEDICA, 16153 GENOA, ITALY TO ESAOTE BIOMEDICA, 16153 GENOA, ITALY:
1,901,647, COR. INT. CL. 10.
- ESSKAY INVESTMENTS, INC., WILMINGTON, DE, WM. SCHLUDERBERG-T. J. KURDLE CO., THE, BALTIMORE, MD:
154,687, REN. 4-6-02. U.S. CL. 46 (INT. CL. 29).

- ETABLISSEMENTS CAILLAU, 92130 ISSY LES MOULINEAUX, FRANCE:
1,885,800, CANC. INT. CL. 6.
- ETABLISSEMENTS FALLOT, 21200 BEAUNE, FRANCE:
1,684,566, REN. 4-10-02. INT. CL. 30.
- EUREKA! INSTITUTE, INC., NEWTOWN, OH:
2,570,979, PUB. 2-26-2002. INT. CL. 35.
- EURIBOR FEDERATION BANCAIRE EUROPEENNE, 1000 BRUSSELS, BELGIUM:
2,570,946, PUB. 2-26-2002. INT. CL. 36.
- EUSTACHE, DOMINIQUE R., SEILLANS, FRANCE:
2,572,225, INT. CL. 21.
- EVANS MANUFACTURING, LLC, FARMINGDALE, NY:
2,572,070, INT. CL. 15.
- EVANS, MARK, PINEHURST, NC:
2,571,671, PUB. 2-26-2002. INT. CL. 41.
- EVEREADY BATTERY COMPANY, INC., ST. LOUIS, MO:
2,572,178, INT. CL. 9.
2,572,186, INT. CL. 11.
2,572,321, INT. CL. 11.
- EVERETT AND JONES BARBEQUE, INC., HAYWARD, CA:
2,571,217, PUB. 2-26-2002. INT. CL. 42.
- EXCELLCARE, INC., NORTHBROOK, IL:
1,886,742, CANC. INT. CL. 42.
- EXECUTIVE IMAGE, INCORPORATED, THE, PITTSBURGH, PA:
1,886,459, CANC. INT. CL. 42.
- EXPLORENT CHIRURGISCHE INSTRUMENTE GMBH, D-78532 TUTTLINGEN, FED REP GERMANY:
2,445,407, COR. INT. CL. 10.
- EXTATICA, INC., MILL VALLEY, CA:
2,571,153, PUB. 2-26-2002. INT. CL. 42.
- EXTREME NUTRITIONALS, LLC, MOORESVILLE, NC:
2,571,801, INT. CL. 5.
- EXXON MOBIL CORPORATION, IRVING, TX FROM EXXON CORPORATION, IRVING, TX:
2,571,850, INT. CL. 4.
- EXXON MOBIL CORPORATION (FORMERLY EXXON CORPORATION), IRVING, TX:
2,571,274, PUB. 2-26-2002. INT. CL. 4.
- EXXONMOBIL OIL CORPORATION, IRVING, TX, STANDARD OIL COMPANY OF NEW YORK, NEW YORK, NY:
287,746, REN. 4-10-02. U.S. CL. 15 (INT. CL. 4).
- EYE STATE INC, LAS VEGAS, CA:
2,571,556, PUB. 2-26-2002. INT. CL. 9.
- EYERIS, INC., DENVER, CO:
2,572,350, INT. CL. 42.
- EIYSIAN BREWING COMPANY, INC, SEATTLE, WA:
2,571,622, PUB. 2-26-2002. INT. CL. 32.
- E3WORLD.COM, INC., GARDENDALE, AL:
2,570,726, PUB. 2-26-2002. INT. CL. 35.
- F. B. ASSOCIATES LLC, STAMFORD, CT, NEW ENGLAND BREWING CO., INC., SOUTH NORWALK, CT:
1,733,423, REN. 4-8-02. INT. CL. 32.
- F. OBERDORFER SIEBTECHNIK GMBH, 7920 HEIDENHEIM, FED REP GERMANY:
1,638,891, CANC. INT. CL. 7.
- FACE IT COSMETICS, INC., AUSTIN, TX:
2,571,549, PUB. 2-26-2002. INT. CL. 3.
- FACILITY MERCHANDISING, INC., WOODLAND HILLS, CA:
2,571,732, MULTIPLE CLASS, INT. CLS. 6 AND 14.
- FAIDLEY, WARREN E. JR., TUCSON, AZ:
2,571,660, PUB. 2-26-2002. INT. CL. 42.
- FAIRFIELD INDUSTRIES INCORPORATED, SUGAR LAND, TX:
2,572,200, INT. CL. 42.
- FAIRMONT HOTELS & RESORTS (U.S.) INC., TORONTO, ONTARIO, CANADA, FAIRMONT HOTEL MANAGEMENT COMPANY, SAN FRANCISCO, CA:
1,709,532, REN. 4-6-02. INT. CL. 42.
- FAIRMOUNT BAGEL BAKERY INC., MONTREAL, PROVINCE OF QUEBEC, CANADA:
2,570,491, PUB. 6-20-2000. MULTIPLE CLASS, INT. CLS. 30 AND 35.
- FAIRWAYS GROUP, L.P., THE, LA QUINTA, CA:
1,886,813, CANC. INT. CL. 41.
- FAITHLINE DESIGN, INC., COLUMBIA, PA:
2,572,054, INT. CL. 25.
- FALKE KG, D-57392 SCHMALLEMBERG, FED REP GERMANY:
2,570,702, PUB. 2-26-2002. INT. CL. 25.
- FAMILETTE, JOHN, DEER PARK, NY:
2,571,653, PUB. 2-26-2002. INT. CL. 39.
- FAMILY CENTER, INC., THE, SOMERVILLE, MA:
2,570,591, PUB. 2-26-2002. MULTIPLE CLASS, INT. CLS. 16, 41 AND 42.
- FAMILY Y, THE, WASHINGTON, PA:
2,570,961, PUB. 2-26-2002. INT. CL. 41.
- FANTASTIC CORPORATION, THE, CH-6928 LUGANOMANNO, SWITZERLAND FROM STARBURST COMMUNICATIONS CORP., CONCORD, MA:
2,571,833, INT. CL. 9.
- FARMER BROS. CO., TORRANCE, CA:
1,682,453, REN. 4-12-02. INT. CL. 29.
- FASHION FOOTWEAR ASSOCIATION OF NEW YORK, INC., NEW YORK, NY:
1,639,283, CANC. INT. CL. 41.
- FASSINO, ROBERT J., HUDSON, WI:
2,571,955, INT. CL. 41.
- FATBOY FILMS, LLC, RENO, NV, DBA TRIANGLE IMAGES:
2,571,914, INT. CL. 42.
- FAULTLESS STARCH/BON AMI COMPANY, KANSAS CITY, MO:
946,150, REN. 4-10-02. U.S. CL. 6 (INT. CL. 3).
- FAZZARI, VALENTINO, STUDIO CITY, CA, DBA FESTIVAL CATALINA COMPANY:
2,572,340, INT. CL. 41.
- FCIB-NACM CORPORATION, COLUMBIA, MD:
2,571,391, PUB. 2-26-2002. INT. CL. 36.
- FCIB-NACM, CORP., ISELIN, NJ:
2,570,613, PUB. 2-26-2002. INT. CL. 36.
- FEATHERBALL INC., RENO, NV:
1,886,145, CANC. INT. CL. 25.
- FEDERAL NATIONAL MORTGAGE ASSOCIATION, WASHINGTON, DC, DBA FANNIE MAE:
2,571,871, INT. CL. 36.
- FEDERAL-MOGUL WIESBADEN GMBH, D-65091 WIESBADEN, FED REP GERMANY:
2,570,566, PUB. 6-12-2001. MULTIPLE CLASS, INT. CLS. 6, 7 AND 12.
2,570,567, PUB. 6-12-2001. MULTIPLE CLASS, INT. CLS. 6, 7 AND 12.
2,570,568, PUB. 6-12-2001. MULTIPLE CLASS, INT. CLS. 6, 7 AND 12.
2,570,569, PUB. 6-12-2001. MULTIPLE CLASS, INT. CLS. 6, 7 AND 12.
2,570,570, PUB. 6-12-2001. MULTIPLE CLASS, INT. CLS. 6, 7 AND 12.
- FEDERAL-MOGUL WORLD WIDE, INC., SOUTHFIELD, MI, FEL-PRO INCORPORATED, SKOKIE, IL:
1,677,628, REN. 4-6-02. INT. CL. 17.
- FEDERATED DEPARTMENT STORES, INC., CINCINNATI, OH:
1,886,143, CANC. INT. CL. 25.
- FEDERATED GROUP, INC., THE, ARLINGTON HEIGHTS, IL:
1,964,460, CANC. MULTIPLE CLASS, INT. CLS. 3, 16 AND 29.
- FEDERATED MUTUAL INSURANCE COMPANY, OWATONNA, MN:
1,686,732, REN. 4-6-02. INT. CL. 36.
1,694,832, REN. 4-10-02. INT. CL. 36.
- FELLOWES, INC., ITASCA, IL, FELLOWES MANUFACTURING COMPANY, ITASCA, IL:
1,166,480, REN. 4-10-02. MULTIPLE CLASS, INT. CLS. 16 AND 20.
- FELLOWS, TERRI, NEW YORK, NY:
2,571,980, MULTIPLE CLASS, INT. CLS. 35 AND 42.
- FEMBRACE, INC., MONSEY, NY:
2,571,386, PUB. 2-26-2002. INT. CL. 10.
- FERGUSON, RONALD ANTONIO, BALTIMORE, MD:
2,571,246, PUB. 2-26-2002. INT. CL. 16.

- FERRARA PAN CANDY CO., INC., FOREST PARK, IL:
2,571,632, PUB. 2-26-2002. INT. CL. 30.
- FERRARI F.LLI LUNELLIS.P.A., 38040 TRENTO, ITALY:
1,741,586. REN. 4-11-02. INT. CL. 33.
- FERRARI, PHILIP F., MEDINAH, IL:
2,571,713, INT. CL. 28.
- FETZER VINEYARDS, REDWOOD VALLEY, CA:
1,843,123, CANC. INT. CL. 33.
- FIA OF ST. LOUIS, L.L.C., ST. LOUIS, MO, DBA FIRST INTERNET WORLDWIDE:
2,570,777, PUB. 2-26-2002. INT. CL. 42.
- FIBER DOES, INC., SAN JOSE, CA:
1,885,917, CANC. INT. CL. 9.
- FIBER INDUSTRIES, INC., SHREWSBURY, NJ:
1,674,283. REN. 4-9-02. MULTIPLE CLASS, INT. CLS. 22 AND 23.
- FIELDCREST CANNON LICENSING, INC., KANNAPOLIS, NC, FIELDCREST CANNON, INC., EDEN, NC:
1,598,672. REN. 4-6-02. INT. CL. 24.
- FIFN, INC., SEAL BEACH, CA:
2,572,273, INT. CL. 35.
- FILM FABRICATORS, INC., ORLAND, IN:
1,886,019, CANC. INT. CL. 16.
- FILMAX, INC., KNOXVILLE, TN:
1,885,819, CANC. INT. CL. 7.
- FILTRATION GROUP INCORPORATED, JOLIET, IL FROM ENVIRONMENTAL FILTER CORPORATION, SANTA ROSA, CA:
2,571,773, MULTIPLE CLASS, INT. CLS. 35 AND 37.
- FILTRONA RICHMOND, INC., COLONIAL HEIGHTS, VA, U.S. FILTER CORPORATION, RICHMOND, VA:
733,601. REN. 4-11-02. U.S. CL. 1 (INT. CL. 1).
- FINANCIAL INSIGHT SYSTEMS, INC., ROCKVILLE, MD:
2,570,715, PUB. 11-13-2001. INT. CL. 42.
- FIORINO, DEBRA H., NEWCASTLE, ME:
1,886,056, CANC. MULTIPLE CLASS, INT. CLS. 18 AND 25.
- FIRMENICH INCORPORATED, PLAINSBORO, NJ:
2,571,897, INT. CL. 30.
- FIRST COLONY COFFEE & TEA COMPANY, INC., THE, NORFOLK, VA:
1,192,242. REN. 4-10-02. INT. CL. 30.
- FIRST GUARANTY COMPANIES, DALLAS, TX:
2,571,645, PUB. 2-26-2002. INT. CL. 35.
- FIRST RESPONSE, INC., GRIFFIN, GA:
1,886,604, CANC. INT. CL. 12.
- FIRST UNION CORPORATION, CHARLOTTE, NC:
2,571,344, PUB. 2-26-2002. INT. CL. 36.
- FIRST-CITIZENS BANK AND TRUST COMPANY OF SOUTH CAROLINA, COLUMBIA, SC:
2,571,443, PUB. 2-26-2002. INT. CL. 36.
- FISCHER, JOHN S., BIRMINGHAM, AL:
1,886,659, CANC. INT. CL. 25.
- FISHER SCIENTIFIC COMPANY L.L.C., HAMPTON, NH:
2,571,082, PUB. 2-26-2002. INT. CL. 41.
- FISHMAN, DEL, KEEGO HARBOR, MI:
2,570,642, PUB. 2-26-2002. INT. CL. 36.
- FIVE-0, BEVERLY HILLS, CA:
2,571,640, PUB. 2-26-2002. INT. CL. 42.
- FIXX ENTERPRISES, INC., NORCROSS, GA:
1,886,326, CANC. INT. CL. 37.
- FIZGIG PRODUCTIONS, LLC, OLD GREENWICH, CT:
2,570,722, PUB. 2-26-2002. MULTIPLE CLASS, INT. CLS. 35 AND 42.
- FLAGSTONE HOSPITALITY MANAGEMENT, LLC, MEMPHIS, TN FROM WHARF MANAGEMENT COMPANY, MEMPHIS, TN:
2,572,107, INT. CL. 42.
- FLATBREAD COMPANY, INC., AMESBURY, MA:
2,572,294, INT. CL. 42.
- FLAVOR BURST COMPANY, DANVILLE, IN:
2,571,291, PUB. 2-26-2002. MULTIPLE CLASS, INT. CLS. 21 AND 30.
- FLAVORX, INC., BETHESDA, MD:
2,570,944, PUB. 2-26-2002. INT. CL. 42.
- FLEER/SKYBOX INTERNATIONAL LP, MT. LAUREL, NJ:
2,572,137, INT. CL. 16.
- FLEET FINANCIAL GROUP, INC.:
See— FLEETBOSTON FINANCIAL CORPORATION.
- FLEETBOSTON FINANCIAL CORPORATION, BOSTON, MA FROM FLEET FINANCIAL GROUP, INC., BOSTON, MA:
2,570,538, PUB. 10-2-2001. MULTIPLE CLASS, INT. CLS. 35 AND 42.
- FLEETWOOD ENTERPRISES, INC., RIVERSIDE, CA:
1,886,077, CANC. MULTIPLE CLASS, INT. CLS. 20 AND 21.
- FLEXMOMS.COM, INC., MILL VALLEY, CA:
2,572,218, INT. CL. 35.
- FLIGHT INNOVATIONS, INC., ARLINGTON, WA:
1,639,017, CANC. INT. CL. 12.
- FLO-BALL, INC., EAST SYRACUSE, NY:
1,639,084, CANC. INT. CL. 16.
- FLORES S.A.R.L., 38000, GRENOBLE, FRANCE:
1,886,207, CANC. MULTIPLE CLASS, INT. CLS. 29, 30 AND 32.
- FLORI ROBERTS, INC., FARMINGDALE, NJ:
1,149,548, CANC. INT. CL. 3.
- FLORIDA EYE CENTER, SEVER & RAMSEUR, M.D., P.A., TAMPA, FL:
1,886,405, CANC. INT. CL. 42.
- FLORIDA FEDERAL SAVINGS AND LOAN ASSOCIATION, ST. PETERSBURG, FL:
1,150,021, CANC. INT. CL. 36.
- FLORSHEIM SHOE COMPANY, THE, CHICAGO, IL:
1,639,173, CANC. INT. CL. 25.
- FLP ENTERPRISES, INC., ANDOVER, MA:
1,638,995, CANC. INT. CL. 10.
- FLUENT BABY, INC., PALO ALTO, CA:
2,572,333, MULTIPLE CLASS, INT. CLS. 9, 16, 28 AND 41.
- FLUOR CORPORATION, ALISO VIEJO, CA:
2,571,941, INT. CL. 35.
- FLYING FISH BREWING CO., LLC, CHERRY HILL, NJ:
2,571,547, PUB. 2-26-2002. MULTIPLE CLASS, INT. CLS. 25 AND 32.
- FMC CORPORATION, PHILADELPHIA, PA:
1,705,721. REN. 4-12-02. INT. CL. 1.
- FOAM FORM SYSTEMS, INC., MCHENRY, IL, FOAM FORM SYSTEMS, INC., MCHENRY, IL:
1,676,795. REN. 4-10-02. INT. CL. 19.
- FOCUS ON THE FAMILY, COLORADO SPRINGS, CO:
2,572,343, INT. CL. 42.
- FOGDOG, INC., REDWOOD CITY, CA:
2,571,064, PUB. 10-23-2001. INT. CL. 35.
- FONDA GROUP, INC., OSHKOSH, WI, SCOTT PAPER COMPANY, DELAWARE COUNTY, PA:
1,705,845. REN. 4-11-02. INT. CL. 16.
- FOR FUTURE GENERATIONS, INC., REDWAY, CA, MUSIC FOR LITTLE PEOPLE, INCORPORATED, REDWAY, CA, DBA EARTHBEAT!
1,600,065. REN. 4-10-02. INT. CL. 42.
- FORD FASTENERS, INC., HACKENSACK, NJ:
2,572,018, INT. CL. 6.
- FORD GUM AND MACHINE COMPANY, INC., AKRON, NY:
937,259. REN. 4-6-02. U.S. CL. 101 (INT. CL. 35).
- FORD MOTOR COMPANY, DEARBORN, MI:
395,731. REN. 4-12-02. U.S. CL. 21 (INT. CL. 9).
- 1,664,940. REN. 4-9-02. INT. CL. 12.
- 1,706,326. REN. 4-8-02. INT. CL. 9.
- 2,571,339, PUB. 2-26-2002. INT. CL. 36.
- FORD MOTOR COMPANY, DEARBORN, MI FROM FORD MOTOR COMPANY, DEARBORN, MI:
2,572,071, INT. CL. 42.
- FOREIGN POLICY RESEARCH INSTITUTE, PHILADELPHIA, PA:
1,886,812, CANC. INT. CL. 41.
- FOREMOST CORPORATION OF AMERICA, GRAND RAPIDS, MI:
1,975,797, CANC. INT. CL. 9.
- FOREST STEWARDSHIP COUNCIL, A.C., 68000 OAXACA, OAXACA, MEXICO:
2,570,559, PUB. 6-27-2000. MULTIPLE CLASS, U.S. CLS. A AND B.

- FOREVER NEW INTERNATIONAL, INC., SIOUX FALLS, SD:
2,572,387, INT. CL. 3.
- FORM RITE CORPORATION, AUBURN HILLS, MI:
1,885,799, CANC. INT. CL. 6.
- FORTIFIED NETWORKS, INC., CARMEL, IN:
2,571,062, PUB. 2-26-2002. INT. CL. 42.
- FORTRESS FINANCIAL SECURITIES CORP., TEMECULA, CA:
2,572,325, INT. CL. 36.
- FOSPUR LIMITED, DERBY DE55 4LR, ENGLAND:
1,885,733, CANC. INT. CL. 1.
- FOSTER & SMITH, INC., RHINELANDER, WI:
2,571,207, PUB. 2-26-2002. INT. CL. 31.
- FOSTER PEPPER & SHEFELMAN PLLC, SEATTLE, WA:
2,571,876, INT. CL. 42.
- FOUNDATION FOR EVANGELISM, THE, LAKE JUNALUSKA, NC:
2,571,460, PUB. 2-26-2002. INT. CL. 42.
- FOUR STAR MARKETING, INC., LINCOLNWOOD, IL:
2,572,323, INT. CL. 35.
- FOURTHCHANNEL, INC., COLUMBUS, DE:
2,570,560, PUB. 2-26-2002. INT. CL. 42.
- FOVEON, INC., SANTA CLARA, CA:
2,571,817, INT. CL. 9.
- FOX BROADCASTING COMPANY, LOS ANGELES, CA:
2,571,569, PUB. 2-26-2002. INT. CL. 41.
- FRANCESCO AZIENDA AGRICOLA SPADAFORA, I-90144 PALERMO, ITALY:
2,572,370, INT. CL. 33.
- FRANKLIN MINT COMPANY, PHILADELPHIA, PA:
2,571,788, MULTIPLE CLASS, INT. CLS. 21 AND 28.
- FRANZ HAAS S.R.L., MONTAGNA (BOLZANO), ITALY:
2,570,718, PUB. 11-13-2001. INT. CL. 33.
- FRAYMOULD CORPORATION, ENGLEWOOD, CO:
1,886,043, CANC. INT. CL. 17.
- FRE COMPOSITES INC., ST. ANDRE EST, QUEBEC, CANADA:
1,886,041, CANC. INT. CL. 17.
- FREDERICK ATKINS, INC., NEW YORK, NY:
1,886,653, CANC. INT. CL. 25.
- FREE PEERS, INC., WEST PALM BEACH, FL:
2,571,561, PUB. 2-26-2002. INT. CL. 9.
- FREELAND, FRANK B., MARIETTA, GA:
1,886,324, CANC. INT. CL. 37.
- FREIGHT SALES, INC., SCOTTSDALE, AZ:
2,570,960, PUB. 2-26-2002. INT. CL. 35.
- FRES-CO SYSTEM USA, INC., TELFORD, PA:
2,571,814, INT. CL. 7.
- FRESENIUS USA, INC., WALNUT CREEK, CA:
2,570,480, PUB. 2-26-2002. INT. CL. 10.
- FRIBAD COSMETICS GMBH (CURRENT OWNER) (GERMAN LIMITED LIABILITY CO.), BADEN-BADEN GERMANY:
713,283, CANC. U.S. CL. 51.
- FRIEDRICH LUTZE GMBH + CO., D-71384 WEINSTADT, FED REP GERMANY:
2,572,094, INT. CL. 9.
- FRUIT-A-FREEZE, INC., NORWALK, CA:
1,886,221, CANC. INT. CL. 30.
- FRY, STEPHEN E., PARADISE VALLEY, AZ:
1,886,595, CANC. INT. CL. 10.
- FSP RESEARCH, INC., MILFORD, CT:
1,885,758, CANC. INT. CL. 3.
- FUJI KOGYO CO., LTD., SHIZUOKA-SHI, SHIZUOKA-KEN, JAPAN:
1,190,123, REN. 4-6-02. INT. CL. 28.
- FUKUVI KAGAKU KOGYO KABUSHIKI KAISHA, FUKUISHI, FUKUI-KEN, JAPAN, TA FUKUVI CHEMICAL INDUSTRY CO., LTD.:
1,886,074, CANC. INT. CL. 20.
- FULLFILLMENT PLUS, INC, WALTHAM, MA:
2,571,931, INT. CL. 39.
- FULLER COMPANY, BETHLEHEM, PA:
1,885,948, CANC. INT. CL. 11.
- FULLER CORPORATION, THE, BROCKTON, MA:
1,679,669, REN. 4-10-02. INT. CL. 39.
- FUTURE COMMUNICATIONS GROUP, LTD, ROCKFORD, IL:
2,571,035, PUB. 2-26-2002. INT. CL. 42.
- FUZZY MANGO, INC., BOKEELIA, FL:
2,572,335, INT. CL. 25.
- G. LEBLANC CORPORATION, KENOSHA, WI:
2,571,361, PUB. 2-26-2002. INT. CL. 15.
- G.S. BUILDING SYSTEMS CORPORATION:
1,638,958, CANC. INT. CL. 9.
- G.W. HEALTHCARE, INC., OAKLAND, FL:
2,572,202, INT. CL. 10.
- GABET, RENEE ANN, LIGONIER, IN, DBA ANNIE OAKLEY ENTERPRISE:
1,639,133, CANC. INT. CL. 25.
- GAIT BROTHERS LACROSSE COMPANY, SYRACUSE, NY:
2,570,793, PUB. 2-26-2002. MULTIPLE CLASS, INT. CLS. 25 AND 35.
- GALACTIC TRADERS INTERNATIONAL MARKETING PTY LTD, PARRAMATTA, NEW SOUTH WALES 2151, AUSTRALIA:
1,886,183, CANC. INT. CL. 28.
- GALLEON INTERNATIONAL, INC., SAN ANTONIO, TX:
1,149,843, CANC. INT. CL. 20.
- GAMES MAGNET LIMITED, LONDON NW2 2DP, UNITED KINGDOM:
2,570,955, PUB. 2-26-2002. INT. CL. 41.
- GAMES OF ENTROPY & TIME, HAYWARD, CA:
1,886,668, CANC. INT. CL. 28.
- GAMEWRIGHT, INCORPORATED, CHESTNUT HILL, MA:
1,886,202, CANC. INT. CL. 28.
- GAMING CONCEPTS, INC., LONG BEACH, CA:
1,639,185, CANC. INT. CL. 28.
- GARNER, ROBBY D., CLINTON, MD:
2,571,843, INT. CL. 34.
- GARRABRANT, SCOTT J., BARRINGTON, IL:
2,571,500, PUB. 2-26-2002. INT. CL. 41.
- GARRITY INDUSTRIES, MADISON, CT:
1,775,104, COR. INT. CL. 11.
- GARRITY INDUSTRIES, INC., MADISON, CT, GARRITY; PAUL G., STAMFORD, CT:
1,176,016, REN. 4-11-02. INT. CL. 11.
- GASPAROVIC, TONY, DIAMOND BAR, CA:
2,572,152, INT. CL. 42.
- GATES CORPORATION, THE, DENVER, CO:
2,571,751, INT. CL. 7.
- GATES RUBBER COMPANY, THE, DENVER, CO:
1,149,810, CANC. INT. CL. 17.
- GE ENGINE SERVICES, INC.:
See—GENERAL ELECTRIC COMPANY.
- GEBKA, MIROSLAW W., CHICAGO, IL, DBA UNITED WORLD IMPORTS, INC.:
1,883,081, CANC. INT. CL. 32.
- GEBR. MARKLIN & CIE. GMBH, 73037 GOPPINGEN, FED REP GERMANY:
1,885,889, CANC. MULTIPLE CLASS, INT. CLS. 9 AND 28.
- GEER GROUP, INC., THE, CHARLOTTE, NC:
2,571,800, INT. CL. 9.
- GEM CITY CHEMICALS, INC., DAYTON, OH:
1,149,531, CANC. INT. CL. 1.
- GEM PRODUCTS, INCORPORATED, ORANGE PARK, FL, DBA GEM PRODUCTS, INC.:
1,693,972, REN. 4-7-02. INT. CL. 6.
- GENERAL AVIATION MANUFACTURERS ASSOCIATION, THE, WASHINGTON, DC AND NATIONAL BUSINESS AIRCRAFT ASSOCIATION, INC., THE, WASHINGTON, DC:
1,886,745, CANC. INT. CL. 42.
- GENERAL CONTAINER CO. OF MICHIGAN, INC., HILLSDALE, MI:
1,886,223, CANC. INT. CL. 30.
- GENERAL ELECTRIC COMPANY, LOUISVILLE, KY:
1,149,631, CANC. INT. CL. 7.
- GENERAL ELECTRIC COMPANY, SCHENECTADY, NY:
1,149,664, CANC. INT. CL. 9.
- GENERAL ELECTRIC COMPANY, SCHENECTADY, NY FROM GE ENGINE SERVICES, INC., CINCINNATI, OH:
2,571,544, PUB. 2-26-2002. INT. CL. 7.

- GENERAL ELECTRIC COMPANY, SCHENECTADY, NY:
2,572,229, INT. CL. 17.
- GENERAL FINANCE SERVICE CORPORATION, HUNTINGDON, PA:
713,299, CANC. U.S. CL. 102.
- GENERAL MILLS, INC., MINNEAPOLIS, MN:
1,149,852, CANC. INT. CL. 21.
1,149,853, CANC. INT. CL. 21.
1,149,854, CANC. INT. CL. 21.
1,149,855, CANC. INT. CL. 21.
1,149,856, CANC. INT. CL. 21.
2,570,967, PUB. 2-26-2002. MULTIPLE CLASS, INT. CLS. 16 AND 28.
- GENERAL MOTORS CORPORATION, DETROIT, MI:
1,675,488, REN. 4-6-02. INT. CL. 42.
1,689,849, REN. 4-6-02. INT. CL. 7.
2,570,842, PUB. 2-26-2002. INT. CL. 18.
- GENERAL SERVICES ADMINISTRATION, WASHINGTON, DC:
2,572,324, INT. CL. 42.
- GENERAL TIRE, INC., AKRON, OH:
1,885,961, CANC. INT. CL. 12.
- GENERAL VALVE CORPORATION, FAIRFIELD, NJ:
1,886,562, CANC. INT. CL. 9.
- GENERATIONS FINANCIAL ADVISORS, INC., SALISBURY, MD:
2,571,928, INT. CL. 36.
- GENESCO INC., NASHVILLE, TN:
1,872,558, CANC. INT. CL. 25.
- GENTLE DENTAL SERVICE CORPORATION, VANCOUVER, WA, MALOOF, DANIEL L., SILVER SPRING, MD:
1,214,461, REN. 4-6-02. INT. CL. 42.
- GENUS, INC., WILMINGTON, DE:
2,572,351, INT. CL. 42.
- GEO. J. BALL, INC., WEST CHICAGO, IL, AKA PAN-AMERICAN SEED COMPANY:
1,149,984, CANC. INT. CL. 31.
- GEODIGM CORPORATION, CHANHASSEN, MN FROM HULTGREN, BRUCE, VICTORIA, MN:
2,572,036, INT. CL. 9.
- GEORGE LITTLE MANAGEMENT, INC., NEW YORK, NY:
1,886,262, CANC. INT. CL. 35.
- GEORGE MEANY CENTER FOR LABOR STUDIES, INC., SILVER SPRING, MD:
1,639,047, CANC. MULTIPLE CLASS, INT. CLS. 16, 21 AND 25.
- GEORGIA-PACIFIC CORPORATION, ATLANTA, GA:
1,149,805, CANC. INT. CL. 16.
- GEORGIA-PACIFIC RESINS, INC., ATLANTA, GA:
936,897, REN. 4-8-02. U.S. CL. 6 (INT. CL. 1).
1,698,652, REN. 4-10-02. INT. CL. 1.
- GEOSOURCE INC., HOUSTON, TX:
1,149,670, CANC. INT. CL. 9.
1,149,671, CANC. INT. CL. 9.
1,149,672, CANC. INT. CL. 9.
- GERAGHTY, WALTER J., JR., SAN ANTONIO, TX:
1,716,877, REN. 4-11-02. INT. CL. 42.
- GERARDI S.P.A., 21017 SAMARATE (VA), ITALY:
2,570,618, PUB. 6-26-2001. MULTIPLE CLASS, INT. CLS. 7 AND 8.
- GERTRUDE HAWK CHOCOLATES, INC., DUNMORE, PA:
1,886,242, CANC. INT. CL. 30.
- GESAM OY:
See—SONERA OJY.
- GESSER, HUBERT PINHEIRO, LOS ANGELES, CA:
2,570,948, PUB. 2-26-2002. INT. CL. 14.
- GESTION TECHNOCAP INC., QUEBEC, H9G 2Y1, CANADA:
2,570,596, PUB. 9-4-2001. MULTIPLE CLASS, INT. CLS. 35 AND 36.
- GFD FABRICS, INC., GREENSBORO, NC:
2,571,417, PUB. 2-26-2002. INT. CL. 24.
- GFI HOLDINGS, INC., SAN JOSE, CA:
2,571,373, PUB. 2-26-2002. INT. CL. 41.
- GHEZ, ANNE, 75008 PARIS, FRANCE:
1,885,969, CANC. INT. CL. 14.
- GIANNI VERSACE S.P.A., 20121 MILAN, ITALY:
1,885,997, CANC. INT. CL. 16.
- GIANSANTI, WILLARD R., ROCKY HILL, CT:
2,570,766, PUB. 2-26-2002. INT. CL. 37.
- GIBSON, DUNN & CRUTCHER LLP, LOS ANGELES, CA:
2,571,258, PUB. 2-26-2002. INT. CL. 42.
- GIESECKE & DEVRIENT GMBH, D-81677 MUNCHEN, FED REP GERMANY:
2,403,101, COR. MULTIPLE CLASS, INT. CLS. 7 AND 16.
- GIFTLOGIC.COM, INC.:
See—WISH SOLUTIONS.
- GILDA MARX INCORPORATED, LOS ANGELES, CA:
1,886,662, CANC. INT. CL. 25.
- GIROSOL CORP., ELIZABETH, NJ:
2,002,532, AM. INT. CL. 36.
- GLACIER TECHNOLOGIES, INC., NEW YORK, NY:
1,886,005, CANC. INT. CL. 16.
- GLASS, MICHAEL ALAN, BERKELEY, CA:
2,572,318, INT. CL. 41.
- GLEZZ, HUGO, CAMARILLO, CA AND SALVATO, DAVID A., CAMARILLO, CA, DBA HG & DS PRODUCTS AND DBA D & D ENTERPRISES:
1,885,987, CANC. MULTIPLE CLASS, INT. CLS. 16 AND 25.
- GLITTERBEST LIMITED, LONDON W.1, ENGLAND:
1,149,769, CANC. INT. CL. 16.
- GLOBAL EDVENTURES, LLP, COLUMBIA, MD:
2,571,856, INT. CL. 42.
- GLOBAL GRAPHICS S.A., 54340 POMPEY, FRANCE:
2,571,774, INT. CL. 7.
- GLOBAL GROUP INC., FORT WORTH, TX, GLOBAL GRAPHICS INC., FT. WORTH, TX:
1,189,612, REN. 4-8-02. INT. CL. 42.
- GLOBAL TRADZ, INC., WATERVILLE, OH:
2,571,674, PUB. 2-26-2002. INT. CL. 36.
- GLOBE CORPORATION LIMITED, WANCHAI, HONG KONG:
2,571,160, PUB. 2-26-2002. INT. CL. 28.
- GLORIA VANDERBILT TRADEMARK B.V., 1101 CR AMSTERDAM-Z.O., NETHERLANDS:
2,572,330, INT. CL. 25.
- GOAL SYSTEMS INTERNATIONAL INC., COLUMBUS, OH:
1,149,786, CANC. INT. CL. 16.
- GOAL SYSTEMS INTERNATIONAL, INC., COLUMBUS, OH:
1,149,784, CANC. INT. CL. 16.
- GOBUYBUY, INC., MEMPHIS, TN:
2,571,895, INT. CL. 42.
- GOINS, JERRY EDWIN, BYRON, GA:
2,571,787, INT. CL. 21.
- GOLD KEY ENTERPRISES, INC., MIDDLETOWN, KY:
1,150,096, CANC. INT. CL. 42.
- GOLD KIST INC., ATLANTA, GA:
1,150,085, CANC. INT. CL. 42.
- GOLD LANCE, INC., HOUSTON, TX:
1,885,971, CANC. INT. CL. 14.
- GOLD, SAMANTHA, NEW YORK, NY:
2,570,752, PUB. 2-26-2002. INT. CL. 16.
- GOLDBERG, DAVID, MARINA DEL REY, CA, DBA PETKIN PET CARE SYSTEMS:
1,886,508, CANC. INT. CL. 5.
- GOLDBERG, LEWIS B., CANOGA PARK, CA, DBA SOUND & SIGHT:
1,886,623, CANC. INT. CL. 20.
- GOLDEN BEAR INTERNATIONAL, INC., NORTH PALM BEACH, FL:
1,886,798, CANC. INT. CL. 25.
- GOLDEN BOY ENTERPRISES, LLC, LOS ANGELES, CA FROM OSCAR DE LA HOYA ENTERPRISES, INC., MONTEREY PARK, CA:
2,570,543, PUB. 10-16-2001. INT. CL. 25.
- GOLDEN DISCOUNTS INCORPORATED, LOUISVILLE, KY:
1,886,274, CANC. INT. CL. 35.
- GOLDEN FRANCHISING CORPORATION, DALLAS, TX:
1,886,208, CANC. INT. CL. 29.
- GOLDEN SUN, INC., SANTA CLARITA, CA:
2,570,554, PUB. 2-26-2002. INT. CL. 3.
- GOLDEN WEST PUBLISHING, INC., SANTA ANA, CA:
2,570,977, PUB. 2-26-2002. INT. CL. 16.

GOLDESIGN L.L.C., PROVO, UT:
2,571,495, PUB. 2-26-2002. INT. CL. 14.

GOLDSTEIN, HOWARD, J., WALLINGFORD, PA:
2,571,680, PUB. 2-26-2002. INT. CL. 30.

GOLF WELL AND BETTER, INC., AURORA, CO:
2,572,334, INT. CL. 41.

GOMEZ, ARTHUR, MIAMI BEACH, FL:
1,965,212, CANC. MULTIPLE CLASS, INT. CLS. 7 AND 9.

GONZALEZ-BLANCO, JOSE M., CITY OF COMMERCE, CA:
2,570,890, PUB. 2-26-2002. INT. CL. 5.

GONZALEZ, GLORIA, LA JOLLA, CA:
2,571,846, MULTIPLE CLASS, INT. CLS. 9, 16 AND 41.

GOOD STUFF L.L.C., LONG ISLAND CITY, NY:
2,571,304, PUB. 2-26-2002. INT. CL. 28.

GOODMANSON, DEBRA, KIRKLAND, WA:
2,571,509, PUB. 2-26-2002. INT. CL. 29.

GOODYEAR TIRE & RUBBER COMPANY, THE, AKRON, OH:
927,322. REN. 4-8-02. U.S. CL. 35 (INT. CL. 17).

GORDON & FERGUSON OF DELAWARE, INC., PLYMOUTH, MN:
1,886,140, CANC. INT. CL. 25.

GORDON-DARBY, INC., LOUISVILLE, KY:
2,570,743, PUB. 2-26-2002. INT. CL. 9.

GORMAN AND CAMPBELL, INC., HOOD RIVER, OR:
1,886,195, CANC. INT. CL. 28.

GOODES, JAMES, KANNAPOLIS, NC:
2,571,099, PUB. 7-3-2001. INT. CL. 12.

GOVERNOR AND COMPANY OF ADVENTURERS OF ENGLAND TRADING INTO HUDSON'S BAY, THE, TORONTO, ONTARIO, CANADA:
291,625. REN. 4-11-02. U.S. CL. 42 (INT. CL. 24).

GRAND SLAM TENNIS TOURS INC., DENVER, CO:
2,570,518, PUB. 2-26-2002. INT. CL. 39.

GRANICK ENTERPRISES, INC., WEST CHESTER, PA:
2,570,759, PUB. 2-26-2002. INT. CL. 30.

GRANIX TEAM, INC., ST. SIMONS, GA:
2,571,503, PUB. 2-26-2002. INT. CL. 30.

GRAPHIC PRODUCTS CORPORATION, WHEELING, IL:
1,886,559, CANC. INT. CL. 9.

GRATEFUL DEAD PRODUCTIONS, NOVATO, CA:
2,571,743, MULTIPLE CLASS, INT. CLS. 14, 16 AND 25.

GRAVES; ORVILLE R., MERCER ISLAND, WA, DBA SNOQUALMIE FALLS LODGE TO SNOQUALMIE HOSPITALITY SERVICES, INC., HOOD RIVER, OR:
1,192,225, CANC. INT. CL. 29.

GRAY COMMUNICATIONS, INC., CHICAGO, IL:
2,571,836, MULTIPLE CLASS, INT. CLS. 35 AND 38.

GRAYHOUND ELECTRONICS, INC., LAKEWOOD, NJ:
1,886,193, CANC. INT. CL. 28.

GREAT AMERICAN INSURANCE COMPANY, CINCINNATI, OH:
1,886,706, CANC. INT. CL. 36.
2,572,282, INT. CL. 36.

GREAT AMERICAN LIFE INSURANCE COMPANY, CINCINNATI, OH:
1,886,304, CANC. INT. CL. 36.
1,886,306, CANC. INT. CL. 36.

GREAT COFFEE COMPANY, INC., THE, COHASSET, MA:
1,886,399, CANC. INT. CL. 42.

GREAT PYRAMID, L.L.C., VIRGINIA BEACH, VA:
2,571,924, INT. CL. 42.

GRECIAN DELIGHT INC., SKOKIE, IL:
1,149,970, CANC. INT. CL. 29.

GREEN BAY PACKAGING, INC., GREEN BAY, WI:
1,886,012, CANC. INT. CL. 16.

GREEN, LONNY, S., GLEN ALLEN, VA:
2,571,611, PUB. 2-26-2002. INT. CL. 5.

GREENFIELD ENVIRONMENTAL, TORRANCE, CA:
1,886,718, CANC. INT. CL. 40.

GREENFIELD ONLINE, INC., WILTON, CT:
2,570,802, PUB. 2-26-2002. INT. CL. 35.

GREENLEE TEXTRON INC., ROCKFORD, IL:
1,659,447. REN. 4-10-02. INT. CL. 7.

GRIFFIN CORPORATION, VALDOSTA, GA:
2,523,957, CANC. INT. CL. 1.

GRIMALDI, CATHERINE HELEN, KANEOHE, HI:
2,572,026, INT. CL. 12.

GROUP PUBLISHING, INC., LOVELAND, CO:
1,886,388, CANC. INT. CL. 41.

GROUP 20, INC., NASHVILLE, TN:
2,571,067, PUB. 2-26-2002. INT. CL. 35.

GROVAC SYSTEMS, INC., PINE BLUFF, AR:
1,886,215, CANC. INT. CL. 29.

GRUNER + JAHR PRINTING & PUBLISHING CO., NEW YORK, NY:
2,571,459, PUB. 2-26-2002. INT. CL. 26.
2,571,461, PUB. 2-26-2002. INT. CL. 14.

GRUPPO CAVALLINO, INC., DALLAS, TX:
2,571,651, PUB. 2-26-2002. INT. CL. 25.

GRUPPO ITALIANO VINI S.C.A.R.L., BARDOLINO (VERONA), ITALY:
2,571,077, PUB. 2-26-2002. INT. CL. 33.

GTE SERVICE CORPORATION, STAMFORD, CT:
1,886,701, CANC. INT. CL. 35.

GTFM, INC., NEW YORK, NY:
2,571,080, PUB. 2-26-2002. INT. CL. 38.
2,571,725, INT. CL. 3.

GUANGDONG MACHINERY & EQUIPMENT IMPORT & EXPORT CORPORATION, GUANGZHOU, CHINA:
1,638,886, CANC. MULTIPLE CLASS, INT. CLS. 7, 9 AND 11.

GUARDAIR CORPORATION, CHICOPEE, MA:
2,571,023, PUB. 2-26-2002. INT. CL. 8.

GUARDIAN ANGEL, INC., MEMPHIS, TN:
1,886,533, CANC. INT. CL. 9.

GUARDIAN HOME FUNDING, INC., LANCASTER, PA:
2,570,812, PUB. 2-26-2002. INT. CL. 36.

GUCCI AMERICA INC., NEW YORK, NY:
1,149,731, CANC. INT. CL. 12.

GUCCI AMERICA, INC., NEW YORK, NY:
1,149,724, CANC. INT. CL. 12.

GUERDON INDUSTRIES, INC., LOUISVILLE, KY:
1,149,733, CANC. INT. CL. 12.

GUIDECOMM SYSTEMS, INC., CHANTILLY, VA:
2,572,181, INT. CL. 42.

GUILLOT, JOHN C. III, KILN, MS:
2,571,965, INT. CL. 13.

GUITAR AXIS INC., SEATTLE, WA:
2,571,945, INT. CL. 35.

GULFSTREAM AEROSPACE CORPORATION, SAVANNAH, GA:
1,149,802, CANC. INT. CL. 16.

GUN BARREL STEAKHOUSE, LLC., THE, JACKSON, WY:
1,890,303, CANC. INT. CL. 42.

GUSTIN-KRAMER LIMITED, CONCORD, ONTARIO, L4K 3P1, CANADA:
2,570,858, PUB. 2-26-2002. INT. CL. 21.

H & N FOODS INTERNATIONAL, INC., SAN FRANCISCO, CA, H & N FISH CO., SAN FRANCISCO, CA:
1,675,248. REN. 4-12-02. INT. CL. 29.

H.B. FULLER LICENSING & FINANCING, INC., SAINT PAUL, MN:
2,571,893, INT. CL. 1.

H.C. NAHIGIAN & SONS, INC., SKOKIE, IL:
2,571,056, PUB. 2-26-2002. INT. CL. 35.

H.D. LEE COMPANY, INC., THE, WILMINGTON, DE:
2,571,259, PUB. 2-26-2002. INT. CL. 25.

HABERSHAM HEARTH, INC., ALTO, GA:
1,675,114. REN. 4-10-02. INT. CL. 20.

HAFELE AMERICA CO., ARCHDALE, NC:
2,570,941, PUB. 2-26-2002. INT. CL. 6.

HAGAR, SAMMY, NOVATO, CA:
1,886,437, CANC. INT. CL. 42.

HAIN CELESTIAL GROUP, INC. THE, UNIONDALE, NY, ORIGINAL HAMPTON POTATO CHIP CO., THE, PORT WASHINGTON, NY:
1,731,395. REN. 4-7-02. INT. CL. 30.

HAINES, TERESA M., OLYMPIA, WA:
2,571,542, PUB. 2-26-2002. INT. CL. 16.

HAITAI AMERICA, INC., DOWNEY, CA:
1,858,435, CANC. INT. CL. 9.

HALLITE SEALS INTERNATIONAL LIMITED, HAMPTON, MIDDLESEX TW12 2HT, ENGLAND:
1,659,744. REN. 4-10-02. INT. CL. 17.

- HAMPTON DIRECT INC., SOUTH BURLINGTON, VT:
2,570,824, PUB. 2-26-2002. INT. CL. 3.
- HAMPTON INNS, INC., MEMPHIS, TN:
1,639,323, CANC. INT. CL. 42.
- HAMPTON, EDWARD JOHN, TRAFFORD, PA:
1,886,268, CANC. INT. CL. 35.
- HANAQUA INTERNATIONAL CORPORATION, TAIPEI, TAIWAN:
1,886,688, CANC. INT. CL. 31.
- HANEKAMP, JAMES, GLENVIEW, IL:
2,571,618, PUB. 2-26-2002. INT. CL. 42.
- HANLEY-WOOD, LLC, WASHINGTON, DC:
2,571,079, PUB. 7-10-2001. INT. CL. 16.
- HANNA, HARLINGTON L., JR., LOXAHATCHEE, FL:
2,570,582, PUB. 2-26-2002. INT. CL. 41.
- HANNAH, SCOTT WILLIAM, SAN CLEMENTE, CA, DBA REDLINE STUDIOS:
2,571,828, INT. CL. 41.
- HANS GSPANDL AND WILLIAM ROGERS PARTNERSHIP, THE, CROTON FALLS, NY:
1,886,732, CANC. INT. CL. 41.
- HANSAN GROUP, INC., THE, MCLEAN, VA:
1,682,901, REN. 4-12-02. INT. CL. 16.
- HARBOURSIDE, INC., ST. MICHAELS, MD:
2,571,113, PUB. 2-26-2002. MULTIPLE CLASS, INT. CLS. 39 AND 42.
- HARDWARE WHOLESALERS, INC., FORT WAYNE, IN:
1,886,711, CANC. INT. CL. 36.
- HAREWOOD, LLC, CONCORD, NC, ZERICK COMPANY, THE, WALLAND, TN:
1,671,139, REN. 4-11-02. INT. CL. 20.
- HARMAN INTERNATIONAL INDUSTRIES, INC., NORTH-RIDGE, CA, CROWN INTERNATIONAL, ELKHART, IN:
1,181,962, REN. 4-9-02. INT. CL. 9.
- HARMONY GOLD USA, INC., LOS ANGELES, CA:
2,571,879, INT. CL. 25.
- HARMONY PRODUCTS, INC., CHESAPEAKE, VA:
1,712,865, REN. 4-10-02. INT. CL. 1.
- HARRIS CORPORATION, MELBOURNE, FL:
1,885,874, CANC. INT. CL. 9.
- HARRIS, JAMES T., CULVER CITY, CA:
2,570,904, PUB. 2-26-2002. INT. CL. 35.
- HARRISON, HOWARD W., UNION CITY, NJ:
2,571,230, PUB. 2-26-2002. MULTIPLE CLASS, INT. CLS. 9 AND 41.
- HARRY J. BOSWORTH COMPANY, SKOKIE, IL:
2,571,478, PUB. 2-26-2002. INT. CL. 5.
- HARSCO TECHNOLOGIES CORPORATION, FAIRMONT, MN, STEEL SCAFFOLDING COMPANY, INC., THE, BROOKLYN, NY:
561,559, REN. 4-9-02. U.S. CL. 50 (INT. CL. 6).
- HARSCO TECHNOLOGIES CORPORATION, FAIRMONT, MN, HARSCO CORPORATION, WORMLEYSBURG, PA:
924,571, REN. 4-10-02. U.S. CL. 12 (INT. CL. 19).
- HARSCO TECHNOLOGIES CORPORATION, FAIRMONT, MN, SUPERIOR VALVE COMPANY, WASHINGTON, PA:
936,444, REN. 4-9-02. U.S. CL. 13 (INT. CL. 11).
- HARTFORD FIRE INSURANCE COMPANY, HARTFORD, CT:
2,570,633, PUB. 10-16-2001. INT. CL. 36.
2,571,007, PUB. 2-26-2002. INT. CL. 35.
- HARTFORD HOUSE, LTD., BOULDER, CO:
1,886,417, CANC. INT. CL. 42.
- HARTING KGAA, 32325 ESPELKAMP, FED REP GERMANY, HARTING ELEKTRONIK GMBH, 4992 ESPELKAMP, FED REP GERMANY:
1,674,063, REN. 4-9-02. INT. CL. 9.
- HARTZ & COMPANY, INC., FREDERICK, MD:
2,571,088, PUB. 2-26-2002. INT. CL. 25.
- HARVEY ENTERTAINMENT, INC., NEW YORK, NY FROM HARVEY COMICS, INC., LOS ANGELES, CA:
2,571,747, INT. CL. 28.
- HARVEY HUBBELL INCORPORATED, ORANGE, CT:
386,053, CANC. U.S. CL. 21.
- HASBRO DEVELOPMENT CORP., PAWTUCKET, RI:
713,094, CANC. U.S. CL. 22.
- HATCHER ENTERPRISES, LLC, BEDFORD, TX:
2,572,331, INT. CL. 36.
- HAWAII-PACIFIC APPAREL GROUP, INC., HONOLULU, HI:
1,886,129, CANC. INT. CL. 25.
- HAWAIIAN PACIFIC RESTAURANT GROUP, INC., HONOLULU, HI:
2,571,123, PUB. 2-26-2002. INT. CL. 41.
- HAWAIIAN RECTIFIERS, INC., MIRA LOMA, CA:
2,571,048, PUB. 2-26-2002. INT. CL. 33.
- HAWAIIAN SUN PRODUCTS, INC., HONOLULU, HI, AKA HAWAIIAN SUN PRODUCTS:
1,165,711, REN. 4-11-02. MULTIPLE CLASS, INT. CLS. 29, 30 AND 32.
- HD ELECTRIC COMPANY, WAUKEGAN, IL:
1,682,744, REN. 4-9-02. INT. CL. 9.
- HEADLIGHT SOFTWARE, INC., SEATTLE, WA:
2,571,682, PUB. 2-26-2002. INT. CL. 9.
- HEALING WITHOUT HATE ENTERPRISES, INC., UPLAND, CA:
2,570,694, PUB. 2-26-2002. INT. CL. 16.
- HEALTH CARE-ONE INSURANCE AGENCY, INC., SAN DIEGO, CA:
2,068,747, CANC. INT. CL. 36.
- HEALTH DESIGNS, INC., ROCHESTER, NY:
1,885,887, CANC. INT. CL. 9.
- HEALTH FOUNDATION OF GREATER INDIANAPOLIS, INC., THE, INDIANAPOLIS, IN:
2,570,830, PUB. 2-26-2002. INT. CL. 36.
- HEALTH INDUSTRY MANUFACTURERS ASSOCIATION, WASHINGTON, DC:
2,572,059, INT. CL. 42.
- HEALTHCARE MANAGEMENT ADVISORS, INC., ALPHARETTA, GA:
2,570,481, PUB. 2-26-2002. INT. CL. 16.
2,570,482, PUB. 2-26-2002. INT. CL. 16.
- HEALTHCARE TECHNOLOGY MARKETING, INC.:
See— HEALTHCARE TECHNOLOGY SYSTEMS, INC..
- HEALTHCARE TECHNOLOGY SYSTEMS, INC., MADISON, WI FROM HEALTHCARE TECHNOLOGY MARKETING, INC., MADISON, WI:
2,570,903, PUB. 2-26-2002. INT. CL. 42.
- HEALTHCOMMUNITIES.COM, INC., NORTHAMPTON, MA:
2,571,327, PUB. 2-26-2002. INT. CL. 42.
- HEALTHPARTNERS, INC., MINNEAPOLIS, MN:
2,571,200, PUB. 2-26-2002. INT. CL. 42.
- HEAR ME & CO., SAN FRANCISCO, CA:
2,570,678, PUB. 2-26-2002. MULTIPLE CLASS, INT. CLS. 41 AND 42.
- HEARST COMMUNICATIONS, INC., NEW YORK, NY:
2,572,035, INT. CL. 21.
- HEART FOODS COMPANY, INC., MINNEAPOLIS, MN:
1,885,789, CANC. INT. CL. 5.
- HEDSTROM CORPORATION, MT. PROSPECT, IL:
2,572,415, INT. CL. 16.
- HEEP TUNG MANUFACTORY, LTD., FO TAN, N.T., HONG KONG:
2,571,037, PUB. 2-26-2002. INT. CL. 28.
- HEINRICH KIPP WERK, 72172 SULZ, FED REP GERMANY:
2,570,754, PUB. 6-27-2000. MULTIPLE CLASS, INT. CLS. 7, 9, 20 AND 26.
- HEINZ WEYERMANN GMBH FARBMALZBIERBRAUEREI:
See— HEINZ WEYERMANN ROSATMALZBIEBRAUEREI BAMBERG GESELLSCHAFT MIT BERSCHRANKTER HAFTUNG.
- HEINZ WEYERMANN ROSATMALZBIEBRAUEREI BAMBERG GESELLSCHAFT MIT BERSCHRANKTER HAFTUNG, BAMBERG, FED REP GERMANY FROM HEINZ WEYERMANN GMBH FARBMALZBIERBRAUEREI, D-96052 BAMBERG, FED REP GERMANY:
2,570,735, PUB. 2-26-2002. INT. CL. 30.
- HELEN WOODHULL, INC., NEW YORK, NY:
1,149,752, CANC. INT. CL. 14.
- HELFTER FEEDS, INC., OSCO, IL:
2,571,620, PUB. 2-26-2002. INT. CL. 5.

- HELIX SOFTWARE COMPANY, INC., LONG ISLAND CITY, NY TO HELIX SOFTWARE COMPANY, INC., LONG ISLAND CITY, NY:
2,291,646, COR. INT. CL. 9.
- HELMUT FISCHER GMBH & CO., D-71069 SINDELFIN-GEN, FED REP GERMANY:
1,166,233. REN. 4-7-02. INT. CL. 9.
- HEM, INC., PRYOR, OK, HARRIS, GERALD R., HAYWARD, CA, DBA HARRIS ENGINEERING & MANUFACTURING COMPANY:
936,015. REN. 4-12-02. U.S. CL. 23 (INT. CL. 7).
- HENDERSON AQUATICS, INC., MILLVILLE, NJ:
2,572,363, INT. CL. 25.
- HENDREN, DAVID L., READING, OH:
1,886,598, CANC. INT. CL. 10.
- HENKEL KGAA, DUESSELDORF, FED REP GERMANY:
2,572,303, INT. CL. 3.
- HERAEUS INSTRUMENTS GMBH, 6450 HANAU AM MAIN, FED REP GERMANY:
1,638,982, CANC. INT. CL. 10.
- HERBERTZ, HEINZ, 8600 BAMBERG, FED REP GERMANY:
1,886,555, CANC. INT. CL. 9.
- HERCULES INCORPORATED, WILMINGTON, DE:
1,638,781, CANC. INT. CL. 1.
- HERGET, PATRICK R., WALLINGFORD, CT:
2,572,224, INT. CL. 28.
- HERM. SPRENGER GMBH & CO. KG, D-58644 ISERLOHN, FED REP GERMANY:
2,571,908, MULTIPLE CLASS, INT. CLS. 6 AND 18.
- HERMAN MILLER, INC., ZEELAND, MI:
1,149,732, CANC. INT. CL. 12.
- HERMAN SURVIVORS INC., ARMONK, NY:
2,571,854, MULTIPLE CLASS, INT. CLS. 18 AND 25.
- HERMES SCHLEIFMITTEL GMBH & CO., D-22547 HAMBURG, FED REP GERMANY:
2,571,151, PUB. 2-26-2002. INT. CL. 3.
- HERNDON PROPERTIES, L.L.C., ROME, GA:
2,570,671, PUB. 2-26-2002. INT. CL. 42.
- HEROKEE MANUFACTURING, INC., SOUTH ST. PAUL, MN FROM SCHUMACHER'S, INCORPORATED, SOUTH ST. PAUL, MN, DBA CHEROKEE MANUFACTURING:
2,571,860, INT. CL. 19.
- HERS, BALA CYNWYD, PA:
1,886,023, CANC. INT. CL. 16.
- HESTER INDUSTRIES, INC., MOREFIELD, WV:
1,149,972, CANC. INT. CL. 29.
- HEXCEL CORPORATION, DUBLIN, CA:
2,571,894, MULTIPLE CLASS, INT. CLS. 6 AND 17.
- HI-TEK RATIONS, INC., DUBLIN, GA:
2,571,656, PUB. 12-25-2001. INT. CL. 31.
- HICKS EQUIPMENT, INC., SWARTZ CREEK, MI:
2,571,008, PUB. 2-26-2002. MULTIPLE CLASS, INT. CLS. 9 AND 42.
- HIGHLAND IMPORT CORPORATION, MARLBORO, MA:
1,149,901, CANC. INT. CL. 25.
- HIGHLAND SUPPLY CORPORATION, HIGHLAND, IL:
1,885,797, CANC. MULTIPLE CLASS, INT. CLS. 6 AND 16.
- HILL, GREGORY, ATLANTA, GA:
2,571,609, PUB. 2-26-2002. INT. CL. 5.
- HILLWOOD DEVELOPMENT CORPORATION, DALLAS, TX, DBA HILLWOOD VENTURES:
2,572,097, MULTIPLE CLASS, INT. CLS. 37, 38 AND 42.
- HILLYARD ENTERPRISES, INC., ST. JOSEPH, MO:
2,571,134, PUB. 8-14-2001. INT. CL. 3.
- HIMES, HARRY C. J., MEADOWBROOK, PA:
2,571,001, PUB. 2-26-2002. INT. CL. 35.
- HIPBONE, INC., SAN CARLOS, CA FROM HIPBONE SOFTWARE, INC., SAN CARLOS, CA:
2,572,090, MULTIPLE CLASS, INT. CLS. 9 AND 42.
- HIRES ENTERPRISES, INC., SANDY, UT:
2,571,006, PUB. 2-26-2002. INT. CL. 42.
- HIT BRANDS, INC., SPARKS, NV:
1,886,169, CANC. INT. CL. 25.
- HITEC ASA, N-4033 FORUS, NORWAY:
2,571,765, MULTIPLE CLASS, INT. CLS. 9 AND 16.
- HOECHST AKTIENGESELLSCHAFT, FRANKFURT AM MAIN - 80, FED REP GERMANY:
1,149,534, CANC. INT. CL. 1.
- HOFFMAN PROMOTIONS, INC., OKLAHOMA CITY, OK:
2,571,094, PUB. 2-26-2002. INT. CL. 41.
- HOGAR CREA INTENACIONAL, INC., TRUJILLO ALTO, PUERTO RICO:
2,571,040, PUB. 2-26-2002. INT. CL. 42.
- HOHMANN & BARNARD, INC., HAUPPAUGE, NY:
2,571,272, PUB. 2-26-2002. INT. CL. 17.
- HOKE INCORPORATED, CRESSKILL, NJ:
1,638,899, CANC. INT. CL. 7.
- HOLDER PHILIP T., MORRISVILLE, PA:
2,572,419, INT. CL. 35.
- HOLIDAY TOGS, INC., BROOKLYN, NY:
1,149,903, CANC. INT. CL. 25.
- HOLLAND & HOLLAND LIMITED, NEW YORK, NY:
2,571,714, INT. CL. 18.
- HOLLAND AMERICAN WAFER COMPANY, GRAND RAPIDS, MI:
2,570,930, PUB. 2-26-2002. MULTIPLE CLASS, INT. CLS. 35 AND 39.
- HOLLAND WIRE PRODUCTS, INCORPORATED, HOLLAND, MI:
713,175, CANC. U.S. CL. 32.
713,176, CANC. U.S. CL. 32.
- HOLMES, SUE E., CITRUS HEIGHTS, CA:
2,571,437, PUB. 2-26-2002. INT. CL. 16.
- HOLY COW INC., MIDDLEBURY, VT:
1,639,040, CANC. INT. CL. 16.
- HOMEMAKERS, THE, OMAHA, NE:
2,570,549, PUB. 2-26-2002. MULTIPLE CLASS, INT. CLS. 35, 36 AND 42.
- HOMETEK INTERNATIONAL GROUP CORP., NAPERVILLE, IL:
2,571,613, PUB. 2-26-2002. INT. CL. 21.
- HOMETEX CORPORATION, SAN ANTONIO, TX:
2,571,392, PUB. 2-26-2002. INT. CL. 37.
2,571,394, PUB. 2-26-2002. INT. CL. 37.
- HOMEXAM, INC., OCEANSIDE, CA:
2,570,932, PUB. 2-26-2002. MULTIPLE CLASS, INT. CLS. 9 AND 16.
- HONDA GIKEN KOGYO KABUSHIKI KAISHA, MINATOKU, TOKYO, JAPAN, TA HONDA MOTOR CO., LTD.:
2,571,859, INT. CL. 12.
- HONEGGERS' & CO., INC., FAIRBURY, IL:
713,264, CANC. U.S. CL. 46.
- HONEY POT, INC., NEW YORK, NY:
2,570,687, PUB. 2-26-2002. INT. CL. 25.
- HONEYBERRY FARM, INC., KNOXVILLE, TN:
2,571,688, MULTIPLE CLASS, INT. CLS. 29 AND 30.
- HONEYWELL INTERNATIONAL INC., MORRISTOWN, NJ:
2,570,758, PUB. 2-26-2002. INT. CL. 27.
- HONEYWELL INTERNATIONAL INC., MORRISTOWN, NJ FROM ALLIEDSIGNAL INC., MORRISTOWN, NJ:
2,571,837, INT. CL. 9.
- HONOR PROPERTIES, LLC, DALLAS, TX:
2,571,211, PUB. 2-26-2002. INT. CL. 35.
- HOOS COMMUNICATIONS, INC.:
See—PLEASANT COMPANY.
- HOOSIER MAGNETICS, INC., TOLEDO, OH:
1,885,739, CANC. INT. CL. 1.
- HOPE FOR THE HEART, INC., DALLAS, TX:
2,570,753, PUB. 2-26-2002. MULTIPLE CLASS, INT. CLS. 16 AND 41.
- HORNBAKER, JEFFREY, MONTCLAIR, CA:
2,571,712, INT. CL. 9.
- HORNBY HOBBIES LIMITED, KENT, CT9 4JX, GREAT BRITAIN, MINIMODELS LIMITED, NEW LANE HAVANT, ENGLAND:
727,200. REN. 4-11-02. U.S. CL. 22 (INT. CL. 28).
- HORTON INSURANCE AGENCY, INC., ORLAND PARK, IL:
2,571,385, PUB. 2-26-2002. INT. CL. 42.
- HORWEEN LEATHER COMPANY, CHICAGO, IL:
1,696,232. REN. 4-6-02. INT. CL. 28.
- HOT SAM COMPANIES, INC., CLEVELAND, OH:
1,886,397, CANC. INT. CL. 42.

- HOT SHOTS INCORPORATED, NEW YORK, NY:
1,639,140, CANC. INT. CL. 25.
- HOUGHTON MIFFLIN COMPANY, BOSTON, MA:
2,570,958, PUB. 2-26-2002. INT. CL. 16.
2,570,959, PUB. 2-26-2002. INT. CL. 28.
2,570,968, PUB. 2-26-2002. INT. CL. 14.
- HOULIHAN, LOKEY, HOWARD & ZUKIN, INC., LOS ANGELES, CA:
2,572,272, INT. CL. 16.
- HOUSE OF BLUES BRANDS CORP., HOLLYWOOD, CA:
2,571,010, PUB. 2-26-2002. INT. CL. 35.
2,571,011, PUB. 2-26-2002. INT. CL. 41.
- HOUSEHOLD INTERNATIONAL, INC., PROSPECT HEIGHTS, IL:
1,886,301, CANC. INT. CL. 36.
- HOWARD BRINTON SEMINARS, INC., BOULDER, CO:
2,572,357, INT. CL. 41.
- HOWARD, PAUL S., FELTON, CA:
2,572,339, MULTIPLE CLASS, INT. CLS. 9 AND 41.
- HOWDY JONGRO KIMBAP INTERNATIONAL, INC., HARBOR CITY, CA:
2,570,650, PUB. 2-26-2002. MULTIPLE CLASS, INT. CLS. 30 AND 42.
- HOY, GENE, MIO, MI:
2,571,728, INT. CL. 3.
- HT USA, INC., ENGLEWOOD CLIFFS, NJ:
2,571,593, PUB. 2-26-2002. INT. CL. 12.
- HTZ INVESTMENT CORP., WILMINGTON, DE:
2,571,957, INT. CL. 5.
2,572,024, INT. CL. 5.
2,572,025, INT. CL. 5.
- HUBBELL INCORPORATED, ORANGE, CT, ALL-STEEL EQUIPMENT INC., AURORA, IL:
725,020, REN. 4-10-02. U.S. CL. 21 (INT. CL. 9).
- HUDSON'S BAY COMPANY, TORONTO, ONTARIO, CANADA, DBA HUDSON'S BAY COMPANY, GOVERNOR AND COMPANY OF ADVENTURERS OF ENGLAND TRADING INTO HUDSON'S BAY, THE, LONDON, UNITED KINGDOM:
291,639, REN. 4-11-02. U.S. CL. 42 (INT. CL. 24).
- HUGGIE AIDS, LTD., OKLAHOMA CITY, OK:
1,638,989, CANC. INT. CL. 10.
- HULL, S.M., SAN DIEGO, CA, DBA LADYBUG ART:
1,213,896, REN. 4-8-02. INT. CL. 16.
- HUMMERT INTERNATIONAL, INC., ST. LOUIS, MO:
1,886,756, CANC. MULTIPLE CLASS, INT. CLS. 31, 37, 39 AND 42.
- HUMPHREYS INC., CHICAGO, IL:
2,571,899, INT. CL. 18.
- HUNTER FAN COMPANY, MEMPHIS, TN:
2,572,165, INT. CL. 11.
2,572,166, INT. CL. 11.
- HUNTINGTON LABORATORIES, INC., HUNTINGTON, IN:
386,032, CANC. U.S. CL. 6.
- HUO, WILLIAM, NEW YORK, NY:
2,572,420, INT. CL. 42.
- HURCKMAN MECHANICAL INDUSTRIES, INC., GREENBAY, WI:
1,741,487, REN. 4-11-02. INT. CL. 28.
- HUTCHISON & MASON PLLC, RALEIGH, NC:
2,571,559, PUB. 2-26-2002. INT. CL. 42.
- HYAL PHARMACEUTICAL CORPORATION, MISSISSAUGA, ONTARIO, CANADA:
1,638,809, CANC. MULTIPLE CLASS, INT. CLS. 3 AND 5.
- HYDE SCHOOL, BATH, ME:
2,571,999, INT. CL. 41.
- HYDRO-THERMAL CORPORATION, WAUKESHA, WI:
2,572,174, INT. CL. 11.
- HYDROTEX PARTNERS, LTD., CARROLLTON, TX, HYDROTEX, INC., DALLAS, TX:
1,677,305, REN. 4-6-02. INT. CL. 4.
- HYPRO CORPORATION, NEW BRIGHTON, MN:
1,676,567, REN. 4-11-02. INT. CL. 7.
- I. APPEL CORPORATION, NEW YORK, NY:
1,886,174, CANC. INT. CL. 25.
- IA CORPORATION, EMERYVILLE, CA:
1,886,558, CANC. INT. CL. 9.
- IBI SYNERGY, INC., FREMONT, CA:
2,572,235, INT. CL. 10.
- IBILL TECHNOLOGIES, L.L.C., FORT LAUDERDALE, FL FROM APPSERV, INC., BOCA RATON, FL:
2,570,610, PUB. 2-26-2002. INT. CL. 38.
- ICC INNOVATIVE CONCEPTS CORPORATION, TORRINGTON, CT:
2,572,111, INT. CL. 8.
- ICELAND SEAFOOD CORPORATION, CAMP HILL, PA:
1,886,671, CANC. INT. CL. 29.
- ICHECKOUT, INC., AUSTIN, TX:
2,570,693, PUB. 2-26-2002. MULTIPLE CLASS, INT. CLS. 9 AND 35.
- ICI AMERICAS INC., WILMINGTON, DE TO AGRICULTURAL RETAILERS ASSOCIATION, WASHINGTON, DC:
1,674,603, CANC. INT. CL. 42.
- ICI AUSTRALIA OPERATIONS PROPRIETARY LIMITED:
See—ORICA AUSTRALIA PTY LTD.
- IDA CASON CALLAWAY FOUNDATION, PINE MOUNTAIN, GA:
921,345, AM. U.S. CL. 107.
- IDENTIX INCORPORATED, LOS GATOS, CA:
2,571,986, INT. CL. 9.
- IDEOPLASTOS, INC., HOLBROOK, NY, FORMERLY PAS-TIME INDUSTRIES, INC.:
2,571,120, PUB. 2-26-2002. INT. CL. 28.
- IDEOPLASTOS, INC., HOLBROOK, NY, FORMERLY PAS-TIME INDUSTRIES, INC.:
2,571,122, PUB. 2-26-2002. INT. CL. 28.
- IDX SYSTEMS CORPORATION, BURLINGTON, VT:
2,571,102, PUB. 2-26-2002. MULTIPLE CLASS, INT. CLS. 9, 37 AND 42.
- IEX CORPORATION, RICHARDSON, TX:
2,570,918, PUB. 2-26-2002. INT. CL. 9.
2,570,919, PUB. 2-26-2002. INT. CL. 9.
- IGATE HOLDING CORPORATION, WILMINGTON, DE FROM MASTECH TRADEMARK CORPORATION, WILMINGTON, DE:
2,572,003, MULTIPLE CLASS, INT. CLS. 35 AND 36.
- IGLESIAS, RAMON E., NORTH BERGEN, NJ:
1,885,780, CANC. INT. CL. 5.
- IGLOO PRODUCTS CORP., HOUSTON, TX:
1,886,632, CANC. INT. CL. 21.
- IHEAR SYSTEMS, DANVILLE, CA:
2,571,796, INT. CL. 10.
- IL MARCHESE COCCAPANI S.P.A., 41019 SOLIERA, MODENA, ITALY:
1,820,925, AM. INT. CL. 25.
- ILC DOVER, INC., FREDERICA, DE:
1,900,700, CANC. INT. CL. 21.
- ILLINOIS POWER COMPANY, DECATUR, IL:
2,528,813, COR. INT. CL. 42.
- ILLINOIS TOOL WORKS INC., GLENVIEW, IL:
2,570,813, PUB. 4-3-2001. INT. CL. 2.
2,571,450, PUB. 2-26-2002. INT. CL. 9.
- ILLUMINATION POLYMER TECHNOLOGIES, INC., NAPERVILLE, IL:
2,572,125, INT. CL. 9.
- IMAGEMAX, INC., CONSHOHOCKEN, PA:
2,571,813, INT. CL. 9.
- IMAGICAST, INC., BURLINGAME, CA:
2,572,017, INT. CL. 35.
- IMAGING AUTOMATION, INC., BEDFORD, NH:
2,571,430, PUB. 2-26-2002. INT. CL. 9.
- IMATRON, INC., SOUTH SAN FRANCISCO, CA:
2,571,046, PUB. 2-26-2002. INT. CL. 42.
- IMERYS PIGMENTS, INC., ROSWELL, GA, ANGLO-AMERICAN CLAYS CORPORATION, ATLANTA, GA:
1,189,052, REN. 4-12-02. INT. CL. 2.
- IMERYS PIGMENTS, INC., ROSWELL, GA:
2,572,052, INT. CL. 1.
- IMPACT IDEALSOLUTIONS, INC., DENVER, CO:
2,572,133, INT. CL. 35.
- IMPERIAL TOY CORPORATION, LOS ANGELES, CA:
1,886,186, CANC. INT. CL. 28.
- IMPROVED PIPING PRODUCTS, INC., ORINDA, CA:
1,885,804, CANC. INT. CL. 6.

IN OFFICE COFFEE SERVICE, INC., SECAUCUS, NY:
1,886,487, CANC. MULTIPLE CLASS, INT. CLS. 29, 30 AND 42.

INDIAN HEAD INDUSTRIES, CHARLOTTE, NC:
2,571,988, INT. CL. 9.

INDIANA MEMBERS CREDIT UNION, INDIANAPOLIS, IN:
2,571,953, INT. CL. 36.

INDOPCO, INC., BRIDGEWATER, NJ, DBA NATIONAL STARCH AND CHEMICAL COMPANY:
1,840,210, CANC. INT. CL. 1.

INDUSTRIA DE DISEÑO TEXTIL, S.A., 15080 CORUNA, SPAIN, AKA INDITEX, S.A.:
2,570,942, PUB. 2-26-2002. INT. CL. 34.

INDUSTRIA DE MEIAS SCALINA LTDA., SAO PAULO, BRAZIL:
2,571,734, INT. CL. 25.

INDUSTRIA FARMACEUTICA ANDROMACO, S.A. DE C.V., AMPLIACIO GRANADA, 11520, MEXICO:
1,885,775, CANC. INT. CL. 5.

INDUSTRIAL CHEMICAL PRODUCTS OF DETROIT, INC., LIVONIA, MI:
386,167, CANC. U.S. CL. 6.
386,168, CANC. U.S. CL. 6.

INDUSTRIAL DYNAMICS COMPANY, LTD., TORRANCE, CA:
2,570,850, PUB. 2-26-2002. INT. CL. 9.

INDUSTRIAL ELECTRONIC ENGINEERS, INC., VAN NUYS, CA:
1,886,565, CANC. INT. CL. 9.

INDUSTRIAL RECYCLING SYSTEMS CORPORATION, VICTORIA, B.C., CANADA:
2,571,736, INT. CL. 19.

INDUSTRIAL RUBBER DEVELOPMENT, INC., LODI, CA:
1,149,626, CANC. INT. CL. 7.

INDUSTRIAS ALIMENTARIAS DE NAVARRA, S.A., SAN ADRIAN NAVARRA, SPAIN:
2,354,485, COR. MULTIPLE CLASS, INT. CLS. 29 AND 30.

INDUSTRIAS ALIMENTICIAS NOEL S.A., MEDELLIN, COLOMBIA:
1,159,346, REN. 4-6-02. INT. CL. 30.

INDUSTRIAS ROMI S.A., SAO PAULO, BRAZIL:
1,885,821, CANC. INT. CL. 7.

INDUSTRIAS SALVER, S.A., GUADALAJARA, JALISCO, MEXICO:
1,198,928, REN. 4-10-02. INT. CL. 28.

INFECTION CONTROL PRODUCTS, INC., GARDENDALE, AL:
1,885,933, CANC. INT. CL. 10.

INFECTIOUS DISEASES ASSOCIATE, P.C., OMAHA, NE:
2,571,264, PUB. 2-26-2002. INT. CL. 42.

INFORMATION MANAGEMENT NETWORK, INC., NEW YORK, NY:
2,570,502, PUB. 4-21-1998. INT. CL. 41.

INFOTERIA INC., TOKYO, JAPAN:
2,570,761, PUB. 2-26-2002. INT. CL. 9.

INFRARED DYNAMICS, INC., COSTA MESA, CA:
2,572,237, INT. CL. 11.

INFRASTRUCTURE DEFENSE, INC., ALEXANDRIA, VA:
2,572,297, INT. CL. 42.

INGERSOLL-RAND COMPANY, WOODCLIFF LAKE, NJ:
2,572,101, INT. CL. 7.

INGOLD, JAMES EDWARD, JR., HILLSBOROUGH, NC:
2,571,567, PUB. 2-26-2002. INT. CL. 25.

INGRAM ENTERPRISES, INC., SPRINGFIELD, MO:
1,696,601, REN. 4-8-02. INT. CL. 42.

INLAND SEAS EDUCATION ASSOCIATION, SUTTONS BAY, MI:
2,571,027, PUB. 2-26-2002. INT. CL. 16.

INLAND STEEL COMPANY, CHICAGO, IL:
1,886,511, CANC. INT. CL. 6.

INNER CITY BROADCASTING CORPORATION, NEW YORK, NY:
2,570,606, PUB. 2-26-2002. INT. CL. 41.
2,570,607, PUB. 2-26-2002. INT. CL. 41.

INNER CITY BROADCASTING CORPORATION OF BERKELEY, SAN FRANCISCO, CA:
2,570,720, PUB. 2-26-2002. INT. CL. 41.

INNISFREE, INC., MIAMI, FL:
1,886,089, CANC. INT. CL. 21.

INNOVAGE MICROSYSTEMS INC., CALGARY, ALBERTA T2H 2S5, CANADA:
1,851,329, CANC. INT. CL. 9.

INNOVASIC, INC., ALBUQUERQUE, NM:
2,571,029, PUB. 9-18-2001. MULTIPLE CLASS, INT. CLS. 9, 40 AND 42.

INNOVATIVE EMERGENCY MANAGEMENT, INC., BATON ROUGE, LA:
2,571,328, PUB. 2-26-2002. MULTIPLE CLASS, INT. CLS. 35 AND 42.

INNOVATIVE SPORTS MANAGEMENT, PACIFIC PALISADES, CA:
2,571,719, MULTIPLE CLASS, INT. CLS. 25 AND 41.

INSCAPE PUBLISHING, INC., MINNEAPOLIS, MN:
2,571,117, PUB. 2-26-2002. INT. CL. 41.

INSTALLNET INTERNATIONAL, INC., CROFTON, MD:
2,571,309, PUB. 2-26-2002. INT. CL. 37.

INSTITUTE OF INTERNAL AUDITORS, ATLAMONTE SPRINGS, FL:
1,696,074, REN. 4-12-02. INT. CL. 16.
1,703,228, REN. 4-12-02. INT. CL. 16.

INSTITUTE OF PREVENTIVE MEDICINE, INC., DENVERVILLE, NJ:
1,639,297, CANC. INT. CL. 42.

INSTRUMENTARIUM SURGICAL CORP, INC., TERREBONNE QUEBEC, CANADA:
2,571,927, INT. CL. 10.

INSURANCE REGULATORY EXAMINERS SOCIETY, OLATHE, KS:
1,739,774, REN. 4-10-02. INT. CL. 16.

INTEGRA BIOSCIENCES AG, WALLISELLEN, SWITZERLAND:
2,571,070, PUB. 2-26-2002. INT. CL. 9.

INTEGRATED CIRCUIT SYSTEMS, INC., VALLEY FORGE, PA:
1,904,237, CANC. INT. CL. 9.

INTELICUS, L.C., OCOEE, FL:
2,570,953, PUB. 2-26-2002. INT. CL. 41.

INTER-INDUSTRY CONFERENCE ON AUTO COLLISION REPAIR, ROLLING MEADOWS, IL:
2,571,221, PUB. 2-26-2002. INT. CL. 41.

INTERACTIVE TRAINING, INC., BALTIMORE, MD:
2,571,823, INT. CL. 9.
2,571,824, INT. CL. 16.

INTERBANK CARD ASSOCIATION, NEW YORK, NY TO MASTERCARD INTERNATIONAL INCORPORATED, PURCHASE, NY:
1,186,117, AM. INT. CL. 36.

INTERCLEAN EQUIPMENT, INC., ANN ARBOR, MI:
2,571,900, INT. CL. 7.

INTERCOLLEGIATE TENNIS COACHES ASSOCIATION, SKILLMAN, NJ, DBA INTERCOLLEGIATE TENNIS ASSOCIATION:
1,740,688, REN. 4-9-02. INT. CL. 42.

INTERIOR CREATORS, INC., INDIANAPOLIS, IN:
1,885,753, CANC. INT. CL. 2.

INTERIOR SPACE, INC., ST. LOUIS, MO:
2,571,898, INT. CL. 42.

INTERLOGIX, INC., TUALATIN, OR:
2,571,228, PUB. 2-26-2002. INT. CL. 1.

INTERNATIONAL ASSOCIATION OF AIRPORT DUTY FREE STORES, INC., WASHINGTON, DC:
1,685,536, REN. 4-6-02. INT. CL. 35.

INTERNATIONAL BRACHYTHERAPY, S.A., 7180 SE-NEFFE, BELGIUM:
2,486,359, COR. INT. CL. 10.

INTERNATIONAL COMMERCE ONLINE NETWORK, LLC., HASBROUCK HEIGHTS, NJ:
2,571,582, PUB. 2-26-2002. INT. CL. 25.

INTERNATIONAL DATA GROUP, INC., FRAMINGHAM, MA:
2,570,540, PUB. 7-25-2000. INT. CL. 35.
2,570,597, PUB. 2-26-2002. INT. CL. 16.
2,571,407, PUB. 2-26-2002. INT. CL. 16.

- INTERNATIONAL EDUCATIONAL EXCHANGE SERVICES, INC., ITHACA, NY:
2,571,598, PUB. 2-26-2002. INT. CL. 36.
- INTERNATIONAL ETHNIC FOODS, INC., SPARKS, NV, DBA PASTA PRODUCTS COMPANY:
1,886,240, CANC. INT. CL. 30.
1,886,241, CANC. INT. CL. 30.
- INTERNATIONAL FLAVORS & FRAGRANCES INC., NEW YORK, NY:
2,571,326, PUB. 2-26-2002. MULTIPLE CLASS, INT. CLS. 1, 3 AND 30.
- INTERNATIONAL GAMCO, INC., OMAHA, NE:
1,679,536, REN. 4-10-02. INT. CL. 28.
- INTERNATIONAL HARVESTER COMPANY, CHICAGO, IL:
140,845, CANC. U.S. CL. 23.
- INTERNATIONAL HOUSE OF PANCAKES, INC., GLENDALE, CA:
1,737,261, REN. 4-8-02. INT. CL. 42.
- INTERNATIONAL JENSEN INCORPORATED, LINCOLNSHIRE, IL:
2,347,921, CANC. INT. CL. 9.
- INTERNATIONAL MARKETING SERVICES, INC., NORTH ANDOVER, MA:
2,570,673, PUB. 10-16-2001. MULTIPLE CLASS, INT. CLS. 9 AND 42.
- INTERNATIONAL MINERAL & CHEMICAL CORPORATION, NORTHBROOK, IL:
709,500, CANC. U.S. CL. 5.
- INTERNATIONAL PAPER COMPANY, TUXEDO, NY:
2,571,657, PUB. 2-26-2002. INT. CL. 16.
- INTERNATIONAL SLURRY SEAL ASSOCIATION, CHICAGO, IL:
1,149,825, CANC. INT. CL. 19.
- INTERNATIONAL SWEETS INC, PHOENIX, AZ:
2,572,211, INT. CL. 6.
- INTERNATIONAL TRUCK INTELLECTUAL PROPERTY COMPANY, LLC, WARRENVILLE, IL:
2,571,452, PUB. 2-26-2002. INT. CL. 36.
- INTERNATIONAL WALLCOVERINGS LIMITED, BAMA-LEA, ONTARIO, CANADA:
1,149,928, CANC. INT. CL. 27.
- INTERNATURAL DESIGNS, INC., MINNEAPOLIS, MN:
1,821,641, CANC. INT. CL. 35.
- INTERNET FLORIST ASSOCIATION, INC., ST. PAUL, MN:
2,572,298, MULTIPLE CLASS, INT. CLS. 35 AND 39.
- INTERNET HEADQUARTERS, INC., ROCHESTER, NY:
2,572,216, INT. CL. 35.
- INTERPUBLIC GROUP OF COMPANIES, INC., THE, NEW YORK, NY FROM TRUE NORTH COMMUNICATIONS INC., CHICAGO, IL:
2,572,260, INT. CL. 35.
- INTERSTATE BRANDS WEST CORPORATION, KANSAS CITY, MO, HOMESTEAD PROVISIONS, INC., SAN FRANCISCO, CA:
1,219,342, REN. 4-6-02. INT. CL. 30.
1,220,211, REN. 4-6-02. INT. CL. 30.
- INTERSTATE BRANDS WEST CORPORATION, KANSAS CITY, MO, INTERSTATE BRANDS COMPANY - LICENSING CO., KANSAS CITY, MO:
1,735,773, REN. 4-9-02. INT. CL. 30.
- INTERTEC PUBLISHING CORPORATION, OVERLAND PARK, KS:
2,572,284, INT. CL. 16.
- INTERTRUST TECHNOLOGIES CORPORATION, SANTA CLARA, CA:
2,571,716, INT. CL. 9.
- INTERWRAP INC., MISSION, BRITISH COLUMBIA V2V 6E4, CANADA:
2,571,365, PUB. 2-26-2002. INT. CL. 22.
- INVENTURE, INC., OMAHA, NE:
2,571,703, INT. CL. 41.
- INVERSIONE CHURRO MANIA C.A., PUERTO LA CRUZ, EDO. ANZOATEGUI, VENEZUELA:
2,571,789, INT. CL. 30.
- INVETECH COMPANY, DETROIT, MI:
1,639,068, CANC. MULTIPLE CLASS, INT. CLS. 16 AND 42.
- IOMEGA CORPORATION, ROY, UT:
2,570,514, PUB. 7-3-2001. INT. CL. 9.
- IOP PUBLISHING LIMITED, BRISTOL BS1 6BE, UNITED KINGDOM:
2,571,763, INT. CL. 42.
- IOWA DEPARTMENT OF TRANSPORTATION, AMES, IA:
2,571,588, PUB. 2-26-2002. INT. CL. 39.
- IPPOLITO, PETER M., AUSTIN, TX, DBA CGG DESIGNS:
2,571,799, INT. CL. 6.
- IPSO USA, INC., PANAMA CITY, FL:
2,571,562, PUB. 2-26-2002. INT. CL. 7.
- IRIS CERAMICA - SOCIETA' PER AZIONI, VIA GHIAROLA NUOVA, 119, ITALY:
2,571,059, PUB. 2-26-2002. INT. CL. 19.
- IRMA S. MANN, STRATEGIC MARKETING, INC., BOSTON, MA:
2,571,253, PUB. 2-26-2002. INT. CL. 35.
- IRON AGE CORPORATION, PITTSBURGH, PA:
949,859, REN. 4-10-02. U.S. CL. 39 (INT. CL. 9).
- IRON AGE CORPORATION, PITTSBURGH, PA, CHILDS CORPORATION, PITTSBURGH, PA:
1,212,263, REN. 4-11-02. INT. CL. 9.
- ISHIDA CO., LTD., SHOGOIN, SAKYO-KU 606, JAPAN, ISHIDA SCALES MFG. CO., LTD, SAKYO-KU, KYOTO, 606, JAPAN:
1,686,136, REN. 4-12-02. INT. CL. 9.
- ISKY, INC., COLUMBIA, MD FROM SKY ALLAND RESEARCH, COLUMBIA, MD:
2,572,262, MULTIPLE CLASS, INT. CLS. 35 AND 41.
- ISKY, INC., COLUMBIA, MD FROM SKY ALLAND RESEARCH, INC., COLUMBIA, MD:
2,572,269, INT. CL. 35.
- ISRAEL COLLOQUIUM, INC., THE, WALNUT CREEK, CA:
1,675,415, REN. 4-9-02. INT. CL. 41.
- ISTITUTO ITALIANO SPUMANTE METODO CLASSICO, 20122 MILAN, ITALY:
1,639,235, CANC. INT. CL. 33.
- ITOMAN NOHSUISAN KABUSHIKI KAISHA:
1,149,987, CANC. INT. CL. 31.
- ITT MANUFACTURING ENTERPRISES, INC., WILMINGTON, DE, INTERNATIONAL TELEPHONE AND TELEGRAPH CORPORATION, NEW YORK, NY:
1,189,121, REN. 4-6-02. MULTIPLE CLASS, INT. CLS. 7 AND 9.
- IVANKO BARBELL COMPANY, SAN PEDRO, CA:
1,201,283, REN. 4-10-02. INT. CL. 28.
- IVAR RIVENAES A/S, 5000 BERGEN, NORWAY:
1,149,523, CANC. MULTIPLE CLASS, INT. CLS. 1 AND 9.
- IWERKS ENTERTAINMENT, INC., BURBANK, CA:
1,886,481, CANC. MULTIPLE CLASS, INT. CLS. 28 AND 41.
- IXP CORP., LAWRENCEVILLE, NJ:
2,571,421, PUB. 2-26-2002. INT. CL. 35.
- J & J RANCH PRODUCE, INC., PALM DESERT, CA:
2,570,750, PUB. 2-26-2002. INT. CL. 31.
- J & M DIAMOND TOOL, INC., EAST PROVIDENCE, RI:
1,885,815, CANC. INT. CL. 7.
- J. M. NEY COMPANY, THE, BLOOMFIELD, CT:
1,886,069, CANC. INT. CL. 19.
- J. PERCY FOR MARVIN RICHARDS, LTD., NEW YORK, NY:
1,886,151, CANC. INT. CL. 25.
- J. W. STANNARD COMPANY, LARGO, FL:
1,876,684, CANC. INT. CL. 21.
- J.A. SEXAUER, INC., WHITE PLAINS, NY, J. A. SEXAUER MFG. CO., INC., WHITE PLAINS, NY:
941,244, REN. 4-12-02. U.S. CL. 13 (INT. CL. 6).
- J.A. STYERS, LLC, NORTHVILLE, MI:
2,571,803, MULTIPLE CLASS, INT. CLS. 25 AND 41.
- J.C. TAYLOR ANTIQUE AUTOMOBILE AGENCY, INC., UPPER DARBY, PA:
2,571,139, PUB. 2-26-2002. INT. CL. 36.
- J.R. SIMPLOT COMPANY, BOISE, ID, VALLEY NITROGEN PRODUCERS, INC., FRESNO, CA:
928,967, REN. 4-10-02. U.S. CL. 10 (INT. CL. 1).
- J.T. INDUSTRIES, SANTA ANA, CA TO J.T. INDUSTRIES, SANTA ANA, CA:
2,509,483, COR. INT. CL. 5.

- J.W. HARRIS CO., INC., MASON, OH:
2,571,992, INT. CL. 9.
- J&J SNACK FOODS CORP., PENNSAUKEN, NJ:
2,570,927, PUB. 2-26-2002. INT. CL. 30.
- JA-MAR APPAREL MFG. CO., INC., IRWINDALE, CA:
1,867,873, CANC. INT. CL. 25.
- JACAM CHEMICAL PARTNERS, LIMITED, STERLING, KS:
1,666,336, REN. 4-6-02. INT. CL. 1.
- JACK DANIEL'S PROPERTIES, INC., SAN RAFAEL, CA:
2,572,051, INT. CL. 33.
- JACK LA LANNE COMPANY, THE, LOS ANGELES, CA:
713,092, CANC. U.S. CL. 22.
- JACK SCHWARTZ SHOES, INC., NEW YORK, NY:
1,656,334, REN. 4-10-02. INT. CL. 25.
- JACKSON, ARNOLD S., LOS ANGELES, CA:
1,886,381, CANC. INT. CL. 41.
- JACKSON, BARRY MARTIN, MURRYSVILLE, PA, DBA THE SYNERGY CHANNEL:
2,571,668, PUB. 2-26-2002. INT. CL. 35.
- JACOBSON, CORINNE, TUSTIN, CA:
2,571,402, PUB. 2-26-2002. INT. CL. 5.
- JAI A/S, DK-2600 GLOSTRUP, DENMARK:
2,570,857, PUB. 2-26-2002. INT. CL. 9.
- JAKKS PACIFIC, INC., MALIBU, CA:
2,571,162, PUB. 2-26-2002. INT. CL. 28.
- JAMDAT MOBILE INC., SANTA MONICA, CA:
2,571,176, PUB. 2-26-2002. INT. CL. 41.
- JAMES MARTIN & CO., INC., RESTON, VA:
1,886,752, CANC. MULTIPLE CLASS, INT. CLS. 41 AND 42.
- JAMES, BRENT R., MANHATTAN BEACH, CA:
1,886,176, CANC. INT. CL. 25.
- JAMISON GROUP, LAKE MARY, FL:
2,571,057, PUB. 2-26-2002. MULTIPLE CLASS, INT. CLS. 16 AND 35.
- JANTZEN; WILLIAM J., NEW YORK, NY AND BLESSEY; ROBERT L., NEW YORK, NY:
713,232, CANC. U.S. CL. 39.
- JASON INCORPORATED, CONOVER, NC:
2,572,176, INT. CL. 7.
- JBI, INC., CANTON, MA:
1,886,173, CANC. INT. CL. 25.
- JENERIC/PENTRON INCORPORATED, WALLINGFORD, CT:
2,571,987, MULTIPLE CLASS, INT. CLS. 5 AND 7.
- JENMARCO, INC., MCCORDSVILLE, IN:
2,571,237, PUB. 2-26-2002. INT. CL. 42.
- JENNINGS, GARRETT, VENTURA, CA:
1,886,233, CANC. INT. CL. 30.
- JEPPESEN SANDERSON, INC., ENGLEWOOD, CO:
2,572,251, INT. CL. 16.
- JET WORKS AVIATION, INC., FORT WORTH, TX:
2,571,311, PUB. 2-26-2002. INT. CL. 37.
- JETBLADE VENTURES, INC., EL CERRITO, CA:
2,571,347, PUB. 2-26-2002. INT. CL. 35.
- JEWELCOR INCORPORATED, WILKES-BARRE, PA:
1,150,057, CANC. INT. CL. 42.
- JEWELL, JIM, DURHAM, NH:
2,571,961, INT. CL. 20.
- JIANGSU SILK IMPORT & EXPORT GROUP CORPORATION, NANJING, CHINA:
2,570,950, PUB. 2-26-2002. INT. CL. 25.
- JIFFY PRODUCTS INTERNATIONAL LTD., 6300 ZUG, SWITZERLAND:
931,054, REN. 4-6-02. U.S. CL. 2 (INT. CL. 31).
- JK-JOSEF KRATZ GMBH, D-5469 WINDHAGEN, FED REP GERMANY:
1,886,482, CANC. MULTIPLE CLASS, INT. CLS. 10 AND 11.
- JOBERVE LIMITED, TIPTREE, ESSEX, UNITED KINGDOM:
2,480,300, COR. INT. CL. 35.
- JOE PICASSO'S, INC., FORT LAUDERDALE, FL:
2,571,318, PUB. 2-26-2002. MULTIPLE CLASS, INT. CLS. 35 AND 41.
- JOHN HOLMES PUBLISHING COMPANY, WHITING, IA:
2,570,900, PUB. 2-26-2002. INT. CL. 37.
- JOHN MORRELL & CO.:
See— JONMOR INVESTMENTS, INC..
- JOHN PAUL MITCHELL SYSTEMS, SANTA CLARITA, CA:
1,638,823, CANC. INT. CL. 3.
- JOHN WILEY & SONS, INC., NEW YORK, NY, NATIONAL TRUST FOR HISTORIC PRESERVATION IN THE UNITED STATES, WASHINGTON, DC:
1,201,041, REN. 4-10-02. INT. CL. 16.
- JOHNSON & JOHNSON, NEW BRUNSWICK, NJ:
2,571,766, INT. CL. 5.
- JOMED GMBH, FED REP GERMANY:
2,570,962, PUB. 2-26-2002. INT. CL. 10.
- JONES FIRE PROTECTION, INC., CARLSBAD, CA:
2,571,550, PUB. 2-26-2002. INT. CL. 37.
- JONES, GARY, PLANO, IL:
1,886,136, CANC. INT. CL. 25.
- JONMOR INVESTMENTS, INC., WILMINGTON, DE, JOHN MORRELL & CO., CHICAGO, IL:
1,210,789, REN. 4-8-02. INT. CL. 29.
- JONMOR INVESTMENTS, INC., WILMINGTON, DE FROM JOHN MORRELL & CO., CINCINNATI, OH:
2,572,236, INT. CL. 29.
- JORGE MAURER FITNESS, INC., BEVERLY HILLS, CA:
2,572,406, MULTIPLE CLASS, INT. CLS. 9, 16 AND 41.
- JOSE JULIO JORDAO, LDA, 4802 GUIMARAES CODEX, PORTUGAL:
2,572,170, INT. CL. 11.
- JOSEPH C. GILARDONE & SON, INC., VIRGINVILLE, PA:
1,886,654, CANC. INT. CL. 25.
- JOSLIN DIABETES CENTER, INC., BOSTON, MA:
2,571,147, PUB. 10-30-2001. MULTIPLE CLASS, INT. CLS. 41 AND 42.
- JOYCE BERTRAM, INC., HOUSTON, TX:
918,242, REN. 4-8-02. U.S. CL. 101 (INT. CL. 35).
- JOYCE CHEN, INC., BILLERICA, MA:
2,571,844, INT. CL. 21.
- JUDITH, ANODEA, SEBASTOPOL, CA:
2,571,661, PUB. 2-26-2002. INT. CL. 41.
- JULIUS SAMANN LTD, HAMILTON HM CX, BERMUDA:
1,638,802, CANC. INT. CL. 3.
- JUMBERCA, S.A., BADALONA, BARCELONA, SPAIN:
930,451, REN. 4-10-02. U.S. CL. 23 (INT. CL. 7).
- JUNGLE LABORATORIES CORPORATION, CIBOLO, TX:
2,381,023, COR. INT. CL. 5.
- JUNO OF CALIFORNIA, BALDWIN PARK, CA:
2,571,416, PUB. 2-26-2002. INT. CL. 25.
- JWI LTD., KANATA ONTARIO, CANADA:
1,149,608, CANC. INT. CL. 7.
- K VALLEY ORTHOPEDICS, P.C., KALAMAZOO, MI:
2,571,316, PUB. 2-26-2002. INT. CL. 41.
- K&N ENGINEERING, INC., RIVERSIDE, CA:
2,570,869, PUB. 2-26-2002. INT. CL. 7.
- K-LINE INDUSTRIES, INC., HOLLAND, MI:
1,736,090, REN. 4-6-02. INT. CL. 7.
- K-SWISS INC., WESTLAKE VILLAGE, CA:
2,572,115, INT. CL. 25.
- K-2 CORPORATION, VASHON, WA, ANTHONY INDUSTRIES, INC., LOS ANGELES, CA:
1,744,540, REN. 4-6-02. MULTIPLE CLASS, INT. CLS. 18, 25 AND 28.
- KABUSHIKI KAISHA TOKYO KIKAI SEISAKUSHO, MINATO-KU, TOKYO, JAPAN:
2,570,665, PUB. 2-26-2002. INT. CL. 37.
- KAHN LAW GROUP (A PROFESSIONAL LAW CORPORATION):
See— KAHN-GAUTHIER LAW GROUP, L.L.C..
- KAHN-GAUTHIER LAW GROUP, L.L.C., METAIRIE, LA FROM KAHN LAW GROUP (A PROFESSIONAL LAW CORPORATION), METAIRIE, LA:
2,572,322, INT. CL. 42.
- KAKADE, ASHOK M., HAYWARD, CA:
2,571,074, PUB. 2-26-2002. MULTIPLE CLASS, INT. CLS. 37 AND 42.
- KALAMAZOO AVIATION HISTORY MUSEUM, THE, KALAMAZOO, MI:
2,571,784, INT. CL. 41.

- KALEIDOSCOPE SPORTS & ENTERTAINMENT L.L.C., NEW YORK, NY:
2,571,626, PUB. 2-26-2002. INT. CL. 9.
- KALMBACH PUBLISHING CO., WAUKESHA, WI:
1,739,817, REN. 4-9-02. INT. CL. 16.
- KALTENBACH & VOIGT GMBH & CO., D-88400 BIBERACH, FED REP GERMANY:
2,570,645, PUB. 2-26-2002. MULTIPLE CLASS, INT. CLS. 10 AND 20.
- KANAL MUELLER GRUPPE INTERNATIONAL, GMBH & CO. KG, 4938 SCHIEDER-SCHAWLENBERG 2, FED REP GERMANY:
1,886,036, CANC. INT. CL. 17.
- KANAS, DAVID C., CARSON CITY, NV:
1,885,938, CANC. INT. CL. 10.
- KAOZ, PENSACOLA, FL:
2,571,600, PUB. 2-26-2002. INT. CL. 42.
- KARBACH HOLDINGS CORPORATION, HIGHLAND, IN:
2,571,526, PUB. 2-26-2002. INT. CL. 27.
- KARL SCHNELL GMBH & CO., 73650 WINTERBACH, FED REP GERMANY:
1,676,576, REN. 4-7-02. INT. CL. 7.
- KARL SCHNELL GMBH & CO., D-7065 WINTERBACH, FED REP GERMANY:
1,676,577, REN. 4-7-02. INT. CL. 7.
- KATE SHIFRIN STYLE CONSULTANTS, INC., CHICAGO, IL:
2,571,312, PUB. 2-26-2002. INT. CL. 42.
- KATURA INCORPORATED, COLTON, CA:
2,571,681, PUB. 2-26-2002. INT. CL. 28.
- KATZ, MATTHEW, MALIBU, CA:
1,886,382, CANC. INT. CL. 41.
- KAVAZEN INC., BERKELEY, CA:
2,572,226, MULTIPLE CLASS, INT. CLS. 5 AND 32.
- KAWAI, TAKEO, YOKOHAMA-SHI, JAPAN:
2,491,673, COR. INT. CL. 42.
- KAY, LARRY, LOS GATOS, CA FROM KAY, LARRY, LOS GATOS, CA:
2,571,711, INT. CL. 9.
- KAYSER-ROTH CORPORATION, GREENSBORO, NC:
2,571,294, PUB. 2-26-2002. INT. CL. 25.
2,572,289, INT. CL. 25.
- KAZOO3D PLC, SHEFFIELD S10 2LJ, UNITED KINGDOM:
2,572,091, INT. CL. 9.
- KCI COMMUNICATIONS, INC., MCLEAN, VA, NATIONAL INFORMATION CORPORATION, ALEXANDRIA, VA:
1,653,645, REN. 4-11-02. INT. CL. 16.
- KCTS TELEVISION, SEATTLE, WA:
2,571,700, INT. CL. 9.
- KEENPEX, INC., INDUSTRY, CA:
1,886,269, CANC. INT. CL. 35.
- KELEDJIAN, VIKEN, LOS ANGELES, CA:
1,584,562, REN. 4-9-02. INT. CL. 14.
- KEMI LABORATORIES, INC., COLUMBIA, MD:
1,885,761, CANC. INT. CL. 3.
1,885,762, CANC. INT. CL. 3.
- KENNAMETAL INC., LATROBE, PA:
1,168,067, REN. 4-11-02. INT. CL. 7.
- KENNAMETAL TC INC., MONROVIA, CA, KENNAMETAL INC., LATROBE, PA:
1,166,160, REN. 4-11-02. INT. CL. 7.
- KENZO, 75001 PARIS, FRANCE:
2,571,219, PUB. 2-26-2002. INT. CL. 3.
- KERAVISION, INC., FREMONT, CA:
2,572,088, INT. CL. 10.
- KGA ENGINEERING COMPANY, INC., LIBERTYVILLE, IL:
1,716,450, REN. 4-10-02. INT. CL. 36.
- KIDGENIUS COMPANY, THE, AUSTIN, TX:
2,570,574, PUB. 2-26-2002. INT. CL. 35.
- KIMBERLY-CLARK CORPORATION, NEENAH, WI:
1,690,018, REN. 4-6-02. INT. CL. 10.
1,690,019, REN. 4-6-02. INT. CL. 10.
- KIMCO CORPORATION, NORRIDGE, IL:
1,686,752, REN. 4-6-02. INT. CL. 37.
1,694,869, REN. 4-6-02. INT. CL. 37.
- KING HENRY'S, INC., BEAVERTON, OR:
2,570,660, PUB. 2-26-2002. MULTIPLE CLASS, INT. CLS. 29, 30 AND 31.
- KING'S MESSENGERS QUARTET, THE, MURRAYVILLE, GA:
1,886,365, CANC. INT. CL. 41.
- KINGSTON-MIAMI TRADING CO., MIAMI, FL:
2,571,721, MULTIPLE CLASS, INT. CLS. 29, 30 AND 32.
2,572,268, MULTIPLE CLASS, INT. CLS. 29 AND 30.
- KIRKBI AG, SWITZERLAND:
2,570,989, PUB. 2-26-2002. INT. CL. 28.
- KIRKBI AG, CH-6340, BAAR, SWITZERLAND:
2,572,021, INT. CL. 28.
- KIRSCHNER MEDICAL CORPORATION, TIMONIUM, MD:
1,885,934, CANC. INT. CL. 10.
- KISTLER-MORSE CORPORATION, BOTHELL, WA:
2,571,699, INT. CL. 9.
- KITCHEN WHORE RECORDS, SAN JOSE, CA:
2,570,584, PUB. 2-26-2002. INT. CL. 41.
- KLEINERT'S INC., KUTZTOWN, PA:
140,859, CANC. U.S. CL. 39.
- KLR, INC., NEW YORK, NY:
1,886,630, CANC. INT. CL. 21.
1,886,631, CANC. INT. CL. 21.
1,886,795, CANC. INT. CL. 21.
- KMART PROPERTIES, INC., TROY, MI:
1,886,222, CANC. INT. CL. 30.
- KNISE, DAVID J., NORWALK, CT, DBA MICROTRAINING PLUS:
1,886,351, CANC. INT. CL. 41.
- KNOWLEDGE KIDS ENTERPRISES, INC. DBA LEAPFROG:
See—LEAPFROG ENTERPRISES, INC..
- KONINKLIJKE PHILIPS ELECTRONICS N.V., EINDHOVEN, NETHERLANDS FROM PHILIPS ELECTRONICS N.V., EINDHOVEN, NETHERLANDS:
2,570,492, PUB. 5-5-1998. INT. CL. 10.
- KONINKLIJKE PHILIPS ELECTRONICS N.V., EINDHOVEN, NETHERLANDS:
2,570,945, PUB. 2-26-2002. INT. CL. 9.
- KOPPARBERGS BRYGGERI AB, 714 35 KOPPARBERG, SWEDEN:
2,570,508, PUB. 2-26-2002. MULTIPLE CLASS, INT. CLS. 32 AND 33.
- KORET OF CALIFORNIA, INC., OAKLAND, CA:
2,570,640, PUB. 2-26-2002. INT. CL. 25.
- KOZORA, JOSEPH W., VALENCIA, PA:
1,903,404, CANC. INT. CL. 9.
- KRAFT GENERAL FOODS, INC., NORTHFIELD, IL:
1,864,843, CANC. INT. CL. 30.
1,886,673, CANC. INT. CL. 29.
- KRAVET FABRICS, INC., BETHPAGE, NY:
2,571,650, PUB. 2-26-2002. INT. CL. 20.
- KROHN, RABBI YEHOASHUA, MONSEY, NY:
2,570,737, PUB. 2-26-2002. INT. CL. 42.
- KRONOS INCORPORATED, CHELMSFORD, MA, SHOP-TRAC DATA COLLECTION SYSTEMS, INC., CALABASAS, CA:
1,702,996, REN. 4-8-02. INT. CL. 9.
- KTX CO., LTD., KONAN-SHI, AICHI-KEN, 483-8111, JAPAN:
2,572,358, INT. CL. 7.
- KUA'AINA SANDWICH CORPORATION, HALEIWA, HI:
1,714,538, REN. 4-12-02. INT. CL. 42.
- KUDU COMPANY FOR FOOD & CATERING, RIYADH 11553, SAUDI ARABIA:
2,570,644, PUB. 6-26-2001. INT. CL. 29.
- KULBER, CAROLE DEVOGLE, SANTA MONICA, CA:
2,571,026, PUB. 2-26-2002. INT. CL. 25.
- KURARAY CO., LTD., KURASHIKI CITY, OKAYAMA PREFECTURE, JAPAN:
1,189,035, REN. 4-9-02. MULTIPLE CLASS, INT. CLS. 1 AND 17.
- KVAERNER PROCESS SYSTEMS AS, BILLINGSTAD, NORWAY:
2,571,707, INT. CL. 11.
- L & S ENTERPRISES, INC., LEXINGTON, KY:
2,572,056, INT. CL. 11.
- L. B. FOSTER COMPANY, INC., PITTSBURGH, PA:
713,026, CANC. U.S. CL. 14.
- L. KEE & CO., INC., SOUTH SAN FRANCISCO, CA:
2,572,030, MULTIPLE CLASS, INT. CLS. 20 AND 24.

- L.G. LION & CO., INC., NEW YORK, NY:
2,571,359, PUB. 2-26-2002. INT. CL. 26.
2,571,360, PUB. 2-26-2002. INT. CL. 26.
- L.M. VAN MOPPES & SONS DIAMOND TOOLS LIMITED,
STAFFORD, ST16 1EA, ENGLAND:
1,885,766, CANC. INT. CL. 3.
- L&N FEDERAL CREDIT UNION, LOUISVILLE, KY:
2,570,643, PUB. 3-7-2000. INT. CL. 36.
- L-COM, INC., NORTH ANDOVER, MA:
1,691,214, REN. 4-9-02. INT. CL. 9.
- L'OREAL, 75008 PARIS, FRANCE:
2,570,571, PUB. 2-26-2002. INT. CL. 3.
2,570,572, PUB. 2-26-2002. INT. CL. 3.
- L'OREAL USA CREATIVE, INC., NEW YORK, NY FROM
COSMAIR CREATIVE, INC., NEW YORK, NY:
2,572,082, INT. CL. 3.
- L'OREAL USA, INC., NEW YORK, NY FROM AMETHYST
INVESTMENT GROUP, INC., CHICAGO, IL:
2,571,963, INT. CL. 3.
- LA ROSA DEL MONTE EXPRESS INC., BRONX, NY FROM
MONTI VAN LINES, INC., MEDLEY, FL:
2,571,628, PUB. 2-26-2002. INT. CL. 39.
- LABORATOIRES CELLORGAN SA, ST. DENIS, SWITZER-
LAND:
1,149,566, CANC. INT. CL. 5.
- LABORATOIRES SUISSES, PANAMA CITY, PANAMA:
2,571,756, MULTIPLE CLASS, INT. CLS. 3 AND 10.
- LACKOVIC, VICTORIA, NEW BRITAIN, PA, TA VICTORIA
JAMES DESIGNS:
1,639,359, CANC. INT. CL. 14.
- LACLEDE, INC., RANCHO DOMINGUEZ, CA. LACLEDE
PROFESSIONAL PRODUCTS, INC., RANCHO DOMIN-
QUEZ, CA:
1,739,407, REN. 4-10-02. INT. CL. 5.
- LADD FURNITURE, INC., GREENSBORO, NC:
2,570,983, PUB. 2-26-2002. INT. CL. 20.
- LADOVE, INC., HIALEAH, FL:
2,571,356, PUB. 2-26-2002. INT. CL. 3.
- LADYWORKS, INC., POOLESVILLE, MD:
1,886,180, CANC. INT. CL. 26.
- LAFAYETTE, DOUGLAS L., WEST HARTFORD, CT:
2,572,104, INT. CL. 36.
- LAINÉ, DEBRA, CLOQUET, MN AND LAINÉ, BURTON,
CLOQUET, MN:
2,572,190, INT. CL. 16.
- LAMART CORPORATION, CLIFTON, NJ:
939,291, REN. 4-6-02. U.S. CL. 1 (INT. CL. 17).
942,174, REN. 4-6-02. U.S. CL. 1 (INT. CL. 17).
943,057, REN. 4-10-02. U.S. CL. 1 (INT. CL. 17).
- LAMB COMPONENTS, INC., UPLAND, CA:
1,636,827, REN. 4-9-02. INT. CL. 12.
- LANCASTER COLONY CORPORATION, NEW YORK, NY:
1,149,857, CANC. INT. CL. 21.
- LAND & SKY, INC., LINCOLN, NE:
1,675,113, REN. 4-9-02. INT. CL. 20.
- LAND O'FROST, INC., LANSING, IL:
927,409, CANC. U.S. CL. 46.
- LANDRY'S TRADEMARK, INC., WILMINGTON, DE:
2,571,816, INT. CL. 25.
- LANDS' END, INC., DODGEVILLE, WI:
1,886,438, CANC. INT. CL. 42.
- LANE, GEORGE W., JR., SONOMA, CA:
1,639,233, CANC. INT. CL. 32.
- LANGE GRAPHICS, INC., DENVER, CO:
1,886,455, CANC. INT. CL. 42.
- LANSINOH LABORATORIES, INC., ALEXANDRIA, VA:
2,571,275, PUB. 2-26-2002. MULTIPLE CLASS, INT. CLS. 3
AND 4.
- LARAGH, JOHN H., GOLF, FL:
2,572,114, INT. CL. 42.
- LARRY LATHAM AUCTIONEERS, INC., SCOTTSDALE,
AZ:
2,570,601, PUB. 6-19-2001. INT. CL. 35.
- LARSEN, DONNA R., SAN DIEGO, CA:
2,571,698, MULTIPLE CLASS, INT. CLS. 9 AND 41.
- LARSEN, JANE, ALLENTOWN, PA, CHROMIAK, JANE,
ALLENTOWN, PA, TA WALKERCISE ENTERPRISES:
1,601,473, REN. 4-8-02. INT. CL. 41.
- LATIN AMERICAN ELECTRONIC COMMUNITY & IN-
FORMATION NETWORK, LLC, MIAMI, FL:
2,474,872 NEW CERT. 5-21-2002. INT. CL. 42.
- LATTICE COMMUNICATIONS, LLC, CINCINNATI, OH:
2,571,533, PUB. 2-26-2002. MULTIPLE CLASS, INT. CLS.
9, 37 AND 38.
- LAUVER, FRED J., CAMP HILL, PA:
2,571,555, PUB. 2-26-2002. INT. CL. 35.
- LAWLER FOODS, LTD., HUMBLE, TX, LAWLER FOODS,
INC., HUMBLE, TX:
1,605,809, REN. 4-9-02. INT. CL. 30.
- LAWTER INTERNATIONAL, INC., PLEASANT PRAIRIE,
WI:
2,571,473, PUB. 2-26-2002. INT. CL. 1.
- LCC INCORPORATED, ARLINGTON, VA:
1,886,569, CANC. INT. CL. 9.
- LDOS COMMUNICATIONS, INC., JACKSON, MS:
1,886,339, CANC. INT. CL. 38.
- LE CRAVATTE DI PANCALDI S.R.L., 40128 BOLOGNA,
ITALY, PANCALDI; VITALIANO, BOLOGNA, ITALY:
1,187,777, REN. 4-11-02. INT. CL. 25.
- LEA, ROSEMARY L., BIG BEAR LAKE, CA:
2,572,172, INT. CL. 41.
- LEAD DATA TECHNOLOGIES, INC., NANUET, NY:
2,570,870, PUB. 2-26-2002. INT. CL. 42.
- LEADER'S HOLDING COMPANY, CLEARWATER, FL:
2,571,172, PUB. 2-26-2002. INT. CL. 20.
- LEADING EDGE PRODUCTS, INC., WESTBOROUGH, MA:
1,886,590, CANC. INT. CL. 9.
- LEANLOGISTICS, INC., HOLLAND, MI FROM LEANLO-
GISTICS.COM, HOLLAND, MI:
2,571,944, INT. CL. 39.
2,572,109, INT. CL. 39.
- LEAPFROG ENTERPRISES, INC., EMERYVILLE, CA FROM
KNOWLEDGE KIDS ENTERPRISES, INC., EMERYVILLE,
CA, DBA LEAPFROG:
2,571,177, PUB. 2-26-2002. INT. CL. 9.
- LEARNING MEDIA LIMITED, WELLINGTON, NEW ZEAL-
AND:
2,572,309, INT. CL. 16.
- LEARNING RESEARCH, INC., EVANSVILLE, IN:
1,886,757, CANC. MULTIPLE CLASS, INT. CLS. 9 AND
16.
- LEASECOMM CORPORATION, WALTHAM, MA:
1,886,299, CANC. INT. CL. 36.
- LECO CORPORATION, ST. JOSEPH, MI:
1,723,512, REN. 4-6-02. INT. CL. 9.
- LEE MASONRY PRODUCTS, LLC, BOWLING GREEN, KY:
2,571,222, PUB. 2-26-2002. INT. CL. 19.
- LEE, LELA, LOS ANGELES, CA, DBA GORILLA PRODUC-
TIONS:
2,570,641, PUB. 2-26-2002. MULTIPLE CLASS, INT. CLS.
16 AND 41.
- LEEN & ASSOCIATES, INC., BELLEVUE, WA:
2,572,311, INT. CL. 9.
- LEGACY CAPITAL GROUP CALIFORNIA, LOS ALTOS, CA:
2,572,151, INT. CL. 36.
- LEGAL DOCUMENTS FOR LESS, INC., PALERMO, ME:
2,571,543, PUB. 2-26-2002. INT. CL. 42.
- LENDER'S SERVICE, INC., CORAOPOLIS, PA:
2,572,248, MULTIPLE CLASS, INT. CLS. 36 AND 42.
- LENG HENG AGRICULTURE FOODS CO., LTD., PATHUMTHANI
12120, THAILAND:
2,571,755, MULTIPLE CLASS, INT. CLS. 29 AND 30.
- LENOX, INCORPORATED, LAWRENCEVILLE, NJ:
1,639,005, CANC. INT. CL. 11.
- LENTEX OF NORTH AMERICA, INC., WESTPORT, CT:
1,886,519, CANC. INT. CL. 7.
- LENZING AKTIENGESELLSCHAFT, A-4860 LENZING,
AUSTRIA:
1,869,637, CANC. MULTIPLE CLASS, INT. CLS. 23, 24
AND 25.
- LEO GROUP, INC. THE, CHICAGO, IL TO LEO GROUP,
INC. THE, CHICAGO, IL:
2,465,068, COR. INT. CL. 35.
- LEO LAMMERTZ, NADELFABRIK GMBH & CO. KG,
AACHEN, FED REP GERMANY:
1,149,922, CANC. INT. CL. 26.

- LEONARD STORCH ENTERPRISES, INC., NEW YORK, NY:
1,149,790, CANC. INT. CL. 16.
- LEVITAN, YEGIDIS & GOLDSTEIN, LLP, MIDDLETOWN, NY:
2,572,389, MULTIPLE CLASS, INT. CLS. 35 AND 41.
- LEVITON MANUFACTURING CO., LTD., NEW YORK, NY,
PACIFIC ELECTRICORD COMPANY, LOS ANGELES, CA:
719,205, REN. 4-9-02. U.S. CL. 21 (INT. CL. 9).
- LEVY, EREZ, CRESSKILL, NJ:
1,886,150, CANC. INT. CL. 25.
- LEVY'S LEATHERS LIMITED, WINNIPEG, MANITOBA
R3B 2Z4, CANADA:
2,570,876, PUB. 2-26-2002. MULTIPLE CLASS, INT. CLS.
13 AND 15.
- LEWIS AND COSTAS, L.P., CONROE, TX, LANGENBERG
HAT CO., MARTHASVILLE, MO:
1,183,052, REN. 4-6-02. INT. CL. 25.
- LEWIS, JEFFREY Q., MONTECITO, CA AND MARTEN,
MARCUS, MONTECITO, CA:
2,571,923, INT. CL. 35.
- LEXCOM, INC., LEXINGTON, NC:
2,570,534, PUB. 2-26-2002. INT. CL. 38.
- LEXICON GENETICS INCORPORATED, THE WOOD-
LANDS, TX:
2,570,600, PUB. 8-22-2000. INT. CL. 42.
- LFC INTERNET TECHNOLOGIES, INC., NEWPORT
BEACH, CA:
2,570,689, PUB. 2-26-2002. MULTIPLE CLASS, INT. CLS.
35 AND 36.
- LIBERTY UNIFORM MANUFACTURING CO., INC., HUN-
TINGTON, NY:
2,571,480, PUB. 2-26-2002. INT. CL. 25.
- LIEBERT CORPORATION, COLUMBUS, OH:
1,886,554, CANC. INT. CL. 9.
- LIFE INDUSTRIES CORPORATION, CHARLESTON, SC:
2,571,303, PUB. 2-26-2002. INT. CL. 3.
- LIFE NAVIGATOR, INC., MINNEAPOLIS, MN:
2,571,215, PUB. 8-14-2001. INT. CL. 42.
- LIFECCELL CORPORATION, HOUSTON, TX:
1,475,428, COR. INT. CL. 42.
- LIFECRAFT ENTERPRISES, INC., WOODBURY, NY:
1,886,353, CANC. INT. CL. 41.
- LIFETIME HOAN CORPORATION, BROOKLYN, NY:
1,885,833, CANC. MULTIPLE CLASS, INT. CLS. 8 AND
21.
- LIFETOUCH INC., EDEN PRAIRIE, MN:
2,570,744, PUB. 10-23-2001. INT. CL. 35.
- LIFEWAY CHRISTIAN RESOURCES OF THE SOUTHERN
BAPTIST CONVENTION, NASHVILLE, TN FROM SUN-
DAY SCHOOL BOARD, THE, NASHVILLE, TN:
2,570,541, PUB. 2-26-2002. INT. CL. 14.
- LIGHTSPAN, INC., SAN DIEGO, CA:
2,571,150, PUB. 2-26-2002. MULTIPLE CLASS, INT. CLS. 9
AND 16.
2,571,152, PUB. 2-26-2002. MULTIPLE CLASS, INT. CLS. 9
AND 16.
- LILLY SOFTWARE ASSOCIATES, INC., HAMPTON, NH:
2,571,925, INT. CL. 9.
- LIMESTONE ROME, REDONDO BEACH, CA:
1,886,360, CANC. INT. CL. 41.
- LIMOS DI SCALCO VALENTINO & C. SNC, VICENTINO
(VI), ITALY:
2,571,107, PUB. 9-25-2001. INT. CL. 25.
- LINCOLN HOCKEY LLC, WASHINGTON, DC:
2,572,113, INT. CL. 41.
- LINDA'S FLOWERS, INC., SPRINGFIELD, MO:
1,189,013, REN. 4-6-02. INT. CL. 42.
1,191,412, REN. 4-6-02. INT. CL. 42.
- LINDAV USA, INC., SAN DIEGO, CA:
2,570,664, PUB. 8-7-2001. INT. CL. 42.
- LINDER, RONALD, NEW YORK, NY:
2,571,740, MULTIPLE CLASS, INT. CLS. 3, 5 AND 42.
- LINDSEY, BARBARA C., HOOVER, AL:
2,429,038, COR. INT. CL. 16.
- LINEAGE HOME FURNISHINGS, INC., HIGH POINT, NC:
1,886,409, CANC. INT. CL. 42.
- LINJAN, CORP., NAPLES, FL:
2,571,552, PUB. 2-26-2002. INT. CL. 9.
- LIPHA, 69008 LYON, FRANCE:
2,571,954, INT. CL. 5.
- LIPPER & COMPANY, INC., NEW YORK, NY:
2,571,068, PUB. 2-26-2002. INT. CL. 36.
2,571,069, PUB. 2-26-2002. INT. CL. 36.
- LIQUI-MARK CORP., WESTBURY, NY, LIQUI-MARK
CORP., WESTBURY, NY:
1,705,846, REN. 4-10-02. INT. CL. 16.
- LIQUID CONTROL CORPORATION, NORTH CANTON,
OH:
1,692,409, REN. 4-6-02. INT. CL. 7.
- LISAPARMA S.P.A., ERBA, ITALY:
1,885,778, CANC. INT. CL. 5.
- LITTLE DETROIT, INCORPORATED, ST. PAUL, MN:
2,570,807, PUB. 2-26-2002. INT. CL. 25.
- LIVING DAYLIGHT DISPLAYS, LLC, BOSTON, MA:
2,571,273, PUB. 2-26-2002. INT. CL. 9.
- LMG INVESTMENTS, INC., WILMINGTON, DE:
1,711,945, REN. 4-6-02. INT. CL. 29.
1,718,395, REN. 4-6-02. INT. CL. 29.
- LML PAYMENT SYSTEMS CORP., DALLAS, TX FROM
LML PAYMENT SYSTEMS INC., VANCOUVER, BRITISH
COLUMBIA V6E 4G1, CANADA:
2,572,072, INT. CL. 36.
- LML PAYMENT SYSTEMS CORP., DALLAS, TX FROM
LML PAYMENT SYSTEMS, INC., VANCOUVER, BRITISH
COLUMBIA V6E 4G1, CANADA:
2,572,073, INT. CL. 36.
- LOBLAWS INC., TORONTO, ONTARIO M4T 2S7, CANADA:
1,886,677, CANC. INT. CL. 30.
- LOCAL MOTION, INC., HONOLULU, HI:
2,571,165, PUB. 2-26-2002. INT. CL. 35.
- LODER MANAGEMENT ASSOCIATES, L.L.C., INDIAN
ROCKS BEACH, FL, CRABBY BILL'S SEAFOOD, INC.,
INDIAN ROCKS BEACH, FL:
1,664,569, REN. 4-12-02. INT. CL. 42.
- LODER MANAGEMENT ASSOCIATES, L.L.C., INDIAN
ROCKS BEACH, FL:
2,571,669, PUB. 2-26-2002. INT. CL. 42.
- LOJON, LLC, CERRITOS, CA:
2,570,805, PUB. 2-26-2002. MULTIPLE CLASS, INT. CLS.
35, 36 AND 42.
- LOLLY TOGS, LTD., NEW YORK, NY:
1,692,689, REN. 4-10-02. INT. CL. 9.
1,692,999, REN. 4-10-02. INT. CL. 18.
- LONDON FOG INDUSTRIES, INC., ELDERSBURG, MD:
1,886,119, CANC. INT. CL. 25.
- LONG & FOSTER COMPANIES, INC., FAIRFAX, VA:
2,570,797, PUB. 2-26-2002. INT. CL. 36.
- LONG BAY PARTNERS, L.L.C., BONITA SPRINGS, FL:
2,570,775, PUB. 2-26-2002. INT. CL. 36.
- LONG SWAMP STUDIOS, LLC, BORDENTOWN, NJ:
2,571,525, PUB. 2-26-2002. INT. CL. 20.
- LONGEVITY CENTER OF U.S.A., INC, MIAMI, FL:
2,572,232, INT. CL. 5.
- LONGORIA, RICHARD, LOS OLIVOS, CA:
2,571,187, PUB. 2-26-2002. INT. CL. 33.
- LONZA INC., FAIR LAWN, NJ:
933,731, REN. 4-9-02. U.S. CL. 6 (INT. CL. 5).
- LOPKER, JOHN KEVIN, BEVERLY HILLS, CA:
2,572,227, INT. CL. 16.
2,572,228, INT. CL. 16.
- LORESTE S.A., GENEVA, SWITZERLAND:
1,885,763, CANC. INT. CL. 3.
- LORIS AZZARO B.V., 7336 AZ APELDOORN, NETHER-
LANDS:
2,571,770, INT. CL. 3.
- LOS ALAMOS TECHNICAL ASSOCIATES, INC., ALBU-
QUERQUE, NM:
2,570,790, PUB. 2-26-2002. MULTIPLE CLASS, INT. CLS.
35, 37, 40 AND 42.
- LOS ANGELES TILE COMPANY, INC., LOS ANGELES, CA:
1,639,371, CANC. INT. CL. 19.
- LOUISIANA CASINO CRUISES, INC., BATON ROUGE, LA:
2,572,128, INT. CL. 41.

- LOUVER-LITE LIMITED, HYDE, CHESHIRE SK14 4BG, ENGLAND:
2,362,355, COR. MULTIPLE CLASS, INT. CLS. 7, 8, 9, 16 AND 20.
- LPB COMMUNICATIONS, INC., FRAZER, PA:
2,571,566, PUB. 2-26-2002. INT. CL. 9.
- LPJ RESEARCH, INC., SEYMOUR, IL:
2,571,599, PUB. 2-26-2002. INT. CL. 5.
- LTC PRODUCTS, INC., NEW YORK, NY:
1,886,597, CANC. INT. CL. 10.
- LUCENT TECHNOLOGIES INC., MURRAY HILL, NJ:
1,639,347, CANC. INT. CL. 9.
- LUKAS, JOHN, NEW YORK, NY:
2,571,118, PUB. 2-26-2002. INT. CL. 41.
- LUMEN TWEAKS LIGHTING, INC., SIMI VALLEY, CA:
2,570,765, PUB. 9-4-2001. INT. CL. 22.
- LUMIGEN, INC., SOUTHFIELD, MI:
1,675,524, REN. 4-9-02. INT. CL. 1.
- LUMINOUS CORPORATION, EVERETT, WA:
2,571,499, PUB. 2-26-2002. INT. CL. 42.
- LUNA, RAY RALPH, EL PASO, TX, DBA RAY-SUN:
1,639,142, CANC. INT. CL. 25.
- LURGI AKTIENGESSELLSCHAFT, FRANKFURT AM MAIN, FED REP GERMANY, LURGI GESELLSCHAFT FUR WARME-UND CHEMOTECHNIK M.B.H., 600 FRNAKFURT, FED REP GERMANY:
929,544, REN. 4-9-02. U.S. CL. 26 (INT. CL. 9).
- LYERLY AGENCY, INC., CHARLOTTE, NC:
2,571,655, PUB. 2-26-2002. INT. CL. 35.
- LYNDEN INCORPORATED, SEATTLE, WA:
1,691,914, REN. 4-10-02. MULTIPLE CLASS, INT. CLS. 36 AND 39.
- LYNX GOLF, INC., CITY OF INDUSTRY, CA:
1,639,182, CANC. INT. CL. 28.
- LYTE OPTRONICS, INC., TORRANCE, CA:
2,570,800, PUB. 2-26-2002. INT. CL. 11.
- M & R PLASTICS INC., LAVAL (QUEBEC), CANADA:
1,700,555, REN. 4-11-02. INT. CL. 17.
- M.A. HANNA COMPANY, CLEVELAND, OH:
2,570,587, PUB. 12-7-1999. INT. CL. 1.
- M.G. - MINI GEARS S.P.A., PADOVA ZONA INDUSTRIALE, ITALY:
2,454,365, COR. INT. CL. 7.
- M.I.N.D. INSTITUTE, IRVINE, CA:
2,571,762, INT. CL. 9.
- M.P. ACQUISITION CORP., CRANFORD, NJ, DBA MADAN PLASTICS INC.:
1,886,090, CANC. INT. CL. 21.
- M&M CREATIVE SERVICES, TALLAHASSEE, FL:
2,571,538, PUB. 2-26-2002. MULTIPLE CLASS, INT. CLS. 35 AND 42.
- MA & PA HATTER INC., NEW YORK, NY:
1,886,367, CANC. INT. CL. 41.
- MACADAMIAN TECHNOLOGIES, INC., OTTAWA, ONTARIO, CANADA:
2,570,565, PUB. 7-17-2001. INT. CL. 9.
- MACDERMID INCORPORATED, WATERBURY, CT:
713,288, CANC. U.S. CL. 52.
- MACK-BROOKS EXHIBITIONS LIMITED, HATFIELD, HERTFORSHIRE, AL10 ORN, UNITED KINGDOM:
1,886,266, CANC. INT. CL. 35.
- MAGLIFICIO SIMA S.P.A., CASINA REGGIO EMILIA, ITALY:
1,149,884, CANC. INT. CL. 25.
- MAGNER CORPORATION:
See— MAGNER CORPORATION OF AMERICA.
- MAGNER CORPORATION OF AMERICA, DURHAM, CT FROM MAGNER CORPORATION, DURHAM, CT:
2,570,884, PUB. 2-26-2002. INT. CL. 9.
- MAGUIRE PRODUCTS, INC., ASTON, PA:
2,571,522, PUB. 10-2-2001. INT. CL. 7.
- MAHARISHI AYUR-VED PRODUCTS INTERNATIONAL, INC, COLORADO SPRINGS, CO:
2,571,884, INT. CL. 5.
- MAIDENFORM, INC., NEW YORK, NY:
1,149,918, CANC. INT. CL. 25.
1,149,919, CANC. INT. CL. 25.
- MAIN STREET YORK, INC., YORK, PA TO YORK COUNTY, PENNSYLVANIA, 250TH ANNIVERSARY CORPORATION, YORK, PA:
2,543,312, COR. MULTIPLE CLASS, INT. CLS. 16 AND 25.
- MAJOR LEAGUE BASEBALL PLAYERS ALUMNI ASSOCIATION, COLORADO SPRINGS, CO:
2,571,015, PUB. 2-26-2002. MULTIPLE CLASS, INT. CLS. 16, 18, 25, 41 AND 42.
- MAJOR WATCH CASE CO., INC., BROOKLYN, NY:
1,149,762, CANC. INT. CL. 14.
- MAKALU, INC., RED HOOK, NY:
2,571,401, PUB. 2-26-2002. INT. CL. 25.
- MAKE A CHILD SMILE, INC., OLD TAPPAN, NJ:
2,570,839, PUB. 2-26-2002. INT. CL. 36.
- MANAGED HEALTH NETWORK, INC., SAN RAFAEL, CA:
2,570,882, PUB. 2-26-2002. INT. CL. 42.
- MANDEL'S OF CALIFORNIA, LOS ANGELES, CA:
713,222, CANC. U.S. CL. 39.
- MANGO BOTTLING, INC., COCOA BEACH, FL:
1,886,697, CANC. INT. CL. 33.
- MANIFATTURA DI FERNO S.R.L., FERNO (VARESE), ITALY:
2,571,517, PUB. 2-26-2002. INT. CL. 24.
- MANITOU AND PIKES PEAK RAILWAY CO., MANITOU SPRINGS, CO:
1,723,672, REN. 4-10-02. MULTIPLE CLASS, INT. CLS. 16 AND 39.
- MANUFACTURE DE VILEBREQUINS DE LORETTE MAVILOR, LOIRE, FRANCE:
1,149,604, CANC. MULTIPLE CLASS, INT. CLS. 7 AND 40.
- MANUFACTURERS LIFE INSURANCE COMPANY OF NORTH AMERICA, THE, BOSTON, MA:
2,572,116, INT. CL. 36.
- MARBLEHEAD LIME COMPANY, CHICAGO HEIGHTS, IL:
1,639,106, CANC. INT. CL. 19.
- MARCH OF DIMES BIRTH DEFECTS FOUNDATION, WHITE PLAINS, NY:
2,263,766, CANC. INT. CL. 36.
- MARDELL, STEVEN DAVID, HILTON HEAD, SC:
2,571,498, PUB. 2-26-2002. INT. CL. 25.
- MAREMONT CORPORATION, CAROL STREAM, IL:
1,639,018, CANC. INT. CL. 12.
- MARGARET MITCHELL MUSEUM, INC., THE, ATLANTA, GA:
2,572,396, INT. CL. 41.
- MARIMARK CORPORATION, TAMPA, FL:
2,571,189, PUB. 2-26-2002. INT. CL. 35.
- MARINE INSTITUTE IN ORANGE COUNTY, DANA POINT, CA, DBA OCEAN INSTITUTE:
2,571,956, INT. CL. 41.
- MARK'S WORK WEARHOUSE LTD., CALGARY, ALBERTA T2H 2J7, CANADA:
1,886,142, CANC. INT. CL. 25.
- MARKETING ONE TO ONE, INC.:
See— MARKETING ONE-TO-ONE, INC..
- MARKETING ONE-TO-ONE, INC., NORWALK, CT FROM MARKETING ONE TO ONE, INC., STAMFORD, CT:
2,571,018, PUB. 2-26-2002. INT. CL. 16.
- MARKETWARE CORPORATION, NORCROSS, GA:
1,885,843, CANC. INT. CL. 9.
- MARKKO INTERNATIONAL, INC., EDMONDS, WA:
1,886,078, CANC. INT. CL. 20.
1,886,079, CANC. INT. CL. 20.
- MARKVAD, PILGRIM V/ANNE-METTE, DK-8660 SKANDERBORG, DENMARK:
2,571,488, PUB. 2-26-2002. MULTIPLE CLASS, INT. CLS. 14 AND 26.
- MARLEY COMPANY, THE, MISSION WOODS, KS:
1,692,770, REN. 4-8-02. INT. CL. 11.
- MARMON HOLDINGS, INC., CHICAGO, IL:
1,639,170, CANC. INT. CL. 25.
- MARMOT MOUNTAIN LTD., SANTA ROSA, CA:
2,570,792, PUB. 2-26-2002. INT. CL. 25.
- MARO HOSIERY CORP., NEW YORK, NY:
1,149,895, CANC. INT. CL. 25.

- MARRIOTT INTERNATIONAL, INC., BETHESDA, MD:
2,570,767, PUB. 2-26-2002. INT. CL. 41.
- MARS, INCORPORATED, MCLEAN, VA:
2,572,045, INT. CL. 28.
- MARSH USA INC., NEW YORK, NY:
2,570,832, PUB. 2-26-2002. INT. CL. 36.
- MARSHALL & SWIFT, LOS ANGELES, CA:
1,886,573, CANC. INT. CL. 9.
- MARSHALL FARMS USA, INC., NORTH ROSE, NY:
2,571,901, INT. CL. 31.
- MARSHALL'S OF MA, INC., FRAMINGHAM, MA:
2,571,933, MULTIPLE CLASS, INT. CLS. 35 AND 42.
- MARSIN MEDICAL INTERNATIONAL, INC., PHILADELPHIA, PA:
1,867,567, CANC. INT. CL. 10.
- MARTEK BIOSCIENCES CORPORATION, COLUMBIA, MD:
2,571,188, PUB. 2-26-2002. MULTIPLE CLASS, INT. CLS. 1 AND 5.
- MARTEN, MARJORIE, WEST ALLIS, WI:
1,699,217, REN. 4-8-02. INT. CL. 28.
- MARTIN'S POTATO CHIPS, INC., THOMASVILLE, PA:
1,626,144, REN. 4-10-02. INT. CL. 29.
- MARVEL CHARACTERS, INC., LOS ANGELES, CA, CADENCE INDUSTRIES CORPORATION, NEW YORK, NY, AKA MARVEL COMICS GROUP:
1,178,554, REN. 4-9-02. INT. CL. 41.
- MARVEL CHARACTERS, INC., LOS ANGELES, CA, MARVEL ENTERTAINMENT GROUP, INC., NEW YORK, NY:
1,685,314, REN. 4-10-02. INT. CL. 16.
- MARVEL CHARACTERS, INC., LOS ANGELES, CA:
2,571,051, PUB. 2-26-2002. INT. CL. 16.
- MARVEL ENTERTAINMENT GROUP, INC., NEW YORK, NY:
1,885,990, CANC. INT. CL. 16.
- MARYLAND CUP CORPORATION, OWINGS MILLS, MD:
386,110, CANC. U.S. CL. 2.
- MARYLAND PUBLIC BROADCASTING COMMISSION, OWINGS MILLS, MD:
2,571,250, PUB. 2-26-2002. INT. CL. 41.
- MASCO CORPORATION OF INDIANA, TAYLOR, MI:
1,189,918, REN. 4-6-02. INT. CL. 11.
- MASSACHUSETTS ELECTRONIC COMMERCE ASSOCIATION, INC., BOSTON, MA:
2,570,868, PUB. 2-26-2002. INT. CL. 35.
2,570,871, PUB. 2-26-2002. INT. CL. 38.
2,570,872, PUB. 2-26-2002. INT. CL. 35.
2,570,873, PUB. 2-26-2002. INT. CL. 35.
2,570,878, PUB. 2-26-2002. INT. CL. 42.
- MASTER CHEMICAL CORPORATION, PERRYSBURG, OH:
2,570,617, PUB. 9-4-2001. INT. CL. 3.
- MASTER SHIELD BUILDING PRODUCTS CO., L.P., WEATHERFORD, TX:
1,886,060, CANC. INT. CL. 19.
- MASTER-KRETE, INC., KANSAS CITY, MO:
713,045, CANC. U.S. CL. 16.
- MATCHCRAFT, INC., MALIBU, CA:
2,571,818, INT. CL. 35.
- MATHEWS, MATT, CAPITOLA, CA:
2,570,688, PUB. 2-26-2002. INT. CL. 8.
- MATRIX.NET, INC., AUSTIN, TX FROM MATRIX INFORMATION AND DIRECTORY SERVICES, INC., AUSTIN, TX:
2,572,063, INT. CL. 42.
- MATSUSHITA ELECTRIC INDUSTRIAL CO., LTD., KADOMA-SHI, OSAKA PREFECTURE, JAPAN:
1,149,704, CANC. INT. CL. 9.
- MATTEL, INC., EL SEGUNDO, CA:
2,571,103, PUB. 2-26-2002. INT. CL. 28.
2,572,191, INT. CL. 28.
2,572,207, INT. CL. 28.
- MATTHEW GOWAR & GILLIAN GOWAR, PARTNERSHIP, THE, BUCKINGHAMSHIRE, UNITED KINGDOM:
2,526,493, CANC. IIRN. RESTORED TO S.N. 75-697,103.
- MAURER AG, D-78479 REICHENAU, FED REP GERMANY, H. MAURER + SOHNE RAUCH-UND WARMETECHNIKGMBH + CO. KG., D-7752 INSEL REICHENAU, FED REP GERMANY:
1,189,897, REN. 4-11-02. INT. CL. 11.
- MAVERICK RANCH ASSOCIATION, INC., DENVER, CO:
1,703,575, REN. 4-6-02. INT. CL. 31.
- MAX & LUCY, LLC, PHOENIX, AZ:
2,570,915, PUB. 2-26-2002. INT. CL. 16.
2,570,916, PUB. 2-26-2002. INT. CL. 16.
- MAX ROHR, INC., WILMINGTON, DE:
1,172,530, REN. 4-9-02. INT. CL. 34.
- MAXIM HEALTHCARE SERVICES, INC., COLUMBIA, MD:
2,571,109, PUB. 2-26-2002. INT. CL. 42.
2,571,110, PUB. 2-26-2002. INT. CL. 35.
- MAXITROL COMPANY, SOUTHFIELD, MI, DETROIT REGULATOR COMPANY, DETROIT, MI:
552,283, REN. 4-10-02. U.S. CL. 13 (INT. CL. 6).
- MAXSCAN INC., AUSTIN, TX:
2,571,463, PUB. 2-26-2002. INT. CL. 9.
- MAY, DONALD R., SUN LAKES, AZ:
2,572,217, INT. CL. 6.
- MAYAN CORPORATION, NORWALK, CT:
1,886,055, CANC. INT. CL. 18.
- MAYBE IT'S TIME, INC., GOLDEN VALLEY, MN:
2,571,921, INT. CL. 16.
- MAYBELLINE CO., NORTH LITTLE ROCK, AR:
1,149,560, CANC. INT. CL. 3.
- MAYCO WELLCHEM, INC., HOUSTON, TX:
1,183,365, REN. 4-6-02. INT. CL. 1.
- MAZZCO, INC., EUGENE, OR:
2,572,183, INT. CL. 12.
- MAZZIO'S CORPORATION, TULSA, OK:
1,886,408, CANC. INT. CL. 42.
- MBNA AMERICA BANK, NATIONAL ASSOCIATION, NEWARK, DE:
2,572,238, INT. CL. 36.
- MC CARTER CORPORATION, THE, NORRISTOWN, PA:
697,095, REN. 4-9-02. U.S. CL. 23 (INT. CLS. 6, 7, 8, 9, 11, 12, 16, 21 AND 28).
- MCC FOODS AMERICA, INC., CARSON, CA:
1,875,748, CANC. MULTIPLE CLASS, INT. CLS. 29, 30 AND 42.
- MCCLOSKEY, ROBERT E., WARREN, MI, DBA TRIN-MAC COMPANY:
1,149,636, CANC. INT. CL. 7.
- MCCONNELL, TYRON J., ROGERSVILLE, AL:
2,571,209, PUB. 2-26-2002. INT. CL. 12.
- MCDONALD, GREG, QUINCY, MA:
2,570,995, PUB. 2-26-2002. INT. CL. 30.
- MCDONNELL DOUGLAS CORPORATION, ST. LOUIS, MO:
1,639,019, CANC. INT. CL. 12.
- MCDONOUGH, ROBERT A., HENDERSON, NV, DBA I.C.C.:
2,571,675, PUB. 2-26-2002. INT. CL. 28.
- MCELFRESH, STEVE, PALO ALTO, CA:
2,571,389, PUB. 2-26-2002. INT. CL. 35.
- MCFARLAND DISTRIBUTORS, INC., BROKEN ARROW, OK TO REX CHICKEN, L.L.C., OKLAHOMA CITY, OK:
1,639,311, CANC. INT. CL. 42.
- MCGANNON, JOHN, DALY CITY, CA, DBA WILDEATS ENTERPRISES:
2,570,503, PUB. 10-6-1998. INT. CL. 16.
- MCGUINNESS FUNERAL HOMES, WOODBURY, NJ:
1,886,454, CANC. INT. CL. 42.
- MCHENRY, DAVID M., WASHINGTON, DC:
1,886,650, CANC. INT. CL. 25.
- MCINNES STEEL COMPANY, CORRY, PA:
1,189,113, REN. 4-10-02. INT. CL. 6.
- MCLANE COMPANY, INC., TEMPLE, TX:
2,570,579, PUB. 9-28-1999. INT. CL. 30.
- MCLAUGHLIN GORMLEY KING COMPANY, MINNEAPOLIS, MN:
2,572,106, INT. CL. 5.
- MCLAUGHLIN, PIVEN, VOGEL SECURITIES INC., NEW YORK, NY:
1,886,300, CANC. INT. CL. 36.

MCLEAN, JAN, SOUTH DUNEDIN, NEW ZEALAND, TA
 JAN MCLEAN ORIGINALS:
 2,571,229, PUB. 2-26-2002. INT. CL. 28.

MCMANUS, JOHN, LONGMEADOW, MA, DBA MCMANUS
 ASSOCIATES:
 1,886,075, CANC. INT. CL. 20.

MCORP, DALLAS, TX:
 1,150,028, CANC. INT. CL. 36.

MCRAE, KELVIN C., NEW WINDSOR, NY:
 1,886,801, CANC. INT. CL. 25.

MDLB ENTERPRISES, LLC., OAK PARK, IL, DBA DOODY
 PUBLISHING:
 2,570,609, PUB. 2-26-2002. MULTIPLE CLASS, INT. CLS.
 41 AND 42.

MDO DEVELOPMENT CORPORATION, NEW YORK, NY:
 1,692,110, REN. 4-11-02. INT. CL. 42.

MDS GEAR, INC., SAN PEDRO, CA:
 2,572,220, INT. CL. 25.

MDS INC., ETOBICOKE, ONTARIO, CANADA:
 2,571,704, MULTIPLE CLASS, INT. CLS. 1, 5, 9, 10, 35, 37
 AND 42.

ME LICENSING CORPORATION, CLAYMONT, DE:
 2,570,986, PUB. 2-26-2002. INT. CL. 16.
 2,571,104, PUB. 2-26-2002. INT. CL. 41.

MEA INTERESTS, INC., LINDALE, TX:
 1,149,985, CANC. INT. CL. 31.

MEARES, LISE, SAN PEDRO, CA:
 2,571,548, PUB. 2-26-2002. INT. CL. 9.

MED POWER, INC., PRINCETON, NJ:
 1,886,485, CANC. MULTIPLE CLASS, INT. CLS. 35 AND
 36.

MED-LOGICS, INC., LAGUNA NIGUEL, CA:
 2,571,092, PUB. 2-26-2002. INT. CL. 10.

MEDALLIC ART COMPANY LTD., DAYTON, NV:
 2,572,214, INT. CL. 14.

MEDIA GROUP, STAMFORD, CT:
 2,571,792, INT. CL. 9.

MEDLEY DISTILLING COMPANY, OWENSBORO, KY:
 745,217, CANC. U.S. CL. 49.

MEDRAD, INC., INDIANOLA, PA:
 1,677,492, REN. 4-8-02. INT. CL. 10.

MEDTRONIC, INC., MINNEAPOLIS, MN, DLP, INC.,
 GRAND RAPIDS, MI:
 1,677,484, REN. 4-10-02. INT. CL. 10.

MELVIN F. LAUINGER AND BRENDA J. MCRANN,
 YAKIMA, WA:
 1,689,606, REN. 4-12-02. INT. CL. 28.

MEMPHIS NETWORK, LLC, MEMPHIS, TN:
 2,572,278, INT. CL. 38.

MEN'S PLACE INC., LOS ANGELES, CA:
 2,571,472, PUB. 2-26-2002. INT. CL. 25.

MENAGE LIMITED PARTNERSHIP, WASHINGTON, DC:
 1,886,477, CANC. MULTIPLE CLASS, INT. CLS. 41 AND
 42.

MENDLOWITZ WEITSEN, LLP, CPAS, EAST BRUNSWICK,
 NJ:
 2,571,782, INT. CL. 16.

MENNEL MILLING COMPANY, THE, FOSTORIA, OH:
 552,481, REN. 4-9-02. U.S. CL. 46 (INT. CL. 30).
 559,239, REN. 4-10-02. U.S. CL. 46 (INT. CL. 30).
 564,885, REN. 4-10-02. U.S. CL. 46 (INT. CL. 30).
 2,571,227, PUB. 2-26-2002. INT. CL. 30.

MENTALWEB, INC., MIAMI, FL:
 2,570,863, PUB. 2-26-2002. INT. CL. 35.

MERCK-MEDCO MANAGED CARE, L.L.C., FRANKLIN
 LAKES, NJ:
 2,533,722, COR. INT. CL. 16.

MERCY SHIPS, GARDEN VALLEY, TX:
 2,570,865, PUB. 2-26-2002. INT. CL. 42.

MEREDITH, GEOFFREY E., LAFAYETTE, CA, DBA LIFE-
 STAGE MATRIX MARKETING:
 1,886,805, CANC. INT. CL. 35.

MERIT INDUSTRIES, INC., BENSLEM, PA:
 2,570,815, PUB. 2-26-2002. INT. CL. 28.
 2,572,136, INT. CL. 28.

MERLE WOOD & ASSOCIATES, INC., FORT LAUDER-
 DALE, FL:
 2,570,810, PUB. 2-26-2002. MULTIPLE CLASS, INT. CLS.
 35, 36, 39 AND 42.

MEROCEL CORPORATION, MYSTIC, CT:
 1,886,599, CANC. INT. CL. 10.

MERRILL LYNCH & CO., INC., NEW YORK, NY:
 2,571,170, PUB. 2-26-2002. INT. CL. 35.

MERRYVALE VINEYARDS LLC, ST. HELENA, CA, MER-
 RYVALE VINEYARDS, LTD., ST. HELENA, CA:
 1,687,299, REN. 4-10-02. INT. CL. 33.

MERVYN'S BRANDS, INC., MINNEAPOLIS, MN:
 2,570,917, PUB. 5-22-2001. INT. CL. 25.

MESS ENTERPRISES, SAN FRANCISCO, CA:
 2,572,201, MULTIPLE CLASS, INT. CLS. 41 AND 42.

METAL COATERS OPERATING, LP, HOUSTON, TX, ME-
 TAL COATERS, INC., HOUSTON, TX:
 1,675,343, REN. 4-6-02. INT. CL. 37.

METAL MANAGEMENT, INC., CHICAGO, IL:
 2,570,931, PUB. 2-26-2002. MULTIPLE CLASS, INT. CLS.
 35, 37, 39, 40 AND 42.

METALLICA, SAN FRANCISCO, CA:
 2,570,843, PUB. 2-26-2002. INT. CL. 41.

METAPATH SOFTWARE INTERNATIONAL (BELLEVUE),
 INC., BELLEVUE, WA TO METAPATH CORPORATION,
 REDMOND, WA:
 2,465,897, COR. INT. CL. 42.

METRO-GOLDWYN-MAYER LION CORP., SANTA MON-
 ICA, CA:
 2,571,241, PUB. 2-26-2002. INT. CL. 18.

METROMEDIA STEAKHOUSES COMPANY, L.P., PLANO,
 TX, METROMEDIA STEAKHOUSES, INC., DAYTON, OH,
 DBA PONDEROSA STEAKHOUSE:
 1,677,995, REN. 4-7-02. INT. CL. 42.

METROPOLIS STUDIOS LTD., LONDON W4 1SY, ENG-
 LAND:
 2,571,934, INT. CL. 41.

MEXICANA DE ELECTROMECANICOS, S.A. DE C.V., C.P.
 45010 ZAPOPAN, JALISCO, MEXICO:
 2,572,254, INT. CL. 9.

MEYER MANUFACTURING COMPANY LIMITED, KWUN
 TONG, KOWLOON, HONG KONG:
 1,886,628, CANC. INT. CL. 21.

MEYER SALES SERVICE, INC., HIALEAH GARDENS, FL:
 1,885,943, CANC. INT. CL. 11.

MEYER TOMATOES, LLC, KING CITY, CA, MEYER,
 ROBERT L., KING CITY, CA, DBA MEYER TOMATOES:
 1,688,036, REN. 4-6-02. INT. CL. 31.

MGW GROUP, INC., PLANO, TX:
 2,570,550, PUB. 9-5-2000. INT. CL. 35.

MHA INSURANCE COMPANY, LANSING, MI:
 2,572,008, INT. CL. 36.

MIAMI-DADE EXPRESSWAY AUTHORITY, MIAMI, FL:
 2,571,793, INT. CL. 37.
 2,571,794, INT. CL. 37.

MICHELIN NORTH AMERICA, INC., GREENVILLE, SC:
 2,571,183, PUB. 8-14-2001. INT. CL. 12.

MICRO FASTENERS INC., FLEMINGTON, NJ:
 2,572,386, INT. CL. 6.

MICRO TEXTILE, INC., SANTA ANA, CA:
 2,571,038, PUB. 2-26-2002. MULTIPLE CLASS, INT. CLS.
 16, 18 AND 25.

MICRO WAREHOUSE, INC., NORWALK, CT:
 2,571,090, PUB. 2-26-2002. INT. CL. 35.

MICROBEST, INC., BOCA RATON, FL:
 2,572,279, INT. CL. 3.

MICROMONITORS, INC., BEND, OR:
 2,572,006, MULTIPLE CLASS, INT. CLS. 9 AND 42.

MICRONAS SEMICONDUCTOR HOLDING AG, CH-8005,
 ZURICH, SWITZERLAND:
 2,570,624, PUB. 10-24-2000. INT. CL. 9.

MID-MOUNTAIN MATERIALS, INC., SEATTLE, WA:
 1,674,724, REN. 4-6-02. MULTIPLE CLASS, INT. CLS. 2
 AND 19.

MIDWAY HOME ENTERTAINMENT INC., CHICAGO, IL:
 2,571,930, INT. CL. 9.

MIDWAY MANUFACTURING COMPANY, CHICAGO, IL:
 1,886,184, CANC. INT. CL. 28.

MIDWEST RECREATIONAL PRODUCTS INC., WAUKE-
 SHA, WI:
 2,571,085, PUB. 2-26-2002. INT. CL. 35.

- MILES LABORATORIES INC., ELKHART, IN:
383,747, CANC. U.S. CL. 46.
- MILLARD, CATHERINE, SPRINGFIELD, VA, DBA CHRISTIAN HERITAGE TOURS, INC.:
2,570,485, PUB. 4-1-1997. INT. CL. 41.
- MILLENNIUM TECHNOLOGY VENTURES, L.P., NEW YORK, NY:
2,570,730, PUB. 10-9-2001. INT. CL. 36.
- MILLER CORPORATION, CAMBRIDGE CITY, IN:
1,886,675, CANC. INT. CL. 30.
- MILLER PUBLISHING COMPANY, THE, MINNEAPOLIS, MN:
713,191, CANC. U.S. CL. 38.
- MILLER, MICHAEL J., VALLEY STREAM, NY:
2,572,198, INT. CL. 9.
- MILLIKEN & COMPANY, NEW YORK, NY:
1,639,130, CANC. INT. CL. 24.
- MILLIPORE CORPORATION, BEDFORD, MA:
2,571,523, PUB. 2-26-2002. INT. CL. 11.
- MILTON BRADLEY COMPANY, EAST LONGMEADOW, MA:
1,149,952, CANC. INT. CL. 28.
- MILWAUKEE MATTRESS & FURNITURE, INC., MILWAUKEE, WI:
1,149,849, CANC. INT. CL. 20.
- MIMNAUGH, GARY, LAKE OSWEGO, OR:
2,571,991, INT. CL. 9.
- MIN, PETER DAEKIE, LAKE FOREST, CA:
2,572,195, INT. CL. 5.
- MINNESOTA DIVERSIFIED PRODUCTS, INC., ROCKFORD, MN:
1,189,301, REN. 4-10-02. INT. CL. 17.
- MINNESOTA MINING AND MANUFACTURING COMPANY, ST. PAUL, MN, AKA 3M:
1,204,524, REN. 4-12-02. INT. CL. 16.
- MINTIE CORPORATION, LOS ANGELES, CA:
1,683,234, REN. 4-10-02. INT. CL. 37.
- MINUTEMAN INTERNATIONAL, INC., ADDISON, IL:
1,681,722, REN. 4-6-02. INT. CL. 3.
- MIRANT CORPORATION, ATLANTA, GA:
2,571,256, PUB. 2-26-2002. INT. CL. 36.
- MISSION SOCIETY FOR UNITED METHODISTS, THE, DECATUR, GA:
1,886,368, CANC. INT. CL. 41.
- MISSION YOGURT, INC., WESTMINSTER, CO:
2,570,656, PUB. 2-26-2002. INT. CL. 42.
- MITSA INTERNATIONAL INC., NEW YORK, NY:
1,886,165, CANC. INT. CL. 25.
- MIXX ENTERTAINMENT, INC., LOS ANGELES, CA:
2,570,864, PUB. 2-26-2002. INT. CL. 16.
- MIYAMONTE U.S.A., INC., BEVERLY HILLS, CA:
2,571,577, PUB. 2-26-2002. INT. CL. 3.
- MMK, INC., NASHVILLE, TN, KORE ENTERPRISES, INC., DALLAS, TX:
1,676,410, REN. 4-11-02. INT. CL. 41.
- MOBILE TECHNOLOGIES, INC., TULSA, OK:
1,638,883, CANC. INT. CL. 7.
- MOBIPRO A/S, 3450 ALLEROD, DENMARK FROM TIME/SYSTEM INTERNATIONAL A/S, 3450 ALLERAD, DENMARK:
2,570,692, PUB. 2-26-2002. INT. CL. 9.
- MOBLEY, DARRYL L., DANVILLE, CA:
2,570,976, PUB. 2-26-2002. INT. CL. 16.
- MODERNISTA!, LTD., BOSTON, MA:
2,571,673, PUB. 2-26-2002. INT. CL. 35.
- MODULAR MINING SYSTEMS, INC., TUCSON, AZ:
2,572,281, INT. CL. 9.
- MOEN INCORPORATED, NORTH OLMSTED, OH:
2,571,521, PUB. 2-26-2002. INT. CL. 35.
- MOHAWK VALLEY RANCH, BLAIRSDEN, CA, DBA WHITEHAWK RANCH:
1,639,271, CANC. MULTIPLE CLASS, INT. CLS. 37 AND 41.
- MOHON INTERNATIONAL, INC., PARIS, TN:
2,572,189, INT. CL. 11.
- MOKIEM & JULIAN INDUSTRIAL CORP., LOS ANGELES, CA:
1,886,785, CANC. INT. CL. 16.
- MOLECULARWARE, INC., CAMBRIDGE, MA:
2,572,002, INT. CL. 9.
- MOLSON CANADA, ETOBICOKE, ONTARIO, CANADA, MOLSON BREWERIES, TORONTO, ONTARIO, CANADA:
1,688,037, REN. 4-7-02. INT. CL. 32.
- MONDO, INC., NEW YORK, NY:
1,886,153, CANC. INT. CL. 25.
- MONTANA GRAIN GROWERS ASSOCIATION, GREAT FALLS, MT:
2,572,199, INT. CL. 41.
- MONTANA SUNDOWN, INC., HAMILTON, MT, DBA ROCKY MOUNTAIN LOG HOMES:
1,699,093, REN. 4-9-02. INT. CL. 19.
- MONTECO HAIR ASSOCIATES, INC., HALLANDALE, FL:
1,886,181, CANC. INT. CL. 26.
- MONTGOMERY WARD & CO., INCORPORATED, CHICAGO, IL:
1,149,737, CANC. INT. CL. 12.
- MONTI VAN LINES, INC.:
See—LA ROSA DEL MONTE EXPRESS INC..
- MOORE; ROBERT, SPARTA, NJ:
1,150,084, CANC. INT. CL. 42.
- MORAN FOODS, INC., EARTH CITY, MO TO MORAN FOODS, INC., EARTH CITY, MO:
2,427,442, COR. INT. CL. 29.
- MORE, VICKY, FAIRFAX, VA:
2,571,601, PUB. 2-26-2002. INT. CL. 42.
- MORGAN CRUCIBLE COMPANY PLC, THE, WINDSOR, BERKSHIRE SL4 1EP, ENGLAND, NATIONAL CARBON COMPANY, INC., NEW YORK, NY:
444,613, REN. 4-8-02. U.S. CL. 35 (INT. CL. 17).
- MORGAN CRUCIBLE COMPANY PLC, THE, WINDSOR, BERKSHIRE, SL4 1EP, ENGLAND, UNION CARBIDE AND CARBON CORPORATION, NEW YORK, NY:
549,044, REN. 4-8-02. U.S. CL. 12 (INT. CL. 17).
- MORGAN PRODUCTS LTD., LINCOLNSHIRE, IL:
1,886,791, CANC. INT. CL. 19.
- MORGAN, JO DEE, GARLAND, TX:
2,571,157, PUB. 2-26-2002. INT. CL. 35.
- MORRIS, GEORGE, REDONDO BEACH, CA:
1,639,163, CANC. INT. CL. 25.
- MORRO CASTLE INC., MIAMI, FL:
1,870,119, CANC. INT. CL. 42.
- MORTON INTERNATIONAL, INC., CHICAGO, IL, DYNACHEM CORPORATION, SANTA FE SPRINGS, CA:
927,610, REN. 4-7-02. U.S. CL. 6 (INT. CLS. 1 AND 2).
- MOSBY-YEAR BOOK, INC., ST. LOUIS, MO:
1,886,277, CANC. INT. CL. 35.
- MOSLEY, MELISSA M., BURLINGTON, IA:
2,571,288, PUB. 2-26-2002. INT. CL. 41.
- MOTIVATION EXCELLENCE, INC., SCHAUMBURG, IL:
2,571,050, PUB. 2-26-2002. INT. CL. 35.
- MOTLEY FOOL, INC., THE, ALEXANDRIA, VA:
1,953,034, COR. MULTIPLE CLASS, INT. CLS. 16 AND 42.
- MOTONATION, POWAY, CA:
2,571,065, PUB. 2-26-2002. INT. CL. 25.
- MOTORKOTE, INC., CHARLOTTE, MI:
2,571,086, PUB. 2-26-2002. INT. CL. 1.
- MOTOROLA, INC., SCHAUMBURG, IL:
2,570,578, PUB. 2-26-2002. INT. CL. 9.
- MOUNTAIN MEADOWS PRODUCTS, INC., LEWISTOWN, MT:
1,676,947, REN. 4-12-02. INT. CL. 31.
1,676,948, REN. 4-10-02. INT. CL. 31.
- MOUNTAIN RESCUE ASSOCIATION, POWAY, CA:
722,413, REN. 4-12-02. U.S. CL. 200.
- MOUNTAINTOP PUBLISHING, INC., BOULDER, CO:
2,570,920, PUB. 2-26-2002. INT. CL. 16.
2,570,921, PUB. 2-26-2002. INT. CL. 41.
- MOVADO LLC, WILMINGTON, DE FROM MOVADO CORPORATION, WILMINGTON, DE:
2,572,077, INT. CL. 14.
- MPW, INC., AUGUSTA, MO:
2,571,003, PUB. 2-26-2002. INT. CL. 35.
- MRI/SALES CONSULTANTS OF LAKE OSWEGO, LLC, LAKE OSWEGO, OR, DBA FINANCIALPLACEMENTS:
2,571,197, PUB. 2-26-2002. INT. CL. 35.

- MRK INDUSTRIES LLC., PALATINE, IL:
2,571,589, PUB. 2-26-2002. INT. CL. 9.
2,571,590, PUB. 2-26-2002. INT. CL. 9.
- MSE SHREVEPORT, LLC, LOS ANGELES, CA:
2,571,647, PUB. 2-26-2002. INT. CL. 41.
- MSKC GROUP LLC DBA PHARMOGENEXX, WESTMINSTER, CO:
2,571,494, PUB. 9-18-2001. INT. CL. 5.
- MTD PRODUCTS INC, CLEVELAND, OH:
2,572,130, INT. CL. 12.
2,572,249, INT. CL. 7.
- MUECK, DONNA, CEDAR PARK, TX, DBA SOAPSAFE PRODUCTS:
1,886,088, CANC. INT. CL. 21.
- MUELLER SPORTS MEDICINE, INC., PRAIRIE DU SAC, WI, MUELLER CHEMICAL COMPANY, INC., PRAIRIE DU SAC, WI:
1,195,611. REN. 4-10-02. INT. CL. 10.
- MUELLER, EVAN, SEBEKA, MN, DBA ACCURIGHT PRODUCTS:
1,639,025, CANC. INT. CL. 13.
- MULLEN, DEVON AINSWORTH, SANTA CRUZ, CA:
1,855,688, CANC. INT. CL. 14.
- MULTIMEDIA ENTERTAINMENT, INC., NEW YORK, NY:
1,886,356, CANC. INT. CL. 41.
- MULTIPOINT NETWORKS, INC., BELMONT, CA:
1,885,905, CANC. INT. CL. 9.
1,885,906, CANC. INT. CL. 9.
1,885,907, CANC. INT. CL. 9.
- MUNCHKIN, INC., VAN NUYS, CA:
2,572,034, MULTIPLE CLASS, INT. CLS. 10, 21 AND 26.
- MURPHY OIL USA, INC., EL DORADO, AR:
291,502. REN. 4-10-02. U.S. CL. 15 (INT. CL. 4).
- MURPHY, JEANMARIE, SAN FRANCISCO, CA:
1,886,270, CANC. INT. CL. 35.
- MURPHY, SCOTT, CHICAGO, IL AND ROGNER, TIM, CHICAGO, IL AND HAMADA, JOHN, CHICAGO, IL AND ROSSI, DAVID, CHICAGO, IL:
2,571,204, PUB. 2-26-2002. INT. CL. 41.
- MURRAY OHIO MANUFACTURING CO., THE, BRENTWOOD, TN:
1,149,740, CANC. INT. CL. 12.
- MUSCATINE PEARL WORKS, MUSCATINE, IA:
713,235, CANC. U.S. CL. 40.
- MUSENKI, INC., AUSTIN, TX:
2,571,678, PUB. 2-26-2002. INT. CL. 9.
- MUSIC FOR YOUNG CHILDREN BY FRANCES BALODIS LTD., KANATA, ONTARIO, CANADA:
2,570,599, PUB. 3-13-2001. MULTIPLE CLASS, INT. CLS. 15, 28 AND 41.
- MUSICWARE, INC., REDMOND, WA:
1,886,585, CANC. INT. CL. 9.
- MVIS CORPORATION, NEW YORK, NY, DBA MARKET VISION:
1,885,923, CANC. INT. CL. 9.
- MWS PRECISION WIRE INDUSTRIES, INC., CHATSWORTH, CA:
1,149,601, CANC. INT. CL. 6.
- MY CRAZY LIFE, NORTHRIDGE, CA:
1,886,656, CANC. INT. CL. 25.
- MY EHS MANAGER, INC., SHOREWOOD, MN:
2,571,545, PUB. 2-26-2002. INT. CL. 42.
- N.S. & M.G. INC., ROCKVILLE, MD:
1,207,533. REN. 4-9-02. INT. CL. 37.
- N.S. & M.G., INC., ROCKVILLE, MD:
1,886,332, CANC. INT. CL. 37.
- N.V.E., INC., NEWTON, NJ:
2,571,797, INT. CL. 5.
- NABISCO BRANDS COMPANY, WILMINGTON, DE:
2,572,410, INT. CL. 30.
- NABISCO, INC., PARSIPPANY, NJ:
1,886,685, CANC. INT. CL. 30.
- NAKAMURA, MICHAEL TOSHIO, BURLINGAME, CA:
2,571,030, PUB. 2-26-2002. INT. CL. 29.
- NALCO CHEMICAL COMPANY, NAPERVILLE, IL:
1,886,402, CANC. INT. CL. 42.
- NAMASTE LABORATORIES, L.L.C., BLUE ISLAND, IL:
2,570,801, PUB. 2-26-2002. INT. CL. 3.
- NAMBRONE LE FONTI S.P.A., CARISOLO (TRENTO), ITALY:
1,726,065. REN. 4-11-02. INT. CL. 32.
- NANOMETRICS INCORPORATED, MILPITAS, CA, OPTICAL SPECIALTIES, INC., FREMONT, CA:
1,678,055. REN. 4-7-02. INT. CL. 9.
- NASHUA PHOTO INC., NASHUA, NH:
1,886,719, CANC. INT. CL. 40.
- NATCOM, INC., BIXBY, OK:
1,886,787, CANC. INT. CL. 16.
- NATIONAL ASSOCIATION OF ALCOHOLISM AND DRUG ABUSE COUNSELORS, ALEXANDRIA, VA:
1,676,280. REN. 4-8-02. U.S. CL. B.
- NATIONAL ASSOCIATION OF DEMOLITION CONTRACTORS, INC., DOYLESTOWN, PA:
2,572,348, INT. CL. 16.
- NATIONAL ASSOCIATION OF FEDERAL CREDIT UNIONS, ARLINGTON, VA:
2,571,247, PUB. 2-26-2002. INT. CL. 16.
- NATIONAL BLACK MBA ASSOCIATION, INC., CHICAGO, IL:
2,570,940, PUB. 2-26-2002. INT. CL. 35.
- NATIONAL BUSINESS SERVICES, INC., LANGHORNE, PA, AKA ADVERTISING SPECIALITY INSTITUTE TO ADVERTISING SPECIALTY INSTITUTE INC., TREVOSE, PA:
1,174,140, CANC. INT. CL. 35.
- NATIONAL COUPLING COMPANY, INC., STAFFORD, TX:
2,572,120, INT. CL. 6.
- NATIONAL DATA INTELLECTUAL PROPERTY CORP., ATLANTA, GA:
888,836. REN. 4-8-02. U.S. CL. 101 (INT. CLS. 35, 36, 38, 41 AND 42).
- NATIONAL DISCOUNT BROKERS GROUP, INC., JERSEY CITY, NJ FROM NATIONAL DISCOUNT BROKERS CORPORATION, NEW YORK, NY:
2,570,788, PUB. 2-26-2002. INT. CL. 36.
- NATIONAL DISCOUNT BROKERS CORPORATION:
See—NATIONAL DISCOUNT BROKERS GROUP, INC.
- NATIONAL DISPATCH CENTER, INC., THE, SAN DIEGO, CA:
2,570,847, PUB. 9-11-2001. INT. CL. 35.
- NATIONAL EMPLOYEE RIGHTS INSTITUTE, SAN FRANCISCO, CA:
2,572,400, MULTIPLE CLASS, INT. CLS. 16 AND 35.
- NATIONAL ENDOWMENT FOR THE CHRISTIAN ARTS, INC., THE, FORT WASHINGTON, MD:
2,571,315, PUB. 2-26-2002. INT. CL. 36.
- NATIONAL GEOGRAPHIC SOCIETY, WASHINGTON, DC:
2,571,216, PUB. 2-26-2002. MULTIPLE CLASS, INT. CLS. 16 AND 41.
- NATIONAL HEALTH PROMOTION ASSOCIATES, INC., HATSDALE, NY:
2,571,031, PUB. 2-26-2002. INT. CL. 41.
- NATIONAL HOT ROD ASSOCIATION (AKA NHRA), GLEN DORA, CA:
2,570,623, PUB. 2-26-2002. INT. CL. 35.
- NATIONAL INSTITUTE ON DEAFNESS AND OTHER COMMUNICATION DISORDERS, BETHESDA, MD:
2,570,939, PUB. 2-26-2002. INT. CL. 42.
- NATIONAL SEMICONDUCTOR CORPORATION, SANTA CLARA, CA:
1,885,910, CANC. INT. CL. 9.
- NATIONAL SERVICE CENTER, INC., ATLANTA, GA:
2,570,952, PUB. 2-26-2002. MULTIPLE CLASS, INT. CLS. 35 AND 37.
- NATIONAL TOBACCO COMPANY, L.P., NEW YORK, NY:
2,570,970, PUB. 2-26-2002. INT. CL. 35.
- NATIONAL TRAINING RINK CORP., CALGARY, ALBERTA, CANADA:
2,570,784, PUB. 2-6-2001. INT. CL. 41.
- NATIONAL URBAN LEAGUE, INC., NEW YORK, NY:
1,224,197. REN. 4-12-02. INT. CL. 16.
- NATIONAL URBAN TECHNOLOGY CENTER, INC., THE, NEW YORK, NY:
2,570,705, PUB. 2-26-2002. MULTIPLE CLASS, INT. CLS. 37 AND 42.
- NATIONAL VAN LINES, INC., BROADVIEW, IL:
1,718,818. REN. 4-6-02. INT. CL. 39.

- NATIONAL WILDLIFE FEDERATION, WASHINGTON, DC:
1,886,031, CANC. INT. CL. 16.
- NATURAL LIGHT, PARSIPPANY, NJ:
2,572,365, INT. CL. 1.
- NATURCOM ENTERPRISES, LLC, BRADFORD, VT:
2,571,396, PUB. 2-26-2002. INT. CL. 1.
- NATURE'S SUNSHINE PRODUCTS, INC., PROVO, UT:
1,676,532, REN. 4-9-02. INT. CL. 5.
2,435,532, COR. INT. CL. 3.
2,571,400, PUB. 2-26-2002. INT. CL. 11.
- NATUROPATHIC LABORATORIES INTERNATIONAL
INC., GREAT NECK, NY:
2,571,324, PUB. 2-26-2002. INT. CL. 5.
- NAVIGANT CONSULTING, INC.:
See—SMARTORG, INC.
- NAXOS CLEANERS, INC., BROOKLYN, NY:
2,571,388, PUB. 2-26-2002. INT. CL. 37.
- NBTY, INC., BOHEMIA, NY:
2,572,074, INT. CL. 5.
2,572,075, INT. CL. 5.
- NCR CORPORATION, DAYTON, OH, NATIONAL CASH
REGISTER COMPANY, THE, DAYTON, OH:
148,174, REN. 4-9-02. U.S. CL. 38 (INT. CL. 16).
- NEELEY SALES COMPANY, INC., GREENWOOD, SC:
1,885,966, CANC. INT. CL. 13.
- NEI, INC., VANCOUVER, WA, WILLIAM BLAIR, INC.,
YAKIMA, WA, AKA NORTHWEST EQUITY INVEST-
MENTS:
1,190,928, REN. 4-11-02. INT. CL. 36.
- NELL'S INC., NEW YORK, NY:
2,251,288, AM. INT. CL. 42.
- NEON NITS, LLC, DAYTON, TN:
2,571,530, PUB. 2-26-2002. INT. CL. 5.
- NEOSAN PHARMACEUTICALS, INC., WILMINGTON, DE,
USV PHARMACEUTICAL CORPORATION, TUCKAHOE,
NY:
942,612, REN. 4-11-02. U.S. CL. 18 (INT. CL. 5).
- NEOSAN PHARMACEUTICALS, INC., WILMINGTON, NC,
USV PHARMACEUTICAL CORPORATION, TUCKAHOE,
NY:
942,613, REN. 4-11-02. U.S. CL. 18 (INT. CL. 5).
- NERENBERG, ALBERT:
See—TRAILERVISION, INC.
- NESTOR SALES CO., INC.:
See—NESTOR SALES LLC.
- NESTOR SALES LLC, LARGO, FL FROM NESTOR SALES
CO., INC., LARGO, FL:
2,570,562, PUB. 1-9-2001. MULTIPLE CLASS, INT. CLS. 4,
6, 7, 8, 9, 11, 12, 17 AND 20.
- NET BOOLEAN INCORPORATED, REDWOOD CITY, CA:
2,570,552, PUB. 2-26-2002. INT. CL. 35.
- NET INSIGHT AB, S-117 43 STOCKHOLM, SWEDEN:
2,571,834, MULTIPLE CLASS, INT. CLS. 9, 37, 41 AND 42.
- NETDECIDE CORP., FALLS CHURCH, VA:
2,570,891, PUB. 2-26-2002. INT. CL. 9.
2,570,892, PUB. 2-26-2002. INT. CL. 9.
2,570,893, PUB. 2-26-2002. INT. CL. 9.
2,570,894, PUB. 2-26-2002. INT. CL. 9.
2,570,895, PUB. 2-26-2002. INT. CL. 9.
- NETWORLD ALLIANCE, LLC, LOUISVILLE, KY:
2,572,143, MULTIPLE CLASS, INT. CLS. 35 AND 38.
- NEVADA FEET, INC., WEST NYACK, NY:
2,571,490, PUB. 2-26-2002. INT. CL. 25.
- NEW ENGLAND ART PUBLISHERS, INC., NORTH ABING-
TON, MA:
2,571,909, INT. CL. 16.
- NEW ENGLAND LABORERS HEALTH & SAFETY FUND,
PROVIDENCE, RI:
2,570,835, PUB. 2-26-2002. INT. CL. 42.
- NEW LEAF ENTERTAINMENT, DEERFIELD BEACH, FL:
1,886,271, CANC. INT. CL. 35.
- NEW PROCESS STEEL, L.P., HOUSTON, TX:
2,572,005, INT. CL. 6.
- NEW WIRELESS SERVICES, INC., WOBURN, MA:
2,572,027, INT. CL. 36.
- NEW YORK GLOVE CO., INC., NEW YORK, NY:
1,149,910, CANC. INT. CL. 25.
- NEW YORK HALL OF SCIENCE, FLUSHING MEADOWS
CORONA PARK, NY:
2,572,038, MULTIPLE CLASS, INT. CLS. 38, 41 AND 42.
- NEW YORK RIDING PROGRAM FOR THE HANDI-
CAPPED, INC., NEW YORK, NY:
1,639,441, CANC. INT. CL. 41.
- NEW YORK STATE OFFICE FOR TECHNOLOGY, AL-
BANY, NY:
2,571,012, PUB. 2-26-2002. INT. CL. 42.
2,571,013, PUB. 2-26-2002. INT. CL. 38.
- NEW ZEALAND RUGBY FOOTBALL UNION INC., WELL-
INGTON 1, DX SP20064, NEW ZEALAND:
2,570,598, PUB. 2-26-2002. MULTIPLE CLASS, INT. CLS.
18, 25, 28 AND 41.
- NEWBRIDGE PARTNERS LLC, NEW YORK, NY:
2,571,121, PUB. 12-18-2001. INT. CL. 36.
- NEWCOURT CREDIT GROUP, TORONTO, ONTARIO,
CANADA:
1,886,316, CANC. INT. CL. 36.
- NEWPATH COMMUNICATIONS, L.C.:
See—NEWWPATH HOLDING, INC.
- NEWSTED, JASON, SAN FRANCISCO, CA:
2,571,742, INT. CL. 25.
- NEWEST MEZZANINE FUND LP, DENVER, CO:
2,571,223, PUB. 2-26-2002. INT. CL. 36.
- NEWWPATH HOLDING, INC., DOWNERS GROVE, IL
FROM NEWWPATH COMMUNICATIONS, L.C., DES
MOINES, IA:
2,570,593, PUB. 2-26-2002. INT. CL. 38.
- NEXUS TECHNOLOGIES, CHATEAURENARD, FRANCE:
2,570,728, PUB. 6-5-2001. MULTIPLE CLASS, INT. CLS. 40
AND 42.
- NEXXUS PRODUCTS COMPANY, GOLETA, CA:
2,571,352, PUB. 2-26-2002. INT. CL. 3.
- NFP PHOTO, SAN FRANCISCO, CA:
2,571,340, PUB. 2-26-2002. INT. CL. 40.
- NIAGARA FRONTIER HOCKEY, L.P., BUFFALO, NY:
1,675,182, REN. 4-6-02. INT. CL. 25.
1,675,926, REN. 4-6-02. INT. CL. 25.
- NIELSEN MEDIA RESEARCI, INC., NEW YORK, NY:
2,572,374, INT. CL. 9.
- NIETO, EDUARDO, LOS ANGELES, CA:
2,571,702, INT. CL. 40.
- NIIT (USA), INC., ATLANTA, GA:
2,571,857, INT. CL. 41.
- NIKE, INC., BEAVERTON, OR:
2,571,314, PUB. 2-26-2002. MULTIPLE CLASS, INT. CLS.
25 AND 28.
2,571,726, MULTIPLE CLASS, INT. CLS. 18, 25 AND 28.
- NIKKEN USA, INC., IRVINE, CA:
2,570,757, PUB. 1-9-2001. INT. CL. 5.
- NIMS ASSOCIATES, INC., ROCKFORD, IL:
2,571,143, PUB. 2-26-2002. INT. CL. 42.
- NINA FOOTWEAR CORP, NEW YORK, NY, NINA FOOT-
WEAR CO., INC., NEW YORK, NY:
1,190,045, REN. 4-6-02. INT. CL. 25.
- NINE WEST DEVELOPMENT CORPORATION, WHITE
PLAINS, NY:
2,571,795, MULTIPLE CLASS, INT. CLS. 1, 3 AND 21.
- NIPPON DENSIN DENWA KABUSHIKI KAISHA DBA
NIPPON TELEGRAPH AND TELEPHONE CORPORA-
TION:
See—NTT COMMUNICATIONS KABUSHIKI KAISHA.
- NIPPON VALQUA INDUSTRIES, LTD., TOKYO, JAPAN:
2,570,551, PUB. 2-26-2002. INT. CL. 17.
- NISSEI INDUSTRY CO., LTD., SHIZUOKA 424-0055, JAPAN:
2,572,050, INT. CL. 11.
- NISUS HOLDINGS, INC., NEW YORK, NY:
2,571,570, PUB. 2-26-2002. INT. CL. 42.
- NIX COMPANY LTD., BUNKYO-KU, TOKYO, JAPAN:
2,571,984, INT. CL. 10.
- NMW, INC., INDIANAPOLIS, IN:
2,571,072, PUB. 2-26-2002. INT. CL. 17.
- NMXS.COM, INC., ALBUQUERQUE, NM:
2,570,714, PUB. 2-26-2002. INT. CL. 42.

- NOKIA NETWORKS OY, FIN-00045 ESPOO, FINLAND FROM NOKIA TELECOMMUNICATIONS OY, 02150 ESPOO, FINLAND:
2,570,544, PUB. 2-26-2002. INT. CL. 9.
- NOKIA TELECOMMUNICATIONS, NOKIA GROUP, FINLAND:
2,570,527, PUB. 2-26-2002. MULTIPLE CLASS, INT. CLS. 9, 37 AND 38.
- NOKIA TELECOMMUNICATIONS OY:
See— NOKIA NETWORKS OY.
- NOODE', LLC, NEW YORK, NY FROM 972 DEAD SEA SPA, L.L.C., GREAT NECK, NY:
2,572,149, INT. CL. 3.
- NORDSON CORPORATION, WESTLAKE, OH:
2,571,387, PUB. 2-26-2002. INT. CL. 7.
- NORDSTROM, INC., SEATTLE, WA:
2,389,457, COR. INT. CL. 18.
- NORMA KAMALI, INC., NEW YORK, NY:
1,149,887, CANC. MULTIPLE CLASS, INT. CLS. 25 AND 42.
- NORMAN, FOX & CO., CITY OF COMMERCE, CA:
1,676,447, REN. 4-10-02. MULTIPLE CLASS, INT. CLS. 1 AND 4.
- NORSTAR CONSUMER PRODUCTS CO., INC., NORTHVALE, NJ:
2,571,041, PUB. 2-26-2002. INT. CL. 5.
- NORTEL NETWORKS INC., NASHVILLE, TN, NORTHERN TELECOM LIMITED, MONTREAL, QUEBEC, CANADA:
1,681,819, REN. 4-12-02. INT. CL. 9.
- NORTH AMERICAN CARROUSEL, INC., ST. PAUL, MN:
1,886,376, CANC. INT. CL. 41.
- NORTH AMERICAN COALITION ON RELIGION AND ECOLOGY, WASHINGTON, DC:
2,570,697, PUB. 2-26-2002. INT. CL. 41.
- NORTH AMERICAN MISSION BOARD OF THE SOUTHERN BAPTIST CONVENTION, INC., THE, ALPHARETTA, GA:
2,571,367, PUB. 2-26-2002. INT. CL. 41.
- NORTH CAROLINA STATE UNIVERSITY, RALEIGH, NC:
2,570,679, PUB. 2-26-2002. MULTIPLE CLASS, INT. CLS. 38 AND 41.
- NORTH STAR ICE EQUIPMENT CORPORATION, SEATTLE, WA:
1,719,435, REN. 4-6-02. INT. CL. 11.
- NORTHEAST GARAGE DOOR SYSTEMS, LLC, BRISTOL, CT:
2,570,690, PUB. 2-26-2002. INT. CL. 37.
- NORTHEAST PRODUCTS CO., FALL RIVER, MA, U.S. OIL COMPANY, EAST PROVIDENCE, RI:
292,693, REN. 4-10-02. U.S. CL. 15 (INT. CL. 4).
- NORTHERN COMPUTERS, INC., SYOSSET, NY:
1,713,215, REN. 4-6-02. INT. CL. 9.
1,717,673, REN. 4-6-02. INT. CL. 9.
- NORTHERN STAR INDUSTRIES, INC., IRON MOUNTAIN, MI FROM M.J. ELECTRIC, INC., IRON MOUNTAIN, MI:
2,571,855, INT. CL. 9.
- NORTHROP CORPORATION:
1,149,677, CANC. MULTIPLE CLASS, INT. CLS. 9 AND 12.
- NORTON PACKAGING, INC., HAYWARD, CA, B.W. NORTON MANUFACTURING CO., INC., HAYWARD, CA:
1,675,116, REN. 4-10-02. INT. CL. 20.
- NORTON PERFORMANCE PLASTICS CORPORATION, WAYNE, NJ:
2,571,717, INT. CL. 17.
- NOVAGEN, INC., MADISON, WI:
2,571,378, PUB. 2-26-2002. INT. CL. 1.
- NOVARTIS CONSUMER HEALTH, INC., SUMMIT, NJ, WARREN-TEED PRODUCTS COMPANY, THE, COLUMBUS, OH:
716,041, REN. 4-11-02. U.S. CL. 18 (INT. CL. 5).
- NOVATOR AB, S-113 47 STOCKHOLM, SWEDEN:
2,571,764, MULTIPLE CLASS, INT. CLS. 7 AND 8.
- NOW AND ZEN, INC., PINE PLAINS, NY:
2,571,128, PUB. 2-26-2002. INT. CL. 9.
- NOW CORPORATION, ORION, MI:
2,571,508, PUB. 2-26-2002. INT. CL. 38.
- NTT COMMUNICATIONS KABUSHIKI KAISHA, TOKYO, JAPAN, DBA NTT COMMUNICATIONS CORPORATION FROM NIPPON DENSHIN DENWA KABUSHIKI KAISHA, SHINJUKU-KU, TOKYO, JAPAN, DBA NIPPON TELEGRAPH AND TELEPHONE CORPORATION:
2,570,506, PUB. 2-26-2002. INT. CL. 38.
- NU PERFECT, INC., WOODSIDE, NY:
2,571,098, PUB. 2-26-2002. INT. CL. 26.
- NUCLEAR MANAGEMENT COMPANY, LLC, MILWAUKEE, WI:
2,571,929, INT. CL. 35.
2,571,932, INT. CL. 35.
- NUNEZ, BRIAN, FT. LAUDERDALE, FL:
2,572,032, INT. CL. 41.
- NUSIL TECHNOLOGY, CARPINTERIA, CA:
2,570,589, PUB. 2-26-2002. INT. CL. 42.
- NUTEK INTERNATIONAL, INC., WILMINGTON, DE:
2,571,564, PUB. 2-26-2002. INT. CL. 1.
- NUTRA-SOURCE CORPORATION, NEPTUNE, NJ, TA LIFE SERVICES NETWORK:
1,905,267, CANC. INT. CL. 5.
- NYFIX, INC., STAMFORD, CT:
2,571,553, PUB. 2-26-2002. INT. CL. 9.
- NYLINT CORPORATION, ROCKFORD, IL:
2,570,825, PUB. 2-26-2002. INT. CL. 28.
- O.P.E.N. AMERICA, INC., PHOENIX, AZ:
2,570,926, PUB. 2-26-2002. INT. CL. 37.
- O-SUNG KNY CO., LTD., KYUNGKI-DO, REPUBLIC OF KOREA:
2,571,779, INT. CL. 42.
- O'BRIEN, THOMAS N., ANN ARBOR, MI:
1,886,553, CANC. INT. CL. 9.
- O'ROURKE BROS. DISTRIBUTING, INC., MOLINE, IL:
1,886,303, CANC. INT. CL. 36.
- OASIS VINEYARD, INC., HUME, VA:
2,570,780, PUB. 2-26-2002. INT. CL. 33.
- OBJECTLAND, INC., BOULDER, CO:
1,885,912, CANC. INT. CL. 9.
- OBJECTWORKS, INC., CALGARY, ALBERTA T2P 3N2, CANADA:
2,570,505, PUB. 11-7-2000. MULTIPLE CLASS, INT. CLS. 9 AND 42.
- OBSOLETE, INC., VENICE, CA:
2,570,975, PUB. 2-26-2002. INT. CL. 35.
- OCCIDENTAL PETROLEUM CORPORATION, LOS ANGELES, CA, OCCIDENTAL PETROLEUM CORPORATION, LOS ANGELES, CA:
938,422, REN. 4-6-02. U.S. CL. 6 (INT. CL. 1).
- OCHOA, JAVIER, ZAPOPAN, MEXICO:
2,572,208, INT. CL. 25.
- ODETT, KIETH, CARPINTERIA, CA:
2,571,346, PUB. 2-26-2002. INT. CL. 41.
- ODYSSEY HOLDINGS, L.L.C., NEW YORK, NY FROM F & V CHANNEL, L.L.C., NEW YORK, NY:
2,571,692, INT. CL. 41.
- OH COMPANY, THE, LOS ANGELES, CA:
2,571,920, INT. CL. 36.
- OHIO VALLEY A.F.M., INC., COLD SPRING, KY:
1,677,799, REN. 4-10-02. INT. CL. 30.
- OHMY ENTERPRISES, INC., SUNNYVALE, CA:
2,571,557, PUB. 2-26-2002. INT. CL. 42.
- OIL-DRI CORPORATION OF AMERICA, CHICAGO, IL:
722,480, REN. 4-9-02. U.S. CL. 10 (INT. CL. 1).
- OLD BALDY CORPORATION, SARATOGA, WY:
1,203,117, REN. 4-10-02. INT. CL. 41.
- OLD FLORENCE S.R.L., I-52100 AREZZO, ITALY:
2,571,108, PUB. 2-26-2002. INT. CL. 14.
- OLD TIME POTTERY, INC., MURFREESBORO, TN:
2,570,772, PUB. 2-26-2002. INT. CL. 26.
2,570,773, PUB. 2-26-2002. INT. CL. 22.
2,570,774, PUB. 2-26-2002. INT. CL. 22.
- OLDHORSES.COM, INC., PRINCETON, NJ:
2,571,475, PUB. 2-26-2002. INT. CL. 35.
- OLSTEN STAFFING SERVICES V, INC., MELVILLE, NY:
1,639,394, CANC. INT. CL. 35.
- OLY HOLIGAN, L.P., DALLAS, TX:
2,572,085, INT. CL. 9.

- OMEGA HEALTH SYSTEMS, INC., MEMPHIS, TN TO VISIONAMERICA INCORPORATED, MEMPHIS, TN: 2,066,256, AM. MULTIPLE CLASS, INT. CLS. 35 AND 42.
- OMEGA RUBBER PRODUCTS, INC., FT. WAYNE, IN: 1,149,809, CANC. INT. CL. 17.
- OMX, INC., LAS VEGAS, NV: 2,571,412, PUB. 2-26-2002. INT. CL. 35.
- ONE VENTURES, INC., SAN FRANCISCO, CA: 2,570,827, PUB. 2-26-2002. MULTIPLE CLASS, INT. CLS. 16 AND 42.
- ONECREDITSOURCE.COM, LLC, LAKE OSWEGO, OR: 2,570,751, PUB. 1-30-2001. INT. CL. 36.
- OPENMIND SOFTWARE TECHNOLOGIES GMBH, 85774 UNTERFOHRING, FED REP GERMANY: 2,570,628, PUB. 6-26-2001. MULTIPLE CLASS, INT. CLS. 9, 16, 41 AND 42.
- OPERATING TAX SPECIALISTS, INC.:
See— OPERATING TAX SYSTEMS, LLC.
- OPERATING TAX SYSTEMS, LLC, STOW, OH FROM OPERATING TAX SPECIALISTS, INC., PEMBROKE PINES, FL: 2,572,314, INT. CL. 9.
- OPTABS LIMITED, BRADFORD, YORK, ENGLAND: 385,957, CANC. U.S. CL. 18.
- OPTION-NFA INC., VANCOUVER, BC V6A 2J1, CANADA: 2,571,332, PUB. 2-26-2002. MULTIPLE CLASS, INT. CLS. 25 AND 28.
- ORA SMITH, D.B.A., DUDLEY NC: 386,054, CANC. U.S. CL. 51.
- ORATRONICS, INC., NEW YORK, NY: 1,681,082, REN. 4-8-02. INT. CL. 10.
- ORCAL, INC., JUNCTION CITY, OR: 2,571,283, PUB. 2-26-2002. INT. CL. 5.
- ORCHID MANUFACTURING CO., NEW YORK, NY: 1,705,115, REN. 4-10-02. INT. CL. 25.
- ORE-IDA FOODS, INC., BOISE, ID: 713,263, CANC. U.S. CL. 46.
- ORFEVRENERIE CHRISTOFLE, 75008 PARIS, FRANCE: 1,677,373, REN. 4-10-02. INT. CL. 8.
- ORICA AUSTRALIA PTY LTD, MELBOURNE, VICTORIA, 3000, AUSTRALIA: 2,570,535, PUB. 9-4-2001. INT. CL. 1.
2,570,536, PUB. 9-4-2001. INT. CL. 39.
2,570,537, PUB. 9-4-2001. INT. CL. 40.
- ORICA AUSTRALIA PTY LTD, MELBOURNE, VICTORIA, 3000, AUSTRALIA FROM ICI AUSTRALIA OPERATIONS PROPRIETARY LIMITED, VICTORIA, 3000, AUSTRALIA: 2,570,523, PUB. 9-4-2001. INT. CL. 1.
- ORIGINAL APPALACHIAN ARTWORKS, INC., CLEVELAND, GA: 1,191,258, REN. 4-7-02. INT. CL. 28.
1,193,440, REN. 4-7-02. INT. CL. 28.
- ORII & MEC CORPORATION, KAWAGUCHI-SHI, SAITAMA, JAPAN: 2,572,177, INT. CL. 7.
- ORION PACKAGING SYSTEMS, INC., MEMPHIS, TN: 2,572,041, INT. CL. 7.
- ORLANDO MAGIC, LTD., ORLANDO, FL: 2,571,959, INT. CL. 25.
- OSBORN GROUP INC, OLATHE, KS, OSBORN LABORATORIES INC., SHAWNEE MISSION, KS: 1,643,834, REN. 4-9-02. INT. CL. 35.
- OSCAR DE LA HOYA ENTERPRISES, INC.:
See— GOLDEN BOY ENTERPRISES, LLC.
- OSKER'S, PLACERVILLE, CA: 2,570,647, PUB. 11-6-2001. INT. CL. 30.
- OSPREY PACKS, INC., CORTEZ, CO: 2,571,330, PUB. 2-26-2002. INT. CL. 18.
- OSSIAN CHEMICAL, INC., DAVENPORT, IA: 1,149,569, CANC. INT. CL. 5.
- OUR FOOD PRODUCTS GROUP, INC., BUDA, TX, TEXSTAR RESOURCES (USA), INC., BUDA, TX, DBA JARDINE'S TEXAS FOODS: 1,675,992, REN. 4-12-02. INT. CL. 29.
1,684,576, REN. 4-12-02. INT. CL. 30.
- OUTRAGEOUS RUGS INTERNATIONAL, INC., SAN DIEGO, CA: 1,730,003, REN. 4-8-02. INT. CL. 42.
- OVERMAN, KATHLEEN, J., NORFOLK, VA: 2,572,000, INT. CL. 9.
- OVERREAD.COM, INC., PLEASANTON, CA: 2,572,296, INT. CL. 39.
- OXIS HEALTH PRODUCTS, INC., PORTLAND, OR: 2,570,845, PUB. 2-26-2002. MULTIPLE CLASS, INT. CLS. 35 AND 42.
- OXYMORON CORPORATION, DALLAS, TX: 1,886,560, CANC. INT. CL. 9.
1,886,561, CANC. INT. CL. 9.
- OZBURN-JANESVILLE CORPORATION, JANESVILLE, WI: 1,149,800, CANC. INT. CL. 16.
1,149,801, CANC. INT. CL. 16.
- PA RESOURCES CORP., DUNMORE, PA: 2,572,380, INT. CL. 35.
- PACIFIC COAST FEATHER CO., INC., SEATTLE, WA: 1,690,212, REN. 4-6-02. INT. CL. 20.
1,829,858, AM. INT. CL. 20.
- PACIFIC COAST REALTY SERVICES, INC., IRVINE, CA: 2,570,612, PUB. 2-26-2002. INT. CL. 35.
- PACIFIC GAMBLE ROBINSON CO., SEATTLE, WA, DBA RYAN FRUIT CO.: 713,252, CANC. U.S. CL. 46.
- PACIFIC HEALTH ADVANTAGE, SAN FRANCISCO, CA: 2,571,002, PUB. 2-26-2002. INT. CL. 36.
- PACIFIC HEMOSTASIS LABORATORY, INC., BAKERSFIELD, CA TO FISHER SCIENTIFIC COMPANY LLC, HAMPTON, NH: 1,173,752, AM. INT. CL. 1.
- PACIFIC LAW GROUP LLP, SAN JOSE, CA: 2,571,485, PUB. 2-26-2002. INT. CL. 42.
- PACIFIC TELESIS GROUP, SAN FRANCISCO, CA: 1,886,265, CANC. INT. CL. 35.
- PACIFICA FOUNDATION, WASHINGTON, DC: 2,571,290, PUB. 2-26-2002. INT. CL. 42.
- PACIFICA, INC., PORTLAND, OR: 2,572,317, INT. CL. 4.
- PADILLA, JUAN, WALNUT, CA: 2,571,487, PUB. 2-26-2002. INT. CL. 42.
- PAINT THE TOWN RED, INC., NEW YORK, NY: 1,886,278, CANC. MULTIPLE CLASS, INT. CLS. 35 AND 41.
- PAINTER ONE CORPORATION, WILLOUGHBY, OH: 1,886,328, CANC. INT. CL. 37.
- PAINTERS FOR HIRE INC., ST PETERSBURG, FL: 2,571,004, PUB. 2-26-2002. INT. CL. 37.
- PAL, CARRY ON!, INC., SAN DIEGO, CA: 1,886,054, CANC. INT. CL. 18.
- PALISADE SYSTEMS, INC., AMES, IA: 2,571,091, PUB. 2-26-2002. INT. CL. 9.
- PAN AMERICAN COFFEE CO., INC., HOBOKEN, NJ: 1,675,249, REN. 4-6-02. INT. CL. 30.
- PANKL AEROSPACE SYSTEMS, CERRITOS, CA: 2,572,379, INT. CL. 12.
- PANTONE, INC., CARLSTADT, NJ: 1,995,095, COR. INT. CL. 42.
- PAOLINI, SALVATORE, ENDICOTT, NY AND BAMBARA, JOSEPH J., ENDICOTT, NY: 2,570,990, PUB. 2-26-2002. INT. CL. 25.
- PAPER-PAK PRODUCTS, INC., SAN DIMAS, CA: 1,678,469, REN. 4-6-02. INT. CL. 16.
- PARA-CHEM SOUTHERN, INC., SIMPSONVILLE, SC: 1,680,899, REN. 4-9-02. INT. CL. 1.
- PARABLE LLC, NEWTON, MA TO PARABLE LLC, NEWTON, MA: 2,313,279, COR. INT. CL. 9.
- PARACELSIAN, INC., ITHACA, NY: 1,886,596, CANC. INT. CL. 10.
- PARAGON TECHNOLOGY, INC., STATE COLLEGE, PA: 1,885,916, CANC. INT. CL. 9.
- PARAMAGNETIC LOGGING, INC., WOODINVILLE, WA: 1,886,549, CANC. INT. CL. 9.
- PARAMOUNT PICTURES CORPORATION, LOS ANGELES, CA: 1,674,277, REN. 4-10-02. INT. CL. 21.
- PARENTAL STRESS CENTER, INC., THE, PITTSBURGH, PA: 1,875,627, CANC. INT. CL. 41.

- PARFUMS DE COEUR, LTD., DARIEN, CT:
2,571,581, PUB. 2-26-2002. INT. CL. 3.
- PARIS STAR KNITTING MILLS INC., MONTREAL, QUEBEC, CANADA:
1,886,643, CANC. INT. CL. 25.
- PARKER MARKETING RESEARCH, INC., MILFORD, OH:
2,572,012, INT. CL. 35.
- PARKER PEN (I.P) LIMITED, MIDDLESEX TW7 5NP, ENGLAND:
1,885,981, CANC. INT. CL. 16.
- PARLETT, ISABEL, SANTA FE, NM:
2,535,352, COR. INT. CL. 41.
- PARTEK FOREST AB, S-904 04 UMEA, SWEDEN:
2,572,001, INT. CL. 37.
- PASCAL COMPANY, INC., BELLEVUE, WA:
1,220,518, REN. 4-12-02. INT. CL. 5.
- PASCAL, FRANCINE, NEW YORK, NY:
1,681,183, REN. 4-10-02. INT. CL. 16.
- PASSE, JAMES G., RALEIGH, NC:
2,571,206, PUB. 2-26-2002. INT. CL. 41.
- PASSION FOOD TWO, LLC, WASHINGTON, DC:
2,570,856, PUB. 2-26-2002. INT. CL. 42.
- PASTA JAY'S, INCORPORATED, BOULDER, CO:
1,886,416, CANC. INT. CL. 42.
- PASTAZIOS PIZZA, INC., ADDISON, TX:
2,571,377, PUB. 2-26-2002. INT. CL. 42.
- PATERNO, JOSEPH, STATE COLLEGE, PA:
2,572,061, MULTIPLE CLASS, INT. CLS. 35 AND 38.
- PATHFINDER CONSULTING GROUP, LLC, THE, GOLD RIVER, CA:
2,570,621, PUB. 10-16-2001. INT. CL. 35.
- PATHOLOGY SERVICES P.A., TOPEKA, KS:
2,572,384, INT. CL. 42.
- PATRICIA GALLUP & DAVID HALL, GILSUM, NH AND HALL, DAVID, GILSUM, NH TO PATRICIA GALLUP & DAVID HALL, GILSUM, NH AND HALL, DAVID, GILSUM, NH:
1,902,236, CANC. INT. CL. 41.
- PAUL FRANK INDUSTRIES, INC., NEWPORT BEACH, CA:
2,571,471, PUB. 2-26-2002. INT. CL. 14.
- PAWN SHOP, INC., ARLINGTON, VA:
1,150,078, CANC. INT. CL. 42.
- PAYMENT, ELIZABETH, FLANDERS, NJ:
2,571,156, PUB. 10-16-2001. INT. CL. 35.
- PCT INTERNATIONAL, INC., GILBERT, AZ FROM PHOENIX COMMUNICATION TECHNOLOGIES INTERNATIONAL, GILBERT, AZ:
2,571,832, INT. CL. 9.
- PE CORPORATION, FOSTER CITY, CA:
2,572,147, INT. CL. 9.
- PEABODY ENGINEERING CORPORATION, SHELTON, CT, PEABODY ENGINEERING CORPORATION, NEW YORK, NY:
724,823, REN. 4-9-02. U.S. CL. 34 (INT. CLS. 7 AND 11).
- PEABODY MANAGEMENT, INC., MEMPHIS, TN:
2,570,836, PUB. 2-26-2002. INT. CL. 24.
- PEACE PILLOWS, INC., DETROIT, MI:
1,886,619, CANC. INT. CL. 20.
- PEACEBIKE, LAFAYETTE, OR:
2,571,271, PUB. 2-26-2002. INT. CL. 41.
- PEAKCARE, LLC, ENGLEWOOD, CO:
2,571,715, INT. CL. 9.
- PEASE INDUSTRIES, INC., FAIRFIELD, OH:
1,639,105, CANC. INT. CL. 19.
- PECHACEK, SUSAN, AUSTIN, TX AND BLOOM, MARY JO, AUSTIN, TX:
1,886,658, CANC. INT. CL. 25.
- PECK, VICTOR H. JR., ALEXANDRIA, VA:
2,571,343, PUB. 2-26-2002. INT. CL. 25.
- PEDIA PALS, INC., COLUMBUS, OH TO HNT HOLDINGS ACQUISITION, LLC, PLYMOUTH, MN:
1,952,406, CANC. INT. CL. 10.
- PEDROLLO, S.P.A., 37047 SAN BONIFACIO (VERONA), ITALY:
1,885,812, CANC. INT. CL. 7.
- PEERLESS CARPET CORPORATION:
See— BEAULIEU CANADA COMPANY.
- PEGASUS COMMUNICATIONS CORPORATION, BALA CYNWYD, PA:
2,571,145, PUB. 2-26-2002. INT. CL. 38.
- PEGASYSYSTEMS INC., CAMBRIDGE, MA:
2,571,516, PUB. 2-26-2002. INT. CL. 9.
- PEL-FREEZ CLINICAL SYSTEMS, LLC, BROWN DEER, WI:
2,571,444, PUB. 2-26-2002. INT. CL. 9.
- PENN FISHING TACKLE MFG. CO., PHILADELPHIA, PA:
1,675,235, REN. 4-10-02. INT. CL. 28.
- PENN, MICHAEL, LOS ANGELES, CA:
2,572,092, INT. CL. 9.
- PENNSYLVANIA HISTORICAL AND MUSEUM COMMISSION, HARRISBURG, PA:
2,572,302, INT. CL. 41.
- PENSKE TRUCK LEASING CO., L.P., READING, PA:
2,572,422, INT. CL. 39.
- PEOPLE DESIGN TECHNOLOGY, LLC:
See— ANYWHEREYOUGO.COM, INC..
- PEOPLELINK, INC., SANTA MONICA, CA:
2,570,716, PUB. 2-26-2002. INT. CL. 38.
- PEOPLES, INC., LAWRENCE, KS:
2,571,333, PUB. 2-26-2002. INT. CL. 36.
- PERCUDISC INC., NEW YORK, NY:
1,704,192, REN. 4-8-02. INT. CL. 10.
- PERFECTION CORPORATION, MADISON, OH:
1,678,399, REN. 4-8-02. INT. CL. 11.
- PERFECTION HY-TEST COMPANY, TIMMONSVILLE, SC:
1,999,582, CANC. INT. CL. 7.
- PERFORMANCE SYSTEMS INTERNATIONAL, INC., RESTON, VA:
1,886,337, CANC. INT. CL. 38.
- PERI & SONS FARMS, INC., YERINGTON, NV, DBA PERI & SONS FARMS:
1,695,622, REN. 4-8-02. INT. CL. 31.
- PERKINELMER INSTRUMENTS LLC, NORWALK, CT:
2,572,019, INT. CL. 9.
- PERMACRETE SYSTEMS LIMITED, DARTMOUTH, NOVA SCOTIA, CANADA:
1,877,986, CANC. INT. CL. 37.
- PERRY MAINTENANCE & COMPLIANCE, INC., EAST CHICAGO, IN:
1,639,276, CANC. INT. CL. 37.
- PERSONAL CLIMATE CONTROL, INC., HOUSTON, TX FROM LAVIN, EDWARD F., JR., HOUSTON, TX:
2,571,870, MULTIPLE CLASS, INT. CLS. 10 AND 28.
- PES INC., SPRING, TX:
2,570,764, PUB. 2-26-2002. MULTIPLE CLASS, INT. CLS. 7, 9 AND 42.
- PETER J. LISTRO ASSOCIATES, LTD., NEW YORK, NY:
2,571,016, PUB. 2-26-2002. INT. CL. 9.
- PETER PAN INDUSTRIES, NEWARK, NJ:
1,886,636, CANC. INT. CL. 21.
- PETER RABBIT FARMS, INC., COACHELLA, CA, CARDINAL DISTRIBUTING COMPANY, INC., COACHELLA, CA, AKA CARDINAL DISTRIBUTING CO.:
1,196,384, REN. 4-6-02. INT. CL. 31.
- PETERSON MACHINE TOOL, INC., SHAWNEE MISSION, KS:
1,639,334, CANC. INT. CL. 7.
- PETRO-CANADA, CALGARY, ALBERTA, CANADA:
2,570,555, PUB. 2-26-2002. INT. CL. 36.
2,570,556, PUB. 2-26-2002. INT. CL. 36.
- PFIZER INC., NEW YORK, NY:
713,278, CANC. U.S. CL. 51.
713,287, CANC. U.S. CL. 51.
- PFIZER INC., NEW YORK, NY, BEECHAM INC., CLIFTON, NJ:
1,189,087, REN. 4-6-02. INT. CL. 5.
- PHALANX CORPORATION, BOCA RATON, FL:
2,572,243, INT. CL. 13.
- PHARMACIA INCORPORATED, PISCATAWAY, NJ:
715,774, CANC. U.S. CL. 31.
- PHARMACIA LKB BIOTECHNOLOGY AB, S-751 82 UPPSALA, SWEDEN:
1,885,892, CANC. INT. CL. 9.
- PHARMACY BUYING ASSOCIATION, INC., KANSAS CITY, MO:
2,571,464, PUB. 2-26-2002. INT. CL. 42.

- PHARMATON S.A., CH-6934 BIOGGIO, SWITZERLAND:
1,885,783, CANC. INT. CL. 5.
- PHARMED GROUP HOLDINGS, INC., MIAMI, FL:
2,571,135, PUB. 2-26-2002. INT. CL. 5.
2,571,268, PUB. 2-26-2002. INT. CL. 5.
2,571,269, PUB. 2-26-2002. INT. CL. 5.
- PHILADELPHIA CHEWING GUM CORPORATION, HAVERTOWN, PA:
2,572,364, INT. CL. 30.
- PHILIP MORRIS INCORPORATED, NEW YORK, NY:
938,510. REN. 4-12-02. U.S. CL. 17 (INT. CL. 34).
1,150,011, CANC. INT. CL. 35.
1,687,301. REN. 4-12-02. INT. CL. 34.
1,693,472. REN. 4-12-02. INT. CL. 34.
1,693,473. REN. 4-12-02. INT. CL. 34.
- PHILIP MORRIS INCORPORATED, NEW YORK, NY, DBA COLLECTOR'S CHOICE:
1,693,474. REN. 4-12-02. INT. CL. 34.
- PHILIPS ELECTRONICS N.V., EINDHOVEN, NETHERLANDS:
1,886,556, CANC. INT. CL. 9.
- PHILIPS ELECTRONICS N.V.:
See—KONINKLIJKE PHILIPS ELECTRONICS N.V.
- PHILLIPS, STEVEN D., COLUMBUS, OH:
1,886,385, CANC. INT. CL. 41.
- PHOCUSWRIGHT, INC., SHERMAN, CT:
2,570,949, PUB. 2-26-2002. INT. CL. 16.
- PHOEBE PUTNEY MEMORIAL HOSPITAL, ALBANY, GA:
1,882,693, CANC. INT. CL. 42.
- PHOENIX PACKAGING, INC., PLANO, TX:
2,571,532, PUB. 2-26-2002. INT. CL. 16.
- PHONAK HOLDING AG, CH-8712 STAFA, SWITZERLAND:
2,570,495, PUB. 9-25-2001. INT. CL. 10.
2,570,496, PUB. 8-28-2001. INT. CL. 10.
2,570,497, PUB. 8-28-2001. INT. CL. 10.
2,570,498, PUB. 8-14-2001. INT. CL. 10.
2,570,499, PUB. 8-28-2001. INT. CL. 10.
- PHOSPHATE RESOURCE PARTNERS LIMITED PARTNERSHIP, LAKE FOREST, IL, FREEPORT-MCMORAN RESOURCE PARTNERS, NEW ORLEANS, LA, DBA AGRICO CHEMICAL COMPANY:
1,666,342. REN. 4-9-02. INT. CL. 1.
- PHUTURECORP, INC., HENDERSON, NV:
2,570,831, PUB. 2-26-2002. INT. CL. 42.
- PHYLLIS G. THEROUX, ASHLAND, VA, DBA NIGHTWRITERS, INC.:
2,571,320, PUB. 2-26-2002. INT. CL. 41.
- PHYSICAL MARKET, INC., SEATTLE, WA:
2,570,779, PUB. 2-26-2002. INT. CL. 35.
- PHYSICIAN'S CHOICE OF ARIZONA, INC., SCOTTSDALE, AZ:
2,571,997, INT. CL. 3.
- PIE PRACTICAL SOLUTIONS INC., JERSEY CITY, NJ:
1,885,924, CANC. INT. CL. 9.
- PIERCE SALES CO., INC., ORLANDO, FL:
2,570,998, PUB. 2-26-2002. INT. CL. 35.
- PIERRE FABRE DERMO-COSMETIQUE, 92100 BOULOGNE, FRANCE:
2,571,191, PUB. 2-26-2002. INT. CL. 3.
- PIERRE FABRE, S.A., 92100 BOULOGNE, FRANCE AND PIERRE FABRE, S.A., 92100 BOULOGNE, FRANCE:
2,477,327, COR. MULTIPLE CLASS, INT. CLS. 3 AND 5.
- PIERREL FARMACEUTICI S.P.A., 20123 MILAN, ITALY:
2,570,951, PUB. 2-26-2002. MULTIPLE CLASS, INT. CLS. 3 AND 5.
- PILGRIM BAXTER & ASSOCIATES, LTD., WAYNE, PA:
2,571,132, PUB. 2-26-2002. INT. CL. 36.
- PILOT SOFTWARE, INC., BOSTON, MA:
1,885,848, CANC. INT. CL. 9.
- PINEHURST, INC., VILLAGE OF PINEHURST, NC:
2,571,441, PUB. 2-26-2002. INT. CL. 15.
- PINNACLE COACHING ASSCIATES, INC., RICHFIELD, MN:
2,571,313, PUB. 2-26-2002. INT. CL. 41.
- PIO ECHEVERRIA LIZARAZU, 20120 HERNANI (GUIPUZKOA), SPAIN:
1,952,646, COR. INT. CL. 7.
- PISCITELLI, THOMAS J., WOODINVILLE, WA:
2,571,338, PUB. 2-26-2002. INT. CL. 41.
- PITTSBURGH DOWNTOWN PARTNERSHIP, THE, PITTSBURGH, PA:
2,571,390, PUB. 2-26-2002. INT. CL. 41.
- PIVOTAL SOFTWARE INC., NORTH VANCOUVER, BRITISH COLUMBIA, CANADA:
2,410,184, COR. INT. CL. 9.
- PIZZA MAKER INC., THE, WHITE LAKE, MI:
1,679,573, CANC. INT. CL. 30.
- PKHT INVESTMENT COMPANY, WILMINGTON, DE:
1,886,758, CANC. MULTIPLE CLASS, INT. CLS. 9 AND 12.
- PLANALYTICS, INC., WAYNE, PA FROM STRATEGIC WEATHER SERVICES, INC., WAYNE, PA:
2,572,029, INT. CL. 9.
- PLANET EARTH FOUNDATION, SEATTLE, WA:
2,572,306, INT. CL. 35.
- PLATINUM TECHNOLOGY, INC., OAKBROOK TERRACE, IL:
1,868,121, CANC. INT. CL. 9.
1,868,122, CANC. INT. CL. 9.
1,869,383, CANC. INT. CL. 9.
1,869,384, CANC. INT. CL. 9.
1,869,385, CANC. INT. CL. 9.
- PLAUENER SPINNHUTTE GMBH, 08525 PLAUE, FED REP GERMANY:
2,498,840, COR. MULTIPLE CLASS, INT. CLS. 24 AND 25.
- PLAY VISIONS, INC., WOODINVILLE, WA:
2,570,732, PUB. 2-26-2002. INT. CL. 28.
- PLAYSYS.COM, LAS VEGAS, NV:
2,571,518, PUB. 2-26-2002. INT. CL. 41.
- PLAYSYS.COM, INC., LAS VEGAS, NV:
2,571,519, PUB. 2-26-2002. INT. CL. 41.
- PLAYTEX APPAREL, INC., STAMFORD, CT, INTERNATIONAL PLAYTEX, INC., STAMFORD, CT:
1,190,080. REN. 4-6-02. INT. CL. 25.
- PLEASANT COMPANY, MIDDLETOWN, WI FROM HOOS COMMUNICATIONS, INC., NASHVILLE, TN:
2,570,561, PUB. 2-26-2002. INT. CL. 16.
- PLEASANT HOLIDAYS, LLC, WESTLAKE VILLAGE, CA:
2,571,357, PUB. 2-26-2002. INT. CL. 39.
2,571,358, PUB. 2-26-2002. INT. CL. 39.
- PLEASURECRAFT MARINE ENGINE CO., LITTLE MOUNTAIN, SC:
1,698,833. REN. 4-11-02. INT. CL. 9.
- PLOUGH, INC., MEMPHIS, TN:
1,149,795, CANC. INT. CL. 16.
- PLYMOUTH PRODUCTS, INC., SHEBOYGAN, WI:
2,570,885, PUB. 9-18-2001. INT. CL. 11.
- PLYMOUTH PROPERTY LAND OWNER, LLC, PLYMOUTH, MA:
2,571,411, PUB. 2-26-2002. INT. CL. 42.
- PLYMOUTH RUBBER COMPANY, INC., CANTON, MA:
713,246, CANC. U.S. CL. 42.
- PM AG PRODUCTS INCORPORATED, HOMEWOOD, IL:
1,638,866, CANC. INT. CL. 5.
- PM CO. L.L.C., CINCINNATI, OH:
2,572,308, INT. CL. 35.
- PMI MORTGAGE INSURANCE CO., SAN FRANCISCO, CA:
1,886,319, CANC. INT. CL. 36.
- PNEUMOFOR S.P.A., TORINO, ITALY:
2,399,935, COR. INT. CL. 37.
- POCKETPYRO, INC., FORT LAUDERDALE, FL:
2,571,654, PUB. 2-26-2002. INT. CL. 9.
- POETS & WRITERS, INC., NEW YORK, NY:
2,570,795, PUB. 2-26-2002. INT. CL. 16.
- POGOSSIYAN, SEMEN AMAYAKOVICH, YEREVAN, ARMENIA:
2,572,047, INT. CL. 34.
- POLAKOW, JASON NICHOLAS, TORQUAY, VICTORIA 3228, AUSTRALIA:
2,570,651, PUB. 7-10-2001. INT. CL. 28.
- POLARIS INDUSTRIES PARTNER L.P., MINNEAPOLIS, MN:
1,639,356, CANC. INT. CL. 12.

- POLAROID CORPORATION, CAMBRIDGE, MA:
1,885,994, CANC. INT. CL. 16.
- POLYGRAM RECORDS, INC.:
1,149,701, CANC. INT. CL. 9.
- POLYMER ENGINEERING CORP., OXNARD, CA:
1,885,746, CANC. INT. CL. 1.
1,886,048, CANC. INT. CL. 17.
- PONDEROSA, INC., DAYTON, OH:
1,149,965, CANC. MULTIPLE CLASS, INT. CLS. 29 AND 30.
- POOL COVER CORPORATION, HAUPPAUGE, NY:
1,654,203, REN. 4-6-02, INT. CL. 9.
- POPSICLE INDUSTRIES, INC., ENGLEWOOD, NJ:
1,149,979, CANC. INT. CL. 30.
1,149,980, CANC. INT. CL. 30.
- PORCELAIN METALS CORPORATION, LOUISVILLE, KY:
1,885,953, CANC. INT. CL. 11.
- POROX INTERNATIONAL CO., INC., NEW YORK, NY:
1,886,058, CANC. INT. CL. 18.
- PORSCHE DESIGN PRODUKTE VERTRIEBSGESELLSCHAFT M.B.H., OSTERREICH, AUSTRIA TO PORSCHE DESIGN MANGMENTS GMBH & CO KG, OSTERREICH, AUSTRIA:
1,955,838, CANC. INT. CL. 9.
- POST OFFICE, THE:
See— CONSIGNIA P.L.C.
- POSTER.COM, INC., FORT LEE, NJ:
2,572,267, INT. CL. 40.
- POWER MONITORS, INC., HARRISONBURG, VA, SHENANDOAH ELECTRONIC INTELLIGENCE, INCORPORATED, HARRISONBURG, VA:
1,676,617, REN. 4-11-02, INT. CL. 9.
- PPG ARCHITECTURAL FINISHES, PITTSBURGH, PA, PITTSBURG PLATE GLASS COMPANY, PITTSBURGH, PA:
724,128, REN. 4-9-02, U.S. CL. 16 (INT. CL. 2).
- PPG INDUSTRIES OHIO, INC., CLEVELAND, OH:
2,571,848, INT. CL. 2.
- PPT VISION, INC., EDEN PRAIRIE, MN:
2,571,116, PUB. 2-26-2002, INT. CL. 9.
- PRAB, INC., KALAMAZOO, MI:
2,571,363, PUB. 2-26-2002, INT. CL. 7.
- PRADA S.P.A., 20122 MILAN, ITALY TO PREFEL S.A., LUXEMBOURG:
1,869,578, CANC. MULTIPLE CLASS, INT. CLS. 18 AND 25.
- PREMARK FEG L.L.C., WILMINGTON, DE:
1,639,339, CANC. INT. CL. 9.
2,570,992, PUB. 2-26-2002, INT. CL. 16.
- PREMIER BROADCASTING COMPANY, INC., WHITEHALL, OH:
2,571,173, PUB. 2-26-2002, MULTIPLE CLASS, INT. CLS. 29, 30 AND 42.
- PREMIER FOODSERVICE DISTRIBUTORS OF AMERICA, INC., STOCKTON, CA:
2,570,602, PUB. 5-15-2001, INT. CL. 35.
- PREMIER TECHNOLOGIES, INC., APPLETON, WI:
1,886,545, CANC. INT. CL. 9.
- PREMIER WEST BANK, MEDFORD, OR, TIMBERLINE COMMUNITY BANK, YREKA, CA:
1,183,215, REN. 4-10-02, INT. CL. 36.
- PRESBYTERIAN HOME, THE, EVANSTON, IL:
1,685,708, REN. 4-12-02, INT. CL. 42.
- PRESBYTERIAN LAY COMMITTEE, INC., LENOIR, NC:
2,571,112, PUB. 2-26-2002, INT. CL. 16.
- PRESS, GANEY ASSOCIATES, INC., SOUTH BEND, IN:
2,570,703, PUB. 8-7-2001, MULTIPLE CLASS, INT. CLS. 35 AND 42.
- PRI ASSOCIATES, INC., DURHAM, NC:
2,572,270, INT. CL. 9.
- PRI AUTOMATION, INC., BILLERICA, MA:
2,572,068, INT. CL. 9.
- PRICewaterHOUSECOOPERS LLP, NEW YORK, NY:
2,571,370, PUB. 2-26-2002, INT. CL. 35.
- PRIMARY PROVIDER MANAGEMENT COMPANY, INC., SAN DIEGO, CA:
2,572,381, INT. CL. 42.
- PRIMEDIA MAGAZINE FINANCE INC., NEW YORK, NY, INSTITUTE FOR ADVANCEMENT OF SAILING, INC., BOSTON, MA:
934,484, REN. 4-10-02, U.S. CL. 38 (INT. CL. 16).
- PRINCIPAL FINANCIAL GROUP, INC., DES MOINES, IA:
2,571,769, INT. CL. 36.
2,572,372, MULTIPLE CLASS, INT. CLS. 36 AND 41.
- PRINCIPIA ENTERPRISES CORPORATION, TAMPA, FL:
2,570,637, PUB. 8-7-2001, INT. CL. 28.
- PRINSCO, INC., PRINSBURG, MN:
1,639,425, CANC. INT. CL. 17.
- PRINTING FOR SYSTEMS, INC., MADISON, CT:
2,572,102, INT. CL. 16.
- PRINZ VERLAG, GMBH, D-94034, PASSAU, FED REP GERMANY:
1,886,014, CANC. INT. CL. 16.
- PRIORITY CALL MANAGEMENT, INC., WILMINGTON, MA:
1,885,852, CANC. INT. CL. 9.
- PRISMA GRAPHIC SYSTEMS INC., TAIPEI, TAIWAN:
1,667,364, REN. 4-9-02, INT. CL. 9.
- PRIVA SHAVE CORPORATION, STONE MOUNTAIN, GA:
2,571,053, PUB. 2-26-2002, INT. CL. 3.
- PRO GOLF OF AMERICA, INC., FARMINGTON HILLS, MI:
2,571,418, PUB. 2-26-2002, INT. CL. 28.
- PRO GROUP, INC., WESTPORT, CT, CUSTOM LEATHERCRAFT MANUFACTURING CO. INC., LOS ANGELES, CA:
1,653,129, REN. 4-10-02, INT. CL. 25.
- PRO GROUP, INC., ENGLEWOOD, CO, CUSTOM LEATHERCRAFT MANUFACTURING CO. INC., LOS ANGELES, CA:
1,686,128, REN. 4-8-02, INT. CL. 18.
- PRO SPORTS & ENTERTAINMENT, INC., SANTA BARBARA, CA:
2,572,382, MULTIPLE CLASS, INT. CLS. 25 AND 41.
- PRO-CAD SOFTWARE, LTD., CALGARY, ALBERTA, CANADA:
2,571,916, INT. CL. 9.
- PROCESS AUTOMATION INC., CINCINNATI, OH:
2,571,623, PUB. 2-26-2002, INT. CL. 9.
- PROCUM TECHNOLOGY, SANTA ANA, CA:
2,570,834, PUB. 2-26-2002, INT. CL. 9.
- PROCTER & GAMBLE COMPANY, THE, CINCINNATI, OH:
2,571,684, PUB. 2-26-2002, INT. CL. 3.
- PROCYTE CORPORATION, KIRKLAND, WA FROM HUMATECH CORP., BOCA RATON, FL:
2,571,738, MULTIPLE CLASS, INT. CLS. 35 AND 40.
- PRODIMED, NEUILLY-EN-THELLE, FRANCE:
1,638,983, CANC. INT. CL. 10.
- PRODUCING OPPORTUNITY AND PROSPERITY, INC., SKOKIE, IL:
2,571,319, PUB. 2-26-2002, INT. CL. 41.
- PRODUCTION MACHINERY, INC., ROSEDALE, MD:
739,702, REN. 4-10-02, U.S. CL. 23 (INT. CL. 7).
- PROFESSIONAL GOLFERS' ASSOCIATION OF AMERICA, THE, PALM BEACH GARDENS, FL:
2,571,325, PUB. 2-26-2002, MULTIPLE CLASS, INT. CLS. 25, 28, 36 AND 41.
2,571,615, PUB. 2-26-2002, INT. CL. 41.
2,571,616, PUB. 2-26-2002, INT. CL. 14.
- PROFESSIONAL SOFTWARE TECHNOLOGIES, INC., LANGHORNE, PA:
1,885,896, CANC. INT. CL. 9.
1,885,897, CANC. INT. CL. 9.
1,885,898, CANC. INT. CL. 9.
- PROFESSIONAL TRADE SHOWS, MILPITAS, CA:
1,888,095, CANC. INT. CL. 35.
- PROFIT PLANTATION, INC., MESA, AZ:
2,571,381, PUB. 2-26-2002, INT. CL. 35.
- PROGRESSIVE GROWTH CORP., GAYLORD, MN:
2,571,171, PUB. 8-28-2001, INT. CL. 36.
- PROJECTTOOLS.COM, INC., BELLVILLE, TX FROM A.G. MORGAN & ASSOCIATES, HOUSTON, TX:
2,572,256, INT. CL. 9.
- PROJECTS UNLIMITED, INC., DAYTON, OH:
935,590, REN. 4-12-02, MULTIPLE CLASS, U.S. CLS. 21 (INT. CL. 9) AND 26 (INT. CL. 9).

- PROPPER MANUFACTURING CO., INC., LONG ISLAND CITY, NY:
1,676,653. REN. 4-6-02. INT. CL. 10.
- PROTECTIVE COATINGS TECHNOLOGY, INC., BLAINE, MN FROM POLY-WALL INTERNATIONAL, INC., BLAINE, MN:
2,571,849. INT. CL. 40.
- PROTEUS, INC., WASHINGTON, DC:
2,428,027. COR. INT. CL. 42.
- PROTOTYPE PRODUCTION PLASTICS, INC., WINDHAM, OH:
1,886,042. CANC. INT. CL. 17.
- PROXIMA CORPORATION, SAN DIEGO, CA:
1,886,773. CANC. INT. CL. 9.
- PRT SOFTWARE, INC., SARASOTA, FL:
2,571,114. PUB. 2-26-2002. INT. CL. 9.
- PRUDENTIAL INSURANCE COMPANY OF AMERICA, THE, NEWARK, NJ:
1,150,026. CANC. INT. CL. 36.
1,639,263. CANC. INT. CL. 36.
- PUBLIC BROADCASTING SERVICE, ALEXANDRIA, VA:
2,572,086. INT. CL. 41.
2,572,087. INT. CL. 38.
- PUBLISHING GROUP OF AMERICA, INC., FRANKLIN, TN:
2,571,429. PUB. 2-26-2002. INT. CL. 16.
- PULL-BUOY, INC., STERLING HEIGHTS, MI:
2,571,317. PUB. 2-26-2002. INT. CL. 35.
- PULS, FRED, M., BROOMFIELD, CO:
2,572,417. INT. CL. 42.
- PUPPY PAWS, INC., CLEVELAND, OH:
2,571,182. PUB. 9-4-2001. MULTIPLE CLASS, INT. CLS. 14 AND 28.
- PURE T COMPANY, SAN FRANCISCO, CA:
1,886,683. CANC. INT. CL. 30.
- PURESYN, INC., MALVERN, PA:
2,571,019. PUB. 2-26-2002. INT. CL. 1.
- PURINA MILLS, INC., ST. LOUIS, MO:
1,702,608. REN. 4-9-02. INT. CL. 31.
- PV BAKERY INC., NEW YORK, NY, DBA H&H MIDTOWN BAGELS EAST:
2,571,095. PUB. 2-26-2002. MULTIPLE CLASS, INT. CLS. 30 AND 42.
- PYDERION CONTACT TECHNOLOGIES INC., ST. LAURENT (MONTREAL), QUEBEC, H4T 2B5, CANADA:
2,570,626. PUB. 2-26-2002. INT. CL. 9.
- P3M, INC., LOS GATOS, CA:
2,570,575. PUB. 5-23-2000. INT. CL. 35.
- Q.E.D., INC., NEW YORK, NY:
2,209,703. CANC. INT. CL. 42.
- Q-MED AKTIEBOLAG, 752 28 UPPSALA, SWEDEN:
2,390,731. COR. INT. CL. 5.
- QED INFORMATION SYSTEMS, INC., MARLTON, NJ:
2,570,515. PUB. 6-19-2001. INT. CL. 9.
- QLX PHOTOPROCESSING, INC., ROCHESTER, NY, QUALIX INC., DURHAM, NC:
1,733,643. REN. 4-10-02. INT. CL. 40.
- QUAIL HOLLOW INN, INC., CLEVELAND, OH:
1,150,099. CANC. INT. CL. 42.
- QUALCOMM INCORPORATED, SAN DIEGO, CA:
1,886,716. CANC. INT. CL. 37.
- QUALITY AND OUTCOME, INC., CLEARWATER, FL:
1,886,467. CANC. U.S. CL. B.
- QUALITY STORES SERVICES, INC., MUSKEGON, MI FROM QUALITY STORES, INC., MUSKEGON, MI:
2,570,708. PUB. 2-26-2002. INT. CL. 35.
- QUALITY STORES, INC.:
See—QUALITY STORES SERVICES, INC..
- QUALITYLOGIC, INC., MOORPARK, CA:
2,570,648. PUB. 5-22-2001. INT. CL. 42.
- QUALITYMETRIC INCORPORATED, LINCOLN, RI:
2,570,746. PUB. 2-26-2002. INT. CL. 42.
- QUANTUM BIOENGINEERING, INC., PLANTATION, FL:
2,572,057. INT. CL. 10.
- QUARTON INC., TAIPEI, TAIWAN:
1,886,535. CANC. INT. CL. 9.
- QUICK CHEK FOOD STORES, WHITEHOUSE STATION, NJ:
2,571,364. PUB. 2-26-2002. INT. CL. 35.
- QUICK MARKETING, LOS ANGELES, CA, ORANGE WHIP CORPORATION, LOS ANGELES, CA:
1,202,278. REN. 4-6-02. MULTIPLE CLASS, INT. CLS. 35 AND 42.
- QUICKQUOTE SYSTEMS, INC., RENO, NV:
2,570,898. PUB. 2-26-2002. INT. CL. 36.
- QUICKSILVER WATER COMPANY, SEDALIA, MO:
1,639,231. CANC. INT. CL. 32.
- QUIKSILVER, INC., COSTA MESA, CA:
1,862,995. CANC. MULTIPLE CLASS, INT. CLS. 18 AND 25.
- QUIKTRIP WEST, INC., WICHITA, KS:
2,572,393. INT. CL. 32.
- QUINETTE JR., RICHARD T., KEKAHA, HI:
2,571,580. PUB. 2-26-2002. INT. CL. 42.
- QUINN ENTERPRISES, INC., PORTLAND, ME:
2,571,284. PUB. 2-26-2002. INT. CL. 14.
- QUOTATIONARY, L.C., SANDY, UT:
2,570,627. PUB. 7-3-2001. INT. CL. 9.
- QVC, INC., WEST CHESTER, PA:
2,572,123. INT. CL. 14.
- QWEST COMMUNICATIONS INTERNATIONAL INC, DENVER, CO FROM U S WEST, INC., DENVER, CO:
2,570,866. PUB. 2-26-2002. INT. CL. 38.
- R. K. TEICHGRALBER, EL DORADO KS:
695,996. CANC. U.S. CL. 23.
- R.G. BARRY CORPORATION, PICKERINGTON, OH:
1,886,081. CANC. INT. CL. 20.
- R.S. MEANS COMPANY, INC., KINGSTON, MA:
1,886,273. CANC. INT. CL. 35.
- RABCAN ASSOCIATES, INC., ROCKVILLE, MD:
1,886,720. CANC. INT. CL. 41.
- RACAL SURVEY LIMITED, BRACKNELL, BERKSHIRE RG12 1RG, ENGLAND:
1,885,842. CANC. INT. CL. 9.
- RADIATOR SPECIALTY COMPANY, CHARLOTTE, NC:
561,160. REN. 4-11-02. U.S. CL. 52 (INT. CL. 3).
- RADIO FLYER INC., CHICAGO, IL:
2,571,296. PUB. 2-26-2002. INT. CL. 12.
- RADIO FREQUENCY SYSTEMS, INC., MERIDEN, CT:
2,571,017. PUB. 2-26-2002. INT. CL. 9.
- RADIO HULA, INC., NEW YORK, NY:
1,880,936. CANC. MULTIPLE CLASS, INT. CLS. 41 AND 42.
- RADISSON SEVEN SEAS CRUISES, INC., FT. LAUDERDALE, FL:
2,571,631. PUB. 2-26-2002. INT. CL. 39.
- RAFFINERIE TIRLEMONTAISE S.A., EN NEERLANDAIS TIENSE SUIKERRAFFINADERIJ N.V., 1150 BRUXELLES (WOLUWE-SAINT-PIERRE), BELGIUM:
2,570,531. PUB. 2-26-2002. INT. CL. 1.
- RAINDANCE COMMUNICATIONS, INC., LOUISVILLE, CO FROM EVOKE COMMUNICATIONS, INC., LOUISVILLE, CO:
2,572,187. INT. CL. 9.
- RAINDROP GEOMAGIC, INC., RESEARCH TRIANGLE PARK, NC:
2,571,111. PUB. 2-26-2002. INT. CL. 9.
2,571,141. PUB. 2-26-2002. INT. CL. 9.
- RAINIER BANCORPORATION, SEATTLE, WA:
1,150,018. CANC. MULTIPLE CLASS, INT. CLS. 36 AND 42.
- RALPHS GROCERY COMPANY, LOS ANGELES, CA:
2,571,510. PUB. 2-26-2002. INT. CL. 30.
- RALSTON PURINA COMPANY, ST. LOUIS, MO:
2,572,413. INT. CL. 31.
- RAM GOLF CORPORATION, MELROSE PARK, IL:
1,344,759. CANC. INT. CL. 28.
- RAND FINANCIAL SERVICES, INC., CHICAGO, IL:
2,571,261. PUB. 2-26-2002. MULTIPLE CLASS, INT. CLS. 36 AND 42.
- RAO, POTLURI M., SEATTLE, WA AND RAO, CATHERINE MCDOLE, SEATTLE, WA:
1,721,623. REN. 4-8-02. INT. CL. 9.

- RAPID 2-WAY, INC., MEDINA, OH:
2,572,310, INT. CL. 38.
- RATON SERVICOS DE CONSULTADORIA E MARKETING LDA., 9000 FUNCHAL, PORTUGAL:
2,570,638, PUB. 10-31-2000. INT. CL. 18.
- RAYMOND CORPORATION, THE, GREENE, NY:
1,711,313. REN. 4-12-02. INT. CL. 9.
- RAYMOND JAMES & ASSOCIATES, INC., ST. PETERSBURG, FL:
1,731,554. REN. 4-11-02. INT. CL. 36.
- RCP SERVICES, LLC, PHOENIX, AZ:
2,571,168, PUB. 2-26-2002. MULTIPLE CLASS, INT. CLS. 16 AND 36.
- READEX, INC., STILLWATER, MN:
2,571,484, PUB. 2-26-2002. INT. CL. 35.
- REAL DECISIONS CORPORATION, DARIEN, CT:
1,885,986, CANC. INT. CL. 16.
- REAL ESTATE CHANNEL CORPORATION, ALTAMONTE SPRINGS, FL:
2,572,275, INT. CL. 36.
- REBA MCENTIRE, A U.S. CITIZEN, AS TRUSTEE OF THE SMITH TRUST, NASHVILLE, TN:
2,571,687, INT. CL. 25.
- REBEL INDUSTRIES LLC, PINCKNEY, MI:
2,572,182, INT. CL. 7.
- REBORN PRODUCTS CO., INC., BENSALEM, PA, AKA THE AMERICAN BELT COMPANY:
1,220,073. REN. 4-9-02. INT. CL. 25.
- REBUILDING EDUCATIONAL SYSTEMS THROUGH OUR RAISED EFFORTS, INC., SANTA MARIA, CA, DBA R.E.S.T.O.R.E.:
2,571,514, PUB. 2-26-2002. INT. CL. 36.
- RECKITT BENCKISER INC., WAYNE, NJ, AMERICAN HOME PRODUCTS CORPORATION, NEW YORK, NY:
922,525. REN. 4-10-02. U.S. CL. 52 (INT. CL. 3).
- RECOGNITION EXPERTS INC., ROCHESTER, NY:
2,571,451, PUB. 2-26-2002. MULTIPLE CLASS, INT. CLS. 20, 40 AND 42.
- RECOT, INC., WILMINGTON, DE:
1,886,680, CANC. INT. CL. 30.
- RECOT, INC., PLEASANTON, CA:
2,571,282, PUB. 2-26-2002. INT. CL. 35.
- RED CHIP COMPANY LTD., TORTOLA, BR. VIRGIN ISLANDS:
2,571,733, INT. CL. 9.
2,571,735, INT. CL. 9.
- RED DOOR ANTIQUES, INC., AMARILLO, TX:
2,570,672, PUB. 2-26-2002. INT. CL. 35.
- RED HAT, INC., DURHAM, NC FROM CYGNUS SOLUTIONS, INC., SUNNYVALE, CA:
2,571,937, INT. CL. 9.
- RED HERRING COMMUNICATIONS, INC., SAN FRANCISCO, CA:
2,570,739, PUB. 2-26-2002. INT. CL. 9.
- REDER, MARIA H., WEXFORD, PA:
2,571,097, PUB. 2-26-2002. INT. CL. 28.
- REEBOK INTERNATIONAL LTD., CANTON, MA:
1,694,551. REN. 4-10-02. INT. CL. 25.
- REED ELSEVIER PROPERTIES INC., WILMINGTON, DE, REED PROPERTIES, INC., WILMINGTON, DE:
1,697,156. REN. 4-11-02. INT. CL. 16.
- REEVIVE, INC., RYDAL, PA:
2,571,723, INT. CL. 30.
- REGENTS OF THE UNIVERSITY OF CALIFORNIA, THE, OAKLAND, CA:
2,570,526, PUB. 2-26-2002. INT. CL. 9.
2,570,721, PUB. 2-26-2002. INT. CL. 25.
2,572,283, INT. CL. 36.
- REH KENDERMANN GMBH WEINKELLEREI, D-55411 BINGEN, FED REP GERMANY:
2,570,684, PUB. 7-17-2001. INT. CL. 33.
- REHABCLINICS (SPT) INC, KING OF PRUSSIA, PA:
1,639,188, CANC. INT. CL. 28.
- REHAU AG & CO., REHAU, FED REP GERMANY, REHAU PLASTIKS AG & CO., REHAU, FED REP GERMANY:
1,182,940. REN. 4-12-02. INT. CL. 17.
- REID, SHEILA A., WASHINGTON, DC:
2,571,210, PUB. 2-26-2002. MULTIPLE CLASS, INT. CLS. 16 AND 41.
- REISLER, PAUL, WASHINGTON, VA:
1,885,913, CANC. INT. CL. 9.
- REITER, WERNER, A-5020 SALZBURG, AUSTRIA:
2,570,639, PUB. 2-26-2002. MULTIPLE CLASS, INT. CLS. 19 AND 20.
- RELOCATION EXCHANGE CORP., THE, SPRINGFIELD, NJ:
2,572,411, INT. CL. 36.
- RENAISSANCE HOTEL HOLDINGS, INC, BETHESDA, MD, RAMADA INC., PHOENIX, AZ:
1,714,479. REN. 4-10-02. INT. CL. 42.
- RENE OF PARIS, INC., VAN NUYS, CA:
2,572,175, INT. CL. 26.
- RENTRAK CORPORATION, PORTLAND, OR:
2,570,659, PUB. 6-12-2001. MULTIPLE CLASS, INT. CLS. 35 AND 39.
- REPUBLIC ENGINEERED STEELS, INC., MASSILLON, OH:
1,638,873, CANC. INT. CL. 6.
1,638,874, CANC. INT. CL. 6.
- RESCUE MISSION, INC., OMAHA, NE:
2,570,822, PUB. 2-26-2002. INT. CL. 42.
- RESEARCH ACCESS, INC.:
See— ELLIANCE, INC..
- RESIDENT'S HOME BUYING SERVICES, INC., HEMPSTEAD, TX:
2,570,763, PUB. 2-26-2002. INT. CL. 36.
- RESMED LIMITED, NORTH RYDE NSW 2113, AUSTRALIA:
2,570,833, PUB. 12-4-2001. INT. CL. 10.
- RESOLUTION TECHNOLOGY MANAGEMENT, INC., SARATOGA SPRINGS, NY:
2,572,409, INT. CL. 35.
- RESORTS INTERNATIONAL HOTEL, INC., ATLANTIC CITY, NJ:
1,886,728, CANC. INT. CL. 41.
- RESPONSIVE ENVIRONMENTS, INC., DOVER, PA:
1,886,073, CANC. INT. CL. 19.
- RETEVISION INTERACTIVA, S.A., 28046 MADRID, SPAIN:
2,570,776, PUB. 2-26-2002. MULTIPLE CLASS, INT. CLS. 38 AND 42.
- RETRO 1951, INC., RICHARDSON, TX:
2,571,868, MULTIPLE CLASS, INT. CLS. 16 AND 18.
- REUSE TECHNOLOGY, INC., KENNESAW, GA:
1,886,494, CANC. INT. CL. 1.
- REVAL.COM, INC., NEW YORK, NY:
2,571,922, INT. CL. 36.
- REVERE MILLS, INC., NILES, IL:
1,886,096, CANC. INT. CL. 24.
- REVLON, INC., NEW YORK, NY:
385,922, CANC. U.S. CL. 51.
- REYNARD, ADRIAN JOHN, 1885 CHESIERES, SWITZERLAND:
2,505,811, COR. MULTIPLE CLASS, INT. CLS. 7, 9, 12, 18, 25 AND 42.
- REYNOLDS METALS COMPANY, RICHMOND, VA:
2,572,121, INT. CL. 6.
- RHEEM MANUFACTURING COMPANY, COLUMBIA, SC:
713,162, CANC. U.S. CL. 31.
- RHEINLAND-PFALZ-SAAR INTERNATIONAL, LLC, RIVERSIDE, CA:
2,571,345, PUB. 2-26-2002. MULTIPLE CLASS, INT. CLS. 35 AND 42.
- RICE INDUSTRY, THE, HOUSTON, TX TO USA RICE COUNCIL, HOUSTON, TX:
717,307, AM. U.S. CL. 100.
- RICHCRAFT, INC., JACKSONVILLE, FL:
1,886,087, CANC. INT. CL. 21.
- RICKEY PATRICK, OAKLAND, CA:
1,639,305, CANC. INT. CL. 42.
- RICOCHET, INC., COLUMBIA, MO TO RICOCHET, INC., COLUMBIA, MO:
1,883,139, CANC. INT. CL. 41.
- RICOH COMPANY, LTD., OHTA-KU, TOKYO, JAPAN:
1,188,275. REN. 4-9-02. MULTIPLE CLASS, INT. CLS. 1, 2 AND 3.
1,886,568, CANC. INT. CL. 9.
- RIDGELAND INN AND SUITES, INC., VICKSBURG, MS:
1,886,744, CANC. INT. CL. 42.

- RIKER LABORATORIES, INC., SAINT PAUL, MN:
929,017. REN. 4-8-02. U.S. CL. 18 (INT. CL. 5).
- RIPALTA S.N.C. DI MARCUZZI CLAUDIA E SUTOR
ARMANDO, TREVISO, ITALY:
2,369,007, COR. MULTIPLE CLASS, INT. CLS. 19 AND
27.
- RISKMETRICS GROUP, NEW YORK, NY:
2,572,271, MULTIPLE CLASS, INT. CLS. 36 AND 42.
- RIVENDELL BICYCLE WORKS, INC., WALNUT CREEK,
CA:
2,571,985, INT. CL. 12.
- RIVERDEEP INTERACTIVE LEARNING LIMITED, DU-
BLIN, IRELAND FROM EDMARK CORPORATION, RED-
MOND, WA:
2,571,790, INT. CL. 9.
- RIVIERA TRADING CORP., NEW YORK, NY:
1,149,925, CANC. INT. CL. 26.
- RIVIERA TRADING CORPORATION, NEW YORK, NY TO
RIVIERA TRADING CORPORATION, NEW YORK, NY:
2,507,276, COR. MULTIPLE CLASS, INT. CLS. 9, 14 AND
26.
- ROAD MATE INTERNATIONAL LIMITED, KOWLOON,
HONG KONG:
2,571,084, PUB. 2-26-2002. INT. CL. 25.
- ROALD MARTH LEARNING SYSTEMS, INC., EDEN
PRAIRIE, MN:
1,886,363, CANC. INT. CL. 41.
- ROB LIEFELD, INC., ANAHEIM, CA:
1,885,999, CANC. INT. CL. 16.
- ROBERT BOSCH GMBH, STUTTGART 1, FED REP GER-
MANY:
1,189,182. REN. 4-10-02. INT. CL. 9.
- ROBERT MONDAVI WINERY, NAPA, CA:
2,571,910, INT. CL. 33.
- ROBERTET FLAVORS, INC., PISCATAWAY, NJ:
1,683,113. REN. 4-9-02. INT. CL. 30.
1,716,155. REN. 4-10-02. INT. CL. 30.
- ROBERTS, KIMBERLY ANN, ANNAPOLIS, MD:
2,570,867, PUB. 2-26-2002. INT. CL. 25.
- ROBIE PROPERTIES LLC, DANVERS, MA:
2,570,796, PUB. 2-26-2002. MULTIPLE CLASS, INT. CLS.
36 AND 37.
- ROCCOGRANDI; ANTHONY S., WILKES-BARRE, PA, DBA
ROBYN PRODUCTS:
1,175,212. REN. 4-11-02. INT. CL. 20.
- ROCK BOTTOM RESTAURANTS, INC., LOUISVILLE, CO,
DAY; FRANK B., BOULDER, CO:
1,190,244. REN. 4-8-02. INT. CL. 42.
- ROD MCLELLAN CO., SAN MATEO, CA:
2,572,096, INT. CL. 31.
- RODRIGUEZ, DAMIAN E., LIVERMORE, CA:
2,571,621, PUB. 2-26-2002. INT. CL. 7.
- RODRIGUEZ, MIGUEL ANGEL, MEXICO CITY, MEXICO:
2,571,560, PUB. 2-26-2002. INT. CL. 25.
- ROGERS TOOL WORKS, ROGERS, AR:
1,886,516, CANC. INT. CL. 7.
- ROHDE & SCHWARZ GMBH & CO. KG., 81671 MUNCHEN,
FED REP GERMANY:
725,575. REN. 4-9-02. U.S. CL. 21 (INT. CL. 9).
- ROLAND MARKETING, INC., FRIDLEY, MN:
1,679,577. REN. 4-10-02. INT. CL. 31.
- ROLAND MEINL MUSIKINSTRUMENTE GMBH & CO., D-
91413 NEUSTADT/AISCH, FED REP GERMANY:
2,570,938, PUB. 2-26-2002. INT. CL. 15.
2,571,178, PUB. 2-26-2002. INT. CL. 9.
- ROOCHI TRADERS, INC., CITY OF COMMERCE, CA:
2,571,231, PUB. 9-4-2001. INT. CL. 25.
- ROPLAST INDUSTRIES, INC., OROVILLE, CA:
2,571,248, PUB. 2-26-2002. INT. CL. 16.
- ROSE PLASTIC GMBH, D 88138 HERGENSWEILER/LIN-
DAU, FED REP GERMANY:
2,570,806, PUB. 9-11-2001. INT. CL. 20.
- ROSEDALE WALLCOVERINGS INC., CONCORD, ONTAR-
IO L4K 1Z5, CANADA:
1,885,985, CANC. MULTIPLE CLASS, INT. CLS. 16, 20
AND 27.
- ROSEN, STEVEN R., FORT LAUDERDALE, FL FROM
ROSEN, STEVEN R., FORT LAUDERDALE, FL:
2,572,239, INT. CL. 3.
- ROSEN, STEVEN R.:
See—ROSEN, STEVEN R.
- ROSENBLUTH INTERNATIONAL, INC., PHILADELPHIA,
PA:
1,886,702, CANC. INT. CL. 35.
- ROSETTI HANDBAGS & ACCESSORIES, LTD., NEW YORK,
NY:
2,570,840, PUB. 2-26-2002. MULTIPLE CLASS, INT. CLS.
9, 16 AND 18.
- ROSS WHITE ENTERPRISES, INC., HOLLYWOOD, FL, DBA
NATIONAL COMPUTER DISTRIBUTORS:
1,886,412, CANC. INT. CL. 42.
- ROUSE, LAWRENCE J., VAN NUYS, CA, DBA LAWRENCE
ROUSE KUNG-FU SAN SOO CENTER FOR SELF-DE-
FENSE:
2,571,940, INT. CL. 41.
- ROUSSEL, PHILIPPE, 95880 ENGHEN LES BAINS,
FRANCE:
2,570,548, PUB. 2-27-2001. MULTIPLE CLASS, INT. CLS. 9
AND 42.
- ROYAL BODYCARE, INC., IRVING, TX:
2,570,674, PUB. 2-26-2002. INT. CL. 5.
- ROYAL OAK SALES, INC., ROSWELL, GA:
2,571,184, PUB. 2-26-2002. INT. CL. 4.
- ROYAL PAPER CONVERTING, INC., PHOENIX, AZ:
2,571,415, PUB. 2-26-2002. INT. CL. 16.
- RPS PRODUCTS INC., HAMPSHIRE, IL:
1,674,958. REN. 4-10-02. INT. CL. 11.
- RUFFHOUSE RECORDS, INC., PHILADELPHIA, PA:
1,885,876, CANC. INT. CL. 9.
1,885,880, CANC. INT. CL. 9.
- RUHOF CORPORATION, THE, MINEOLA, NY:
2,572,179, INT. CL. 3.
- RUTHERFORD, A. KEITH, REDONDO BEACH, CA, DBA
TIE ANCHOR COMPANY:
1,886,127, CANC. INT. CL. 25.
- RVP VITAMIN PRODUCTS, ROCKVILLE CENTRE, NY:
1,150,090, CANC. INT. CL. 42.
- RYKODISC, INC., MINNEAPOLIS, MN:
1,886,548, CANC. INT. CL. 9.
- RYOBI LIMITED, FUCHU-SHI, HIROSHIMA-KEN, JAPAN:
1,149,961, CANC. INT. CL. 28.
- S & B SHOKUHIN CO., LTD., NIHONBASHI, CHUO-KU,
TOKYO, JAPAN:
1,149,978, CANC. INT. CL. 30.
- S. C. JOHNSON & SON, INC., RACINE, WI:
726,593. REN. 4-10-02. U.S. CL. 52 (INT. CL. 3).
- S.D.L. TECHNOLOGIES (SOL) LTD., ASHDOD 77166, IS-
RAEL:
2,570,632, PUB. 1-16-2001. INT. CL. 11.
- S.T. DUPONT, PARIS, FRANCE:
1,885,973, CANC. MULTIPLE CLASS, INT. CLS. 14, 16, 18,
25 AND 34.
- SABAN ENTERTAINMENT, INC., LOS ANGELES, CA:
2,084,293, CANC. INT. CL. 9.
- SACRAMENTO KINGS LIMITED PARTNERSHIP, L.P.,
SACRAMENTO, CA:
2,571,232, PUB. 2-26-2002. INT. CL. 35.
- SADIE'S, LLC, BOUNTIFUL, UT:
2,571,409, PUB. 2-26-2002. INT. CL. 42.
- SAEKAPHEN CHEMICAL LIMITED, MANITOWOC, WI,
SAKAPHEN GMBH & CO. KG, GLADBECK, FED REP
GERMANY:
1,184,297. REN. 4-12-02. MULTIPLE CLASS, INT. CLS. 1,
2 AND 17.
- SAES GETTERS S.P.A., MILANO, ITALY:
2,572,277, INT. CL. 9.
- SAF-T-LOK INTERNATIONAL, LOMBARD, IL:
2,571,585, PUB. 2-26-2002. INT. CL. 1.
- SAFETEL, INC., RICHARDSON, TX:
2,570,512, PUB. 2-26-2002. INT. CL. 16.
- SAGE DINING SERVICES, INC., TOWSON, MD:
2,570,608, PUB. 2-26-2002. INT. CL. 42.
- SAKS & COMPANY, NEW YORK, NY:
1,639,154, CANC. INT. CL. 25.

- SALOMON SMITH BARNEY, HARRISBURG, PA:
2,570,902, PUB. 2-26-2002. MULTIPLE CLASS, INT. CLS.
25 AND 36.
- SALON CAREER TRACK, INC., DENVER, CO:
1,886,013, CANC. INT. CL. 16.
- SALTON, INC., MOUNT PROSPECT, IL:
2,572,188, INT. CL. 11.
- SAMPLETRAK, INC., CONCORD, CA:
1,886,536, CANC. INT. CL. 9.
- SAMSONITE CORPORATION, DENVER, CO, DROUTMAN
MANUFACTURING CO., INC., BROOKLYN, NY:
728,121. REN. 4-9-02. U.S. CL. 3 (INT. CL. 18).
- SAMSUNG AMERICA, INC., RIDGEFIELD PARK, NJ:
2,572,009, INT. CL. 25.
- SAMSUNG CORPORATION, SEOUL, REPUBLIC OF KOR-
EA:
2,570,616, PUB. 9-4-2001. INT. CL. 29.
- SAN ANTONIO TACO CO., NASHVILLE, TN:
1,639,309, CANC. INT. CL. 42.
- SAN DIEGO FLOOD BUSTERS, INC., SANTEE, CA:
2,571,679, PUB. 2-26-2002. INT. CL. 37.
- SAN YEH HONG KONG FOOD INC., S. EL MONTE, CA:
2,572,062, INT. CL. 30.
- SANDALWOOD APPAREL CORP., NEW YORK, NY:
2,571,720, INT. CL. 25.
- SANDERSON COMPUTERS INC., WORTHINGTON, OH:
2,570,818, PUB. 2-26-2002. INT. CL. 9.
- SANDLER SYSTEMS, INC., STEVENSON, MD:
2,494,343, COR. INT. CL. 41.
- SANDOZ NUTRITION LTD., BERNE, SWITZERLAND:
1,885,937, CANC. INT. CL. 10.
- SANFORD, L.P., BELLWOOD, IL, M. GRUMBACHER, INC.,
NEW YORK, NY:
1,184,354, REN. 4-6-02. INT. CL. 2.
- SANGRITA DE LA VIUDA DE SANCHEZ, S.A., CHAPALA,
JALISCO, MEXICO TO BIENES INMUEBLES DE TLAX-
CALA, S.A. DE C.V., TLAXCALA C.P., MEXICO:
1,162,128, AM. INT. CL. 32.
- SANKYO COMPANY LIMITED, TOKYO, JAPAN:
1,885,774, CANC. INT. CL. 5.
- SANOFI-SYNTHELABO, 75013 PARIS, FRANCE:
2,570,756, PUB. 10-16-2001. INT. CL. 5.
- SANTA NINFA PACKING CORP., LINDEN, NJ:
1,886,235, CANC. INT. CL. 30.
- SANTA'S BEST, NORTHFIELD, IL:
1,886,191, CANC. INT. CL. 28.
- SANTO, BERGIN J., NEW YORK, NY AND SANTO, JOSEPH
B., NEW YORK, NY, SANTO, JOSEPH B., NEW YORK,
NY, DBA THE SIGN OF THE DOVE:
930,101. REN. 4-11-02. U.S. CL. 46 (INT. CL. 29).
- SANYO ELECTRIC, INC., COMPTON, CA:
1,149,689, CANC. INT. CL. 9.
- SAPHAR & ASSOCIATES, INC., ROCHESTER, NY:
1,675,578. REN. 4-6-02. INT. CL. 35.
- SARA LEE CORPORATION, WINSTON-SALEM, NC:
2,571,905, INT. CL. 24.
- SARAMAR L.L.C., CHICAGO, IL, SARAMAR CORPORA-
TION, DOVER, DE:
1,676,016. REN. 4-6-02. INT. CL. 30.
- SARAMAR, L.L.C., CHICAGO, IL:
2,571,506, PUB. 2-26-2002. INT. CL. 29.
- SARAN INDUSTRIES, INC., INDIANAPOLIS, IN:
1,149,644, CANC. INT. CL. 8.
- SAS LABORATORIES, INC., BOSTON, MA:
1,886,781, CANC. INT. CL. 10.
- SAUCONY SHOE MANUFACTURING COMPANY, INC.,
KUTZTOWN, PA TO SAUCONY, INC., PEABODY, MA:
1,147,250, AM. INT. CL. 25.
- SAUER-DANFOSS INC., AMES, IA FROM SAUER INC.,
AMES, IA:
2,572,023, MULTIPLE CLASS, INT. CLS. 7, 9 AND 12.
- SAVAGE, BRIAN D., VESTAVIA HILLS, AL:
2,570,966, PUB. 6-12-2001. INT. CL. 16.
- SAVANNAH COLLEGE OF ART AND DESIGN, INC.,
SAVANNAH, GA:
2,570,532, PUB. 12-28-1999. INT. CL. 41.
- SAVAREZ, 69004 LYON, FRANCE:
1,924,875, AM. INT. CL. 15.
- SAWDUST RESTAURANTS, INC., DALLAS, TX:
1,886,746, CANC. INT. CL. 42.
- SAYA, MICHAEL J., SYRACUSE, NY:
1,886,345, CANC. INT. CL. 39.
- SAZERAC CO., INC., NEW ORLEANS, LA, PEPSI-COLA
INTERNATIONAL LIMITED, HAMILTON, BERMUDA:
1,200,619. REN. 4-12-02. INT. CL. 33.
- SCC GOLF PROPERTIES, LLC, CHATTANOOGA, TN:
2,571,511, PUB. 2-26-2002. INT. CL. 37.
- SCHALOW, ROLAND WAYNE, FENWICK, MI, DBA MI-
CHIGAN FIRST RESPONSE:
2,571,448, PUB. 2-26-2002. MULTIPLE CLASS, INT. CLS. 9
AND 12.
- SCHEMA GMBH, 90411 NURNBERG, FED REP GERMANY:
2,570,707, PUB. 9-18-2001. MULTIPLE CLASS, INT. CLS.
9, 35 AND 42.
- SCHILLER, HENRI, PARIS 75007, FRANCE, SEPTODONT,
SOCIETE ANONYME, 94107 ST. MAUR DES FOSSES,
FRANCE, DBA SPECIALITES SEPTODONT:
1,677,333. REN. 4-6-02. INT. CL. 5.
- SCHINDLER AUGZUGE AG, EBIKON, SWITZERLAND:
2,570,853, PUB. 2-26-2002. MULTIPLE CLASS, INT. CLS.
7, 9, 37 AND 42.
- SCHINDLER ELEVATOR CORPORATION DBA MILLAR
ELEVATOR SERVICE COMPANY:
See—UNIVERSAL TECHNOLOGY CORPORATION.
- SCHMIDT, CRAIG A., CAMERON PARK, CA, DBA KAR-
RIER COMMUNICATIONS:
2,571,625, PUB. 2-26-2002. INT. CL. 9.
- SCHOLASTIC INC., NEW YORK, NY:
396,008. REN. 4-10-02. U.S. CL. 38 (INT. CL. 16).
- 2,571,336, PUB. 2-26-2002. INT. CL. 16.
- SCHOOL OF METAPHYSICS, WINDYVILLE, MO:
1,886,815, CANC. INT. CL. 42.
- SCHOOLBENCH.COM, LLC, CHEVY CHASE, MD:
2,571,981, INT. CL. 9.
- SCHOTT GLASS TECHNOLOGIES INC., DURYEA, PA:
1,149,691, CANC. INT. CL. 9.
- SCHOTT GLASS TECHNOLOGIES, INC., DURYEA, PA:
1,149,690, CANC. INT. CL. 9.
- SCHROER, MICHAEL G., MCMURRAY, PA:
2,571,199, PUB. 2-26-2002. INT. CL. 35.
- SCHULZE, RANDALL M., SAN ANTONIO, TX:
1,886,710, CANC. INT. CL. 36.
- SCHUMANN SASOL GMBH, D-20457 HAMBURG, FED REP
GERMANY:
2,571,043, PUB. 2-26-2002. MULTIPLE CLASS, INT. CLS.
1, 3, 4 AND 5.
- SCHUMANN, LAVERNE E., BLUE GRASS, IA:
2,572,349, INT. CL. 7.
- SCIENTIA, INC., PASADENA, CA:
2,571,507, PUB. 2-26-2002. INT. CL. 42.
- SCIENTIFIC SOFTWARE-INTERCOMP, INC., DENVER,
CO:
1,885,899, CANC. INT. CL. 9.
- SCIENTIFIC TECHNOLOGIES INCORPORATED, FRE-
MONT, CA:
2,572,080, INT. CL. 9.
- SCOA INDUSTRIES, INC., COLUMBUS, OH:
713,212, CANC. U.S. CL. 39.
- SEA PINES COMPANY, INC., HILTON HEAD ISLAND, SC,
SEA PINES PLANTATION COMPANY, INC., HILTON
HEAD, SC:
1,679,455. REN. 4-9-02. MULTIPLE CLASS, INT. CLS. 24
AND 25.
- SEA PINES COMPANY, INC., HILTON HEAD ISLAND, SC:
1,679,500. REN. 4-6-02. INT. CL. 28.
- SEA PINES COMPANY, INC., HILTON HEAD ISLAND, SC,
SEA PINES PLANTATION COMPANY, INC., HILTON
HEAD, SC:
1,684,476. REN. 4-9-02. INT. CL. 21.
- SEABRIDGE LTD., HOD HASHARON, ISRAEL:
2,571,659, PUB. 2-26-2002. INT. CL. 38.
- SEAL-SPOUT CORPORATION, LIBERTY CORNER, NJ:
2,570,706, PUB. 2-26-2002. INT. CL. 21.
- SEALED AIR CORPORATION (US), SADDLEBROOK, NJ,
SEALED AIR CORPORATION, SADDLE BROOK, NJ:
927,332. REN. 4-10-02. U.S. CL. 37 (INT. CL. 16).

- SEALY TECHNOLOGY LLC, TRINITY, NC, SEALY, INCORPORATED, CHICAGO, IL:
1,189,347. REN. 4-7-02. INT. CL. 20.
- SEAQUISTPERFECT DISPENSING FOREIGN, INC., CRYSTAL LAKE, IL, PITTWAY CORPORATION, CARY, IL:
929,877. REN. 4-12-02. U.S. CL. 13 (INT. CL. 6).
- SEARCH AND RESCUE DOGS OF MARYLAND, INC., WALDORF, MD:
1,886,811, CANC. INT. CL. 39.
- SEARS, ROEBUCK AND CO., HOFFMAN ESTATES, IL:
1,189,943. REN. 4-10-02. INT. CL. 12.
- SEATTLE'S BEST COFFEE, INC., SEATTLE, WA:
1,639,432. CANC. INT. CL. 30.
- SEEIDEAS, INC., MASON, OH:
2,571,058, PUB. 2-26-2002. INT. CL. 42.
- SEIKO DENSHI KOGYO KABUSHIKI KAISHA, KOTO-KU, TOKYO, JAPAN:
1,880,436, CANC. INT. CL. 9.
- SELECTED AMERICAN GOLF ENTERPRISES CORPORATION, TIMONIUM, MD:
1,886,295, CANC. INT. CL. 36.
- SELF-REALIZATION FELLOWSHIP CHURCH, LOS ANGELES, CA:
1,675,411. REN. 4-8-02. MULTIPLE CLASS, INT. CLS. 41 AND 42.
1,726,357. REN. 4-8-02. MULTIPLE CLASS, INT. CLS. 41 AND 42.
- SELLE ROYAL S.P.A., 36050 POZZOLEONE (VICENZA), ITALY:
1,870,469, CANC. INT. CL. 12.
- SELMER COMPANY, INC., THE, ELKHART, IN:
2,570,653, PUB. 9-11-2001. INT. CL. 15.
- SEMTEK INNOVATION SOLUTIONS, INC., SAN DIEGO, CA:
2,571,140, PUB. 9-18-2001. INT. CL. 9.
- SENTINEL CONSUMER PRODUCTS, MENTOR, OH, SENTINEL CONSUMER PRODUCTS, MENTOR, OH:
1,201,202. REN. 4-10-02. INT. CL. 25.
- SENTINEL CONSUMER PRODUCTS, INC., MENTOR, OH:
1,711,052. REN. 4-9-02. INT. CL. 3.
- SERGEANT'S PET CARE PRODUCTS, INC., DALLAS, TX, CONAGRA, INC., OMAHA, NE, DBA CONAGRA PET PRODUCTS COMPANY:
1,614,506. REN. 4-8-02. INT. CL. 1.
- SERVICE-TECH CORPORATION, WARRENSVILLE HTS., OH:
1,886,809, CANC. INT. CL. 37.
- SERVICES UNLIMITED, INC., WHITE CLOUD, MI:
2,572,360, INT. CL. 37.
- SEVEN STAR SHOES INC., NEW YORK, NY:
1,191,223. REN. 4-9-02. INT. CL. 25.
- SF INVESTMENTS, INC., WILMINGTON, DE:
1,208,740. REN. 4-6-02. INT. CL. 29.
- SFA, INC., LANDOVER, MD:
1,638,927, CANC. MULTIPLE CLASS, INT. CLS. 9 AND 42.
- SGARLATA, ROBERT E., LAKE FOREST, IL:
2,570,838, PUB. 2-26-2002. MULTIPLE CLASS, INT. CLS. 25 AND 41.
- SHAKESPEARE COMPANY, LLC, NEWBERRY, SC, SHAKESPEARE COMPANY, NEWBERRY, SC:
1,690,801. REN. 4-6-02. INT. CL. 17.
- SHAKLEE CORPORATION, SAN FRANCISCO, CA:
1,885,980, CANC. INT. CL. 16.
- SHANDLEZ CO., USA, SIMI VALLEY, CA:
1,886,149, CANC. INT. CL. 25.
- SHAREVISION TECHNOLOGY, INC., MILPITAS, CA:
1,885,853, CANC. INT. CL. 9.
- SHARING NETWORK, LLC, THE, SALT LAKE CITY, UT:
2,571,739, MULTIPLE CLASS, INT. CLS. 16 AND 36.
- SHARP PLASTICS MANUFACTURING LTD., DELTA, BRITISH COLUMBIA, CANADA:
1,885,839, CANC. MULTIPLE CLASS, INT. CLS. 9 AND 28.
- SHAW INDUSTRIES, INC., DALTON, GA, QUEEN CARPET CORPORATION, DALTON, GA:
1,675,954. REN. 4-12-02. INT. CL. 27.
- SHAW'S SUPERMARKETS, INC., WEST BRIDGEWATER, MA:
2,571,124, PUB. 2-26-2002. INT. CL. 35.
- SHERWIN-WILLIAMS COMPANY, THE, CLEVELAND, OH:
1,885,751, CANC. INT. CL. 2.
- SHETLAND SEAFOOD QUALITY CONTROL, LERWICK, SHETLAND ZEI OES, SCOTLAND:
1,679,766. REN. 4-11-02. U.S. CL. A.
- SHIMANO, INC., SAKAI, OSAKA, JAPAN:
1,681,588. REN. 4-10-02. INT. CL. 8.
- SHINE COMPANY, INC., PROVO, UT:
2,570,799, PUB. 2-26-2002. INT. CL. 37.
- SHIPLEY COMPANY, L.L.C., MARLBOROUGH, MA:
2,570,742, PUB. 2-26-2002. INT. CL. 1.
- SHIRLEY & BARNETT HELZBERG FOUNDATION, KANSAS CITY, MO:
2,572,103, INT. CL. 16.
- SHOLK, JEFFREY CLAY, LEUCADIA, CA:
2,572,040, INT. CL. 25.
- SHOWTIME NETWORKS INC., NEW YORK, NY:
2,572,209, INT. CL. 41.
2,572,210, INT. CL. 38.
2,572,221, INT. CL. 38.
2,572,222, INT. CL. 41.
- SHURFINE FOODS, INC., TIGARD, OR:
1,683,923. REN. 4-11-02. INT. CL. 31.
1,702,791. REN. 4-11-02. INT. CL. 5.
- SHURFINE FOODS, INC., TIGARD, OR, WESTERN FAMILY FOODS, INC., TIGARD, OR, DBA BRAND MARKETING CORPORATION:
1,703,595. REN. 4-11-02. INT. CL. 32.
- SHURFINE INTERNATIONAL, INC., NORTHLAKE, IL, CENTRAL RETAILER-OWNED GROCERS, INC., NORTHLAKE, IL:
729,253. REN. 4-11-02. U.S. CL. 46 (INT. CL. 29).
- SHURFINE INTERNATIONAL, INC., NORTHLAKE, IL:
2,571,949, MULTIPLE CLASS, INT. CLS. 21, 29, 30, 31 AND 32.
- SHUTTLELIFT, INC., STURGEON BAY, WI:
2,572,154, INT. CL. 7.
- SICURELLA, CHRISTOPHER T., PHOENIX, AZ:
2,571,406, PUB. 2-26-2002. INT. CL. 28.
- SIEMENS AKTIENGESELLSCHAFT, D-1000, BERLIN 13, FED REP GERMANY:
1,149,708, CANC. INT. CL. 10.
- SIEMENS AKTIENGESELLSCHAFT, D-8000 MUNICH 2, FED REP GERMANY:
1,885,860, CANC. INT. CL. 9.
- SIEMENS AKTIENGESELLSCHAFT, WITTELSBACHER-PLATZ 2, MUNICH, FED REP GERMANY:
2,570,557, PUB. 3-28-2000. INT. CL. 9.
- SIEMENS AKTIENGESELLSCHAFT, MUNICH, FED REP GERMANY:
2,570,670, PUB. 2-20-2001. MULTIPLE CLASS, INT. CLS. 6 AND 40.
- SIEMIENIEC, JANICE L., PLAINFIELD, IL:
2,571,804, INT. CL. 10.
- SIERRA VISTA PACKING CO., INC., OROSI, CA:
1,193,722. REN. 4-10-02. INT. CL. 31.
- SIFCO INDUSTRIES, INC., CLEVELAND, OH:
940,193. REN. 4-10-02. U.S. CL. 106 (INT. CL. 40).
- SIGMA GAME, INC., NORTH LAS VEGAS, NV:
1,886,574, CANC. INT. CL. 9.
- SIGMA PHI EPSILON FRATERNITY, RICHMOND, VA:
387,956. REN. 4-9-02. U.S. CL. 28 (INT. CL. 14).
- SIGNET SCIENTIFIC COMPANY, EL MONTE, CA:
2,572,055, INT. CL. 9.
- SILBER'S, INC., HOUSTON, TX:
1,639,032, CANC. INT. CL. 14.
- SILER, TODD, NORWOOD, MA:
1,902,133, CANC. INT. CL. 9.
- SILICON BRIDGE, INC., FREMONT, CA:
2,572,407, INT. CL. 9.
- SILKAIR (SINGAPORE) PRIVATE LIMITED, SINGAPORE:
1,879,336, CANC. INT. CL. 39.
- SILVERSEA CRUISES LTD., FORT LAUDERDALE, FL:
2,572,028, INT. CL. 39.

SIMBA ENTERTAINMENT, LLC, NASHVILLE, TN:
2,571,353, PUB. 2-26-2002. INT. CL. 15.

SIMMONS FOODS, INC., SILOAM SPRINGS, AR, PLUS
POULTRY, INC. OF NW. ARKANSAS, SILOAM SPRINGS,
AR, DBA PLUS POULTRY, INC.:
701,087. REN. 4-10-02. U.S. CL. 46 (INT. CL. 29).

SIMON GOLUB & SONS, INC., SEATTLE, WA:
726,490. REN. 4-10-02. U.S. CL. 27 (INT. CL. 14).

SIMPSON PAPER COMPANY, SAN FRANCISCO, CA:
386,004, CANC. U.S. CL. 37.

SIMPSON STRONG-TIE COMPANY, INC., DUBLIN, CA:
1,685,994. REN. 4-8-02. INT. CL. 6.
2,572,020, INT. CL. 6.

SIMS; SYLVIA, NEW YORK, NY:
1,149,750, CANC. INT. CL. 14.

SINSKEY VINEYARDS, INC., NAPA, CA:
1,678,753. REN. 4-10-02. INT. CL. 33.

SIR SPEEDY, INC., MISSION VIEJO, CA:
2,570,896, PUB. 10-9-2001. MULTIPLE CLASS, INT. CLS.
35 AND 42.

SIRIUSWARE, INC., TAOS, NM:
2,570,529, PUB. 10-12-1999. INT. CL. 9.

SISTINA SOFTWARE, INC., MINNEAPOLIS, MN:
2,572,010, INT. CL. 42.

SITUS CORPORATION, SOLANA BEACH, CA:
2,570,661, PUB. 7-3-2001. INT. CL. 5.

SIZE APPEAL, INC., SANTA MONICA, CA:
2,571,260, PUB. 2-26-2002. INT. CL. 25.

SK PM CORP., LEMOORE, CA, SK FOODS, INC., LE-
MOORE, CA:
1,690,547. REN. 4-8-02. INT. CL. 40.

SK TECHNOLOGIES CORP., DEERFIELD BEACH, FL:
1,620,914. REN. 4-9-02. INT. CL. 9.

SKB CORPORATION, ORANGE, CA:
2,572,291, INT. CL. 20.

SKELLY, NORMAN E., MIDLAND, MI:
1,886,768, CANC. INT. CL. 7.

SKIN CARE CENTER OF THE AMERICAS, INC., THE, FT.
LAUDERDALE, FL:
2,572,395, INT. CL. 42.

SKY ALLAND RESEARCH:
See—ISKY, INC.

SKY ALLAND RESEARCH, INC.:
See—ISKY, INC.

SLAMBOOK.COM, LLC, NEW ORLEANS, LA:
2,572,258, INT. CL. 38.

SLATER, BEVERLY L., LA MESA, CA, DBA FLOYD:
1,886,030, CANC. INT. CL. 16.

SLEEMAN BREWERIES LTD., GUELPH, ONTARIO N1H
6H9, CANADA:
2,571,838, INT. CL. 32.

SLONIM, MELISSA N., SAN DIEGO, CA:
2,571,729, INT. CL. 20.

SMART INDUSTRIES CORPORATION, DES MOINES, IA:
2,571,596, PUB. 2-26-2002. INT. CL. 28.

SMARTORG, INC., MENLO PARK, CA FROM NAVIGANT
CONSULTING, INC., MENLO PARK, CA:
2,570,814, PUB. 2-26-2002. INT. CL. 35.

SMITH HELMS MULLISS & MOORE, L.L.P., CHARLOTTE,
NC:
2,570,965, PUB. 2-26-2002. INT. CL. 42.

SMITH INTERNATIONAL, INC., HOUSTON, TX:
2,571,685, PUB. 2-26-2002. INT. CL. 7.

SMITH, CHARLOTTE A., WAUWATOSA, WI:
2,572,093, INT. CL. 42.

SMITH, LARRY, M., KNOXVILLE, TN:
2,571,607, PUB. 2-26-2002. INT. CL. 41.

SMITH, MICHAEL P., GROSSE POINTE PARK, MI, DBA
PITNEY PRODUCTS:
2,362,642, CANC. INT. CL. 28.

SMITHKLINE BEECHAM BIOLOGICALS, S.A., B-1330 RIX-
ENSART, BELGIUM:
2,571,403, PUB. 2-26-2002. INT. CL. 5.

SNACK KING CORP., CITY OF INDUSTRY, CA:
2,571,778, INT. CL. 30.

SNOQUALMIE HOSPITALITY SERVICES, INC., HOOD
RIVER, OR, GRAVES; ORVILLE R., MERCER ISLAND,
WA, DBA SNOQUALMIE FALLS LODGE:
1,192,225. REN. 4-10-02. INT. CL. 30.

SOCA WEAR, INC., CHARLOTTE, NC:
2,571,351, PUB. 2-26-2002. INT. CL. 25.

SOCIEDAD ANONIMA SANPERE, BARCELONA, SPAIN:
1,149,867, CANC. INT. CL. 24.

SOCIETA PER AZIONI LUCCHESI OLII E VINI, LUCCA,
ITALY:
1,919,608, CANC. INT. CL. 16.

SOCIETE DES PRODUITS NESTLE S.A., 1800 VEVEY,
SWITZERLAND, NESTLE COMPANY, INC., THE, WHITE
PLAINS, NY:
734,286. REN. 4-7-02. U.S. CL. 46 (INT. CL. 30).

SOFT SHEEN/CARSON INC., CHICAGO, IL FROM DER-
MABLEND, INC., A DIVISION OF CARSON PRODUCTS
COMPANY, RICHFIELD, NJ:
2,570,848, PUB. 2-26-2002. INT. CL. 3.

SOFTSOLUTIONS, INC., ROANOKE, VA:
2,572,263, INT. CL. 9.

SOFTWARE ARCHITECTS, INC., GLEN BURNIE, MD:
2,572,015, MULTIPLE CLASS, INT. CLS. 41 AND 42.

SOFTWARE CONSULTING SERVICES, INC., STATEN IS-
LAND, NY:
2,570,516, PUB. 2-26-2002. INT. CL. 9.
2,570,517, PUB. 2-26-2002. MULTIPLE CLASS, INT. CLS.
37 AND 42.

SOLAR GROUP, INC., BUFFALO, NY:
2,572,184, INT. CL. 6.

SOLATURE, INC., TAMPA, FL:
2,571,635, PUB. 2-26-2002. INT. CL. 42.

SOLE S.P.A., I-33170 PORDENONE, ITALY:
2,571,951, MULTIPLE CLASS, INT. CLS. 7 AND 9.

SOLIDSTATE CONTROLS, COLUMBUS, OH:
1,638,962, CANC. INT. CL. 9.

SOLUTIONS-II, INC., ENGLEWOOD, CO:
2,571,133, PUB. 2-26-2002. INT. CL. 39.

SOLVAY (SOCIETE ANONYME), B-1050 BRUSSELS, BEL-
GIUM:
2,465,104, COR. MULTIPLE CLASS, INT. CLS. 1 AND 17.

SOMA BLUE, INC., AUGUSTA, GA:
2,571,903, MULTIPLE CLASS, INT. CLS. 5 AND 10.

SONERA OJY, HELSINKI, FINLAND FROM GESAM OY,
00510 HELSINKI, FINLAND:
2,570,530, PUB. 2-26-2002. MULTIPLE CLASS, INT. CLS.
9, 38 AND 42.

SONIDO, INC., VALDOSTA, GA:
2,571,009, PUB. 10-23-2001. INT. CL. 9.

SONITROL CORPORATION, ALEXANDRIA, VA:
1,188,998. REN. 4-11-02. INT. CL. 42.

SONOTECH, INC., BELLINGHAM, WA:
1,885,745, CANC. INT. CL. 1.

SONY CORPORATION, SHINAGAWA-KU, TOKYO, JAPAN:
1,885,838, CANC. INT. CL. 9.

SONY ELECTRONICS INC., PARK RIDGE, NJ:
1,886,584, CANC. INT. CL. 9.

SOPKO, JOHN, FRANKLIN, TN:
2,571,414, PUB. 2-26-2002. INT. CL. 16.

SOTHMAN, DONALD J., MENOMONEE FALLS, WI:
2,572,371, INT. CL. 21.

SOUND CONCEPTIONS, INC., FORT LEE, NJ:
2,570,585, PUB. 7-17-2001. INT. CL. 35.

SOUNDS GREAT, INC., ALBANY, NY:
1,150,066, CANC. INT. CL. 42.

SOUPIOS, MEREDITH F., LARCHMONT, NY:
2,571,131, PUB. 2-26-2002. INT. CL. 20.

SOURCE/INC., CHICAGO, IL:
1,639,416, CANC. INT. CL. 16.

SOUTHEASTERN NATURAL ENERGIES, INC., CARROLL-
TON, GA:
1,819,642, CANC. INT. CL. 4.

SOUTHERN ALUMINUM MFG., INC., MAGNOLIA, AR:
1,190,000. REN. 4-11-02. INT. CL. 20.

SOX, RONNIE, ALAMANCE, NC:
2,571,399, PUB. 2-26-2002. INT. CL. 28.

SPA BLENDS, NEVADA CITY, CA:
2,571,329, PUB. 2-26-2002. INT. CL. 3.

- SPA SHOP MANAGEMENT AND MAINTENANCE INC., NEW YORK, NY TO ROBERTS, LUCILLE, NEW YORK, NY:
1,165,132, CANC. MULTIPLE CLASS, INT. CLS. 3, 5 AND 25.
- SPACESAVER CORPORATION, FORT ATKINSON, WI:
2,571,780, INT. CL. 20.
- SPALDING SPORTS WORLDWIDE, INC., CHICOPEE, MA:
2,572,234, INT. CL. 28.
- SPANEL INTERNATIONAL, LTD., PALATINE, IL:
1,885,832, CANC. INT. CL. 8.
- SPARTON CORPORATION, JACKSON, MI:
1,639,013, CANC. INT. CL. 12.
- SPECIAL OFFSITE SERVICES, INC., NAPERVILLE, IL:
2,570,725, PUB. 2-26-2002. INT. CL. 35.
- SPECIALTY RISK INTERNATIONAL, INC., INDIANAPOLIS, IN:
2,571,663, PUB. 2-26-2002. INT. CL. 36.
- SPECTRUM SOFTWARE, INC., WINNECONNE, WI:
2,571,586, PUB. 2-26-2002. INT. CL. 9.
- SPENCER GIFTS, INC., EGG HARBOR TOWNSHIP, NJ:
2,572,359, INT. CL. 11.
- SPENCER STUART MANAGEMENT CONSULTANTS N.V., NETHERLD ANTILLES:
2,570,696, PUB. 2-26-2002. INT. CL. 16.
- SPICE ENTERTAINMENT, INC., CHICAGO, IL:
2,571,163, PUB. 2-26-2002. INT. CL. 41.
- SPIDERDANCE, INC., VENICE, CA:
2,571,614, PUB. 2-26-2002. MULTIPLE CLASS, INT. CLS. 38 AND 41.
- SPINCYCLE, INC.:
See— SPINCYCLE, LLC.
- SPINCYCLE, LLC, SCOTTSDALE, AZ FROM SPINCYCLE, INC., SCOTTSDALE, AZ:
2,570,899, PUB. 2-26-2002. INT. CL. 37.
- SPINNER, LAURA, FOREST HILLS, NY:
2,572,064, INT. CL. 37.
- SPIREMEDIA, INC., DENVER, CO:
2,571,597, PUB. 2-26-2002. INT. CL. 42.
- SPIREX CORPORATION, YOUNGSTOWN, OH:
2,570,809, PUB. 2-26-2002. INT. CL. 7.
- SPIROX SYSTEMS CORPORATION, HSINCHU, TAIWAN:
2,571,642, PUB. 2-26-2002. INT. CL. 9.
- SPOETZL BREWERY, INC., SAN ANTONIO, TX:
2,571,442, PUB. 2-26-2002. INT. CL. 32.
- SPONGE FACTORY, INC., THE, NEW YORK, NY:
1,886,082, CANC. INT. CL. 21.
- SPORT SHACKS INC., ST. PAUL, MN:
1,150,005, CANC. INT. CL. 35.
- SPORTS SCIENCES, INC., TWINSBURG, OH:
1,886,772, CANC. INT. CL. 9.
- SPORTSLINE.COM, INC., FT. LAUDERDALE, FL:
2,571,093, PUB. 2-26-2002. INT. CL. 35.
- SPOTTED DOG PRESS, INC., BISHOP, CA:
2,570,852, PUB. 8-28-2001. INT. CL. 16.
- SPRINGFIELD FIREWORKS, INC., BLUFFTON, OH:
2,571,825, INT. CL. 13.
2,571,826, INT. CL. 13.
- SPRINGFIELD PRECISION INSTRUMENTS, INC., WOODRIDGE, NJ:
2,571,454, PUB. 2-26-2002. INT. CL. 9.
- SPRINGS INDUSTRIES, INC., FORT MILL, SC:
2,571,786, MULTIPLE CLASS, INT. CLS. 6, 20, 24 AND 27.
- SQL ACCESS GROUP, CUPERTINO, CA:
1,886,739, CANC. INT. CL. 42.
- SQUARE D COMPANY, PALATINE, IL:
732,278, REN. 4-9-02. U.S. CL. 21 (INT. CL. 9).
- SQUEEZE WITH EASE INC., RICHMOND HILL, NY:
1,886,627, CANC. INT. CL. 21.
- ST. AMAND, DAVID G., BOXBOROUGH, MA:
1,886,281, CANC. INT. CL. 35.
- ST. JOHN KNITS, INC., IRVINE, CA:
1,693,187, REN. 4-11-02. INT. CL. 25.
- ST. LAWRENCE PRESS COMPANY, INC., ROMULUS, MI:
1,885,826, CANC. INT. CL. 7.
- ST. LOUIS BLUES HOCKEY CLUB, L.P., ST. LOUIS, MO:
1,675,177, REN. 4-8-02. INT. CL. 25.
- STA-RITE INDUSTRIES, INC., DELAVAN, WI:
2,571,565, PUB. 10-2-2001. INT. CL. 11.
- STADT CORPORATION, BROOKLYN, NY:
2,536,696, COR. INT. CL. 30.
- STANLEY ALLEN ULLMAN, CAMARILLO, CA, DBA PROFESSIONAL SOLAR PRODUCTS:
2,571,658, PUB. 2-26-2002. INT. CL. 6.
- STANLEY LOGISTICS, INC., BEW BRITAIN, CT, PLOMB TOOL COMPANY, THE, LOS ANGELES, CA:
555,093, REN. 4-12-02. U.S. CL. 26 (INT. CL. 9).
- STARDATA TECHNOLOGIES, INC., ATLANTA, GA:
2,571,301, PUB. 2-26-2002. INT. CL. 42.
- STARFISH SOFTWARE, INC., SCOTTS VALLEY, CA:
2,571,689, INT. CL. 9.
- STARTECH BUSINESS DEVELOPMENT, L.L.C.:
See— STARTECH EARLY VENTURES, LLC.
- STARTECH EARLY VENTURES, LLC, RICHARDSON, TX FROM STARTECH BUSINESS DEVELOPMENT, L.L.C., RICHARDSON, TX:
2,570,887, PUB. 2-26-2002. INT. CL. 41.
- STARZ ENCORE GROUP LLC, ENGLEWOOD, CO:
2,572,361, MULTIPLE CLASS, INT. CLS. 38 AND 41.
- STATE BAR OF CALIFORNIA, THE, SAN FRANCISCO, CA:
2,571,115, PUB. 2-26-2002. INT. CL. 9.
- STATE FISH COMPANY, INC., SAN PEDRO, CA:
2,571,970, INT. CL. 29.
- STAUBLI INTERNATIONAL AG, CH 8808 PFAFFIKON, SWITZERLAND:
1,675,696, REN. 4-10-02. MULTIPLE CLASS, INT. CLS. 7 AND 9.
- STAYNER, MARK, TEMECULA, CA AND STAYNER, DEENA, TEMECULA, CA:
2,570,798, PUB. 2-26-2002. INT. CL. 20.
- STELLAR INTERNATIONAL MUSIC CORP., FULLERTON, CA:
2,572,383, INT. CL. 15.
- STEP COMPANY, THE, MARIETTA, GA:
1,676,883, REN. 4-9-02. INT. CL. 25.
- STEPAN COMPANY, NORTHFIELD, IL:
1,638,788, CANC. INT. CL. 1.
1,638,807, CANC. INT. CL. 3.
- STEPTOE CORPORATION, INGLEWOOD, CA:
1,886,734, CANC. INT. CL. 42.
- STERLINGS/MACFADDEN PARTNERSHIP, THE, NEW YORK, NY, MACFADDEN HOLDINGS, INC., NEW YORK, NY:
1,656,215, REN. 4-7-02. INT. CL. 16.
- STEVIES, INC., LONG ISLAND CITY, NY FROM STEVEN MADDEN, LTD, LONG ISLAND CITY, NY:
2,571,974, INT. CL. 18.
- STEVIES, INC., LONG ISLAND CITY, NY FROM STEVEN MADDEN, LTD., LONG ISLAND CITY, NY:
2,571,975, INT. CL. 14.
2,571,976, INT. CL. 9.
2,571,979, INT. CL. 26.
- STEWART, J JOSEPH, AUSTIN, TX:
2,570,719, PUB. 2-26-2002. MULTIPLE CLASS, INT. CLS. 25 AND 42.
- STIMSON LANE LTD., WOODINVILLE, WA, STE. MICHELLE VINTNERS INCORPORATED, WOODINVILLE, WA:
1,205,651, REN. 4-8-02. INT. CL. 33.
- STOCKMAN, SHAWN, NEW YORK, NY:
2,572,053, INT. CL. 41.
- STONE CONTAINER CORPORATION, CHICAGO, IL:
1,639,086, CANC. INT. CL. 16.
- STONE MOUNTAIN COMPUTING CORPORATION, GOLETA, CA:
1,885,902, CANC. INT. CL. 9.
- STONE STANLEY PRODUCTIONS, LOS ANGELES, CA:
2,571,126, PUB. 2-26-2002. INT. CL. 41.
- STONER INCORPORATED, QUARRYVILLE, PA:
2,571,667, PUB. 2-26-2002. INT. CL. 3.
- STONETREE, LLC, SALT LAKE CITY, UT:
2,572,250, INT. CL. 19.

- STORAGE TECHNOLOGY CORPORATION, LOUISVILLE, CO:
1,886,539, CANC. INT. CL. 9.
2,571,748, MULTIPLE CLASS, INT. CLS. 9 AND 42.
- STORE ROOM - THIRD AVENUE, L.P., THE, FT. LAUDERDALE, FL:
2,571,864, INT. CL. 35.
- STOREFRONT SYSTEMS AND SERVICE CO., INC., NORTH CANTON, OH:
2,571,619, PUB. 2-26-2002. INT. CL. 37.
- STRATAGENE, LA JOLLA, CA:
2,572,150, INT. CL. 1.
- STRATEGIC RESOURCES, INC., STAMFORD, CT:
2,570,713, PUB. 7-3-2001. INT. CL. 9.
- STRAVINA OPERATING COMPANY, LLC, CHATSWORTH, CA:
2,571,174, PUB. 2-26-2002. INT. CL. 20.
- STUART WEITZMAN, INC., NEW YORK, NY:
2,571,208, PUB. 2-26-2002. INT. CL. 25.
- STUMP, ROBERT FRANK, EL PASO, TX:
2,571,528, PUB. 2-26-2002. INT. CL. 9.
- STYLES, BEVERLY, JOSHUA TREE, CA, DBA BEVERLY STYLES MUSIC:
1,149,657, CANC. MULTIPLE CLASS, INT. CLS. 9 AND 16.
- SULFLO, INC., NORTH TONAWANDA, NY:
725,814, REN. 4-9-02. U.S. CL. 15 (INT. CL. 4).
- SUMMIT INVESTMENTS LOAN CORPORATION, OCEANSIDE, CA:
2,571,595, PUB. 2-26-2002. INT. CL. 36.
- SUMMUM, SALT LAKE CITY, UT:
1,885,784, CANC. INT. CL. 5.
- SUN CHEMICAL CORPORATION, FORT LEE, NJ:
1,697,277, REN. 4-11-02. INT. CL. 2.
1,707,658, REN. 4-6-02. INT. CL. 2.
- SUN MICROSYSTEMS, INC., MOUNTAIN VIEW, CA:
1,885,866, CANC. INT. CL. 9.
- SUN REFINING AND MARKETING COMPANY, PHILADELPHIA, PA:
1,149,564, CANC. INT. CL. 4.
- SUN VALLEY RICE CO., LLC, THE, DUNNIGAN, CA:
2,571,938, INT. CL. 30.
- SUN-LAND PRODUCTS OF CALIFORNIA, KINGSBURG, CA, SUN-MAID GROWERS OF CALIFORNIA, KINGSBURG, CA:
1,200,043, REN. 4-10-02. INT. CL. 29.
- SUN, DONALD J. C., YONG ANN HSIANG, KAOHSIUNG, TAIWAN:
1,872,633, CANC. INT. CL. 28.
- SUNBELT SOFTWARE SOLUTIONS, INC., CHATTANOOGA, TN:
2,572,193, INT. CL. 9.
- SUNBURY TEXTILE MILLS, INC., SUNBURY, PA:
2,571,423, PUB. 2-26-2002. INT. CL. 24.
- SUNDAY SCHOOL BOARD, THE:
See— LIFEWAY CHRISTIAN RESOURCES OF THE SOUTHERN BAPTIST CONVENTION.
- SUNGLO TELECOM, INC., UPLAND, CA:
2,570,997, PUB. 12-11-2001. INT. CL. 37.
- SUNPOWER, LLC, SCOTTSDALE, AZ:
2,571,624, PUB. 2-26-2002. INT. CL. 36.
- SUNTECH MEDICAL INSTRUMENTS, INC., RALEIGH, NC:
2,571,308, PUB. 2-26-2002. INT. CL. 42.
- SUNTEX INTERNATIONAL, INC., EASTON, PA:
2,571,693, INT. CL. 9.
- SUNTORY WATER GROUP, INC., COLUMBUS, OH, POLAR WATER COMPANY, COLUMBUS, OH:
1,220,478, REN. 4-11-02. INT. CL. 1.
- SUPER POWER INVESTMENT, LTD. INC., SOUTH SAN FRANCISCO, CA, DBA LYN ANNE SLEEPWEAR:
1,639,167, CANC. INT. CL. 25.
- SUPER SCIENTIFIC CIRCUS, INC., MADISON, NJ:
2,571,295, PUB. 2-26-2002. INT. CL. 41.
- SUPERIOR CARPET CARE, INC., LITTLETON, CO:
2,572,354, INT. CL. 3.
- SUPERIOR LABEL SYSTEMS, INC., MASON, OH:
1,700,970, REN. 4-8-02. INT. CL. 42.
- SUPERIOR SIGNALS INC., OLATHE, KS:
1,742,895, REN. 4-8-02. INT. CL. 9.
- SUPERWINCH, INC., PUTNAM, CT:
1,149,610, CANC. INT. CL. 7.
- SUPPLY CHAIN CONSULTANTS, INC., WILMINGTON, DE:
2,571,646, PUB. 2-26-2002. INT. CL. 9.
- SUR-GARD SECURITY SYSTEMS LTD., DOWNSVIEW, ONTARIO, CANADA:
2,571,746, INT. CL. 9.
- SURFACE ACTIVE LIMITED, BRISTOL, ENGLAND:
1,885,732, CANC. MULTIPLE CLASS, INT. CLS. 1 AND 5.
- SUSHI DELI EXPRESS, INC., SAN DIEGO, CA:
2,571,236, PUB. 2-26-2002. INT. CL. 42.
- SUSSEX PUBLISHERS, INC., NEW YORK, NY:
2,570,680, PUB. 2-26-2002. INT. CL. 41.
- SWANK, INC., NEW YORK, NY:
935,850, REN. 4-12-02. U.S. CL. 3 (INT. CL. 18).
- SWAT, INC., CITY OF INDUSTRY, CA:
1,886,160, CANC. INT. CL. 25.
- SWENCO PRODUCTS, INC., POPLAR BLUFF, MO:
2,570,493, PUB. 10-28-1997. INT. CL. 9.
- SWIMC, INC., WILMINGTON, DE:
1,638,799, CANC. INT. CL. 2.
- SWIMWAYS CORP., VIRGINIA BEACH, VA:
2,571,404, PUB. 2-26-2002. INT. CL. 28.
- SYCOM TECHNOLOGIES, INC., PHILADELPHIA, PA:
1,886,774, CANC. INT. CL. 9.
- SYLVAN LEARNING SYSTEMS, INC., BALTIMORE, MD:
2,572,252, INT. CL. 41.
- SYMLOG CONSULTING GROUP, SAN DIEGO, CA, BALES, ROBERT F., WESTON, MA:
1,700,502, REN. 4-9-02. MULTIPLE CLASS, INT. CLS. 16, 35 AND 41.
- SYNAPSE SOFTWARE, INC., VICTORIA, BRITISH COLUMBIA, V8X 4P7, CANADA:
1,886,564, CANC. INT. CL. 9.
- SYNDERGENERAL CORPORATION, DALLAS, TX:
1,885,942, CANC. MULTIPLE CLASS, INT. CLS. 11 AND 17.
- SYNTEX (U.S.A.) INC., PALO ALTO, CA:
140,876, CANC. U.S. CL. 6.
- SYSTEMED, INC., LAGUNA HILLS, CA:
1,886,287, CANC. INT. CL. 36.
- SYSTEMS MATERIAL HANDLING CO., OLATHE, KS:
2,570,786, PUB. 2-26-2002. INT. CL. 9.
- T. BAIRD MCILVAIN COMPANY, KING OF PRUSSIA, PA:
2,572,169, MULTIPLE CLASS, INT. CLS. 19 AND 35.
- T.K. FOOD CO., LTD., CHIAYI HSIEN, TAIWAN, R.O.C., TAIWAN:
2,196,087 NEW CERT. 5-21-2002. INT. CL. 30.
- T.K.F., INC., CINCINNATI, OH:
1,886,518, CANC. INT. CL. 7.
- T.M. SPECIALTIES, INC., BOCA RATON, FL:
1,886,189, CANC. INT. CL. 28.
- T&S BRASS AND BRONZE WORKS, INC., TRAVELERS REST, SC:
2,571,948, INT. CL. 6.
- TAB PRODUCTS CO., VERNON HILLS, IL, TAB PRODUCTS CO., PALO ALTO, CA:
1,170,959, REN. 4-10-02. MULTIPLE CLASS, INT. CLS. 16 AND 20.
- TAB PRODUCTS CO., PALO ALTO, CA TO TAB PRODUCTS CO., VERNON HILLS, IL:
1,170,959, CANC. INT. CL. 9.
- TABLAS CREEK VINEYARD, PASO ROBLES, CA:
2,572,223, INT. CL. 33.
- TACTICA INTERNATIONAL, INC., EL PASO, TX:
2,571,469, PUB. 2-26-2002. INT. CL. 10.
- TAI CHI CHUAN CENTER INC., NEW YORK, NY:
2,571,369, PUB. 2-26-2002. INT. CL. 41.
- TAI FOONG INTERNATIONAL LTD., SCARBOROUGH, ONTARIO MIX 1E6, CANADA:
2,570,972, PUB. 2-26-2002. INT. CL. 30.
2,570,973, PUB. 2-26-2002. INT. CL. 29.
- TAIYI PRINTING ENTERPRISE CO., LTD., TAIPEI HSIEN, TAIWAN:
2,570,804, PUB. 2-26-2002. INT. CL. 35.

- TAMA PLASTIC INDUSTRY, KIBBUTZ MISHMAR HA'EMEK 19236, ISRAEL:
2,570,736, PUB. 7-24-2001. MULTIPLE CLASS, INT. CLS. 11 AND 21.
- TANISTRY, INC., AUSTIN, TX:
2,570,877, PUB. 12-25-2001. INT. CL. 42.
- TANNER, JOEY M., TUCSON, AZ AND TANNER, ARTHUR R., TUCSON, AZ, DBA ZEPHYR PRESS:
1,886,007, CANC. INT. CL. 16.
- TARA MATERIALS, INC., LAWRENCEVILLE, GA:
2,571,393, PUB. 2-26-2002. INT. CL. 16.
- TARAFLEX, S.A., 69170 TARARE, FRANCE:
1,656,341. REN. 4-10-02. INT. CL. 27.
- TASOVA, TASH, LILBURN, GA:
2,572,408, INT. CL. 15.
- TATE, EDWIN M., CHATTANOOGA, TN:
1,886,551, CANC. INT. CL. 9.
- TAY-E CO., LTD., TACHIA CHEN, TAICHUNG HSIEN, TAIWAN:
2,571,474, PUB. 2-26-2002. INT. CL. 15.
- TAYLOR CORPORATION, NORTH MANKATO, MN:
2,571,278, PUB. 2-26-2002. INT. CL. 35.
- TBC, INC., RENTON, WA:
2,572,013, INT. CL. 41.
- TCBY ENTERPRISES, INC., SALT LAKE CITY, UT:
2,571,873, INT. CL. 42.
- TCPIP, INC., WILMINGTON, DE:
2,572,397, INT. CL. 25.
- TEACHERS FEDERAL CREDIT UNION, FARMINGDALE, NY:
2,395,590, COR. INT. CL. 36.
- TEAM CHEER, INC., GENESEO, NY:
2,571,060, PUB. 2-26-2002. INT. CL. 25.
- TECH ASSETS INC, DALLAS, TX:
1,638,952, CANC. INT. CL. 9.
- TECH GUARD, INC., FORT COLLINS, CO:
2,571,224, PUB. 2-26-2002. INT. CL. 36.
- TECHMIX, INC., STEWART, MN:
1,691,149. REN. 4-10-02. INT. CL. 5.
- TECHNASONIC ELECTRONICS, INC., LINCOLNWOOD, IL:
1,687,669. REN. 4-10-02. INT. CL. 9.
- TECHNICAL CONCEPTS LP, MUNDELEIN, IL:
2,572,399, INT. CL. 11.
- TECHNOLOGY ADVANCEMENT GROUP, INC., DULLES, VA:
2,570,911, PUB. 2-26-2002. INT. CL. 38.
- TECHNOLOGY EDUCATION NETWORK, INC., ARDSLEY, NY:
2,571,867, MULTIPLE CLASS, INT. CLS. 39 AND 41.
- TECHNOLOGY INVESTMENTS OF TAMPA BAY, INC.:
See—COMMERCEQUEST, INC.
- TECHNOLOGY PROPERTIES, INC., FORT WORTH, TX:
1,886,451, CANC. INT. CL. 42.
- TECHTRACER SYSTEMS, LLC, CHERRY HILL, NJ:
2,571,571, PUB. 2-26-2002. INT. CL. 35.
- TECNOL MEDICAL PRODUCTS, INC., FORT WORTH, TX:
1,886,583, CANC. INT. CL. 9.
- TEEPAK INVESTMENTS, INC., WILMINGTON, DE, TRANSPARENT PACKAGE COMPANY, CHICAGO, IL:
547,415. REN. 4-7-02. U.S. CL. 2 (INT. CL. 18).
- TEKHNIKOS SOLUTIONS, INC., FLOWER MOUND, TX:
2,571,604, PUB. 2-26-2002. INT. CL. 16.
- TEKONSHA ENGINEERING COMPANY, TEKONSHA, MI:
2,570,768, PUB. 2-26-2002. INT. CL. 9.
- TELE-MEDIA BROADCASTING COMPANY OF LEHIGH VALLEY, PLEASANT GAP, PA:
1,886,340, CANC. INT. CL. 38.
- TELE-MEDIA CORPORATION OF DELAWARE, PLEASANT GAP, PA:
2,570,851, PUB. 2-26-2002. INT. CL. 38.
- TELECOMMUNICATIONS SERVICE CENTER, INC., TAMPA, FL:
1,886,335, CANC. INT. CL. 38.
- TELECOMPETITION, INC., SAN RAMON, CA:
2,570,738, PUB. 2-26-2002. INT. CL. 35.
- TELEDEBIT, L.P., SARASOTA, FL:
1,886,284, CANC. INT. CL. 36.
- TELEDYNE INDUSTRIES INC., LOS ANGELES, CA:
2,317,512, AM. INT. CL. 35.
- TELEDYNE TECHNOLOGIES INCORPORATED, LOS ANGELES, CA TO TELEDYNE INDUSTRIES, INC., LOS ANGELES, CA:
2,541,072, COR. INT. CL. 9.
- TELEVISION BROADCASTS LIMITED, KOWLOON, HONG KONG:
2,571,791, MULTIPLE CLASS, INT. CLS. 16, 38 AND 41.
- TELIA AB, 123 86 FARSTA, SWEDEN:
2,570,533, PUB. 12-12-2000. MULTIPLE CLASS, INT. CLS. 9, 20, 35, 38, 39, 41 AND 42.
- TELICA, INC., MARLBORO, MA:
2,572,065, INT. CL. 9.
2,572,066, INT. CL. 9.
- TELTRON TECHNOLOGIES, INC., BIRDSBORO, PA:
2,571,239, PUB. 2-26-2002. INT. CL. 9.
- TENDER COLOR INC., TOKYO, JAPAN:
1,149,684, CANC. INT. CL. 9.
- TENSOLITE-CDI, INC., LONG BEACH, CA:
2,571,449, PUB. 2-26-2002. INT. CL. 9.
- TERME DI MONTECATINI S.P.A., MONTECATINI TERME(PT), ITALY:
2,571,602, PUB. 2-26-2002. INT. CL. 3.
- TERRA INTERNATIONAL, INC., SIOUX CITY, IA:
1,150,065, CANC. INT. CL. 42.
- TERRAMAR SPORTS WORLDWIDE, LTD., PORT CHESTER, NY:
2,572,095, INT. CL. 25.
- TEST SYSTEMS STRATEGIES, INC., BEAVERTON, OR TO FLUENCE TECHNOLOGY, INC., BEAVERTON, OR:
1,652,227, CANC. INT. CL. 9.
- TESTCHIP TECHNOLOGIES, INC., PLANO, TX:
2,571,666, PUB. 2-26-2002. INT. CL. 42.
- TEXAS INSTRUMENTS INCORPORATED, DALLAS, TX:
2,570,733, PUB. 2-26-2002. INT. CL. 9.
- TEXAS MEDICAL ASSOCIATION, AUSTIN, TX:
2,571,584, PUB. 2-26-2002. INT. CL. 42.
- TEXAS OFF ROAD PERFORMANCE, SPRING, TX:
2,572,338, INT. CL. 35.
- THARP, DANIAL, NORTH FORT MYERS, FL:
2,572,241, INT. CL. 28.
- THE DERBY CONE COMPANY, LOUISVILLE, KY:
1,621,454, COR. INT. CL. 30.
- THE WHITAKER CORPORATION, WILMINGTON, DE, AMP INCORPORATED, HARRISBURG, PA:
717,823. REN. 4-9-02. U.S. CL. 21 (INT. CL. 9).
- THEARCHSUPPORT.COM, NORTH POTOMAC, MD:
2,571,546, PUB. 2-26-2002. INT. CL. 35.
- THER-A-PEDIC ASSOCIATES, INC., GARWOOD, NJ:
1,149,836, CANC. INT. CL. 20.
- THERMASOL, LTD., LEONIA, NJ:
1,149,720, CANC. MULTIPLE CLASS, INT. CLS. 11 AND 42.
- THERMODYNE FOODSERVICE PRODUCTS, INC., FORT WAYNE, IN:
1,676,688. REN. 4-9-02. INT. CL. 11.
- THERMOGRAPHIC MEASUREMENTS, INCORPORATED, NORTHBROOK, IL, DAVIS LIQUID CRYSTALS, INC., SAN LEANDRO, CA:
1,681,221. REN. 4-9-02. INT. CL. 20.
- THERMTRON PRODUCTS, INC. THERMTRON PRODUCTS, INC.:
713,009, CANC. U.S. CL. 12.
- THIELEN, JEFF, ST. PAUL, MN:
2,571,918, MULTIPLE CLASS, INT. CLS. 35 AND 42.
- THIRD COAST MEDIA, LLC, RICHARDSON, TX:
2,570,879, PUB. 2-26-2002. INT. CL. 42.
- THOMAS CAMERON CORPORATION, CALGARY, ALBERTA, CANADA:
1,885,972, CANC. INT. CL. 14.
- THOMAS NELSON, INC., NASHVILLE, TN:
1,886,612, CANC. INT. CL. 16.
- THOMAS PINK LIMITED, LONDON, SW8 4AP, ENGLAND:
2,570,539, PUB. 1-9-2001. INT. CL. 5.
- THOMPSON PUMP & MANUFACTURING COMPANY, INC., PORT ORANGE, FL:
2,571,342, PUB. 2-26-2002. INT. CL. 7.

- THORNTON, ROBERT P., DAYTONA BEACH, FL AND THORNTON, CONNIE R., DAYTONA BEACH, FL: 1,886,667, CANC. INT. CL. 28.
- THOS FLOATS, LLC, ATLANTA, GA: 2,571,966, INT. CL. 28.
- THOUGHTWORKS, INC., CHICAGO, IL: 2,571,263, PUB. 2-26-2002. INT. CL. 42.
- THREE H JEWELRY, LTD., WYNNWOOD, PA: 1,157,231, CANC. INT. CL. 14.
- THRIFTY, INC., TULSA, OK: 2,571,205, PUB. 2-26-2002. INT. CL. 36.
- THUNDERBIRD LODGE PRESERVATION SOCIETY, LAKE TAHOE, NV: 2,570,821, PUB. 2-26-2002. MULTIPLE CLASS, INT. CLS. 39 AND 42.
- TIANJIN CENTRAL PHARMACEUTICAL CO., LTD., TIANJIN, CHINA, CHINA NATIONAL NATIVE PRODUCE AND ANIMAL BY-PRODUCTS AND IMPORT AND EXPORT CORPORATION, PEKING, CHINA: 1,200,098, REN. 4-9-02. INT. CL. 5.
- TIARA MEDICAL SYSTEMS, INC., OAK FOREST, IL: 2,571,759, INT. CL. 10.
2,571,777, INT. CL. 10.
- TICHENOR, BRUCE H., PLYMOUTH, CA, DBA STORY WINERY: 2,571,083, PUB. 2-26-2002. INT. CL. 16.
- TILIA INTERNATIONAL, INC., TAI KOK TSAI, KOWLOON, HONG KONG: 2,571,772, INT. CL. 7.
- TIMBER LODGE STEAKHOUSE, INC., SAINT LOUIS PARK, MN: 2,571,629, PUB. 2-26-2002. MULTIPLE CLASS, INT. CLS. 29 AND 30.
- TIME WARNER ENTERTAINMENT COMPANY, L.P., NEW YORK, NY: 1,873,947, CANC. INT. CL. 25.
- TIME WARNER ENTERTAINMENTCOMPANY L.P., NEW YORK, NY: 1,875,181, CANC. MULTIPLE CLASS, INT. CLS. 11, 14, 16, 18, 20, 21, 24 AND 28.
- TIME/SYSTEM INTERNATIONAL A/S:
See—MOBIPRO A/S.
- TIMKEN COMPANY, THE, CANTON, OH: 2,570,910, PUB. 2-26-2002. INT. CL. 6.
- TIMSIT, JEAN, 75017 PARIS, FRANCE: 2,570,657, PUB. 11-21-2000. MULTIPLE CLASS, INT. CLS. 35, 41 AND 42.
- TINNITRONICS HANDELS - UND VERTRIEBSGMBH, 9800 SPITAL AN DER DRAU, AUSTRALIA: 2,570,576, PUB. 11-27-2001. MULTIPLE CLASS, INT. CLS. 10, 16 AND 41.
- TITUS SOFTWARE CORPORATION, CHATSWORTH, CA: 2,570,844, PUB. 2-26-2002. INT. CL. 9.
- TM GROUP GRAPHIC SERVICES, INC., THE, CONSHOHOCKEN, PA: 2,571,127, PUB. 7-3-2001. INT. CL. 35.
- TML VENTURES, INC., ANN ARBOR, MI: 1,686,936, REN. 4-12-02. INT. CL. 42.
- TMS, INC., STILLWATER, OK, DBA TMSSEQUOIA: 2,571,768, INT. CL. 9.
- TODD CHRISTOPHER INTERNATIONAL, INC., OLDSMAR, FL, DBA VOGUE INTERNATIONAL, INC.: 2,571,255, PUB. 10-9-2001. INT. CL. 3.
- TOLEDO MEDICAL SERVICES, INC., TOLEDO, OH: 1,150,071, CANC. INT. CL. 42.
- TOLMA S.A., PARIS, FRANCE: 2,572,265, MULTIPLE CLASS, INT. CLS. 9, 37, 38 AND 42.
- TONO A.G., LAUSANNE, SWITZERLAND: 713,186, CANC. U.S. CL. 36.
- TOOLEY, JEROME A., OCEANSIDE, CA: 2,571,969, INT. CL. 35.
- TOPCO ASSOCIATES, INC., SKOKIE, IL: 1,189,525, REN. 4-6-02. INT. CL. 34.
- TOPPS COMPANY, INC., THE, BROOKLYN, NY: 1,886,678, CANC. INT. CL. 30.
- TOUCH-MAP SYSTEMS, JENSEN BEACH, FL: 2,570,789, PUB. 2-26-2002. INT. CL. 42.
- TOWLE MANUFACTURING COMPANY, EAST BOSTON, MA: 925,513, REN. 4-6-02. U.S. CL. 28 (INT. CL. 8).
- TOWN & COUNTRY CORPORATION, CHELSEA, MA: 1,885,975, CANC. INT. CL. 14.
- TOWNSEND GROUP, INC., THE, BRANFORD, CT: 1,886,289, CANC. INT. CL. 36.
- TOWNSENDS, INC., WILMINGTON, DE: 1,681,331, REN. 4-6-02. INT. CL. 29.
- TOYO INK MFG. CO., LTD., CHUO-KU, TOKYO, JAPAN: 1,685,780, REN. 4-9-02. INT. CL. 16.
- TOYON RESEARCH CORPORATION, GOLETA, CA: 1,886,771, CANC. INT. CL. 9.
- TOYOTA JIDOSHA KABUSHIKI KAISHA, TOYOTA-SHI, AICHI 471, JAPAN, TA TOYOTA MOTOR CORPORATION: 2,571,835, INT. CL. 12.
- TOZZI, DONNA, BOCA RATON, FL: 2,572,048, INT. CL. 25.
- TRADE2EUROPE, INC., WESTLAKE VILLAGE, CA: 2,572,286, MULTIPLE CLASS, INT. CLS. 35 AND 39.
- TRADITIONAL COWBOY ARTS ASSOCIATION, SALMON, ID: 2,572,305, U.S. CL. 200.
- TRAILERVISION, INC., TORONTO, ONTARIO FROM NERENBERG, ALBERT, TORONTO, ONTARIO M5S 2R6, CANADA: 2,570,620, PUB. 2-26-2002. INT. CL. 41.
- TRANSHIELD AS, OSLO, NORWAY: 2,571,025, PUB. 2-26-2002. INT. CL. 16.
- TRANSPORT GRAPHICS, INC., MERRILLVILLE, IN: 2,572,159, INT. CL. 27.
- TRANZ-SEND BROADCASTING NETWORK, SAN FRANCISCO, CA: 2,572,245, INT. CL. 38.
- TRAVELBYUS.COM, INC., WHITE ROCK, B.C., CANADA: 2,571,862, MULTIPLE CLASS, INT. CLS. 35, 39 AND 42.
- TRAX WORLD TRAVEL & TOURS, INC., ENGLEWOOD, CO: 2,570,509, PUB. 10-30-2001. INT. CL. 39.
- TREAT ENTERTAINMENT, INC., FLORENCE, AL: 2,572,242, MULTIPLE CLASS, INT. CLS. 21 AND 24.
- TREVIGEN, INC., GAITHERSBURG, MD: 2,571,608, PUB. 2-26-2002. INT. CL. 1.
- TRF SYSTEMS, INC., CORAL SPRINGS, FL: 2,572,255, MULTIPLE CLASS, INT. CLS. 9 AND 42.
- TRI-SEAL HOLDINGS, INC., SOMERVILLE, NJ, TRI-SEAL INTERNATIONAL, INC., BLAUVELT, NY: 1,675,065, REN. 4-9-02. INT. CL. 17.
- TRI-STAR PLASTICS CORP., SHREWSBURY, MA: 2,571,251, PUB. 2-26-2002. INT. CL. 17.
- TRIALTRAC, INC., W. HOLLYWOOD, CA: 2,571,952, INT. CL. 9.
- TRIANGLE PACIFIC CORP., DALLAS, TX: 1,857,705, CANC. INT. CL. 19.
- TRIBORO QUILT MANUFACTURING CORPORATION, WHITE PLAINS, NY: 1,886,639, CANC. INT. CL. 24.
- TRICORP FEDERAL CREDIT UNION, WESTBROOK, ME: 2,572,122, INT. CL. 36.
- TRIDENT SEAFOODS CORPORATION, SEATTLE, WA, D.B. BERELSON & CO., SAN FRANCISCO, CA: 1,202,195, REN. 4-9-02. INT. CL. 29.
- TRIGON INSURANCE COMPANY, RICHMOND, VA, DBA TRIGON BLUE CROSS BLUE SHIELD: 2,571,820, MULTIPLE CLASS, INT. CLS. 35 AND 42.
- TRINITY MARKETING, INC., SOUTHAMPTON, PA: 2,571,745, MULTIPLE CLASS, INT. CLS. 16 AND 28.
- TRIPP, MARTHA J., HOUSTON, TX: 2,571,676, PUB. 2-26-2002. INT. CL. 4.
- TRISTAR PICTURES, INC., CULVER CITY, CA: 1,886,660, CANC. INT. CL. 25.
- TRISTAR PRODUCTS, INC., PARSIPPANY, NJ: 2,571,760, INT. CL. 20.
- TRISTAR PROTECTION PLAN INC., MASON, OH: 2,572,173, INT. CL. 36.

- TRIUMPH DESIGNS LIMITED, DERBYSHIRE DE 12 7JP, UNITED KINGDOM:
2,571,967, INT. CL. 28.
- TRIVANTIS CORPORATION, CINCINNATI, OH:
2,571,196, PUB. 2-26-2002. INT. CL. 9.
- TRUE NORTH COMMUNICATIONS INC.:
See— INTERPUBLIC GROUP OF COMPANIES, INC., THE.
- TRUE TEMPER HARDWARE COMPANY, MIAMISBURG, OH:
1,886,520, CANC. INT. CL. 8.
- TRUONG GIANG CORPORATION, SOUTH EL MONTE, CA:
2,570,889, PUB. 12-18-2001. INT. CL. 30.
- TRUSERV CORPORATION, CHICAGO, IL:
2,571,606, PUB. 2-26-2002. INT. CL. 35.
- TRUSTILE DOORS, INC., DENVER, CO:
2,572,247, INT. CL. 19.
- TUCUMCARI AERO, INCORPORATED, TUCUMCARI, NM:
1,149,727, CANC. INT. CL. 12.
- TUFCO, L.P., DALLAS, TX, HAMCO, INCORPORATED, NEWTON, NC:
1,703,259, REN. 4-10-02. INT. CL. 16.
- TUMBLE TOGS, INC., FARMVILLE, NC:
1,886,648, CANC. INT. CL. 25.
- TURNER BROADCASTING SYSTEM, INC., ATLANTA, GA:
1,886,370, CANC. INT. CL. 41.
- TURNER DUCKWORTH, LLC, SAN FRANCISCO, CA:
2,570,614, PUB. 2-26-2002. MULTIPLE CLASS, INT. CLS. 35 AND 42.
- TURTLETAUB, MARC, FAIR OAKS, CA:
2,571,904, INT. CL. 41.
- TUTERRI'S, INC., LEE'S SUMMIT, MO, AKA TUTERRI'S HANDMADE PASTA:
1,886,224, CANC. INT. CL. 30.
- TUTOR TIME LEARNING SYSTEMS, INC., BOCA RATON, FL:
2,571,054, PUB. 2-26-2002. INT. CL. 16.
- TWECO PRODUCTS, INC., ST. LOUIS, MO, ARCAIR COMPANY, THE, LANCASTER, OH:
1,190,507, REN. 4-10-02. INT. CL. 9.
- TWENTIETH CENTURY FOX FILM CORPORATION, LOS ANGELES, CA:
1,886,032, CANC. INT. CL. 16.
- TWENTY-TWO, INC., BIRMINGHAM, MI:
2,572,416, INT. CL. 20.
- TWICE, INC., BEVERLY HILLS, CA:
1,886,171, CANC. INT. CL. 25.
- TWIN LABORATORIES INC., HAUPPAUGE, NY, TWIN LABORATORIES, INC., RONKONKOMA, NY:
1,698,746, REN. 4-9-02. INT. CL. 5.
1,709,127, REN. 4-9-02. INT. CL. 5.
- TYCO INDUSTRIES, INC., MOUNT LAUREL, NJ:
1,891,783, CANC. INT. CL. 28.
- TYE-DYE FACTORY, INC., THE, POMPAÑO BEACH, FL:
2,571,021, PUB. 2-26-2002. INT. CL. 25.
- U S WEST, INC.:
See— QWEST COMMUNICATIONS INTERNATIONAL INC.
- U.S. CREATIVE, INC., AUSTIN, TX:
2,571,242, PUB. 10-30-2001. INT. CL. 42.
- UBI SOFT, INC., SAN FRANCISCO, CA:
2,572,132, INT. CL. 9.
- UHU GMBH & CO. KG, 77815 BUHL, FED REP GERMANY, LINGNER + FISCHER GMBH, BUHL (BADEN), FED REP GERMANY:
1,190,654, REN. 4-8-02. INT. CL. 16.
- UJB FINANCIAL CORP., PRINCETON, NJ:
1,886,311, CANC. INT. CL. 36.
1,886,312, CANC. INT. CL. 36.
- ULTIMATE STRENGTH SYSTEMS LABS, INC., BLOOMFIELD, CT:
1,885,781, CANC. INT. CL. 5.
- UMEYA RICE CAKE COMPANY, LOS ANGELES, CA:
2,572,328, INT. CL. 30.
- UMPQUA HOLDINGS CORPORATION, PORTLAND, OR:
2,571,638, PUB. 2-26-2002. INT. CL. 36.
- UNCLE WAFFLES, LTD., CLEVELAND HEIGHTS, OH:
2,570,521, PUB. 2-20-2001. MULTIPLE CLASS, INT. CLS. 30 AND 42.
- UNIFLAG COMPANY, THE, PELHAM, NY:
1,886,657, CANC. INT. CL. 25.
- UNION BANK AND TRUST, BARTLESVILLE, OK:
1,150,019, CANC. INT. CL. 36.
- UNION BANK OF CALIFORNIA, N.A., SAN FRANCISCO, CA:
2,572,301, INT. CL. 36.
- UNION CARBIDE CHEMICALS & PLASTICS TECHNOLOGY CORPORATION, WILMINGTON, DE:
1,886,491, CANC. INT. CL. 1.
- UNION DE CERVECERIAS PERUANAS BACKUS Y JOHNSTON, S.A., LIMA 1 PERU, PUERTO RICO, CERVECERIA BACKUS Y JOHNSTON S.A., LIMA, PERU:
1,675,260, REN. 4-12-02. INT. CL. 32.
- UNION SPECIAL CORPORATION, HUNTLEY, IL:
725,904, REN. 4-10-02. U.S. CL. 23 (INT. CL. 7).
- UNION VITIVINICOLA, S.A. VINEDOS EN CENICERO, 26350 CENICERO (LA RIOJA), SPAIN:
2,570,913, PUB. 2-26-2002. INT. CL. 33.
- UNIPRO FOODSERVICE, INC., ATLANTA, GA, CONTINENTAL ORGANIZATION OF DISTRIBUTOR ENTERPRISES, INC., PITTSBURGH, PA, DBA CODE, INC.:
1,575,911, REN. 4-9-02. MULTIPLE CLASS, INT. CLS. 3 AND 5.
- UNIPURE CORPORATION, HOUSTON, TX:
2,572,362, INT. CL. 42.
- UNIQUE COMMUNICATIONS OF DENVER, INC., LITTLETON, CO:
2,571,634, PUB. 2-26-2002. INT. CL. 9.
- UNIROYAL TECHNOLOGY CORPORATION, SARASOTA, FL:
1,886,040, CANC. INT. CL. 17.
- UNITED AIR LINES, INC., CHICAGO, IL:
2,572,261, INT. CL. 39.
- UNITED FOOD & COMMERCIAL WORKERS INTERNATIONAL UNION, LOCAL 770, LOS ANGELES, CA:
1,741,881, REN. 4-10-02. INT. CL. 42.
- UNITED LAWYERS NETWORK, INC., GLENDORA, NJ:
2,571,574, PUB. 2-26-2002. INT. CL. 35.
- UNITED MERCHANTS AND MANUFACTURERS, INC., NEW YORK, NY:
713,240, CANC. U.S. CL. 42.
- UNITED SECURITY PRODUCTS, INC., SAN DIEGO, CA:
1,199,401, REN. 4-10-02. INT. CL. 9.
- UNITED SERVICES AUTOMOBILE ASSOCIATION, SAN ANTONIO, TX:
2,571,044, PUB. 2-26-2002. INT. CL. 14.
- UNITED SPORTS VENTURES, INC., NEW YORK, NY:
2,571,841, MULTIPLE CLASS, INT. CLS. 9, 14, 16, 21 AND 28.
- UNITED STATES FILTER CORPORATION, PALM DESERT, CA:
2,571,907, INT. CL. 7.
- UNITED STATES NAVY, ARLINGTON, VA:
2,571,181, PUB. 2-26-2002. INT. CL. 16.
- UNITED STATES PIPE AND FOUNDRY COMPANY, BIRMINGHAM, AL:
1,149,589, CANC. INT. CL. 6.
- UNITED STATES PLAYING CARD COMPANY, THE, CINCINNATI, OH, UNITED STATES PLAYING CARD COMPANY, THE, CINCINNATI, OH:
555,116, REN. 4-11-02. U.S. CL. 22 (INT. CL. 16).
- UNITED STATES SHOE CORPORATION, THE, CINCINNATI, OH:
1,877,045, CANC. INT. CL. 42.
- UNITED STATIONERS SUPPLY CO., DES PLAINES, IL:
2,571,419, PUB. 2-26-2002. INT. CL. 35.
2,571,420, PUB. 2-26-2002. INT. CL. 35.
- UNIVERSAL AGGREGATES, LLC, PITTSBURGH, PA:
2,571,998, INT. CL. 19.
- UNIVERSAL CITY STUDIOS, INC., UNIVERSAL CITY, CA:
1,681,501, REN. 4-12-02. INT. CL. 41.
1,886,020, CANC. INT. CL. 16.
- UNIVERSAL DISTRIBUTING OF NEVADA, INC., LAS VEGAS, NV:
2,571,708, INT. CL. 9.

- UNIVERSAL SOLUTIONS INTERNATIONAL, INC., WINSTON-SALEM, NC:
2,572,398, INT. CL. 37.
- UNIVERSAL TECHNOLOGY CORPORATION, WILMINGTON, DE FROM SCHINDLER ELEVATOR CORPORATION, HOLLAND, OH, DBA MILLAR ELEVATOR SERVICE COMPANY:
2,570,487, PUB. 2-26-2002. INT. CL. 9.
- UNIVERSAL/U-DRIVE, UNIVERSAL CITY, CA:
1,678,863, REN. 4-6-02. INT. CL. 41.
- UNIVERSE LIFE INSURANCE COMPANY, THE, RENO, NV:
1,150,025, CANC. INT. CL. 36.
- UNIVERSITY CORPORATION FOR ATMOSPHERIC RESEARCH, BOULDER, CO:
1,885,862, CANC. INT. CL. 9.
1,886,463, CANC. INT. CL. 42.
- UNIVERSITY OF MIAMI, CORAL GABLES, FL:
2,572,373, INT. CL. 41.
- UNIVERSITY OF NORTH TEXAS, DENTON, TX:
2,572,376, INT. CL. 16.
- UNIVERSITY OF THE STATE OF NEW YORK, THE, ALBANY, NY:
2,118,369, CANC. INT. CL. 16.
- UNIVERSITY OF WASHINGTON, SEATTLE, WA:
1,983,078, CANC. INT. CL. 41.
- UNIWELD PRODUCTS, INC., FORT LAUDERDALE, FL:
2,571,427, PUB. 2-26-2002. INT. CL. 9.
- UNR INDUSTRIES, INC., CHICAGO, IL:
1,886,602, CANC. INT. CL. 12.
- UPPER DECK COMPANY, THE, CARLSBAD, CA TO UPPER DECK COMPANY, L.L.C., THE, CARLSBAD, CA:
1,953,992, CANC. INT. CL. 41.
- URBAN EASE, LLC, SEATTLE, WA:
2,570,999, PUB. 2-26-2002. INT. CL. 35.
- URBAN, ROBERT T., KEARNEY, UNITED STATES FROM URBAN, ROBERT T., KEARNEY, UNITED STATES:
2,570,808, PUB. 2-26-2002. MULTIPLE CLASS, INT. CLS. 35 AND 41.
- URBAN, ROBERT T.:
See—URBAN, ROBERT T.
- URSHEL MANUFACTURING INCORPORATED, SCOTTSDALE, AZ:
1,886,429, CANC. INT. CL. 42.
- US - CHINA TECHNOLOGY & TRADING COMPANY, NEW YORK, NY:
1,885,930, CANC. INT. CL. 10.
- USINOR, PUTEAUX, FRANCE:
2,571,558, PUB. 2-26-2002. MULTIPLE CLASS, INT. CLS. 6, 35, 38 AND 42.
- UTILITIES INTERNATIONAL, INC., CHICAGO, IL:
2,571,045, PUB. 2-26-2002. INT. CL. 35.
- V CORP TECHNOLOGIES, INC., CARLSBAD, CA:
2,570,685, PUB. 2-26-2002. INT. CL. 9.
2,570,686, PUB. 2-26-2002. INT. CL. 9.
- VALASSIS COMMUNICATIONS, INC., LIVONIA, MI:
2,518,625, COR. INT. CL. 35.
- VAN DER KEMP, RONALD, 75003 PARIS, FRANCE:
2,571,305, PUB. 2-26-2002. INT. CL. 25.
- VAN SCOY, TOMMY, JR., DALLAS, PA:
1,886,411, CANC. INT. CL. 42.
- VANCE PUBLISHING CORPORATION, LINCOLNSHIRE, IL:
2,571,169, PUB. 2-26-2002. INT. CL. 42.
- VANGUARD PIPING SYSTEMS, INC., MCPHERSON, KS:
2,571,919, MULTIPLE CLASS, INT. CLS. 6 AND 20.
- VANTAGE GROUP INC., THE, BOSTON, MA:
2,570,937, PUB. 6-26-2001. INT. CL. 39.
- VARIMETRIX CORPORATION, PALM BAY, FL:
2,571,639, PUB. 2-26-2002. INT. CL. 9.
- VARN INTERNATIONAL, INC., OAKLAND, NJ:
2,571,445, PUB. 2-26-2002. INT. CL. 3.
- VARN PRODUCTS CO., INC., OAKLAND, NJ:
1,394,569, COR. INT. CL. 3.
- VAST RESOURCES, INC., SAN FERNANDO, CA, DBA TOPCO SALES:
2,571,534, PUB. 2-26-2002. INT. CL. 10.
2,571,535, PUB. 2-26-2002. INT. CL. 10.
- VASTEX INTERNATIONAL, INC., BRANCHBURG TOWNSHIP, SOMERVILLE, NJ:
1,149,713, CANC. INT. CL. 11.
- VATTIER, CLAUDE, 76260 EU, FRANCE:
2,571,185, PUB. 2-26-2002. INT. CL. 9.
- VEKA AKTIENGESELLSCHAFT, D-4415 SENDENHORST, FED REP GERMANY, VEKAPLAST HEINRICH LAUMANN, SENDENHORST, FED REP GERMANY:
1,201,116, REN. 4-12-02. INT. CL. 19.
- VELCRO INDUSTRIES B.V., CURACAO, NETHERLANDS ANTTILLES:
2,570,823, PUB. 2-26-2002. INT. CL. 26.
- VELLUS PRODUCTS, INC., COLUMBUS, OH:
2,571,496, PUB. 5-29-2001. INT. CL. 3.
- VELUNZA, BERT ALEXSANDER, MIAMI, FL:
1,886,294, CANC. INT. CL. 36.
- VENTURE STORES, INC., O'FALLON, MO:
713,220, CANC. U.S. CL. 39.
- VENTURE TRADING, KENT, CT:
1,886,424, CANC. INT. CL. 42.
- VERACITY, INC., SAN DIMAS, CA:
1,673,957, REN. 4-6-02. INT. CL. 3.
- VERELA, RAPHAEL, VENICE, CA:
2,570,819, PUB. 2-26-2002. INT. CL. 41.
- VERIDA INTERNET CORP., SAN FRANCISCO, CA:
2,570,622, PUB. 6-12-2001. MULTIPLE CLASS, INT. CLS. 35, 36 AND 42.
- VERIPACK.COM, INC., NEWARK, DE:
2,570,912, PUB. 2-26-2002. INT. CL. 35.
- VERONICA CUSTOM DOLLS, INC., HUNTINGTON, NY:
2,571,964, INT. CL. 28.
- VETERINARY PRACTICE PUBLISHING CO., LOS ANGELES, CA:
1,639,422, CANC. INT. CL. 16.
- VI-TEL ELECTRONICS, INC., TETERBORO, NJ:
1,886,591, CANC. INT. CL. 9.
- VIACORE, INC., ORANGE, CA:
2,570,985, PUB. 2-26-2002. INT. CL. 42.
- VICTAULIC COMPANY OF AMERICA, EASTON, PA:
2,570,711, PUB. 1-9-2001. INT. CL. 6.
- VICTOR FORSTMANN, INC., NEW YORK, NY:
2,571,066, PUB. 2-26-2002. INT. CL. 24.
- VICTORY BREWING COMPANY, DOWNINGTOWN, PA:
2,571,438, PUB. 2-26-2002. INT. CL. 32.
2,571,439, PUB. 2-26-2002. INT. CL. 32.
2,571,440, PUB. 2-26-2002. INT. CL. 32.
- VIDEK, INC., ROCHESTER, NY:
2,571,453, PUB. 2-26-2002. INT. CL. 9.
- VIDIFORMS COMPANY, INC., CONGERS, NY, WEISBERG, ROBERT L., NEW CITY, NY, DBA VIDIFORMS COMPANY:
939,673, REN. 4-10-02. U.S. CL. 22 (INT. CL. 16).
- VIEWPOINT INTERNATIONAL, INC., NEW YORK, NY:
2,571,664, PUB. 2-26-2002. INT. CL. 25.
2,571,665, PUB. 2-26-2002. INT. CL. 25.
- VIKEN KELEDJIAN, LOS ANGELES, CA:
1,584,561, REN. 4-9-02. INT. CL. 14.
- VILLAGE VENTURES, INC., WILLIAMSTOWN, MA:
2,571,212, PUB. 2-26-2002. INT. CL. 36.
- VINTEX INC., MISSISSAUGA, ONTARIO, CANADA, TA COMPLETE CYCLE PLASTICS:
1,886,038, CANC. MULTIPLE CLASS, INT. CLS. 17 AND 40.
- VIRGIN ENTERPRISES LIMITED, LONDON, ENGLAND:
1,597,386, REN. 4-12-02. MULTIPLE CLASS, INT. CLS. 17 AND 25.
- VIRTUAL COUNTRIES, INC., SEATTLE, WA:
2,572,290, INT. CL. 35.
- VIRTUAL RAIN, INC., PLEASANTON, CA FROM KEARBY, MIKE, VISTA, CA:
2,571,749, INT. CL. 11.
- VISA U.S.A. INC., FOSTER CITY, CA:
2,572,197, INT. CL. 35.
- VISION ENGINEERING LIMITED, WOKING, SURREY GU23 7ER, ENGLAND:
2,571,808, INT. CL. 9.
- VISION-EASE LENS, INC., BROOKLYN PARK, MN:
2,571,137, PUB. 2-26-2002. INT. CL. 9.

- VISX, INCORPORATED, SANTA CLARA, CA:
2,570,791, PUB. 11-6-2001. INT. CL. 10.
- VITAL APPAREL GROUP, HUNTINGTON STATION, NY:
2,571,081, PUB. 2-26-2002. INT. CL. 25.
- VITANTONIO MFG. CO., EASTLAKE, OH:
713,123, CANC. U.S. CL. 23.
- VIVA AMERICA MEDIA GROUP, MIAMI, FL:
1,886,334, CANC. INT. CL. 38.
- VIVALAC INC., BROOKVILLE, MD:
2,571,757, INT. CL. 5.
- VOITH SULZER PAPIERTECHNIK PATENT GMBH, D-89522 HEIDENHEIM, FED REP GERMANY:
2,571,885, INT. CL. 7.
- VOLKSWAGEN AKTIENGESELLSCHAFT, D-38436, WOLFSBURG, FED REP GERMANY:
2,570,691, PUB. 2-26-2002. MULTIPLE CLASS, INT. CLS. 12, 28 AND 37.
- VOS SYSTEMS LLC, POWAY, CA:
2,570,519, PUB. 8-17-1999. INT. CL. 9.
- VYSIS, INC., DOWNER GROVE, IL:
2,571,805, MULTIPLE CLASS, INT. CLS. 1 AND 5.
- W STERNOFF LLC, BELLEVUE, WA:
2,571,744, INT. CL. 3.
- W. E. BASSETT COMPANY, THE, DERBY, CT:
713,101, CANC. U.S. CL. 23.
- W. R. MEADOWS, INC., ELGIN, IL:
1,149,814, CANC. INT. CL. 17.
- W-I-LINK.COM INC., RICHMOND, VA:
2,572,292, INT. CL. 35.
- WACHOVIA CORPORATION, WINSTON-SALEM, NC, FIRST WACHOVIA CORPORATION, WINSTON-SALEM, NC:
1,653,891, REN. 4-11-02. INT. CL. 36.
- WACKER-CHEMIE GMBH, D-81737 MUNICH, FED REP GERMANY:
1,724,824, REN. 4-11-02. INT. CL. 1.
2,476,955, COR. MULTIPLE CLASS, INT. CLS. 1, 2, 3, 5 AND 16.
2,535,292, COR. MULTIPLE CLASS, INT. CLS. 1 AND 17.
2,570,577, PUB. 11-27-2001. MULTIPLE CLASS, INT. CLS. 1 AND 5.
- WAHL CLIPPER CORPORATION, STERLING, IL:
1,886,521, CANC. INT. CL. 8.
- WAL-MART STORES, INC., BENTONVILLE, AR:
2,571,741, INT. CL. 11.
- WAL-MART STORES, INC., BENTONVILLE, AR FROM LOBLAWS INC., TORONTO, ONTARIO M4T 2S7, CANADA:
2,572,031, INT. CL. 29.
- WALL, WENDY, NEW YORK, NY:
2,571,300, PUB. 2-26-2002. INT. CL. 41.
- WALLACE-O'FARRELL MARKETING, INC., PUYALLUP, WA:
2,477,024, COR. INT. CL. 3.
- WALLS INDUSTRIES, INC., CLEBURNE, TX:
2,571,382, PUB. 2-26-2002. INT. CL. 25.
- WALONG MARKETING, INC., BUENA PARK, CA:
2,570,724, PUB. 2-26-2002. INT. CL. 35.
- WALTON & POST, INC., MIAMI, FL:
2,572,099, INT. CL. 16.
- WARD COVE PACKING COMPANY, SEATTLE, WA, WARDS COVE PACKING COMPANY, INC., SEATTLE, WA:
890,586, REN. 4-6-02. U.S. CL. 46 (INT. CL. 29).
- WAREHOUSE COLLECTION INC., THE, MARKHAM, ONTARIO, CANADA:
1,886,109, CANC. INT. CL. 25.
- WARREN TOOL CORPORATION, CINCINNATI, OH:
140,773, CANC. U.S. CL. 23.
- WARSAW CHEMICAL CO., INC., WARSAW, IN:
2,570,740, PUB. 2-26-2002. INT. CL. 3.
2,570,741, PUB. 2-26-2002. INT. CL. 3.
- WARSHAW, JEREMY, NEW YORK, NY AND ROGERS-BAUGNON, MEG, NEW YORK, NY:
2,571,911, INT. CL. 41.
- WASENDORF & ASSOCIATES INC., CHICAGO, IL:
2,571,630, PUB. 2-26-2002. MULTIPLE CLASS, INT. CLS. 16 AND 41.
- WASHINGTON MUTUAL BANK, F.A., STOCKTON, CA TO AMERICAN SAVINGS BANK, F.S.B., HONOLULU, HI:
2,210,117 NEW CERT. 5-21-2002. INT. CL. 36.
- WASHINGTON MUTUAL, INC., SEATTLE, WA:
2,571,775, INT. CL. 36.
- WASHTRONICS, INC., STARK COUNTY, OH:
1,638,896, CANC. INT. CL. 7.
- WATCOM INTERNATIONAL CORPORATION, WATERLOO, ONTARIO, CANADA:
1,885,845, CANC. MULTIPLE CLASS, INT. CLS. 9 AND 16.
- WATER GARDENERS, INC., THE, CEDAR LAKE, IN:
2,571,234, PUB. 2-26-2002. INT. CL. 16.
- WATER PIK, INC., NEWPORT BEACH, CA TO TELEDYNE INDUSTRIES, INC., LOS ANGELES, CA, DBA TELEDYNE WATER PIK:
2,537,137, COR. INT. CL. 11.
- WATER PIK, INC., NEWPORT BEACH, CA:
2,572,168, INT. CL. 11.
- WATERMARK COMMUNITIES, INC., BONITA SPRINGS, FL:
2,570,769, PUB. 9-18-2001. MULTIPLE CLASS, INT. CLS. 36, 37, 41 AND 42.
2,570,770, PUB. 9-18-2001. MULTIPLE CLASS, INT. CLS. 36, 37, 41 AND 42.
- WATKINS MANUFACTURING COMPANY INC., CINCINNATI, OH:
2,571,078, PUB. 2-26-2002. INT. CL. 7.
- WATKINS MANUFACTURING CORPORATION, VISTA, CA:
1,694,210, REN. 4-10-02. INT. CL. 11.
- WATTS, CONNIE, GREENS FORK, IN, WATTS, BRUCE D., GREENS FORK, IN, DBA BIRTHDAY CHOCOLATES:
1,681,550, REN. 4-12-02. INT. CL. 42.
- WAVIN B.V., 8031 EM ZWOLIE, NETHERLANDS TO GEORG FISCHER WAVING AG, 4553 SUBINGEN, SWITZERLAND:
1,869,564, CANC. MULTIPLE CLASS, INT. CLS. 17 AND 19.
- WAYNE-DALTON CORP., MT. HOPE, OH:
2,570,603, PUB. 12-26-2000. INT. CL. 7.
- WEATHER SHIELD MFG., INC., MEDFORD, WI:
1,639,331, CANC. INT. CL. 6.
- WEBB PARTNERSHIP, THE, WARWICKSHIRE CV8 1BP, UNITED KINGDOM:
2,571,771, INT. CL. 35.
- WEBCO, CAPE CORAL, FL:
1,886,601, CANC. INT. CL. 11.
- WEDDINGCHANNEL.COM, INC., LOS ANGELES, DE TO WEDCOM INC., PASADENA, CA:
2,508,302, COR. MULTIPLE CLASS, INT. CLS. 35 AND 39.
- WEIDER PUBLICATIONS, INC., WOODLAND HILLS, CA:
2,571,727, INT. CL. 41.
- WEIGHT WATCHERS INTERNATIONAL, INC., WOODBURY, NY:
2,570,771, PUB. 2-26-2002. MULTIPLE CLASS, INT. CLS. 38, 41 AND 42.
- WEIN, MARC, COS COB, CT AND WEIN, MARGARET R., COS COB, CT:
2,572,246, INT. CL. 25.
- WELLS FARGO & COMPANY, MINNEAPOLIS, MN:
2,571,073, PUB. 2-26-2002. INT. CL. 36.
2,572,140, INT. CL. 36.
- WENGER CORPORATION, OWATONNA, MN:
2,571,683, PUB. 2-26-2002. INT. CL. 19.
- WERA WERK HERMANN WERNER GMBH & CO., 42349 WUPPERTAL, FED REP GERMANY TO WERA WERK HERMANN WERNER GMBH & CO. KG, WUPPERTAL, FED REP GERMANY:
1,940,573, CANC. MULTIPLE CLASS, INT. CLS. 6, 7 AND 20.
- WESKOTE, INC., COMMERCE, CA:
1,886,022, CANC. INT. CL. 16.
- WEST COAST INDUSTRIES, INC., SAN FRANCISCO, CA:
2,572,161, INT. CL. 20.
- WEST MARINE IHC I, INC., WATSONVILLE, CA:
2,571,286, PUB. 2-26-2002. INT. CL. 2.

- WEST, MICHAEL A., SAN PEDRO, CA:
2,571,235, PUB. 2-26-2002. INT. CL. 25.
- WESTCOATT, WILLIAM H., TITUSVILLE, FL:
1,886,063, CANC. INT. CL. 19.
- WESTERN ATLAS INTERNATIONAL, INC., HOUSTON, TX:
1,886,532, CANC. INT. CL. 9.
- WESTERN FEDERAL CREDIT UNION, LOS ANGELES, CA:
2,571,225, PUB. 2-26-2002. INT. CL. 36.
- WESTERN PHOTOGRAPHICS, INC., SEATTLE, WA:
1,150,043, CANC. INT. CL. 40.
- WESTERN-MOBILE NEW MEXICO, INC., ALBUQUERQUE, NM:
2,570,542, PUB. 9-11-2001. INT. CL. 19.
- WESTHILL PARTNERS, INC., NEW YORK, NY:
2,571,515, PUB. 2-26-2002. INT. CL. 35.
- WESTLAND GUMMIWERKE GMBH, D-49324 MELLE-
WESTERHAUSEN, FED REP GERMANY:
2,572,067, INT. CL. 7.
- WESTLEDGE ASSOCIATES, INC., AVON, CT:
1,150,012, CANC. MULTIPLE CLASS, INT. CLS. 35 AND
36.
- WETTLAUFER, JEANNE, WAKEFIELD, RI:
2,570,963, PUB. 2-26-2002. MULTIPLE CLASS, INT. CLS.
35, 41 AND 42.
- WEYERHAEUSER COMPANY, FEDERAL WAY, WA FROM
TRUS JOIST MACMILLAN, BOISE, ID:
2,572,110, INT. CL. 19.
- WHEELING HOSPITAL, INC., WHEELING, WV:
2,571,252, PUB. 10-16-2001. INT. CL. 42.
- WHERE INTERNATIONAL L.P., TORONTO, ONTARIO,
CANADA FROM WHERE SOUTH CORPORATION, TOR-
ONTO, ONTARIO, CANADA:
2,570,501, PUB. 10-23-2001. MULTIPLE CLASS, INT. CLS.
35 AND 41.
- WHERE SOUTH CORPORATION:
See— WHERE INTERNATIONAL L.P..
- WHIRLPOOL PROPERTIES, INC., BENTON HARBOR, MI:
2,572,196, INT. CL. 11.
- WHIT CORPORATION, RAMSEUR, NC:
1,711,779, REN. 4-11-02. INT. CL. 21.
- WHITE CONSOLIDATED INDUSTRIES, INC. (DEL. CORP.),
CLEVELAND OH:
713,084, CANC. U.S. CL. 21.
- WHITTAKER, RICHARD E., NEW CASTLE, PA:
1,886,664, CANC. INT. CL. 28.
- WHITTLE COMMUNICATIONS L.P., KNOXVILLE, TN:
1,886,723, CANC. INT. CL. 41.
- WHITWORTH, S. RICHARD, CARMEL, CA:
2,572,391, INT. CL. 9.
- WHOGLUE, INC., BALTIMORE, MD:
2,571,617, PUB. 2-26-2002. INT. CL. 42.
- WIELAND ELECTRIC GMBH, D - 96052 BAMBERG, FED
REP GERMANY:
2,570,564, PUB. 8-28-2001. INT. CL. 9.
- WIELAND ELECTRIC GMBH, D-96052 BAMBERG, FED
REP GERMANY:
2,570,710, PUB. 2-26-2002. INT. CL. 9.
- WILBORN, DENNIS, HANCEVILLE, AL:
1,886,198, CANC. INT. CL. 28.
- WILD BIRD CENTERS OF AMERICA, INC., GLEN ECHO,
MD:
2,571,497, PUB. 2-26-2002. INT. CL. 35.
- WILD GOOSE HOLDING CO., INC., WILMINGTON, DE:
1,886,434, CANC. INT. CL. 42.
- WILD HARE, L.L.P., THE, TROY, MI:
2,572,405, INT. CL. 16.
- WILD WELL CONTROL, INC., SPRING, TX:
2,572,304, INT. CL. 42.
- WILDFORM, INC., VENICE, CA:
2,571,551, PUB. 2-26-2002. INT. CL. 9.
- WILKINS, JACK E, WICHITA, KS:
2,571,539, PUB. 2-26-2002. INT. CL. 35.
- WILLIAM AND SCOTT COMPANY, CULVER CITY, CA:
1,886,251, CANC. INT. CL. 32.
- WILLIAM ATKIN COMPANY, INC., NEW YORK, NY:
385,933, CANC. U.S. CL. 39.
- WILLIAM KAUFMANN, INC., MENLO PARK, CA:
1,886,024, CANC. INT. CL. 16.
- WILLIAM ZINSSER & CO., INCORPORATED, SOMERSET,
NJ:
1,889,109, CANC. INT. CL. 2.
- WILLIAMS & WILLIAMS REAL ESTATE, TULSA, OK:
2,571,348, PUB. 2-26-2002. INT. CL. 35.
- WILMER; JUANITA J., GREENBELT, MD:
1,191,376, REN. 4-10-02. INT. CL. 41.
- WILSON, JOHN C., GREENVILLE, PA AND PISULA,
GEORGE, JOHNSTOWN, PA:
2,572,158, INT. CL. 9.
- WILTON TOOL COMPANY, LLC, PALATINE, IL FROM
WILTON CORPORATION, PALATINE, IL:
2,572,108, INT. CL. 8.
- WIMP, LLC, JAMESTOWN, NC:
2,570,855, PUB. 2-26-2002. INT. CL. 41.
- WINKLER INCORPORATED, DALE, IN, VALUBUY
FOODS, INC., DALE, IN:
1,686,879, REN. 4-10-02. INT. CL. 42.
- WINSFORD CORPORATION, ONTARIO, CA:
1,682,820, REN. 4-9-02. INT. CL. 12.
- WINSTEAD SECHREST & MINICK P.C., DALLAS, TX:
2,571,486, PUB. 2-26-2002. INT. CL. 42.
- WINTER PARK RECREATIONAL ASSOCIATION, WINTER
PARK, CO:
2,572,300, INT. CL. 35.
- WIRELESS LINK CORPORATION, MILPITAS, CA:
2,571,798, INT. CL. 9.
- WIRELESS VALLEY COMMUNICATIONS, INC., BLACKS-
BURG, VA:
2,572,117, INT. CL. 9.
- WISE, STEPHEN, KENT, WA:
2,572,315, INT. CL. 36.
- WISH SOLUTIONS, CAMPBELL, CA FROM GIFTLOGIC-
COM, INC., CAMPBELL, CA:
2,570,762, PUB. 2-26-2002. INT. CL. 35.
- WITCO CHEMICAL CORPORATION, NEW YORK, NY:
713,046, CANC. U.S. CL. 16.
- WM. WRIGLEY JR. COMPANY, CHICAGO, IL:
1,149,977, CANC. INT. CL. 30.
- WOHL SHOE COMPANY, INC.:
1,150,097, CANC. INT. CL. 42.
- WOLF CAMERA, INC., ALPHARETTA, GA:
2,364,345 NEW CERT. 5-21-2002. INT. CL. 40.
- WOMEN'S INTERNATIONAL MOTORSPORT ASSOCIA-
TION, INC., THE, IDYLLWILD, CA:
1,886,450, CANC. INT. CL. 42.
- WOODMASTERS, INC., VIRGINIA BEACH, VA:
2,571,270, PUB. 2-26-2002. INT. CL. 37.
- WOOSTER BRUSH COMPANY, THE, WOOSTER, OH:
1,886,796, CANC. INT. CL. 21.
- WOR INTERNATIONAL, INC., CITY OF INDUSTRY, CA:
2,571,226, PUB. 9-4-2001. INT. CL. 25.
- WORDALONE NETWORK, MAHTOMEDI, MN FROM
HOOTMAN, JOSEPH PAUL, AUSTIN, TX:
2,571,960, INT. CL. 42.
- WORDPERFECT CORPORATION, OREM, UT:
1,886,540, CANC. INT. CL. 9.
- WORKFORCE SOLUTIONS, INC., SALT LAKE CITY, UT:
2,572,192, MULTIPLE CLASS, INT. CLS. 35, 36 AND 41.
- WORKMEN'S OUTLET, TARZANA, CA:
2,570,837, PUB. 2-26-2002. INT. CL. 35.
- WORLD ASSOCIATES, INC., GOLDEN, CO, DBA TEAM
FAMILY, INC.:
1,886,004, CANC. INT. CL. 16.
- WORLD DO HAP SOOL ASSOCIATION, FREDERICKS-
BURG, VA:
2,570,580, PUB. 2-26-2002. MULTIPLE CLASS, INT. CLS.
25 AND 41.
- WORLD TRIATHLON CORPORATION, TARPON SPRINGS,
FL:
2,571,690, INT. CL. 32.
- WORLD WIDE BEAUTY, INC., BROOKLYN, NY:
2,571,395, PUB. 2-26-2002. INT. CL. 3.
- WORLD WIDE PET SUPPLY ASSOCIATION, INC., ARCA-
DIA, CA:
2,571,781, MULTIPLE CLASS, INT. CLS. 36 AND 42.
- WORLD'S FINEST CHOCOLATE, INC., CHICAGO, IL:
2,570,881, PUB. 2-26-2002. INT. CL. 30.

- WORLDBYNET.COM, INC., HOUSTON, TX:
 2,571,889, INT. CL. 38.
- WORLDSHARE, INC., CINCINNATI, OH:
 2,570,695, PUB. 2-26-2002. MULTIPLE CLASS, INT. CLS.
 36, 38 AND 42.
- WORLDWIDE HOMESTAY PTY LTD., TEMPLESTOWE,
 AUSTRALIA:
 2,571,536, PUB. 2-26-2002. INT. CL. 42.
- WRECK ROOM INC., THE, VILLA PARK, IL:
 1,668,808. REN. 4-9-02. INT. CL. 37.
- WUNDIES ENTERPRISES, INC., NEW YORK, NY:
 2,572,049, INT. CL. 25.
- XENOVA LTD., SLOUGH, BERKSHIRE, SL1 4EF, ENG-
 LAND:
 2,570,553, PUB. 11-27-2001. MULTIPLE CLASS, INT. CLS.
 1, 5 AND 42.
- XEROX CORPORATION, STAMFORD, CT:
 2,571,785, INT. CL. 7.
 2,572,412, INT. CL. 9.
- XILINX, INC., SAN JOSE, CA:
 2,571,254, PUB. 2-26-2002. INT. CL. 9.
- XM SATELLITE RADIO INC., WASHINGTON, DC:
 2,572,164, INT. CL. 41.
 2,572,185, INT. CL. 41.
- XPARTICIPATION, INC., NAHANT, MA FROM HEWITT,
 CARL E., NAHANT, MA:
 2,571,706, MULTIPLE CLASS, INT. CLS. 9 AND 42.
- XTO ENERGY INC., FORT WORTH, TX:
 2,571,483, PUB. 2-26-2002. INT. CL. 42.
- XULU ENTERTAINMENT INC., SAN JOSE, CA:
 2,571,697, INT. CL. 9.
 2,571,701, INT. CL. 9.
 2,571,709, INT. CL. 25.
- XYBERNAUT CORPORATION, FAIRFAX, VA:
 2,571,028, PUB. 2-26-2002. MULTIPLE CLASS, INT. CLS.
 14 AND 25.
- YAMAHA CORPORATION, HAMAMATSU-SHI, SHIZUO-
 KA, JAPAN:
 2,572,156, INT. CL. 15.
- YANKEE BOOK PEDDLER, INC., CONTOOCOOK, NH:
 2,571,491, PUB. 2-26-2002. MULTIPLE CLASS, INT. CLS.
 35 AND 42.
- YANKTON MEDICAL CLINIC, PC, YANKTON, SD:
 2,571,186, PUB. 2-26-2002. INT. CL. 42.
- YBM TECHNOLOGIES, INC., HATBORO, PA TO YBM
 TECHNOLOGIES, INC., HATBORO, PA:
 1,863,095, CANC. INT. CL. 9.
- YEAR ONE, INC., TUCKER, GA:
 1,714,523. REN. 4-11-02. INT. CL. 42.
- YELLOWHOUSE, L.L.C., TUCSON, AZ:
 2,571,458, PUB. 2-26-2002. INT. CL. 42.
- YOGA INSTITUTE OF MIAMI, INC., SOUTH MIAMI, FL:
 1,728,239. REN. 4-10-02. INT. CL. 41.
- YOKOHAMA HYDEX COMPANY, MINATO-KU, TOKYO
 108, JAPAN:
 2,570,488, PUB. 2-22-2000. INT. CL. 17.
 2,570,489, PUB. 1-25-2000. INT. CL. 17.
- YOKOHAMA TIRE CORPORATION, FULLERTON, CA:
 1,674,968. REN. 4-8-02. INT. CL. 12.
- YORK, CHRISTOPHER C., NEW YORK, NY, DBA C.C.
 YORK & COMPANY:
 1,688,464. REN. 4-10-02. INT. CL. 35.
- YOUTUBE.COM, INC., LOS ANGELES, CA:
 2,570,629, PUB. 11-14-2000. INT. CL. 9.
 2,570,630, PUB. 2-1-2000. INT. CL. 25.
 2,570,631, PUB. 2-22-2000. INT. CL. 25.
- YOUCENTRIC, INC., CHARLOTTE, NC:
 2,572,276, INT. CL. 9.
- YOUNGS' AMERICAN ROSE NURSERY, HURON, OH:
 1,886,689, CANC. INT. CL. 31.
 1,886,690, CANC. INT. CL. 31.
- ZALE DELAWARE, INC., IRVING, TX:
 2,571,323, PUB. 2-26-2002. INT. CL. 14.
- ZAVODY PRESNEHO STROJIRENSTVI, ZLIN, CZECHO-
 SLOVAKIA:
 2,570,479, PUB. 4-18-2000. INT. CL. 7.
- ZELLWEGER LUWA AG, CH-8610 USTER, SWITZERLAND,
 ZELLWEGER USTER, LTD., USTER, SWITZERLAND:
 1,189,773. REN. 4-11-02. INT. CL. 7.
- ZGS COMMUNICATIONS, INC., ARLINGTON, VA:
 1,886,441, CANC. INT. CL. 42.
- ZODIAC GROUP, INC., THE, BOCA RATON, FL:
 2,572,367, INT. CL. 41.
- ZOELLER COMPANY, LOUISVILLE, KY FROM ZOELLER
 COMPANY, LOUISVILLE, KY:
 2,571,872, INT. CL. 11.
- ZOLLER, PRESTON F., WILMINGTON, DE:
 1,886,682, CANC. INT. CL. 30.
- ZOO TO YOU INC., PHILADELPHIA, PA:
 1,886,369, CANC. INT. CL. 41.
- ZORRO PRODUCTIONS, INC., BERKELEY, CA:
 2,571,279, PUB. 2-26-2002. INT. CL. 16.
- ZUMTOBEL STAFF GMBH, A-6850 DORNBERN, AUSTRIA:
 2,570,709, PUB. 12-25-2001. MULTIPLE CLASS, INT. CLS.
 9, 11 AND 42.
- ZWICKER KNITTING MILLS, APPLETON, WI:
 1,149,914, CANC. INT. CL. 25.
- ZYWAVE, INC., MILWAUKEE, WI:
 2,571,896, MULTIPLE CLASS, INT. CLS. 36 AND 42.
- 1-800-WEDDING, INC., WEST YARMOUTH, MA:
 2,570,704, PUB. 2-26-2002. INT. CL. 9.
- 3 DAY BLINDS, INC., ANAHEIM, CA:
 1,693,043. REN. 4-9-02. INT. CL. 20.
- 3-D MARKETING, INC., HARTLAND, WI:
 2,572,388, INT. CL. 20.
- 3KWORLD, LLC, DENVER, CO:
 2,571,853, INT. CL. 35.
- 310 MOTORING CORPORATION, LOS ANGELES, CA:
 2,571,276, PUB. 2-26-2002. INT. CL. 39.
 2,571,277, PUB. 2-26-2002. INT. CL. 37.
- 329985 ONTARIO LIMITED, MARKHAM, ONTARIO, CA-
 NADA, DBA KISKO PRODUCTS:
 2,570,507, PUB. 5-1-2001. MULTIPLE CLASS, INT. CLS. 30
 AND 32.
- 4MOST ENTERPRISES, LLC, PARSIPPANY, NJ:
 2,572,329, INT. CL. 35.
- 4YOURSOU.COM, LLC, SANTA BARBARA, CA:
 2,571,983, MULTIPLE CLASS, INT. CLS. 9, 16, 35 AND 42.
- 800 SPIRITS, INC., HACKENSACK, NJ:
 2,570,484, PUB. 12-17-1996. INT. CL. 42.
- 911 EMERGENCY PRODUCTS, INC., ST. CLOUD, MN:
 2,571,880, INT. CL. 9.
 2,571,915, INT. CL. 9.